

# Operating manual

## VWR® pH 1100 L - pH Meter

EU cat. no  
662-1657

NA cat. no  
76460-488

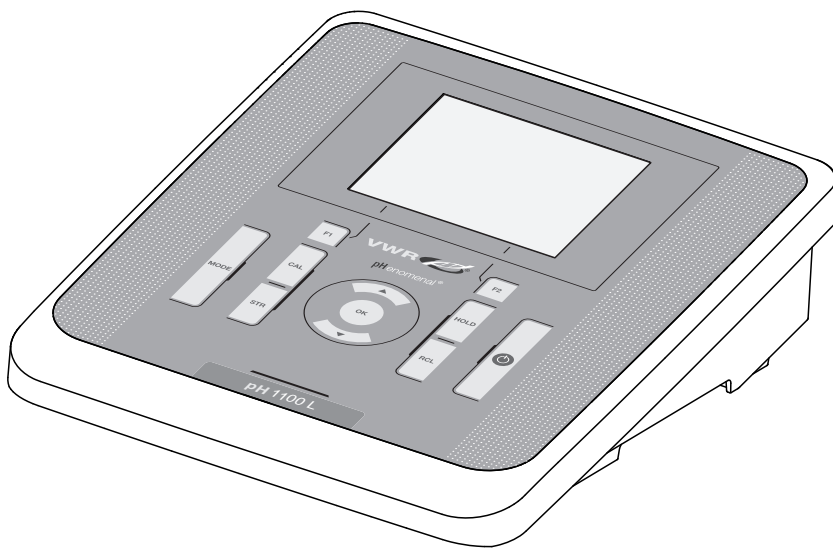

**CE**

**UK  
CA**

**Legal Address of Manufacturer:**

Europe

VWR International BV  
Researchpark Haasrode 2020  
Geldenaaksebaan 464  
B-3001 Leuven  
+32 16 385011  
<http://be.vwr.com>

United States

VWR International LLC  
100 Matsonford Rd  
Radnor, PA 19087  
+1 800-932-5000  
[www.vwr.com](http://www.vwr.com)

Importer to UK:

VWR International Ltd  
Hunter Boulevard, Magna Park  
Lutterworth, Leicestershire, LE17 4XN  
<http://uk.vwr.com>

Country of origin: Germany.

## pH 1100 L - Contents

<b>1</b>	<b>Safety</b> .....	<b>5</b>
1.1	Authorized use .....	6
1.2	General safety instructions .....	6
<b>2</b>	<b>Overview</b> .....	<b>8</b>
2.1	Keypad .....	9
2.2	Display .....	10
2.3	Connectors .....	11
<b>3</b>	<b>Technical data</b> .....	<b>12</b>
3.1	General data .....	12
3.2	Measuring ranges, resolution, accuracy .....	13
<b>4</b>	<b>Commissioning</b> .....	<b>15</b>
4.1	Scope of delivery .....	15
4.2	Initial commissioning .....	15
4.2.1	Inserting the batteries .....	15
4.2.2	Connecting the power pack .....	16
4.2.3	Switching on the meter .....	16
4.2.4	Setting the date and time .....	17
4.2.5	Stand .....	17
<b>5</b>	<b>Operation</b> .....	<b>18</b>
5.1	Switching on the meter .....	18
5.2	General operating principles .....	19
5.2.1	Operating modes .....	19
5.2.2	Navigation .....	20
5.2.3	Navigation example 1: Setting the language .....	22
5.2.4	Example 2 on navigation: Setting the date and time .....	24
5.3	Sensor-independent settings .....	26
5.3.1	<i>System</i> .....	26
5.3.2	<i>Data storage</i> .....	27
5.3.3	<i>Automatic Stability control</i> .....	27
5.4	pH value / ORP voltage .....	28
5.4.1	General information .....	28
5.4.2	Measuring the pH value .....	29
5.4.3	Measuring the ORP .....	30
5.4.4	Settings for pH and ORP measurements .....	31
5.4.5	pH calibration .....	33

---

5.4.6	Calibration interval . . . . .	37
5.4.7	Carrying out automatic calibration (AutoCal) . . .	37
5.4.8	Carrying out a manual calibration (AnyCal) . . . .	40
5.4.9	Displaying calibration records . . . . .	44
5.5	Data memory . . . . .	45
5.5.1	Manual storage . . . . .	46
5.5.2	Automatic storage at intervals . . . . .	47
5.5.3	Editing the measurement data memory . . . . .	49
5.5.4	Erasing the measurement data memory . . . . .	51
5.6	Transmitting data (USB interface) . . . . .	52
5.6.1	Options for data transmission . . . . .	52
5.6.2	Connecting a PC . . . . .	53
5.7	MultiLab Importer . . . . .	53
5.8	Reset . . . . .	54
5.8.1	Resetting the measurement settings . . . . .	54
5.8.2	Resetting the system settings . . . . .	55
<b>6</b>	<b>Maintenance, cleaning, disposal, accessories . . . . .</b>	<b>56</b>
6.1	Maintenance . . . . .	56
6.1.1	Replacing the batteries . . . . .	56
6.2	Cleaning . . . . .	57
6.3	Packing . . . . .	57
6.4	Disposal . . . . .	57
6.5	Accessories . . . . .	58
6.5.1	General information . . . . .	58
6.5.2	pH / ORP . . . . .	58
<b>7</b>	<b>What to do if... . . . . .</b>	<b>61</b>
<b>8</b>	<b>Firmware update . . . . .</b>	<b>64</b>
<b>9</b>	<b>Lists . . . . .</b>	<b>65</b>
<b>10</b>	<b>Technical service . . . . .</b>	<b>69</b>
<b>11</b>	<b>Warranty . . . . .</b>	<b>69</b>
<b>12</b>	<b>Compliance with local laws and regulations . . . . .</b>	<b>69</b>

# 1 Safety

This operating manual contains basic instructions that you must follow during the commissioning, operation and maintenance of the meter. Consequently, all responsible personnel must read this operating manual before working with the meter.

The operating manual must always be available within the vicinity of the meter.

## Target group

The meter was developed for work in the laboratory. Thus, we assume that, as a result of their professional training and experience, the operators will know the necessary safety precautions to take when handling chemicals.

## Safety instructions

Safety instructions in this operating manual are indicated by the warning symbol (triangle) in the left column. The signal word (e.g. "Caution") indicates the level of danger:



### Warning

indicates instructions that must be followed precisely in order to avoid possibly great dangers to personnel.



### Caution

indicates instructions that must be followed precisely in order to avoid the possibility of slight injuries or damage to the instrument or the environment.

## Further notes



### Note

indicates notes that draw your attention to special features.



### Note

indicates cross-references to other documents, e.g. operating manuals.

**Function and operational safety****1.1 Authorized use**

This meter is authorized exclusively for pH and ORP measurements in a laboratory environment.

The technical specifications as given in chapter 3 TECHNICAL DATA must be observed. Only the operation and running of the meter according to the instructions given in this operating manual is authorized.

Any other use is considered **unauthorized**.

**1.2 General safety instructions**

This meter is constructed and tested in compliance with the IEC 1010 safety regulations for electronic measuring instruments.

It left the factory in a safe and secure technical condition.

The smooth functioning and operational safety of the meter can only be guaranteed if the generally applicable safety measures and the specific safety instructions in this operating manual are followed during operation.

The smooth functioning and operational safety of the meter can only be guaranteed under the environmental conditions that are specified in chapter 3 TECHNICAL DATA.

If the meter was transported from a cold environment to a warm environment, the formation of condensate can lead to the faulty functioning of the meter. In this event, wait until the temperature of the meter reaches room temperature before putting the meter back into operation.

**Caution**

**The meter is only allowed to be opened by authorized personnel.**

**Safe operation**

If safe operation is no longer possible, the meter must be taken out of service and secured against inadvertent operation!

Safe operation is no longer possible if the meter:

- has been damaged in transport
- has been stored under adverse conditions for a lengthy period of time
- is visibly damaged
- no longer operates as described in this manual.

If you are in any doubt, please contact the supplier of the meter.

**Obligations of the purchaser**

The purchaser of this meter must ensure that the following laws and guidelines are observed when using dangerous substances:

- EEC directives for protective labor legislation
- National protective labor legislation
- Safety regulations
- Safety datasheets of the chemical manufacturers.

**Caution**

**In addition to the safety instructions mentioned here, also follow the safety instructions of the sensors used.**

## 2 Overview

The compact pH 1100 L precision pH meter enables you to perform pH measurements rapidly and reliably. The pH 1100 L provides the maximum degree of operating comfort, reliability and measuring certainty for all applications.

The proven calibration procedures and automatic stability control function (AR) support your work with the pH meter.

The USB interface can be used for data transmission to a PC and for software updates of the meter.

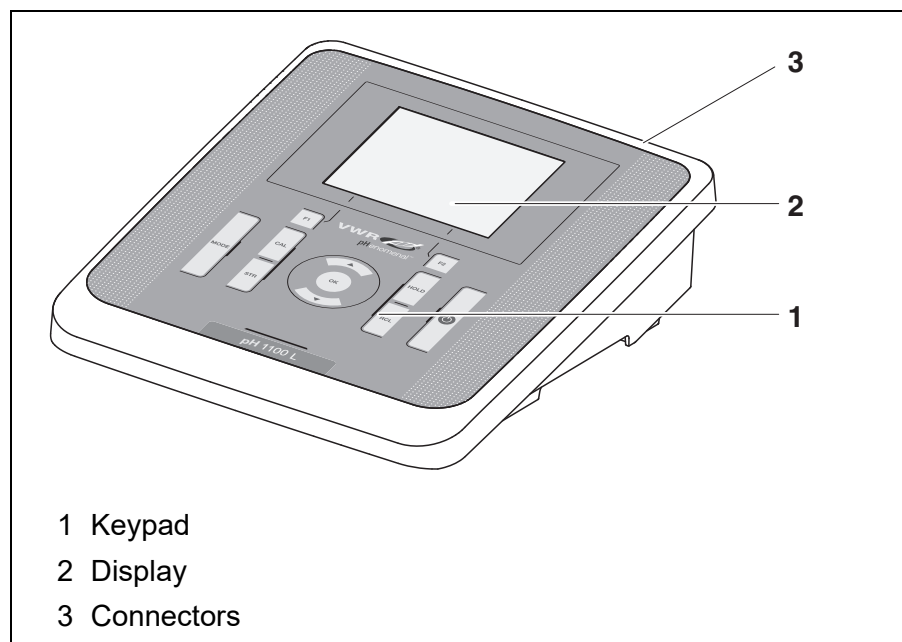

## 2.1 Keypad

In this operating manual, keys are indicated by brackets <.> .  
The key symbol (e.g. **<OK>**) generally indicates a short keystroke (under 2 sec) in this operating manual. A long keystroke (approx. 2 sec) is indicated by the underscore behind the key symbol (e.g. **<OK\_\_ >**).

<b>&lt;F1&gt;</b> :	Softkeys providing situation dependent functions, e.g.: <b>&lt;F1&gt;/[Menu]</b> : Opens the menu for measurement settings <b>&lt;F1__&gt;/[Menu]</b> : Opens the menu for system settings
<b>&lt;F1__&gt;</b> :	
<b>&lt;F2&gt;</b> :	
<b>&lt;F2__&gt;</b> :	
<b>&lt;On/Off&gt;</b> :	Switches the meter on or off
<b>&lt;MODE&gt;</b> :	Selects the measured parameter
<b>&lt;CAL&gt;</b> :	Calls up the calibration procedure Displays the calibration data
<b>&lt;CAL__&gt;</b> :	
<b>&lt;STR&gt;</b> :	Saves a measured value manually Opens the menu for the automatic save function
<b>&lt;STR__ &gt;</b> :	
<b>&lt;RCL&gt;</b> :	Displays the manually stored measured values Displays the automatically stored measured values
<b>&lt;RCL__&gt;</b> :	
<b>&lt;▲ &gt;</b> :	Increments values, scrolls
<b>&lt;▼ &gt;</b> :	Decrements values, scrolls
<b>&lt;OK&gt;</b> :	Opens the menu for measurement settings / confirms entries Opens the menu for system settings
<b>&lt;OK__ &gt;</b> :	
<b>&lt;HOLD&gt;</b>	Freezes the measured value (HOLD function)Switches the AutoRead measurement on or off

## 2.2 Display

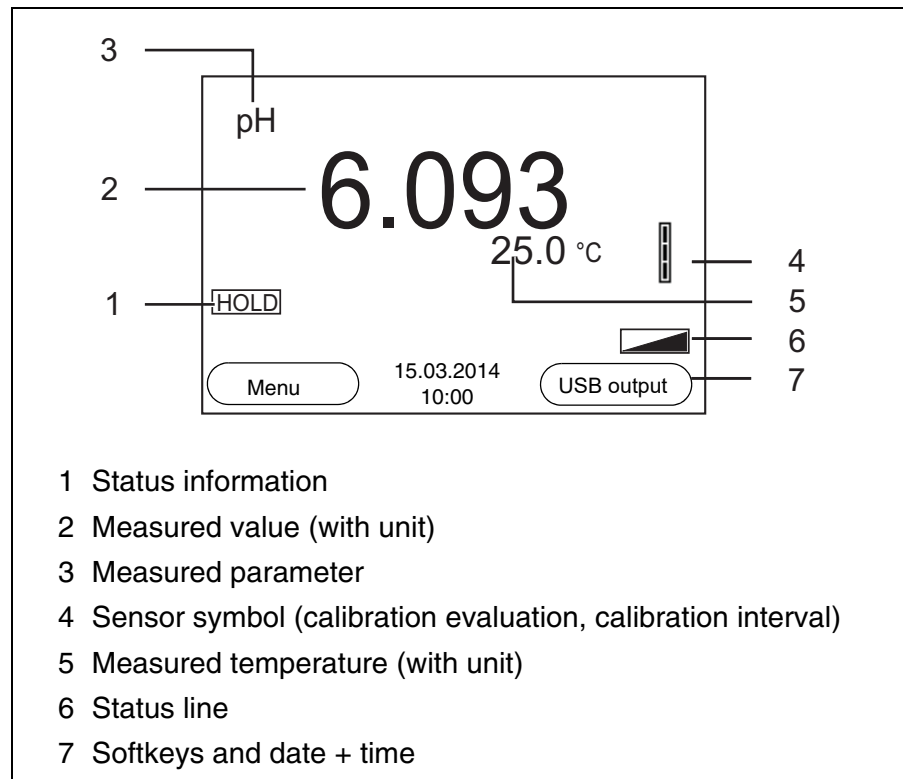

### Function display indicators

AutoCal e.g. TEC	Calibration with automatic buffer recognition, e.g. with the buffer set: Technical buffers
AnyCal	Calibration with any buffers
Error	An error occurred during calibration
LoBat	Batteries are almost empty
AR	Stability control (AutoRead) is active (calibration)
HOLD	Measured value is frozen (<HOLD> key)
	Batteries are almost empty

## 2.3 Connectors

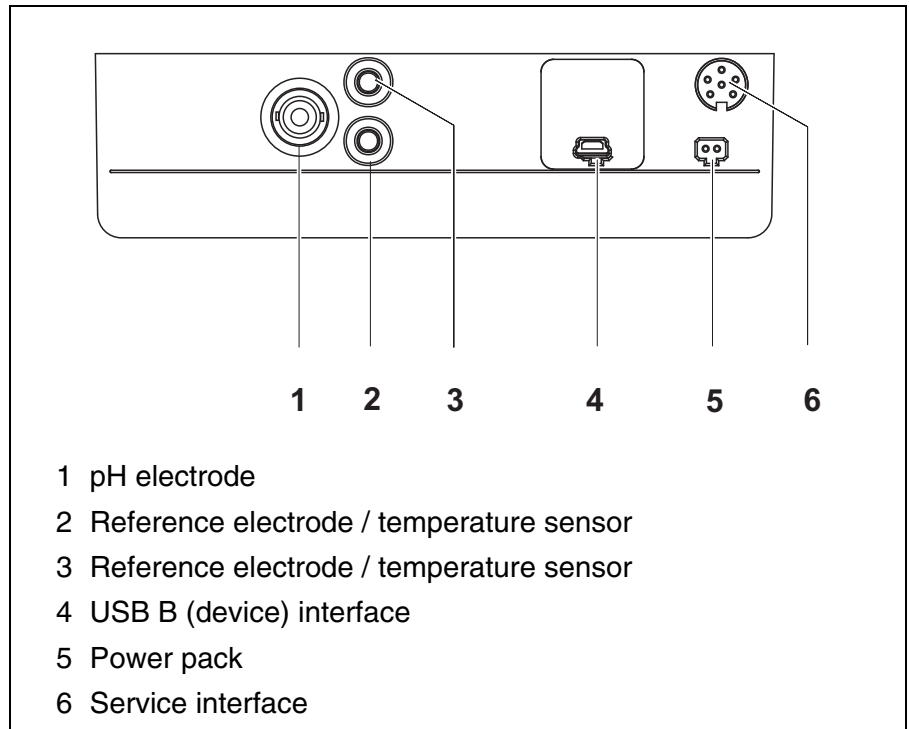

### Caution

Only connect sensors to the meter that cannot return any voltages or currents that are not allowed (> SELV and > current circuit with current limiting).

Almost all customary sensors fulfill these conditions.

### 3 Technical data

#### 3.1 General data

<b>Dimensions</b>	ca. 240 x 190 x 80 mm	
<b>Weight</b>	Approx. 1.0 kg	
<b>Mechanical structure</b>	Type of protection	IP 43
<b>Electrical safety</b>	Protective class	III
<b>Test certificates</b>	CE	
<b>Ambient conditions</b>	Storage	- 25 °C ... + 65 °C
	Operation	-10 °C ... + 55 °C
	Admissible relative humidity	Yearly mean: < 75 % 30 days/year: 95 % Other days: 85 %
<b>Power supply</b>	Batteries	4 x 1.5 V alkali-manganese batteries, type AA
	Rechargeable batteries	4 x 1.2 V NiMH rechargeable batteries, type AA (no charging function)
	Operational life	Up to 1000 h without / 150 h with illumination
	Power pack	Input: 100 ... 240 V ~ / 50 ... 60 Hz / 0,5 mA Output: 9 V = / 1.1 A Connection max. overvoltage category II Primary plugs contained in the scope of delivery: Euro, US, UK and Australian.
<b>Sensor input</b>	Input resistance	> 5 * 10 <sup>12</sup> ohm
	Input current	< 1 * 10 <sup>-12</sup> A
<b>USB interface</b>	Type	USB 1.1 USB B (device), data output
	Baud rate	Adjustable: 1200, 2400, 4800, 9600, 19200 Baud
	Data bits	8
	Stop bits	2
	Parity	None
	Handshake	RTS/CTS
	Cable length	Max. 3 m
<b>Guidelines and norms used</b>	EMC	EU directive 2014/30/EU EN 61326-1 FCC Class A

Meter safety	EU directive 2014/30/EU EN 61010-1
IP protection class	EN 60529
RoHS	EU directive 2011/65/EU

### 3.2 Measuring ranges, resolution, accuracy

#### Measuring ranges, resolution

Variable	Measuring range	Resolution
pH	- 2.0 ... + 20.0	0.1
	- 2.00 ... + 20.00	0.01
	- 2.000 ... + 19.999	0.001
U [mV]	- 2500 ... + 2500	1
	- 1200.0 ... + 1200.0	0.1
T [°C]	- 5.0 ... + 105.0	0.1
T [°F]	23.0 ... + 221.0	0.1

#### Manual temperature input

Variable	Range	Increment
T <sub>manual</sub> [°C]	- 25 ... + 130	1
T <sub>manual</sub> [°F]	-13 ... + 266	1

#### Accuracy (± 1 digit)

Variable	Accuracy	Temperature of the test sample
<b><i>pH / range *</i></b>		
- 2.0 ... + 20.0	± 0.1	+ 15 °C ... + 35 °C
- 2.00 ... + 20.00	± 0.01	+ 15 °C ... + 35 °C
- 2.000 ... + 19.999	± 0.005	+ 15 °C ... + 35 °C
<b><i>U [mV] / range</i></b>		
- 2500 ... + 2500	± 1	+ 15 °C ... + 35 °C
-1200.0 ... +1200.	± 0.3	+ 15 °C ... + 35 °C
<b><i>T [°C] / temperature sensor</i></b>		
NTC 30	± 0.1	
PT 1000	± 0.1	

\* when measuring in a range of ± 2 pH around a calibration point



#### Note

The accuracy values specified here apply exclusively to the meter. The accuracy of the electrodes and buffer solutions has to be taken into

account additionally.

## 4 Commissioning

### 4.1 Scope of delivery

- pH meter pH 1100 L
- 4 batteries 1.5 V Mignon type AA
- Power pack
- Stand
- Stand holder
- Short instructions
- CD-ROM with
  - USB drivers
  - detailed operating manual
  - Software MultiLab Importer

### 4.2 Initial commissioning

Perform the following activities:

- Insert the supplied batteries
- For mains operation: Connect the power pack
- If necessary, mount the stand
- Switch on the meter
- Set the date and time

#### 4.2.1 Inserting the batteries

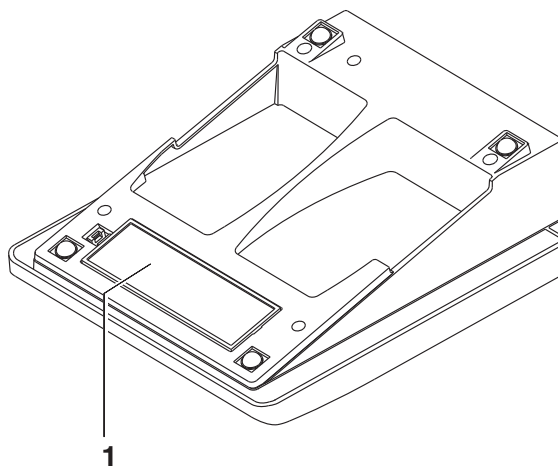

- 1 | Open the battery compartment (1) on the underside of the meter.



**Caution**

Make sure that the poles of the batteries are positioned correctly. The ± signs on the batteries must correspond to the ± signs in the battery compartment.



**Note**

Alternatively, you can also use Ni-MH rechargeable batteries (type Mignon AA). In order to charge the batteries, an external charging device is required.

- 2 | Place four batteries (type Mignon AA) in the battery compartment.
- 3 | Close the battery compartment.

**4.2.2 Connecting the power pack**



**Caution**

The line voltage at the operating site must lie within the input voltage range of the original power pack (see section 3.1).



**Caution**

Use original power packs only.

- 1 | Insert the plug into the socket of the pH 1100 L.
- 2 | Connect the original power pack to an easily accessible power outlet.



**Note**

You can carry out measurements without the power pack.

**4.2.3 Switching on the meter**

- 1 | Press the **<On/Off>** key.  
The meter performs a self-test.  
The display shows the manufacturer's logo while the self-test is being performed.  
Subsequently, the meter switches to the measuring mode (measured value display).

**Note**

The meter has an energy saving feature to avoid unnecessary battery depletion.

The energy saving feature switches off the meter if no key is pressed during the adjusted interval. (How to set the switch-off interval, see section 5.3.1).

**4.2.4 Setting the date and time**

- |   |                   |
|---|-------------------|
| 1 | See section 5.2.4 |
|---|-------------------|

**4.2.5 Stand**

The stand base can be mounted at the right side of the meter.

- |   |   |
|---|---|
| 1 | Screw the stand base to the underside of the meter. |
| 2 | Insert the stand rod in the stand base.             |

An arrangement of the meter with the stand may look as follows:



## 5 Operation

### 5.1 Switching on the meter

#### Switching on

Press the **<On/Off>** key.

The meter performs a self-test.

The display shows the manufacturer's logo while the self-test is being performed.

The measured value display appears.

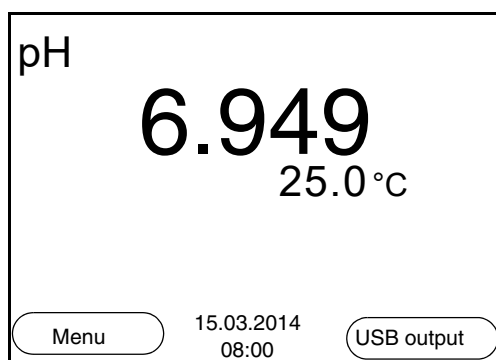

#### Switching off

Press the **<On/Off>** key.

#### Automatic switch-off function

The instrument has an automatic switch-off function in order to save the batteries (see section 5.3.1). The automatic switch-off function switches off the meter if no key is pressed for an adjustable period.

The automatic switch-off function is not active

- if the communication cable is connected
- if the power pack is connected
- if the *Autom. storage* function is active, or with automatic data transmission

#### Display illumination

The meter automatically switches off the display illumination if no key is pressed for 30 seconds. The illumination is switched on with the next keystroke again.

You can also generally switch the display illumination on or off (see section 5.3.1).

## 5.2 General operating principles

This section contains basic information on the operation of the pH 1100 L.

### Operating elements, display

An overview of the operating elements and the display is given in section 2.1 and section 2.2.

### Operating modes, navigation

An overview of the operating modes and navigation of the pH 1100 L is given in section 5.2.1 and section 5.2.2.

### 5.2.1 Operating modes

The instrument has the following operating modes:

- Measuring  
The measurement data of the connected sensor are shown in the measured value display
- Calibration  
The course of a calibration with calibration information, functions and settings is displayed
- Storing in memory  
The meter stores the measurement data manually or automatically
- Transmitting data  
The meter transmits measurement data and calibration records to the USB interface automatically or manually.
- Setting  
The system menu or a sensor menu with submenus, settings and functions is displayed

## 5.2.2 Navigation

### Measured value display

In the measured value display, you can

- open the menu for calibration and measurement settings with **<F1>** (short keystroke)
- open the system menu with the sensor-independent settings by pressing **<F1>** *Storage & config* for a **<F1\_\_>**long keystroke, approx. 2 s).
- change the display in the selected measuring screen (e. g. pH <-> mV) by pressing **<MODE>**.

### Menus and dialogs

The menus for settings and dialogs in procedures contain further sub-elements. The selection is made with the **<▲>****<▼>** keys. The current selection is displayed with a frame.

- Submenus

The name of the submenu is displayed at the upper edge of the frame. Submenus are opened by confirming with **<OK>**. Example:

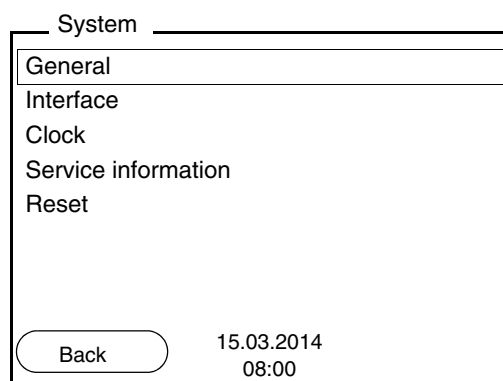

- Settings

Settings are indicated by a colon. The current setting is displayed on the right-hand side. The setting mode is opened with **<OK>**. Subsequently, the setting can be changed with **<▲>****<▼>** and **<OK>**. Example:

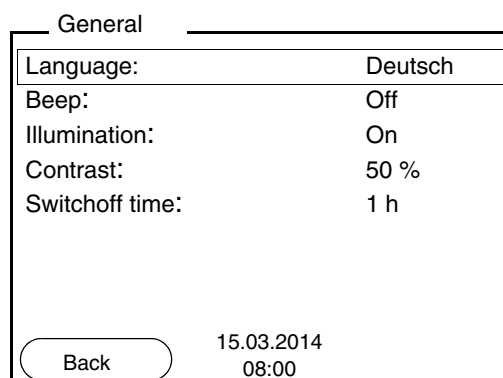

- **Functions**

Functions are designated by the name of the function. They are immediately carried out by confirming with **<OK>**.

Example: Display the *Calibration record* function.

pH

Calibration record	
Calibration data storage	
Buffer:	TEC
One point calibration:	Yes
Calibration interval:	7 d
Unit for slope:	mV/pH
<i>i</i> 4.00 7.00 10.00 (20 °C)	
Back	15.03.2014 08:00

**Messages**

Information is marked by the *i* symbol. It cannot be selected. Example:

pH

Calibration record	
Calibration data storage	
Buffer:	TEC
One point calibration:	Yes
Calibration interval:	7 d
Unit for slope:	mV/pH
<i>i</i> 4.00 7.00 10.00 (20 °C)	
Back	15.03.2014 08:00



**Note**

The principles of navigation are explained in the two following sections by reference of examples:

- Setting the language (section 5.2.3)
- Setting the date and time (see section 5.2.4).

### 5.2.3 Navigation example 1: Setting the language

- 1 Press the **<On/Off>** key.  
The measured value display appears.  
The instrument is in the measuring mode.

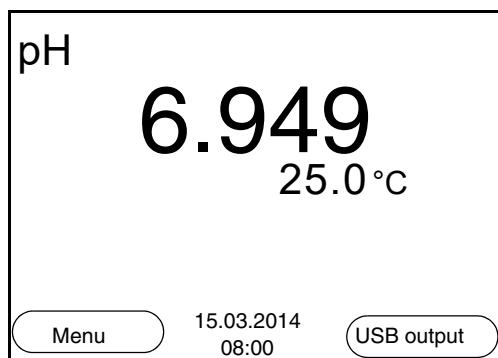

- 2 Using **<F1\_\_>**/[Menu], open the *Storage & config* menu.  
The instrument is in the setting mode.

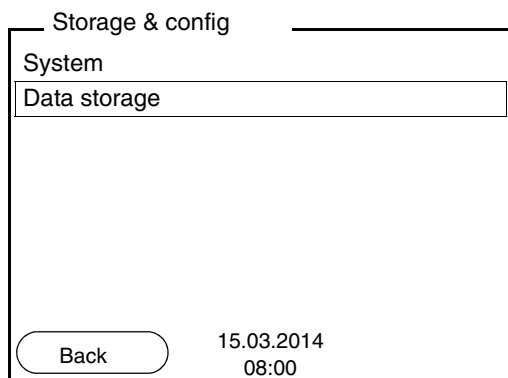

- 3 Select the *System* submenu with **<▲>**/**<▼>**.  
The current selection is displayed with a frame.
- 4 Open the *System* submenu with **<OK>**.

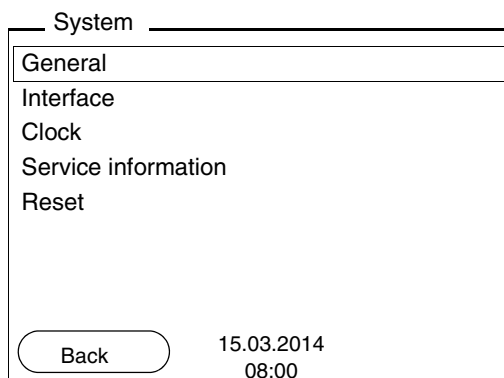

5 | Select the *General* submenu with <▲><▼>. The current selection is displayed with a frame.

6 | Open the *General* submenu with <OK>.

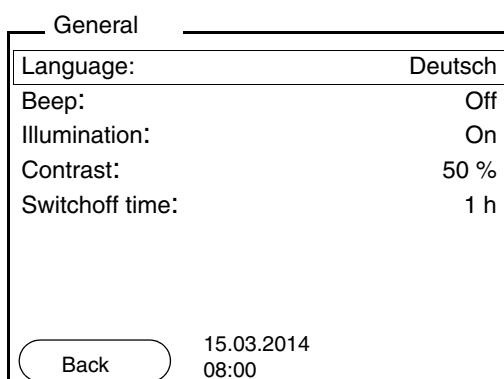

7 | Open the setting mode for the *Language* with <OK>.

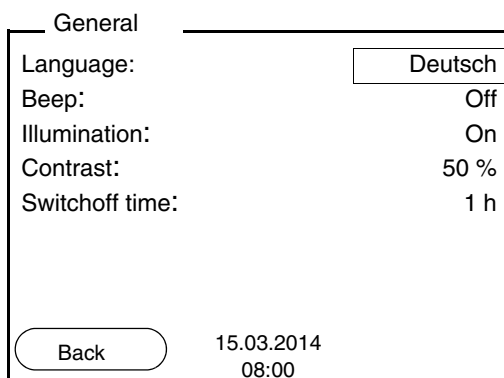

8 | Select the required language with <▲><▼>.

- |   |   |
|---|---|
| 9 | <p>Confirm the setting with <b>&lt;OK&gt;</b>.<br/>         The meter switches to the measuring mode.<br/>         The selected language is active.</p> |
|---|---|

#### 5.2.4 Example 2 on navigation: Setting the date and time

The meter has a clock with a date function. The date and time are indicated in the status line of the measured value display.

When storing measured values and calibrating, the current date and time are automatically stored as well.

The correct setting of the date and time and date format is important for the following functions and displays:

- Current date and time
- Calibration date
- Identification of stored measured values.

Therefore, check the time at regular intervals.



#### Note

After a fall of the supply voltage (empty batteries), the date and time are reset.

#### Setting the date, time and date format

The date format can be switched from the display of day, month, year (*dd.mm.yyyy*) to the display of month, day, year (*mm/dd/yyyy* or *mm.dd.yyyy*).

1	<p>In the measured value display:          Using <b>&lt;F1__&gt;/[Menu]</b>, open the <i>Storage &amp; config</i> menu.          The instrument is in the setting mode.</p>
2	<p>Select and confirm the <i>System / Clock</i> menu with <b>&lt;▲&gt;&lt;▼&gt;</b> and <b>&lt;OK&gt;</b>.          The setting menu for the date and time opens up.</p>
3	<p>Select and confirm the <i>Time</i> menu with <b>&lt;▲&gt;&lt;▼&gt;</b> and <b>&lt;OK&gt;</b>.          The hours are highlighted.</p>

Clock

Date format:	dd.mm.yyyy
Date:	15.03.2014
Time:	14:53:40
<div style="display: flex; justify-content: space-between; align-items: center;"> <span>Back</span> <span>15.03.2014 08:00</span> </div>	

4	Change and confirm the setting with <b>&lt;▲&gt;&lt;▼&gt;</b> and <b>&lt;OK&gt;</b> . The minutes are highlighted.
5	Change and confirm the setting with <b>&lt;▲&gt;&lt;▼&gt;</b> and <b>&lt;OK&gt;</b> . The seconds are highlighted.
6	Change and confirm the setting with <b>&lt;▲&gt;&lt;▼&gt;</b> and <b>&lt;OK&gt;</b> . The time is set.
7	If necessary, set the <i>Date</i> and <i>Date format</i> . The setting is made similarly to that of the time.
8	If necessary, select and set the <i>Date</i> with <b>&lt;▲&gt;&lt;▼&gt;</b> and <b>&lt;OK&gt;</b> .
9	To make further settings, switch to the next higher menu level with <b>&lt;F1&gt;/[Back]</b> . or Switch to the measured value display with <b>&lt;MODE&gt;</b> . The instrument is in the measuring mode.

### 5.3 Sensor-independent settings

The *Storage & config* menu comprises the following settings:

- *System* (see section 5.3.1).
- *Data storage* (see section 5.3.2)

#### 5.3.1 System

##### Overview

The following sensor-independent meter characteristics can be adjusted in the *Storage & config/System* menu:

- Menu language
- Beep on keystroke
- Illumination
- Display contrast
- Interval of the automatic switch-off function
- Data interface
- Clock and date function
- Reset of all sensor-independent system settings to the default condition

##### Settings

To open the *Storage & config* menu, press the **<F1\_\_>/[Menu]** key in the measured value display. After completing the settings, switch to the measured value display with **<MODE>**.

Menu item	Setting	Explanation
<i>System / General / Language</i>	<i>Deutsch</i> <i>English</i> (more)	Selects the menu language
<i>System / General / Beep</i>	<i>On</i> <i>Off</i>	Switches on/off the beep on keystroke
<i>System / General / Illumination</i>	<i>Auto</i> <i>On</i> <i>Off</i>	Switches the display illumination on/off
<i>System / General / Contrast</i>	0 ... 100 %	Changes the display contrast
<i>System / General / Switchoff time</i>	10 min ... 24 h	Adjusts the switch-off time
<i>System / Interface / Baud rate</i>	1200, 2400, 4800, 9600, 19200	Baud rate of the data interface

Menu item	Setting	Explanation
<i>System / Interface / Output format</i>	<i>ASCII</i> <i>CSV</i>	Output format for data transmission For details, see section 5.6
<i>System / Interface / Decimal separator</i>	<i>Dot (xx.x)</i> <i>Comma (xx,x)</i>	Decimal separator
<i>System / Interface / Output header</i>		Output of a header for <i>Output format: CSV</i>
<i>System / Clock</i>	<i>Time</i> <i>Date</i> <i>Date format</i>	Settings of time and date. For details, see section 5.2.4
<i>System / Service information</i>		Hardware version and software version of the meter are displayed.
<i>System / Reset</i>	-	Resets the system settings to the default values. For details, see section 5.8.2

### 5.3.2 Data storage

This menu contains all functions to display, edit and erase stored measured values and calibration records.



#### Note

Detailed information on the memory functions of the pH 1100 L is given in section 5.5.

### 5.3.3 Automatic Stability control

The automatic *Stability control* (AutoRead) function continuously checks the stability of the measurement signal. The stability has a considerable impact on the reproducibility of measured values.

You can activate or switch off the automatic *Stability control* function (see section 5.4.4).

The measured parameter flashes on the display

- as soon as the measured value is outside the stability range
- when the automatic *Stability control* is switched off.

## 5.4 pH value / ORP voltage

### 5.4.1 General information

You can measure the following parameters:

- pH value [ ]
- ORP [mV]



#### Temperature measurement

#### Attention

**When a grounded PC is connected, measurements cannot be performed in grounded media as incorrect values would result. The USB-A (Device) is not galvanically isolated.**

For reproducible pH measurements, it is essential to measure the temperature of the test sample.

You have the following options to measure the temperature:

- Automatic measurement of the temperature by the temperature sensor (NTC30 or Pt1000) integrated in electrode.
- Measurement by an external temperature sensor.
- Manual determination and input of the temperature.

The measuring instrument recognizes whether a suitable sensor is connected and automatically switches on the temperature measurement.

The display of the temperature indicates the active temperature measuring mode:

Temperature sensor	Resolution of the temp. display	Mode
yes	0.1 °C	Automatic with temperature sensor
-	1 °C	Manual

### Preparatory activities

Perform the following preparatory activities when you want to measure:

1	Connect a pH or ORP electrode to the meter. The pH measuring window is displayed.
2	If necessary, select the pH or mV display with <b>&lt;MODE&gt;</b> .
3	Adjust the temperature of the solutions and measure the current temperature if the measurement is made without a temperature sensor.
4	Calibrate or check the meter with the electrode.

### 5.4.2 Measuring the pH value

1	Perform the preparatory activities according to section 5.4.1.
2	Immerse the pH electrode in the test sample.

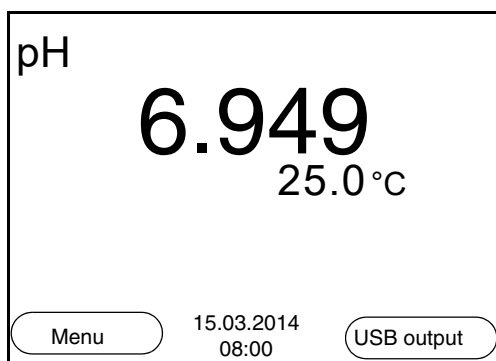

3	Select the pH or mV display with <b>&lt;MODE&gt;</b> .
---	--

#### Stability control (AutoRead)

The stability control function (AutoRead) continually checks the stability of the measurement signal. The stability has a considerable impact on the reproducibility of measured values.

The measured parameter flashes on the display

- as soon as the measured value is outside the stability range
- when the automatic *Stability control* is switched off.

#### Criteria for a stable measured value

The *Stability control* function checks whether the measured values are stable within the monitored time interval.

Measured parameter	Time interval	Stability during the time interval
pH value	15 seconds	$\Delta$ : better than 0.01 pH
Temperature	15 seconds	$\Delta$ : better than 0.5 °C

The minimum duration until a measured value is assessed as stable is the monitored time interval. The actual duration is mostly longer.

#### HOLD function

1	Freeze the measured value with <b>&lt;HOLD&gt;</b> . The [HOLD] status indicator is displayed. The HOLD function is active.
---	---

- 2 | Release the frozen measured value again with **<HOLD>** or **<MODE>**.  
The [HOLD] status display disappears. The display switches back to the previous indication.

### 5.4.3 Measuring the ORP



**Note**

ORP electrodes are not calibrated. However, you can check ORP electrodes using a test solution.

- 1 | Perform the preparatory activities according to section 5.4.1.
- 2 | Submerge the ORP electrode in the sample.

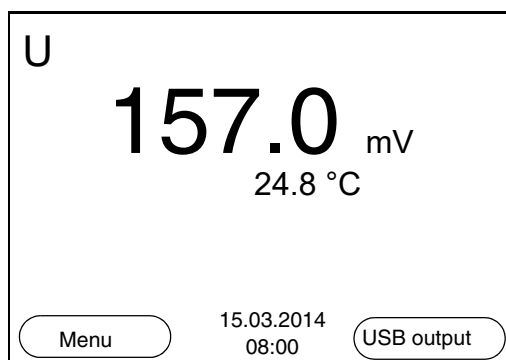

- 3 | Select the mV display with **<MODE>**.

**Stability control (AutoRead)**

The stability control function (AutoRead) continually checks the stability of the measurement signal. The stability has a considerable impact on the reproducibility of measured values.

The measured parameter flashes on the display

- as soon as the measured value is outside the stability range
- when the automatic *Stability control* is switched off.

**Criteria for a stable measured value**

The *Stability control* function checks whether the measured values are stable within the monitored time interval.

Measured parameter	Time interval	Stability during the time interval
ORP	15 seconds	$\Delta$ : better than 0.3 mV

Measured parameter	Time interval	Stability during the time interval
Temperature	15 seconds	$\Delta$ : better than 0.5 °C

The minimum duration until a measured value is assessed as stable is the monitored time interval. The actual duration is mostly longer.

### HOLD function

1	Freeze the measured value with <b>&lt;HOLD&gt;</b> . The [HOLD] status indicator is displayed. The HOLD function is active.
2	Release the frozen measured value again with <b>&lt;HOLD&gt;</b> or <b>&lt;MODE&gt;</b> . The [HOLD] status display disappears. The display switches back to the previous indication.

### 5.4.4 Settings for pH and ORP measurements

#### Overview

The following settings are possible for pH and ORP measurements:

- Resolution
- Calibration interval
- Buffers for calibration
- Unit of the temperature
- Automatic stability control
- Unit for slope
- Calibration record (display)

#### Settings

The settings are made in the menu for calibration and measurement settings of the pH/ORP measurement. To open the settings, display the required parameter in the measured value display and press the **<F1>**/ [menu] or **<OK>** key. After completing the settings, switch to the measured value display with **<MODE>**.

Menu item	Possible setting	Explanation
<i>Calibration / Calibration record</i>	-	Displays the calibration record of the last calibration.

Menu item	Possible setting	Explanation
<i>Calibration / Buffer</i>	TEC AnyCal NIST/DIN TEC 2 ...	Buffer sets to be used for pH calibration. More buffers and details, see section 5.4.5.
<i>Calibration / Calibration data storage</i>	-	Displays the last calibration records.
<i>Calibration / One point calibration</i>	Yes No	Quick calibration with 1 buffer
<i>Calibration / Serial number (sensor)</i>	-	Entry of the serial number of the connected sensor. The serial number is output in the calibration record. <ul style="list-style-type: none"> <li>● Change the contents of the highlighted position with &lt;▲ &gt;&lt;▼ &gt;.</li> <li>● Go to the next position with &lt;F2&gt;/[▶].</li> <li>● When the serial number has been completely entered, confirm with &lt;OK&gt;.</li> </ul>
<i>Calibration / Calibration interval</i>	1 ... 999 d	<i>Calibration interval</i> for the pH electrode (in days). The meter reminds you to calibrate regularly by the flashing sensor symbol in the measuring screen.
<i>Calibration / Unit for slope</i>	mV/pH %	Unit of the slope. The % display refers to the Nernst slope of -59.2 mV/pH (100 x determined slope/Nernst slope).
<i>Man. temperature</i>	-25 ... +130 °C	Entry of the manually determined temperature. For measurements without temperature sensor only.

Menu item	Possible setting	Explanation
<i>Temperature unit</i>	°C °F	Temperature unit, degrees Celsius or degrees Fahrenheit. All temperature values are displayed with the selected unit.
<i>Resolution pH</i>	0.001 0.01 0.1	Resolution of the pH display:
<i>Resolution mV</i>	0.1 1	Resolution of the mV display:
<i>Stability control</i>	<i>On / Off</i>	Switches on or off the automatic stability control during measurement (see section 5.3.3)
<i>Reset</i>	-	Resets all sensor settings to the delivery condition (see section 5.8.1).

#### 5.4.5 pH calibration

##### Why calibrate?

pH electrodes age. This changes the zero point (asymmetry) and slope of the pH electrode. As a result, an inexact measured value is displayed. Calibration determines and stores the current values of the zero point and slope of the electrode. Thus, you should calibrate at regular intervals.

##### When do you have to calibrate?

- After connecting another combination electrode
- When the calibration interval has expired

##### Buffer sets for calibration

You can use the buffer sets quoted in the table for an automatic calibration. The pH values are valid for the specified temperature values. The temperature dependence of the pH values is taken into consideration during calibration.

No.	Buffer set *	pH values	at
1	TEC EU Technical buffers EU	2.00 4.00 7.00 10.00	20 °C
2	TEC US Technical buffers US	1.68 4.01 7.00 10.01 12.45	25 °C
3	AnyCal	Any	Any
4	NIST/DIN DIN buffers according to DIN 19266 and NIST Traceable Buffers	1.679 4.006 6.865 9.180 12.454	25 °C
5	TEC 2 Technical buffers	4.010 7.000 10.011	25 °C
6	Merck 1*	4.000 7.000 9.000	20°C
7	Merck 2 *	1.000 6.000 8.000 13.000	20°C
8	Merck 3 *	4.660 6.880 9.220	20°C
9	Merck 4 *	2.000 4.000 7.000 10.000	20°C
10	Merck 5 *	4.010 7.000 10.000	25 °C

\* Brand names or trade names are trademarks of their respective owners protected by law.

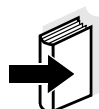

#### Note

The buffers are selected in the menu, pH / <F1>/[Menu] / Calibration / Buffer (see page 31).

**Calibration points**

Calibration can be performed using one to five buffer solutions in any order (single-point to five-point calibration). The meter determines the following values and calculates the calibration line as follows:

	<b>Determined values</b>	<b>Displayed calibration data</b>
<b>1-point</b>	<i>Asy</i>	<ul style="list-style-type: none"> <li>● Zero point = <i>Asy</i></li> <li>● Slope = Nernst slope (-59.2 mV/pH at 25 °C)</li> </ul>
<b>2-point</b>	<i>Asy</i> <i>Slp.</i>	<ul style="list-style-type: none"> <li>● Zero point = <i>Asy</i></li> <li>● Slope = <i>Slp.</i></li> </ul>
<b>3-point to 5-point</b>	<i>Asy</i> <i>Slp.</i>	<ul style="list-style-type: none"> <li>● Zero point = <i>Asy</i></li> <li>● Slope = <i>Slp.</i></li> </ul> <p>The calibration line is calculated by linear regression.</p>

**Stability control****Note**

You can display the slope in the units, mV/pH or % (see page 31).

The calibration procedure automatically activates the stability control function. The current measurement with stability control can be terminated at any time (accepting the current value).

**Calibration record**

The new calibration values are displayed when the calibration is finished.

**Display calibration data and output to interface**

You can have the data of the last calibration displayed (see page 44). Subsequently, you can transmit the displayed calibration data to the interface, e.g. to a PC, with the **<F2>/[USB output]** key.

**Note**

The calibration record is automatically transmitted to the interface after calibrating.

**Sample record**

```

30.03.2014 15:55
pH 1100 L
Ser. no. 08502113

CALIBRATION pH

AutoCal TEC
Buffer 1          4.00
Buffer 2          7.00
Buffer 3          10.00
Voltage 1         184.0 mV
Voltage 2         3.0 mV
Voltage 3         -177.0 mV
Temperatur 1     24.0 °C
Temperatur 2     24.0 °C
Temperatur 3     24.0 °C
Slope            -60.2 mV/pH
Asymmetry        4.0 mV
Sensor           +++

etc...
    
```

**Calibration evaluation**

After calibrating, the meter automatically evaluates the calibration. The zero point and slope are evaluated separately. The worse evaluation of both is taken into account. The evaluation appears on the display and in the calibration record.

Display	Calibration record	Zero point [mV]	Slope [mV/pH]
	+++	-15 ... +15	-60,5 ... -58
	++	-20 ... +20	-58 ... -57
	+	-25 ... +25	-61 ... -60.5 or -57 ... -56
	-	-30 ... +30	-62 ... -61 or -56 ... -50
Clean the electrode according to the electrode operating manual			
Error	Error	< -30 or > 30	... -62 or ... -50
Eliminate the error according to chapter 7 WHAT TO DO IF... (page 61)			

**Preparatory activities**

Perform the following preparatory activities when you want to calibrate:

1	Connect the pH electrode to the meter. The pH measuring window is displayed.
2	Keep the buffer solutions ready. Adjust the temperature of the buffer solutions, or measure the current temperature, if you measure without a temperature sensor.

**5.4.6 Calibration interval**

The calibration evaluation is displayed as a sensor symbol.

The sensor symbol flashes after the adjusted calibration interval has expired. It is still possible to measure.

**Note**

To ensure the high measuring accuracy of the measuring system, calibrate after the calibration interval has expired.

**Setting the calibration interval**

The calibration interval is set to 7 days (d7) in the factory. You can change the interval (1 ... 999 days):

1	Open the menu for measurement settings with <b>&lt;F1&gt;/[Menu]</b> .
2	In the <i>Calibration / Calibration interval</i> menu, set the calibration interval with <b>&lt;▲&gt;&lt;▼&gt;</b> .
3	Confirm the setting with <b>&lt;OK&gt;</b> .
4	Quit the menu with <b>&lt;MODE&gt;</b> .

**5.4.7 Carrying out automatic calibration (AutoCal)**

Make sure that in the sensor menu, *Buffer* menu, the buffer set is correctly selected (see page 31).

Use any one to five buffer solutions of the selected buffer set in ascending or descending order.

Below, calibration with Technical buffers (TEC) is described. When other buffer sets are used, other nominal buffer values are displayed. Apart from that, the procedure is identical.

**Note**

If single-point calibration was set in the menu, the calibration procedure

is automatically finished with the measurement of buffer solution 1 and the calibration record is displayed.

- |   |  |
|---|--|
| 1 | In the measured value display, select the measured parameter pH or mV with <b>&lt;MODE&gt;</b> .                           |
| 2 | Start the calibration with <b>&lt;CAL&gt;</b> .<br>The calibration display for the first buffer appears (voltage display). |

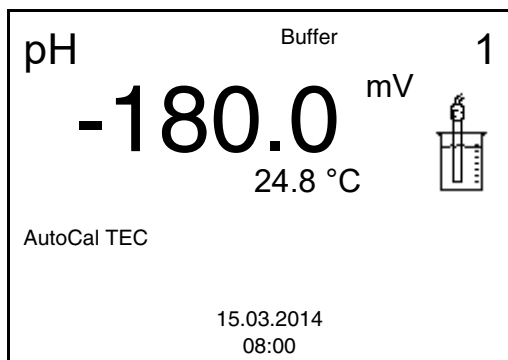

- |   |   |
|---|---|
| 3 | Thoroughly rinse the electrode with deionized water.  |
| 4 | Immerse the electrode in buffer solution 1.   |
| 5 | When measuring without temperature sensor:<br>Measure the temperature of the buffer manually and enter it with <b>&lt;▲&gt;&lt;▼&gt;</b> .  |
| 6 | Start the measurement with <b>&lt;OK&gt;</b> .<br>The measured value is checked for stability (stability control).<br>The [AR] status indicator is displayed. The measured parameter flashes. |

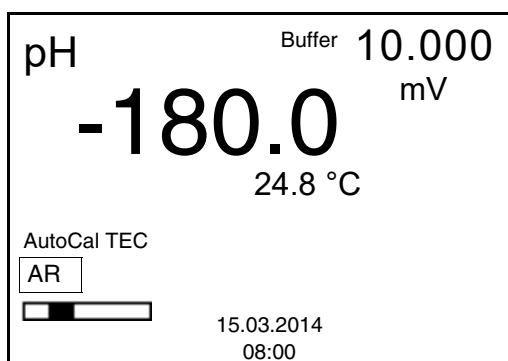

- |   |   |
|---|---|
| 7 | Wait for the end of the measurement with stability control or accept the calibration value with <b>&lt;OK&gt;</b> . |
|---|---|

- 8 | If necessary, finish the calibration procedure as a single-point calibration with **<MODE>**.  
The calibration record is displayed.



**Note**

For **single-point calibration**, the instrument uses the Nernst slope (-59.2 mV/pH at 25 °C) and determines the zero point of the electrode.

**Continuing with two-point calibration**

- 9 | Thoroughly rinse the electrode with deionized water.
- 10 | Immerse the electrode in buffer solution 2.
- 11 | When measuring without temperature sensor:  
Measure the temperature of the buffer manually and enter it with **<▲><▼>**.
- 12 | Start the measurement with **<OK>**.  
The measured value is checked for stability (stability control).  
The [AR] status indicator is displayed. The measured parameter flashes.

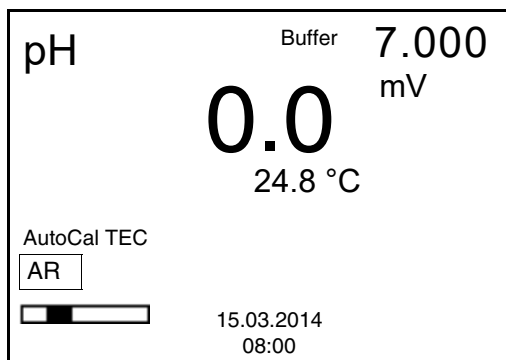

- 13 | Wait for the measurement with stability control to be completed or terminate the stability control and take over the calibration value with **<OK>**.  
The calibration display for the next buffer appears (voltage display).
- 14 | If necessary, finish the calibration procedure as a two-point calibration with **<MODE>**.  
The calibration record is displayed.

**Continuing with three-to five-point calibration**

- 15 | Thoroughly rinse the electrode with deionized water.
- 16 | Immerse the electrode in the next buffer solution.

- |    |   |
|----|---|
| 17 | When measuring without temperature sensor:<br>Measure the temperature of the buffer manually and enter it with <▲><▼>.  |
| 18 | Start the measurement with <OK>.<br>The measured value is checked for stability (stability control).<br>The [AR] status indicator is displayed. The measured parameter flashes. |

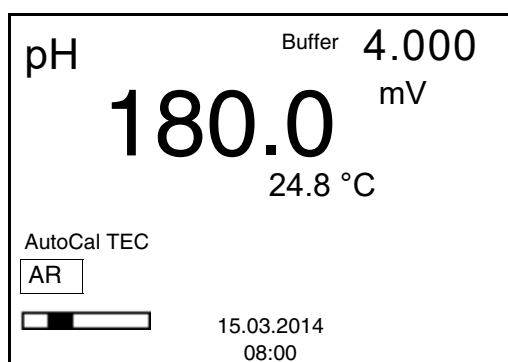

- |    |   |
|----|---|
| 19 | Wait for the measurement with stability control to be completed or terminate the stability control and take over the calibration value with <OK>.<br>The calibration display for the next buffer appears (voltage display). |
| 20 | If necessary, use <MODE> to finish calibration or switch to calibration with the next buffer with <OK>.   |



### Note

Calibration is automatically completed after the last buffer of a buffer set has been measured. Then the calibration record is displayed.

The calibration line is determined by linear regression.

### 5.4.8 Carrying out a manual calibration (AnyCal)

Make sure that in the sensor menu, *Buffer* menu, the AnyCal buffer set is correctly selected (see page 31).

Use any one to five buffer solutions in ascending or descending order.



### Note

If single-point calibration was set in the menu, the calibration procedure is automatically finished with the measurement of buffer solution 1 and the calibration record is displayed.

- 1 In the measured value display, select the measured parameter pH or mV with **<MODE>**.
- 2 Start the calibration with **<CAL>**.  
The calibration display appears.

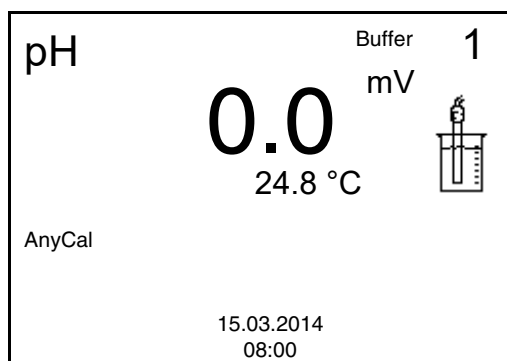

- 3 Thoroughly rinse the electrode with deionized water.
- 4 Immerse the electrode in buffer solution 1.
- 5 When measuring without temperature sensor:  
Measure the temperature of the buffer manually and enter it with **<▲><▼>**.
- 6 Start the measurement with **<OK>**.  
The measured value is checked for stability (stability control).  
The [AR] status indicator is displayed. The measured parameter flashes.

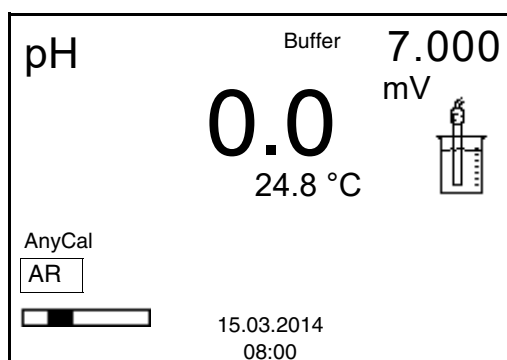

- 7 Wait for the end of the measurement with stability control or accept the calibration value with **<OK>**.

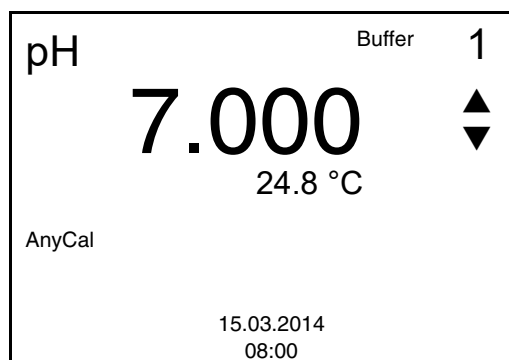

8	Set the nominal buffer value for the measured temperature with <b>&lt;▲ &gt;&lt;▼ &gt;</b> .
9	Accept the calibration value with <b>&lt;OK&gt;</b> . The calibration display for the next buffer appears (voltage display).
10	If necessary, finish the calibration procedure as a single-point calibration with <b>&lt;MODE&gt;</b> . The calibration record is displayed.

**Note**

For **single-point calibration**, the instrument uses the Nernst slope (-59.2 mV/pH at 25 °C) and determines the zero point of the electrode.

**Continuing with two-point calibration**

11	Thoroughly rinse the electrode with deionized water.
12	Immerse the electrode in buffer solution 2.
13	When measuring without temperature sensor: Measure the temperature of the buffer manually and enter it with <b>&lt;▲&gt;&lt;▼&gt;</b> .
14	Start the measurement with <b>&lt;OK&gt;</b> . The measured value is checked for stability (stability control). The [AR] status indicator is displayed. The measured parameter flashes.
15	Wait for the measurement with stability control to be completed or terminate the stability control and take over the calibration value with <b>&lt;OK&gt;</b> .

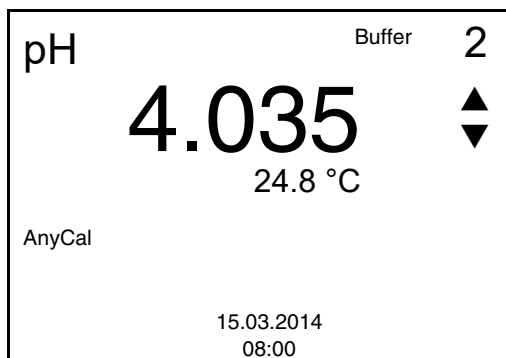

16	Set the nominal buffer value for the measured temperature with <b>&lt;▲ &gt;&lt;▼ &gt;</b> .
17	Accept the calibration value with <b>&lt;OK&gt;</b> . The calibration display for the next buffer appears (voltage display).
18	Finish the calibration procedure as a two-point calibration with <b>&lt;MODE&gt;</b> . The calibration record is displayed.
19	Thoroughly rinse the electrode with deionized water.
20	Immerse the electrode in the next buffer solution.
21	When measuring without temperature sensor: Measure the temperature of the buffer manually and enter it with <b>&lt;▲&gt;&lt;▼&gt;</b> .
22	Start the measurement with <b>&lt;OK&gt;</b> . The measured value is checked for stability (stability control). The [AR] status indicator is displayed. The measured parameter flashes.
23	Wait for the measurement with stability control to be completed or terminate the stability control and take over the calibration value with <b>&lt;OK&gt;</b> .

**Continuing with three-to five-point calibration**

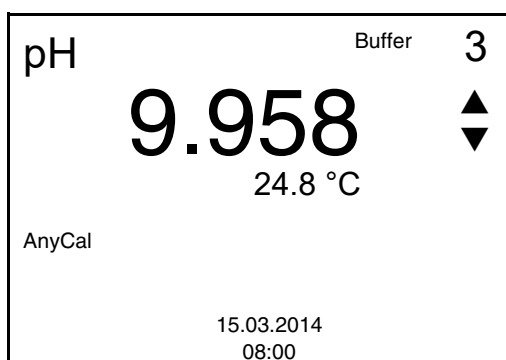

24	Set the nominal buffer value for the measured temperature with <b>&lt;▲ &gt;&lt;▼ &gt;</b> .
25	Accept the calibration value with <b>&lt;OK&gt;</b> . The calibration display for the next buffer appears (voltage display).
26	Use <b>&lt;MODE&gt;</b> to finish calibration or switch to calibration with the next buffer with <b>&lt;OK&gt;</b> .

**Note**

After the fifth buffer has been measured the calibration is automatically finished. Then the calibration record is displayed.

The calibration line is determined by linear regression.

### Displaying the calibration record

#### 5.4.9 Displaying calibration records

The calibration data can be displayed and then output to the interface

The calibration record of the last calibration is to be found under the menu item, *Calibration / Calibration record*. To open it in the measured value display, press the **<CAL\_\_>** key.

The calibration records of the last calibration procedures are available in the **<F1>/[Menu] / Calibration / Calibration data storage** and **<F1\_\_>/[Menu] / Storage & config/Data storage / Calibration data storage** menu.

Menu item	Setting/function	Explanation
<i>Calibration / Calibration data storage / Display</i> or <i>Data storage / Calibration data storage / Display</i>	-	Displays the calibration record.  Further options: <ul style="list-style-type: none"> <li>● Scroll through the calibration records with <b>&lt;▲&gt;&lt;▼&gt;</b>.</li> <li>● Output the displayed calibration record to the interface with <b>&lt;F2&gt;/[USB output]</b>.</li> <li>● Quit the display with <b>&lt;F1&gt;/[Back]</b> or <b>&lt;OK&gt;</b>.</li> <li>● Switch directly to the measured value display with <b>&lt;MODE&gt;</b>.</li> </ul>

Menu item	Setting/ function	Explanation
<i>Calibration / Calibration data stor- age / Output to USB or  Data storage / Calibration data stor- age / Output to USB</i>	-	Outputs the calibration records to the interface.

### Example

```

30.03.2014 15:55
pH 1100 L
Ser. no. 08502113

CALIBRATION pH

AutoCal TEC
Buffer 1          4.00
Buffer 2          7.00
Buffer 3          10.00
Voltage 1         184.0 mV
Voltage 2         3.0 mV
Voltage 3        -177.0 mV
Temperatur 1     24.0 øC
Temperatur 2     24.0 øC
Temperatur 3     24.0 øC
Slope            -60.2 mV/pH
Asymmetry        4.0 mV
Sensor           +++

etc...
```

## 5.5 Data memory

You can transmit measured values (datasets) to the data memory:

- Manual storage (see section 5.5.1)
- Automatic storage at intervals (see section 5.5.2)

Each data storage process transmits the current dataset to the interface at the same time.

### Measurement dataset

A complete dataset consists of:

- ID number
- Date/time
- Measured value of the connected sensor
- Measured temperature value of the connected sensor or manually set temperature

- AutoRead info: *AR* appears with the measured value if the Auto-Read criterion was met while storing (stable measured value). Otherwise, the *AR* display is missing.
- Calibration evaluation: +++, ++, +, -, or no evaluation

### Storage locations

The pH 1100 L meter has two measurement data memories. The measured values recorded either manually or automatic are stored separately in individual measurement data memories.

Data memory	Maximum number of datasets
<i>Manual data storage</i>	200
<i>Automatic data storage</i>	5000

#### 5.5.1 Manual storage

You can store a measurement dataset to the data memory as follows. The dataset is at the same time output to the interface:

- 1 Press the **<STR>** key shortly.  
The menu for manual data storage appears.

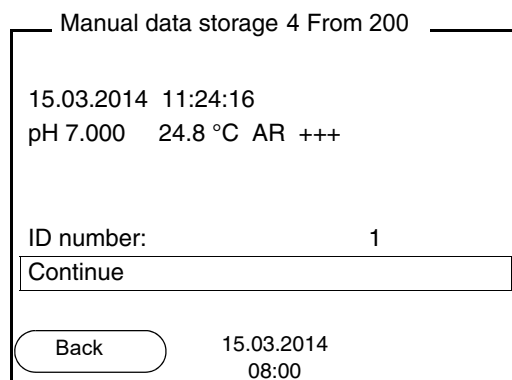

- 2 If necessary, change and confirm the ID number (1 ... 10000) with **<▲><▼>** and **<OK>**.  
The dataset is stored. The meter switches to the measured value display.

**If the memory is full**

The following window appears if all 200 storage locations are occupied:

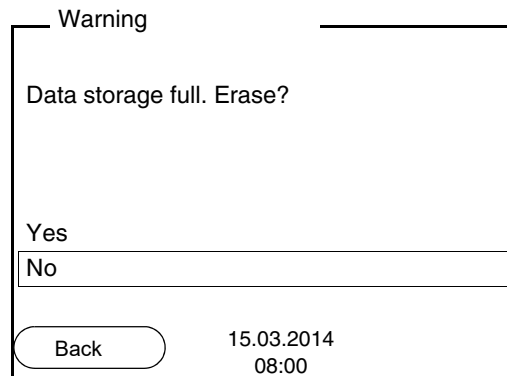

You have the following options:

- To erase the entire storage, confirm *Yes*.
- To cancel the storage process and switch to the measured value display, confirm *No*. Then you can e.g. store the data from the memory to a PC (see section 5.5.3) and subsequently erase the memory (see section 5.5.4).

**5.5.2 Automatic storage at intervals**

The storage interval (*Interval*) determines the time interval between automatic data storage processes. Each data storage process transmits the current dataset to the interface at the same time.

**Configuring the automatic storage function**

- 1 Press the **<STR\_\_>** key.  
The menu for automatic data storage appears.

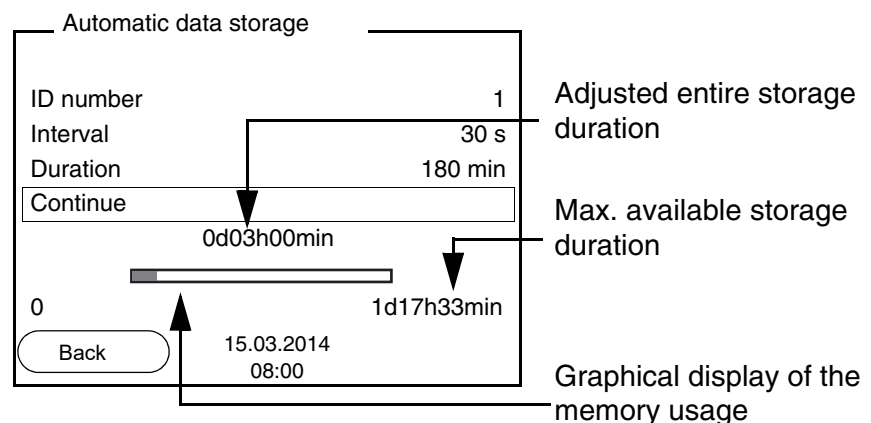

**Settings**

You can configure the automatic data storage function with the following settings:

Menu item	Possible setting	Explanation
ID number	1 ... 10000	ID number for the dataset series.
<i>Interval</i>	1 s, 5 s, 10 s, 30 s, 1 min, 5 min, 10 min, 15 min, 30 min, 60 min	Storage interval.  The lower limit of the storage interval can be restricted by the number of free storage locations. The upper limit is restricted by the storage duration.
<i>Duration</i>	1 min ... x min	Storing duration. Specifies after which time the automatic data storage should be terminated.  The lower limit of the storage duration is restricted by the storage interval. The upper limit is restricted by the number of free storage locations.

**Starting the automatic storage function**

To start the automatic storage function, select *Continue* with **<▲><▼>** and confirm with **<OK>**. The meter switches to the measured value display.

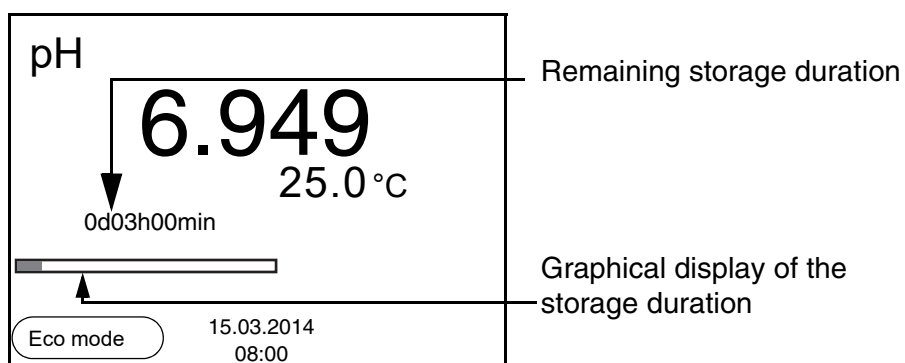

The active automatic data storage function can be recognized by the progress bar in the status line. The progress bar indicates the remaining storage duration.



**Note**

If the automatic storage function is activated, only the following keys are active: Softkeys, **<MODE>**, **<STR\_\_ >** and **<On/Off>**. The other keys and the automatic switch-off function are deactivated.

### Energy saving mode ([Eco mode])

If the automatic storing function is active, the meter provides an energy saving mode ([Eco mode]) to avoid unnecessary energy consumption. The energy saving mode switches off functions of the meter that are not required for the automatic storage of measurement data (such as the display). By pressing any key the energy saving mode is switched off again.

### Terminating the automatic storage function prematurely

Proceed as follows to switch off the automatic data storage function before the adjusted storage duration has expired:

- 1 Press the **<STR\_\_ >** key.  
The following window appears.

The image shows a rectangular warning dialog box with a thin black border. At the top left, the word "Warning" is displayed. The main text in the center asks "Stop automatic storage?". Below this text are two options: "Yes" and "No". The "No" option is currently selected, indicated by a vertical bar to its left. At the bottom left of the dialog is a rounded rectangular button labeled "Back". At the bottom right, the date and time "15.03.2014 08:00" are displayed.

- 2 Using **<▲><▼>**, select Yes and confirm with **<OK>**.  
The meter switches to the measured value display.  
The automatic data storage function is terminated.

### 5.5.3 Editing the measurement data memory

The contents of the manual or automatic measurement data memory can be shown on the display.

Each of the measurement data memories has a function to erase the entire contents.

The contents of the manual or automatic measurement data memory can be shown on the display and output to the interface.

Each of the measurement data memories has a function to erase the entire contents.

### Editing the data memory

The memory is edited in the menu, *Storage & config/ Data storage*. To open the *Storage & config* menu, press the **<F1\_\_>/[Menu]** key in the measured value display.

Open the manual or automatic storage directly with the **<RCL>** or **<RCL\_\_>** key.



**Note**

The settings are explained here using the manual data memory as an example. The same settings and functions are available for the automatic data memory.

**Settings**

Menu item	Setting/ function	Explanation
<i>Data storage / Manual data storage / Display</i>	-	Displays all measurement datasets page by page.  Further options: <ul style="list-style-type: none"> <li>● Scroll through the datasets with <b>&lt;▲&gt;&lt;▼&gt;</b>.</li> <li>● Output the displayed dataset to the interface with <b>&lt;F2&gt;/[USB output]</b>.</li> <li>● Quit the display with <b>&lt;F1&gt;/[Back]</b>.</li> </ul>
<i>Data storage / Manual data storage / Erase</i>	-	Erases the entire manual measurement data memory.  Note: All calibration data remain stored when this action is performed.
<i>Data storage / Manual data storage / Output to USB</i>	-	Outputs all stored measurement data to the interface.

**Display presentation of a dataset**

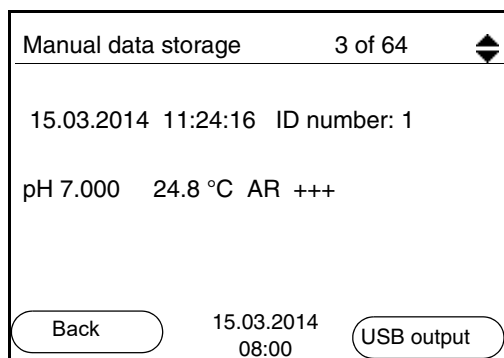

**Example**

```
30.03.2014 09:56:20
pH 1100 L
Ser. no. 08502113

ID number 2
pH 6.012 24.8 °C, AR, +++
-----

30.03.2014 10:56:20
pH 1100 L
Ser. no. 08502113

ID number 2
pH 6.012 24.8 °C, AR, +++
-----
```

**Quitting the display**

To quit the display of stored measurement datasets, you have the following options:

- Switch directly to the measured value display with **<MODE>**.
- Quit the display and move to the next higher menu level with **<F1>/[Back]**.

**5.5.4 Erasing the measurement data memory**

How to erase the measurement data memory is described in section 5.5.3 EDITING THE MEASUREMENT DATA MEMORY.

## 5.6 Transmitting data (USB interface)

### 5.6.1 Options for data transmission

Via the USB interface you can transmit data to a PC. The following table shows which data are transmitted to the interface in which way:

Data	Control	Operation / description
Current measured values of all connected sensors	Manual	<ul style="list-style-type: none"> <li>● With <b>&lt;F2&gt;/[USB output]</b>.</li> <li>● Simultaneously with every manual storage process (see section 5.5.1).</li> </ul>
	Automatic, at intervals	<ul style="list-style-type: none"> <li>● With <b>&lt;F2__&gt;/[USB output]</b>. Then you can set the transmission interval.</li> </ul> <p><b>Note:</b> For operation with MultiLab pilot: set the <i>Send ID</i> option to <i>No</i> (see section 5.7).</p> <ul style="list-style-type: none"> <li>● Simultaneously with every automatic storage process (see section 5.5.2).</li> </ul>
Stored measured values	Manual	<ul style="list-style-type: none"> <li>● Displayed dataset with <b>&lt;F2&gt;/[USB output]</b> after calling up from the memory.</li> <li>● All datasets with the <i>Output to USB</i> function.</li> </ul> <p>For details, see section 5.5.3.</p>
Calibration records	Manual	<ul style="list-style-type: none"> <li>● Calibration record with <b>&lt;F2&gt;/[USB output]</b>.</li> </ul> <p>For details, see section 5.6.</p>
	Automatic	<ul style="list-style-type: none"> <li>● At the end of a calibration procedure.</li> </ul>



#### Note

The following rule applies: With the exception of the menus, shortly pressing the **<F2>/[USB output]** key generally outputs the display contents to the interface (displayed measured values, measurement datasets, calibration records).

### 5.6.2 Connecting a PC

Connect the pH 1100 L to the PC via the USB interface.



#### Attention

**The USB interface is not galvanically isolated.**

**When a grounded PC is connected, measurements cannot be performed in grounded media as incorrect values would result.**

#### Installation of the USB driver on the PC

System requirements of the PC for installation of the USB driver:

- PC with USB port and CD-ROM drive
- Microsoft Windows  
(for details, see enclosed installation CD, Driver directory)

1	Insert the supplied installation CD in the CD drive of your PC.
2	Install the driver from the CD. Follow the Windows installation instructions as necessary.
3	Connect the pH 1100 L to the PC via the USB interface. The meter is listed as a virtual COM interface among the connections in the Windows instrument manager.

### 5.7 MultiLab Importer

With the aid of the MultiLab Importer software, you can record and evaluate measurement data with a PC.



More detailed information can be found in the MultiLab Importer operating manual.

## 5.8 Reset

You can reset (initialize) all sensor settings and sensor-independent settings separately from each other.

### 5.8.1 Resetting the measurement settings



#### Note

The calibration data are reset to the default settings together with the measuring parameters. Recalibrate after performing a reset.

**pH**

The following settings for pH measurements are reset to the default settings with the *Reset* function:

Setting	Default settings
<i>Buffer</i>	TEC
<i>Cal. interval</i>	7 d
<i>Unit for slope</i>	mV/pH
Measured parameter	pH
Resolution pH	0.001
Resolution mV	0.1
Asymmetry	0 mV
Slope	-59.2 mV
<i>Man. temperature</i>	25 °C
<i>One point calibration</i>	<i>Off</i>
Stability control	On
Temperature unit	°C

The sensor settings are reset under the *Reset* menu item in the menu for calibration and measurement settings. To open the settings, display the required parameter in the measured value display and press the **<F1>**/[Menu] or **<OK>** key.

### 5.8.2 Resetting the system settings

The following system settings can be reset to the default status:

<b>Setting</b>	<b>Default settings</b>
<i>Language</i>	English
<i>Beep</i>	On
<i>Baud rate</i>	4800 Baud
<i>Output format</i>	ASCII
<i>Contrast</i>	50 %
<i>Illumination</i>	Auto
<i>Switchoff time</i>	1 h

The system settings are reset in the menu, *Storage & config / System / Reset*. To open the *Storage & config* menu, press the **<F1 \_\_>/[Menu]** key in the measured value display.

## 6 Maintenance, cleaning, disposal, accessories

### 6.1 Maintenance

The only maintenance activity required is replacing the batteries.



#### Note

See the relevant operating manuals of the electrodes for instructions on maintenance.

#### 6.1.1 Replacing the batteries

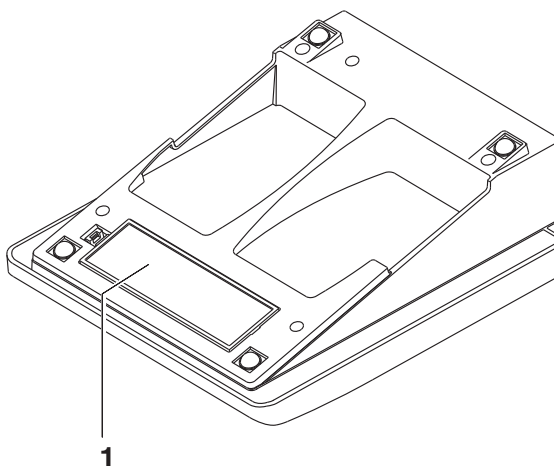

1	Open the battery compartment (1) on the underside of the meter.
---	---

2	Remove the batteries from the battery compartment.
---	--



#### Caution

**Make sure that the poles of the batteries are positioned correctly. The  $\pm$  signs on the batteries must correspond to the  $\pm$  signs in the battery compartment.**



#### Note

Alternatively, you can also use Ni-MH rechargeable batteries (type Mignon AA). In order to charge the batteries, an external charging device is required.

3	Place four batteries (type Mignon AA) in the battery compartment.
4	Close the battery compartment.

## 6.2 Cleaning

Occasionally wipe the outside of the measuring instrument with a damp, lint-free cloth. Disinfect the housing with isopropanol as required.



### Caution

**The housing is made of synthetic material (ABS). Thus, avoid contact with acetone or similar detergents that contain solvents. Remove any splashes immediately.**

## 6.3 Packing

This meter is sent out in a protective transport packing. We recommend: Keep the packing material. The original packing protects the meter against damage during transport.

## 6.4 Disposal



This equipment is marked with the crossed out wheeled bin symbol to indicate that this equipment must not be disposed of with unsorted waste.

Instead it's your responsibility to correctly dispose of your equipment at lifecycle -end by handling it over to an authorized facility for separate collection and recycling. It's also your responsibility to decontaminate the equipment in case of biological, chemical and/or radiological contamination, so as to protect from health hazards the persons involved in the disposal and recycling of the equipment.

For more information about where you can drop off your waste of equipment, please contact your local dealer from whom you originally purchased this equipment.

By doing so, you will help to conserve natural and environmental resources and you will ensure that your equipment is recycled in a manner that protects human health.

Thank you

## 6.5 Accessories

### 6.5.1 General information

Accessories	Order no. (Catalogue No.)	
	EU	NA
Storage tube	662-1167	89236-592
COMMUNICATION KIT (CD-ROM, USB cable, Manual)	662-1225	76470-840
Articulated stand for 4 electrodes and temperature sensor	662-1169	-
Storage vessel	662-1248	-

### 6.5.2 pH / ORP

Electrodes (pH)	Order no. (Catalogue No.)	
	EU	NA
pHenomenal 110 PH ELECTRODE PHENOMENAL GEL EPOXY BNC	662-1156	76460-452
pHenomenal 111 PH ELECTRODE PHENOMENAL 3IN1 GEL 1M BNC	662-1157	76460-454
pHenomenal 111-3 PH ELECTRODE PHENOMENAL 3IN1 GEL 3M BNC	662-1158	-
pHenomenal 220 PH ELECTRODE PHENOMENAL REFILL GLASS BNC	662-1159	76460-456
pHenomenal 221 PH ELECTRODE PHENOMENAL 3IN1 GLASS 1M	662-1161	76460-458
pHenomenal 221-3 PH ELECTRODE PHENOMENAL 3IN1 GLASS 3M	662-1162	-

<b>Electrodes (pH)</b>	<b>Order no. (Catalogue No.)</b>	
	<b>EU</b>	<b>NA</b>
pHenomenal MIC 220 PH ELECTRODE PHENOMENAL MICRO REFILL BNC	662-1163	-
pHenomenal SPEAR 220 PH ELECTRODE PHENOMENAL COMB. SPEAR TYPE	662-1164	-
pHenomenal LS 221 PH ELEKTRODE PHENOMENAL 3IN1 GLAS 1M	662-1247	76460-462
GENERAL PH EKTRODE GEL EPOXY BNC SJ113	662-1382	76460-468
GENERAL PH ELEKTRODE GEL EPOXY BNC DJ113	662-1385	76460-470
SURFACE PH ELEKTRODE GEL EPOXY BNC SF113	662-1388	76460-472
SEMI MICRO PH ELEKTRODE GEL GLASS SM123	662-1391	76460-474
GENERAL PH ELEKTRODE KCL GLASS BNC SJ223	662-1395	76460-476
SURFACE PH ELEKTRODE KCL GLASS BNC SF223	662-1398	76460-478
SEMI MICRO PH ELEKTRODE KCL GLASS SM223	662-1402	76460-480
SPEAR PH ELEKTRODE KCL GLASS BNC SP223	662-1405	76460-482
<b>Electrodes (ORP)</b>	<b>EU</b>	<b>NA</b>
pHenomenal ORP 220 REDOX ELECTRODE PHENOMENAL KOMB. 1M BNC	662-1165	76460-460
REDOX ELEKTRODE GEL EPOXY BNC RD113	662-1408	76460-484
REDOX ELEKTRODE GEL GLASS BNC RD223	662-1409	76460-486

<b>Solutions</b>	<b>EU</b>	<b>NA</b>
Buffer pH 4 AVS TITRINORM, 100 ml	32095.184	-
Buffer pH 7 AVS TITRINORM, 100 ml	32096.187	-
Buffer pH 10 AVS TITRINORM, 100 ml	32040.185	-
Buffer NIST pH 4.01, 30 x 30 ml	1.99001.0001	-
Buffer NIST pH 7, 30 x 30 ml	1.99002.0001	-
Buffer NIST pH 10, 30 x 30 ml	1.99004.0001	-
Buffer pH 1.68, 500 mL	-	BDH5006-500ML
Buffer pH 4, 500 mL	-	BDH5024-500ML
Buffer pH 7, 500 mL	-	BDH5052-500ML
Buffer pH 10, 500 mL	-	BDH5078-500ML
Buffer pH 12.45, 500 mL	-	BDH5096-500ML
Buffer NIST pH 4.006, 500 mL	-	BDH5018-500ML
Buffer NIST pH 6.865, 500 mL	-	BDH5040-500ML
Buffer NIST pH 9.18, 500 mL	-	BDH5066-500ML
Buffer NIST pH 10.012, 500 mL	-	BDH5072-500ML
Storage Solution (3 moles/l KCl), 100 ml	83605.180	BDH7296-0
Cleaning Solution Pepsine/Hydrochloric acid, 100 ml	83603.180	89207-612

## 7 What to do if...

### Error message *OFL, UFL*

Cause	Remedy
pH electrode:	
– Measured value outside the measuring range	– Use suitable electrode
– Air bubble in front of the junction	– Remove air bubble
– Air in the junction	– Extract air or moisten junction
– Cable broken	– Replace the electrode
– Gel electrolyte dried out	– Replace the electrode

### Error message, *Error*

Cause	Remedy
pH electrode:	
– The values determined for zero point and slope of the electrode are outside the allowed limits.	– Recalibrate
– Junction contaminated	– Clean the junction
– Electrode broken	– Replace the electrode
Buffer solutions:	
– Incorrect buffer solutions	– Change calibration procedure
– Buffer solutions too old	– Use only once. Note the shelf life
– Buffer solutions depleted	– Change solutions

**No stable measured value**

<b>Cause</b>	<b>Remedy</b>
pH electrode:	
– Junction contaminated	– Clean the junction
– Membrane contaminated	– Clean membrane
Test sample:	
– pH value not stable	– Measure with air excluded if necessary
– Temperature not stable	– Adjust temperature if necessary
Electrode + test sample:	
– Conductivity too low	– Use suitable electrode
– Temperature too high	– Use suitable electrode
– Organic liquids	– Use suitable electrode

**Sensor symbol flashes**

<b>Cause</b>	<b>Remedy</b>
– Calibration interval expired	– Recalibrate the measuring system

**Display**

<b>Cause</b>	<b>Remedy</b>
– Batteries almost empty	– Replace the batteries (see section 6.1 MAINTENANCE)

**Obviously incorrect measured values**

Cause	Remedy
pH electrode:	
– pH electrode unsuitable	– Use suitable electrode
– Temperature difference between buffer and test sample too great	– Adjust temperature of buffer or sample solutions
– Measurement procedure not suitable	– Follow special procedure

**Meter does not react to keystroke**

Cause	Remedy
– Operating condition undefined or EMC load unallowed	– Processor reset: Press the <b>&lt;OK&gt;</b> and <b>&lt;On/Off&gt;</b> key simultaneously

**You want to know which software version is in the meter**

Cause	Remedy
– E.g., a question by the service department	– Switch on the meter. Open the menu, <b>&lt;F1__&gt;</b> / [Menu] / <i>Storage &amp; config / SystemService information</i> . The instrument data are displayed.

## 8 Firmware update

### General information

Available firmware updates are provided on the Internet. With the "Firmware Update " program and a PC you can update the firmware of the pH 1100 L to the newest version.

For the update you have to connect the meter to a PC.

For the update via the USB interface, the following is required:

- a free USB interface (virtual COM port) on the PC
- the driver for the USB interface (on the enclosed CD-ROM)
- the USB cable (included in the scope of delivery of the pH 1100 L).

### Program installation

- |   |  |
|---|--|
| 1 | Install the downloaded firmware update on a PC.<br><br>An update folder is created in the Windows start menu. If an update folder already exists for the meter (or meter type), the new data is displayed there. |
|---|--|

### Program start

- |   |  |
|---|--|
| 2 | In the windows start menu, open the update folder and start the firmware update program. |
|---|--|

### Firmware update

- |   |  |
|---|--|
| 3 | Using the USB interface cable, connect the pH 1100 L to a USB interface (virtual COM port) of the PC.  |
| 4 | Switch on the pH 1100 L.   |
| 5 | In the firmware update program, start the update process with OK.  |
| 6 | Follow the instructions of the firmware update program. During the programming process, a corresponding message and a progress bar (in %) are displayed. The programming process takes approx. three minutes. A terminatory message is displayed after a successful programming process. The firmware update is completed. |
| 7 | Disconnect the pH 1100 L from the PC. The pH 1100 L is ready for operation again.  |

After switching the meter off and on you can check whether the meter has taken over the new software version (see page 63).

## 9 Lists

This chapter provides additional information and orientation aids.

**Specialist terms** The glossary briefly explains the meaning of the specialist terms. However, terms that should already be familiar to the target group are not described here.

**Index** The index will help you to find the topics that you are looking for.

### Glossary

**Adjusting** To manipulate a measuring system so that the relevant value (e.g. the displayed value) differs as little as possible from the correct value or a value that is regarded as correct, or that the difference remains within the tolerance.

**Asymmetry** see zero point

**AutoRange** Name of the automatic selection of the measuring range.

**Calibration** Comparing the value from a measuring system (e.g. the displayed value) to the correct value or a value that is regarded as correct. Often, this expression is also used when the measuring system is adjusted at the same time (see adjusting).

**Electromotive force of an electrode**

The electromotive force  $U$  of the combination electrode is the measurable electromotive force of an electrode in a solution. It equals the sum of all the galvanic voltages of the combination electrode. Its dependency on the pH results in the electrode function, which is characterized by the parameters, slope and zero point.

**Junction**

The junction is a porous body in the housing wall of reference electrodes or electrolyte bridges. It arranges the electrical contact between two solutions and makes the electrolyte exchange more difficult. The expression, junction, is also used for ground or junctionless transitions.

**Measured parameter**

The measured parameter is the physical dimension determined by measuring, e.g. pH, conductivity or D.O. concentration.

**Measured value**

The measured value is the special value of a measured parameter to be determined. It is given as a combination of the numerical value and unit (e. g. 3 m; 0.5 s; 5.2 A; 373.15 K).

---

<b>ORP</b>	The ORP is caused by oxidizing or reducing substances dissolved in water if these substances become effective on an electrode surface (e.g. a gold or platinum surface).
<b>pH value</b>	The pH value is a measure of the acidic or basic effect of an aqueous solution. It corresponds to the negative decadic logarithm of the molal hydrogen ions activity divided by the unit of the molality. The practical pH value is the value of a pH measurement.
<b>Potentiometry</b>	Name of a measuring technique. The signal (depending on the measured parameter) of the electrode is the electrical potential. The electrical current remains constant.
<b>Reset</b>	Restoring the original condition of all settings of a measuring system.
<b>Resolution</b>	Smallest difference between two measured values that can be displayed by a meter.
<b>Slope</b>	The slope of a linear calibration function.
<b>Stability control (AutoRead)</b>	Function to control the measured value stability.
<b>Standard solution</b>	The standard solution is a solution where the measured value is known by definition. It is used to calibrate a measuring system.
<b>Test sample</b>	Designation of the test sample ready to be measured. Normally, a test sample is made by processing the original sample. The test sample and original sample are identical if the test sample was not processed.
<b>Zero point</b>	The zero point of a pH combination electrode is the pH value at which the electromotive force of the pH combination electrode at a specified temperature is zero. Normally, this is at 25 °C.

## Index

**A**

- Authorized use ..... 6
- Automatic switch-off function ..... 18
- AutoRead
  - pH ..... 29, 30, 31

**B**

- Battery compartment ..... 16, 56

**C**

- Calibration
  - pH ..... 33
- Calibration evaluation
  - pH ..... 36
- Calibration interval ..... 37
- Calibration points
  - pH ..... 35
- Calibration records ..... 44
- Connect the power pack ..... 16
- Connecting a PC ..... 53
- Connectors ..... 11

**D**

- Dataset ..... 45
- Date and time ..... 24
- Default settings
  - Measured parameter ..... 54
  - System settings ..... 55
- Display ..... 10

**E**

- Energy saving feature ..... 17
- Energy saving mode ..... 49

**F**

- Firmware update ..... 64

**I**

- Initial commissioning ..... 15, 16
- Initialize ..... 54
- Interval for calibration ..... 37

**K**

- Keys ..... 9

**M**

- Measured value display ..... 20
- Measurement accuracy ..... 37
- Measurement data memory
  - Edit ..... 49
  - Erase ..... 49
  - Storage locations ..... 46
- Measurement dataset ..... 45
- Measuring
  - ORP ..... 30
  - pH ..... 29
- Menu for calibration and measurement settings
  - pH/ORP ..... 31
- Menus (navigation) ..... 20
- Messages ..... 21

**O**

- Operational safety ..... 6

**P**

- pH buffer sets ..... 33
- Precautions ..... 5
- Print ..... 52

**R**

- Reset ..... 54

**S**

- Safety ..... 5
- Scope of delivery ..... 15
- Setting the date ..... 17
- Setting the time ..... 17
- Single-point calibration
  - pH ..... 39, 42
- Slope
  - pH ..... 33
- Stability control
  - Automatic ..... 27
- Storage interval ..... 47
- Storing in memory ..... 45
  - Automatic ..... 47

Manual ..... 46

## **T**

Temperature measurement

pH ..... 28

Three-point calibration

pH ..... 39, 43

Transmitting data ..... 52

Transmitting measured values ..... 52

Two-point calibration

pH ..... 39, 42

## **Z**

Zero point of pH electrode ..... 33

## 10 Technical service

### Web resources

Visit the VWR website at [www.vwr.com](http://www.vwr.com) for:

- Complete technical service contact information
- Access to VWR's Online Catalogue, and information about accessories and related products
- Additional product information and special offers

### Contact us:

For information or technical assistance contact your local VWR representative or visit [www.vwr.com](http://www.vwr.com).

## 11 Warranty

**VWR** warrants that this product will be free from defects in material and workmanship for a period of three (3) years from date of delivery. If a defect is present, VWR will, at its option and cost, repair, replace, or refund the purchase price of this product to the customer, provided it is returned during the warranty period. This warranty does not apply if the product has been damaged by accident, abuse, misuse, or misapplication, or from ordinary wear and tear. If the required maintenance and inspection services are not performed according to the manuals and any local regulations, such warranty turns invalid, except to the extent, the defect of the product is not due to such non performance.

Items being returned must be insured by the customer against possible damage or loss. This warranty shall be limited to the aforementioned remedies. IT IS EXPRESSLY AGREED THAT THIS WARRANTY WILL BE IN LIEU OF ALL WARRANTIES OF FITNESS AND IN LIEU OF THE WARRANTY OF MERCHANTABILITY.

## 12 Compliance with local laws and regulations

The customer is responsible for applying for and obtaining the necessary regulatory approvals or other authorizations necessary to run or use the product in its local environment. VWR will not be held liable for any related omission or for not obtaining the required approval or authorization, unless any refusal is due to a defect of the product.





## Local VWR offices in Europe and Asia Pacific

### Austria

VWR International GmbH  
Graumannsgasse 7  
1150 Vienna  
Tel.: +43 01 97 002 0  
info.at@vwr.com

### Belgium

VWR International BV  
Researchpark Haasrode 2020  
Geldenaaksebaan 464  
3001 Leuven  
Tel.: +32 016 385 011  
vwr.be@vwr.com

### Canada

VWR International  
2360 Argentia Road  
Mississauga, Ontario L5N 5Z7  
Tel.: +1 800 932 5000  
Canada\_Orders@vwr.com

### China

VWR (Shanghai) Co., Ltd  
Bld.No.1, No.3728 Jinke Rd,  
Pudong New District  
Shanghai 200123- China  
Tel.: +400 821 8006  
info\_china@vwr.com

### Czech Republic

VWR International s. r. o.  
Veetee Business Park  
Pražská 442  
CZ - 281 67 Strábrná Skalice  
Tel.: +420 321 570 321  
info.cz@vwr.com

### Denmark

VWR International A/S  
Tobaksvejen 21  
2860 Søborg  
Tel.: +45 43 86 87 88  
info.dk@vwr.com

### Finland

VWR International Oy  
Valimotie 9  
00380 Helsinki  
Tel.: +358 09 80 45 51  
info.fi@vwr.com

### France

VWR International S.A.S.  
Le Périgares – Bâtiment B  
201, rue Carnot  
94126 Fontenay-sous-Bois cedex  
Tel.: 0 825 02 30 30\* (national)  
Tel.: +33 (0) 1 45 14 85 00 (international)  
info.fr@vwr.com  
\* 0,18 € TTC/ min + prix appel

### Germany

VWR International GmbH  
Hilpertstraße 20a  
D - 64295 Darmstadt  
Tel.: 0800 702 00 07\* (national)  
Tel.: +49 (0) 6151 3972 0 (international)  
info.de@vwr.com  
\*Freecall

### Hungary

VWR International Kft.  
Simon László u. 4.  
4034 Debrecen  
Tel.: +36 (52) 521-130  
info.hu@vwr.com

### India

Avantor Performance Materials India Limited  
17th Floor, Building No. 5, Tower C  
DLF Cyber City Phase – III  
Gurgaon - 122002, Haryana  
Tel.: +91-1244-65-6700  
help@avantorinc.com

### Ireland

VWR International Ltd  
International (Northern Ireland) Ltd  
Northwest Business Park  
Ballycoolin  
Dublin 15  
Tel.: +353 01 88 22 222  
sales.ie@vwr.com

### Italy

VWR International S.r.l.  
Via San Giusto 85  
20153 Milano (MI)  
Tel.: +39 02-3320311  
info.it@vwr.com

### Korea

VWR International ~  
17, Daehak 4-ro, Yeongtong-gu,  
Suwon-si, Gyeonggi-do  
Tel.: +82 31 645 7256  
saleskorea@avantorsciences.com

### The Netherlands

VWR International B.V.  
Postbus 8198  
1005 AD Amsterdam  
Tel.: +31 020 4808 400  
info.nl@vwr.com

### Mexico

VWR International, S.de R.L. de C.V.  
Km. 14.5 Carretera  
Tlalnepantla-Cuautitlán  
Col. Lechería  
Tultitlán Edo. de México  
CP 54940  
Tel.: +52 (55) 5005 0100  
vwrmx@vwr.com

### Middle East & Africa

VWR International FZ-LLC  
DSP Laboratory Complex  
125, Floor 01  
Dubai, United Arab Emirates  
Tel.: +971 4 5573271  
info.mea@vwr.com

### Norway

VWR International AS  
Brynsalleen 4  
0667 Oslo  
Tel.: +47 22 90 00 00  
info.no@vwr.com

### Poland

VWR International Sp. z o.o.  
Limbowa 5  
80-175 Gdansk  
Tel.: +48 58 32 38 200  
info.pl@vwr.com

### Portugal

VWR International –  
Material de Laboratório, Lda  
Centro Empresarial de Alfragide  
Rua da Indústria, nº 6  
2610-088 Amadora  
Tel.: +351 21 3600 770  
info.pt@vwr.com

### Singapore

VWR Singapore Pte Ltd  
18 Gul Drive  
Singapore 629468  
Tel: +65 6505 0760  
sales.sg@vwr.com

### Spain

VWR International Eurolab S.L.U.  
C/ Tecnología 5-17  
A-7 Llinars Park  
08450 - Llinars del Vallès  
Barcelona  
Tel.: +34 902 222 897  
info.es@vwr.com

### Sweden

VWR International AB  
Fagerstagatan 18a  
163 94 Stockholm  
Tel.: +46 (0) 8 621 34 00  
kundservice.se@vwr.com

### Switzerland

VWR International GmbH  
Lerzenstrasse 16/18  
8953 Dietikon  
Tel.: +41 (0) 44 745 13 13  
info.ch@vwr.com

### UK

VWR International Ltd  
Customer Service Centre  
Hunter Boulevard - Magna Park  
Lutterworth  
Leicestershire  
LE17 4XN  
Tel.: +44 (0) 800 22 33 44  
uksales@vwr.com

### United States

VWR International, LLC  
100 Matsonford Road  
Building One Suite 200  
Radnor, PA 19087  
Tel.: +1 800 932 5000  
VWRCustomerService@vwr.com