

Project Overview

Description of Similarity:

equal – the same article

like – nearly equal but with some slight differences

maybe – only as an alternative

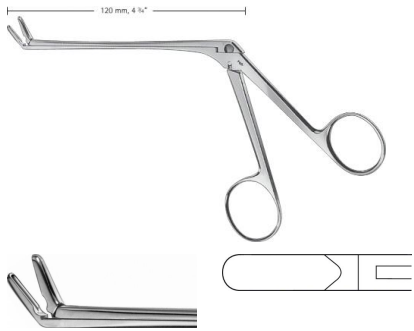
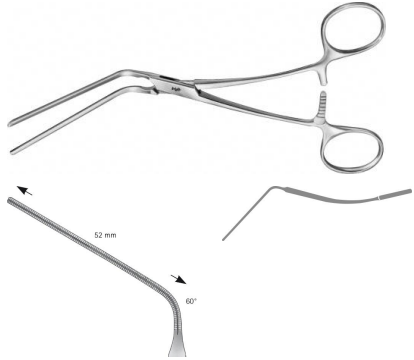
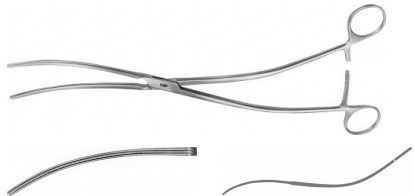
Pos No.	Item Code	Description / Comment	Qty.
10	OF288R	<p>(OF288R) ST. BARTS Ear Hook, 90 °, angled, 180 mm (7"), blunt, non-sterile, reusable</p>  <p>Customer Reference: 17</p>	2
20	OK526R	<p>(OK526R) TAKAHASHI Rongeur, 130 °, upwards cutting, 120 mm (4 3/4"), oval, width: 3 mm</p>  <p>Customer Reference: 23</p>	5
30	FB755R	<p>(FB755R) COOLEY ATRAUMATA® Patent-Ductus Clamp, angled, 60 °, 170 mm (6 3/4"), toothing COOLEY, jaw length: 52 mm</p>  <p>Customer Reference: 24</p>	2
40	FB475R	<p>(FB475R) DE BAKEY ATRAUMATA® Aorta Aneurysm Clamp, curved, 300 mm (11 3/4"), toothing DE BAKEY, jaw length: 120 mm</p>  <p>Customer Reference: 25</p>	2





Project Overview

Description of Similarity:

equal – the same article

like – nearly equal but with some slight differences

maybe – only as an alternative

Pos No.	Item Code	Description / Comment	Qty.
50	PL680R	<p>(PL680R) Fan Retractor, 400 mm, diam. 10 mm, 5 fingers, non-sterile, reusable</p>  <p>Customer Reference: 40</p>	6
60	FF294R	<p>(FF294R) PENFIELD Dissector, slightly curved, 205 mm (8"), blunt, round handle, Fig. 4, non-sterile, reusable</p>  <p>Customer Reference: 42</p>	15
70	BC250R	<p>(BC250R) MAYO DUROTIP® Dissecting Scissors, straight, TC: yes, heavy pattern, blunt/blunt, 140 mm (5 1/2")</p>  <p>Customer Reference: 62</p>	91
80	BC281WB	<p>(BC281WB) NELSON-METZENBAUM Noir® Dissecting Scissors, curved, TC: yes, wave cut, blunt/blunt, 285 mm (11 1/4")</p>  <p>Customer Reference: 64</p>	26





Project Overview

Description of Similarity:

equal – the same article

like – nearly equal but with some slight differences

maybe – only as an alternative

Pos No.	Item Code	Description / Comment	Qty.
90	OK560R	<p>(OK560R) Nasal Scissors, straight, working length: 130 mm (5 1/8"), serrated (one blade), vertical cutting, with tubular shaft, ring handle, single action, non-sterile, reusable</p>  <p>Customer Reference: 69</p>	4
100	BD853R	<p>(BD853R) Micro Forceps, straight, 240 mm (9 1/2"), insulated, non-sterile, reusable</p>  <p>Customer Reference: 96</p>	89
110	BD853R	<p>(BD853R) Micro Forceps, straight, 240 mm (9 1/2"), insulated, non-sterile, reusable</p>  <p>Customer Reference: 97</p>	31
120	PO196R	<p>(PO196R) BABCOCK ADTEC MONOPOLAR Organ Grasping Forceps, complete instrument, straight, working length: 370 mm (14 1/2"), diam. 10 mm, serrated, fenestrated, double action, consisting of PM977R, PO741R, PO959R, non-sterile, reusable</p>  <p>Customer Reference: 112</p>	8
130	PL408R	<p>(PL408R) ADTEC Needle Holder, TC: yes, complete instrument, curved to left, Ø 5 mm, working length: 310 mm (12 1/4")</p>  <p>Customer Reference: 162</p>	16



Project Overview

Description of Similarity:

equal – the same article

like – nearly equal but with some slight differences

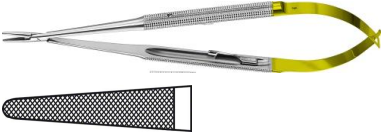
maybe – only as an alternative

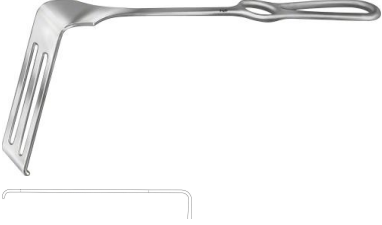
Pos No.	Item Code	Description / Comment	Qty.
140	PL407R	<p>(PL407R) ADTEC Needle Holder, TC: yes, complete instrument, straight, Ø 5 mm, working length: 310 mm (12 1/4")</p>  <p>Customer Reference: 163</p>	5
150	FM388R	<p>(FM388R) DUROGRIP® Micro Needle Holder, TC: yes, straight, 180 mm (7")</p>  <p>Customer Reference: 167</p>	10
160	FM390R	<p>(FM390R) DUROGRIP® Micro Needle Holder, TC: yes, straight, 200 mm (7 7/8")</p>  <p>Customer Reference: 168</p>	6
170	BT514R	<p>(BT514R) SAUERBRUCH Retractor, 260 mm (10 1/4"), open, fenestrated, depth: 130 mm, width: 38 mm, non-sterile, reusable</p>  <p>Customer Reference: 172</p>	2

Project Overview

Description of Similarity:

equal – the same article

like – nearly equal but with some slight differences

maybe – only as an alternative

Pos No.	Item Code	Description / Comment	Qty.
180	783100	(783100) Manipler® AZ 35 W	180



Customer Reference: 190

Scheren – Scissors

DUROTIP® Präparierscheren

DUROTIP® Dissecting Scissors

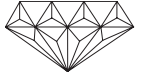

BC



MAYO

BC250R-BC253R



BC250R	BC252R
140 mm	170 mm
5 1/2"	6 3/4"



BC251R	BC253R
140 mm	170 mm
5 1/2"	6 3/4"



MAYO

BC242R-BC559R



BC242R	BC558R
170 mm	230 mm
6 3/4"	9"



BC243R	BC559R
170 mm	230 mm
6 3/4"	9"



Wundhaken – Wound Retractors

Nerv- und Gefäßhäkchen

Nerve- and Vessel Hooks

Maßangaben für Blattgrößen der Wundhaken

1. Zahl = Tiefe Beispiel: 25 x 38 mm

2. Zahl = Breite

Dimensions for blade size of retractors

1st number = depth Example: 25 x 38 mm

2nd number = width

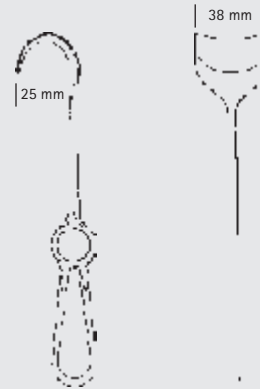

OF282R OF283R OF284R OF285R 1/1

WAGENER

OF282R-OF285R

150 mm, 6"

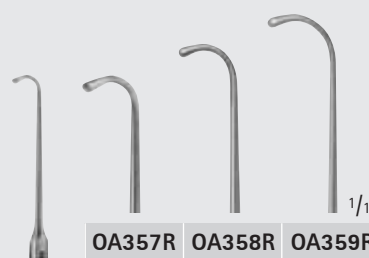

OA357R OA358R OA359R 1/1

GRAEFE

OA357R-OA359R

140 mm, 5 1/2"



1/1

ST. BARTS

OF288R

Ohrhäkchen, stumpf

Hook, blunt

180 mm, 7"



Elektrochirurgie – Electro Surgery
 Pinzetten, isoliert
 Forceps, Insulated

MONOPOLAR

AIRAUMATA®

GK



BD852R	BD853R	BD854R
200 mm	240 mm	300 mm
8"	9 1/2"	12"

Anatomische Pinzette
 Dissecting Forceps



BD855R	BD856R	BD857R
200 mm	240 mm	300 mm
8"	9 1/2"	12"

1 x 2 Zähne
 1 x 2 teeth



BD858R	BD859R	BD860R
200 mm	240 mm	300 mm
8"	9 1/2"	12"

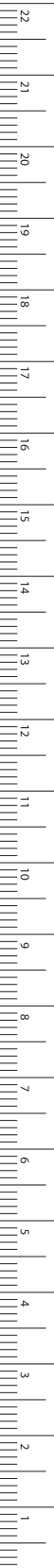

MILLIMETERS

Herz- und Gefäß-Chirurgie – Cardiovascular Surgery

DUROGRIP® Mikro-Nadelhalter

DUROGRIP® Micro Needle Holders

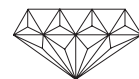

FB



CASTROVIEJO

BM004R

180 mm, 7"



CASTROVIEJO

BM005R

215 mm, 8 1/2"



FM388R

mit Sperre
with catch
180 mm, 7"



FM390R

mit Sperre
with catch
200 mm, 8"



DE BAKEY Zahnung



Toothing DE BAKEY

ARAUMATA®

Herz- und Gefäß-Chirurgie – Cardiovascular Surgery

Aorta-Aneurysma-Klemmen

Aorta-Aneurysm-Clamps

2:3 Zahnreihen
2:3 Teeth rows

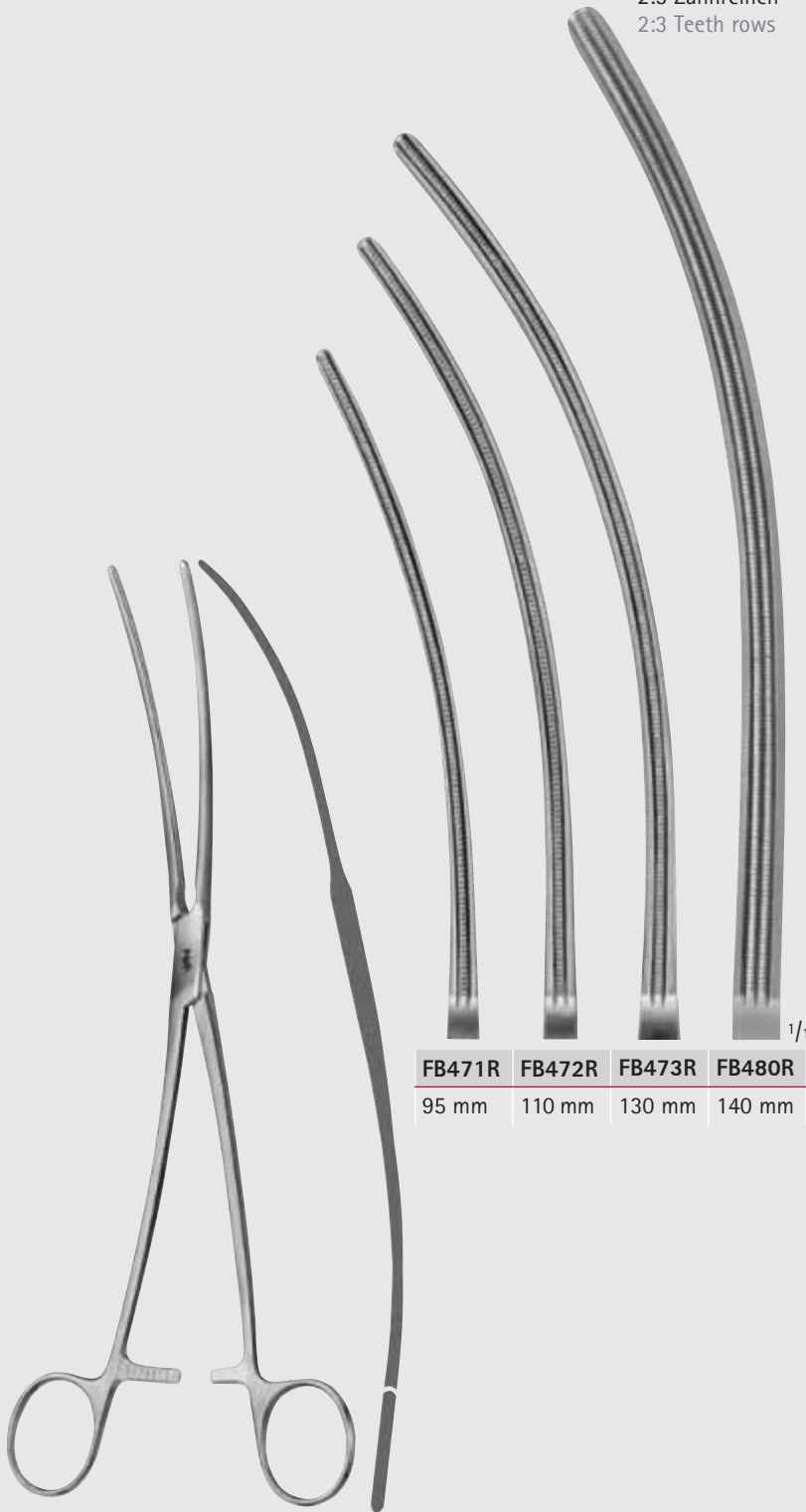

FB471R	FB472R	FB473R	FB480R
95 mm	110 mm	130 mm	140 mm

DE BAKEY

FB471R	250 mm	10"
FB472R	300 mm	12"
FB473R	315 mm	12 1/2"
FB480R	330 mm	13"

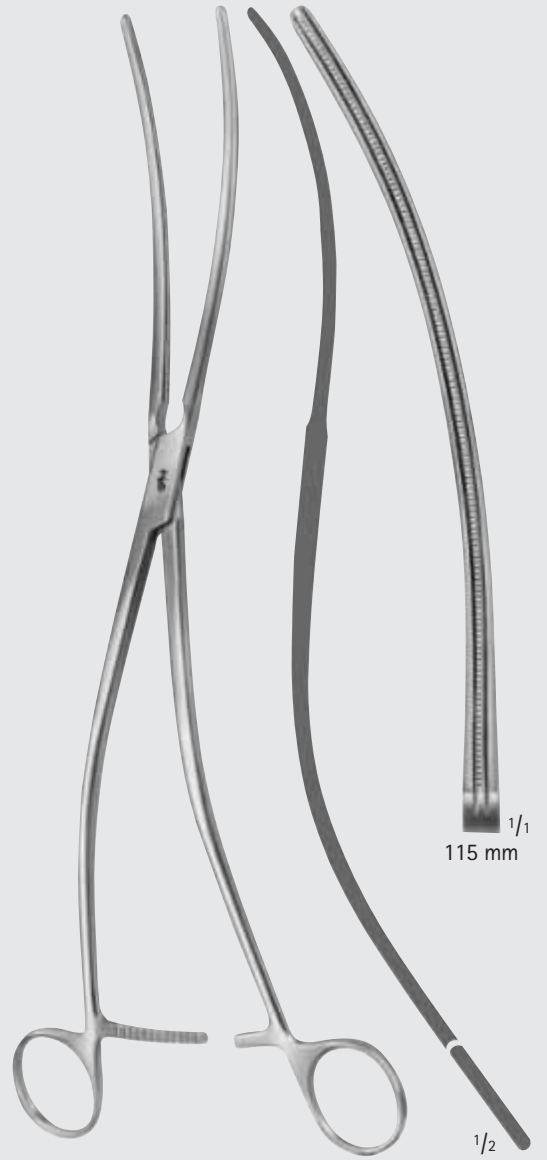

DE BAKEY

FB475R
300 mm, 12"

FB

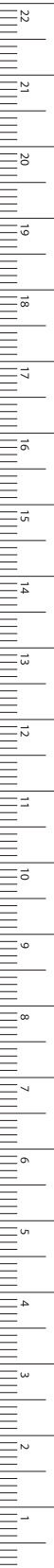

MILLIMETERS



COOLEY Zahnung

Toothing COOLEY

ARAUMATA®

Herz- und Gefäß-Chirurgie – Cardiovascular Surgery

Patent-Ductusklemmen, Coarctationsklemmen, Kinder-Modelle
Patent-Ductus Clamps, Coarctations Clamps, Pediatric Patterns

FB

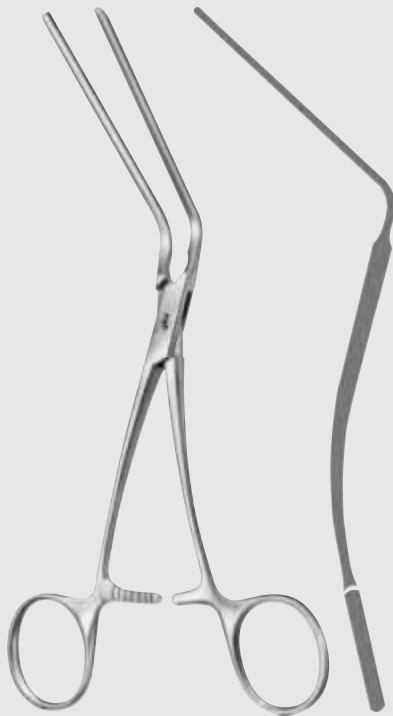
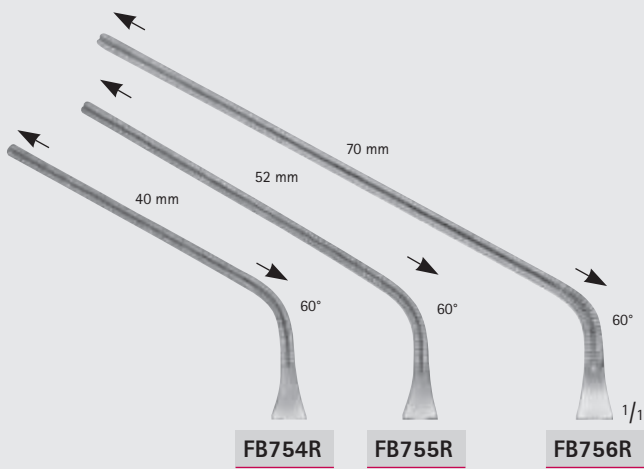

COOLEY

FB754R	165 mm	6 1/2"
FB755R	170 mm	6 3/4"
FB756R	185 mm	7 1/4"

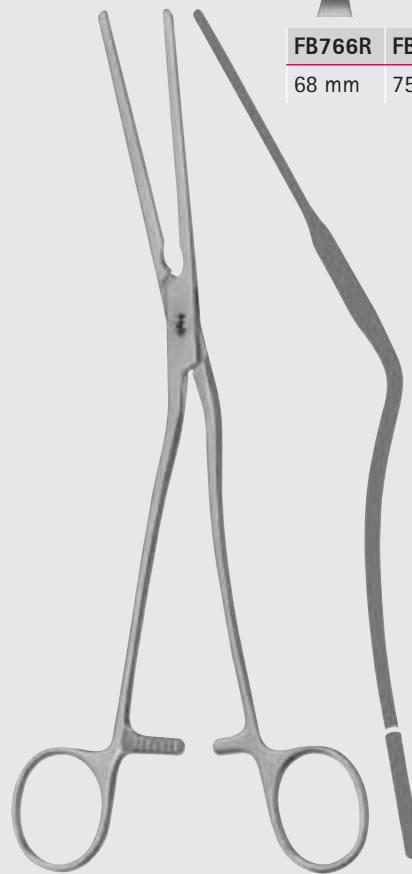
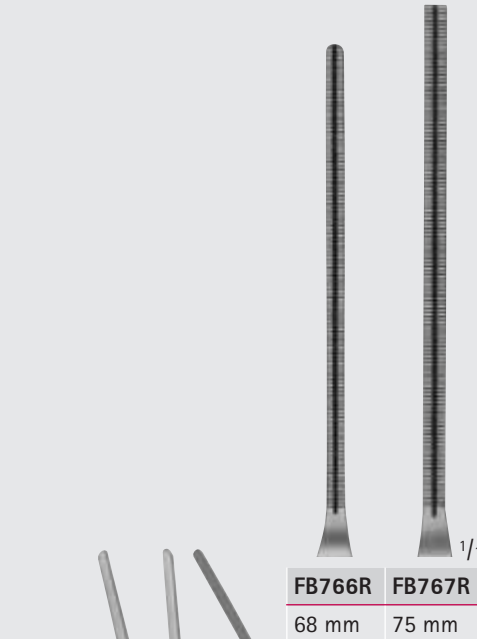

FB766R	225 mm	9"
FB767R	270 mm	10 3/4"

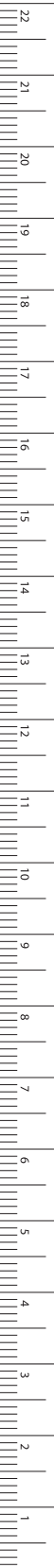

MILLIMETERS



Knochenstanzen, Rongeurs – Bone Punches, Rongeurs

Rongeurs
Rongeurs

FF

140°

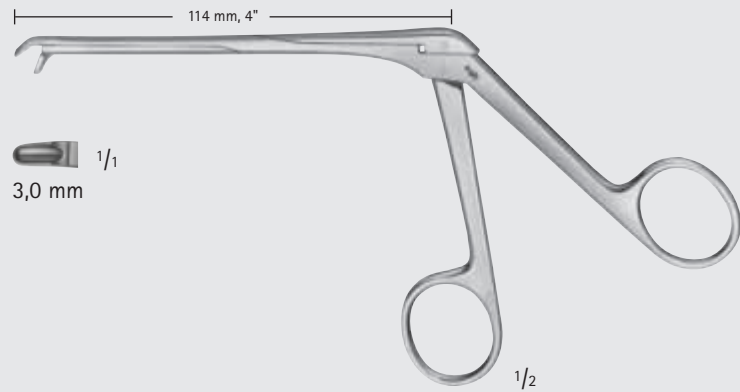

ST. BARTS

OK538R

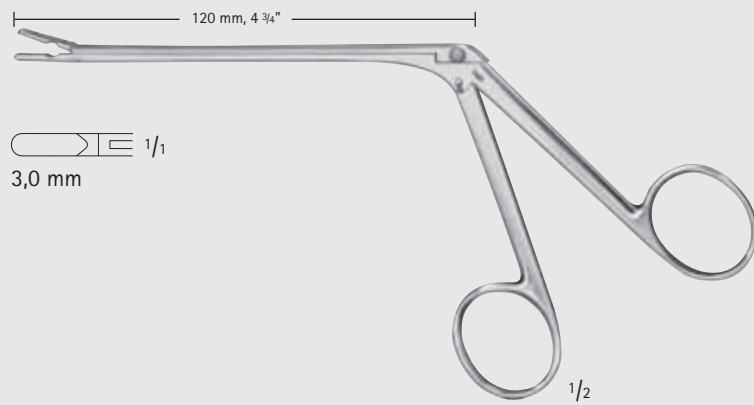

TAKAHASHI

OK525R

130°

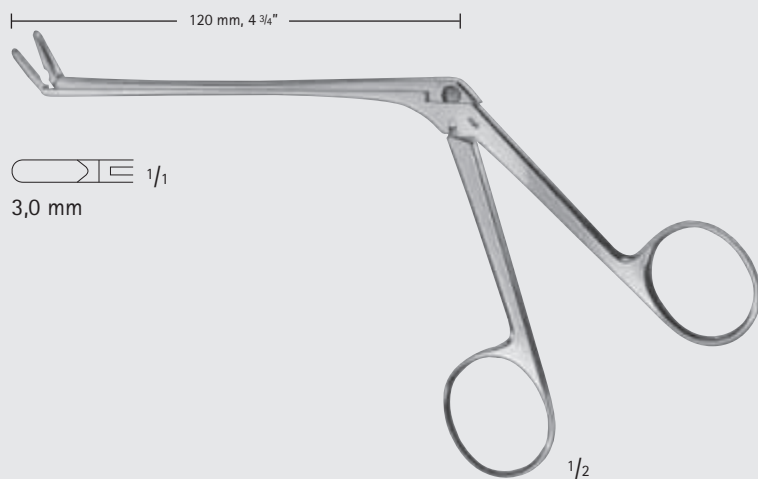

TAKAHASHI

OK526R



MILLIMETERS

Noir

SUPREME CUT SCISSORS

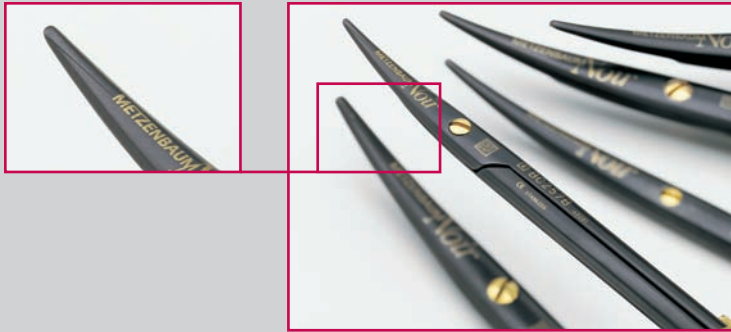

The particularly delicate shape permits smooth dissection even in very delicate tissue structures.

	Delicate			Delicate	Delicate
	1/1	1/1		1/1	1/1
BC273WB curved 7"		BC259WB curved 5-3/4"		BC267WB curved 9"	BC279WB curved 10-1/4"
				BC281WB curved 11"	
NOIR TOENNIS-ADSON Dissecting Scissors, with Wavecut		NOIR BABY-METZENBAUM Dissecting Scissors, with Wavecut		NOIR NELSON-METZENBAUM Dissecting Scissors, with Wavecut	

Knochenheber, Raspatorien, Scharfe Löffel – Bone Levers, Elevators, Bone Curettes

Dissektoren

Dissectors

FK

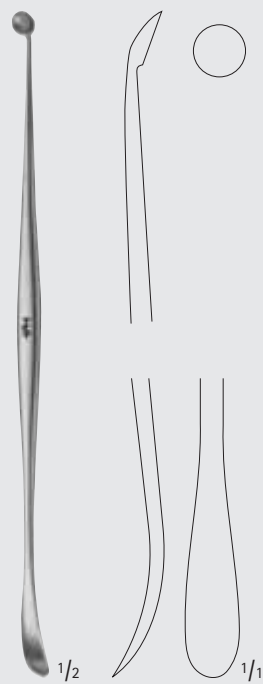

PENFIELD

FF291R

Fig. 1
doppelendig
double-ended
175 mm, 7"

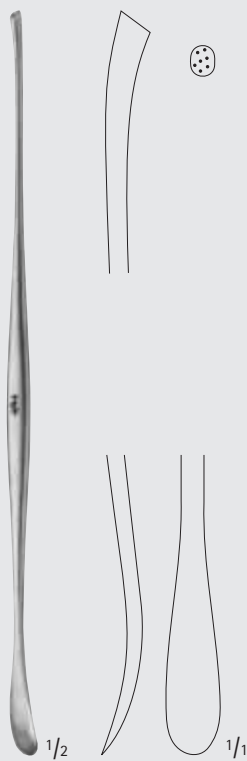

PENFIELD

FF292R

Fig. 2
doppelendig
double-ended
195 mm, 7 3/4"

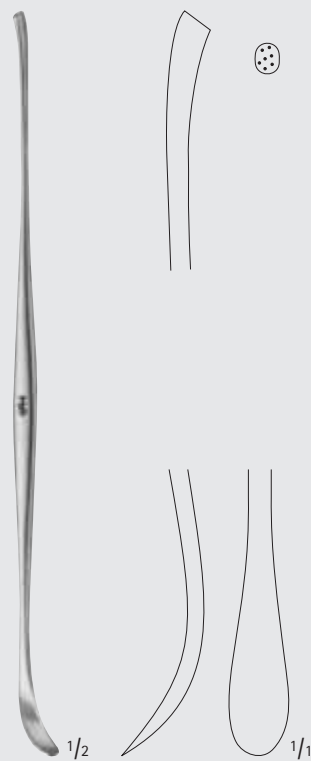

PENFIELD

FF293R

Fig. 3
doppelendig
double-ended
195 mm, 7 3/4"



PENFIELD

FF294R

Fig. 4
leicht gebogen
slightly curved
205 mm, 8"

FESS, Rhinology, Rhinoplasty – FESS, Rhinologie, Septum- und Nasenplastik

Nasal Scissors, Micro Scissors

Nasenscheren, Mikro-Schere



- The LUER-Lock flushing ports of tubular shaft instruments allow easy cleaning of the instruments as well as lubrication with a steam permeable oil (e.g. Aesculap Sterilit®).
- Die LUER-Lock Spülanschlüsse bei Rohrschaft Instrumenten ermöglichen eine einfache Reinigung der Instrumente, sowie die Pflege mit einem dampfdurchlässigen Öl (z.B. Aescuclap Sterilit®).

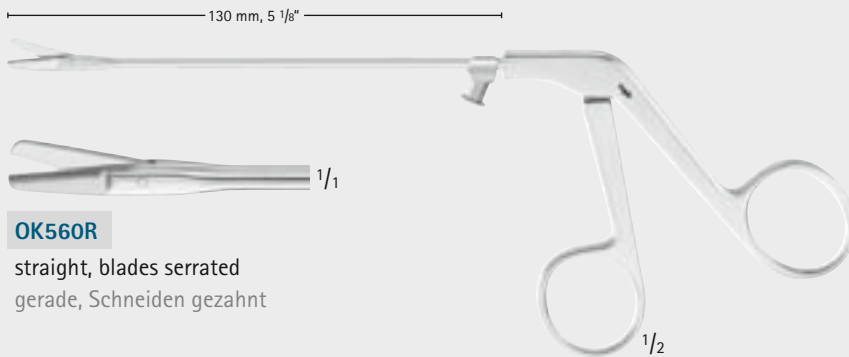

OK560R

straight, blades serrated
gerade, Schneiden gezahnt



OK561R

left curved, blades serrated
links gebogen, Schneiden gezahnt



OK562R

right curved, blades serrated
rechts gebogen, Schneiden gezahnt

OK560R-OK562R

Nasal scissors
Nasenscheren

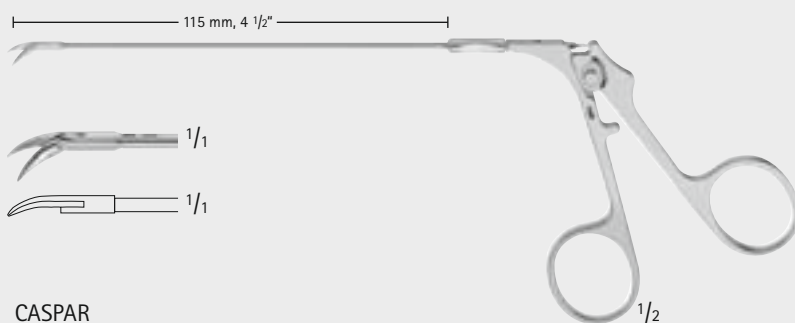

CASPAR

FD228R

Micro scissors, curved rotatable 360°, detachable for cleaning
Mikro-Schere, gebogen, 360° drehbar, zerlegbar zur Reinigung







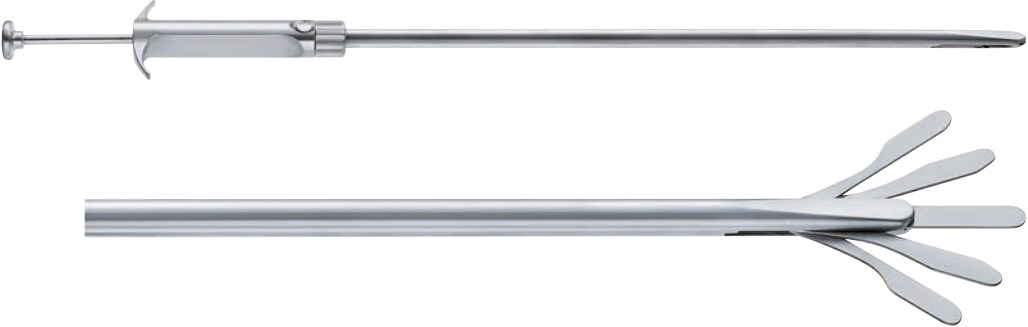

Rhinology
Rhinologie

MILLIMETERS

RETRACTION INSTRUMENTS // RETRAKTIONSINSTRUMENTE

Order number Artikelnummer	Description Beschreibung	Diameter Durchmesser	Shaft Length Schaftlänge
	Retraction instruments for holding away organs and tissue structures. Retraktionsinstrumente zum Weghalten von Organen und Gewebestrukturen.		
PL680R	Fan retractor Fächerretraktor	10 mm	400 mm
			



Intracorporeal	Description	Item No.	Diam.	Length
 1/1	Durogrip™ TC needle holder, straight	PL419R	3.5 mm	20 cm
		PL418R	3.5 mm	29 cm
 1/1	Durogrip TC needle holder, straight	PL407R	5 mm	31 cm
		PL404R	5 mm	37 cm
		PL416R	5 mm	42 cm
 1/1	Durogrip TC needle holder, curved left	PL408R	5 mm	31 cm
		PL405R	5 mm	37 cm
		PL417R	5 mm	42 cm
 1/1	Durogrip TC needle holder, curved right	PL413R	5 mm	31 cm
		PL415R	5 mm	37 cm
 1/1	"The Viper" Durogrip TC suture Assistant/ needle holder, 2 x 3 Teeth	PL409R	5 mm	31 cm
 1/1	Super righting needle holder	PL414R	5 mm	31 cm
 1/1	Durogrip TC needle holder, fenestrated	PL410R	5 mm	31 cm
 1/1	Durogrip TC needle holder, crimped/ fenestrated	PL411R	5 mm	31 cm



Wundhaken – Wound Retractors
 Wundhaken, Lungenspatel
 Retractors, Lung Spatulas

BT

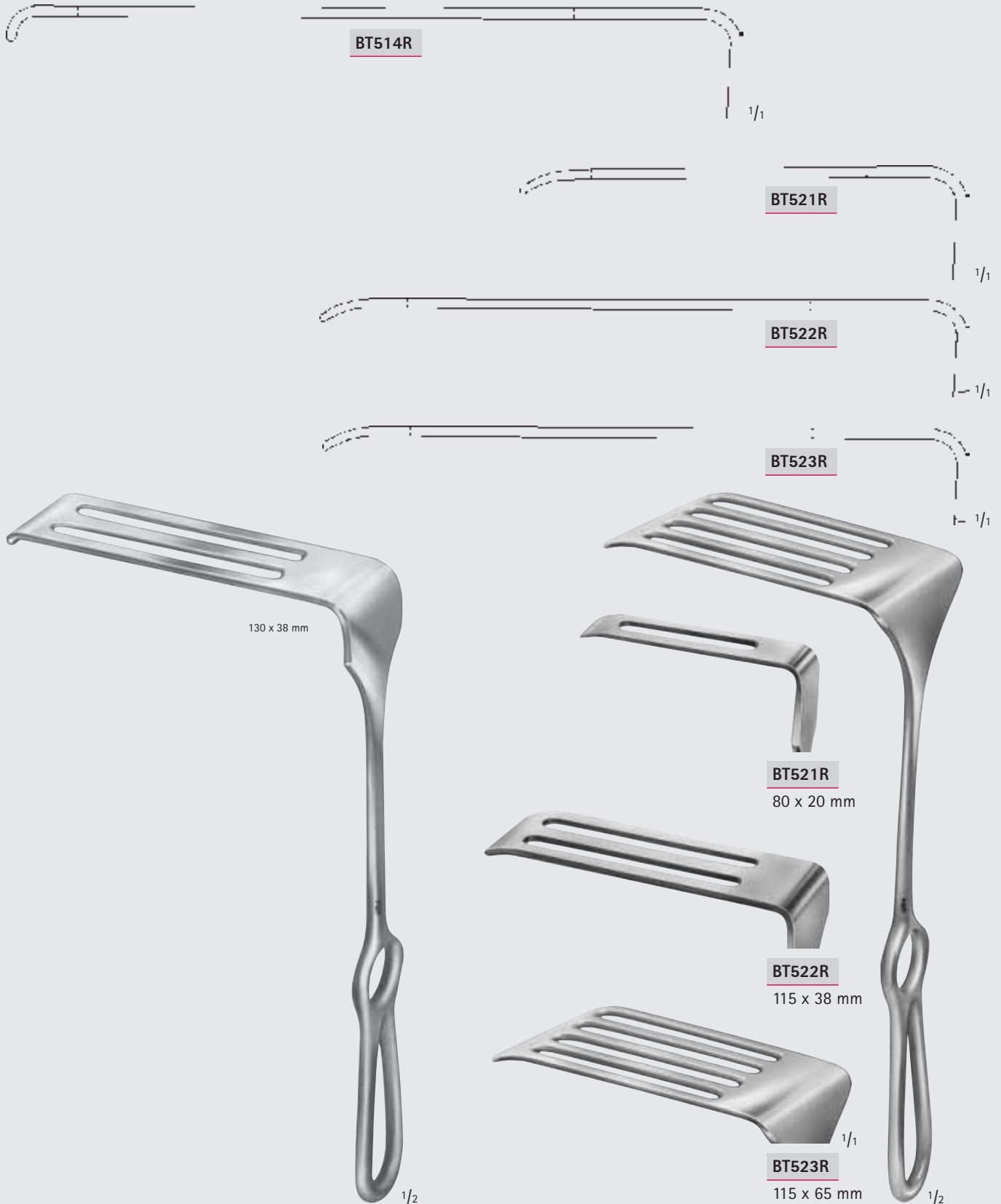

130 x 38 mm

BT521R
80 x 20 mm

BT522R
115 x 38 mm

BT523R
115 x 65 mm

SAUERBRUCH

BT514R

260 mm, 10 1/4"

CORYLLOS

BT521R-BT523R

255 mm, 10"

MILLIMETERS

Manipler[®] AZ

Single-use Skin Stapler for Wound Closure
An Easy Solution for Skin Closure



Closure Technologies

Manipler® AZ

The Easy Solution for Skin Closure

Manipler® AZ Skin Stapler delivers fast closure at the end of any surgical procedure.

It offers the security and confidence, thus reducing the risk to the patient.

skin stapler

Lightweight Design

Handles like a well-balanced, surgical instrument

High Quality Construction

Consistent, reliable performance

Slim Grip Design

Provides excellent visibility and allows for easy handling with no hand fatigue

Special Angled Head

Enables the user to see the incision from a normal viewing perspective to ensure precise staple deployment

Flexible Placement Angle

Allows choice in staple placement depth

Precise Staple Counting

Staple count indicator provides a direct view of remaining staples



Simple and Efficient by Design

new single use remover

Single-use Remover



Reusable Remover



Complete Portfolio

Available as single-use and reusable remover

Versatility

Can be used for virtually all brands of surgical skin staples

Intuitive Control

For reliable and controlled performance

Elegant Design

Easy to handle making removal simple and safe

*With reinforced tip
for safe and easy handling*

Product Range

Article No.	Product Description	Staple Information		Staple Dimensions		Units
		Type	No.	Crown	Leg.	per box
783100	Manipler® AZ	Wide	35	6.9 mm	3.6 mm	6
783101	Single use skin staple remover					6
783102	Reusable skin staple remover					1

Manipler[®] AZ

The Easy Solution for Skin Closure

advantages

▶ Grip Designed for Best Angle

The set up angle of the shape of the device enables a clear view of the wound edges

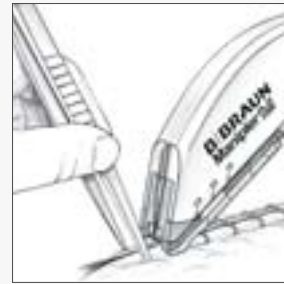

▶ Automatic Clip Ejection

Precisely ejects clips, this enables rapid wound closure and shortens operation time

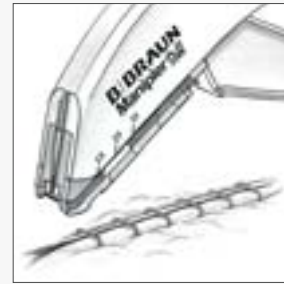

▶ Box-Style Staple

This provides several performance advantages, including safe wound closure and support



▶ Ease of Use

High profile staples make removal easier





B. Braun Surgical SA | Carretera de Terrassa, 121 | 08191 Rubí | Spain
Phone +34 93 5 86 62 00 | Fax +34 93 6 99 73 03 | www.bbraun.es

Aesculap AG | Am Aesculap-Platz | 78532 Tuttlingen | Germany
Phone +49 7461 95-0 | Fax +49 7461 95-26 00 | www.aesculap.com

Aesculap – a B. Braun company

Subject to technical changes. All rights reserved.
This brochure may only be used for the exclusive
purpose of obtaining information about our
products. Reproduction in any form partial or
otherwise is not permitted.