

W GT102-153 Abdominal pad

Material: Non-Woven fabrics + FULLF +SAP + Water Proof

Description: Color: white

10X10cm	1pc/pouch	50pouches/box	12boxes/ctn	42X36X42cm
10X20cm	1pc/pouch	20pouches/box	36boxes/ctn	51X46X48cm
20X10cm	1pc/pouch	20pouches/box	18boxes/ctn	51X40X48cm
20X30cm	1pc/pouch	20pouches/box	12boxes/ctn	52X18X47cm
20X40cm	1pc/pouch	20pouches/box	12boxes/ctn	52X35X52cm



GT102-150 PU adhesive tape

Material: Polyurethane film

Available in line shape or zig shape

Color: transparent

Size: 5x1000cm, 10x1000cm, 15x1000cm, 20x1000cm etc.

Packing: 100rolls/carton, 50rolls/carton



W GT102-160 Fiberglass casting tape

Material: Fiberglass

Size: 5cmx360cm, 7.5cmx360cm, 10cmx360cm, 12.5cmx360cm, 15cmx360cm etc.

Packing: 1pc/ Aluminum Foil Bag 50pcs/box 100box/carton



GT102-110

Self-adhesive wound dressing

Material: PU, Non-woven, etc.

Color: White, Flesh, etc.

Weight of adhesive: 70-75g/m2

Shape: Round corner, Square corner,

With mat or without is available.

Size: 5cmx7cm, 6cmx8cm, 10cmx10cm,

10cmx12cm, 10cmx15cm, 10cmx20cm,

10cmx25cm, 10cmx30cm, 10cmx35cm etc.

Packing: 50pcs/box

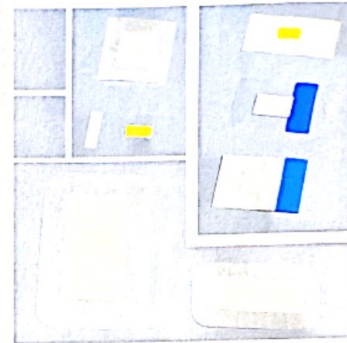

W GT102-120

Infusion plaster

Material: Non-woven

Color: White, Flesh.

Weight of adhesive: 30-32g/m2

Shape: Rectangle

Size: 70x25mm, 70x35mm etc.

Packing: 100pcs/box 100box/carton



GT102-130

Self-adhesive eye pad

Material: Non-woven

Color: White, Flesh.

Weight of adhesive: 30-32g/m2

Shape: Oval

Size: 80x50mm, 85x55mm, 95x65mm etc.

Packing: 50pcs/box 100box/carton

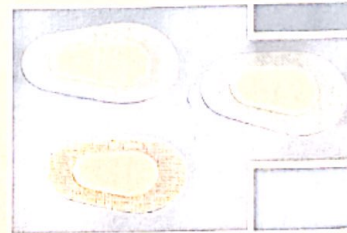

GT102-140

Non-adherent pad

Material: 70% Viscose with 30% Polyester

Color: White

Shape: Round, Square, Rectangle

Size: 5x5cm, 10x10cm, 15x15cm, 20x20cm etc.

Packing: 100pcs/box 100box/carton

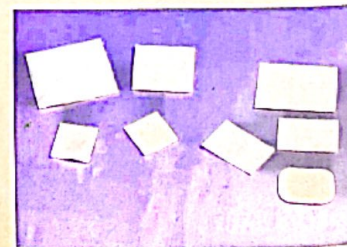

**GT032-300
Disposable Heat Moisture
Exchange Filter(HME Filter)**

Function:moistening,warming and filtering the gas
that come out from the breathing machine.
Made by medical plastic PP.
High effective filtering rate : 99.99%
Size:Adult, Child
Packing:Individual Blister Bag

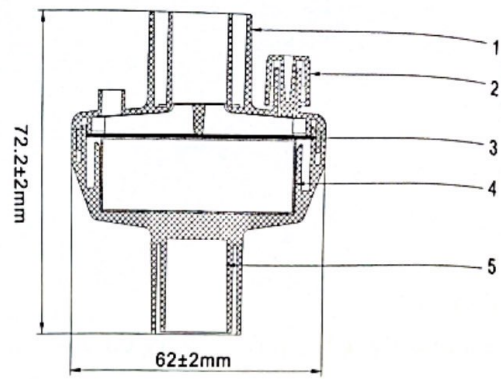

NO.	Components	Material	Quantity
1	Upper Cover	PVC	1
2	Screw Cap	PP	1
3	Filteringmembrane	polyurethane	1
4	Humidifying paper		1
5	Lower Cover	PP	1

**GT032-400A
Disposable Tracheostomy
Heat Moisture Exchanger**

Tidal Volume:200-1500ml;Moisture Output(mg H₂O /
L air):24/25mg@Vt 500ml;Resistance(cm H₂O)
:<2.3@60L/min
size:Adult
Packing:Individual Blister Bag

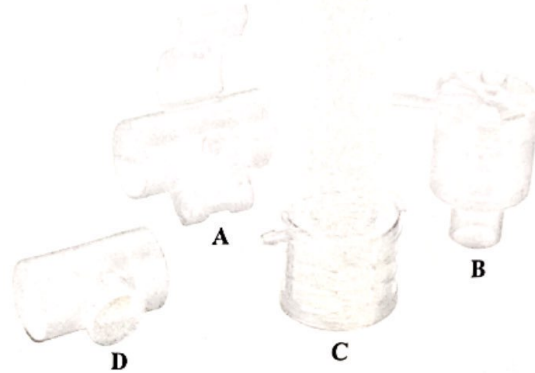

Model	GT032-400A	GT032-400B	GT032-400C	GT032-400D
Recommended tidal volum(ml)	>75	>75	>75	>75
Moisture loss* (mg H ₂ O/lair)	9.0(@Vt 500ml)	9.2(@Vt 500ml)	9.0(@Vt 500ml)	9.0(@Vt 500ml)
Resistance(pa)	15 at 30l/min	50 at 30l/min	20 at 30l/min	20 at 30l/min

**GT032-200
Disposable Bacterial/Viral Filter**

Function:Mainly used for filtering the bacterial,viral and wetting the gases in breathing machine and anesthesia circuits, also can be used with Lung function examination equipment to protect the instruments by filtering the bacterial.
Made of medical high polymer material.
Filter medium is primarily a superfine polypropylene fiber with static electricity,and polypropylene is Hydrophobic materials that restrains the growing of fungus,bacterial and viral.
Packing:Individual Blister Bag

NO.	Components	Material	Quantity
1	Upper Cover	PVC	1
2	Screw Cap	PP	1
3	Filteringmembrane	polyurethane	1
4	Lower Cover	PP	1

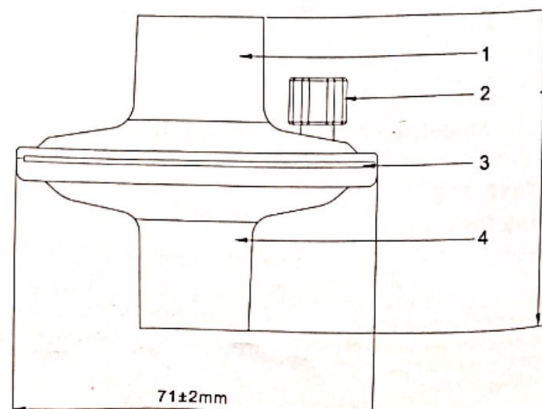

GT038-700

I.V. Cannula

Needle size: 14, 16,18,20,22,24G

I.V.Cannula with Injection port and suturable wings

I.V Cannula with suturable wings

I.V Cannula with Injection port and without Wings

Option Available :

- PTFE / FEP / PU Flex Catheter
- Hydrophobic filter
- Clear or Radio Opaque Catheter

Advantage of using PU Flex Catheter :

- Kink free
- The Catheter softens once inserted in the body
- The properties of this Catheter are similar to PU (Polyurethane)

FEATURES:

Japanese Needle with 3-facet Needle point to reduce penetration force

Kink resistant and specially tapered Catheter for easy vein puncture with minimum trauma

Transparent flash back chamber for easy visualization of blood to confirm venipuncture

With Luer Lock plug

Colour coding for each gauge as per International standards

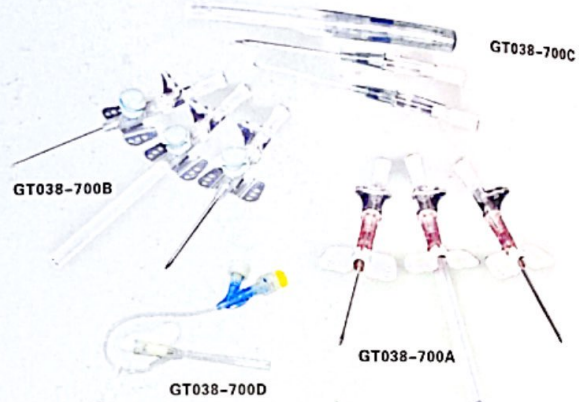

Size	Colour	Catheter (mm)		Catheter Length (mm)	Water Flow Rate (ml / min)
		I.D	O.D		
14 G	Orange	1.7	2.1	45	270
16 G	Grey	1.3	1.7	45	180
17 G	White	1.1	1.5	45	125
18 G	Green	0.9	1.3	32 / 45	80
20 G	Pink	0.8	1.1	32	54
22 G	Blue	0.6	0.9	25	33
24 G	Yellow	0.5	0.7	19	20

Hypodermic & Surgical Instruments

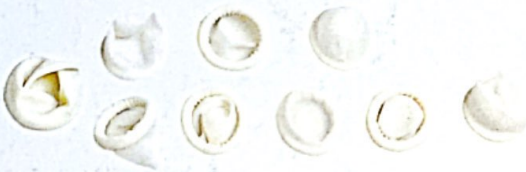

GT053-100

Latex Powder-free Finger Cots And Powdered

Latex Powder-free Anti-static Finger Cots.

Designed With A Proprietary Anti-static Agent That Yields Average Surface Resistance Of 108-11Ω Ohms Per Square Surface Unit.

It Virtually Eliminate Electro Static Discharge.

These Finger Cots Are Clean Processed And To Protect Particulates, Chemicals And Solvents With Skin.

Type: Smooth Surface With Rolled, Unrolled Or Cut Is Available.

Specification Size ±3mm

	L	M	S
Length(mm)	65	65	65
Width(mm)	29	27	25
Thickness(mm)	0.13	0.13	0.13

Packing: 100Pcs/bag, 30000Pcs/ ctn, 45 X 45 X 30cm



GT054-200

Tourniquet

Length: 45cmx Width:2.5cm, Stretch Length: 80-90cm

With ABS Button,

Material Of Belt, Terylene+elastic Latex

Color: Blue, Red, Green, Black,white,yellow, Purple,pink etc.

Packing: 1pc/PP bag, 50Pcs / box, 600Pcs/ ctn, 57 X 38 X 37cm



GT055-100

Latex Tube

I. D. : 3mm-10mm

O. D. : 5mm-15mm



GT054-100

Stanch Colligation Band

1. Stanch Colligation Band (natural Latex)

Size :width 3/4 Inch Length : 18 Inch X Thickness:0.45cm

Size :width 3/4 Inch Length : 29 Inch X Thickness:0.45cm

Size :width 1 Inch Length : 18 Inch X Thickness:0.45cm

2. Stanch Colligation Band , Latex-free(isoprene)

Size :width 3/4 Inch Length : 18 Inch X Thickness:0.55cm

Size :width 3/4 Inch Length : 29 Inch X Thickness:0.55cm

Size :width 1 Inch Length : 18 Inch X Thickness:0.55cm





GT063-100
Spunbond Meltdown Spunbond(SMS)
Surgeon Gown

SMS 手术衣

Specification:

Material: Spunbond Meltdown Spunbond(SMS)
Color: white/blue/yellow/green.
Weight: 40gsm/ 45gsm/48gsm/50gsm/55gsm etc.
Size: S/M/L/XL/XXL
Suited to hospital use & for surgery

Specification:

With ties at back of the neck and waist
Comfortable sleeve tailoring for maximum freedom of movement
Soft knit cuffs for wrist comfort
Secure sleeve seams for protection
Extra protection reinforcement on sleeve & chest and full-body on selected gowns
Spunbond meltdown spunbond(SMS) material gown, breathable, quiet and supple, high repellency, AAMI standard, sterile with comfortable design for operating theater
With knitted cuff , Velcro neck back closure, side waist band
1 hand towel is available
1 wrap towel is available
Sterile method : non sterile or EO STERILE,
Packing: 10 pcs/poly bag or 1 pc/sterile bag



GT063-101
Reinforced SMS Surgical gown
加强型 SMS 手术衣

Specification:

Material: Spunbond Meltdown Spunbond(SMS)
Color: white/blue/yellow/green.
Weight: 40gsm/ 45gsm/48gsm/50gsm/55gsm etc.

Size: S/M/L/XL/XXL

Suited to hospital use & for surgery

Specification:

With ties at back of the neck and waist
Comfortable sleeve tailoring for maximum freedom of movement
Soft knit cuffs for wrist comfort
Secure sleeve seams for protection
Extra protection reinforcement on sleeve & chest and full-body on selected gowns
Spunbond meltdown spunbond(SMS) material gown, breathable, quiet and supple, high repellency, AAMI standard, sterile with comfortable design for operating theater
With knitted cuff , Velcro neck back closure, side waist band
Reinforced arm and additional liner at front
1 hand towel is available
1 wrap towel is available
Sterile method : non sterile or EO STERILE,
Packing: 10 pcs/poly bag or 1 pc/sterile bag

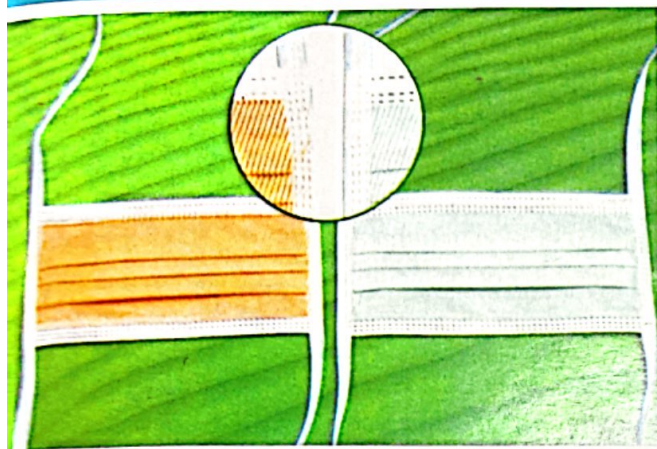

GT059 -104
4-ply Anti-penetration Nonwoven Face Mask
 四层防渗透无纺布口罩

Size: 9.2(18)x18cm
 Material: 18g/m² We-laid nonwovens (or 22g/m² PP)+anti-penetration Punching membrane + 24g/m² melting-blown PP + 25g/m² calendering PP
 Packing: 50pcs/box, 6box/carton or 20box/carton
 Function: 4-ply structure, effectively prevent from bacteria and dust, high efficiency in resisting penetration, BFE up to 99%
 Production technique: ultrasonic machine-sewed, with tie and nosepiece
 Application: suitable for casualty wards, infection wards, surgery rooms, medical sanitation, scientific experiment, chemical industry and pharmacy

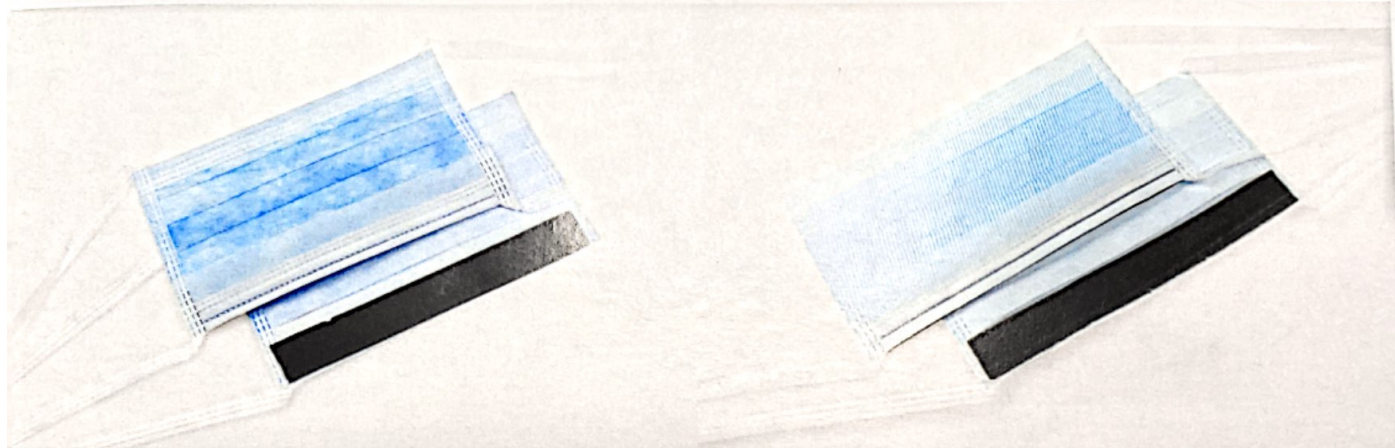

GT059 -121 Face Mask 三层海绵层口罩

Material: 18g/m² we-laid nonwovens (or 22g/m² PP)+ 24g/m² melting-blown PP + 25g/m² calendering PP
 Packing: 50pcs/box, 6box/carton or 20box/carton
 Function: 3-ply structure, effectively prevent from bacteria and dust, BFE up to 99%
 Production technique: ultrasonic machine-sewed, with tie and nosepiece
 Application: suitable for casualty wards, infection wards, surgery rooms, medical sanitation, scientific experiment, chemical industry and pharmacy

GT059 -120
4-ply Non-penetrated Anti-fog Face Mask
 四层防渗透防雾片口罩

Size: 9.2 (18) x 18 cm, with anti-fog piece
 Material: 18g/m² wet-laid nonwovens (or 22g/m² PP) + non-penetrated punching membrane + 24g/m² melting-blown PP + 25g/m² calendering PP
 Packing: 25pcs/box, 10box/carton
 Function: 4-ply structure, effectively prevent from bacteria and dust, protect eyes and face from fluid, provide better safe property
 Production technique: ultrasonic machine-sewed, with tie and anti-fog nosepiece
 Application: suitable for casualty wards, infection wards, and scientific experiment



GT059-120
 镜片口罩

一次性无纺口罩

Conforms to American NELSON N95 test standards.
Mini-fiber high electrostatic filter, filtration efficiency of dust & powder is over 95%.
Repel continually contamination of dangerous blood and saliva continually.
Inner cover is well sweat-absorbed, while outer cover is water resistant.
polypropylene cloth, low breathing resistance and high filtration efficiency.

GT059-101 Non-woven Face Mask**Specification:**

Ear-Loop Type,

Ply: 1ply, 2-Ply or 3 Ply

Detailed Weight: 1 Ply:38g/m², 2Ply:25g/m²+18g/m²;
3Ply:25g/m²+20g/m²+16g/m²;

Size: 18x9cm

Color: White, Green, Blue, Red, Pink, Yellow, etc.

Packing: 50Pcs/Box 40Boxes/Carton

**GT059-105 Non-woven Face Mask For Children****GT059-102 Non-woven Face Mask****Specification:**

With ties type

Ply: 2-ply or 3 ply

Detailed weight: 2ply:25G/M2; 3ply:25G/M2+20G/M2+16G/M2;

Size: 18x9cm

Color:white, Green, Blue, Red, Pink, Yellow, etc.

Packing: 50pcs/box, 40 boxes/carton,

Carton size: 520x380x380CM

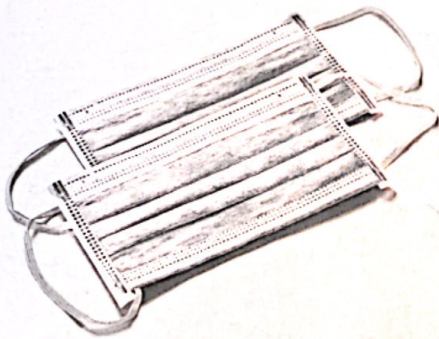
**GT059-103 Non-woven Face Mask with Charcoal****Description:**

一次性无纺口罩 (活性炭)

Conforms to American NELSON N95 test standards.

3-ply polypropylene cloth, low breathing resistance and high filtration efficiency.

Adjustable nose seal, easy to fold and carry. Mini-fiber high electrostatic filter, filtration efficiency of dust & powder is over 95%.

Repel continually contamination of dangerous blood and saliva continually.

Suggested applications: school, restaurant, surgery, electronic, theaters, beauty salon...etc public places.

Specification:

Ear-loop type: 3 ply

Detailed weight: 3ply:25G/M2+20G/M2+16G/M2;

Size: 18x9cm Color:white, green, blue etc.

Packing: 50pcs/box, 40 boxes/carton, Carton size: 520x380x300CM

GT059-200 Nurse Paper Face Mask 一次性纸口罩**Description:**

Our Most Economical Face Masks, High Quality Wet-Strength Paper Comfortable Elastic Ear Loops For Easy Donning Product Description

Specification:

2 Ply or 1 Ply

Size: 20x7cm

Color: White

Suggested Applications: Polluted Environment,

Especially Good For Absorbing and Filtrating The Exhausted Gas From Motor Vehicles.

Packing: 100 Pcs/Box 100Boxes/Carton

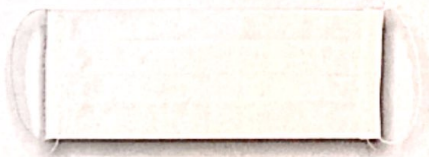



GT010-110 Simple Oxygen Mask

Made of clear, medical grade PVC
 With adjustable nose clip
 With Anti-crush tube
 With elastic strap
 With 2.1m oxygen tube
 Latex free is available
 DEHP Free is available
 Size:XS,S,ML,XL
 Packing:PE bag

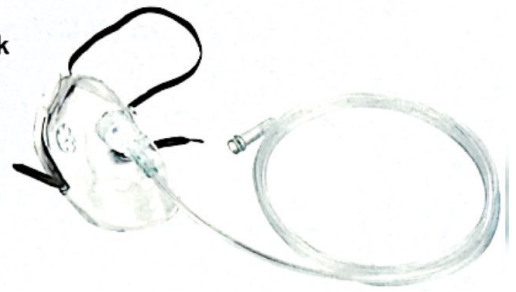

GT010-150 Venturi mask

Made of clear, medical grade PVC
 With adjustable nose clip
 With Anti-crush tube
 With elastic strap
 With 2.1m oxygen tube
 7 density can be adjusted by two diluters
 Green:24%,26%,28%,30%;white:35%,40%,50%
 Latex free is available
 DEHP Free is available
 Size:S,M,L,XL
 Packing:PE bag

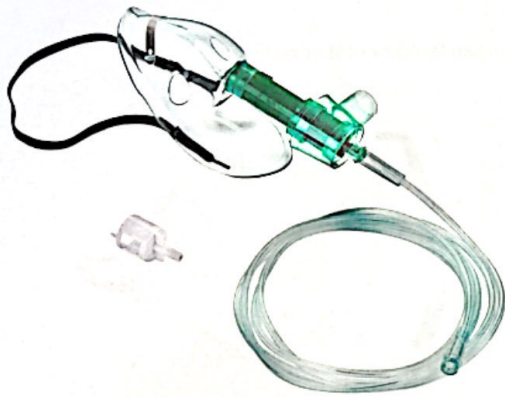

GT010-170 Adjustable Venturi Mask

Made of clear, medical grade PVC
 Adjustable nose clip
 6 diluters choice, each diluter for one oxygen density
 Oxygen concentration is blue 24%,
 Adaptor for high humidity
 Anti-crush tube
 With 2.1m oxygen tube
 Latex free is available
 DEHP Free is available
 Size :S,M,L,XL
 Packing:PE Bag



GT012-100 Nebulizer Mask

Made of clear, medical grade PVC
 With adjustable nose clip
 With 2.1m oxygen tube
 Standard connector
 Nebulizer jar volume:6cc,15cc
 Latex free is available
 DEHP Free is available
 Size:XS/S/M/L/XL
 Packing:PE Bag

GT012-101 Elephant Nebulizer Mask

Made of clear, medical grade PVC

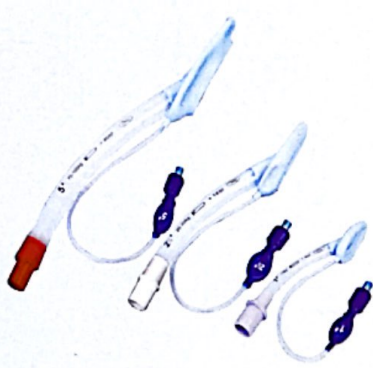

**GT029-700
Disposable Silicone Laryngeal Mask**

Made of 100% medical grade silicone
 No poison and harmless
 Non-epiglottis-bar design provides easy and clear access through the lumen
 5 angular lines appear when the cuff is in flat status, which can avoid the cuff to deform during insertion
 Deep bowl of the cuff provides excellent sealing and prevent the obstruction caused by epiglottis ptosis
 Special treatment of the cuffs surface reduce leak and shift effectively
 Suitable for adult, children and infant use
 Sterilization:EO
 Size 1#,1.5#,2#,2.5#,3#,4#,5#
 Packing:Blister bag



**GT029-720
Disposable PVC Laryngeal Mask**

Made of non-toxic medical grade PVC
 No poison and harmless
 Non-epiglottis-bar design provides easy and clear access through the lumen
 Special treatment of the cuff's surface reduce leak and shift effectively
 Suitable for adult, children and infant use
 Sterilization:EO
 Size:1#,1.5#,2#,2.5#,3#,4#,5#
 Packing:Blister bag

Size	Indicative Patient/Weight	Maximal Volume of Balloon	Remark
1#	<6	4	Newborn
1.5#	6-10	4	Infant
2#	10-20	5	Child
2.5#	20-30	12	Child
3#	30-50	20	Adult
4#	50-70	30	Adult
5#	70-100	40	Adult

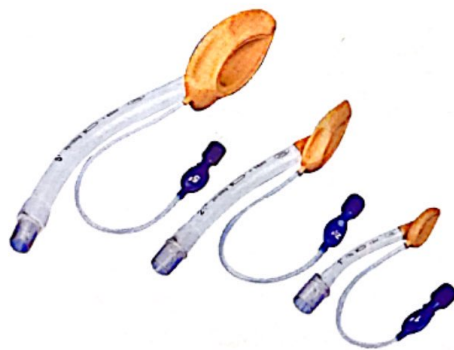

**GT029-710
Reusable Silicone Laryngeal Mask**

Made of 100% medical grade silicone
 No poison and harmless
 Non-epiglottis-bar design provides easy and clear access through the lumen Can be used for 40 times and sterilized by 121°C steam
 5 angular lines appear when the cuff is in flat status, which can avoid the cuff to deform during insertion
 Deep bowl of the cuff provides excellent sealing and prevent the obstruction caused by epiglottis ptosis
 Special treatment of the cuffs surface reduce leak and shift effectively
 Suitable for adult, children and infant use
 Sterilization:EO
 Size:1#,1.5#,2#,2.5#,3#,4#,5#
 Packing:Blister bag

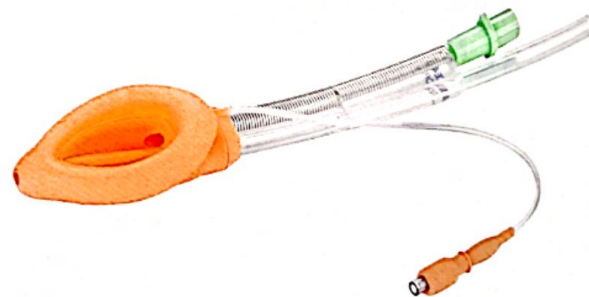

**GT027-730
Reinforced Silicone Laryngeal Mask**

Made of 100% medical grade silicone
 No poison and harmless
 Spiral reinforcement minimizes crushing or kinking
 Smooth transparent and kink-resistant tube
 Suitable for adult, children and infant use
 Sterilization:EO
 Size: 1#,1.5#,2#,2.5#,3#,4#,5#
 Packing:Blister bag

GT012-400S Silicone Anesthesia Mask

Transparent for visual check of bleeding, vomitus, and spontaneous breathing
Available in one piece or dome/cuff type
Cover the 9 sizes from preterm baby to Adult-XL
All models are reusable and can be autoclaved repeatedly at 134°C
Latex-free

Size	Port	QTY/CTN	Carton Size	Description
000#	15OD	300	46x36x30cm	Premature
00#	15OD	300	46x36x30cm	Premature
0#	15OD	200	46x36x30cm	Neonate
1#	15OD	200	46x36x30cm	Infant
2#	22ID	100	46x36x30cm	Pediatric
3#	22ID	100	46x36x30cm	Adult-S
4#	22ID	100	57x33.5x39cm	Adult-M
5#	22ID	100	57x33.5x39cm	Adult-L
6#	22ID	80	57x33.5x46cm	Adult-XL

Round Mask

Size	000#	00#	0#	1#	2#
Port	15OD	15OD	15OD	15OD	22ID
Description	Premature	Premature	Neonate	Infant	Pediatric

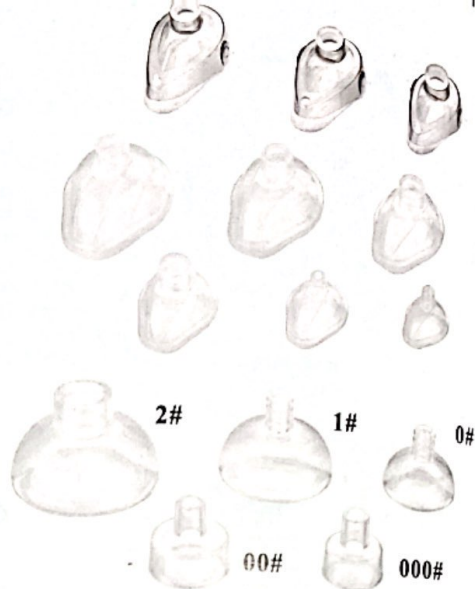

GT012-400 PVC Anesthesia Mask

Transparent for visual check of bleeding, vomitus, and spontaneous breathing
Available in one piece or dome/cuff type
Cover the 9 sizes from preterm baby to Adult-XL
All models are reusable and can be autoclaved repeatedly at 134°C
Latex-free



400PB

Soft Cushion Anesthesia Mask

Size	Hook Color	Port	Description
0#	White	15OD	Premature
1#	Pink	15OD	Neonate
2#	Yellow	15OD	Infant
3#	Green	22ID	Pediatric
4#	Red	22ID	Adult-S
5#	Blue	22ID	Adult-M
6#	Orange	22ID	Adult-L

PVC Anesthesia Mask

Size	Hook Color	Port	Description
0#	White	15OD	Neonate
1#	Pink	15OD	Infant
2#	Yellow	22ID	Pediatric
3#	Green	22ID	Adult-S
4#	Red	22ID	Adult-M
5#	Blue	22ID	Adult-L
6#	Orange	22ID	Adult-L



400PC

PVC Free-Anesthesia Mask

Size	Cushion Color	Port	Description
1#	Blue	15OD	Neonate
2#	Orange	15OD	Infant
3#	Pink	22ID	Pediatric
4#	White	22ID	Adult-S
5#	Yellow	22ID	Adult-M
6#	Green	22ID	Adult-L



GT117-300 CPR Mask

CPR Mask is especially designed to be used for First-Aid rescuing and training. The mask features a replaceable one-way valve with biological filter in one housing
Features:

This mask is made of environmental material
With one-way valve to avoid any direct contact between overcome hesitation to start resuscitation
Apply to Resuscitation, First aid training, Hospital, School or being used as accessory of first aid kit
Box Color: Red, Blue, Green, White.

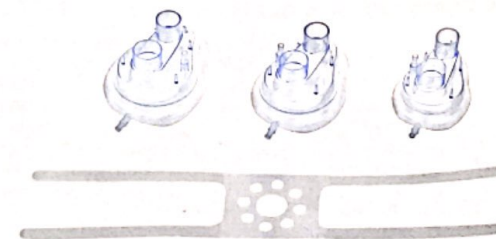

GT117-400 Simple CPAP Mask

CPAP Mask is an interface for the treatment of obstructive sleep apnea using continuous positive airway pressure. It provide a good seal when fitted to the patient whilst providing maximum comfort.

Size: Adult-S, Adult-M, Adult-L
Accessories: PEEP Valve, Headgear (Adult, Pediatric).



GT037-600

Safety Syringe

Size: 1ml, 3ml, 5ml, 10ml, 20ml

Operation procedure

- ① Fix the clip before drawing.
- ② Same operation as normal syringe in drawing and injecting
- ③ After injection, push the clip over the needle and lock it onto the clip base

GT037-700

Safe Syringe

Size: 0.5ml, 1ml, 3ml, 5ml, 10ml

Material: Medical PP (Barrel And Plunger)

Latex/latex Free (Piston)

Stainless Steel (Needle)

Individually Packing: Blister Packaging

Inner Packing: Box/Polybag

Outer Packing: Corrugated Carton

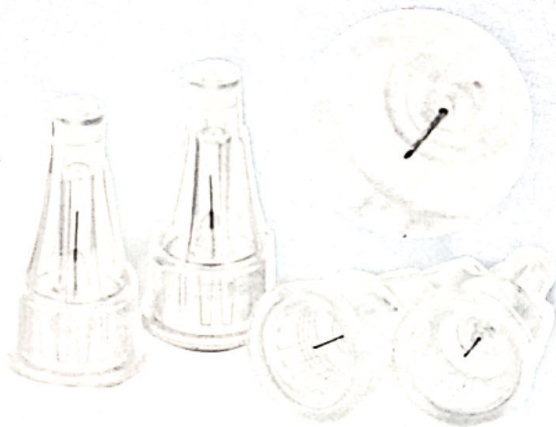

GT038-900

Insulin Needle

Needle Size	Needle length	Package
30G	8mm	100pcs/box
31G	8mm	100pcs/box
31G	6mm	100pcs/box
31G	5mm	100pcs/box
32G	4mm	100pcs/box
33G	4mm	100pcs/box

GT038-500

Scalp Vein Set

Type: Single Wing, Double Wings

Needle O.D(mm)	Color	Needle O.D(mm)	Color
0.3	Yellow	1.1	Milky white
0.33	Red	1.2	Pink
0.36	Bluish Green	1.4	Redish Purple
0.4	Grey	1.6	White
0.45	Brown	1.8	Bluish Grey
0.5	Orange	2.1	Light Green
0.55	Purple	2.4	Purple
0.6	Dark Blue	2.7	Light Blue
0.7	Black	3.0	Greenish Yellow
0.8	Dark Green	3.4	Greenish Brown
0.9	Yellow	-	-

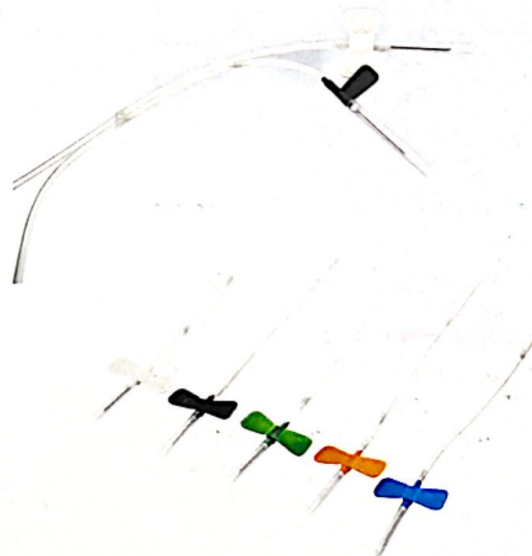



GT004-136 Thermometer Cover

Material: PE
 Description: Insert, twist, pull apart or peel back covers
 Packing: 200pcs/box, 150box/carton
 Carton Dimension: 38x32x32cm



GT078-100 Surgical Hand Brush



GT078-200 Iodine Brush

Detail Description:
 With liquid
 Povidone-Iodine 5%
 Povidone-Iodine 9%
 Povidone-Iodine 10%
 Isopropyl Alcohol 7%
 Parachlormetaxylenol 4%
 Parachlormetaxylenol 3.3%
 Chlorhexidine Digluconate 4%
 Packing: 1/mold bag, 20 bags/bx,
 10 bx/ctn

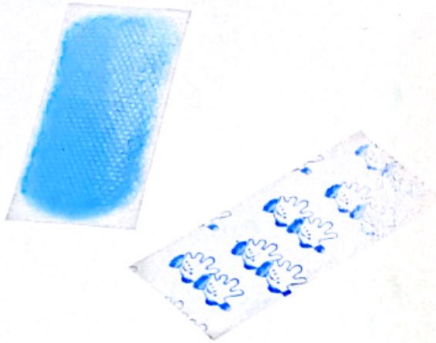

GT085-120 Cooling Gel Patch

For instant cooling sensation soothes fever discomfort

- Produce fever quickly-Easy to use
- Gentle to the skin
- Safe to use with medications
- Contain non-drug
- Soothes fever instantly
- Strong adhesive power
- 12 hours cooling effect

Use Instructions:

Peel off the transparent film and apply aikido on surface to the effeled area.
 To enhance the cooling effect, place aikido in a refrigerator before use, don't place aikido gel in freezer. Aikido gel may be cut to the required size using a pair of scissors



GT004-137 Ear Thermometer Probe Cover



GT112-200 Umbilical Cord Clamp clipper

Material Pom+ Stainless Steel Blade
 Feature Disposable Medical Use
 Colour: White, Green, Blue
 Function: To Cut Off The Umbilical Cord Clamp When A Woman Giving Birth To A Baby.



GT112-300 Umbilical Cord Cutter



GT112-100 Umbilical Cord Clamp

Size: 5.0 /5.5/ 6.0 cm
 Material: ABS/PP/PE
 Color: Bule, White, Pink



GT114-100: I.D. Bracelet

Usage: Record Important Identification Information of A Patient, Tie On Patient's Wrist, 24-hour Close Identification Can Effectively Ensure That Any Time Quickly And Accurately Identify Patients.
 Material:PVC
 Color:Blue, Pink, White, Other Color By Optional
 Model:Adhesive, Write-on, Insert-card,
 Infant, Adult, Adult&Infant

GT112-400 Amniotomy Hook

Material: ABS
 Type: Straight, Curved.



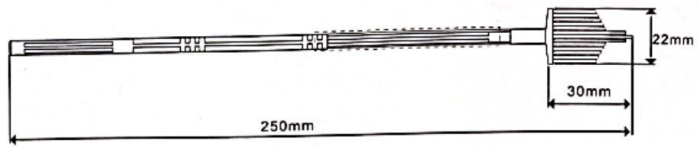

Number	Model	Description	Packaging	Quantity
GT159-0801	A-1	Push tube, pink brush, Individually packaged, EO sterile.	20x100PCS/ carton	>2000PCS
GT159-0802	A-2	No Push tube, pink brush, Individually packaged, EO sterile.	20x100PCS/ carton	>2000PCS

A

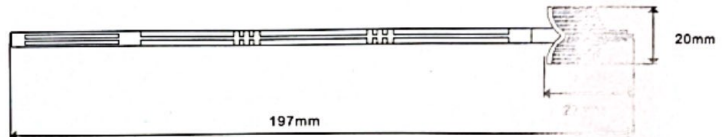

Number	Model	Description	Packaging	Quantity
GT159-0803	B-1	Push tube, blue brush, Individually packaged, EO sterile.	20x100PCS/ carton	>2000PCS
GT159-0804	B-2	NO Push tube, blue brush, Individually packaged, EO sterile.	20x100PCS/ carton	>2000PCS

B

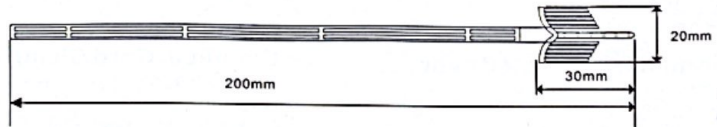

Number	Model	Description	Packaging	Quantity
GT159-0805	C-1	Blue brush bar, individually packaged, EO sterile.	20x100PCS/ carton	>2000PCS

C-1

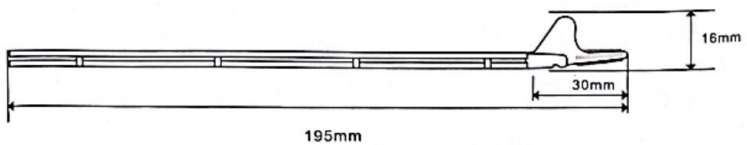

Number	Model	Description	Packaging	Quantity
GT159-0807	C-2	Blue brush bar, individually packaged, EO sterile.	20x100PCS/ carton	>2000PCS

C-2

Vaginal Speculum

Description:

It can be used for the checking and treatment of gynecology disease in hospitals or clinics. Before using it, user must read the usage manual, and then take the speculum, push the "duckbill" of speculum that is closed into the vaginal slowly. Open the "duckbill" of speculum according to demand, fix the nut of speculum, then it can be used for checking and treatment of gynecology disease. After all, loose the nut of speculum, and take "duckbill" of speculum out of the vaginal slowly.

Specification:

Made of polystyrene;
It is a transparent substance, non-toxic, medical grade
Size: Large/Middle/Small
Supplied sterile in individual polybag or Film+ Polybag or blister pack
sterilized by ethylene oxide gas

From of packing:

steriled in individual polybag or Film+ Polybag or blister pack; 100pcs/ carton;

Size of packing:

Export carton:520x380x360mm

G.Weight.:7kgs

N.Weight: 6kgs

Other Medical Products

NINGBO GREEMED MEDICAL INSTRUMENTS CO.,LTD.
WEB: <http://www.greemed.com> E-MAIL: info@greemed.com



GT159-100 Disposable Vaginal Speculum with side screw



GT159-103 Disposable Vaginal Speculum with middle screw

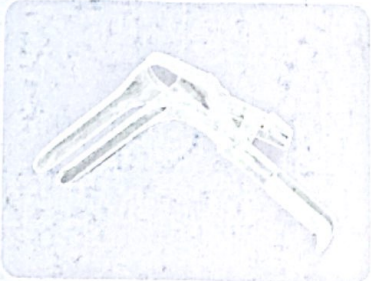

GT159-106 American type Disposable Vaginal Speculum



GT159-101 French type 1 Disposable Vaginal Speculum

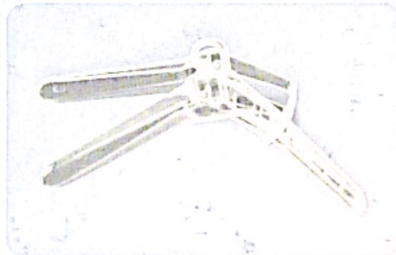

GT159-104 Australia type Disposable Vaginal Speculum



GT159-102 Spanish type Disposable Vaginal Speculum

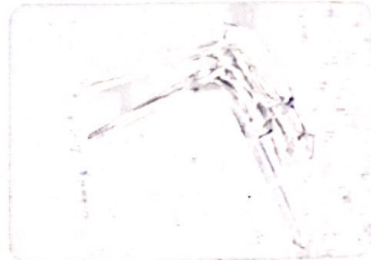

GT159-105 South Asian type Disposable Vaginal Speculum

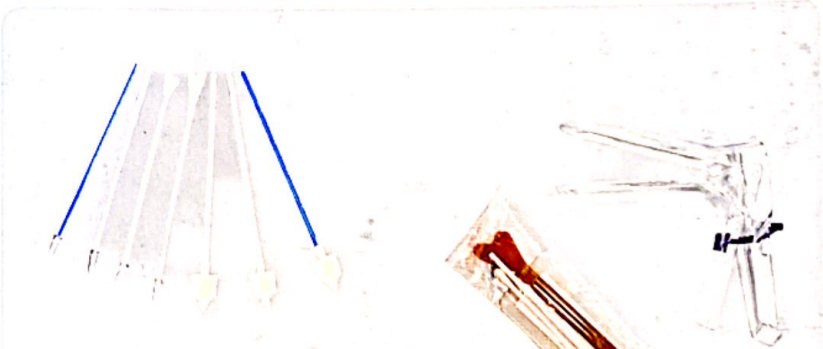

GT207-P22 Cervical Rambrush

Usage: Sampling Examination
For Male And Female
Material: Stainless Steel Thread + PVC Handle + Nylon Tip, PVC
Model: Slid Type, Injection Type
Packing: 1Pc/Pack, 100Packs/box.
50box/ 41 X 35 X 14cm, 13/12Kgs



GT138-117



GT138-118



GT138-119



GT138-120



GT138-121

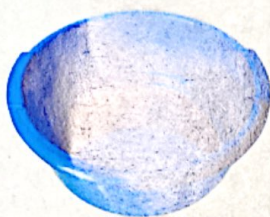

GT138-122

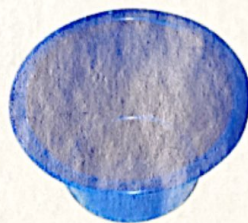

GT138-123



GT138-124



GT138-101



GT138-102



GT138-103



GT138-104



GT138-105



GT139-100

*Best service to all old and new clients!
Best greeting to all patients in the world!*

GT038-500
Scalp vein set

butterfly shaped wings for better handling and attachment to skin
siliconed cannula for smooth penetration
siliconed cannula for smooth penetration
tube length: 15-30cm
gauge 18g - 26g available
Color coded hub for size identification
Sterile by eto:
1pc/1poly bag 100pcs/1 box, 2000pcs/carton
Cartonsize: 56x25.5x37.5cm

GT033-100
Disposable Extension set

Three way-Stopcock with Extension Tube
Integrated Link Three ways stopcock facilitates the simultaneous administration of additional fluid from side port.

Fitted with male luer lock at one end for safe and secure connection and the three way stop cock at the other end.

Single Use, Sterile and non-Pyrogenic.
Packed in individual Blister Bag

Tube Length:

10-25cm	50pcs/ctn, Dimension: 72X56X32 cm
30-50cm	50pcs/ctn, Dimension: 72X56X32 cm
80cm	50pcs/ctn, Dimension: 72X56X32 cm
100-120cm	40pcs/ctn, Dimension: 72x56X32 cm

GT038-600

A.V.Needle

Mult size::15G,16G,17G,18G
Needle with bevel edge with internal and external siliconisation,Ultra thin wall, stainless steel needle with/without backeye, self highly kink resistant tube
Color code for size identification
300pcs/48x44x25.5cm

GT036-100
Disposable Blood bag

Features:

- 1.Anticoagulants: CPDA-1; SAGM
2. Single bag: 100ml-500ml
3. Double bag: 100ml-500ml
4. Triple bag: 100ml-500ml
5. Quadruple: 100ml-500ml

Packing: single package OPP Compound film bag, in lightproof aluminum foil
5pcs/aluminum foil



**GT103-100
Hot Water Bag**

Size: 750cc/1000cc/1750cc/2000cc
/2500cc/3000cc
Color: Blue, Green, Red
Material: PVC
Double Sided Trill, Single Sided Trill
Packing: 1pc/1 Pe Bag



**GT103-100
Hot water bag**

Size: 750cc/1000cc/1750cc/2000cc/2500cc/3000cc
Color: Blue, Green, Red
Material: Latex≥30%,
Bs Standard: latex≥50%,
Double Sided Trill, Single Sided Trill
Packing: 1pc/1 Pe Bag



Material: Polyurethane
Size: 750cc, 1000cc, 1750cc, 2000cc, 2500cc
Packing: individual one bag



**GT104-100
Ice Bag**

Size: 6"/9"/11"
Packing: PVC Box/PE Bag/Paper Box
Can be customized design.

**GT115-001
Instant Ice Pack**

280G, PE+PA, 23x14CM
160G, PE+PA, 19.5x12CM
100G, PE+PA, 15x11CM

Usage:

Find the liquid bag in the ice bag and make it broken and 3 seconds later it will be frozen. Then shake the bag up and down to make the content fully mixed, and the temperature will be depressed below zero by the ice bag in 2 minutes.

Purpose:

To control and alleviate the sore and pain caused by strain, bruise, pull and burn, also can rapidly remove the pain and discomfort induced by fever, headache, toothache, mosquito bite.
Freeze and keep fresh vegetable, fruit, beer, beverage and food and so on when no cold source available.

Precaution:

The ice bag can only be used for external medication. If eye or skin should contact the content, it must be washed by clean water thoroughly. If one eats the content by mistake, he must drink enough water, try his best to vomit it and turn to doctor when necessary.

In order to avoid a too low temperature, it should be better to wrap the ice bag with a towel or cotton cloth to begin with. Those who have something wrong with their circulation system should refer to doctor in advance.

Characteristic:

This product can refrigerate instantly without cold source and be easily used because of portability.

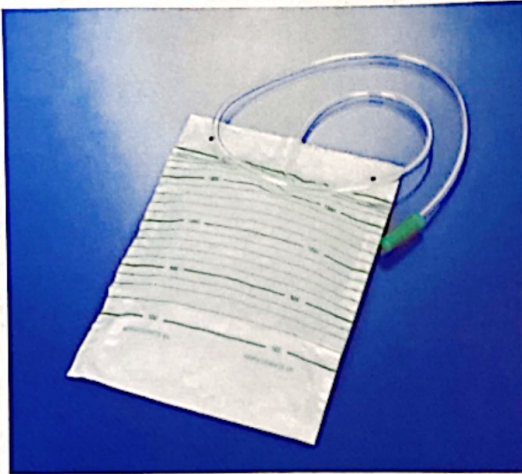

GT028-100

Economic Urinary Drainage Bag

Capacity: 2000ml
 Without bottom outlet; with 90cm inlet tube,
 with non-return valve,
 Sterilization: EO
 Packing: 1pc/PE bag, 250pcs/carton
 Measurement of carton: 52x32x36cm

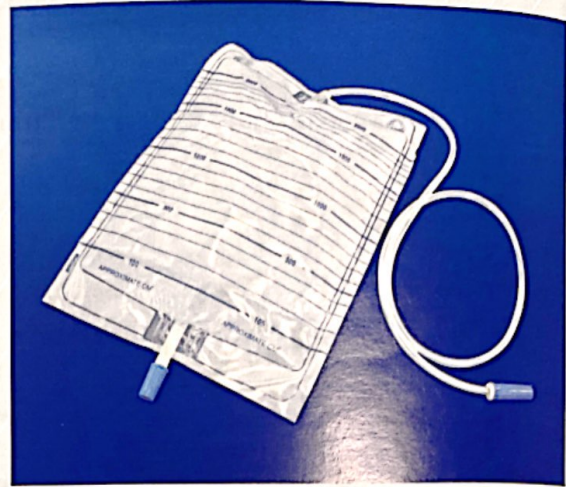

GT028-200

Economic Urinary Drainage Bag

Capacity: 2000ml
 with bottom outlet; with 90cm inlet tube;
 with non-return valve
 with pull-push valve
 Sterilization: EO
 Form of packing: 1pc/PE bag, 250pcs/carton
 Measurement of carton: 540x400x270mm

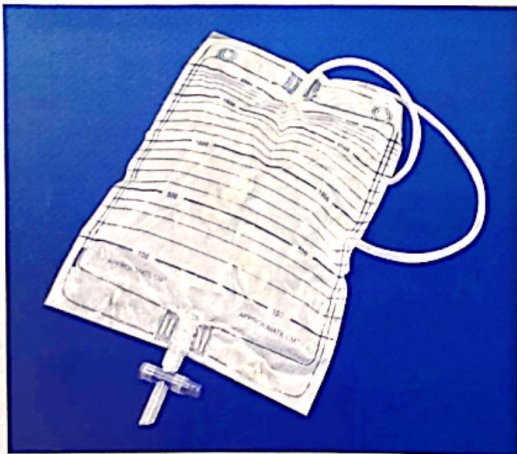

GT028-210

Economic Urinary Drainage Bag

Capacity: 2000ml
 With bottom outlet; with 90cm inlet tube;
 with non-return valve, with T valve
 Sterilization: EO
 Packing: 1pc/PE bag, 250pcs/carton
 Measurement of carton: 52x37x32cm



GT028-300

Luxury Urinary Drainage Bag

Capacity: 2000ml
 Type: square bottom, latex free, with pull push valve,
 with white sample port, with anti-reflux valve, with plastic tie
 Inlet tube: O.D 10mm; 100cm length
 Sterilization: EO
 Packing: 1pc/ PE or blister pack, 100pcs/carton,
 Measurement of carton: 54x36x32cm

Material: PP

Description: This product is a scleroid plastic container which is used for collecting the needles of the syringes, infusion sets and pointed instruments like blades, scalp vein sets, suture needle, small glass products, etc. This product is for single use and the medical waste put in it is not allowed to be taken out and must be recycled by the waste disposable unit of the hospital, and then safely and completely burned within 48 hours. The product has the characteristics of non-toxic, safe, cast-resistant, and non-leaky.



GT163-107

Capacity(L)	Pcs/ctn	Carton Size(cm)
1.5	60	38x38x39.5



GT163-108

Capacity(L)	Pcs/ctn	Carton Size(cm)
0.8	90	38x38x39.5

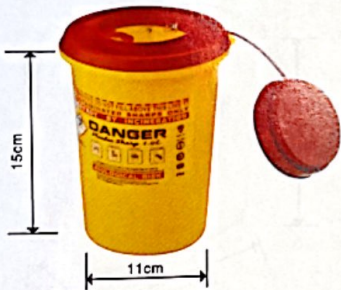

GT163-109

Capacity(L)	Pcs/ctn	Carton Size(cm)
1.0	100	47x36x57

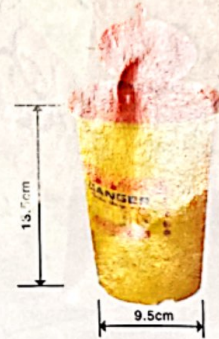

GT163-112

Capacity(L)	Pcs/ctn	Carton Size(cm)
0.7	100	56x24x43

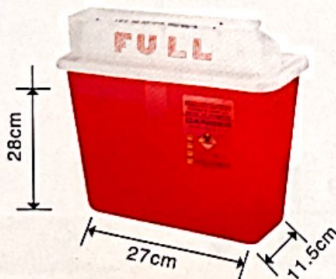

GT163-113

Capacity(L)	Pcs/ctn	Carton Size(cm)
4.6	20	58x56x28



GT163-114

Capacity(L)	Pcs/ctn	Carton Size(cm)
2.0	30	41x34x34

Sharp Container



GT163-101

Capacity(L)	Pcs/ctn	Carton Size(cm)
4.0	24	53x42x45



GT163-102

Capacity(L)	Pcs/ctn	Carton Size(cm)
3.0	30	47x32x45

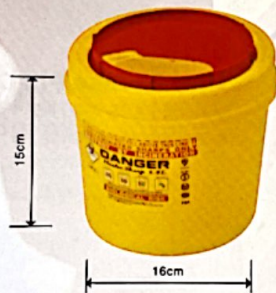

GT163-103

Capacity(L)	Pcs/ctn	Carton Size(cm)
3L	30	36x36x37

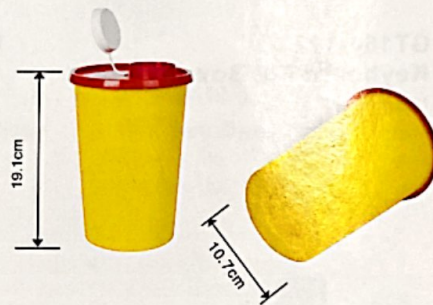

GT163-104

Capacity(L)	Pcs/ctn	Carton Size(cm)
2.0	36	45x30x34

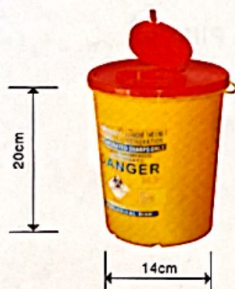

GT163-105

Capacity(L)	Pcs/ctn	Carton Size(cm)
2.0	40	58x29x29



GT163-106

Capacity(L)	Pcs/ctn	Carton Size(cm)
3.0	54	47x50x40

Sharp Container



GT163-115

Capacity(L)	Pcs/ctn	Carton Size(cm)
3.0	30	41x34x31.5



GT163-116

Capacity(L)	Pcs/ctn	Carton Size(cm)
6.0	24	51x42x34.5



GT163-117

Capacity(L)	Pcs/ctn	Carton Size(cm)
5.0	24	51x42x25.5



GT163-118

Capacity(L)	Pcs/ctn	Carton Size(cm)
23.0	20	48x39x65

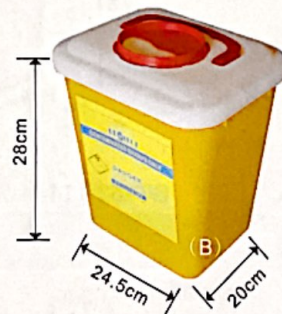
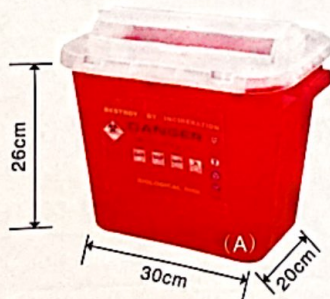

GT163-119

Capacity(L)	Pcs/ctn	Carton Size(cm)
10.0 (A)	12	52x25x73
10.0 (B)	24	51X42X54

Material: PP

Description: This product is a scleroid plastic container which is used for collecting the needles of the syringes, infusion sets and pointed instruments like blades, scalp vein sets, suture needle, small glass products, etc. This product is for single use and the medical waste put in it is not allowed to be taken out and must be recycled by the waste disposable unit of the hospital, and then safely and completely burned within 48 hours. The product has the characteristics of non-toxic, safe, cast-resistant, and non-leaky.



GT163-120

Capacity(L)	Pcs/ctn	Carton Size(cm)
8.0	24	44x38x44



GT163-121

Waste Bag

Color: Red/Yellow/Black
 Material: HDPE/LDPE, virgin or recycled
 Thickness: 40-150 microns per side
 Packaging: Roll packed, or loosed packed
 Primary packaging: labels, polybags
 Secondary packaging: Corrugated cardboard outer cartons, or PP woven bags
 Type: Open with adhesive tape, 61x61cm, 61x76cm, 61x80cm, 96.5x120cm
 Plain top without adhesive tape, 42x48+6cm, 19x26+5.6cm

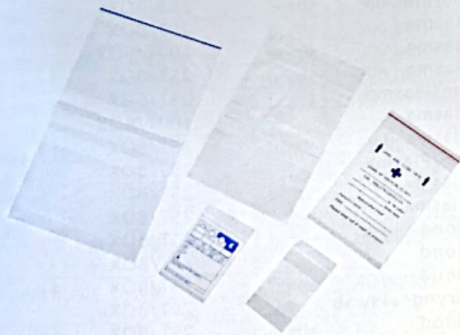

GT163-122

Specimen Bag

Material: VIRGIN LDPE
 Regular Size: 5.5"x6.5", 6"x9", 10"x10", or customized sizes
 Thickness: 40-100micron per side
 Advantages: 1.Superior quality and competitive price, waterproof and recyclable material.
 2.It is environmental protection and excellent quality
 3.very tough, Good stretchability, Flexibility.
 4.Timely delivery.
 5.Each inquiry will be consulted carefully.
 6. Easy to open and take.
 Packaging: By normal corrugated cardboard box, about the detail's as customize.
 Usually 100pcs/bag,10bags/ctn or 20bags/ctn



GT163-110 Paper Safety Box

75pcs/carton,
 62x30x258.5cm,
 20/18.5kgs



GT163-111

Needle Destroyer without blade 11x9.5cm
 Needle Destroyer with blade 11x9.5cm

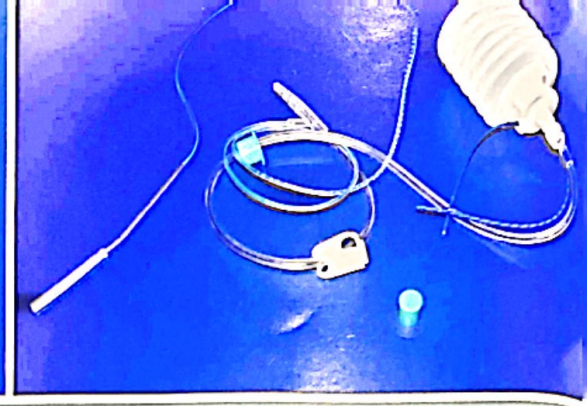

GT029-610

Closed Wound Drainage System (Spring)

1. This product includes 3-spring evacuator, PVC tubing, Y connector, PVC drainage tube and stainless steel trocar.
2. The design of 3-spring evacuator minimizes the Collapse-Resistance.
3. The PVC drainage tube inside can be replaced by our other silicone drains, if needed.

Size available : 200ml,400ml,800ml(8Fr, 10Fr,12Fr, 14Fr, 16Fr, 18Fr,20Fr,22Fr,24Fr)
Packed :Blister Bag

GT029-620

Closed Wound Drainage System (Hollow)

1. Aseptic PE material
 2. Hollow non-spring wound drainage reservoir with PVC drainage tube and trocar, hemi steel clamp and robot clamp.
- Size available : 200ml,400ml(8Fr, 10Fr,12Fr, 14Fr, 16Fr, 18Fr, 20Fr,22Fr,24Fr)
Packing :Blister Bag

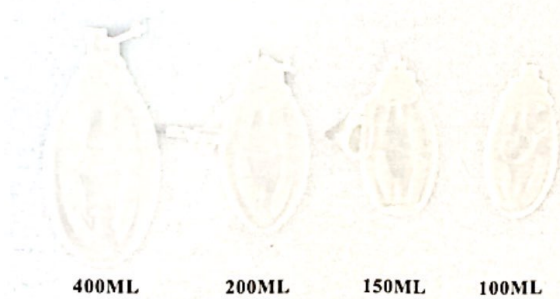

GT069-112

Silicone Reservoir

Made of medical grade silicone
Provided with internal anti-reflux valve
Bulb silicone walls provide easy activation of suction
Regular system is to be used together with silicone flat drains, but we also recommend innovative solutions which are combined with our round fluted drains or round perforated drains.
Size:100ml,150ml,200ml,400ml
Packing :Blister bag

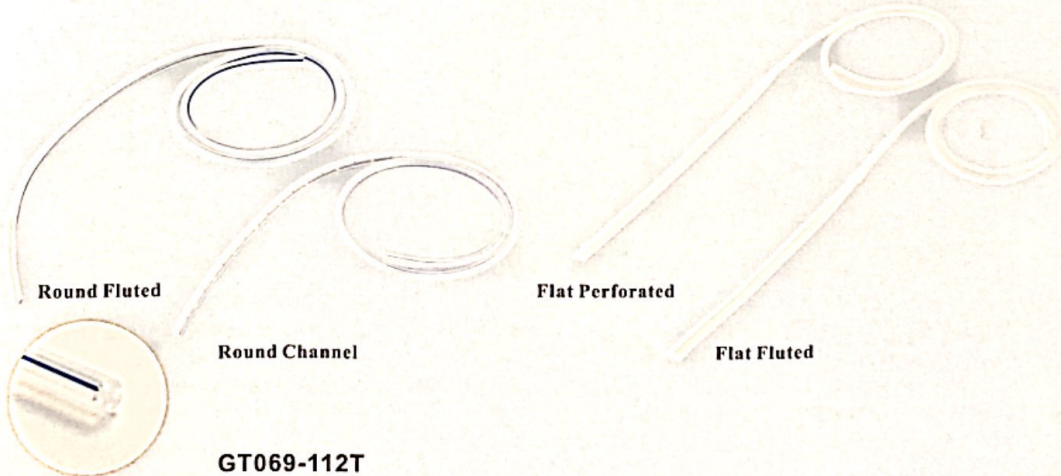

GT069-112T

Silicone Round Channel/Fluted Drains

Made of medical grade silicone
Utilize internal channels or fluted, to swiftly remove exudate Independent channels facilitate drainage and reduce risk of occlusion Made by one time, no connector ensures patients' comfort upon removal Radio-opaque line through the length for X-ray visualization
Available with or without "Three Face" stainless steel trocar
Size and length can be customized
Size:FR 10,FR 15,FR 19,FR 24,FR 28
Packing :Blister bag

Vaginal Speculum

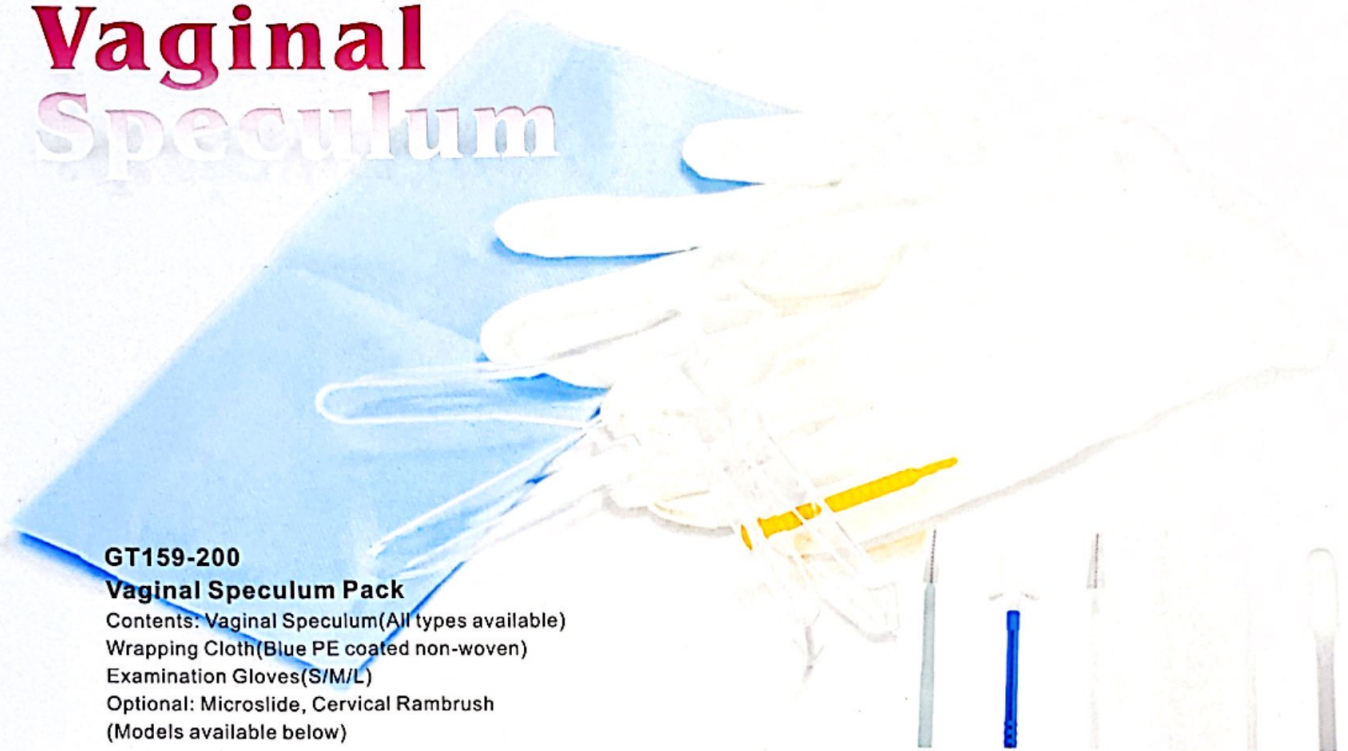

GT159-200

Vaginal Speculum Pack

Contents: Vaginal Speculum (All types available)
 Wrapping Cloth (Blue PE coated non-woven)
 Examination Gloves (S/M/L)
 Optional: Microslide, Cervical Rambrush
 (Models available below)



GT159-100 Disposable Vaginal Speculum with side screw
 Size: L, M, S



GT159-101 French type 1 Disposable Vaginal Speculum
 Size: L, M, S, XS, XXS



GT159-103 Disposable Vaginal Speculum with middle screw
 Size: L, L/M, M, S, XS

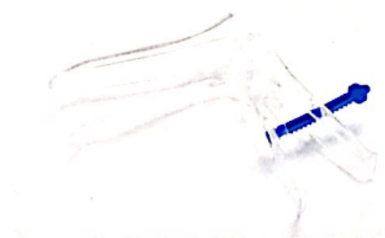

GT159-104 Disposable Vaginal Speculum Rack Type
 Size: L, M, S



GT159-106 American type Disposable Vaginal Speculum
 Size: L, M, S



GT159-104 Spanish Type Disposable Vaginal Speculum
 Size: L, M, S

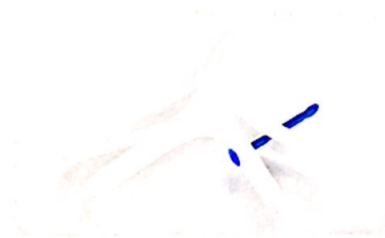

GT159-105 Disposable Vaginal Speculum With Smoke Extractor Type
 Size: L, M, S

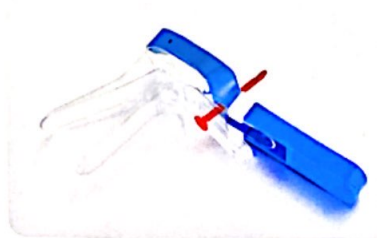

GT159-107 Handle Light Used with French Type Vaginal Speculum



GT159-108 Proctoscope Type: with light; without light
 Size: L, M, S

Anesthesia Kit



Accessories	800-E/S	800-E	800-S
Epidural needle	16G/18G 80mm/90mm	Same	800-S
Spinal needle	25G/27G / 113/123mm(Pencilpoint)		20G/22G
Epidural catheter	Pull-resistance length > 90cm	Same	
Epidural Catheter adapter	One	Same	
Liquid medicine filter	(blue)5 μ	Same	Same
Air filter	(Yellow)0.5μ	Same	
LOR Syringe	One Glass 5ml	Same	Same
Plastic Syringe	Two(3ml and 20ml)	1 pc 20ml	1 pc 5ml
negative pressure tube	one	one	
fenesrated sheet	60cm x 60cm hole 10cm	Same	Same
Small Nonwoven sheet	1 pc 50cm x 50cm	Same	Same
Big Nonwoven sheet	1pc 70cm x95cm	Same	Same
Catheter adhesive silce	One	Same	
Adhesive traps	One 5cm x 40cm , 2pc-1.25cm x 10cm	Same	
Compresses	Two 8 plyers 8cm x 10cm, one 5 x6 with cut	Same	Same
Sponge brush	Three(curving/Straight)	Same	Same
Surgical latex gloves	One pair 7.5/7.0/6.0	Same	Same
Syringe needle	One OD 0.5mm L20mm One OD 0.7mm L32mm One OD 1.6mm L38mm	Same	Same



GT012-300C Disposable PVC Manual Resuscitator

Color: Blue
 Single patient use only
 Built-in 60/40cm H₂O pressure relief valve
 The set includes oxygen reservoir bag, PVC mask and oxygen tubing
 100% Medical level PVC material
 Latex-free components
 Additional Accessories (Airway, mouth opener) and customized label are available
 Built-in 30mm exhale port for PEEP, Inlet Valve, or Manometer (Optional)
 Size: Adult / Pediatric / Infant
 Packing: PP Box / PE Bag / Paper Box

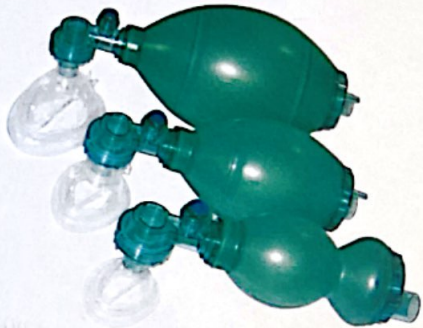

GT012-300B Disposable SEBS Manual Resuscitator

Color: Green
 Single patient use only
 Built-in 60/40cm H₂O pressure relief valve
 The set includes oxygen reservoir bag, PVC mask and oxygen tubing
 100% Medical level PVC material
 Latex-free components
 Additional Accessories (Airway, mouth opener) and customized label are available
 Built-in 30mm exhale port for PEEP, Inlet Valve, or Manometer (Optional)
 Size: Adult / Pediatric / Infant
 Packing: PP Box / PE Bag / Paper Box

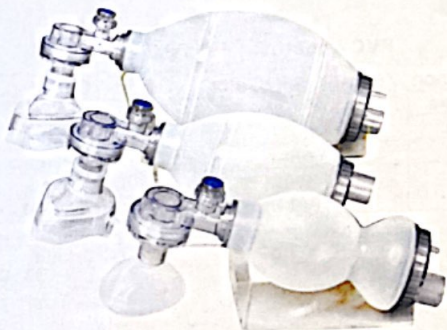

GT012-300A Disposable Silicone Manual Resuscitator

Color: Natural
 Autoclave to 134°C helping to prevent cross infection and contamination.
 Built-in 60cm H₂O pressure relief valve.
 Latex-free high grade medical silicone material.
 Guaranteed for 5 years or alternatively 20 times autoclave cycles.
 All-in-one intake valve connects to oxygen reservoir bag directly.
 Additional accessories (Airway, mouth opener) and customized label are available.
 Built-in 30mm exhale port for PEEP, Inlet Valve, or Manometer (Optional).
 Size: Adult / Pediatric / Infant
 Packing: PP Box / PE Bag / Paper Box



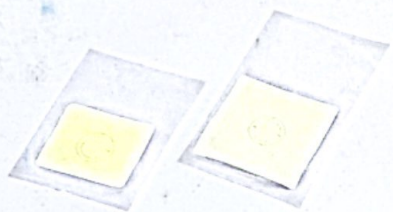

GT029-800

Disposable Colostomy Bag

Size: 20cm x 14cm, 25cm x 15cm
 Adhesive area: 10cm x 9cm, 12cm x 12cm
 Center opening: \varnothing 3cm
 Sterilization: EO
 Form of packing:
 20pc/PE bag, 5 bags/box, 20boxes/carton
 Measurement of carton:
 470x330x240mm(20cm x 14cm)
 580x350x240mm(25cm x 15cm)



GT029-900V

Disposable Enema Bag

Capacity: 1500ml
 Material: PVC
 Sterilization: EO
 Form of packing:
 1pc/PE bag, 200pcs/carton
 Measurement of carton:
 460x440x330mm

GT031-100

Disposable Enteral Feeding Bag Set

Size: 500ml, 1000ml, 1200ml
 Available for Pump Using and Gravity Using
 Packed in individual PE Bag
 30pcs/ctn,
 Dimension: 40X28X25cm

40080



GT031-500

Irrigation syringe

Flat: 80ml, 60ml
 Parts: Protector cap(PE), barrel(PP), piston(synthetic rubber), handspike(PP), two way(PP) 400pcs/58x44x46cm Ring: 60ml
 Parts: Protector cap(PE), barrel(PP), piston(synthetic rubber), handspike(PP), two way(PP) 250pcs/58x44x46cm
 Bulb: 50ml, 60ml Parts: Protector cap(PE), barrel(PP), bulb(PE), two way(PP) 50pcs/35x26x34cm



NEW STYLE OSTOMY BAG

Our ostomy bag are of excellent quality and advanced usage, making the wound healed in the good condition. Ostomy bag applications: collect excrement and urine after colostomy, ileostomy and urostomy.

Features:

- 1.The hydrocolloid skin barrier has the performance of anti-maceration, low allergy, and warping and leakage. It has excellent exudation-absorbent and long sticking ability(up to 7days).And it is soft and comfortable.
- 2.Hydrocolloid skin barrier combines with the highly permeable PU film makes it stick for a long time, no leakage of exudates, convenient to use.
- 3.The material of ostomy bag possesses high obstructing ability, it is comfortable and covert.
- 4.The one-piece system design discharge intestinal gas easily and filtering effect it excellent.

Simple type	Packing Reference:
Foam type	10pcs/bag, 400pcs/ctn
Glue Pan type	Size: 350x310x400mm
Two-piece type	G.W: 6kg N.W: 4.5kg

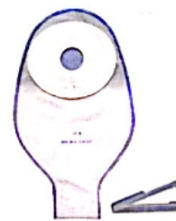

GT030-200 Simple Type



GT030-300 Foam Type



GT030-400 Glue Pan Type



GT030-500 Two-piece Type



GT030-600 Foam Type



GT030-700 Two-piece Type

Foley Catheter

Made from natural latex

Silicone coated

Available with the option of plastic valve or rubber valve

Colour-coded for visualisation of size



GT022-200 2-way Latex Foley Catheter

Made from natural latex

Silicone coated

Plastic valve or Rubber valve is available

Colour-coded for visualization of size

Length: 400mm

Size Fr16-Fr26 Balloon Capacity:3cc/5cc

packing:Blister Bag

GT022-200-100 Silicone Coated Balloon Capacity:5cc/10cc/30cc

packing:Blister Bag

GT022-200-200 Silicone Coated Balloon Capacity:10cc/30cc

packing:Blister Bag

10pcs/box 100cc/30cc, Dimension: 12X43X47.5 cm



GT022-300 3-Way latex Foley Catheter

Made from natural latex

Silicone Coated

Plastic valve or Rubber valve is available

Used for clinical urine catheterition, injection and irrigation.

Length: 400mm

Size

Balloon Capacity

Fr16-Fr26 30cc

packing:Blister Bag



GT022-400 2-Way Female Foley Catheter

Made from natural latex

Silicone Coated

Plastic valve or Rubber valve is available

Used for clinical urine catheterition of Female

Length: 260mm

Size

Balloon Capacity

Fr12-Fr26 30cc

packing:Blister Bag



GT022-500 2-Way Tiemann Foley Catheter

Made from natural latex

Silicone Coated

Plastic valve or Rubber valve is available

Used for clinical urine catheterition of male

Length: 260mm

Size

Balloon Capacity

Fr12-Fr26 30cc

packing:Blister Bag



GT022-100
Urethral Catheter

Made from natural latex
Silicone Coated
Plastic valve or Rubber valve is available
Used for clinical urine catheterisation
Red Latex / Yellow Latex
Size Length
Fr8-Fr10 270mm
Fr12-Fr30 400mm



GT023-100
Malecot Catheter

Made from Natural Latex; Silicone Coated; Length: 400mm; Used for Clinical bladder fistula operation urethral catheterisation;
10pcs/box, 200pcs/carton
Red Latex / Yellow Latex
FR14-FR32, FR12 and FR34-FR42 are also available for customer requests
Packing: Individual Blister Bag



GT022-900
2-Way All Silicone Foley Catheter

Made from high quality 100% silicone, medical grade
With X-ray or without is available
Fr8-Fr10 (Pediatric)
Length: 310mm Balloon Capacity: 3cc/5cc
Fr12-Fr (Standard)
Length: 400mm Balloon Capacity: 5cc/10cc
Fr16-Fr24 (Standard)
Length: 400mm Balloon Capacity: 5cc/10cc/30cc
Packed in individual Blister bag
100pcs/box, 500pcs/ctn, Dimension: 52X43X47.5cm



GT022-200S
Super Lubricating Foley Catheter

Made from Natural Latex; Available with the option of plastic valve or rubber valve; Easy for insertion and hydrophilic coating to reduce the stimulation to mucous membrane of the urethra.
Type: Single way; 2-way; 3-way; 2-way Female; 2-way Tiemann;
size: Fr8-24 (Single way)
Fr8-24 (2-way)
Fr16-24 (3-way)
packing: Individual Blister Bag

GT022-900T
Disposable All Silicone Foley Catheter with Temperature Sensor

Made from High quality 100% silicone, medical grade;
With X-ray or without is available;
Detect temperature in the bladder,
temperature range: 25°C-44°C, Accuracy: ±0.1°C
Length: 400mm; Balloon Capacity: 3ml/5ml/10ml/15ml/30ml
Fully compatible with most monitors. Temperature extension cable is available.
Note: Do not pull hardly the Temperature measurement cord during using.
Size: Fr8-24 (Color coded)
Packing: Individual Blister Bag

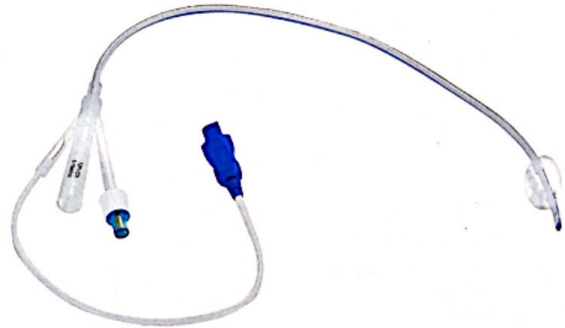

GT022-200T
Self-Catheterization System

Made from Non-toxic, Non-irritant soft Medical grade PVC; DEHP free is available; Component: Intermittent Catheter; PVC Gloves; Collection bag; Moisture-proof underpad; PVP Swabsticks (3/pkt), sterile.
Features: Closed system specially designed reducing risk of contamination. The catheter and introducer are coated with a water soluble lubricant for ease of insertion. Catheter Guide allows for simple, protected control of catheter during insertion. 1500ml collection bag eliminates the need for separate container, reducing the chance of spillage.
Size: Fr6-18 (Color coded)
Packing: Individual Blister Bag





GT022-600
3-Way Double Balloons
Foley Catheter

Made from natural latex
Silicone coated
Color-coated for visualization of size
Fr16-Fr24
Length:400mm Balloon Capacity:30cc(front) / 50cc(rear)
Packed in individual Blister bag
10pcs/box, 500pcs/ctn, Dimension:52X43X47.5cm

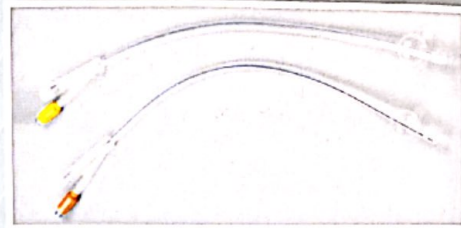
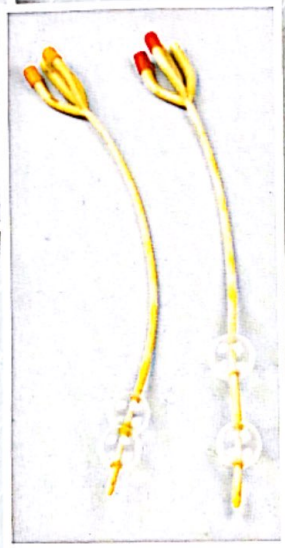

GT022-900
2-Way All Silicone Foley Catheter

Made from high quality 100% silicone, medical grade
With X-ray or without is available
Fr8-Fr10 (Pediatric)
Length:310mm Balloon Capacity:3cc/5cc
Fr12-Fr14 (Standard)
Length:400mm Balloon Capacity:5cc/10cc
Fr16-Fr24 (Standard)
Length:400mm Balloon Capacity:5cc/10cc/30cc
Packed in individual Blister bag
10pcs/box, 500pcs/ctn, Dimension:52X43X47.5cm

GT022-700
4-Way Double Balloons Foley Catheter

Made from natural latex
Silicone coated
Color-coated for visualization of size
Type A:
Fr16-Fr24
Length:400mm Balloon Capacity: 30cc(front) / 50cc(rear)
Type B:
Fr16-Fr24
Length:400mm Balloon Capacity: 50cc(front) / 30cc(rear)
Packed in individual Blister bag
10pcs/box, 500pcs/ctn, Dimension:52X43X47.5cm

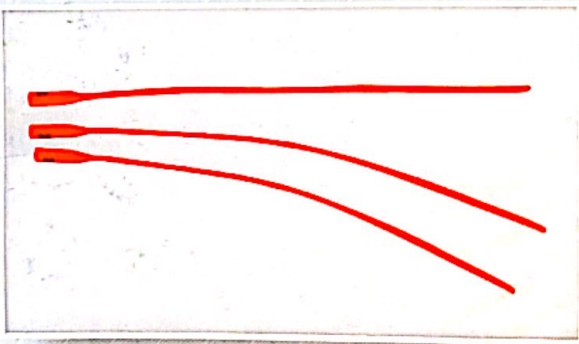

GT022-100
Urethral Catheter (Red Latex)

Made from natural latex
Silicone coated
Fr6-Fr24
Length:400mm
Packed in individual Blister bag
10pcs/box, 500pcs/ctn,
Dimension:52X43X47.5cm

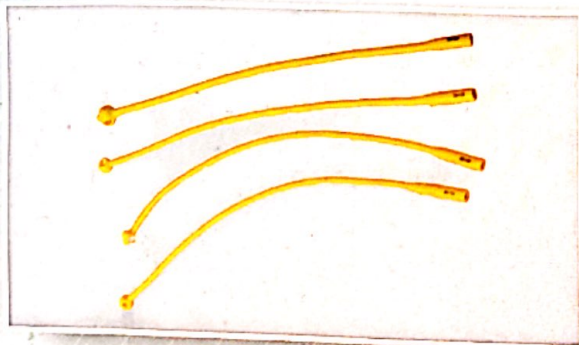

GT023-100
Malecot Catheter

Made from natural latex
Silicone coated
Fr14-Fr36
Length:400mm
Packed in individual Blister bag
10pcs/box, 500pcs/ctn,
Dimension:52X43X47.5cm

Foley Catheter

Made from natural latex

Silicone coated

Available with the option of plastic valve or rubber valve

Colour-coded for visualisation of size



GT022-200 2-way Latex Foley Catheter

Made from natural latex

Silicone coated

Plastic valve or Rubber valve is available

Color-coated for visualization of size

Fr6-Fr10 (Pediatric)

Length:270mm Balloon Capacity:3cc/5cc

Fr12-Fr22 (Standard)

Length:400mm Balloon Capacity:5cc/10cc/30cc

Fr24-Fr26 (Standard)

Length:400mm Balloon Capacity:10cc/30cc

Packed in individual Blister bag

10pcs/box, 500pcs/ctn, Dimension:52X43X47.5 cm

Medical Tubes

NINGBO GREETMED MEDICAL INSTRUMENTS CO.,LTD.
 WEB: <http://www.greetmed.com> E-MAIL: info@greetmed.com

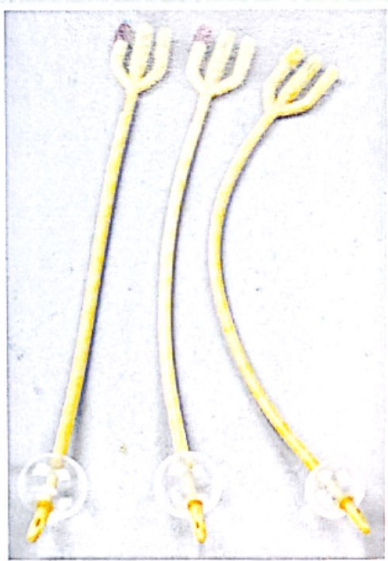

GT022-300

3-Way Latex Foley Catheter

Made from natural latex

Silicone coated

Plastic valve or Rubber valve is available

Color-coated for visualization of size

Fr16-Fr26 (Standard)

Length:400mm Balloon Capacity:30cc

Packed in individual Blister bag

10pcs/box, 500pcs/ctn,

Dimension:52X43X47.5 cm

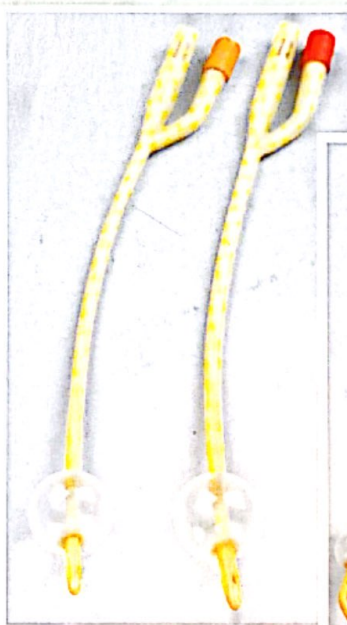

GT022-400

2-Way Female Foley Catheter

Made from natural latex

Silicone coated

Plastic valve or Rubber valve is available

Color-coated for visualization of size

Fr12-Fr22

Length:240mm, Balloon Capacity:5cc/10cc/30cc

Fr24-Fr26

Length:240mm, Balloon Capacity:10cc/30cc

Packed in individual Blister bag

10pcs/box, 500pcs/ctn,

Dimension:52X43X47.5cm



GT022-500

2-Way Tiemann Foley Catheter

Made from natural latex

Silicone coated

Plastic valve or Rubber valve is available

Color-coated for visualization of size

Fr12-Fr22

Length:400mm Balloon Capacity:5cc/10cc/30cc

Fr24

Length:400mm Balloon Capacity:10cc/30cc

Packed in individual Blister bag

10pcs/box, 500pcs/ctn,

Dimension:52X43X47.5cm



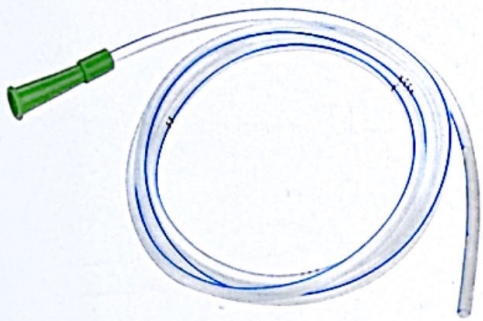

GT019-100 PVC Stomach Tube

Made from non-toxic, non-irritant soft PVC.
 DEHP-FREE is available.
 Printed with graduation.
 Color coded for size identification
 With X-ray or without is available
 Size: Standard Tube Length : 120cm
 Sterilization:EO
 Size: Fr6-Fr26
 packing:Blister Bag / PE Bag



GT019-100B 100% Silicone Stomach Tube

Made of non-toxic, non-irritant 100% silicone
 Color: Transparent or translucent(Surface fog form)
 Provision of four eye-holes for efficient aspiration
 With X-ray line
 Tube length: 120cm
 Sterilization:EO
 Size: Fr6-Fr20
 Packing:Blister Bag

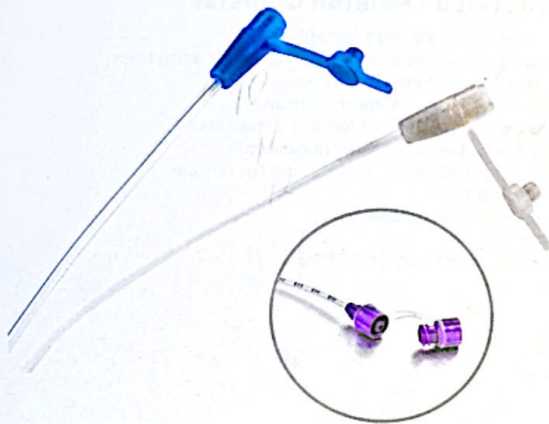

Luer Lock Connector

GT019-100 Feeding Tube

Made from non-toxic, non-irritant soft PVC.
 DEHP-FREE is available.
 Color coded for size identification
 With X-ray or without is available
 Size: Fr4-Fr8 Tube Length: 40cm
 Size: Fr10-Fr22 Tube Length: 120cm
 packing:Blister Bag / PE Bag



GT019-100D Ryle's Tube

Made of non-toxic, non-irritant PVC(Medical grade), or DEHP free or 100% silicone.
 Color: Transparent or translucent(surface fog form).
 With X-ray detectable thread.
 With metal ball.
 Connector(color coded)-Size(Fr/Ch):
 F6, F8, F10, F12, F14, F16, F18, F20, F22.
 Package: Single in PE or blister package.
 Sterilized by EO GAS.

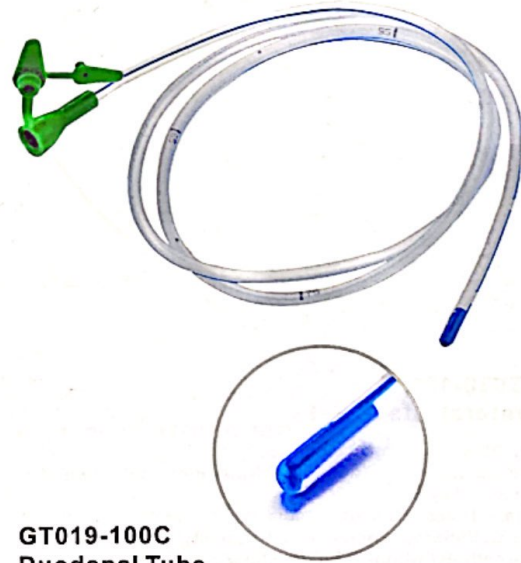

GT019-100C Duodenal Tube

Made of non-toxic, non-irritant PVC(Medical grade), or DEHP free or 100% silicone.
 Color: Transparent or translucent(surface fog form).
 With X-ray detectable thread.
 Closed distal end with four lateral eyes.
 Connector(color coded)-Size(Fr/Ch):
 F6, F8, F10, F12, F14, F16, F18, F20, F22.
 Package: Single in PE or blister package.
 Sterilized by EO GAS.



**GT129-100
Cervical Scraper (wooden)**

1pc/paper wrap, 100pcs/box
Non-sterile: 100pcs/box



**GT128-100 Wooden Tongue Depressor
GT128-200 Plastic Tongue Depressor**

Size Adult: 150mmx18mmx1.6mm
Sterile: Single Medical Paper Wrapped,
1pc/paper wrap, 100pcs/box
Non-sterile: 100pcs/box
Size Child: 140x14x1.6mm
Sterile: Single Medical Paper Wrapped,
1pc/paper wrap, 100pcs/box
Non-sterile: 100pcs/box

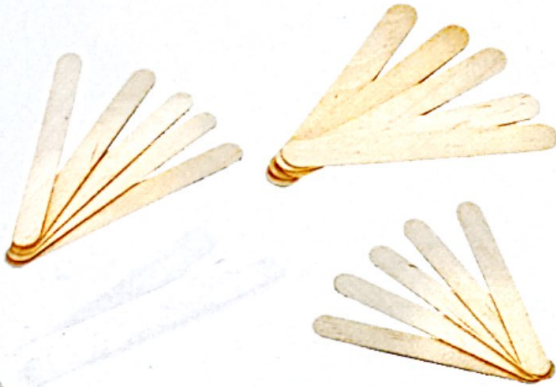

**GT148-203
Lubricating Jelly Series**

Name	Package	Amount/Unit	Units/Case
Lubricating Jelly 3g	Bag	144/bx	12/cs
Lubricating Jelly 5g	Bag	144/bx	12/cs
Lubricating Jelly 5g	Tube	144/bx	4/cs
Lubricating Jelly 42g	Tube	12/bx	6/cs
Lubricating Jelly 57g	Tube	12/bx	6/cs
Lubricating Jelly 82g	Tube	12/bx	6/cs
Lubricating Jelly 113g	Tube	12/bx	6/cs
Lubricating Jelly 1.0oz	Bag	20/bx	18/cs

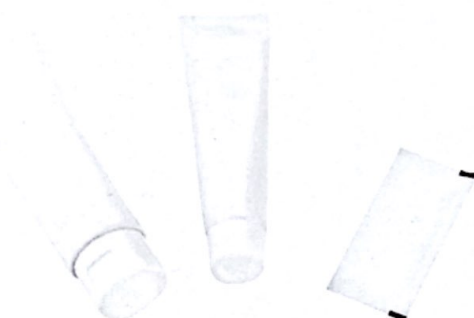

GT113-100 Condom

Surface: smooth, dotted, ribbed lubricated
Size: 49mm, 52mm, 55cm

Be available with spermicide nonoxynol

Be available with various fruit smell

If quantity is large enough, the condom is available with various color
Specification is available with En600, ISO4074, ASTM, WHO, SABS, etc.