

SURGICAL HEART THERAPIES PRODUCT CATALOG

- > Heart Valves
- > Surgical Ablation
- > Revascularization

INTERNATIONAL

CAUTION: For distribution only in markets where the products have been approved.

Medtronic
Further, Together

Table of Contents

Heart Valves

- 3-4 | Freestyle™ Aortic Root Bioprosthesis
- 5-6 | Hancock™ II Bioprosthetic Valve
- 7-8 | Mosaic™ Bioprosthesis
- 9-10 | Medtronic Open Pivot™ Mechanical Heart Valves
- 11-12 | Contegra™ Pulmonary Valve Conduit
- 13-14 | Hancock™ Bioprosthetic Valved Conduit
- 15-16 | CG Future™ Semi-Rigid Annuloplasty Ring and Band
- 17-18 | Contour 3D™ Tricuspid Annuloplasty Ring
- 19-20 | Duran AnCore™ Flexible Annuloplasty Ring and Band
- 21-22 | Profile 3D™ Rigid Annuloplasty Ring
- 23-24 | Simplici-T™ Flexible Annuloplasty Band
- 25-26 | Simulus™ Flexible Annuloplasty Ring and Band
- 27-28 | Simulus™ Semi-Rigid Annuloplasty Ring and Band
- 29-30 | Tri-Ad™ Adams Tricuspid Annuloplasty Ring
- 31-32 | Streamline™ Temporary Pacing Leads

Surgical Ablation

- 33-34 | Cardioblate™ iRF Surgical Ablation System
- 35-36 | CyroFlex™ Surgical Ablation System

Revascularization

- 37-38 | OPCAB Conventional Beating Heart Surgery
- 39-40 | Minimally Invasive Cardiac Surgery MICS CABG
- 41-42 | OPCAB Accessories Enabling Technologies

Freestyle™ Aortic Root Bioprosthesis

A stentless valve that is naturally designed to maximize flow, particularly for young patients.

TABLE OF CONTENTS

HEART VALVES

SURGICAL ABLATION

REVASCULARIZATION

Page | 3

Superior Hemodynamics^{1,2,3}

Intelligently Designed

- Functions like a native valve with low gradients and laminar flow¹
- Absence of stent and sewing ring leaves more room for blood to flow through the valve; improves postoperative coronary flow more than a stented bioprosthesis^{2,3}

Maximum Flow

- Designed to function like a native valve with physiologic hemodynamics
- Excellent mean pressure gradients and EOAs out to 10 years⁴
- Strong clinical outcomes and excellent durability at 15 years⁴

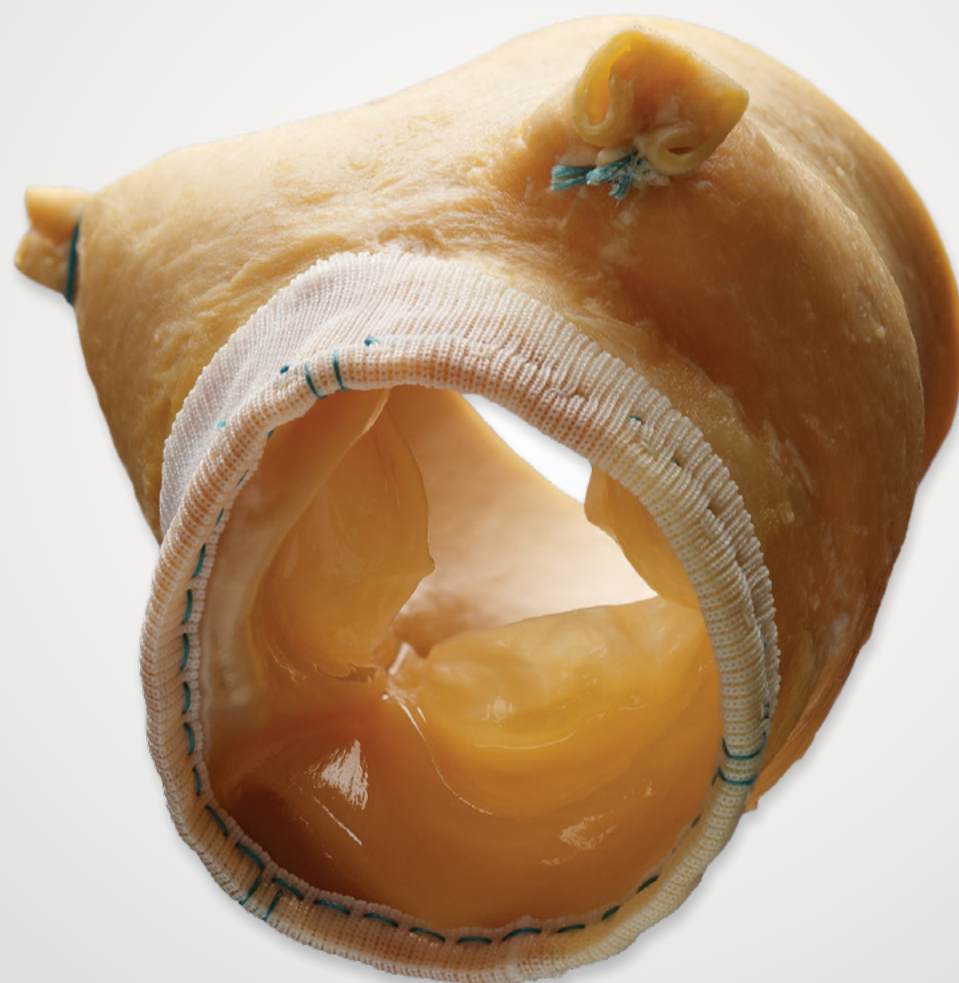

References

1. Westaby S., et al. Valve replacement with a stentless bioprosthesis: Versatility of the porcine aortic root. *J Thorac Cardiovasc Surg* 1998;116:477-84.
2. Bakhtiary F, et al. Stentless bioprostheses improve postoperative coronary flow more than stented prostheses after valve replacement for aortic stenosis. *J Thorac Cardiovasc Surg* 2006;131:883-8.
3. Silberman S, et al. Exercise hemodynamics of aortic prostheses: Comparison between stentless bioprostheses and mechanical valves. *Ann Thorac Surg* 2001;72:1217-21.
4. Freestyle Aortic Root Bioprosthesis 15-year clinical compendium 2012 ©Medtronic.



Freestyle™ Aortic Root Bioprosthesis

A stentless valve that is naturally designed to maximize flow, particularly for young patients.

TABLE OF CONTENTS

HEART VALVES

SURGICAL ABLATION

REVASCULARIZATION

Page | 4

Freestyle Full Root Bioprosthesis

Order Number	Size (mm)	A Outside Diameter (± 0.2mm)	B Profile Height (± 2mm)	C Inner Cloth Height (±0.5mm)
FR99519	19	19.0	30	3.0
FR99521	21	21.0	32	3.0
FR99523	23	23.0	32	3.0
FR99525	25	25.0	34	3.0
FR99527	27	27.0	34	3.0
FR99529	29	29.0	39±0.3	3.0

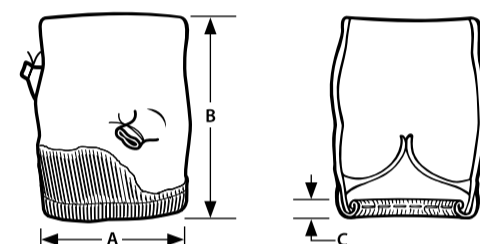

Prestyled Freestyle Complete Subcoronary Bioprosthesis

Order Number	Size (mm)	A Outside Diameter (+0.5mm - 0.0mm)
995CS19	19	19.0
995CS21	21	21.0
995CS23	23	23.0
995CS25	25	25.0
995CS27	27	27.0
995CS29	29	29.0

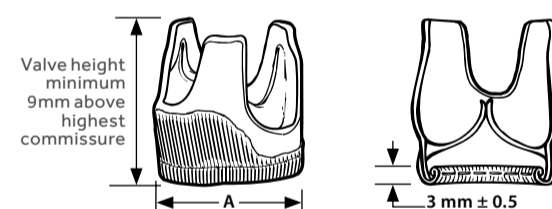

Prestyled Freestyle Modified Subcoronary Bioprosthesis

Order Number	Size (mm)	A Outside Diameter (+0.5mm - 0.0mm)
995MS19	19	19.0
995MS21	21	21.0
995MS23	23	23.0
995MS25	25	25.0
995MS27	27	27.0
995MS29	29	29.0

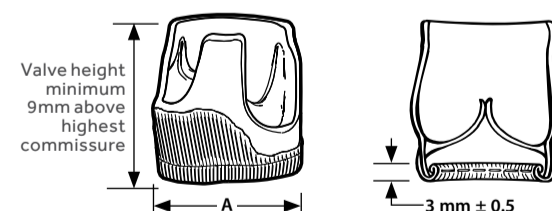

Freestyle Valve Accessories

Order Number	Description
T7625FR	Freestyle Accessory Tray
7639	Handle (234mm length) pliant, without locknut to be used with Freestyle bioprosthesis
7639XL	Handle (368mm length) pliant, without locknut to be used with Freestyle bioprosthesis
7990SET	Freestyle Obturator Set (no handles)

Hancock™ II Bioprosthetic Valve

The valve that has stood the test of time to make outcomes as predictable as procedures.

TABLE OF CONTENTS

HEART VALVES

SURGICAL ABLATION

REVASCULARIZATION

Page | 5

The Standard For Reliability and Consistency

- Proven durability in all patients, especially those ≥ 60 years of age^{1,2}
- Highly studied surgical valve delivering strong results and consistent outcomes from multiple centers^{1,3}
- More than 97% freedom from SVD after 20 years for patients ≥ 65 years of age¹
- Radiopaque for future valve-in-valve procedures
- Optimal performance and value



References

1. David T, et al. Hancock II Bioprosthesis for aortic valve replacement: The gold standard of bioprosthetic valves durability. *Ann Thorac Surg* 2010;90: 775-81.
2. Borger M, et al. Twenty year results of the Hancock II bioprosthesis. *Journal of Heart Valve Disease*. January 2006;15:49-56.
3. Valfre C, et al. The fate of Hancock II porcine valve recipients 25 years after implant. *European Journal of Cardio-Thoracic Surgery*. 2010;28:141-6.



Hancock™ II

Bioprosthetic Valve

The valve that has stood the test of time to make outcomes as predictable as procedures.

TABLE OF CONTENTS

HEART VALVES

SURGICAL ABLATION

REVASCULARIZATION

Page | 6

Hancock II Aortic Heart Valve

Order Number	A Valve Size (Stent O.D.†)	B Orifice Diameter (Stent I.D.)	C Suture Ring Diameter	D Valve Height	E Aortic Protrusion
	(±0.5mm)	(±0.5mm)	(±1mm)	(±0.5mm)	(±0.5mm)
T505C221	21	18.5	27.0	15.0	12.0
T505C223	23	20.5	30.0	16.0	13.5
T505C225	25	22.5	33.0	17.5	15.0
T505C227	27	24.0	36.0	18.5	15.5
T505C229	29	26.0	39.0	20.0	16.0

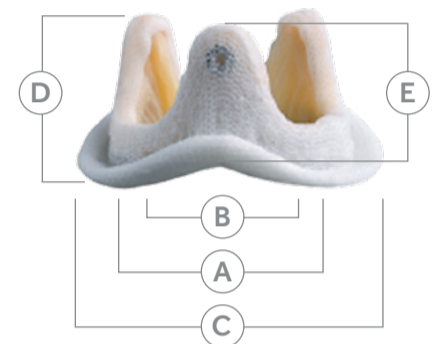

Hancock II Ultra™ Aortic Heart Valve

Order Number	A Valve Size (Stent O.D.†)	B Orifice Diameter (Stent I.D.)	C Suture Ring Diameter	D Valve Height	E Aortic Protrusion
	(±0.5mm)	(±0.5mm)	(±1mm)	(±0.5mm)	(±0.5mm)
T505U221	21	18.5	26.0	15.0	12.0
T505U223	23	20.5	28.0	16.0	13.5
T505U225	25	22.5	30.0	17.5	15.0
T505U227	27	24.0	32.0	18.5	15.5
T505U229	29	26.0	34.0	20.0	16.0

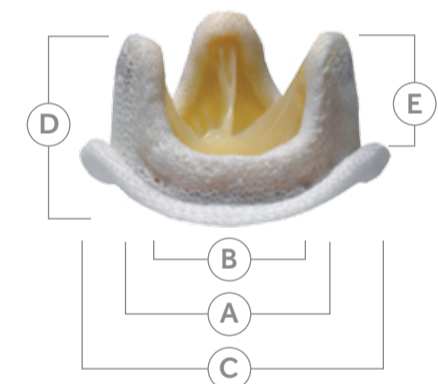

Hancock II Mitral Heart Valve

Order Number	Valve Size (Stent O.D.†) A	Orifice Diameter (Stent I.D.) B	Suture Ring Diameter C	Valve Height D	Ventricular Protrusion E
	(±0.5mm)	(±0.5mm)	(±1mm)	(±0.5mm)	(±0.5mm)
T510C25	25	22.5	33.0	18.0	13.5
T510C27	27	24.0	35.0	19.0	14.0
T510C29	29	26.0	38.0	20.5	15.5
T510C31	31	28.0	41.0	22.0	17.0
T510C33	33	30.0	43.0	23.0	17.5

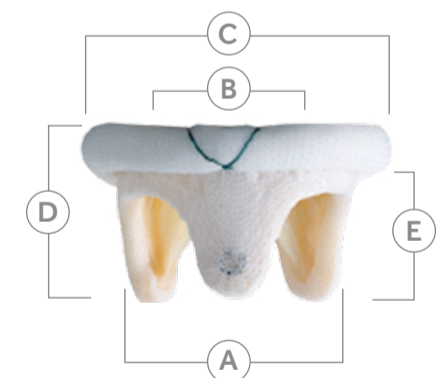

Hancock II Tissue Valve Accessories

Order Number	Description
T7610HKA	Tray, Accessory, Hancock II, Aortic
T7610HKM	Tray, Accessory, Hancock II, Mitral
T7505UX	Tray, Accessory, Hancock II Ultra, Supra-X Aortic Sizer Set
7505UX	Hancock II Ultra, Supra-X Aortic Sizer Set
7639	Handle (234mm length) pliant, without locknut handle to be used with Hancock II, Hancock II ULTRA prostheses
7639XL	Handle (368mm length) pliant, without locknut handle to be used with Hancock II, Hancock II ULTRA prostheses
7505SET	Hancock II Aortic Obturator Set (no handles, no tray)
7510SET	Hancock II Mitral Obturator Set (no handles, no tray)

† Equivalent to annulus diameter

Mosaic™ Bioprosthesis

A versatile platform designed to easily facilitate aortic or mitral valve replacement in open or minimally invasive procedures.

TABLE OF CONTENTS

HEART VALVES

SURGICAL ABLATION

REVASCULARIZATION

Page | 7

Undeniably Durable

- Designed to facilitate aortic and mitral valve replacement in open or minimally invasive procedures
- 80% freedom from explant due to SVD at 16 years in the mitral position¹
- 81% freedom from explant due to SVD at 17 years in the aortic position²



References

1. Medtronic Mosaic Mitral Bioprosthesis 16-year Clinical Compendium. ©2016 Medtronic.
2. Medtronic Mosaic Aortic Bioprosthesis 17-year Clinical Compendium. ©2016 Medtronic.

Mosaic™ Bioprosthesis

A versatile platform designed to easily facilitate aortic or mitral valve replacement in open or minimally invasive procedures.

TABLE OF CONTENTS

HEART VALVES

SURGICAL ABLATION

REVASCULARIZATION

Page | 8

Mosaic Aortic Valve, Model 305

Order Number	A Valve Size (Stent O.D.†)	B Orifice Diameter (Stent I.D.)	C Suture Ring Diameter	D Valve Height	E Aortic Protrusion
	(±0.5mm)	(±0.5mm)	(±1mm)	(±0.5mm)	(±0.5mm)
305C219	19	17.5	25.0	13.5	11.0
305C221	21	18.5	27.0	15.0	12.0
305C223	23	20.5	30.0	16.0	13.5
305C225	25	22.0	33.0	17.5	15.0
305C227	27	24.0	36.0	18.5	15.5
305C229	29	26.0	39.0	20.0	16.0

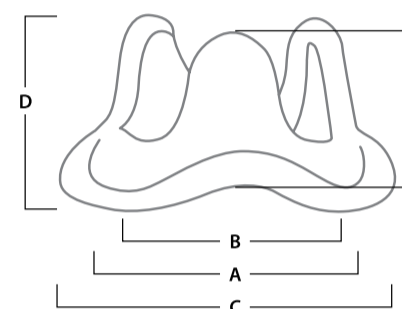

Mosaic Ultra Aortic Valve, Model 305

Order Number	A Valve Size (Stent O.D.†)	B Orifice Diameter (Stent I.D.)	C Suture Ring Diameter	D Valve Height	E Ventricular Protrusion
	(±0.5mm)	(±0.5mm)	(±1mm)	(±0.5mm)	(±0.5mm)
305U219	19	17.5	24.0	13.5	11.0
305U221	21	18.5	26.0	15.0	12.0
305U223	23	20.5	28.0	16.0	13.5
305U225	25	22.5	30.0	17.5	15.0
305U227	27	24.0	32.0	18.5	15.5
305U229	29	26.0	34.0	20.0	16.0

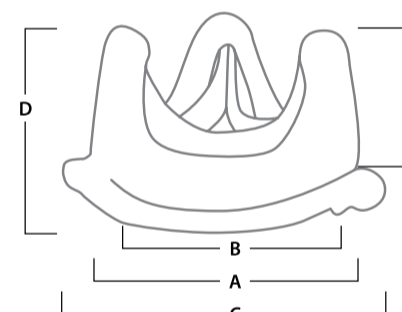

Mosaic Mitral Valve, Model 310

Order Number	A Valve Size (Stent O.D.†)	B Orifice Diameter (Stent I.D.)	C Suture Ring Diameter	D Valve Height	E Ventricular Protrusion
	(±0.5mm)	(±0.5mm)	(±1mm)	(±0.5mm)	(±0.5mm)
310C25	25	22.5	33.0	18.0	13.5
310C27	27	24.0	35.0	19.0	14.0
310C29	29	26.0	38.0	20.5	15.5
310C31	31	28.0	41.0	22.0	17.0
310C33	33	30.0	43.0	23.0	17.5

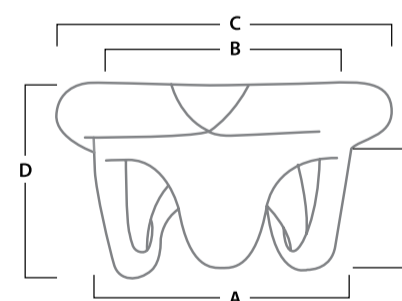

Mosaic Bioprosthesis Accessories

Order Number	Description
T7308C	Mosaic Aortic Sizers
T7615MSM	Tray, Accessory, Mosaic, Mitral
T7308U	Tray, Accessory, Mosaic Ultra Aortic
7308U	Mosaic Ultra Aortic Sizers
7639	Handle (234mm length) pliant, without locknut to be used with Mosaic or Mosaic Ultra prostheses
7639XL	Handle (368mm length) pliant, without locknut to be used with Mosaic or Mosaic Ultra prostheses
7308C	Mosaic Aortic Sizer Set (no handles, no tray)
7310	Mosaic Mitral Obturator Set (no handles, no tray)

† Equivalent to annulus diameter

Medtronic Open Pivot™ Mechanical Heart Valves

Optimal performance with excellent quality of life benefits.

TABLE OF CONTENTS

HEART VALVES

SURGICAL ABLATION

REVASCULARIZATION

Page | 9

Fundamentally Different Design

- Unique axis of suspension results in leaflet movement responsive to physiological demands
- Gentle, passive washing ensures complete washing of the pivot in both open and closed positions

Quiet

- Most patients cannot hear the sound of their valve after implantation¹
- Low levels of hemolysis and thromboembolic events^{2,3}
- Orifice design and unique leaflet movement result in excellent EOAs, even in small sizes^{4,5}



References

1. Sezai A, et al. Evaluation of valve sound and its effects on ATS prosthetic valves in patients' quality of life. *Ann Thorac Surg.* 2000;69:507-12.
2. Shiono M, et al. Multi-institutional experience of the ATS open pivot bileaflet valve in Japan. *Ann Thorac Cardiovasc Surg.* 1996;2(1):51-8.
3. Sezai A, et al. Fifteen years of experience with ATS mechanical heart valve prostheses. *J Thorac Cardiovasc Surg.* 2010;139(6):1494-500.
4. ATS Medical Inc. Pre-market Approval Application - Summary of Safety and Effectiveness: 2000. Washington DC; U.S. Food and Drug Administration. 2000:P990046.
5. Feng Z, et al. In vitro hydrodynamic characteristics among three bileaflet valves in the mitral position. *Artif Organs.* 2000;24(5):346-54.



Open Pivot Standard

Intra-annular valve with generous, compliant cuff for exceptional implantability

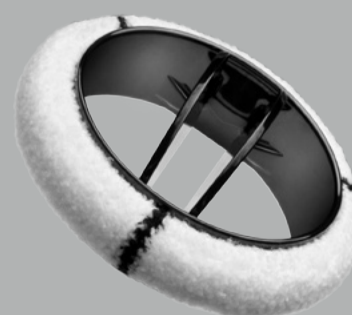

Open Pivot AP

Supra-annular compact cuff configuration for excellent suturability and conformability



Open Pivot AP360

Supra-annular flanged cuff configuration for maximum flexibility, needle penetration and conformability

Medtronic Open Pivot™ Mechanical Heart Valves

Optimal performance with excellent quality of life benefits.

TABLE OF CONTENTS

HEART VALVES

SURGICAL ABLATION

REVASCULARIZATION

Page | 10

Open Pivot Standard Heart Valve Aortic

Order Number	Valve Size (mm)	A Orifice Inner Diameter (mm)	B Tissue Annulus (mm)	Geometric Orifice Area (cm ²)
500FA19	19	14.8	19.5	1.55
500FA21	21	16.8	21.5	2.02
500FA23	23	18.8	23.5	2.56
500FA25	25	20.8	25.5	3.17
500FA27	27	22.8	27.5	3.84
500FA29	29	24.8	29.5	4.59
500FA31	31	26.8	31.5	5.35

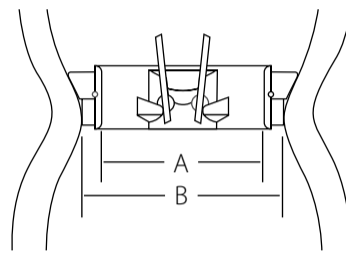

Standard Aortic

Open Pivot Standard Heart Valve Mitral

Order Number	Valve Size (mm)	A Orifice Inner Diameter (mm)	B Tissue Annulus (mm)	Geometric Orifice Area (cm ²)
500DM19	19	14.8	19.5	1.55
500DM21	21	16.8	21.5	2.02
500DM23	23	18.8	23.5	2.56
500DM25	25	20.8	25.5	3.17
500DM27	27	22.8	27.5	3.84
500DM29	29	24.8	29.5	4.59
500DM31	31	26.8	31.5	5.35
500DM33	33	26.8	33.5	5.35

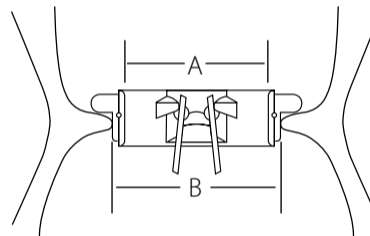

Standard Mitral

Open Pivot AP and AP360° Heart Valves Aortic

Order Number	Valve Size (mm)	A Orifice Inner Diameter (mm)	B Tissue Annulus (mm)	Geometric Orifice Area (cm ²)
501DA16/505DA16	16	14.8	16.2	1.55
501DA18/505DA18	18	16.8	18.2	2.02
501DA20/505DA20	20	18.8	20.2	2.56
501DA22/505DA22	22	20.8	22.2	3.17
501DA24/505DA24	24	22.8	24.2	3.84
501DA26/505DA26	26	24.8	26.2	4.59
501DA28/505DA28	28	26.8	28.2	5.35

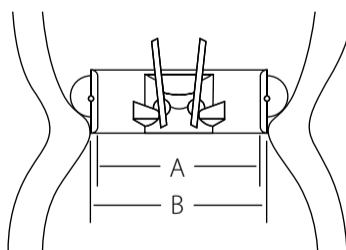

AP Aortic

Open Pivot AP360° Heart Valves Mitral

Order Number	Valve Size (mm)	A Orifice Inner Diameter (mm)	B Tissue Annulus (mm)	Geometric Orifice Area (cm ²)
501DM16	16	14.8	16.2	1.55
501DM18	18	16.8	18.2	2.02
501DM20	20	18.8	20.2	2.56
501DM22	22	20.8	22.2	3.17
501DM24	24	22.8	24.2	3.84
501DM26	26	24.8	26.2	4.59
501DM28	28	26.8	28.2	5.35

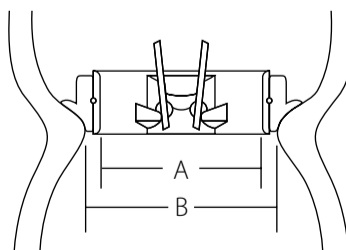

AP360° Aortic

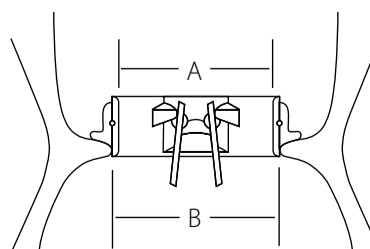

AP360° Mitral

Open Pivot Accessories

Order Number	Description
576	OPHV Sizer Set, (Std, AP series, Handle, Tray)
556	OPHV Aortic and Mitral Handle Rotator Set
558	OPHV Leaflet Actuators (Non-sterile bag of 5)
569	OPHV Bendable Handle
577	OPHV Standard Sizer Set (just sizers)
578	OPHV AP Series Sizer Set (just sizers)
579	OPHV Sizer Sterilization Tray (tray only)
580	OPHV Screw-on Mitral Rotator End Set



Contegra™

Pulmonary Valve Conduit

An integrated valved conduit for reconstruction or replacement of the natural right ventricular outflow tract (RVOT) or replacement of a failed homograft or composite pulmonary conduit.

TABLE OF CONTENTS

HEART VALVES

SURGICAL ABLATION

REVASCULARIZATION

Page | 11

Natural

- Derived from a bovine jugular vein
- Flexible for unique tailoring as only natural tissue can offer
- Blood passes easily across a continuous tissue interface and natural sinus

Versatile

- Proximal length allows for infundibular shaping without patching
- Resilient wall retains suture and supports hemostatic suture line
- No additional materials necessary for proximal anastomosis

Convenient

- Available in supported and unsupported models
- Preserved in buffered glutaraldehyde
- Readily available—no thawing or preclotting required



No discontinuity between the lumen and valve



Thin, compliant leaflets open fully and close readily with minimal pressure

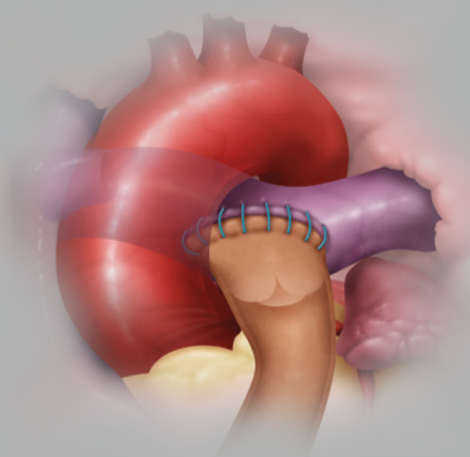

Thin, extensible tissue is especially suited for anastomosis

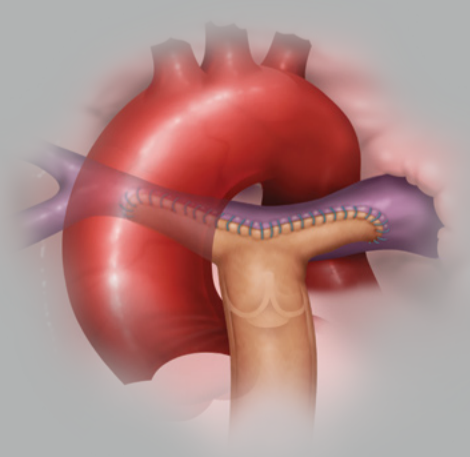

Easily customized to individual needs

Contegra™ Pulmonary Valve Conduit

An integrated valved conduit for reconstruction or replacement of the natural right ventricular outflow tract (RVOT) or replacement of a failed homograft or composite pulmonary conduit.

TABLE OF CONTENTS

HEART VALVES

SURGICAL ABLATION

REVASCULARIZATION

Contegra Pulmonary Valve Conduit - Supported

Order Number	Internal Diameter (Inflow End) (mm)
200SH12	12
200SH14	14
200SH16	16
200SH18	18

Model 01-0055 Torque Wrench (optional reusable jar opener)

Storage Temperature  +25 °C / +77 °F
+15 °C / +59 °F

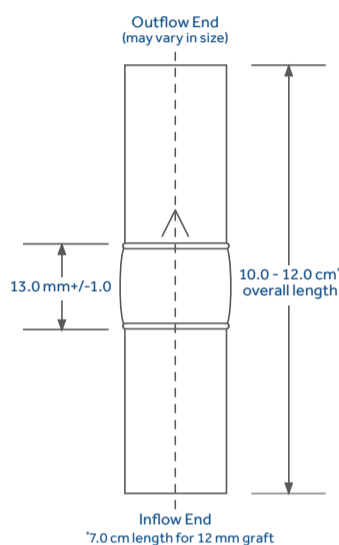

Contegra Pulmonary Valve Conduit - Unsupported

Order Number	Internal Diameter (Inflow End) (mm)
200H12	12
200H14	14
200H16	16
200H18	18

Model 01-0055 Torque Wrench (optional reusable jar opener)

Storage Temperature  +25 °C / +77 °F
+15 °C / +59 °F

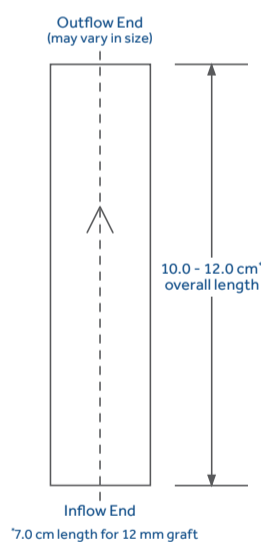

Hancock™

Bioprosthetic Valved Conduit

With options for right and left heart applications.

TABLE OF CONTENTS

HEART VALVES

SURGICAL ABLATION

REVASCULARIZATION

Page | 13

A Proven Alternative

Hancock valved conduits offer proven performance for reconstruction of congenital or acquired cardiac and great vessel malformations or pathologies for right heart applications.

- Porcine aortic valve sutured into a Dacron woven fabric conduit
- Stentless—optimizes the ratio of the conduit outer diameter to the inner diameter
- An external reinforcing ring at the valve annulus supports leaflet coaptation and allows radiographic visualization

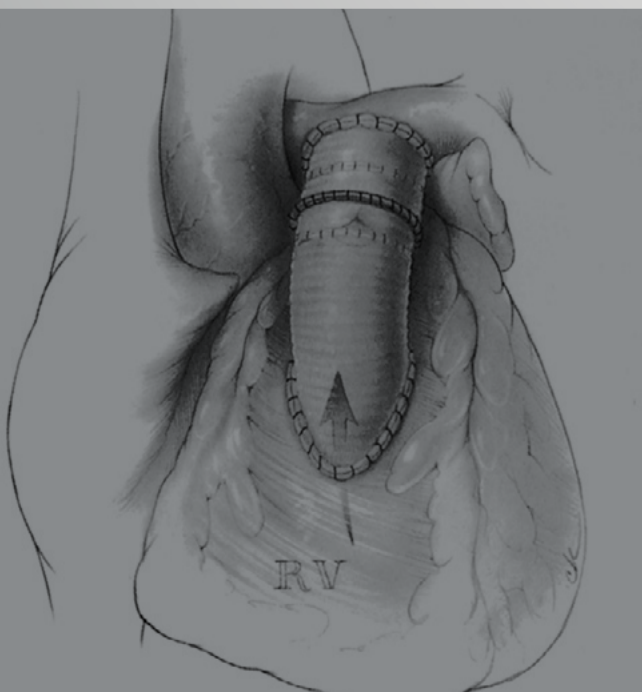

Bioprosthetic Valved Conduit

With options for right and left heart applications.

Model 150 | Hancock Modified Oriface Bioprosthetic Standard-Porosity Valved Conduits

Order Number	Valve Size (mm)
HC15012	12
HC15014	14
HC15016	16
HC15018	18
HC15020	20
HC15022	22
HC15025	25

For right heart applications



Model 105 | Hancock Bioprosthetic Low-Porosity Valved Conduits

Order Number	Valve Size (mm)
HC05012	12
HC05014	14
HC05016	16
HC05018	18
HC05020	20
HC05022	22
HC05025 	26

For right and left heart applications

Intentional Design

Unique composite design considers both cardiac cycles

- **Cardiac Systole**
The ring remodels the mitral valve orifice to normal 3:4 ratio between the anteroposterior and transverse diameters
- **Cardiac Diastole**
The ring's dynamic characteristics allow physiologic motion and movement to maintain the normal 4:4 ratio between anteroposterior and transverse diameters

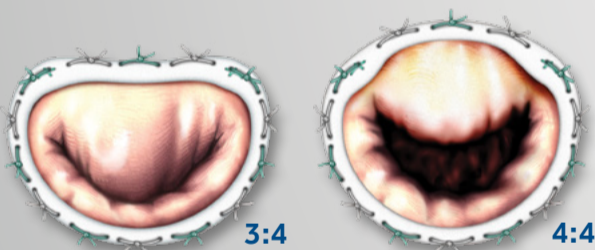

Implant Ease

- Low profile design allows for ease of implant
- Unique eyelet design allows for easy anchoring to the trigones



Provides enough stiffness for posterior remodeling, while preserving dynamic annular motion

CG Future Annuloplasty Ring, Model 638R

Order Number	Ring Size (mm)	A (mm)	B (mm)	C (mm)	D (mm)	Orifice Area (mm ²)
638RL24	24	15.27	16.53	24.0	28.9	269.3
638RL26	26	16.38	17.64	26.0	30.9	314.9
638RL28	28	17.48	18.73	28.0	32.9	364.3
638RL30	30	18.59	19.85	30.0	34.9	417.3
638RL32	32	19.71	20.97	32.0	36.9	474.7
638RL34	34	20.83	22.09	34.0	38.9	536.0
638RL36	36	21.92	23.18	36.0	40.9	600.9
638RL38	38	23.04	24.29	38.0	42.9	669.4

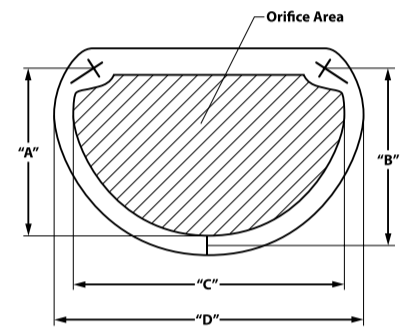

CG Future Annuloplasty Band, Model 638B

Order Number	Band Size (mm)	A (mm)	B (mm)	C (mm)	D (mm)	Orifice Area (mm ²)
638BL26	26	16.38	17.64	26.0	30.9	332.0
638BL28	28	17.48	18.73	28.0	32.9	382.8
638BL30	30	18.59	19.85	30.0	34.9	437.4
638BL32	32	19.71	20.97	32.0	36.9	496.3
638BL34	34	20.83	22.09	34.0	38.9	559.2
638BL36	36	21.92	23.18	36.0	40.9	625.1
638BL38	38	23.04	24.29	38.0	42.9	695.7

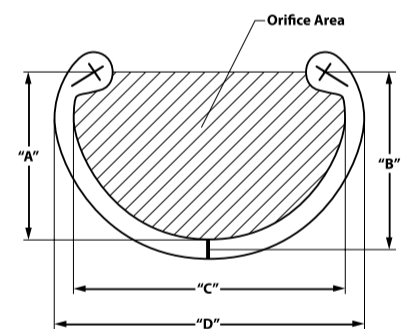

CG Future Annuloplasty Band Accessories

Order Number	Description
T7630	CG Future Accessory Tray
7615	Annuloplasty Handle (216mm length)
7615XL	Annuloplasty Handle (373mm length)
7638S	CG Future Sizer Set (8 reusable sizers, 24 - 38mm)

Contour 3D™ Tricuspid Annuloplasty Ring

Accommodates anterior motion; provides posterior support.

TABLE OF CONTENTS

HEART VALVES

SURGICAL ABLATION

REVASCULARIZATION

Page | 17

Restores Anatomic 3D Shape

- Design of the Contour 3D ring is based on CT data from functional human tricuspid valves—offering surgeons a 3D remodeling ring anatomically shaped to the normal tricuspid annulus

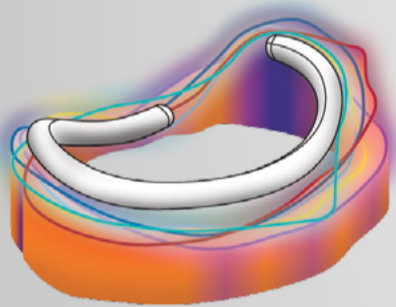

- Low profile and smooth penetration
- Low profile height of 3.3mm helps to avoid interference with the heart's conduction system. In addition, unique fabric allows for smooth needle penetration

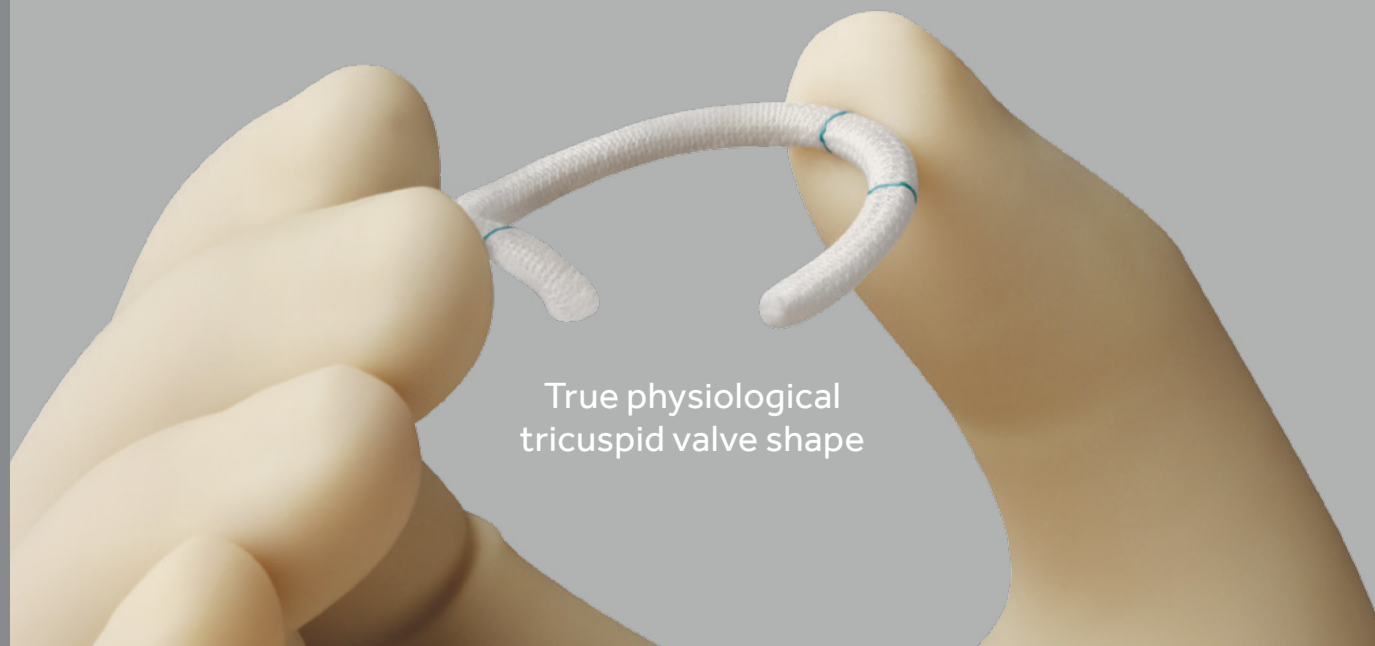

True physiological
tricuspid valve shape

Contour 3D™ Tricuspid Annuloplasty Ring

Accommodates anterior motion; provides posterior support.

TABLE OF CONTENTS

HEART VALVES

SURGICAL ABLATION

REVASCULARIZATION

Page | 18

Contour 3D Annuloplasty Ring, Model 690R

Order Number	Ring Size (mm)	A (mm)	B (mm)	C (mm)	D (mm)	E (mm)	F (mm)	Orifice Area (mm ²)
690R26	26	24	32	16	24	10	7	326.1
690R28	28	26	34	18	25	11	7	387.2
690R30	30	28	36	19	27	12	8	449.2
690R32	32	30	38	21	28	13	8	512.4
690R34	34	32	40	22	30	14	9	588.6
690R36	36	34	42	23	31	15	9	665.1

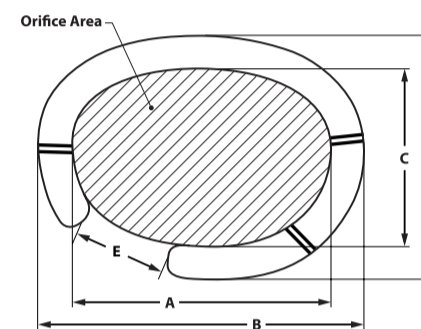

Contour 3D Annuloplasty Ring Accessories

Order Number	Description
T7690	Contour 3D Accessory Tray
7686	Annuloplasty Handle (216mm length)
7686XL	Annuloplasty Handle (373mm length)
7690S	Contour 3D Sizer Set (6 reusable sizers, 26 - 36mm)
7690SD	Contour 3D Sizer Set (6 disposable silicone sizers, 26 - 36mm)

Duran AnCore™

Flexible Annuloplasty Ring and Band

A clinically inspired design by Carlos Duran, MD, PhD, with technology proven by more than 36 years of clinical experience.

TABLE OF CONTENTS

HEART VALVES

SURGICAL ABLATION

REVASCULARIZATION

Page | 19

Duran AnCore Ring

- Flexibility allows preservation of the natural physiologic motion of the annulus resulting in optimal hemodynamics¹
- Adapts to changes in the mitral orifice area during entire cardiac cycle²

Duran AnCore Band

- Optimum choice when only posterior annulus support is required^{3,4}
- Band length extends beyond the trigones to provide secure suturing

Ease of Implant

- Patented chordal guide facilitates replacement of mitral valve chordae tendineae

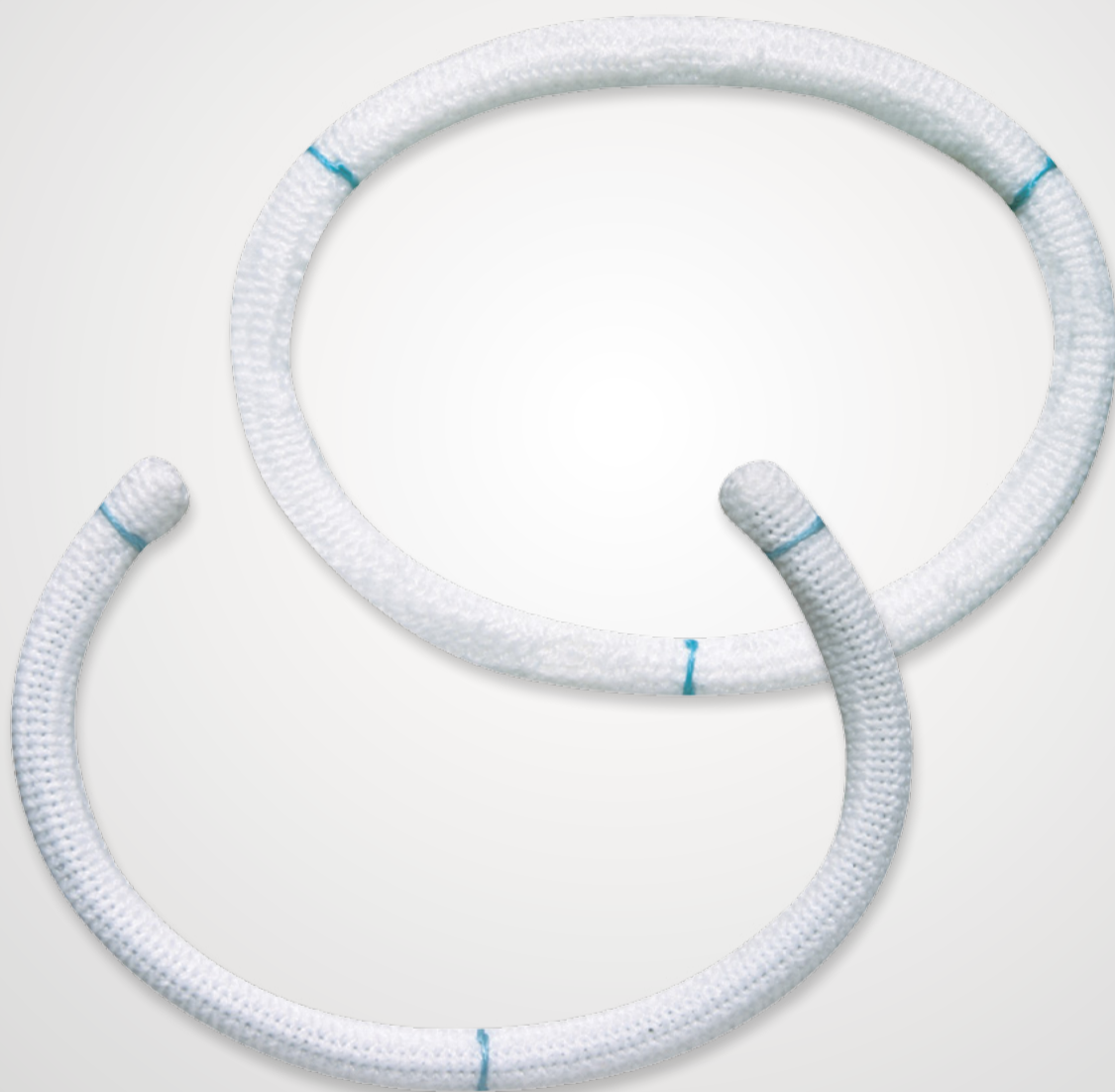

Preserves natural annular motion

References

1. Kunzelman KS, Reimink MS, Cochran RP. Flexible Versus Rigid Ring Annuloplasty for Mitral Valve Annular Dilatation: A Finite Element and Model. *J Heart Valve Dis.* 1998;7:108-116.
2. Yamaura Y, Yoshikawa J, Yoshida K, et al. Three-dimensional Analysis of Configuration and Dynamics in patients with an Annuloplasty Ring by Multiplane Transesophageal Echocardiography: Comparison Between Flexible and Rigid Annuloplasty Rings. *J Heart Valve Dis.* 1995;4:618-22.
3. Duran CMG. Duran Flexible Annuloplasty Repair of the Mitral and Tricuspid Valves: Indications, Patient Selection, and Surgical Techniques using the Duran Flexible Annuloplasty Ring. Medtronic, Inc. 1992.
4. Odell JA, Schaff HV, Orszulak TA. Early Results of a Simplified Method of Mitral Valve Annuloplasty. *Circulation.* 1995;92 (Suppl 2):11-150-4.

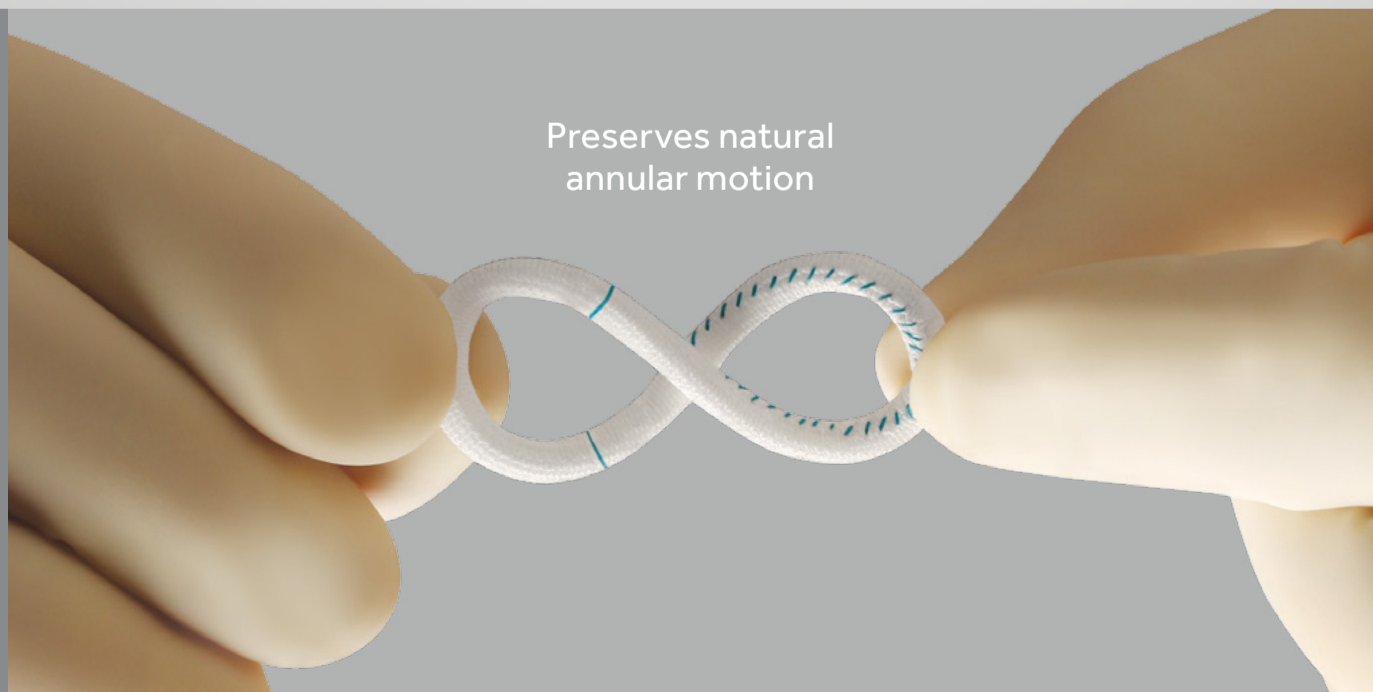

Duran AnCore™

Flexible Annuloplasty Ring and Band

A clinically inspired design by Carlos Duran, MD, PhD, with technology proven by more than 36 years of clinical experience.

TABLE OF CONTENTS

HEART VALVES

SURGICAL ABLATION

REVASCULARIZATION

Page | 20

Duran AnCore Annuloplasty Ring, Model 620R

Order Number	Ring Size (mm)	A (mm)	B (mm)	C (mm)
620RG23	23	25.8	31.8	23
620RG25	25	27.8	33.8	25
620RG27	27	29.8	35.8	27
620RG29	29	31.7	37.7	29
620RG31	31	33.8	39.8	31
620RG33	33	35.8	41.8	33
620RG35	35	37.7	43.7	35

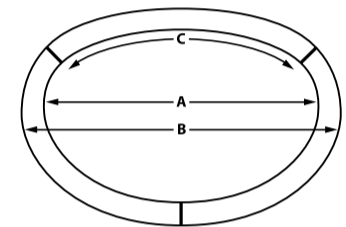

Duran AnCore Annuloplasty Band, Model 620B

Order Number	Band Size (mm)	A (mm)	B (mm)	C (mm)	D (mm)
620BG23	23	25.8	31.8	23	59
620BG25	25	27.8	33.8	25	63
620BG27	27	29.8	35.8	27	67
620BG29	29	31.7	37.7	29	73
620BG31	31	33.8	39.8	31	77
620BG33	33	35.8	41.8	33	81
620BG35	35	37.7	43.7	35	85

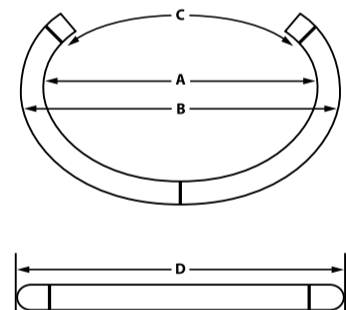

Duran AnCore Annuloplasty Ring and Band Accessories

Order Number	Description
T7660	Duran AnCore Accessory Tray
7620H/7686	Annuloplasty Handle (216mm length)
7620HXL/7686XL	Annuloplasty Handle (373mm length)
7620S	Duran AnCore Sizer Set

Profile 3D™

Rigid Annuloplasty Ring

Engineered to maintain anterior and posterior dimensions of the mitral annulus.

TABLE OF CONTENTS

HEART VALVES

SURGICAL ABLATION

REVASCULARIZATION

Page | 21

Restoring Annular Geometry

- Unique asymmetrical 3D design engineered to maintain anterior and posterior dimensions of mitral annulus to restore annular geometry

Saddle Shape

- The saddle shape, based on the annular geometry of normal human mitral annuli, may reduce stress and increase mitral valve durability^{1,2}
- Design provides a consistent 25% anterior curvature and 15% posterior curvature reducing peak leaflet stress³

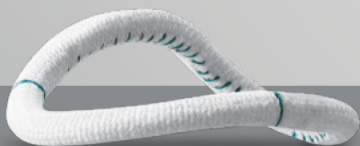

Restores annular geometry

References

1. Published U.S. Patent Application Nos. 2005-0021135 A1 and 2006-0025856 A1.
2. Fedak P, McCarthy P, Bonow R. Evolving concepts and technologies in mitral valve repair. *Circulation*. 2008;117:963-74.
3. Salgo I, Gorman J, Gorman R, et al. Effect of annular shape on leaflet curvature in reducing mitral leaflet stress. *Circulation*. 2002;106:711-7.

Profile 3D™

Rigid Annuloplasty Ring

Engineered to maintain anterior and posterior dimensions of the mitral annulus.

TABLE OF CONTENTS

HEART VALVES

SURGICAL ABLATION

REVASCULARIZATION

Profile 3D Annuloplasty Ring, Model 680R

Order Number	Ring Size (mm)	A (mm)	B (mm)	C (mm)	D (mm)	Orifice Area (mm ²)
680R24	24	13.4	15.0	24.2	30.5	278
680R26	26	14.5	16.1	26.2	32.5	325
680R28	28	15.6	17.2	28.2	34.5	376
680R30	30	16.7	18.3	30.2	36.5	430
680R32	32	17.8	19.4	32.2	38.5	489
680R34	34	18.9	20.5	34.2	40.5	550
680R36	36	19.8	21.4	36.2	42.5	612
680R38	38	20.9	22.5	38.2	44.5	683
680R40	40	22.0	23.6	40.2	46.5	756

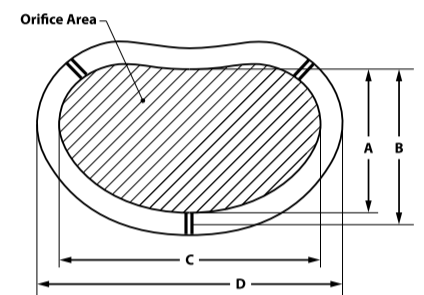

Profile 3D Annuloplasty Ring Accessories

Order Number	Description
T7680	Profile 3D Accessory Tray
7686	Annuloplasty Handle (216mm length)
7686XL	Annuloplasty Handle (373mm length)
7680S	Profile 3D Sizer Set (6 reusable sizers, 26-36mm)

Simplici-T™

Flexible Annuloplasty Band

Designed to repair annular dilation while preserving 3D motion during the cardiac cycle.

TABLE OF CONTENTS

HEART VALVES

SURGICAL ABLATION

REVASCULARIZATION

Page | 23

Eliminate the Need for Traditional Sizing

- Provides a custom fit for mitral and tricuspid patients through graduated markings that can be used to measure the implanted band length
- Unique, low-profile flexible band is supplied in a length of 100mm

Adapts to Pathology

- Adapts to the unique needs of every patient based on pathology. Band length is determined by the annular size and degree of plication.



Customizable, flexible band for every patient



Simplici-T™

Flexible Annuloplasty Band

Designed to repair annular dilation while preserving 3D motion during the cardiac cycle.

TABLE OF CONTENTS

HEART VALVES

SURGICAL ABLATION

REVASCULARIZATION

Page | 24

Simplici-T Annuloplasty Band, Model 670

Order Number	Band Size (mm)	Description
607100 	100	Simplici-T Annuloplasty Band



Simulus™

Flexible Annuloplasty Ring and Band

Flexible ring and band enabling easy manipulation in varied approaches and exposures.

TABLE OF CONTENTS

HEART VALVES

SURGICAL ABLATION

REVASCULARIZATION

Page | 25

Unique Braided Polyester

- Discourages bunching or crimping while enabling low resistance, smooth needle penetration
- Accommodates sternotomy, thoracotomy and minimally invasive procedures

Ease of Implant

- Trigone and midline posterior markers assist in precise suture placement and band positioning
- Flexible throughout cardiac cycle with a low profile design

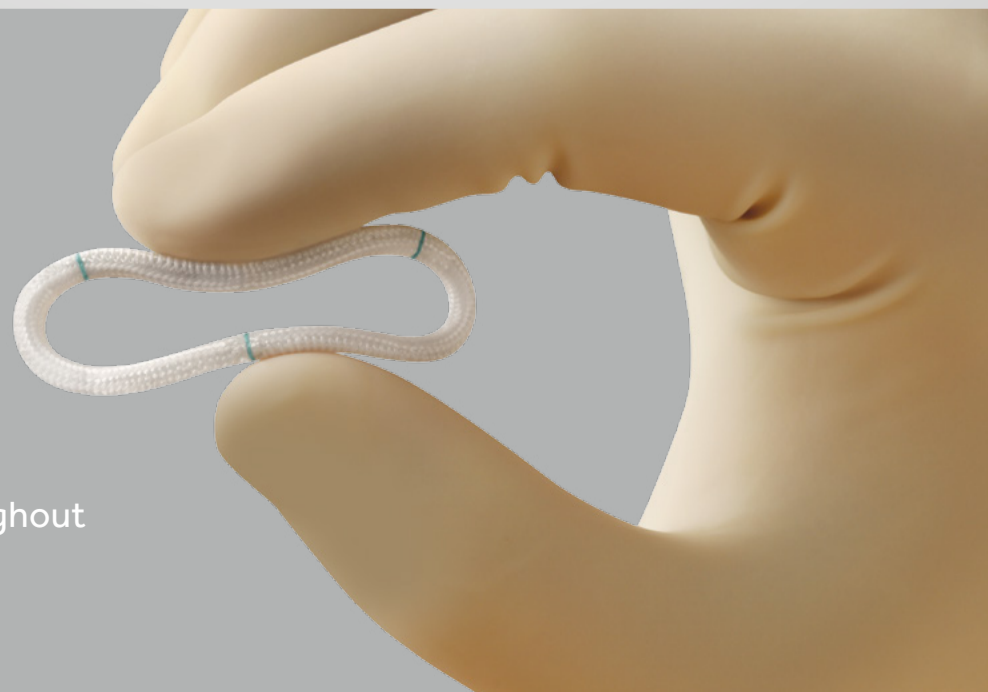

Flexibility throughout cardiac cycle

Flexible Annuloplasty Ring and Band

Flexible ring and band enabling easy manipulation in varied approaches and exposures.

Simulus Flexible Annuloplasty Ring, Model 700FF

Order Number	Ring Size (mm)	A (mm)	B (mm)	C (mm)	D (mm)	Orifice Area (mm ²)
700FF23	23	24	30	17.1	23.1	325
700FF25	25	27	33	19.5	25.5	418
700FF27	27	29	35	20.9	26.9	481
700FF29	29	31	37	22.3	28.3	550
700FF31	31	33	39	23.8	29.8	622
700FF33	33	35	41	25.2	31.2	700
700FF35	35	37	43	26.6	32.6	781
700FF37	37	39	45	28.0	34.0	867
700FF39	39	41	47	29.4	35.4	958

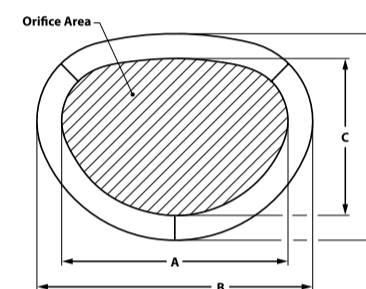

Simulus Flexible Annuloplasty Band, Model 700FC

Order Number	Band Size (mm)	A (mm)	B (mm)	C (mm)	L Straight Length (mm)	T Straight Length Between Trigone Markers (mm)	Orifice Area (mm ²)
700FC23	23	24	30	17.1	59	53	325
700FC25	25	27	33	19.5	63	57	418
700FC27	27	29	35	20.9	67	61	481
700FC29	29	31	37	22.3	73	65	550
700FC31	31	33	39	23.8	77	69	622
700FC33	33	35	41	25.2	81	73	700
700FC35	35	37	43	26.6	85	77	781
700FC37	37	39	45	28.0	89	81	867
700FC39	39	41	47	29.4	93	85	958

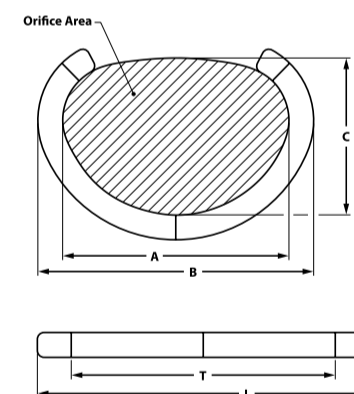

Simulus Flexible Annuloplasty Ring and Band Accessories

Order Number	Description
750	Simulus Flexible Ring/Band Accessory Kit
755	Simulus Flexible Ring/Band Robotic Accessory Kit
752	Annuloplasty Handles (254mm length) (2)

Simulus™

Semi-Rigid Annuloplasty Ring and Band

Distinctive hybrid design enable shaping by dynamic annular motion.

TABLE OF CONTENTS

HEART VALVES

SURGICAL ABLATION

REVASCULARIZATION

Page | 27

Saddle and Flat Shape

- Defined suture area, and braided fabric for smooth needle penetration and one cut release
- Takes the shape of the annulus rising as a saddle in systole and flattening to a planar shape in diastole
- Respects annular motion while preserving posterior support

Sew-Easy Implant

- Braided polyester materials enables smooth needle penetration anywhere along ring or band preventing crimping or bunching
- Trigone markers assist in suture placement and positioning
- Flexible tips allow secure attachment at the trigones

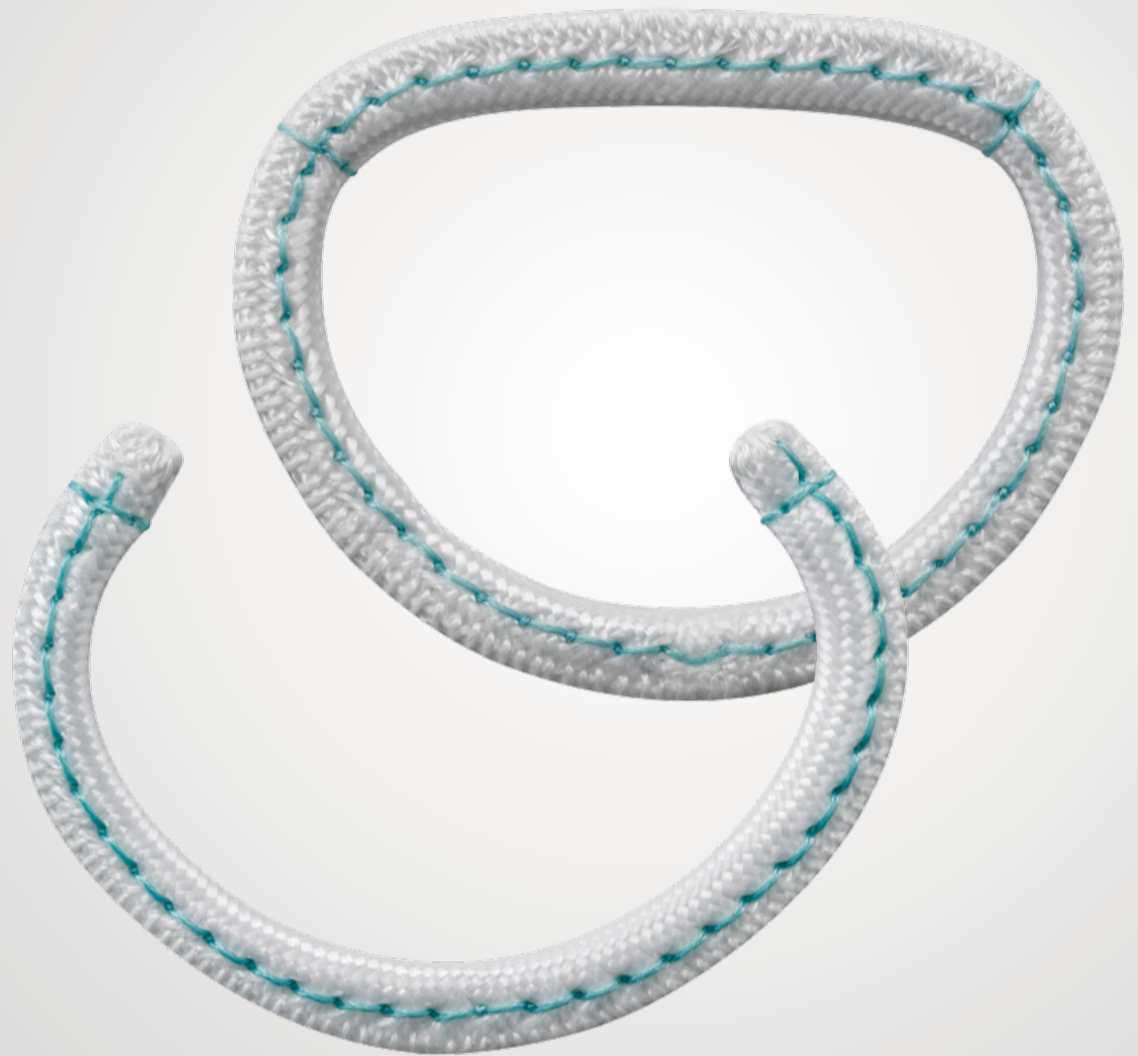

Hybrid design to model natural annular dynamics



Simulus Semi-Rigid Annuloplasty Ring, Model 800SR

Order Number	Ring Size (mm)	A (mm)	B (mm)	C (mm)	D (mm)	E (mm)	Orifice Area (mm ²)
800SR24	24	15.6	23.4	22.6	24	30.3	281
800SR26	26	17.0	24.4	24.5	26	31.9	329
800SR28	28	18.3	25.6	26.3	28	33.7	381
800SR30	30	19.6	27.3	28.2	30	36.0	436
800SR32	32	20.9	28.3	30.1	32	37.6	497
800SR34	34	22.2	29.6	32.0	34	39.4	561
800SR36	36	23.5	30.9	33.9	36	41.3	630
800SR38	38	24.8	32.2	35.8	38	43.2	702
800SR40	40	26.1	33.5	37.6	40	45.1	779

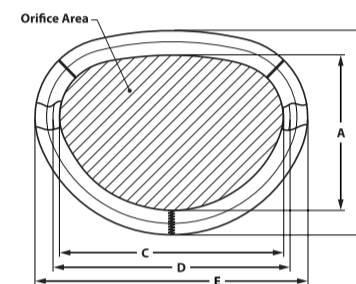

Simulus Semi-Rigid Annuloplasty Band, Model 800SC

Order Number	Band Size (mm)	A (mm)	B (mm)	C (mm)	D (mm)	Orifice Area (mm ²)
800SC24	24	15.6	22.6	24	30.3	281
800SC26	26	17.0	24.5	26	31.9	329
800SC28	28	18.3	26.3	28	33.7	381
800SC30	30	19.6	28.2	30	36.0	436
800SC32	32	20.9	30.1	32	37.6	497
800SC34	34	22.2	32.0	34	39.4	561
800SC36	36	23.5	33.9	36	41.3	630
800SC38	38	24.8	35.8	38	43.2	702
800SC40	40	26.1	37.6	40	45.1	779

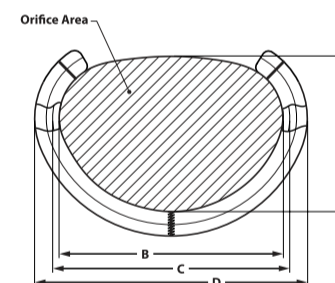

Simulus Semi-Rigid Annuloplasty Ring and Band Accessories

Order Number	Description
850	Simulus Semi-Rigid Ring/Band Accessory Kit
752	Annuloplasty Handles (254mm length) (2)

Tri-Ad™

Adams Tricuspid Annuloplasty Ring

Designed to repair annular dilation while preserving 3D motion during the cardiac cycle.

TABLE OF CONTENTS

HEART VALVES

SURGICAL ABLATION

REVASCULARIZATION

Page | 29

Smooth Implantation

- Braided sewing ring construction provides smooth needle penetration that prevents bunching; one-cut release
- Large open area minimizes potential suture injury to conduction tissue

Adapts to Tricuspid Anatomy¹

- Repairs annular dilation while preserving 3D motion during cardiac cycle
- Enables adaption to non-planar geometry of the tricuspid valve in systole and diastole
- Semi rigid segment addresses annular dilation along right ventricular free wall

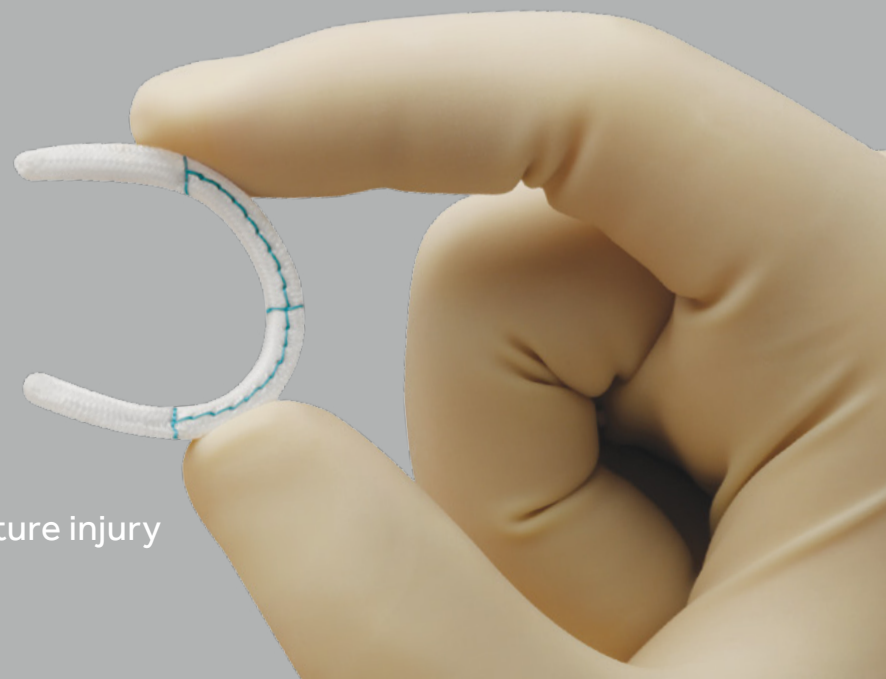
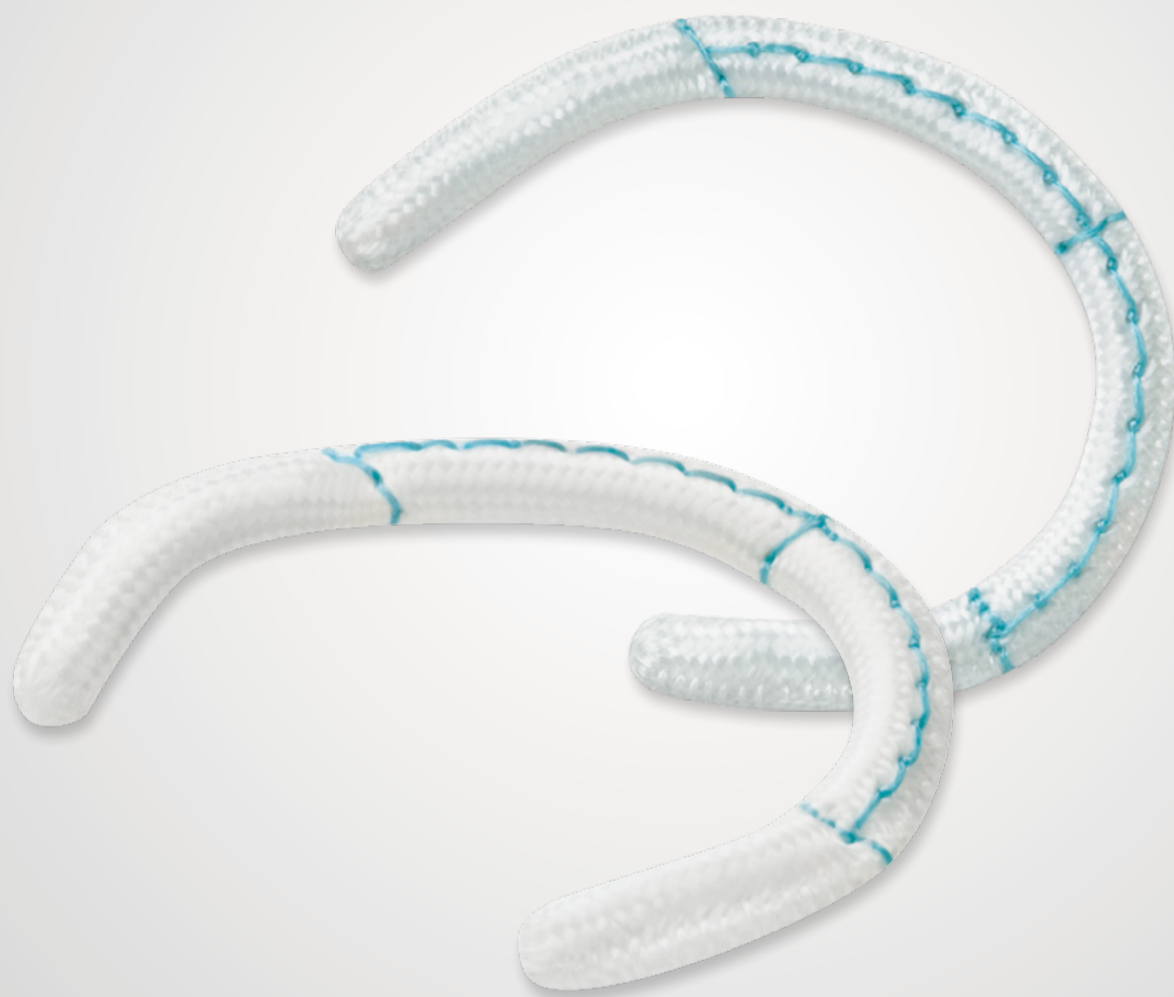

References

1. Milla, F. et al. Rationale and initial experience with the Tri-Ad Adams tricuspid annuloplasty ring. *Journal of Thoracic and Cardiovascular Surgery* 143;4S:S71-3.

Minimizes potential suture injury to conduction tissue

Adams Tricuspid Annuloplasty Ring

Designed to repair annular dilation while preserving 3D motion during the cardiac cycle.

Tri-Ad Adams Tricuspid Annuloplasty Ring, Model 900SFC

Order Number	Ring Size (mm)	A (mm)	B (mm)	C (mm)	D (mm)	E (mm)	Orifice Area (mm ²)
900SFC26	26	17.4	25.8	25.6	33.2	15.5	365
900SFC28	28	19.4	27.6	28.1	24.9	17.1	435
900SFC30	30	20.9	29.1	30.6	37.2	18.5	502
900SFC32	32	22.3	30.7	31.5	38.2	20.0	557
900SFC34	34	24.0	32.3	34.7	41.1	20.9	654
900SFC36	36	25.5	33.8	36.3	42.9	21.9	730

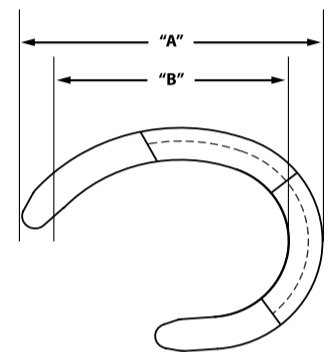

Tri-Ad Adams Tricuspid Annuloplasty Ring Accessories

Order Number	Description
950	Tri-Ad Adams Ring Accessory Kit
951	Tri-Ad Adams Ring Sizer Set (polysulfone & silicone)
752	Annuloplasty Handles (254mm length) (2)

Streamline™

Temporary Pacing Leads

The Streamline family is the gold standard in temporary pacing leads.

TABLE OF CONTENTS

HEART VALVES

SURGICAL ABLATION

REVASCLARIZATION

Page | 31

Generations of Innovation

The Streamline family is designed for temporary pacing and sensing during and after cardiac surgery. The Streamline family includes models that offer consistent unipolar atrial and ventricular pacing, pediatric unipolar pacing and bipolar pacing. All Medtronic temporary pacing leads are compatible with Medtronic external pulse generators. Integrating more than 50 years of scientific and technological pacing expertise into our temporary pacing leads, Streamline is the lead you can trust.

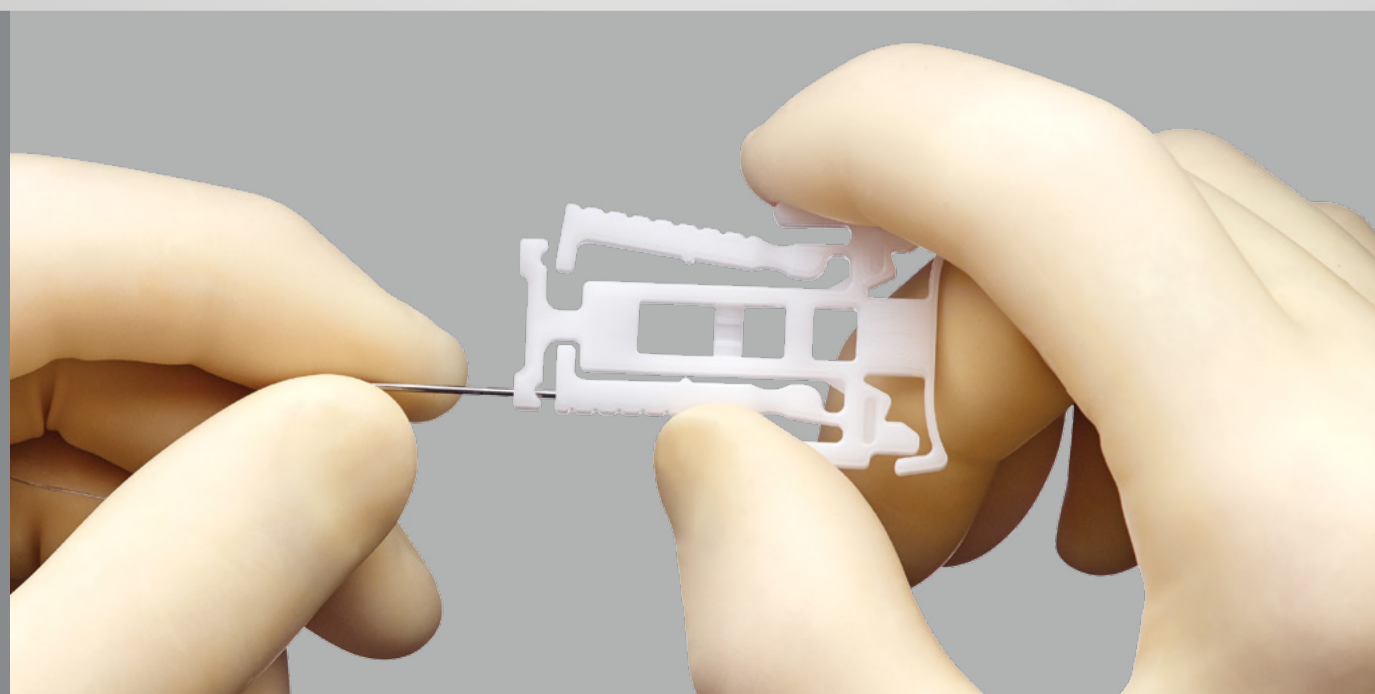

Streamline™ Temporary Pacing Leads

The Streamline family is the gold standard in temporary pacing leads.

TABLE OF CONTENTS

HEART VALVES

SURGICAL ABLATION

REVASCULARIZATION

Page | 32

Premium 6500 Unipolar Temporary Myocardial Pacing Lead

- Relaxed fixation coil minimizes trauma during pacing lead insertion
- Diameter of the curved myocardial needle has been reduced from 0.66mm to 0.61mm to minimize tissue perforation
- Discrete electrode for consistent sensing and pacing
- Easy-to-use breakaway chest needle has been reduced in diameter from 1.00mm to 0.86mm to minimize perforation
- Silastic fixation disc for atrial placement
- Connector pin sleeves insulate connector pins while not in use

Bipolar Coaxial 6495 Bipolar Temporary Myocardial Pacing Lead

- Features coaxial lead body for excellent electrical performance
- Curved myocardial needle is slimmer – reduced from 0.66mm to 0.61mm to minimize tissue perforation
- Two discrete electrodes are optimally spaced for consistent pacing and sensing
- Proximal electrode is swaged for smoother transition through tissue
- Relaxed fixation coil minimizes tissue trauma while securely positioning electrode
- Connector pin sleeves insulate connector pins while not in use

Pediatric 6491 Unipolar Pediatric Temporary Pacing Lead

- Smaller fixation coil well suited for thinner pediatric tissue
- Curved chest needle for greater leverage through small chest cavity
- Discrete electrode for consistent sensing and pacing
- Connector pin sleeves insulate connector pins while not in use

Atrial 6492 Unipolar Temporary Atrial Pacing Lead

- Smaller fixation coil well suited for thinner atrial tissue
- Discrete electrode for consistent sensing and pacing
- Straight breakaway chest needle diameter reduced from 1.00mm to 0.86mm minimizes trauma during lead insertion
- Connector pin sleeves insulate connector pins while not in use

Convenience 6494 Unipolar Temporary Myocardial Pacing Wire

The Convenience wire is a temporary pacing wire designed for either atrial or ventricular sensing and pacing.

- Conductive wire length extended from 50mm to 70mm
- Curved myocardial needle diameter reduced from 0.55mm to 0.43mm to minimize trauma during heart wire insertion
- Chest needle diameter reduced from 1.00 mm to 0.86 mm to minimize perforation
- Color-coded leads come conveniently packaged, two per sleeve
- Connector pin sleeves insulate connector pins while not in use

Important Safety Information

The possibility of dislodgement, lead fractures, threshold elevation and sensing inconsistency exists. Other potential complications include, but are not limited to, myocardial irritability, septicaemia and myocardial infections, myocardial bleeding and damage, especially during removal of the pacing lead(s).

Streamline Temporary Pacing Leads

Streamline Family	Description	Quantity
PREMIUM 6500	Model 6500 Unipolar Temporary Myocardial Pacing Lead	12
BIPOLAR COAXIAL 6495	Model 6495 Bipolar Temporary Myocardial Pacing Lead	6
PEDIATRIC 6491	Model 6491 Unipolar Pediatric Temporary Pacing Lead	12
ATRIAL 6492	Model 6492 Unipolar Temporary Atrial Pacing Lead	12
CONVENIENCE 6494	Model 6494 Unipolar Temporary Myocardial Pacing Wire	24

Cardioblade™ iRF Surgical Ablation System

Unique malleability delivers irrigated RF to confidently create transmural lesions.

TABLE OF CONTENTS

HEART VALVES

SURGICAL ABLATION

REVASCULARIZATION

Page | 33

Designed For Easy Access

Cardioblade iRF surgical ablation systems are designed with maneuverability, placement and visualization in mind. Uniquely malleable devices put surgeons in control of every procedure with superior energy sources that give greater confidence of lesion transmural quality.

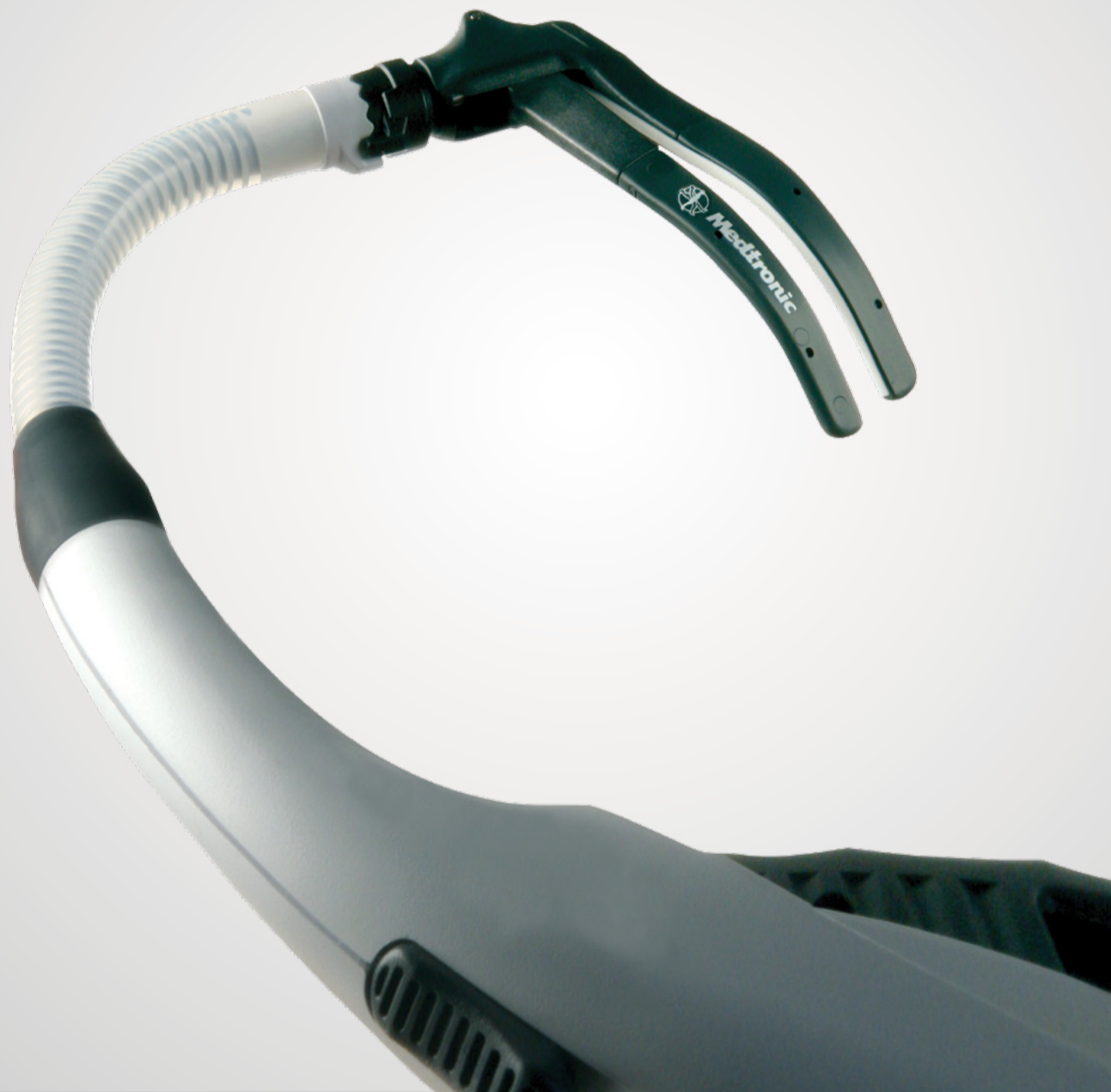

Malleable Jaws | Conforms to pulmonary veins and atrial anatomies.



Rotatable Jaws | Rotate the head up to 300° to facilitate placement.

Cardioblade™ iRF Surgical Ablation System

Unique malleability delivers irrigated RF to confidently create transmural lesions.

TABLE OF CONTENTS

HEART VALVES

SURGICAL ABLATION

REVASCULARIZATION

Page | 34

Cardioblade iRF Surgical Ablation Systems

Order Number	Description
68000	Cardioblade Surgical Ablation System (includes generator, power cord and foot switch)
60813	Cardioblade Surgical Ablation Pen
60814	Cardioblade XL Surgical Ablation Pen
49205	Cardioblade MAPS Device
60831	Cardioblade PB2 Surgical Ablation Device
60841	Cardioblade LP Surgical Ablation Device
49260	Cardioblade Gemini™-s Surgical Ablation Device

Cardioblade Surgical Ablation Generator



Cardioblade Surgical Ablation Pens

Cardioblade iRF Clamps, Pens & MAPS Device

Order Number	Description
60832	BP2 & Pen (1 each packed and shipped together)
CK9014R	BP2 & XL Pen
60842	LP & XL Pen
CK9016R	LP & XL Pen (1 each packed and shipped together)
SGEMPACK	Cardioblade Gemini-s Surgical Ablation Device & Cardioblade MAPS Device (1 each packed and shipped separately)



Cardioblade MAPS Device



Cardioblade PB2 and LP Surgical Devices

Cardioblade iRF Accessories

Order Number	Description
60883	iRF Generator Footswitch
4807	iRF Generator Power Cord
10004D	DLP "Y" Connectors
68005	EGM Cable
5103	Y-adaptor for 2090/2290 Programmer
5437	EKG Slave Cable for 2090/2290 Programmer



Cardioblade Gemini-s Surgical Ablation Device

CyroFlex™

Surgical Ablation System

Unique malleability delivers argon-powered cryoablation for reproducible, transmural lesions with a single probe.

TABLE OF CONTENTS

HEART VALVES

SURGICAL ABLATION

REVASCULARIZATION

Page | 35

Designed For Easy Access

CyroFlex surgical ablation systems are designed with maneuverability, placement and visualization in mind. Uniquely malleable devices put surgeons in control of every procedure with superior energy sources that give greater confidence of lesion transmuralty.



Hand malleable | The tip of the probe can be custom shaped quickly by hand.

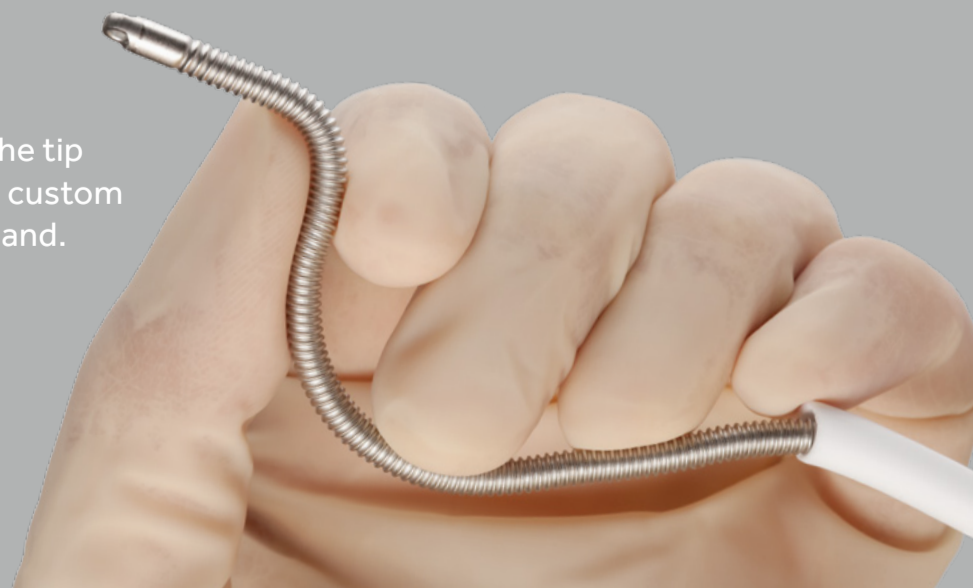

CryoFlex™ Surgical Ablation System

Unique malleability delivers argon-powered cryoablation for reproducible, transmural lesions with a single probe.

TABLE OF CONTENTS

HEART VALVES

SURGICAL ABLATION

REVASCULARIZATION

Page | 36

CryoFlex Surgical Ablation Systems

Order Number	Description
65CS1	CryoFlex Control Panel
60SF7	CryoFlex Probe, 7cm
60SF2	CryoFlex Probe, 10cm
60SF3	CryoFlex 10-S Probe, 10cm
60CM1	CryoFlex Clamp and Probe, 10cm

CryoFlex and Cardioblade iRF Bundles

Order Number	Description
BP2CF	BP2 & CryoFlex 10cm Probe
BP2CF3	BP2 & CryoFlex 10-S Probe
LPCF	LP & CryoFlex 10cm Probe
LPCF3	LP & CryoFlex 10-S Probe

CryoFlex Accessories

Order Number	Description
67RAXNA	CryoFlex Regulator (with pressure sensor cables)
671PCNA	Power Cord; CryoFlex Control Panel
67H08	Gas Hose; CryoFlex System
65TC1	CryoFlex Tank Carrier



CryoFlex
Control Console



CryoFlex Probe

OPCAB

Conventional Beating Heart Surgery

Reliable stability for completing a beating heart anastomosis based on each surgeon's preference.

TABLE OF CONTENTS

HEART VALVES

SURGICAL ABLATION

REVASCULARIZATION

Page | 37

Facilitating Solutions

Urchin™ and Starfish™ Heart Positioners work in concert with the Octopus™ Tissue Stabilizers to facilitate clinical solutions for OPCAB procedures. Cardiac Surgeons can choose from two positioner options, both of which provide enhanced visualization of the anastomotic sites.

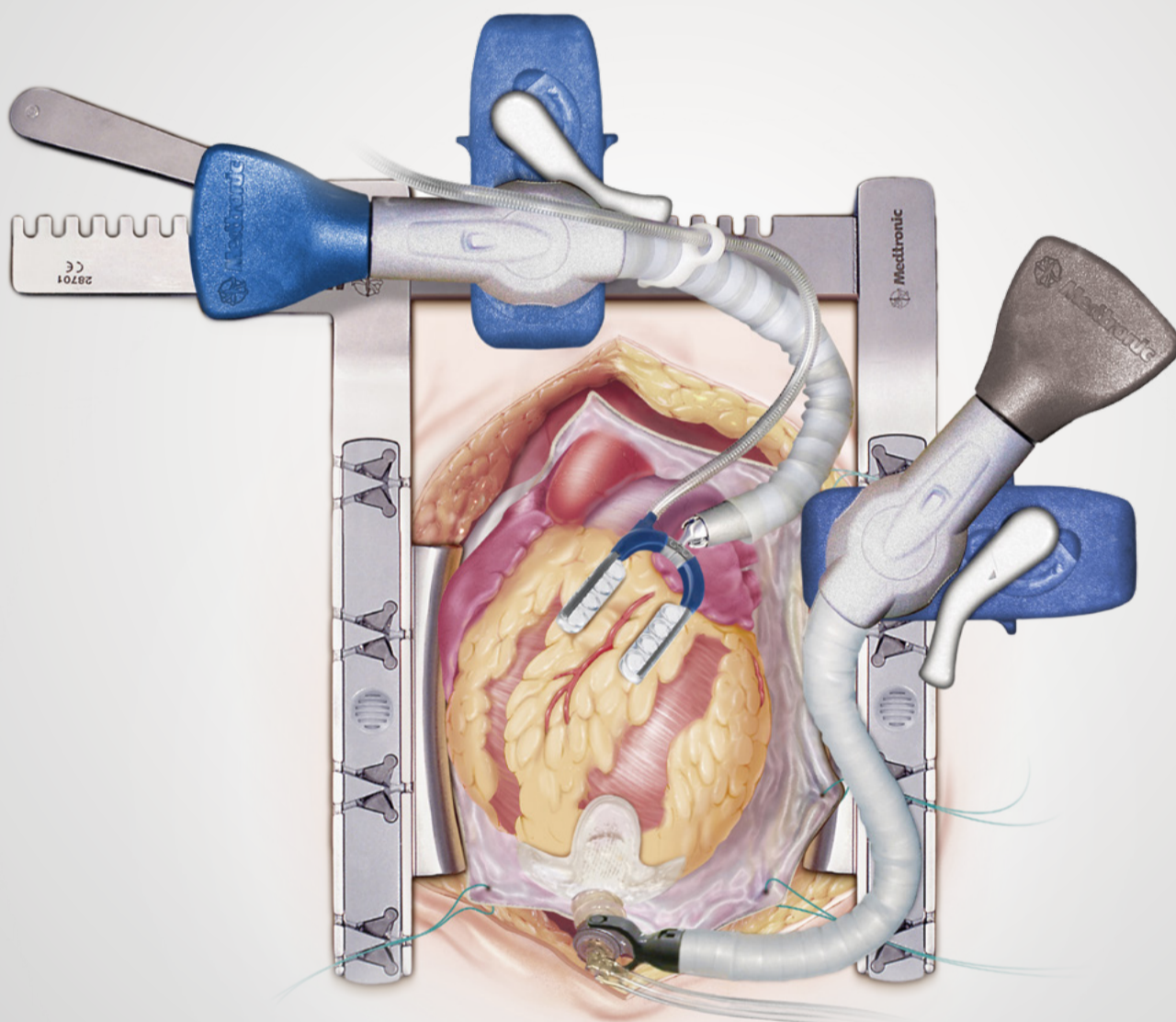

OPCAB

Conventional Beating Heart Surgery

Reliable stability for completing a beating heart anastomosis based on each surgeons preference.

TABLE OF CONTENTS

HEART VALVES

SURGICAL ABLATION

REVASCULARIZATION

Stabilizers

Order Number	Description
TS2500	Octopus Evolution AS Tissue Stabilizer
TS2000	Octopus Evolution Tissue Stabilizer
29403	Octopus 4.3 Tissue Stabilizer
29400	Octopus 4 Tissue Stabilizer



Positioner

Order Number	Description
HP3500	Urchin Evo Heart Positioner

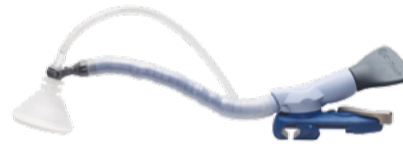

Positioner

Order Number	Description
HP3000	Starfish Evo Heart Positioner



Beating Heart Stabilizer & Positioner Bundles

Order Number	Description
EASE	Octopus Evolution AS Tissue Stabilizer and Starfish Evo Heart Positioner
EAUE	Octopus Evolution AS Tissue Stabilizer and Urchin Evo Heart Positioner
ESE	Octopus Evolution Tissue Stabilizer and Starfish Evo Heart Positioner
EUE	Octopus Evolution Tissue Stabilizer and Urchin Evo Heart Positioner
43ES	Octopus 4.3 Tissue Stabilizer and Starfish Evo Heart Positioner
43EU	Octopus 4.3 Tissue Stabilizer and Urchin Heart Positioner
4EU	Octopus 4 Tissue Stabilizer and Urchin Evo Heart Positioner

MICS Bundles

Order Number	Description
NUB3	1 Starfish NS, 1 Octopus Nuvo
MICS 3	5 Octopus Nuvo, 5 Starfish NS, and 1 Thortrak Retractor System
4ES	1 Octopus 4, 1 Starfish Evo

NOTE: Table clamps are not provided in the MICS Bundles

MICS Accessories

Order Number	Description
28042	Table Clamp



Order Number	Description
28045	Octopus Retractor Adaptor



Octobase Sternal Retractor System

Order Number	Description
28701	Retractor with reusable stainless steel blade inserts
28702	Stainless steel blanks - standard (reusable)
28703	Swivel blades - standard depth (reusable)
28704	Swivel blades - deep (reusable)
28705	Fixed blades - standard depth (reusable)
28706	Fixed blades - deep (reusable)
28707	Suture holder inserts (disposable)
28709	Retractor handle - replacement component
28710	Fixed skirted blades - deep (reusable)



Minimally Invasive Cardiac Surgery

MICS CABG

The stability and familiarity of OPCAB — now available for minimally invasive procedures.

TABLE OF CONTENTS

HEART VALVES

SURGICAL ABLATION

REVASCULARIZATION

Page | 39

Direct Visualization, MICS Made Possible

Medtronic offers a complete portfolio of MICS enabling technologies and training opportunities for today's cardiac surgeons. Consider your options for CABG, Valve and Hybrid Coronary Revascularization (HCR) procedures using minimally invasive techniques and technologies.

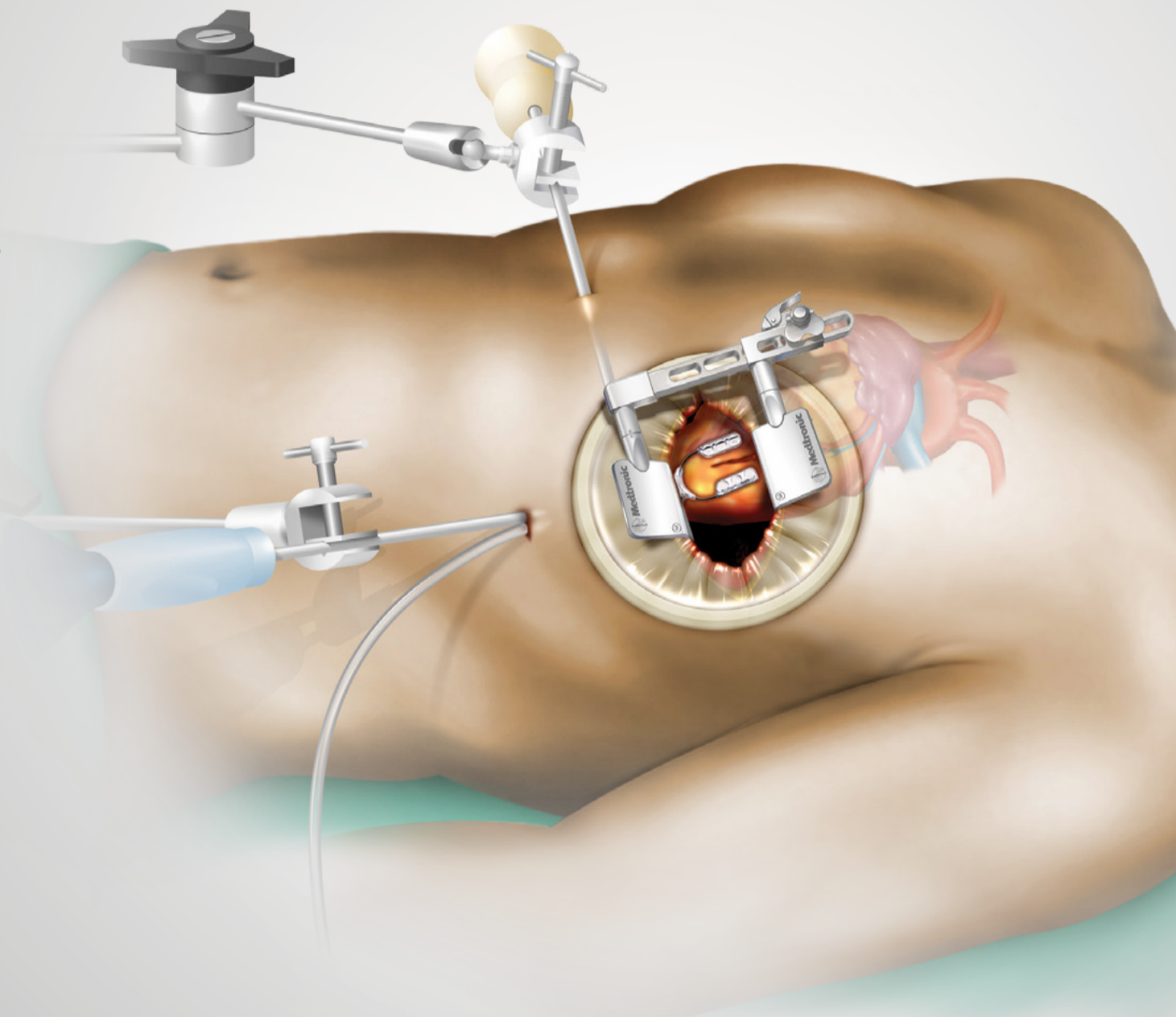

Minimally Invasive Cardiac Surgery

MICS CABG

The stability and familiarity of OPCAB — now available for minimally invasive procedures.

TABLE OF CONTENTS

HEART VALVES

SURGICAL ABLATION

REVASCULARIZATION

Stabilizer

Order Number	Description
TSMICS1	Octopus Nuvo Tissue Stabilizer



Stabilizer

Order Number	Description
TS102	Octopus NS Tissue Stabilizer



Positioner

Order Number	Description
HP102	Starfish NS Heart Positioner



MISC Bundles

Order Number	Description
NUB3	1 Starfish NS, 1 Octopus Nuvo
MICS 3	5 Octopus Nuvo, 5 Starfish NS, and 1 Thoratrak Retractor System
4ES	1 Octopus 4, 1 Starfish Evo

NOTE: Table clamps are not provided in the MICS Bundles

Thoratrak MICS Retractor System

Order Number	Description
28601	Blade - LIMA standard
28602	Blade - LIMA deep
28603	Blade - long thoracotomy standard
28604	Blade - long thoracotomy deep
28604B	Blade - long extended mount standard
28605	Blade - short thoracotomy standard
28606	Blade - short thoracotomy deep
28606B	Blade - short extended mount standard
28610	Thoratrak Retractor System (retractor + multiple blade sets)
28611	Retractor rack



MICS Accessories

Order Number	Description
28042	Table Clamp



Order Number	Description
28045	Octopus Retractor Adaptor



OPCAB Accessories

Enabling Technologies

Contributing to the ease and success of your procedures.

TABLE OF CONTENTS

HEART VALVES

SURGICAL ABLATION

REVASCULARIZATION

Page | 41

More Options for Beating Heart Surgery

Medtronic's numerous accessories can make OPCAB procedures easier and more successful. The Blower/Mister options facilitate a bloodless field. Shunts too provide a clear anastomotic site during the procedure while providing blood flow to the distal myocardium. And, QuickFlow DPS contains a complete set of components designed to establish rapid aorta-to-coronary perfusion during the beating heart procedure.

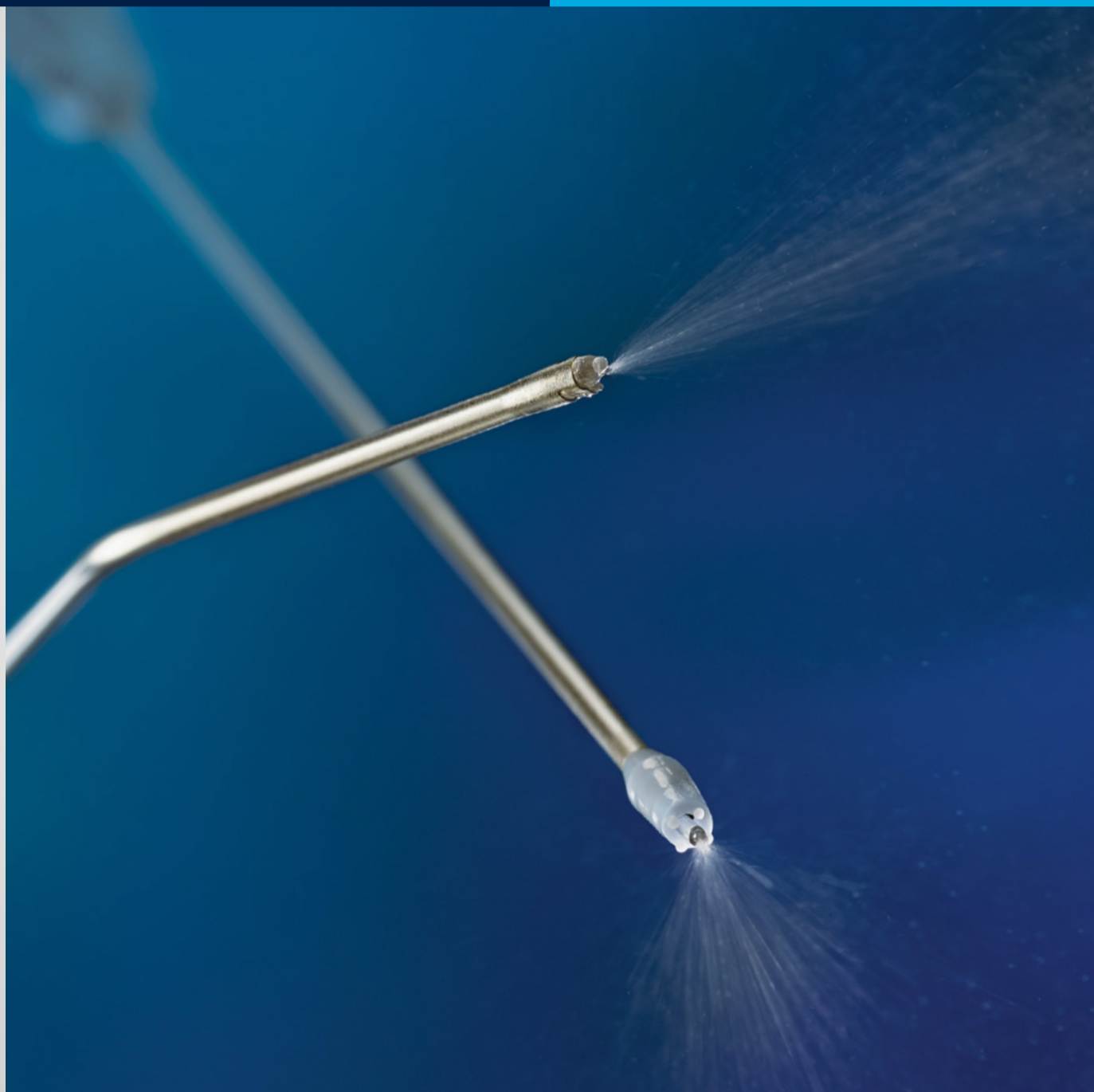

OPCAB Accessories

Enabling Technologies

Contributing to the ease and success of your procedures.

TABLE OF CONTENTS

HEART VALVES

SURGICAL ABLATION

REVASCLARIZATION

Page | 42

Clearview™ Blower/Mister

Order Number	Description
22120	Clearview Blower/Mister (handpiece only) (qty 10)
22150	Clearview Blower/Mister (with attached tubing set) (qty 5)



AccuMist™ Blower/Mister

Order Number	Description
29150	Accumist Blower/Mister (qty 10)



ClearView Shunt

Order Number	Description
31100	1.00mm shunt, 14mm between bulbs (qty 5)
31125	1.25mm shunt, 14mm between bulbs (qty 5)
31150	1.50mm shunt, 14mm between bulbs (qty 5)
31175	1.75mm shunt, 14mm between bulbs (qty 5)
31200	2.00mm shunt, 14mm between bulbs (qty 5)
31225	2.25mm shunt, 14mm between bulbs (qty 5)
31250	2.50mm shunt, 14mm between bulbs (qty 5)
31275	2.75mm shunt, 14mm between bulbs (qty 5)
31300	3.00mm shunt, 14mm between bulbs (qty 5)



Quickflow DPS Distal Perfusion System

Order Number	Description
33100	Quickflow DPS Distal Perfusion System includes: 1-tubing set; 2-2.00mm elongated arteriotomy cannula; 1-3.00mm elongated arteriotomy cannula; 1-4.00mm elongated arteriotomy cannula; 1-14 gauge aortic root cannula



Off-Pump Accessories

Order Number	Description
28030	Vacuum Regulator
VP700	Portable Vacuum Pump with Regulator



For a listing of indications, contraindications, precautions, warnings, and potential adverse events, please refer to the Instructions for Use.

INTERNATIONAL

CAUTION: For distribution only in markets where the products have been approved.

Medtronic

710 Medtronic Parkway
Minneapolis, MN 55432-5604
USA
Tel: (763) 514-4000
Fax: (763) 514-4879
Toll-free: (800) 328-2518

LifeLine

CardioVascular Technical Support
Tel: (877) 526-7890
Tel: (763) 526-7890
Fax: (763) 526-7888
rs.cstechsupport@medtronic.com

Europe

Medtronic International Trading Sàrl
Route du Molliau 31
Case Postale
CH-1131 Tolochenaz
Switzerland
Tel: (41 21) 802-7000

Canada

Medtronic of Canada Ltd.
99 Hereford Street
Brampton, Ontario L6Y 0R3
Canada
Tel: (905) 460-3800
Toll-free: (800) 268-5346

Asia

Medtronic International Ltd.
49 Changi South Avenue 2
Nasaco Tech Centre
Singapore 486056
Singapore
Tel: (65) 6436-5000

Latin America

Doral Corporate Centre II
3750 NW 87th Avenue, Suite 700
Miami, FL 33178
USA
Tel: (305) 500-9328

©2016 Medtronic.
All rights reserved.
Medtronic, Medtronic logo
and Further, Together
are trademarks of Medtronic.
All other brands are trademarks
of a Medtronic company.