

U120 Urine Analyzer



Accurate

- Up to 120 tests/hour in Continuous Test Option
- Test categories include Routine, STAT and QC
- Automatic calibration for accurate results and easy operation

Reliable

- Can read strips with up to 14 parameters, including Microalbumin/Creatinine/Calcium
- Minimal training required

Convenient Operation

- Saves and recalls the last 2,000 results automatically
- Audible beep signals operator to dip strips in urine
- Can print up to 3 copies per test for convenient reviewing and easy record keeping
- Option to print results on sticker paper for quick and simple record management

Easy Data Management

- Includes RS232C and USB ports for easy data transfer to an external computer or LIS
- Record Operator/Patient ID by Manual Entry and Barcode Reader

Specifications

Features	Specifications
Analyzer Type	Manual
Methodology	Reflectance Photometry
Detection	Photosensitive Diode
Throughput	Single Test Option: 60 tests/hour Continuous Test Option: 120 tests/hour
Test Categories	Routine, STAT and QC
Memory	Last 2,000 results
Strip Incubation Time	1 Minute
Wavelength of Monochromatic LED	525 nm and 635 nm
Default Strips	8, 9, 10, 11 Parameters (108 mm x 5 mm)
Strips Available	1-14 parameters (108 mm x 5 mm); see URS Parameters
Total Combinations Per Analyzer	4 Combinations
Analyzer Ports	RS232C Port for Barcode Reader or Data Transfer USB Port for Data Transfer 25 Pin Parallel Port for External Printer
Data Entry Capabilities	Operator/Patient ID - Manual Entry and Barcode Reader (Up to 20 characters)
Connection Capabilities	Internal Thermal Printer (included) RS232C Barcode Reader (optional) Optional External Printer (not included) USB or RS232C Data Transfer Cable (optional)
Major Readable Barcodes	Code 128, Code 39, Codabar (NW-7), EAN 8, EAN 13, Interleave 25, UPCA, UPCE
Calibration	Automatic
Available Languages on the Screen	English and additional language(s)
Operating Conditions	0-40°C (32-104°F); ≤85% RH
Storage Conditions	-5-50°C (23-122°F); ≤90% RH
Power Source	100-240 VAC, 50-60 Hz
Dimensions (L x W x H)	27.2 cm x 26.9 cm x 14.6 cm (10.7" x 10.6" x 5.7")
Display Dimensions (L x W)	10.8 cm x 5.7 cm (4.2" x 2.2")
Weight	2.6 kg (5.7 lbs) without batteries or power supply

Ordering Information

Product Name	Catalog No.	Components	Kit Box Dimensions (L x W x H) & Weight	Carton Dimensions (L x W x H) & Weight	Number of Kits/Carton
U120 Urine Analyzer	U111-101 ^{√X}	1 Urine Analyzer 1 Strip Holder 2 Printer Paper Rolls	2 Fuses (2.0A) 1 Power Cord 1 Quick Start Guide 1 Instruction Manual	42.0 cm x 41.5 cm x 31 cm; 5.0 kg 16.4" x 16.2" x 12.1"; 176.4 oz	1
U120 Urine Analyzer with Barcode Reader	U111-111 ^{√X}	1 Urine Analyzer 1 Strip holder 2 Printer Paper Rolls 1 Barcode Reader (RS232C)	2 Fuses (2.0A) 1 Power Cord 1 Serial Splitter Cable (RS232C) 1 Quick Start Guide 1 Instruction Manual	44.5cm x 44.5cm x 40.0cm; 5.5 kg 17.5" x 17.5" x 15.7"; 194 oz	1
Barcode Reader	U221-111 ^{√X}	1 Barcode Reader (RS232C)	1 Serial Splitter Cable (RS232C)	23.6 cm x 10.8 cm x 7.8 cm; 0.482 kg 9.3" x 4.3" x 3.1"; 17.0 oz 63.0 cm x 37.0 cm x 30.0 cm; 12.0 kg 24.8" x 14.6" x 11.8"; 423.3 oz	22
Printer Paper Rolls	U121-101	4 Printer Paper Rolls	Thermal Paper (0.06 m x 20 m): 200 results/roll Sticker Paper (0.06 m x 9 m): 100 results/roll	12.0 cm x 12.0 cm x 6.5 cm; 0.36kg 4.7" x 4.7" x 2.6"; 12.7oz 12.0 cm x 12.0 cm x 6.5 cm; 0.4 kg 63.0 cm x 37.0 cm x 30.0 cm; 21.4 kg 4.7" x 4.7" x 2.6"; 14.1 oz 24.8" x 14.6" x 11.8"; 684.3 oz; 754.9 oz	50
U120 Data Transfer Kit	U221-131 ^{√X}	1 Data Transfer Cable (RS232C)	1 Package Insert	16.0 cm x 13.0 cm x 3.5 cm; 0.147 kg 6.3" x 5.1" x 1.4"; 5.2 oz 25.0 cm x 21.0 cm x 15.0 cm; 1.36 kg 9.8" x 8.3" x 5.9"; 48.0 oz	8

√ CE Marked for sale in the European Community 

X FDA 510(k) Cleared and CLIA Waived

Urine Controls

Reliable

- Use with *Mission*[®] and *Mission*[®] *Expert* Urinalysis Reagent Strips and Urine Analyzers for optimum quality control
- Validate urinalysis results and prevent procedure errors

Quick and Convenient Testing

- Ensures accurate results for all parameters
- Obtain quick results in any setting
- Competitively priced

Two Types of Urine Controls Available

Liquid Urine Control

- Ready to use without dissolving in distilled water
- 24 months shelf life for unopened controls at 2-8°C
- Two Packaging Options
 - Dropper Tip Bottles
 - Dropper tip bottles provide efficient use of the control solution
 - Easily drop the control solution onto each reagent pad using the dropper tip bottle
 - Controls can be used up to 40 times within 30 days at room temperature
 - Diptubes
 - Diptube packaging allows for quick testing similar to using a urine specimen
 - Simply dip the strip into the control solution and read results
 - Controls can be used up to 20 times within 30 days at room temperature

Dry Strip Urine Control

- Portable for use anywhere with no refrigeration required
- Dissolve the dry strip urine control in distilled water, dip urine strip in the control solution, then compare to color chart
- Each control solution can be used for up to 12 tests at 2-30°C within 8 hours for all parameters
- 24 months shelf life at 2-30°C for unopened controls

Specifications

Features	Specifications		
Product Name	Liquid Urine Control	Liquid Diptube Urine Control	Dry Strip Urine Control
Test Parameters	LEU, NIT, URO, PRO, pH, BLO, SG, KET, BIL, GLU, ASC, ALB, CRE, CA (13)		
Solution Detection Levels	Level 1	Negative: LEU, NIT, URO, PRO, pH, BLO, SG, KET, BIL, GLU, ASC, ALB, CRE, CA	
	Level 2	Positive: LEU, NIT, URO, PRO, pH, BLO, SG, KET, BIL, GLU, ALB CRE, CA and Negative ASC	
Compatible Urine Strips	<i>Mission</i> [®] Urinalysis Reagent Strips, <i>Mission</i> [®] <i>Expert</i> Urinalysis Reagent Strips		
Reading Time/Stability	Refer to insert	Refer to insert	Refer to insert
Storage Temperature	2-8°C	2-8°C	2-30°C
Unopened Control Shelf Life	24 months	24 months	24 months
Opened Control Stability	30 days at 15-30°C or until the expiration date at 2-8°C	30 days at 15-30°C or until the expiration date at 2-8°C	2-30°C: 3 months for Dry Strip; 8 hours for Control Solution for all parameters
Maximum Tests per Unit	20 or 40 tests/bottle	20 tests/diptube	12 tests/control solution of 1 dry strip

Ordering Information

Product Name	Catalog No.	Components	Kit Box Dimensions (LxWxH) & Weight	Carton Dimensions (LxWxH) & Weight	# Kits/Carton
Liquid Urine Control ✓X	U021-011	Level 1: 3 x 10 mL /bottle; Level 2: 3 x 10 mL/bottle	85 mm x 55 mm x 60 mm; 107 g	400 mm x 270 mm x 345 mm; 5.2 kg	198
		Level 1: 3 x 5 mL/bottle; Level 2: 3 x 5 mL/bottle	85 mm x 55 mm x 60 mm; 75 g	400 mm x 270 mm x 345 mm; 4.2 kg	198
		Level 1: 1 x 10 mL/bottle; Level 2: 1 x 10 mL/bottle	55 mm x 28 mm x 60 mm; 41 g	400 mm x 270 mm x 345 mm; 6.6 kg	228
		Level 1: 1 x 5 mL/bottle; Level 2: 1 x 5 mL/bottle	55 mm x 28 mm x 60 mm; 31 g	400 mm x 270 mm x 345 mm; 5.5 kg	228
Liquid Diptube Urine Control ✓X	U021-071	Level 1: 2 x 12 mL/diptube; Level 2: 2 x 12 mL/diptube	130 mm x 55 mm x 55 mm; 101 g	385 mm x 255 mm x 320 mm; 4.7 kg	30
		Level 1: 1 x 12 mL/diptube; Level 2: 1 x 12 mL/diptube	130 mm x 55 mm x 55 mm; 62 g	385 mm x 255 mm x 320 mm; 3.5 kg	30
Dry Strip Urine Control ✓X	U021-041	Level 1: 1 x 25 strips/canister; Level 2: 1 x 25 strips/canister	100 mm x 51 mm x 110 mm; 126 g	280 mm x 280 mm x 260 mm; 3.6 kg	24
		Level 1: 1 x 10 strips/canister; Level 2: 1 x 10 strips/canister	100 mm x 51 mm x 110 mm; 106 g	280 mm x 280 mm x 260 mm; 3.1 kg	24

✓ CE Marked for sale in the European Community 

X FDA 510(k) Cleared and CLIA Waived

We also offer other rapid diagnostic and medical products for:

Blood Glucose Monitoring Systems, Clinical Chemistry including Urinalysis, Immunoassay EIA/ELISA and more.

Contact us for worldwide distribution and custom manufacturing (OEM) opportunities



ACON Laboratories, Inc., 10125 Mesa Rim Road, San Diego, CA 92121, U.S.A. • Tel: 1-858-875-8000 • Fax: 1-858-200-0729 • E-mail: info@aconlabs.com
Please visit our website for details: www.aconlabs.com

Mission® Urinalysis Strips and Controls



Mission® Urinalysis Reagent Strips

Simple to use

- Analytical sensitivity comparable to market leaders
- High quality color chart ensures accurate visual reading
- Compatible for visual and analyzer reading
- Over 35 different combinations available

Multiple Packaging Options

Canister Packaging

- Available in 25, 50, and 100 strips per canister
- Available in 150 strips per canister without MA/CRE Combo

Pouch Packaging

- Individually packaged strips available in kits of 3 or 6 strips for visual reading only (includes 1 color chart)
- Unique packaging maintains 2 year shelf life for all strips in the kit

Shelf Life

- 2 year shelf life for unopened canisters offers cost savings
- 3 month shelf life for strips in opened canisters

Reagent Strips 3 Easy Steps

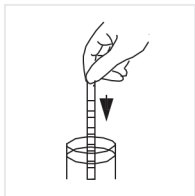

STEP 1
Immerse strip into urine

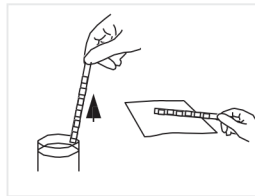

STEP 2
Remove excess urine

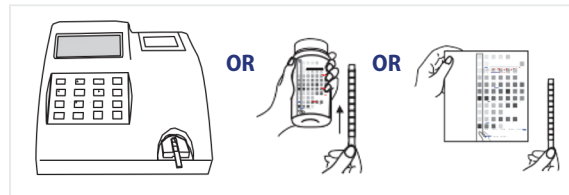

STEP 2
Obtain results by analyzer or visual reading



**High Quality
Color Chart**



**Large Choice
of Parameter
Combinations**



**Individually
Pouched Strips**

Urinalysis Reagent Strip – Combinations for Visual Reading

Catalog Number	Number of Parameters	Type of Strip	Parameter Order (First parameter is closest to strip handle)	ASC	GLU	BIL	KET	SG	BLO	PH	PRO	URO	NIT	LEU	ALB	CRE	CA
U031-141	14	14C	Ca/Blo/pH/Cre/Nit/Ket/SG/Asc/Glu/Bil/Pro/Alb/Uro/Leu	*	*	*	*	*	*	*	*	*	*	*	*	*	*
U031-131	13	13CE	Blo/pH/Cre/Nit/Ket/SG/Asc/Glu/Bil/Pro/Alb/Uro/Leu	*	*	*	*	*	*	*	*	*	*	*	*	*	
U031-111	11	11A	Asc/Glu/Bil/Ket/SG/Blo/pH/Pro/Uro/Nit/Leu	*	*	*	*	*	*	*	*	*	*	*			
U031-101	10	10U	Glu/Bil/Ket/SG/Blo/pH/Pro/Uro/Nit/Leu		*	*	*	*	*	*	*	*	*	*			
U031-091	9	9U	Glu/Bil/Ket/SG/Blo/pH/Pro/Uro/Nit		*	*	*	*	*	*	*	*	*				
U031-081	8	8U	Glu/Bil/Ket/Blo/pH/Pro/Uro/Nit		*	*	*		*	*	*	*	*				
		8N	Glu/Ket/SG/Blo/pH/Pro/Nit/Leu1		*		*	*	*	*	*		*	*			
		8S	Glu/SG/Blo/pH/Pro/Uro/Nit/Leu		*			*	*	*	*	*	*	*			
		8K	pH/Glu/Bil/Pro/Uro/Nit/Leu/Ket		*	*	*			*	*	*	*	*	*		
U031-071	7	7N	Glu/Ket/Pro/pH/Blo/Nit/Leu		*		*		*	*	*		*	*			
U031-061	6	6N	Glu/Pro/pH/Blo/Nit/Leu		*				*	*	*		*	*			
		6U	Bil/SG/Blo/Uro/Pro/Nit			*		*	*		*	*	*				
U031-051	5	5B	Glu/Ket/Pro/pH/Blo		*		*		*	*	*						
		5N	Glu/Pro/Nit/Blo/Leu		*				*		*		*	*			
		5S	Glu/SG/Pro/pH/Blo		*			*	*	*	*						
		5U	Bil/Uro/Leu/Nit/Blo			*			*			*	*	*			
U031-041	4	4P	Glu/Pro/Nit/Leu		*						*		*	*			
		4S	Glu/SG/pH/Pro		*			*		*	*						
		4B	Glu/Pro/pH/Blo		*				*	*	*						
		4K	Glu/Ket/Pro/pH		*		*			*	*						
		4G	Pro/Glu/Leu/Blo		*				*		*				*		
		4N	Pro/Nit/Blo/Leu						*		*		*	*			
U031-031	3	3P	Glu/pH/Pro		*					*	*						
		3K	Glu/Ket/Pro		*		*				*						
		3G	Glu/Ket/pH		*		*			*							
		3N	Blo/Nit/Leu						*				*	*			
U031-021	2	2G	Glu/Pro		*						*						
		2K	Glu/Ket		*		*										
		2N	Nit/Leu										*	*			
		2B	Blo/Leu						*					*			
		2U	Bil/Uro			*						*					
		2S	SG/pH					*		*							
		2C	Alb/Cre												*	*	
U031-011	1	1B	Blo						*								
		1P	pH							*							
		1G	Glu		*												
		1K	Ket				*										
		1R	Pro									*					

TYPE OF STRIP: 1-10 Parameters – 510(k) Cleared, CLIA Waived and CE Marked for sale in the European Community; 11-13 and 14 Parameters only CE Marked for sale in the European Community

Mission® Urinalysis Strips and Controls



Mission® Urine Controls

Accurate

- Use with Mission® and Mission® Expert Urinalysis Reagent Strips and Urine Analyzers for optimum quality control
- Validate urinalysis results and prevent procedure errors

Quick Testing

- Ensures accurate results for all parameters
- Obtain quick results in any setting
- Competitively priced

Two Types of Urine Controls available

- Ready to use without dissolving in distilled water
- 24 months shelf life for unopened controls at 2 - 8 °C
- Two Packaging Options

Dropper Tip Bottles

- Dropper tip bottles provide efficient use of the control solution
- Easily drop the control solution onto each reagent pad using the dropper tip bottle
- Controls can be used up to 30 days at room temperature
- Controls can be used until the expiration date if kept refrigerated

Diptubes

- Diptube packaging allows for QC testing in a way similar to using a urine specimen
- Simply dip the strip into the control solution and read results, or place on strip tray for analyzer reading
- Controls can be used 30 days at room temperature
- Do not dip more than 20 strips into the tube to avoid inaccurate results
- Controls can be used until the expiration date if kept refrigerated



High Quality
Color Chart



Large Choice
of Parameter
Combinations



Dropper bottles
or Dip Tubes

Mission® Urinalysis Strips and Controls



Urine Control Specifications

Features	Specifications	
Product Name	Liquid Urine Control	Liquid Diptube Urine Control
Test Parameters	LEU, NIT, URO, PRO, pH, BLO, SG, KET, BIL, GLU, ASC, ALB, CRE, CA (13)	
Solution Detection Levels	Level 1	Negative: LEU, NIT, URO, PRO, pH, BLO, SG, KET, BIL, GLU, ASC, ALB, CRE, CA
	Level 2	Positive: LEU, NIT, URO, PRO, pH, BLO, SG, KET, BIL, GLU, ALB CRE, CA and Negative ASC
Compatible Urine Strips	Mission® Urinalysis Reagent Strips and Mission® Expert Urinalysis Reagent Strips	
Reading Time/Stability	Refer to insert	Refer to insert
Storage Temperature	2 - 8 °C	2 - 8 °C
Unopened Control Shelf Life	24 months	24 months
Opened Control Stability	30 days at 15 - 30 °C or until the expiration date at 2 - 8 °C	30 days at 15 - 30 °C or until the expiration date at 2 - 8 °C
Maximum Tests per Unit	20 to 40 tests/bottle	20 tests/diptube

Ordering Information

Product Name	Product Number	Components	Kit Box Dimensions (LxWxH) & Weight	Carton Dimensions (LxWxH) & Weight	# Kits /Carton
Liquid Urine Control	U021-011	Level 1: 3 x 10 mL /bottle; Level 2: 3 x 10 mL/bottle	85 mm x 55 mm x 60 mm; 107 g	400 mm x 270 mm x 345 mm; 5.2 kg	198
		Level 1: 3 x 5 mL/bottle; Level 2: 3 x 5 mL/bottle	85 mm x 55 mm x 60 mm; 75 g	400 mm x 270 mm x 345 mm; 4.2 kg	198
		Level 1: 1 x 10 mL/bottle; Level 2: 1 x 10 mL/bottle	55 mm x 28 mm x 60 mm; 41 g	400 mm x 270 mm x 345 mm; 6.6 kg	228
		Level 1: 1 x 5 mL/bottle; Level 2: 1 x 5 mL/bottle	55 mm x 28 mm x 60 mm; 31 g	400 mm x 270 mm x 345 mm; 5.5 kg	228
Liquid Diptube Urine Control	U021-071	Level 1: 2 x 12 mL/diptube; Level 2: 2 x 12 mL/diptube	130 mm x 55 mm x 55 mm; 101 g	385 mm x 255 mm x 320 mm; 4.7 kg	30
		Level 1: 1 x 12 mL/diptube; Level 2: 1 x 12 mL/diptube	130 mm x 55 mm x 55 mm; 62 g	385 mm x 255 mm x 320 mm; 3.5 kg	30

All Urine Controls are 510(k) Cleared, CLIA Waived and CE Marked for sale in the European Community



aconlabs.com

ACON Laboratories, Inc.
 10125 Mesa Rim Road, San Diego, CA 92121, U.S.A.
 Tel: 1.858.875.8000
 Fax: 1.858.200.0729
 Email: info@aconlabs.com

U120 Ghid de inițiere rapidă

Amplasați analizorul pe o suprafață plană. Conectați cablul de alimentare într-o priză electrică, apăsați butonul situat pe panoul din spate pentru a porni analizorul U120.

U120 va efectua un auto-test. Fără suport de bandă instalată, auto-testul va eșua indicând “*Optical Sensor Failed*”. Opriți analizatorul U120.

Instalarea hîrtiei de imprimare

Deschideți capacul imprimantei. Introduceți rola de hîrtie în boxa imprimantei. Ridicați partea din spate a manetei de eliberare a hîrtiei spre partea din față a analizorului. Introduceți hîrtia sub rola imprimantei.

Scoateți aproximativ 10cm de hîrtie deasupra **Rolei Imprimantei**.

Apasați partea frontală al **Manetei de Eliberare de hîrtie** pentru a bloca **Rola Imprimantei**.

Inserați hîrtia, spre **Slotul de Acces a Imprimantei**, în **Capacul Imprimantei**.

Reduceți **capacul** imprimantei în poziția inițială închisă.

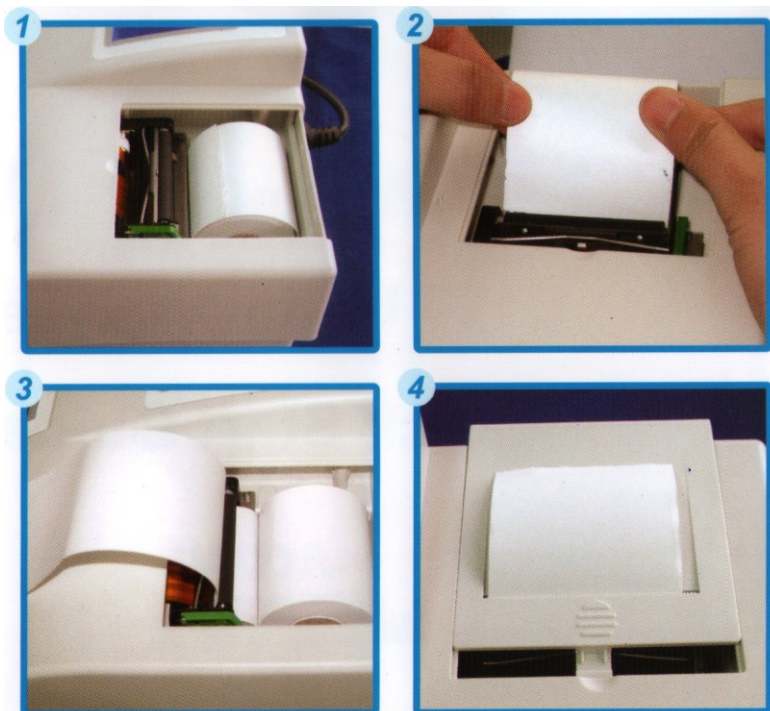

Instalarea suportului pentru benzi

Îndepărtați ambalajul de plastic de pe suportul pentru banda. Introduceți Suportul pentru Banda în orificiu pentru suport. Împingeți suportul pentru bandă spre analizor.



Pornirea analizorului

Porniți analizorul. Tastați **MENU** pentru a configura analizorul

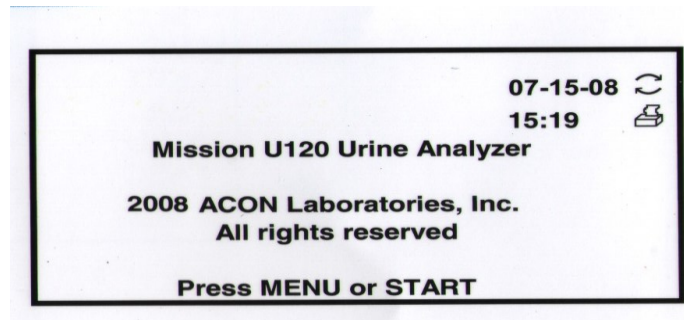

Configurarea

Selectați opțiunile prin apăsarea ▲ sau ▼ până când săgeata (→) va fi alături în drept cu opțiunea dorită. Tastați **ENTER** pentru a afișa opțiunile într-un nou ecran, sau mergeți prin setările enumerate mai jos. Tastați **EXIT**, apoi **ENTER** pentru a reveni în meniu principal.

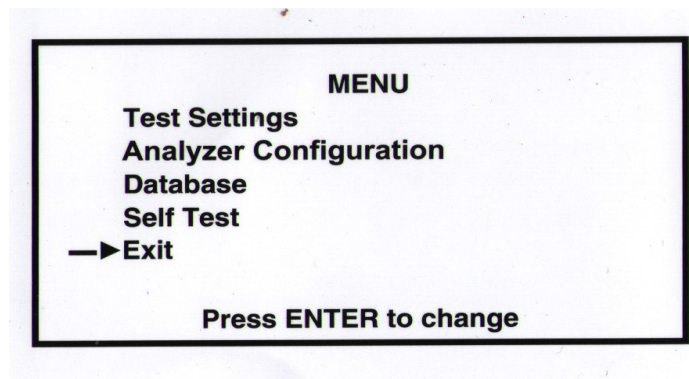

Tip de bandă

Selectați **TIP DE TEST**, apoi tastați **ENTER** pentru a schimba tipul de bandă. Fiecare tip de bandă definește numărul de parametri de testare în cazul dat, 11 parametri. Fiecare apăsare a butonului **ENTER** permite să circulați prin toate opțiunile. Tastați butonul **ENTER** pentru a selecta opțiunea dorită.

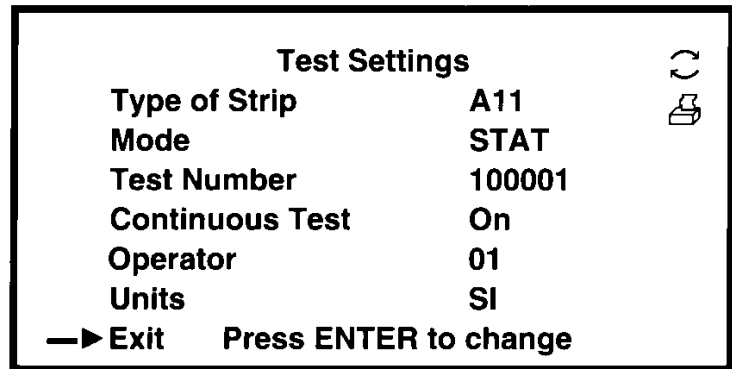

Selectarea regimului

Selectați **MODE** apoi tastați butonul **ENTER** pentru a reveni la regimul **NORMAL**.

Alegerea regimului de testare în mod continuu.

Selectați **CONTINUOUS TEST** și tastați **ENTER** până când opțiunea **SINGLE TEST** va fi în regimul **OFF**.

Selectarea unităților

Selectați **UNITS** apoi tastați **ENTER** pentru a selecta una dintre **CONVENTIONAL** sau **SI** unități. Selectați **EXIT** apoi tastați **ENTER**. Selectați **ANALYZER CONFIGURATION** apoi tastați **ENTER**.

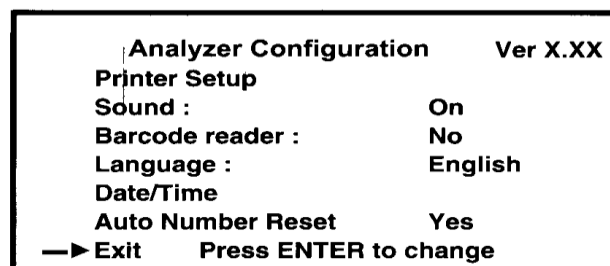

Stabilirea datei și orei

Selectați **DATE/TIME** pentru a vedea data/ora în meniu. Selectați **DATE FORMAT** și **TIME FORMAT** apoi tastați butonul **ENTER** .

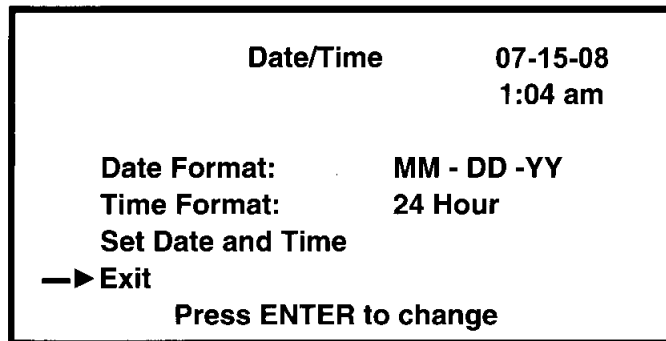

Selectați **SET DATE and TIME** apoi tastați **ENTER**. Urmăriți instrucțiunile de pe ecran pentru a seta ora și data curentă. Tastați **ENTER** pentru a accepta schimbările. Tastați **ENTER** încă o dată pentru ieși din **DATA/TIME** meniu.

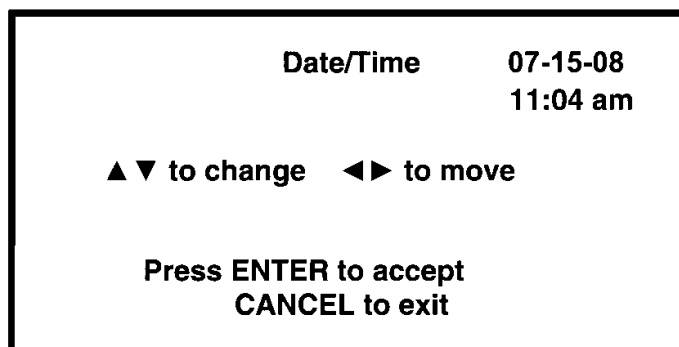

Limba

Selectați **LANGUAGE**, tastați **ENTER**, apoi selectați limba necesară.

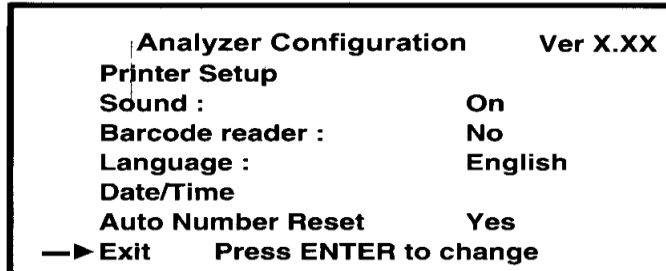

Coduri de bare

Dacă Codul de Bare lipsește, tastați **NO**. Dacă coduri de bară sunt, atunci tastați **YES**.

Sunete

Selectați **SOUND** apoi tastați **ENTER** pentru a alege opțiuni audio.

Configurarea imprimantei

Selectați **PRINTER SETUP** apoi tastați **ENTER** pentru a afișa configurarea imprimantei pe ecran. Selectați **PRINTER SELECT** apoi tastați **ENTER** pentru a alege opțiunile **INTERNAL** sau **EXTERNAL**. Pentru a utiliza imprimanta internă, setați opțiunea **INTERNAL**.

Selectați **AUTO-PRINT** apoi tastați **ENTER** pentru a selecta opțiunile **OFF** sau **ON**. Selectați **ON** pentru a imprima automat toate rezultatele.

Selectați **PRINT COPIES** apoi tastați **ENTER** pentru a alege numărul de copii, de la 1 până la 3.

Selectați **EXIT** apoi tastați **ENTER** pentru a ieși din acest meniu.

Selectați **EXIT** apoi tastați **ENTER** pentru a reveni în meniu principal.

Selectați **EXIT** apoi tastați **ENTER** pentru a reveni la ecranul inițial.

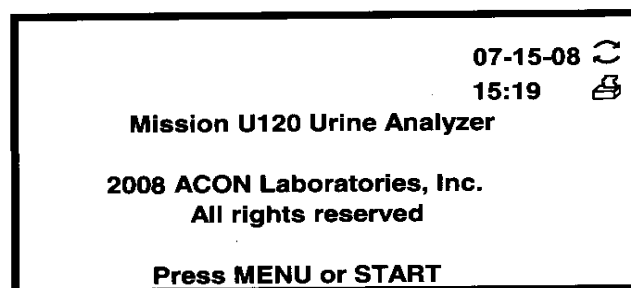
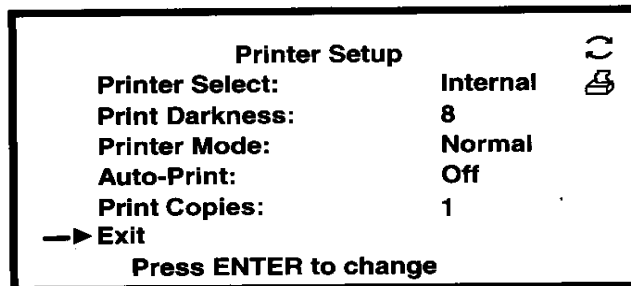

Începerea testării

Tastați butonul **START** pentru a extinde suportul benzi și pentru a arată meniul de testare. Pregătiți toate materiale necesare pentru testare, tastați **START** pentru a afișa ecranul de testare.

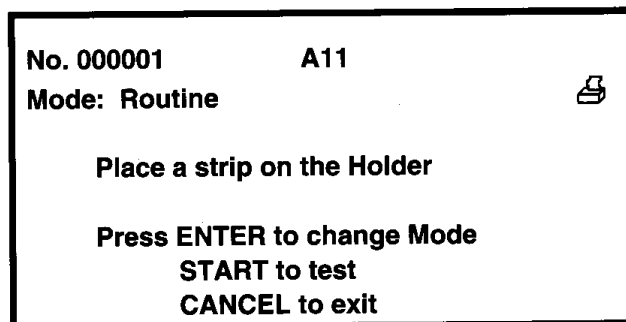

În partea dreapta de jos a ecranului va fi indicat cronometrul, începând de la **65** de secunde. Cufundați o nouă bandă în proba de urină, care urmează să fie testată. Uscați excesul de proba din banda și puneți-o pe suportul de bandă atunci, când cronometrul ajunge la **62** de secunde. Veți auzi semnal sonor triplu. Testul de bandă va rămâne pe suportul de banda până când va fi deplasată în analizor. Rezultatele sunt citite și afișate. Suportul de bandă revine pe banda în poziția extinsă. Puteți să eliminați banda.

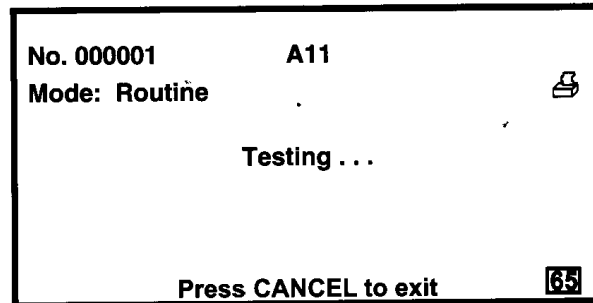

Rezultate de imprimare

Unități arbitrare vor fi imprimate întotdeauna. Rezultatele Convenționale sau SI vor fi imprimate în funcție de setări.

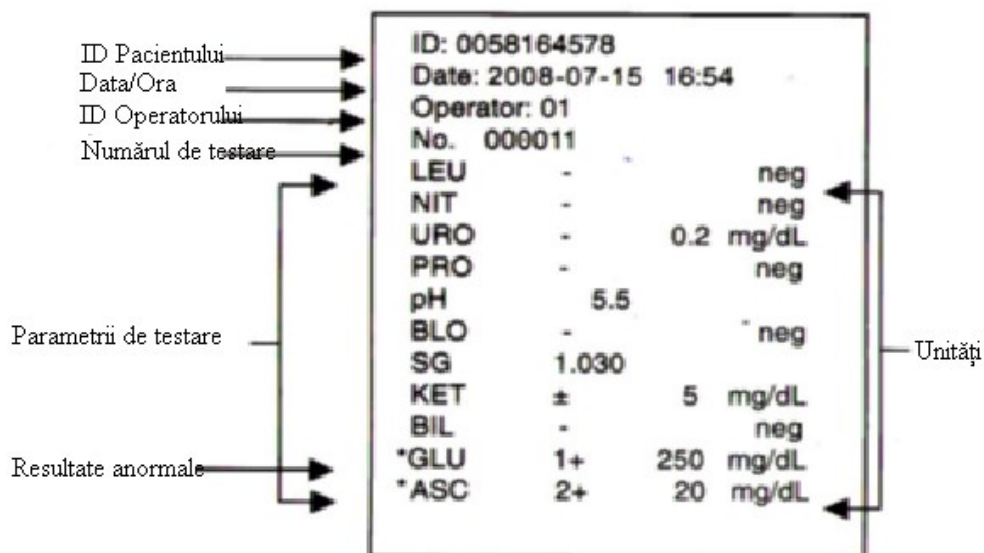

Table of Contents

Section 1	Introduction	1
	Intended Use.....	1
Section 2	Analyzer Components	2
	Analyzer Component Illustrations.....	2
Section 3	Initial Startup	3
Section 4	Analyzer Setup	5
	Test Settings	5
	Type of Strip.....	5
	Mode.....	6
	Test Number.....	6
	Continuous Test.....	7
	Operator ID.....	7
	Units.....	7
	Analyzer Configuration	7
	Printer Setup.....	7
	Sound.....	8
	Barcode reader.....	9
	Language.....	9
	Date/Time.....	9
	Auto Number Reset.....	10
	Database	10
	Clear all Records.....	11
	Locate Record.....	11
	View Current Record.....	11
	Self Test	12
	QC Test	12
	QC Setup.....	12
	Run QC Test.....	13
	Setting the QC Values.....	14
	User Login	14
	ID Admin.....	14
Section 5	Analyzer Operation	17
	Entering Canister Code	18
	Normal Operation, no Barcode reader	20
	Sample/Strip Preparation.....	20
	Strip Test – Single Test Mode.....	20
	Strip Test – Continuous Test Mode.....	22
	Normal Operation, Barcode reader installed	23
	Strip Test – Single Test Mode with Barcode reader.....	24
	Strip Test – Continuous Test Mode with Barcode reader.....	25
	Urine Controls QC Testing	26
	Strip Preparation.....	26
	Urine Control Test Procedures.....	27
	QC lockout	27
Section 6	Data/Communication	29
	External Printer.....	29
	Barcode reader.....	29
Section 7	Quality Control	30
Section 8	Maintenance	31
	Loading Printer Paper	31
	General Cleaning	32
	Daily Cleaning	32
	Remove the Strip Holder.....	32
	Clean the Strip Holder.....	32
	Load the Strip Holder.....	32
	Return the Strip Holder/Mount to its Internal Position.....	33
	Sample Deposit Cleaning	33
	Strip Holder Sterilization	33
Section 9	Precautions	34
Section 10	Troubleshooting	35
Appendix 1	Urine Analyzer Specifications	36
Appendix 2	Performance Characteristics of Urinalysis Reagent Strips	37
Appendix 3	URS Parameter Table	43
Appendix 4	Result Print-Out	44
Appendix 5	Barcode reader	45
Appendix 6	Catalog	46
Appendix 7	Index of Symbols	47
Appendix 8	Warranty	48

Section 1 Introduction

The **Mission**[®] U120 Urine Analyzer reads urine test strips. It stores results and prints reports without the need for special training.

The **Mission**[®] U120 Urine Analyzer runs a self-test each time the power switch is turned on. An optional barcode reader records patient ID. The barcode reader verifies strip canister barcodes. Use only **Mission**[®] Urinalysis Reagent Strips with the canister barcode for correct results.

The **Mission**[®] U120 Urine Analyzer is CLIA waived when used with strips of the same brand as the analyzer. Only laboratories with a Certificate of CLIA Waiver may use this analyzer in a waived setting. Users should read this complete test procedure before performing a test using this analyzer. Failure to adhere to these instructions for use and for performing QC testing is considered off-label use. Off-label use is categorized as high complexity and subject to all CLIA regulations.

Intended Use

The **Mission**[®] U120 Urine Analyzer is intended for use in conjunction with the **Mission**[®] Urinalysis Reagent Strips for the semi-quantitative detection of the following analytes in urine: Glucose, Bilirubin, Ketone (Acetoacetic acid), Specific Gravity, Blood, pH, Protein, Urobilinogen and Leukocytes as well as the qualitative detection of Nitrite. The instrument is intended for professional, in vitro diagnostic use only.

Note: Keys on the Keypad are listed in **bold**. Display items on the screen are listed in ***bold italics*** in the manual.

Section 2 Analyzer Components

Analyzer Component Illustrations

1. Keypad
2. Liquid Crystal Display
3. Printer Cover
4. Paper Release Lever
5. Printer Roller
6. Printer Paper
7. Printer Cover Pull
8. Printer Paper Access Slot
9. Strip Holder
10. Strip Holder Channel
11. Strip Holder Stop
12. White Calibration Circle
13. Strip Holder Mount
14. USB Port
15. External Printer Port
16. Standard RS232C Port
17. Power Socket
18. Fuses
19. Power Switch

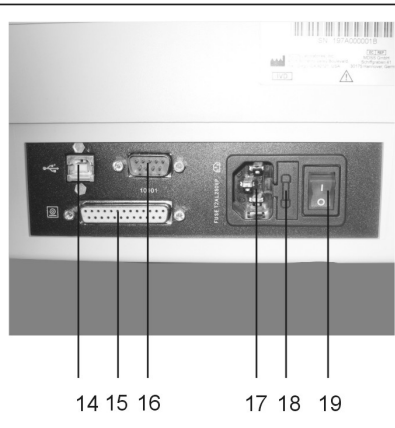
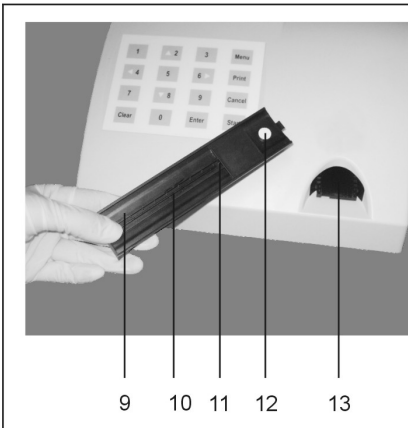
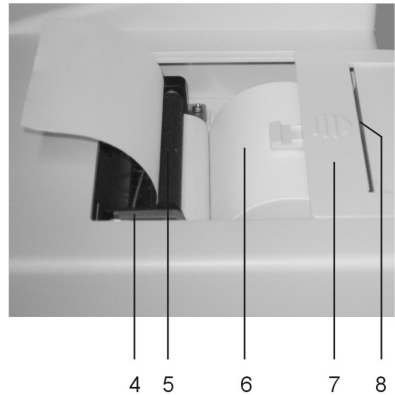
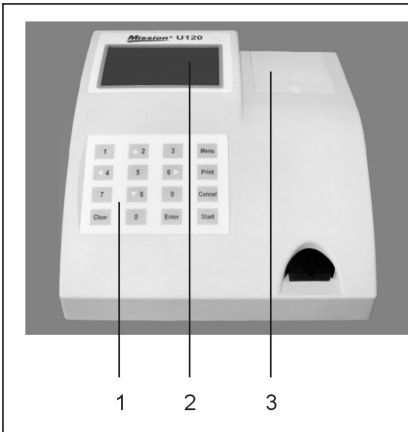

Section 3 Initial Startup

Place the analyzer on a level surface. Allow 80*50 cm on all sides of the analyzer for access.

Plug the power cord into a power outlet. Press the power switch (19) located on the back panel to turn the **Mission**® U120 Urine Analyzer on. The **Mission**® U120 Urine Analyzer will run a Self-Test. The analyzer will display the screen shown below.

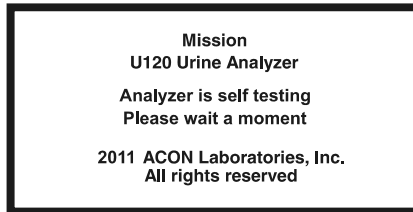

“Optical Sensor Failed” will display due to lack of Strip Holder. The Strip Holder Mount will extend for Strip Holder installation. Turn off the Power Switch.

Remove the Strip Holder from its plastic packaging. Place the Strip Holder on the Strip Holder Mount. Position the white Calibration Circle up and towards the back of the analyzer. It will slide loosely in the locating channel. Push the Strip Holder in until it clicks into place. It will be held firmly on the Strip Holder Mount. Ensure the Strip Holder is installed properly. If it is not locked onto the Strip Holder Mount the analyzer will display “Optical Sensor Failed.”



Turn the Power Switch on. If the Self-Test passes, the Initial Screen will be shown.

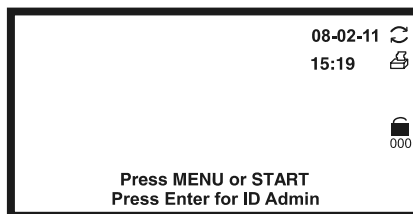

Note: The screen will not display  if Strip Lockout is not included.

If the Self-Test fails, a **Failed** Screen will be displayed. The analyzer cannot be

operated. Press the power switch off then on to re-test. Refer to Section 10 Troubleshooting to correct a failure.

Press **MENU** to access the Test Settings, Analyzer Configuration, Database functions, Self-Test and QC Test.

Note: Use the arrow keys on the keypad to select **Exit** or press the **Cancel** key when **Exit** is not available.

Press **START** to begin strip testing. Press **ENTER** for **ID Admin**.

Section 4 Analyzer Setup

Press **Menu** from the Initial Screen to display the screen below.

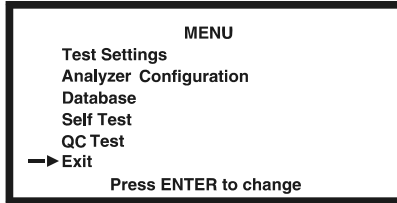

Select options by pressing **▲** or **▼** until the Selection Arrow (→) is next to the option. Press **ENTER** to show the options in a new screen or cycle through the settings below. Select **Exit** and press **ENTER** to return to the Initial Screen.

Test Settings

Select **Test Settings** to display the menu shown below.

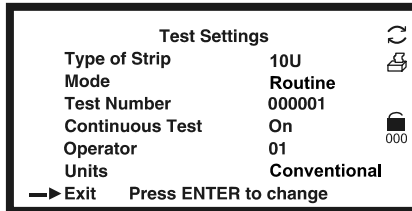

Press **▲** or **▼** to select an option. Press **Enter** to show or change the option settings below. Select **Exit** and press **Enter** to return to the **Main Menu**.

8N, 9U, and 10U are examples of Type of Strips. Refer to Appendix 2 for actual Analyzer-Read Type of Strips.

Type of Strip	8N, 9U and 10U
Mode	Routine, STAT, QC
Test Number	User selected number
Continuous Test	On, Off (single test)
Operator ID	If User Login is off, Operator ID will be 01 through 10. If User login is enabled, Operator ID will be 11 through 20, and 100 for the Administrator
Units	Conventional Units or Standard International (SI)

Type of Strip

Select **Type of Strip** and press **ENTER** to change the strip type. Each strip type name defines the number of test parameters. If **User Login** is enabled and **Operator ID** is 11 through 20, this setting cannot be changed.

Refer to Appendix 2 for a detailed list of available parameters.

Note: Ensure the type of strip selected corresponds with the strip to be used. If it does not, an error message will be displayed.

Mode

There are three test mode options. Press **ENTER** when **Mode** is selected to change the **Mode**.

Note: The Mode can be changed during normal testing for STAT tests.

Routine Test

Use for normal urine testing. The default test number ranges from 1 to 99999. It resets to 1 every day automatically if **Auto Number Reset** is set to **Yes**.

STAT Test

Use for emergency urine testing. The default test number is from 100001 to 199999. It resets to 100001 each day automatically if **Auto Number Reset** is set to **Yes**. The analyzer will automatically switch to **STAT** test and can not be changed if the QC test has failed.

QC Test

Use to test positive/negative controls. If **QC lockout** is on, this test will be run automatically. The test number ranges from 200001 to 299999. It resets to 200001 every day automatically if **Auto Number Reset** is **Yes**.

Note: Ensure **QC Test** mode is used for testing positive and negative controls. Use of any other mode will report the testing results as a regular specimen and will not display proper "Pass/Fail" QC test results.

Test Number

Select **Test Number** and press **ENTER**.

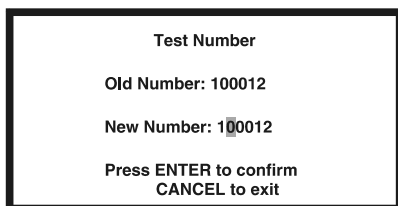

Test Number

Old Number: 100012

New Number: 100012

Press ENTER to confirm
CANCEL to exit

Enter the new **Test Number**. Press **ENTER** to confirm. Press **CANCEL** to delete any changes and keep the existing number.

The first digit in the number will depend on the **Test Mode**. The first digit will be **0** for **Routine**, **1** for **STAT** and **2** for **QC Test**. This first digit is fixed and cannot be changed from this screen. Tests run after this number is changed will be set sequentially from the new number.

Note: Specimens may be assigned the same test number. They will be distinguished by test date and time in the Database.

Continuous Test

Select **Continuous Test** and press **ENTER** to cycle the settings to **Off** or **On**. When the selection is correct, select **EXIT** and press **ENTER** to return to the **Main Menu**.

Continuous Test – Off (Single Test Mode)

Test one strip at a time. **Single Test** Mode performs 60 tests / hour.

Continuous Test - On

Test strips one after another. **Continuous Test** Mode performs up to 120 tests per hour. When **Continuous Test** is on, the ↻ symbol will be displayed.

Operator ID

Select **Operator ID** and press **ENTER** to increase the number by one. After **10**, it reverts back to **01**. If **User Login** is enabled and **Operator ID** is 11 through 20, this setting cannot be changed. Select **EXIT** and press **ENTER** to return to the **Main Menu**.

Units

Select **Units** and press **ENTER** to cycle the units between **Conventional** or **SI** units. If **User Login** is enabled and **Operator ID** is 11 through 20, this setting cannot be changed. Select **EXIT** and press **ENTER** to return to the **Main Menu**.

Note: Arbitrary results will always be printed.

Analyzer Configuration

Select **Analyzer Configuration** from the **Main Menu** to display the screen below.

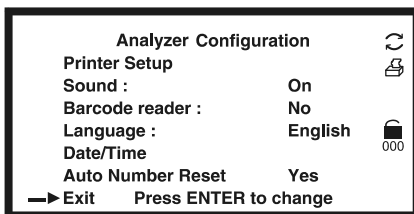

Press **▲** or **▼** to move **→** to make changes. After all changes are made, select **EXIT** and press **ENTER** to save changes and return to the **Main Menu**. If **User Login** is enabled and **Operator ID** is 11 through 20, this **Menu** cannot be changed.

Printer Setup

Select **Printer Setup** to display the screen below.

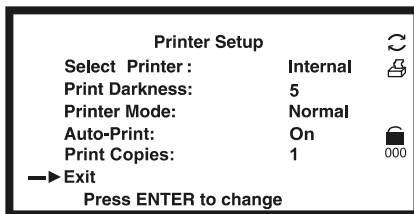

Press ▲ or ▼ to move → to select the options listed below. Press **ENTER** to change the option as shown below.

Select Printer	Internal or External
Print Darkness	1 through 9
Printer Mode	Normal or Expand fonts
Auto-print	On or Off
Print Copies	1 to 3

Select **Exit** and press **ENTER** to save changes. The screen will then return to the previous **Menu**.

Select Printer

Internal prints the results on the internal printer.

External prints the results on an external printer. The symbol **EXT** will display on all screens. Contact your local distributor for a list of printers and printer cables that can be used.



Print Darkness

Print darkness ranges from **1** to **9**. The darkest is **9**. After **9** it reverts back to **1**. The default is **5**.

Printer Mode

Normal prints the standard font size and saves paper. **Expand** prints a larger font size and uses more paper.

Auto-print

Auto-print On prints the results after each test.  is displayed. **Auto-print Off** requires pressing the **Print** key to print the results.  is not displayed.

Print Copies

Print Copies defines the number of result copies printed at one time. **Print Copies** can be set from 1 to 3.

Sound

Select **Sound** and press **ENTER** to cycle the options to **Off**, **On** and **Prompts**. These options function as listed below.

Off – internal speaker is **Off** in all cases

On – Internal speaker is **On** in all cases (keyboard and prompts)

Prompts – Internal speaker is **On** only for prompts to the operator.

Select **Exit** with → and press **ENTER** to save changes. The screen will return to the **Main Menu**.

Barcode reader

Select **Barcode reader** and press **ENTER** to display **Yes** to allow Barcode reading. Press **ENTER** to cycle between **Yes** or **No**. **Yes** displays prompt for full usage of the Barcode reader. The **Barcode reader** icon  will be shown. If the optional Barcode reader is not present, this setting should be set to **No**.

Select **Exit** with → and press **ENTER** to save changes. The screen will return to the **Main Menu**.

Language

Select **Language** and press **ENTER** to change the current language. Each time **ENTER** is pressed the language changes.

Select **Exit** with → and press **ENTER** to save changes. The screen will return to the **Main Menu**.

Date/Time

Select **Date/Time** and press **ENTER** to display the screen to change the date/time as shown below.

Select **Exit** and press **ENTER** to save changes. The screen will return to the previous **Menu**.

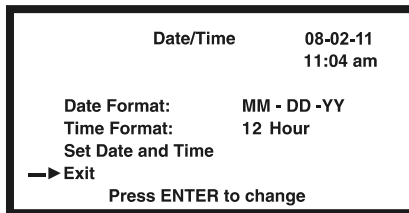

Press ▲ or ▼ to move → to the options listed below. Press **ENTER** to change the selected option.

Date Format

Select **Date Format** and press **ENTER** to cycle to **MM-DD-YY**, **YY-MM-DD** or **DD-MM-YY**.

Time Format

Select **Time Format** and press **ENTER** to cycle to **24 Hour** or **12 Hour**. **12 Hour** displays the time with **am/pm** symbols.

Set Date and Time

Select **Set Date and Time** and press **ENTER** to display a new screen for setting the current date and time.

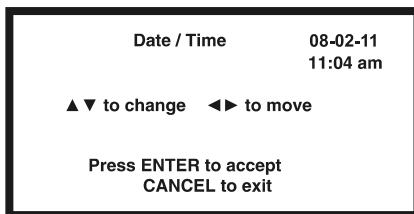

The first digit to be changed in the date will be highlighted. Press **▲** or **▼** to change the number one at a time. Continue to press **▲** or **▼** until the correct number is shown. Press **◀** or **▶** to progress to the next digit to be changed. Press **▲** or **▼** to increase or decrease the number. Change each of the time and date digits/fields in this manner. Press **ENTER** to save the changes and exit the screen. Press **CANCEL** to not accept any changes and exit the screen. Either key will return to the previous screen.

Auto Number Reset

Select **Auto Number Reset** and press **Enter** to cycle to **Yes** or **No**. If **Yes**, the test number will reset to 000001, 100001 or 200001 for **Routine**, **STAT** or **QC** modes each day. If **No** the test number is unaffected by date.

Database

Select **Database** and press **ENTER** to display the screen below.

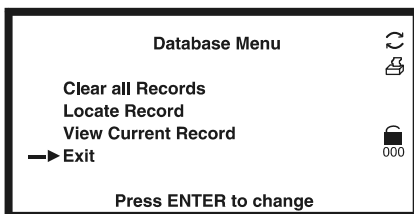

Press **▲** or **▼** to move **→** to enter each screen and make changes. After all changes are made press **ENTER** to save changes and return to the **Main Menu**.

Up to 2000 records can be stored in memory. If **User Login** is enabled and **Operator ID** is 11 through 20, the operator can only review data stored in the analyzer.

Caution: Use a number higher than the previous test number.

If there are 2000 records stored in memory, the oldest record will be erased and replaced.

Records may have the same number but different dates and times.

Clear all Records

Select **Clear all Records** and press **ENTER**. If **User Login** is enabled and **Operator ID** is 11 through 20, the analyzer will not respond.

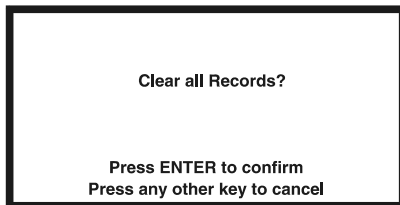

Press **ENTER** to delete all records. A prompt will appear. Once records are deleted they cannot be recovered. The **Test Number** will reset to 000001, 100001 or 200001 depending on the Test Mode. Press any other key to cancel. The screen will return to the **Database Menu**.

Locate Record

Select **Locate Record** and press **ENTER**.

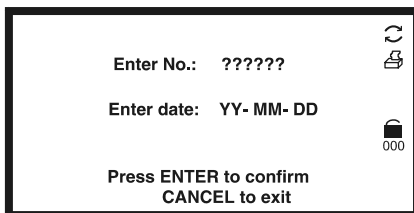

Press the number keys to enter the **Test Number** and/or test **Date**. Press **Enter** to view the results.

If only the **Test Number** is entered records with the current **Date** will be searched.

If there is no **Test Number** with the current **Date**, the latest previous **Date** will be searched. For example, assume the current date is 2007-03-27. There are two records with the same **Test Number** but dates of 2007-03-26 and 2007-03-20. The test from 2007-03-26 will be displayed.

If there is no record found **Record not found** will be displayed. Press any key to return to the **Database Menu**.

Press **Print** to print a record.

Press **▼** to view the previous record. Press **▲** to view the next record.

Press **CANCEL** to return to the previous screen. Additional records can be located, reviewed or printed.

View Current Record

Select **Current Record** and press **ENTER** to show the data from the current or last record.

Press **Print** to print a record once it is displayed.

Press **▼** to view the previous record. Press **▲** to view the next record.

Press **CANCEL** to return to the previous screen.

Self Test

Select **Self Test** and press **ENTER** to perform self tests. A results screen will display the results of each test.

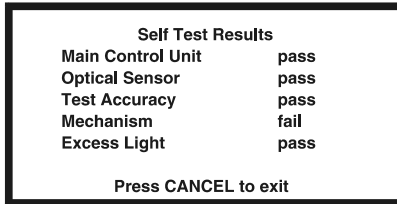

After each test, a **pass** or **fail** is displayed on the screen. If any results **fail**, the unit will not operate. Refer to Section 10 Troubleshooting.

Press **CANCEL** to return to the **Main Menu**.

QC Test

Select **QC Test** and press **ENTER**. If **User Login** is enabled and **Operator ID** is 11 through 20 the operator can only view settings and run a QC test.

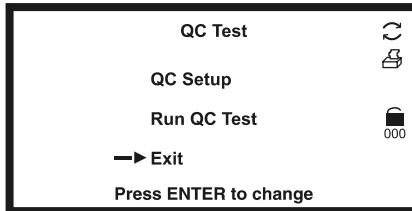

Press **▲** or **▼** to move → to make changes. Select **Exit** and press **ENTER** to save changes.

QC Setup

Select **QC Setup** and press **Enter**.

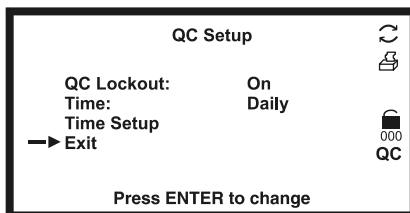

QC Lockout

Select **QC Lockout** and press **ENTER** to cycle the options **Off** or **On**.

Off disables the QC lockout function. The **QC** symbol and Setup Options are not displayed.

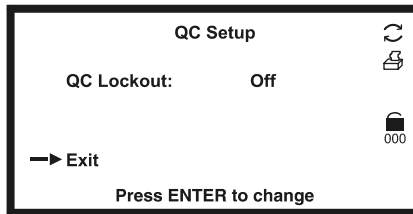

On enables the QC lockout function. The **QC** symbol is displayed. QC Lockout timing can be set for **Every 8 Hours, Daily, Weekly** or **Monthly**.

Time

Select **Time** and press **ENTER** to set the QC test for **Every 8 Hours, Daily, Weekly** or **Monthly**.

Time Setup

Select **Time Setup** and press **ENTER**.

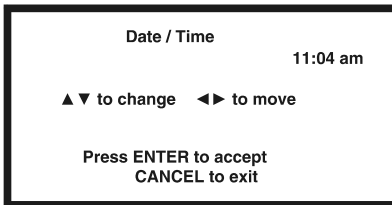

Every 8 Hours / Daily

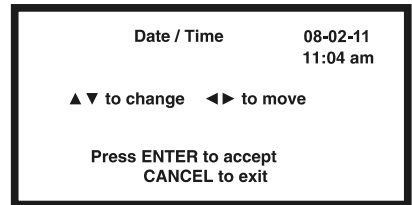

Weekly / Monthly

The first highlighted digit will be changed. Press **▲** or **▼** to change. Continue to press **▲** or **▼** until the correct number is shown. Press **◀** or **▶** to progress to the next digit to be changed. Press **▲** or **▼** to increase or decrease the number. Change each of the time and date digits/fields in this manner until the desired date is shown. Press **ENTER** to save the changes and exit the screen. Press **CANCEL** to not accept changes and exit.

There is no **Date Setup** if QC tests are set for **Every 8 Hours** or **Daily**.

For the **Monthly** option, **Date** can be set from 01 to 28. 29, 30 and 31 are invalid.

Run QC Test

Select **Run QC Test** and press **ENTER** to perform a QC test before the next scheduled test time.

When a QC test is run for the first time, the analyzer will show the screen below if QC values have not been set up.

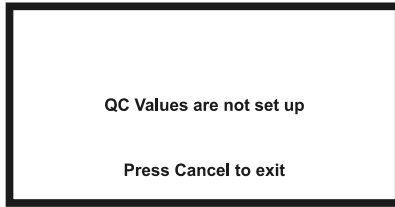

Setting the QC Values

From the Initial Screen, enter the passcode 420024 to show the QC value setup screen.

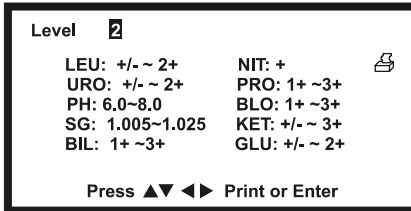

Press ▲ or ▼ to change the highlighted digit. Press ◀ or ▶ to move to the digit to be changed. Press ▲ or ▼ to increase or decrease the value. Change each of the analyte QC values in this manner until the desired values are shown.

Press **ENTER** to save the changes and exit the screen. Press **PRINT** to print the current values.

Note: Please set up the QC values, according to the urine control expected values insert. The U120 QC set-up screen recognizes only arbitrary values.

User Login

Press **ENTER** from the Initial Screen to show the Administrator login screen. The Operator ID is preset to 100.

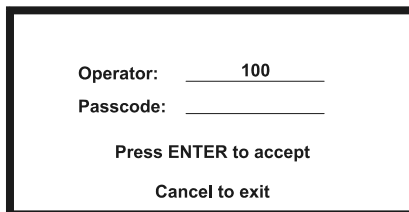

On entry to this screen for the first time, leave the **Passcode** blank and press **ENTER**.

Press **CANCEL** to return to the Initial Screen without enabling User Login.

ID Admin

The Administrator screen is shown.

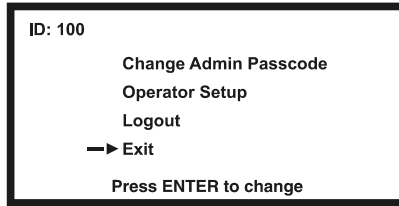

Press ▲ or ▼ to move the → to make changes. If Passcode is blank, user login is not yet enabled and only **Change Admin Passcode** can be chosen. Select **Exit** and press **ENTER** to save changes.

Change Admin Passcode

Change the passcode from blank to a valid passcode, select **Change Admin Passcode** and press **ENTER**.

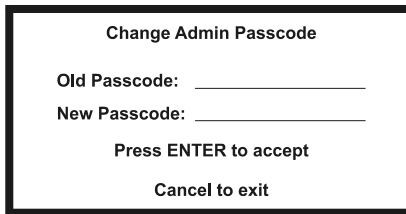

A non-blank passcode must be entered to enable **User Login**. If a blank is entered, a new screen will indicate the passcode is invalid. After 3 seconds, the screen will return to the login screen.

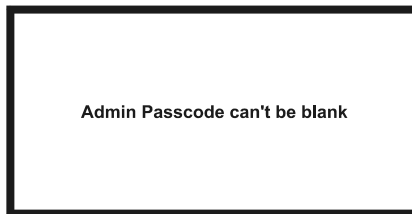

Press **CANCEL** to keep the existing passcode and exit.

Scan or enter a valid **Passcode** and press **ENTER** to accept and exit. **User Login** will be enabled.

Operator Setup

After **User Login** is enabled, select **Operator Setup** and press **ENTER**.

11	12	13	14	15
X	○	○	○	○
16	17	18	19	20
○	○	○	○	○

Press ◀▶ to Select ID
ENTER to change
Cancel to exit

X indicates the ID is enabled. **○** indicates the ID is not enabled

Press ◀ or ▶ to move the cursor to the desired ID. Press **ENTER** for the **Passcode** screen.

Set ID 11 Passcode

Old Passcode: _____

New Passcode: _____

Press ENTER to accept
Cancel to exit
Enter blank to delete

Scan or enter a new **Passcode**. Press **ENTER** to save the settings and exit. Press **CANCEL** to cancel the settings and exit. Enter a blank **Passcode** to disable the ID.

Logout

After the User Login is enabled, select **Logout** and press **ENTER** to log out. The normal Login screen will be shown for a new operator login. See Section 5 for Login procedures.

Operator: _____

Passcode: _____

Press ENTER to accept
Clear to clear

Press **CLEAR** from the Initial Screen to logout and display the Login Screen shown above.

Section 5 Analyzer Operation

If **User Login** is not enabled, the Initial Screen will be shown after Self Test. Refer to Section 3 Initial Startup.

If **User login** is enabled, the analyzer will display a login screen after Self Test.

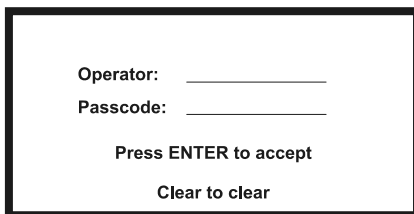

Operator: _____
Passcode: _____
Press ENTER to accept
Clear to clear

Enter the **ID** and enter or scan the **Passcode**. Press **ENTER** to run the analyzer. Press **CLEAR** to return to the login screen.

If the **Passcode** is incorrect, the analyzer will indicate a passcode error. After 3 seconds, the screen will return to the login screen.

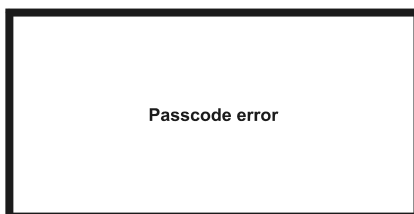

Passcode error

If the **Passcode** is correct, the analyzer will display the Initial Screen. The logged-in ID will be shown (11-20, or 100).

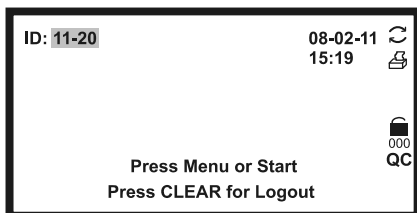

ID: 11-20 08-02-11 15:19
Press Menu or Start
Press CLEAR for Logout
000 QC

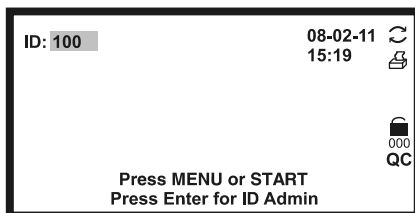





ID: 100 08-02-11 15:19
Press MENU or START
Press Enter for ID Admin
000 QC

The user ID will be 11-20 for Operators. This provides access to operate the analyzer, change test modes and test number, and review settings. Press **CLEAR** from the Initial Screen to logout and display the Login Screen.

The user ID will be 100 for the Administrator. This provides full access to operate the analyzer and change settings. Press **ENTER** from the Initial Screen to display the ID Admin Screen. Press **CLEAR** from the Initial Screen to logout and display the Login Screen.

Press **START** on the Initial Screen to test strips. Check all settings and strip types before testing.

During testing, the screens will display icons showing the status, options available and prompts for testing:

No. 000001	The sequential test number assigned to the next test to be run. In Routine Mode, the first digit will be 0 . In STAT Mode, the first digit will be 1 . In QC Mode, the first digit will be 2 .
10U	Indicates the proper strip to be tested has 10 test pads. Standard strips available are 8, 9 or 10 test parameters, refer to Appendix 2. Select the strip configuration using the MENU function from the Initial Screen. The strip type must match the strip being used or result will not be displayed.
Mode	Indicates the current mode setting. Available modes are Routine , STAT and QC . Press ENTER from this screen to change the mode. Continue to press ENTER to cycle through each mode. The mode may be changed when this prompt appears.
	When visible, Continuous Test is set to test up to 120 tests per hour. If not, Single Test is set to test one strip at a time up to 60 tests per hour.
	When visible, the printer is set to Auto-print . Test data is sent to the internal printer and data ports after each test. Results are displayed on the screen. If this icon is not visible, press Print to send results to the printer and data port.
	When visible, Auto-Print is On . Test data is sent to the external printer and data ports after each test.
	When visible, indicates the Barcode reader is enabled.
EXT	If only EXT is visible, Auto-Print is Off . Press Print to send test data to the printer and data port.
	Strip Lockout is available. The analyzer will only test strips with correct barcodes. There will be no symbol if Strip Lockout is not an included function.
QC	When visible, indicates QC Lockout is On . When the scheduled test time arrives, this symbol will flash. A beep will be heard to prompt that a QC test is required before performing additional tests.

Entering Canister Code

When a new canister of strips is required, the analyzer will request that a canister code is entered from the new canister. The code can be entered manually from the keypad, or scanned with the Barcode reader, if installed.

At first startup, the Strip Holder will fully extend. The screen below will be displayed.

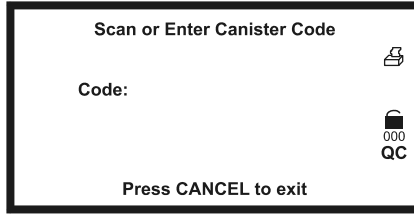

Scan or manually enter the canister code from the strip canister.



Press **CLEAR** to move the cursor to the proper digit if you entered an incorrect number. Edit the number as needed. After the last digit of the correct code is entered, the next screen will be shown. Press **CANCEL** to cancel the changes and exit the screen.

If the canister code is incorrect, the following screen will show.

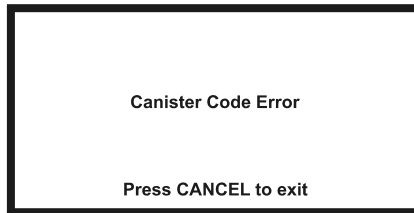

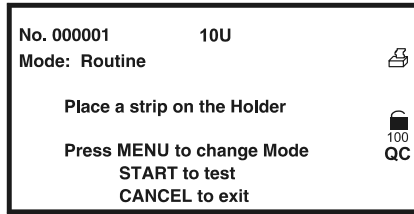

Press **CANCEL** to exit to the previous screen.

If the canister code is correct, the analyzer will proceed to the Initial Screen.



Note: Refer to Section 4, Analyzer Setup, to change the settings.

When there are only 5 strips remaining,  will flash to prompt that a new canister of strips is required. The number of strips left can be seen under .

When the current run is completed, enter the new canister code. The number under  will be increased accordingly.

Note: Refer to the following for more information on the Strip Lockout function. Once a canister code is accepted, the analyzer will automatically recognize the Type of Strip and the number of strips per canister should be tested. The analyzer will keep track of the number of strips available for testing and the strips remaining will be displayed under the lock symbol. **Continue testing as usual until the analyzer prompts that a new canister code is required. When the analyzer prompts that a new canister code is required, scan or manually enter a canister code from a new canister to be used, or from the one currently in use.** The analyzer will not accept canister codes that have already been entered and will lockout the user until a new canister code is entered. One canister code can be entered for each Type of Strip, and will be managed independently of other strip types by the analyzer.

Normal Operation, no Barcode reader

Sample/Strip Preparation

Allow the strip, urine specimen, and/or controls to reach room temperature at 15-30°C (59-86°F) prior to testing.

Note: Only **Mission**[®] Urinalysis Reagent Strips work with the **Mission**[®] U120 Urine Analyzer. Use of any other strips will cause inaccurate results.

Remove the strips from the closed canister. Use them as soon as possible. Tightly close the canister after removing the strips.

Strip Test – Single Test Mode

Press **START** for the strip prompt. Wait for the audible triple beep to immerse the strip.

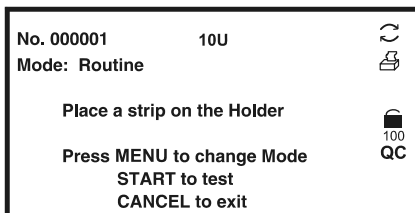

Once **START** is pressed, the screen below will show.

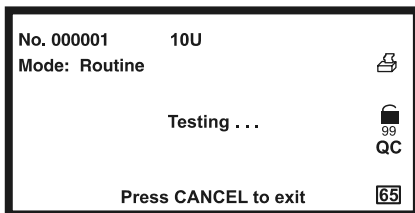

The countdown clock is displayed on the bottom right. The clock will start to count down from **65**. The operator has 3 seconds before the triple beep sounds to immerse the strip into the urine.

Upon hearing the triple beep and/or seeing the countdown clock reach **62**, completely immerse the reagent areas of the strip in fresh, well-mixed urine. Immediately remove the strip to avoid dissolving the reagents.



Run the edge of the strip against the rim of the urine specimen container to remove excess urine. Hold the strip in a horizontal position. Bring the edge of the strip into contact with an absorbent material (e.g. a paper towel). This prevents mixing chemicals from adjacent reagent areas.

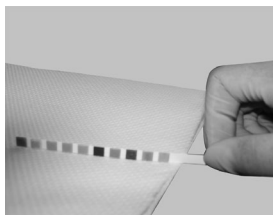

Place the strip with the reagent area facing up, onto the Strip Holder Channel. Make sure the strip end touches the Strip Holder Backstop as shown below.



Note: When the countdown clock on the display reaches 1, the Strip Holder will carry the strip inside and begin testing.

An automatic calibration is done before each test.

The results will be displayed on the screen and stored in memory after each test. Any abnormal results will be highlighted on the screen and flagged on the print out.

If **Auto-print** is set to **on** the results will be printed. If **Auto-print** is set to **off**, press **Print** to print the results.

Remove the used strip from the Strip Holder when the strip carrier moves out. Discard the used strip according to local regulations.

Repeat the previous steps to test more urine.

Strip Test – Continuous Test Mode

Press **START** when the Strip Holder is fully extended to begin the test. The following screen will be displayed. Wait for the audible triple beep to immerse the strip.

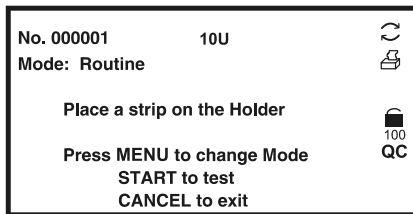

Note: Timing is set up to process a new strip every 30 seconds.

Once **START** is pressed, the screen will change to the following:

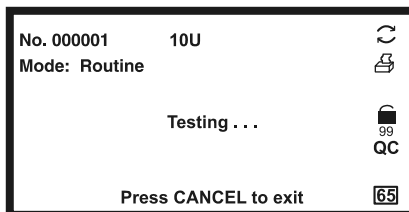

The countdown clock is displayed on the bottom right of the screen. The clock will start to count down from **65**. The operator has 3 seconds before the triple beep sounds to immerse the strip into the urine.

Upon hearing the triple beep and/or seeing the countdown clock reach **62**, completely immerse the reagent areas of the strip in fresh, well-mixed urine. Immediately remove the strip to avoid dissolving the reagents. Handle and test the strips as described in Strip Tests - Single Test Mode above.

Place the first strip onto the Strip Holder Channel. Ensure the reagent pads face up. Make sure the end of the strip touches the Strip Holder Backstop.

Listen for the next triple beep and/or see the countdown clock reach **32**. Immerse a new second strip in fresh, well-mixed urine. Repeat the strip testing steps above. Lay the second urine-exposed strip on a paper towel, with reagent pads up. Wait for the first strip to complete testing and the Strip Holder to move out.

Listen for the next triple beep and/or see the countdown clock reach **2**. Immerse a new third strip in fresh, well-mixed urine. Repeat the strip testing steps above. Lay the third strip on a paper towel with reagent pads up. Wait for the Strip Holder to move out.

Note: When the countdown clock reaches 1, the Strip Holder will carry the first strip inside. The countdown clock also returns to **30**. The results will be displayed on the screen for several seconds and stored in memory. If **Auto-print** is **on**, the results will be printed.

Remove the completed first strip after the Strip Holder moves out. Immediately place the second strip on the Strip Holder before the countdown clock reaches **1**. The Strip Holder will carry the new strip inside for analysis.

Note: The operator has about 8 seconds to discard the used strip and place the next strip on the Strip Holder.

After the first time the countdown clock reaches **1**, it will return to **30** instead of **65**. A triple beep occurs every 30 seconds. This prompts the operator to immerse a new strip.

Discard the used strip according to local regulations.

Repeat the above process for additional urine specimens.
Press **Cancel** to stop testing when all tests are done.

Normal Operation, Barcode reader installed

Plug the RS232C cable from the **Barcode reader** into the **Standard RS232C Port** in the back of the analyzer. Use the cable supplied with the **Barcode reader**. Refer to Appendix 5 **Barcode reader** for specifications and compatibilities.

If both the optional **Barcode reader** and external data transmission capability are used at the same time, use the serial splitter cable to connect both external computer and **Barcode reader** to the analyzer **Standard RS232C port**.

Ensure the analyzer parameters are configured properly as described in **Section 4 Analyzer Setup**, with **Barcode Reader** set to **Yes**. Turn the power switch located at the back panel of the analyzer on.

Strip Test – Single Test Mode with Barcode reader

Press **START** from the Initial Screen.

A prompt to scan the Barcode ID with the reader will display. If a Barcode reader is installed, holding the **Barcode reader** over the barcode on the specimen container, press the Scan button on the **Barcode reader**. A red illuminated line will appear over the barcode to be read. Move the **Barcode reader** to align the red line over the barcode. Position it until the **Barcode reader** beeps, indicating the barcode has been scanned. When the reading has been completed, it will appear next to **ID**. **ID** will reflect the last barcode read by the reader. It will change every time a new barcode is read until **START** is pressed to begin the test.

If a **Barcode reader** is not installed, enter the **ID** manually using the keypad. Press **CANCEL** to clear the input, **START** to begin the test.

Press **MENU** to change the current testing mode.

After the barcode is entered, **ID** will display. Review the ID before testing the strip.

No. 000001 10U 08-02-11
Mode: Routine 08:10
Input Patient ID
ID: 1234567890
Press MENU to change Mode
CANCEL to exit
START to test
100
QC

Press **START** after the **ID** has been entered to display the next screen.

No. 000001 10U
Mode: Routine
Place a strip on the Holder
Press MENU to change Mode
START to test
CANCEL to exit
100
QC

Press **START** again to begin strip testing. The strip is tested the same as other single test modes. The results screen will show the sample ID in the **ID** field.

No. 000001 10U 08-02-11
15:38
ID 123456789012345
LEU - NIT + URO -
PRO 1+ pH 7.0 BLO 1+
SG 1.030 KET - BIL 1+
GLU 1+
Press ▲▼ PRINT or CANCEL
99
QC





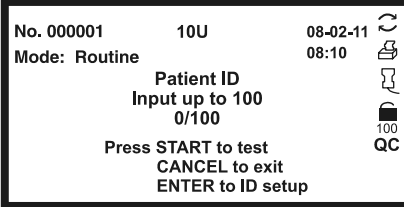

If **Auto-print** is **Off**, press **PRINT** from the results screen to print results. Press **CANCEL** to return to the previous barcode entry screen.

Strip Test – Continuous Test Mode with Barcode reader

If **Barcode reader** is **On** and  is displayed, samples are tested in batch mode. Holding the **Barcode reader** over the barcode on the specimen container, press the Scan button on the **Barcode reader**. A red illuminated line will appear over the barcode to be read. Move the **Barcode reader** to align the red line over the barcode. When the **Barcode reader** beeps the barcode has been scanned. All sample barcode IDs in a batch are read and stored in memory in sequence. Samples must be run in the same sequence as scanned. This ensures IDs and samples correspond. Prompts are displayed to show the next sample to be tested.

Press **START** to begin the batch mode.









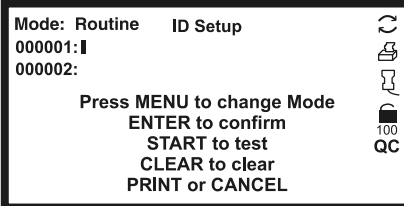

No. 000001 10U 08-02-11 
Mode: Routine 08:10 
Patient ID 
Input up to 100
0/100 
Press START to test 
CANCEL to exit 
ENTER to ID setup 

Press **CANCEL** to return to the *Initial screen*.

Press **ENTER** to enter a new screen to edit the Barcode ID.







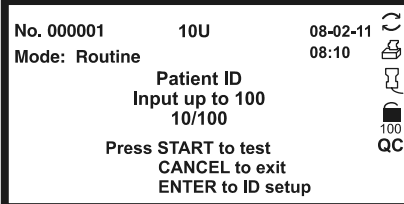

Mode: Routine ID Setup 
000001: 
000002: 
Press MENU to change Mode 
ENTER to confirm 
START to test 
CLEAR to clear 
PRINT or CANCEL 

Using the keypad or barcode reader to enter the Barcode ID, press **ENTER** to confirm the ID entered and enter the next number.

Press **CLEAR** to clear the entered ID. Press **PRINT** to print the list of IDs. **CANCEL** to exit to the previous screen.



No. 000001 10U 08-02-11 
Mode: Routine 08:10 
Patient ID 
Input up to 100
10/100 
Press START to test 
CANCEL to exit 
ENTER to ID setup 

Press **START** to save the IDs and return to the previous screen.

Up to 100 barcodes can be read. The screen will indicate how many barcodes have been read.

Note: Do not change **Barcode reader** or Test number settings before all barcodes have been processed. Otherwise remaining barcodes may be deleted.

Press **START** to begin strip testing. The testing screen will be displayed as shown below. This screen example shows a total of 10 strips to be run. It asks for the first strip to be placed on the Strip Holder.

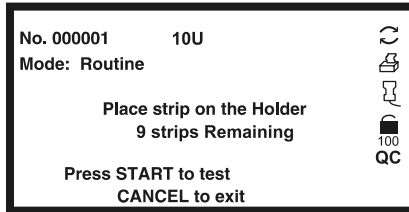

The next screen shows the barcode of the sample to be run and the next sample ID to be run. This reduces the possibility of error and mismatch between the barcode and the sample to be run.

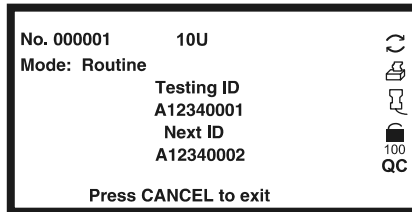

When the test is complete, the **Results Screen** will show briefly. The next strip can be placed on the Strip Holder.

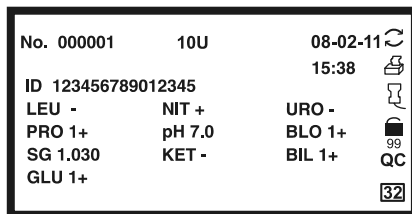

Stop testing by pressing **CANCEL** when the prompt appears. All other testing procedures are the same as testing with no barcode.

Urine Controls QC Testing

Ensure the operating **Mode** is set to **QC**. All test numbers in QC mode will begin with **2**. This allows results to be searched for and found easily.

Strip Preparation

Allow the strip and urine controls to reach room temperature at 15-30°C (59-86°F) prior to testing.

Note: Use *Mission*[®] Urinalysis Reagent Strips for proper functioning and accurate results.

Remove strips from the closed canister and use them as soon as possible. Close the canister tightly immediately after removing the strips.

Urine Control Test Procedures

The urine control test procedures are the same as Normal Operation, no Barcode reader, or Normal Operation, Barcode reader installed. Refer to Section 5 Analyzer Operation.

The results obtained during the Quality Control test will be referenced by the analyzer with pre-programmed target values and report generated, If **Auto-print** is set to **On**, the result will be printed.

If the QC test "Fails", please contact your local distributor for Technical Support.

QC lockout

When **QC lockout** is turned **On**, the user will be notified when a QC test is required. The following screen will be displayed. The **QC** symbol will flash.

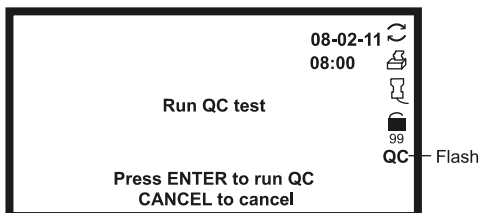

Note: Use *Mission*[®] Urinalysis Reagent Strips for proper functioning and accurate results.

If it is the first time to run the QC test, refer to the section on **Setting the QC Values** to set up QC test values.

Press **CANCEL** to return to the Initial Screen. If canceled, the analyzer will change the test mode to **STAT**. An "E" will be displayed after the test number on all printouts to show QC tests were out of date and pending.

Press **ENTER** to run QC tests.

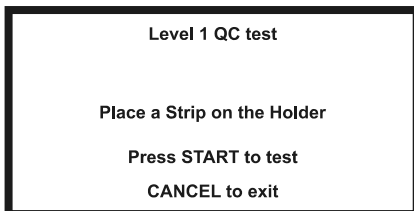

The analyzer will run a Level 1 QC test first. Refer to the Strip Test section for

details on testing.

After testing, the analyzer will display the testing results.

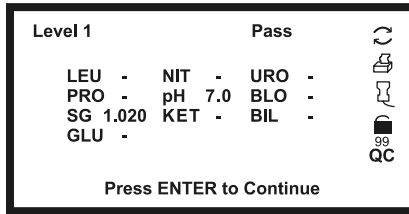

If any parameter is out of range, it will be highlighted and marked with a “*”.

If **Auto-print** is set to **On**, the result will be printed.

Press **ENTER** to test control Level 2. The steps are the same as for Level 1.

When Both QC Tests pass, the “E” at the end of the test number will not be shown.

Date: 2011-08-02	16:54
Operator: 11	
Level 1	Pass
No. 200021	
LEU	- neg
NIT	- neg
URO	- 0.2 mg/dL
PRO	- neg
pH	6.0
BLO	- neg
SG	1.030
KET	- neg
BIL	- neg
GLU	- neg

Date: 2011-08-02	16:54
Operator: 11	
Level 2	Pass
No. 200021	
LEU	2+ 125 Leu/uL
NIT	+ Pos
URO	1+ 2 mg/dL
PRO	3+ 300 mg/dL
pH	8.0
BLO	3+ 200 Ery/uL
SG	1.010
KET	2+ 40 mg/dL
BIL	2+ 2 mg/dL
GLU	2+ 500 mg/dL

Section 6 Data/Communication

The RS232 and USB ports can communicate with an external (optional) PC.

If **Auto-print** is **On**, the printed data on the internal printer is also sent to the RS232 and USB ports. Connect either RS232 or USB cable to the back of the analyzer to a PC with suitable software.

For US customers, call customer service toll free at 1-(800)-838-9502 for details on data transfer. For customers outside the US, contact your local distributor.

External Printer

The RS232 port can connect to an optional external printer for printing data.

For US customers, call customer service toll free at 1-(800)-838-9502 for details on external printing. For customers outside the US, contact your local distributor.

Barcode reader

The RS232 port can also connect to an optional Barcode reader. It can read and enter barcoded sample ID information.

For US customers, call customer service toll free at 1-(800)-838-9502 for details on the barcode reader. For customers outside the US, contact your local distributor.

Section 7 Quality Control

Each lab should use its own standard and procedures for performance. Test known positive and negative specimens/controls at the following events in accordance with local, state, and/or federal regulations or accreditation requirements.

- A new canister of strips is opened
- A new operator uses the analyzer
- Test results seem inaccurate
- After performing maintenance or service on the analyzer

If the QC tests do not provide expected results, perform the following checks:

- Ensure the strips used are not past their expiration date.
- Ensure strips are fresh from a new canister.
- Ensure the controls are not past their expiration date.
- Repeat the test to ensure no errors were made during the test.

For US customers, call customer service toll free at 1-(800)-838-9502 for additional information. For customers outside the US, contact your local distributor.

Section 8 Maintenance

Loading Printer Paper

Pull up on the finger pull area marked  to open the **Printer Cover**.

Place paper roll in the printer box. The paper comes from the bottom of the roll up into the printer.

Caution: The printer will only print on the outside surface of the roll. If placed incorrectly, there will be no printout.

For easy printer paper loading, bend the leading edge of the printer paper upward toward the back of the analyzer. Push the leading edge of the printer paper through the feed and the printer paper will now easily feed through the **Printer Roller**.

A green **Paper Release Lever** is located near the **Printer Roller**. Press the back end of the **Paper Release Lever** towards the front of the analyzer to release the pressure on the **Printer Roller**. Feed the paper under the **Printer Roller** until the end shows above the roller.

Pull the paper up. Leave 10 cm (4 inches) of extra paper above the **Printer Roller**.

Press the front end of the green **Paper Release Lever** down to lock the **Printer Roller**.

Thread the excess paper through the **Printer Paper Access Slot** in the **Printer Cover**. Return the **Printer Cover** to its original closed position.

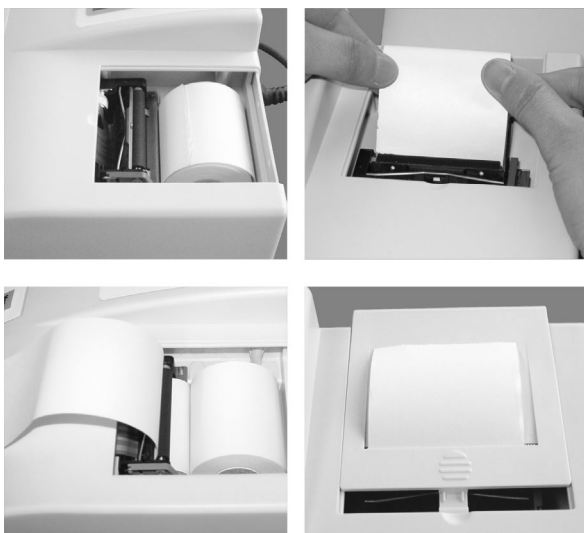

General Cleaning

Keep the surface of the instrument free of dust at all times. If needed, the external surfaces may be cleaned using a damp cloth. Do not use any type of solvent, oil, grease, silicone spray, or lubrication on any part of the instrument.

Daily Cleaning

Remove the Strip Holder

Press **Start** to fully extend the Strip Holder/Mount.

Turn off the Power Switch after the Strip Holder/Mount is fully extended.

Remove the Strip Holder from its mount by pulling out gently by the two sides as shown below.

Clean the Strip Holder

Clean the Strip Holder using a lint free/non-absorbent cotton swab/ball with distilled water. Dry with a clean, dry cotton ball.

Examine the White Calibration Circle to ensure there are no nicks or dirt present. Clean the White Calibration Circle as necessary using a cotton swab or cotton ball with distilled water. Dry with a clean, dry cotton ball.

Note: The White Calibration Circle should be replaced if any nicks or non-removable dirt are found. For US customers, call customer service toll free at 1-(800)-838-9502 for details. For customers outside the US, contact your local distributor.

Load the Strip Holder

Grasp the Strip Holder by its sides as shown below. Place the Strip Holder on the Strip Holder Mount with the white Calibration Circle facing up and positioned towards the analyzer. It will slide loosely in the locating channel. Push the Strip Holder in towards the analyzer until it snaps into place. It will be held firmly on the Strip Holder Mount. Ensure the Strip Holder is installed properly. If it is not locked onto the Strip Holder Mount, the Calibration Circle will not be in the correct position. The analyzer will display “Optical Sensor Failed.”

Note: When correctly positioned, the Strip Holder will snap into and be locked in place, with the White Calibration Circle not visible. See illustration below.



Return the Strip Holder/Mount to its Internal Position

Turn the Power Switch on and wait for the Strip Holder/Mount to move inside the analyzer and stop. Turn the Power Switch off or begin testing strips.

Please refer to Section 5 Analyzer Operation.

Sample Deposit Cleaning

Remove the Strip Holder as above.

Clean the Strip Holder using a lint free/non-absorbent cotton swab or ball dampened with 0.1 N NaOH.

Warning: Do not allow the NaOH solution to touch the White Calibration Circle.

Clean the excess NaOH from the Strip Holder using a cloth moistened with distilled water.

Dry the Strip Holder with a clean lint free non-absorbent cotton swab or ball.

Replace the Strip Holder and return the Strip Holder/Mount it to its original position as described above.

Strip Holder Sterilization

Remove the Strip Holder and repeat Daily Cleaning above.

Clean the Strip Holder using a lint free non-absorbent cotton swab or ball with one of the following sterilizing solutions:

1. 2% Glutaraldehyde (sufficient density): Refer to detailed instructions on the product label.
2. 0.05% Sodium Hypochlorite Solution: Add 1 mL 5% Sodium Hypochlorite into 99 mL distilled water, or prepare a 1:100 dilution ratio with appropriate final volume.
3. Isopropyl alcohol (70-80%).

Pour the sterilizing solution into a narrow vessel 10 cm (4 inches) high.

Dip the Strip Holder into the sterilizing solution

Caution: Ensure the White Calibration Circle does not touch the solution.

Soak the Strip Holder in the sterilizing solution for 10 minutes.

Remove the Strip Holder, clean and dry it.

Load the Strip Holder and return the Strip Holder/Mount to its original position.

Section 9 Precautions

Follow the precautions listed below for accurate results and operation of the analyzer.

- The protection provided by the equipment may be impaired if used in a manner not defined in this user guide.
- Connect to a power connection which contains a working grounding plug.
- Wear gloves to avoid contact with potentially hazardous biological samples during processing strips, or analyzer components.
- Avoid storing or operating the analyzer in direct sunlight, excessive temperature or humidity. Refer to Appendix 1 Urine Analyzer Specifications for operating condition requirements.
- Never place anything within 7 cm of the front of the unit. This will avoid interference with the Strip Holder.
- Keep the unit clean. Wipe it frequently with a soft, clean and dry cloth. Use fresh water when needed.
- Do not clean the unit with substances such as gasoline; paint thinner, benzene compounds or other organic solvents. This will avoid any damage to the Strip Holder, White Calibration Circle, or other components.
- Do not wash the LCD with water. Lightly wipe the LCD with a clean, soft and dry rag.
- The Strip Holder must be kept clean. Wipe the Strip Holder using fresh water daily. Refer to Daily Cleaning in Section 8.
- Follow all local regulations when discarding the unit or its accessories.
- Do not use the unit or the strips outside of the operating temperature ranges listed below.

Analyzer: 0-40°C (32-104°F)

Strips: 15-30°C (59-86°F)

Section 10 Troubleshooting

Problem	Solutions
Strip Position Improper	<ul style="list-style-type: none"> Adjust the strip so the strip end is completely touching the Strip Holder Backstop and centered in the Strip Holder Channel
Strip Missing	<ul style="list-style-type: none"> Insert strip
Strip Error	<ul style="list-style-type: none"> Ensure the type of strip used matches the type of strip setting Ensure the strip brand is compatible with the analyzer Ensure all of the test pads on the strip have been immersed in the specimen
No display on screen	<ul style="list-style-type: none"> Turn the Power Switch on Make sure power is applied to the Analyzer Examine the Fuse on the back of the analyzer to determine if it is damaged and replace if necessary
Fuse is damaged	<ul style="list-style-type: none"> Turn the Power Switch off, disconnect the plug and replace the damaged Fuse with a new 2.0A Fuse (Spare fuse is located in the fuse compartment)
Printer does not work	<ul style="list-style-type: none"> Make sure Auto-Print is set to On. Refer to Printer Setup instructions Load paper if necessary. Ensure Printer Setup is set for Internal when an external printer is not connected Ensure paper roll is placed correctly. If incorrect, there will be no printout Clean printer roller with ethanol See that the proper side of the thermal paper is inserted in the printer Remove paper jam by lifting up green paper release lever and removing jammed paper. (See Section 2)
Main Control Unit Failed	<ul style="list-style-type: none"> Turn the Power Switch off, then on. Perform a Self-Test. Refer to Manual Self-Test section
Optical Sensor Failed	<ul style="list-style-type: none"> Ensure the Strip Holder is locked onto the Strip Holder Mount correctly. The Strip Holder should snap into place and locked onto the Strip Holder Mount. Ensure the white Calibration Circle is clean Clean the Strip Holder and refer to Daily Cleaning section Turn the Power Switch off, then on. Perform a Self-Test. Refer to Manual Self-Test section
Test Accuracy Failed	<ul style="list-style-type: none"> Turn the Power Switch off, then on. Perform a Self-Test. Refer to Manual Self-Test section
Mechanism Failed	<ul style="list-style-type: none"> Remove any obstacles in the path of the Strip Holder Do not touch the Strip Holder when it is moving Turn the Power Switch off, then on. Perform a Self-Test. Refer to Manual Self-Test section
Excess Light Failed	<ul style="list-style-type: none"> Ensure the analyzer is kept away from direct light Ensure the white calibration circle is clean Ensure the Strip Holder is positioned correctly on the Strip Holder Mount. Refer to Daily Cleaning section Turn the Power Switch off, then on. Perform a Self-Test. Refer to Manual Self-Test section
Canister Code Error	<ul style="list-style-type: none"> Ensure the canister code entered is correct Ensure the type of strip used is the same as the analyzer setting.
QC Test Fail	<ul style="list-style-type: none"> Ensure the control is correct Ensure the type of strip is correct Ensure the brand of strip is compatible with the analyzer Ensure all of the reagent pads of the strip have been immersed

For US customers, call customer service toll free at 1-(800)-838-9502 for details. For customers outside the US, contact your local distributor.

Appendix 1 Urine Analyzer Specifications

Feature	Specifications
Methodology	Reflectance Photometer
Detection	Photosensitive diode
Throughput	Single Test Mode: 60 tests/hour Continuous Test Mode: 120 tests/hour
Memory	Last 2000 results
Strip Incubation Time	1 minute
Detection Wavelengths	525 nm and 635 nm
Analyzer Ports	Standard RS232C Port for Barcode Reader or Data Transfer, USB Port for Data Transfer, 25 Pin Parallel Port for External Printer
Capabilities	Internal Thermal Printer (included), Optional External Printer (not included), RS232C Barcode Reader (optional), USB or RS232C Data Transfer Cable (optional)
Major Readable Barcodes	See Appendix 5
Available Languages on Screen	English (default in US and select countries) and additional language(s)
Analyzer Operating Conditions	0-40°C (32-104°F); ≤85% Relative Humidity (non-condensing)
Strip Operating Conditions	15-30°C (59-86°F); ≤85% Relative Humidity (non-condensing)
Power Source	100-240V AC, 50/60Hz, 35 W
Weight	2.6 Kg (5.73 lbs)
Dimensions (L X W X H)	27.2 cm X 26.9 cm X 14.6 cm (10.7" X 10.6" X 5.7")
Display Dimensions (L X W)	10.8 cm x 5.7cm (4.2" X 2.2")

This product complies with EN 61326.

Appendix 2 Performance Characteristics of Urinalysis Reagent Strips

The performance characteristics of the **Mission**[®] Urinalysis Reagent Strips have been determined in both laboratory and clinical tests. The following table indicates performance characteristics for each parameter.

Reagent	Composition	Sensitivity- Visual Reading	Sensitivity – Mission [®] U120 Urine Analyzer Reading
Leukocytes (LEU)	derivatized pyrrole amino acid ester; diazonium salt; buffer; non-reactive ingredients	Detects leukocytes as low as 9-15 white blood cells (Leu/ μ L) in clinical urine.	Detects leukocytes as low as 12-15 white blood cells (Leu/ μ L) in clinical urine.
Nitrite (NIT)	p-arsanilic acid; N-(1-naphtyl) ethylenediamine; non-reactive ingredients	Detects sodium nitrite as low as 0.05-0.1 mg/dL in urine with a low specific gravity and less than 30 mg/dL ascorbic acid.	Detects sodium nitrite as low as 0.05 mg/dL in urine with a low specific gravity and less than 30 mg/dL ascorbic acid.
Urobilinogen (URO)	p-diethylaminobenzaldehyde; buffer and non-reactive ingredients	Detects urobilinogen as low as 0.2-1.0 mg/dL (3.5-17 μ mol/L).	Detects urobilinogen as low as 0.8-1.0 mg/dL (13.6-17 μ mol/L).
Protein (PRO)	tetrabromophenol blue; buffer and non-reactive ingredients	Detects albumin as low as 7.5-15 mg/dL (0.075-0.15 g/L).	Detects albumin as low as 12-15 mg/dL (0.12-0.15 g/L).
pH	methyl red sodium salt; bromthymol blue; non-reactive ingredients	Permits the quantitative differentiation of pH values within the range of 5-9.	Permits the quantitative differentiation of pH values within the range of 5-9.
Blood (BLO)	3,3',5,5'-tetramethylbenzidine (TMB); cumene hydroperoxide; buffer and non-reactive ingredients	Detects free hemoglobin as low as 0.018-0.060 mg/dL or 5-10 Ery/ μ L in urine specimens with ascorbic acid content of <50 mg/dL.	Detects free hemoglobin as low as 0.018-0.030 mg/dL or 5-10 Ery/ μ L in urine specimens with ascorbic acid content of <50 mg/dL.
Specific Gravity (SG)	bromthymol blue indicator; buffer and non-reactive ingredients; poly (methyl vinyl ether/maleic anhydride); sodium hydroxide	Determines urine specific gravity between 1.000 and 1.030. Results correlate with values obtained by refractive index method within \pm 0.005.	Determines urine specific gravity between 1.000 and 1.030. Results correlate with values obtained by refractive index method within \pm 0.005.
Ketone (KET)	sodium nitroprusside; buffer	Detects acetoacetic acid as low as 2.5-5 mg/dL (0.25-0.5 mmol/L).	Detects acetoacetic acid as low as 4-5 mg/dL (0.4-0.5 mmol/L).
Bilirubin (BIL)	2, 4-dichloroaniline diazonium salt; buffer and non-reactive ingredients	Detects bilirubin as low as 0.4-1.0 mg/dL (6.8-17 μ mol/L).	Detects bilirubin as low as 0.8-1.0 mg/dL (13.6-17 μ mol/L).
Glucose (GLU)	glucose oxidase; peroxidase; potassium iodide; buffer; non-reactive ingredients	Detects glucose as low as 50-100 mg/dL (2.5-5 mmol/L).	Detects glucose as low as 80-100 mg/dL (4-5 mmol/L).

Notes:

- For the parameter arrangement and combination of different Urine Reagent Strips, please refer to the product information on the **Mission**[®] Urinalysis Reagent Strips kit box or canister label.
- Ensure that the type of strip selected corresponds with the strip to be used. If not, it will be detected and display an error.
- Only use **Mission**[®] Urinalysis Reagent Strips for proper function and accurate results.

Results of CLIA Waiver Study

A total of nine untrained non-laboratory users from three clinical sites in the US participated in the study by testing a total of 560 urine samples using the **Mission**[®] U120 Urine Analyzer over 2 month period. The **Mission**[®] U120 Urine Analyzer is intended for use in conjunction with the **Mission**[®] Urinalysis Reagent Strips for detection of the following analytes in urine: Glucose, Blood, Protein, Leukocytes, Nitrite, Bilirubin, Ketone, pH, Specific Gravity, and Urobilinogen. At each study site, approximately 120 clinical urine specimens were tested by three untrained, non-laboratory participants: phlebotomist, medical assistants, and ultrasound technician. The results (WM) were compared with the same specimens tested by professionally trained operators using Bayer's Clinitek 500 Urine Chemistry Analyzer (CM).

The CLIA waiver study demonstrated that the following performance data of the **Mission**[®] U120 Urine Analyzer in the hands of non-technical users when using only the Quick Start Guide.

Bilirubin		Bayer Clinitek 500 Urine Chemistry Analyzer				Total
		0	1	2	4	
Mission [®] U120 Urine Analyzer	0	410	8	1	0	419
	1	8	15	0	0	23
	2	4	12	21	5	42
	4	0	1	1	74	76
	Total	422	36	23	79	560

The exact agreement between the CM and the WM is 92.9% (520/560) with 95% CI: (90.4%; 94.8%). Agreement within +/- 1 block is 96.1% (538/560) with 95% CI: (94.1%; 97.5%).

Blood		Bayer Clinitek 500 Urine Chemistry Analyzer					Total
		0	10	25	80	200	
Mission [®] U120 Urine Analyzer	0	191	16	1	0	0	208
	10	11	37	4	0	0	52
	25	0	14	39	8	0	61
	80	0	0	7	35	0	42
	200	0	0	0	13	184	197
	Total	202	67	51	56	184	560

The exact agreement between the CM and the WM were 86.8% (486/560) with 95% CI: (83.7%; 89.5%). Agreement within +/- 1 block was 95% (532/560) with 95% CI: (92.9%; 96.7%).

Glucose		Bayer Clinitek 500 Urine Chemistry Analyzer					Total
		0	100	250	500	1000	
Mission [®] U120 Urine Analyzer	0	389	4	0	0	0	393
	100	4	32	5	0	0	41
	250	3	14	45	2	0	64
	500	0	0	8	9	1	18
	1000	0	0	2	34	8	44
	Total	396	50	60	45	9	560

The exact agreement between the CM and the WM is 86.3% (483/560) with 95% CI: (83.2%; 89%). Agreement within +/- 1 block is 97.7% (547/560) with 95% CI: (96.1%; 98.8%).

Leukocytes		Bayer Clinitek 500 Urine Chemistry Analyzer					Total
		0	15	70	125	500	
Mission® U120 Urine Analyzer	0	268	23	4	0	0	295
	15	14	34	17	0	0	65
	70	8	10	53	7	3	81
	125	1	0	4	80	22	107
	500	0	0	0	1	11	12
	Total	291	67	78	88	36	560

The exact agreement between the CM and the WM is 79.6% (446/560) with 95% CI: (76.0%; 82.9%). Agreement within +/- 1 block is 90.5% (507/560) with 95% CI: (87.8%; 92.8%).

Protein		Bayer Clinitek 500 Urine Chemistry Analyzer					Total
		0	15	30	100	300	
Mission® U120 Urine Analyzer	0	265	10	0	0	0	275
	15	19	42	13	0	0	74
	30	0	9	48	17	0	74
	100	0	0	0	42	9	51
	300	0	0	0	0	86	86
	Total	284	61	61	59	95	560

The exact agreement between the CM and the WM is 86.3% (483/560) with 95% CI: (83.2%; 89%). Agreement within +/- 1 block is 94.8% (531/560) with 95% CI: (92.7%; 96.5%).

Ketone		Bayer Clinitek 500 Urine Chemistry Analyzer					Total
		0	5	15	40	80	
Mission® U120 Urine Analyzer	0	317	10	0	0	0	327
	5	5	55	9	0	0	69
	15	0	0	52	21	0	73
	40	0	0	6	46	2	54
	80	0	0	0	9	28	37
	Total	322	65	67	76	30	560

The exact agreement between the CM and the WM is 88.9% (498/560) with 95% CI: (86.0%; 91.4%). Agreement within +/- 1 block is 97.3% (545/560) from each other with 95% CI: (95.6%; 98.5%).

Nitrite	Bayer Clinitek 500 Urine Chemistry Analyzer			Total
	0	>0		
Mission® U120	0	387	3	390
Urine Analyzer	>0	25	145	170
	Total	412	148	560

Positive percent agreement was 98.0% (145/148) with 95% CI: (94.2%; 99.6%). Negative percent agreement was **93.9%** (387/412) with 95% CI: (91.2%; 96.0%).

pH	Bayer Clinitek 500 Urine Chemistry Analyzer										Total
	5	5.5	6	6.5	7	7.5	8	8.5	9		
Mission® U120	5	4	22	3	1	0	0	0	0	0	30
Urine Analyzer	5.5	2	49	29	2	1	0	0	0	0	83
	6	1	15	163	69	1	0	0	0	0	249
	6.5	0	0	3	18	48	0	0	0	0	69
	7	0	0	0	4	88	2	0	0	0	94
	7.5	0	0	0	0	1	13	1	0	0	15
	8	0	0	0	0	0	2	8	0	0	10
	8.5	0	0	0	0	0	0	1	4	0	5
	9	0	0	0	0	0	0	0	2	3	5
	Total	7	86	198	94	139	17	10	6	3	560

The exact agreement between the CM and the WM is 62.5% (350/560) with 95% CI: (58.4%; 66.6%). Agreement within +/- 1 block is 98.4% (551/560) from each other with 95% CI: (97.0%; 99.3%).

Specific Gravity	Bayer Clinitek 500 Urine Chemistry Analyzer								Total
	1.0	1.005	1.01	1.015	1.02	1.025	1.03		
Mission® U120	1.0	0	20	0	0	0	0	0	20
Urine Analyzer	1.005	0	73	2	0	0	0	0	75
	1.01	0	32	37	8	2	1	0	80
	1.015	0	0	30	69	43	0	0	142
	1.02	0	0	0	5	91	24	1	121
	1.025	0	0	0	0	0	61	17	78
	1.03	0	0	0	0	0	1	43	44
	Total	0	125	69	82	136	87	61	560

The exact agreement between the CM and the WM is 66.8% (374/560) with 95% CI: (62.7%; 70.7%). Agreement within +/- 1 block is 99.3% (556/560) from each other with 95% CI: (98.2%; 99.8%).

Urobilinogen	Bayer Clinitek 500 Urine Chemistry Analyzer						Total
	0	1	2	4	8		
Mission[®] U120	0	390	14	0	0	0	404
Urine Analyzer	1	0	41	7	1	0	49
	2	0	0	22	18	0	40
	4	0	0	0	26	19	45
	8	0	0	0	0	22	22
Total		390	55	29	45	41	560

The exact agreement between the CM and the WM is 89.5% (501/560) with 95% CI: (86.6%; 91.9%). Agreement within +/- 1 block is 97.3% (545/560) from each other with 95% CI: (95.6%; 98.5%).

Appendix 3 URS Parameter Table

Parameter Name (Abbreviation on Display)	Arbitrary	Conventional	SI
Leukocytes (LEU)	- ± 1+ 2+ 3+	neg 15 Leu/µL 70 Leu/µL 125 Leu/µL 500 Leu/µL	neg 15 Leu/µL 70 Leu/µL 125 Leu/µL 500 Leu/µL
Nitrite (NIT)	- +	neg pos	neg pos
Urobilinogen (URO)	- ± 1+ 2+ 3+	0.2 mg/dL 1 mg/dL 2 mg/dL 4 mg/dL 8 mg/dL	3.5 µmol/L 17 µmol/L 35 µmol/L 70 µmol/L 140 µmol/L
Protein (PRO)	- ± 1+ 2+ 3+	neg 15 mg/dL 30 mg/dL 100 mg/dL 300 mg/dL	neg 0.15 g/L 0.3 g/L 1.0 g/L 3.0 g/L
pH	5.0 5.5 6.0 6.5 7.0 7.5 8.0 8.5 9.0	5.0 5.5 6.0 6.5 7.0 7.5 8.0 8.5 9.0	5.0 5.5 6.0 6.5 7.0 7.5 8.0 8.5 9.0
Blood (BLO)	- ± 1+ 2+ 3+	neg 10 Ery/µL 25 Ery/µL 80 Ery/µL 200 Ery/µL	neg 10 Ery/µL 25 Ery/µL 80 Ery/µL 200 Ery/µL
Specific Gravity (SG)	1.000 1.005 1.010 1.015 1.020 1.025 1.030	1.000 1.005 1.010 1.015 1.020 1.025 1.030	1.000 1.005 1.010 1.015 1.020 1.025 1.030
Ketone (KET)	- ± 1+ 2+ 3+	neg 5 mg/dL 15 mg/dL 40 mg/dL 80 mg/dL	neg 0.5 mmol/L 1.5 mmol/L 4.0 mmol/L 8.0 mmol/L
Bilirubin (BIL)	- 1+ 2+ 3+	neg 1 mg/dL 2 mg/dL 4 mg/dL	neg 17 µmol/L 35 µmol/L 70 µmol/L
Glucose (GLU)	- ± 1+ 2+ 3+	neg 100 mg/dL 250 mg/dL 500 mg/dL 1000 mg/dL	neg 5 mmol/L 15 mmol/L 30 mmol/L 60 mmol/L

Appendix 4 Result Print-Out

The printed results are shown below. Arbitrary units will always be printed. Either Conventional or SI unit results will also be printed depending on the units set.

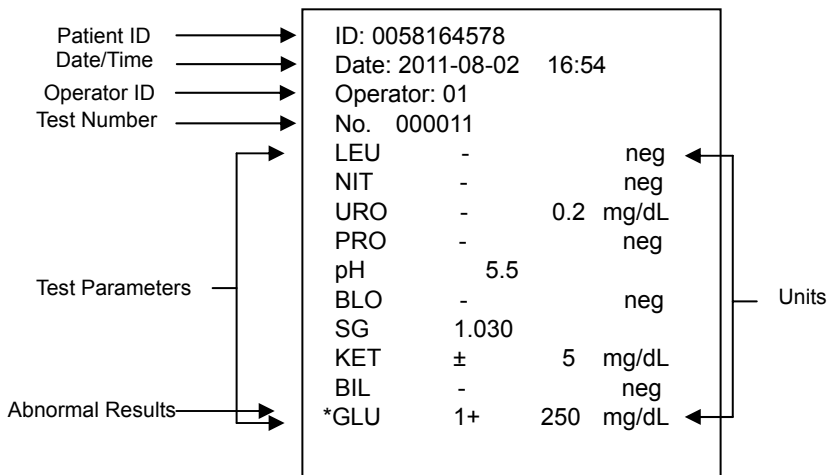

Depending on the type of strip selected, the analyzer recognizes the parameter order and automatically ranks the display and printing sequence of each parameter. Arbitrary results will always be printed automatically. Conventional or SI results will be printed based on the units selected. Abnormal results, or results of pathological significance will be marked with an *.

Arbitrary Results:

- All positive results except pH and Specific Gravity (SG) will be reported as 1+, 2+, or 3+.
- Positive results for pH and Specific Gravity (SG) will be reported with the respective data.
- Negative results for Leukocyte, Nitrite, Urobilinogen, Protein, Blood, Ketone, Bilirubin, and Glucose will be reported as “-”.

Conventional or SI:

- All positive results except Nitrite (NIT) will be reported with the respective data in front of the units. The positive results of Nitrite will be reported as “pos”
- All negative results except Urobilinogen (URO) will be reported as “neg.” The negative results of Urobilinogen (URO) will be reported with the respective data in front of the units.

Appendix 5 Barcode reader

The **Mission**[®] U120 Barcode reader is a laser barcode scanner. The Barcode reader connects to the analyzer to scan the patient (ID) barcode numbers on the specimen containers. The Barcode reader can scan the following:

• Code 39 (Standard/ Full ASCII)	• Codabar (NW-7)	• Code 128
• Italy Pharmacode	• UPCA	• EAN 128
• French Pharmacode	• UPCE	• MSI
• Industrial 25	• EAN8	• Plessey
• Interleave 25	• EAN13	• Telepen
• Matrix 25	• Code 93	• RSS

Note:

A maximum of 20 characters can be read by the barcode reader, displayed, stored, and transmitted by the analyzer.

















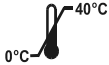









Warning: The Barcode reader is a Class 2 LED Product.

DO NOT stare into the beam.

Appendix 6 Catalog

Product Name	Product Code	Components	Quantity
U120 Urine Analyzer	U111-101	U120 Urine Analyzer	1
		Strip Holder	1
		Printer Paper Rolls	2
		Fuses (2.0A)	2
		Power Cord	1
		Quick Start Guide	1
		Instruction Manual	1
U120 Urine Analyzer With Barcode Reader	U111-111	U120 Urine Analyzer	1
		Strip Holder	1
		Printer Paper Rolls	2
		Fuses (2.0A)	2
		Power Cord	1
		Quick Start Guide	1
		Instruction Manual	1
		Barcode reader (RS232C)	1
Barcode Reader	U221-111	Serial Splitter Cable (RS232C)	1
		Barcode reader (RS232C)	1
Printer Paper Rolls	U121-101	Thermal Paper (0.06 m x 20 m): 200 results/roll	4
		Sticker Paper (0.06 m x 9 m): 100 results/roll; Optional	4
U120 Data Transfer Kit	U121-131	Data Transfer Cable (RS232C or USB)	1
		Package Insert	1

Appendix 7 Index of Symbols

	Consult instructions for use		Manufacturer		Authorized Representative
	For In vitro diagnostic use only		Lot Number		Catalog #
	Store between 0-40°C		Tests per Kit		Serial Number
	Keep away from sunlight and heat		Use by		Serial Port
	Keep Dry		Fragile, handle with care		This Side Up
	Continuous Test		Auto-print is on Internal printer is used		Auto-print is off External printer is used
	Auto-print is on External printer is used		USB Port		25 Pin Parallel External Printer Port
	Fuses type		Power Socket		Grounding
	QC Lockout		Barcode reader		Strip Lockout

Appendix 8 Warranty

Please complete the warranty card included in the packaging. Mail it to your local distributor to register your purchase within 30 days of purchase.

For your records, write the purchase date of your starter kit here:

Note: This warranty applies only to the analyzer in the original purchase. It does not apply to the other materials included with the analyzer.

ACON Laboratories, Inc. warrants to the original purchaser that this analyzer will be free from defects in materials and workmanship for a period of one year (12 months). The one year starts from the later of the date of original purchase or installation (except as noted below). During the stated one year period, **ACON** shall replace the unit under warranty with a reconditioned unit or, at its option, repair at no charge a unit that is found to be defective. **ACON** shall not be responsible for shipping charges incurred in the repair of such an analyzer.

This Warranty is subject to the following exceptions and limitations:

This warranty is limited to repair or replacement due to defects in parts or workmanship. Parts required which were not defective shall be replaced at additional cost. **ACON** shall not be required to make any repairs or replace any parts that are necessitated by abuse, accidents, alteration, misuse, neglect, failure to operate the analyzer in accordance with the operations manual, or maintenance by anyone other than **ACON**. Furthermore, **ACON** assumes no liability from malfunction or damage to analyzers caused by the use of strips other than strips manufactured by **ACON**. **ACON** reserves the right to make changes in the design of this analyzer without obligation to incorporate such changes into previously manufactured analyzers.

Disclaimer of Warranties

This warranty is expressly made in lieu of any and all other warranties express or implied (either in fact or by operation of law) including the warranties of merchantability and fitness for use, which are expressly excluded, and is the only warranty given by **ACON**.

Limitations of Liability

In no event shall **ACON** be liable for indirect, special or consequential damages, even if **ACON** has been advised of the possibility of such damages.

For warranty service, please contact your local authorized **ACON** distributor.

Mission® U120 Urine Analyzer Warranty Card

Please complete this warranty card and mail it to your local distributor to register your purchase within 30 days of purchase. Refer to **Appendix 8 Warranty** in the Instruction Manual for details and terms of the product warranty.

Date of Purchase	Purchaser	Analyzer Serial Number (e.g. SN 0000000. See label on back of analyzer)
Organization Name		Address
Telephone Number		Email address



