

# X-FRAME DR2S Solution

Chest and General X-Ray DR system

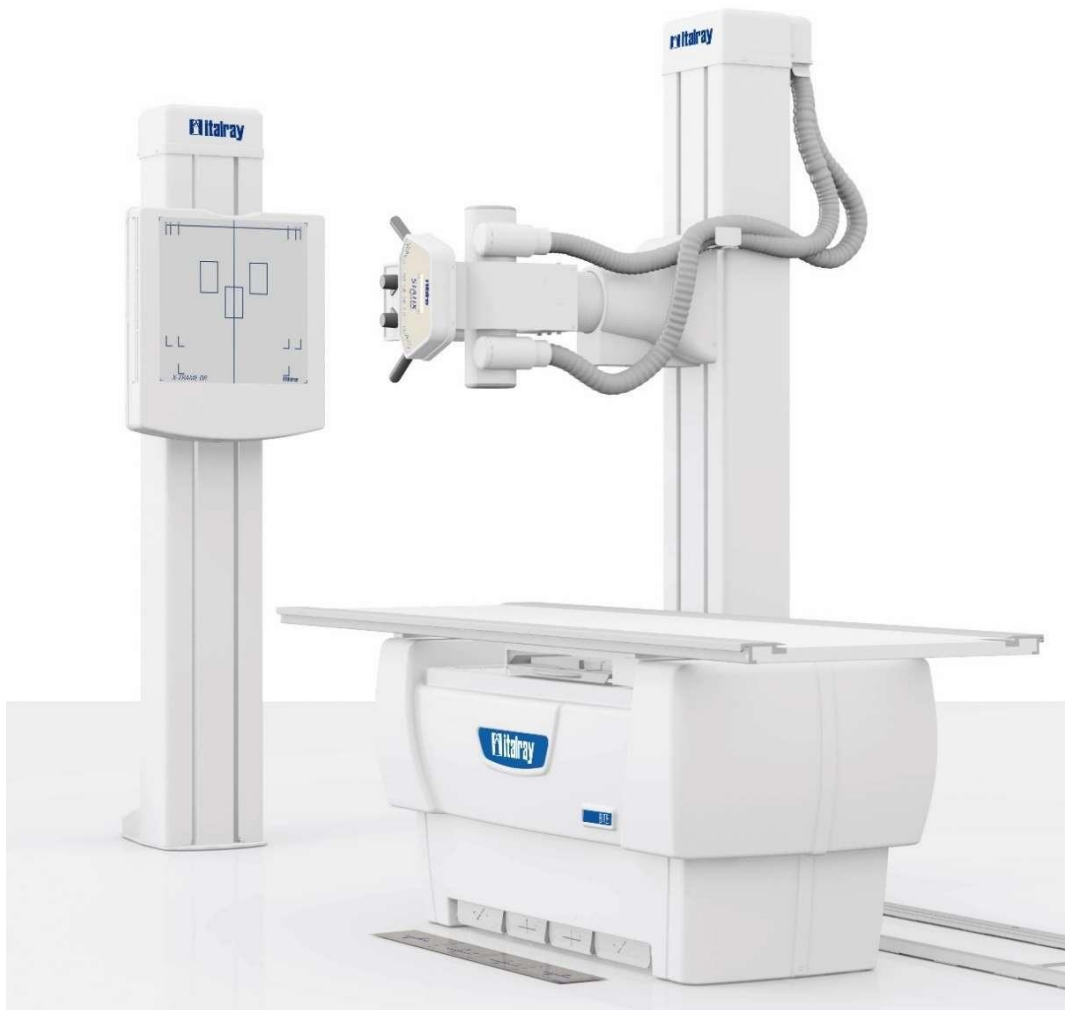

REV.13 (March 2023)

## X-FRAME DR2S Solution

ITALRAY **X-FRAME DR2S SOLUTION** is a high productivity floor mounted Digital X-Ray System with flat panel detector/s capable of taking images in horizontal, vertical and oblique positions for General and Chest examinations, with minimal space requirements, with the following configuration:

- ITALRAY **PIXEL CP** X-ray Generator
- ITALRAY **STATIX** floor mounted tube stand
- ITALRAY **BS45** Vertical Wall bucky
- ITALRAY **BTE** radiographic 4-way elevating motorized table
- ITALRAY **BT** radiographic 4-way static table
- ITALRAY **X-FRAME DR EZ @** Digital Workstation with flat panel detector.

With ITALRAY **X-FRAME DR2S SOLUTION**, flexibility and performances are granted in any application: projections with patient in horizontal/vertical position, chest exams with minimum patient-detector distance, and examinations with grid removal covering any existing routine examination from standing to supine and cross table views.

ITALRAY **X-FRAME DR2S SOLUTION SYNCHRO** is a fully integrated system with all system functions controlled by a single console for both x-ray parameters and image acquisition/processing.

The ITALRAY PIXEL CP X-ray generator is capable of a tube output frequency up to 400 kHz. Thanks to this feature a very high X-ray beam quality is guaranteed at all load conditions. Once the exam is selected on the digital workstation, all the radiological acquisition parameters are immediately set on x-ray generator. This important feature moreover increasing the department productivity reduces the occasion of errors during exam procedure.

ITALRAY **X-FRAME DR2S SOLUTION** is based on the solid-state detectors, featuring amorphous Silicon (a-Si) technology and Gadolinium (GoS) or Cesium Iodide (CsI) scintillator: a combination that guarantees high quality X-ray images for immediate diagnosis, in real time and with low exposure.

ITALRAY **X-FRAME DR2S SOLUTION** versatility is greatly increased thanks to the wireless cassette-size detector that can be positioned either in vertical/horizontal bucky and out of them, in in contact to the patient. This detector is battery powered and employs wireless image data transmission, thus freeing the room from cumbersome and risky cables for an unlimited operation autonomy.

ITALRAY **X-FRAME DR2S SOLUTION** can be supplied with a number of automatic/motorized movements that greatly enhances system productivity.

The everest-X algorithm automatically optimizes image-processing based on exam type and anatomical region. everest-X enhances image content details in both high attenuation image areas (shoulders, abdomen) and, at the same time, low attenuation image areas (lungs, cavities).

Additional post-processing tools are also available such as Edge Enhancement, Unlimited Zoom and Real Size, Window/Level (auto and manual), Measurements, Annotations, Electronic Collimators, Image Stitching (auto and manual), Deviation Index (DI), Exposure Index (EI). The X-FRAME DR software is integrated with an easily configurable Full DICOM package compatible with any RIS and PACS system or DICOM Printer.

## X-FRAME DR2S Solution

ITALRAY **X-FRAME DR2S SOLUTION** can be supplied with fixed and/or mobile Wi-Fi flat panel detectors, in order to perfectly fit all customer needs.

A wide number of configurations are available as shown in the table below:

<b>X-FRAME DR 2S SYSTEMS: DETECTOR CONFIGURATIONS</b>		
<b>N° of detectors</b>	<b>Vertical Bucky</b>	<b>Horizontal Bucky</b>
<b>I)</b> 1 Wireless detector	Wireless	
<b>II)</b> 2 Fixed detectors	Fixed	Fixed
<b>III)</b> 1 Fixed detector + 1 Wireless detector	Fixed	Wireless
<b>IV)</b> 2 Wireless detectors	Wireless	Wireless

**MAIN CHARACTERISTICS**

**AUTOTRACKING (\*)**

Automatic tube-detector vertical focal distance.



**AUTOMATIC CENTERING AND COLLIMATION (\*)**

Automatic centering and collimation also in oblique examinations

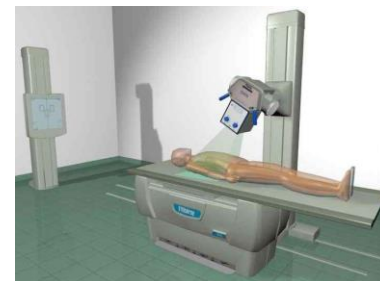
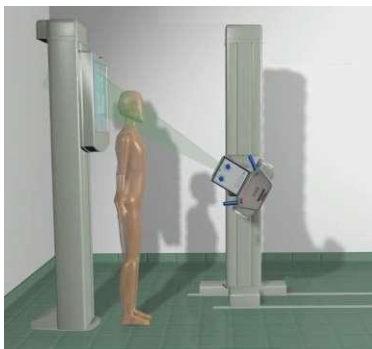

**AUTOMATIC STITCHING (\*)**

For Full-Spine and Full-Leg images, X-FRAME DR2S SOLUTION acquires images with a fully automatic and very fast procedure (rotational stitching). Adjacent images are automatically stitched together in just one single image.

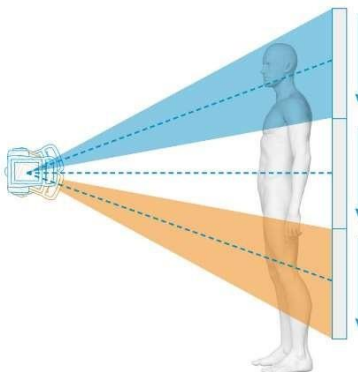

The complete procedure guarantees a maximum patient comfort and optimal image quality minimizing risk of patient movement with very short exposure times, providing also dedicated orthopaedic tools,

**SPECIAL COLLIMATION FOR PAEDIATRIC PATIENTS**

For paediatric patients, the collimation is aligned with the superior border of the detector and not centered on the detector center. In this way patient is not exposed to unnecessary radiation.

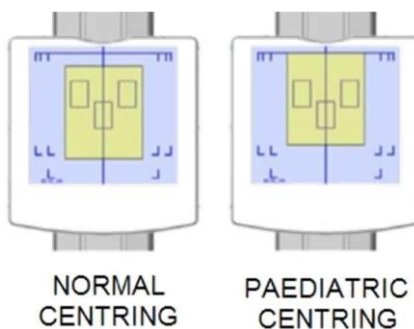

**CONTROL AND SAFETY**

**COLLISION PREVENTION**

Automatic movements are instantaneously blocked when the proximity sensors detect an obstacle in the direction of motion, only after removing the obstacle, the system restarts. In addition to keep everything under control, each movement is only of intentional type (deadman).

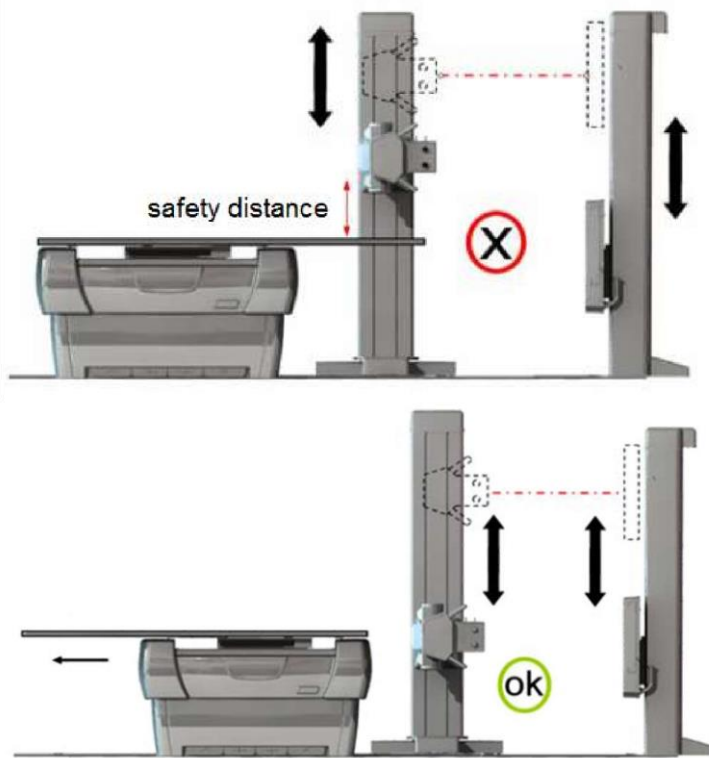

**SHARING SOLUTIONS**

The wireless digital flat panel detectors can also be shared with ALL other Italtay DR and DRF systems, for a maximum optimization of investment.



**PATIENT TABLE BT**



Type	Radiolucent 4 way floating table top with unscratchable, water protected surface and electromagnetic breaking system
Height	75 cm
Max load	Dynamic max load: 250 kg
Controls	Infrared foot sensor to release electromagnetic breaks
Material	Composite (carbon fiber equivalent)
Size	220 x 80 cm
Tabletop - detector distance	6,8 cm
Absorption	< 0,5 mm Al @ 70kVp
Long. travel	± 50 cm (100 cm)
Tranvers. travel	± 13 cm (26 cm)
Detector travel	40 cm (Motorized <sup>(*)</sup> )
Detector speed	7,5 cm/s
Patient coverage	183 cm
Automatic and synchro movement	Auto-centring / Auto-tracking <sup>(*)</sup> (also in oblique projections) / Auto focus maintainment during table elevation
Detector tray	Predisposed for both fixed and wireless ISO 4090 detector
Automatic Exposure Control (AEC)	On board with 3-field ION chambers in table and stand
Detector power integrated into bucky	Yes (*)

<sup>(\*)</sup> Optional

**VERTICAL WALL BUCKY**

**BS45**



Type	Vertical counterbalanced wall bucky with vertical movement and electromagnetic breaking system
Min Detector Height (Vert. Pos.)	40 cm
Max Detector Height (Vert. Pos.)	202 cm
Vertical travel	162 cm Manual Counterbalanced (Motorized <sup>(*)</sup> )
Vertical travel speed	6,6 cm/s
Automatic and synchro movement	Automatic tube detector tracking <sup>(*)</sup> (also in oblique projections and pediatric investigations)
Breaking system	Electromagnetic breaks. All movements are activated from intentional control, deactivated at rest
Collision Detection	Anti collision prevention system guaranteed by a 3D map of the room, which takes care of surrounding room dimensions and unit available movements. <sup>(*)</sup>
Detector insertion	Configurable for either left or right side insertion
Surface – detector distance	6 cm
Radiation absorption	< 0.5 mm Al eq @ 70 kVp
Detector tray	Predisposed for both fixed and wireless detector
Automatic Exposure Control (AEC)	On board with 3-field ION chambers in table and stand
Detector power integrated into bucky	Yes <sup>(*)</sup>

**GRID FOR TABLE AND WALL STAND**

Grid for bucky table (BT/BTE)	oscillating non extractable multifocal grid. R12 – SID 115 cm, 40 lines/cm (for table) and R10 – SID 150 cm 40lines/cm (for wall stand).
-------------------------------	--

<sup>\*)</sup> Optional

# X-FRAME DR2S Solution

## FLOOR TUBE SUPPORT

## STATIX



Type

Floor mounted perfectly counterbalanced tube support with vertical, rotation movement of the column and rotation movement of the tube head and electromagnetic breaking system. Capable of off-table examinations.

Longitudinal Rails

248 cm Front, 300 cm Rear

Rails Height

2 cm

Longitudinal travel

207,6 cm

Longitudinal movement

Manual

Max X-ray Tube Focus Height

200,8 cm

Min X-ray Tube Focus Height  
(Vertical beam)

41,8 cm

Vertical stroke

159 cm

Vertical Movement

Manual (standard) –  
Motorized with Automatic Detector Centering (also for oblique projections) and Automatic Focal Distance<sup>(\*)</sup>

Brakes Type

Electromagnetic brakes. All movements are activated from intentional control, deactivated at rest

Horizontal Axis Tube Rotation Angle

±135° (mechanical stops every 90°)

Vertical Axis Tube Rotation Angle

±90° (mechanical stops every 90°)

Console

Handgrip with Ergonomic Controls

Console Display

LCD, with SID, linear and angular position, and status/error messages. Note:  
**Note:** Not present if collimator with touch screen is installed. See collimator features

<sup>(\*)</sup> Optional



**X-RAY TUBE**

**IAE RTM101 HS**



Type	Dual focus Rotating anode High speed X-Ray tube perfectly compatible with the generator
Anode speed	3000 and 10.000 routes/min (only available when HSS is selected)
Tube construction	RTM
Tube voltage	Up to 150 kV
mA range	10 – 800 mA
Anode Storage Capacity	400 kHU
Maximum Heat Dissipation Rate	84.000 HU/min
Housing capacity	1792 kHU
Target angle	12,5°
Focal spot size	06x0,6 mm (small focus) - 1,2x1,2 mm (large focus)
Focal spot power	26/63kW@3000rpm, 40/100kW@10000rpm
Min. tube assembly inherent filtration	1.2 mm Al @ 75 kV
Safeties	Thermal cut off sensor to avoid over heating

**COLLIMATOR**



Type	Multi leaf manual collimator with retractable tape, filters, adjustable cut-off timer, full field light beam localizer, laser light pointer
Collimator rotation	±45°
Knobs	For adjusting the collimator field
Light source	LED (> 160 LUX)
Light time on	Default: 20 s (adjustable)
Collimation	Square field multilayer (0x0 cm – 48x48 cm @ SID=1 m) Laser centering (*)
Al eq contribution to total filtering	Min 2 mm Al
Additional filtration	<ul style="list-style-type: none"> <li>• 1 mm Al + 0,1 mm Cu</li> <li>• 1 mm Al + 0,2 mm Cu</li> <li>• 2 mm Al + 0,3 mm Cu</li> </ul> Manual selection / Remote control (motorized)**

(\*) Optional

(\*\*) These data are only indicative and referred to standard configurations. Different solutions can be supplied according to customer needs.

**HIGH VOLTAGE GENERATOR      PIXEL CP**



	PIXEL CP 650	PIXEL CP 850	PIXEL CP 1050
Type	High frequency microprocessor controlled inverter type X-Ray generator		
Output frequency	<b>Up to 450 kHz</b>		
Output power	50 kW	65 kW	<b>80 kW</b>
Low ripple	< 1%		
kV range	<b>40 - 150 kV. Precision: 1 kV</b>		
mA range	10 to 630 mA	10 to 800 mA	<b>10 to 1000 mA</b>
Range mAs	0,1 - 630 mAs	0,1 - 1000 mAs	0,1 - 1000 mAs
Time range	0,001 - 6,3 s. Precision: 77 steps. (extendable to 10 or 20 s)		
HSS (High speed starter)	Yes. Automatic selection of rotational speed on the basis of the chosen anatomical program		
APR	Unlimited editable anatomic programs already programmed for each body part, projection and patient dimension and age.		
Available radiological techniques	<b>3 points (kV, mA, mS) technique, 2 points (kV, mAs) technique, 1 point (kV, with AEC) technique</b>		
Independent Operation	Yes. X-ray Generator can also work independently with other imaging supports i.e. film and/or CR		
Console	Directly embedded in the Software on the Acquisition Workstation (FULL DR solution)		
Emergency Stop button	Included in System console		
Automatic Exposure Control (AEC)	On board with 3-field ION chambers in table and stand		
Dose Area Product (DAP)	VacuDAP Dosa Area Product meter with digital interface Dose information stored in image DICOM header (*)		
Exposure switch	Extendable manual exposure switch with 2 levels		
Safeties	Overtemperature protection, Overload protection, automatic mains compensation		

(\*) Optional

**TECHNICAL SPECIFICATIONS**

DIGITAL IMAGING SYSTEM

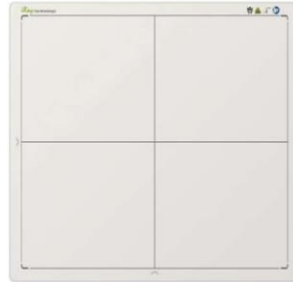

FLAT PANEL DETECTOR	Mars 1717X <sup>(*)</sup>	Mars 1717 <sup>(*)</sup>	Mars 1417 <sup>(*)</sup>
Detector type	Portable wireless		
Technology	Amorphous silicon		
Scintillator	Cesium Iodide (CsI)		
Format (ISO 4090)	43x43 cm (17"x17")	43x43 cm (14"x17")	35x43 cm (14"x17")
Active detector matrix (Effective Pixel matrix)	4267 × 4267 pixels	3072 x 3072 pixels	2304 x 2800 pixels
AD conversion	16 bit	16 bit	14 bit
Pixel pitch	100 µm	139 µm	150 µm
Detector Battery Indicator and Charger	Yes and charger for up to 2 batteries simultaneously		
Battery charge duration	Max. 2,5 hours		
Battery autonomy	Max. 8 hours	Max. 5 hours	
Max.load capacity	300 kg	150 kg	
Typical DQE (@ 0lp and RQA5, per IEC 62220-1)	67%	52%	
Modulation Transfer Function (MTF)	@ 1 lp/mm: 68% @ 3 lp/mm: 21%	@ 1 lp/mm: 60% @ 3 lp/mm: 15%	
Image time	< 4 s	5 s	
Spatial resolution	5 lp/mm	3,3 lp/mm	
Weight	3,4 kg (including battery)	4,5 kg (including battery)	3,82 kg (including battery)
Communication interface	Wireless / Tethered		
X-ray generator synchronization	X-ray push button – <i>Autotriggering</i> mode		

**ACQUISITION WORKSTATION AND SOFTWARE**

Type	Acquisition and review workstation includes on board post processing and dicom full package features
<b>HARDWARE</b>	
HDD	System hard disk: 250 GB read only for virus protection (no need of anti-virus) Hard disk for image archive: <b>1 TB</b> (extendable)
CPU	Intel i5 Quad Core CPU 660 @ 3,3 GHz at least
VGA	GeForce GTX 1660 6GB
RAM	4 GB (extendable to 8 or 16Gbyte)
CD/DVD recorder	Yes <sup>(*)</sup> . Integrated
Accessories	Wired mouse and keyboard
Operating system	Windows 7 Embedded 64 bit at least
Network	Gigabit Ethernet 2 ports
USB	2 USB 2.0 ports
Access point	Yes <sup>(*)</sup> . 802.11g/108 Mbps 2,4 GHz Wireless Access Point
UPS	Yes <sup>(*)</sup> . Emergency power unit system that grants for safe and controlled switch off preventing any data loss or damage with 20 min back up time
Image storage capacity	58.500 images (no compression) 125.000 images (lossless compression)
Console	Dedicated console with system switch on/off and embedded emergency push button
<b>SOFTWARE</b>	
Patient and exam management	Yes. Includes advanced search function
Real Time image enhancement	Everest-X algorithm takes care of enhancing the clinical diagnostic image details in order to obtain a sharp and well contrasted diagnostic image.
Patient an exam management	Patient and exam management system with emergency examination insertion and patient and exam dedicated search system
Image Display functions	Image Flip/Mirror, R.O.I., Pan/Zoom, Window/Level, Automatic Window/Level, Soft/hard tissue equalization, Annotations, Linear and angular measurements, Greyscale Inversion, Image Rotation, Electronic Collimators, Spatial Filters, Multi-Images Visualization (Smart Windowing)
APR	Unlimited preconfigured editable Anatomical Programs divided by body part, projection, patient age and dimension.
FULL DR Solution	Generator and Detector are directly communicating with the acquisition software (FULL DR solution) so that it's possible in any moment to understand what are the status of these last.
Deviation Index	Yes
Reject analysis	Yes
Multi-language	English, Italian, Russian, French, ...
Audio visual exposure indicator	Directly embedded into software

<sup>(\*)</sup> Optional

## ACQUISITION WORKSTATION AND SOFTWARE

### ACQUISITION WORKSTATION

#### STANDARD MONITOR



Type	EIZO LCD colour, 2 MP anti glare display multitouch screen
Size	23"
Recommended resolution	1920 x 1080 (16: 9 aspect ratio)
Contrast	1000:1
Brightness	260 cd/mq

### NETWORKING

#### DICOM functions

DICOM Storage (SCU)	Yes. Send Image to PACS
DICOM Modality worklist (SCU)	Yes. Interface with HIS / RIS with auto refresh option
DICOM Print management Class	Yes. Covers the general cases of printing medical images in standardized layouts
DICOM Media exchange (DICOM DIR)	Yes <sup>(*)</sup> . Patient images export to DVD/CD
DICOM MPPS (SCU)	Yes <sup>(*)</sup> . Send the status of exams to HIS / RIS
DICOM Storage commitment (SCU)	Yes <sup>(*)</sup> . Send commitment status
DICOM Verification (SCU) <sup>(*)</sup>	Yes <sup>(*)</sup> .
DICOM Query / Retrieve (SCU)	Yes <sup>(*)</sup> . Query and retrieve images from PACS
DICOM Grayscale print (SCU)	Yes <sup>(*)</sup> . Support DICOM printers
DICOM Structured Dose Report	To exchange structured data produced in the course of image acquisition or post-processing

#### IHE Integration Profile

Scheduled Workflow	Acquisition Modality : Patient Based Worklist Query / Assisted Acquisition protocol Setting / PPS Exception Management
Patient Information Reconciliation	Acquisition Modality
Consistent Presentation of Image	Acquisition Modality
Radiation Exp. Monitoring	Acquisition Modality

### REMOTE SERVICE

Remote access	ITALRAY X-FRAME DR SYSTEMS are equipped with a remote service system that allows ITALRAY service engineers to have access the system via remote network for servicing and upgrading purposes. The remote servicing system availability is subordinate upon the technical/policy characteristics of the local Hospital network.
---------------	--

<sup>(\*)</sup> Optional

# X-FRAME DR2S Solution

## TECHNICAL SPECIFICATIONS

### INSTALLATION DATA

Generator power supply	Three phase 380 Vac +/-10%, 50/60Hz
Workstation Power supply	Single phase 230 Vac +/- 10%, 50/60 Hz
Wall stand (BS45)	DIMENSIONS: : 81 x 56 x 229 cm WEIGHT: 200 kg
X-ray tube stand (STATIX)	DIMENSIONS: 300 x 107 x 233 cm FRONTAL LONGITUDINAL RAILS: 248 cm POSTERIOR LONGITUDINAL RAILS : 300 cm RAIL HEIGHT: 2 cm WEIGHT: 219 kg
Patient table	DIMENSIONS: 220 x 77 x 55 cm (BTE) - 220 x 77 x 75 cm (BT) WEIGHT: 250 kg (BTE) - 140 kg (BT)
Generator cabinet	DIMENSIONS: 55,9 x 40,6 x 123,7 cm WEIGHT: 107 kg
System cabinet	DIMENSIONS: 55 x 70 x 135 cm WEIGHT: 100 kg

### ENVIRONMENTAL CONDITIONS

<b>OPERATING</b>	
Temperature	+15°C ÷ +35°C
Humidity	20% ÷ 75%
Atmospheric Pressure	700 mbar ÷ 1060 mbar
<b>TRANSPORT AND STORAGE</b>	
Temperature	0°C ÷ +50°C
Humidity	20% ÷ 80%
Atmospheric Pressure	500 mbar ÷ 1060 mbar

### ROOM CONSIDERATION (TYPICAL LAYOUT)

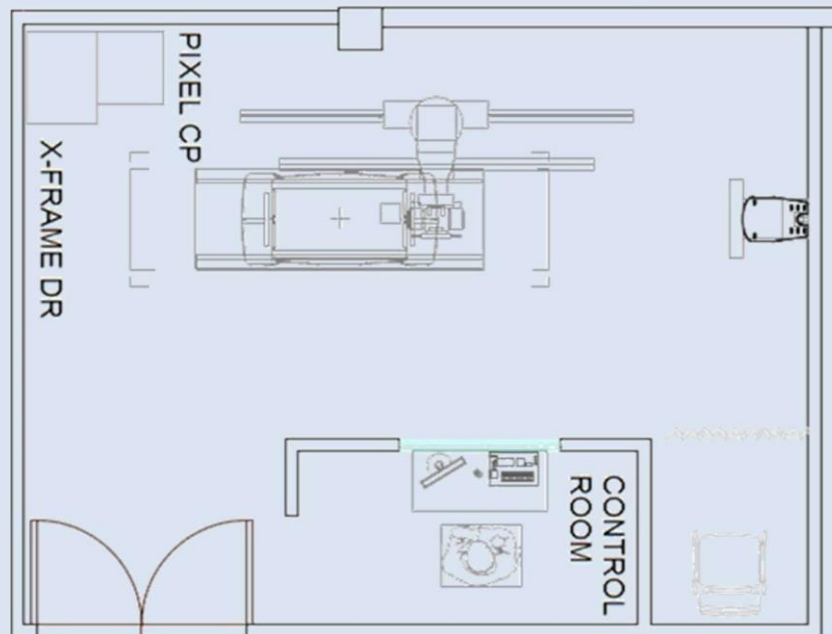

<sup>(\*)</sup> Optional

SIZE AND DIMENSIONS

BS45

FRONT VIEW

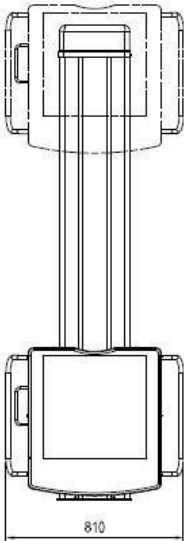

LATERAL VIEW

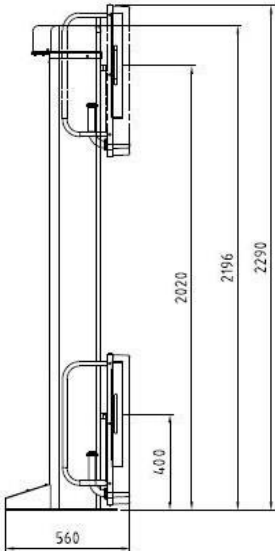

TOP VIEW

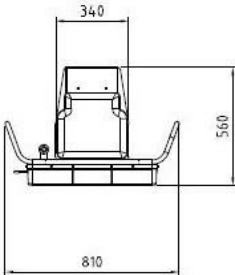



X-FRAME DR2S Solution

SIZE AND DIMENSIONS

STATIX

TOP VIEW

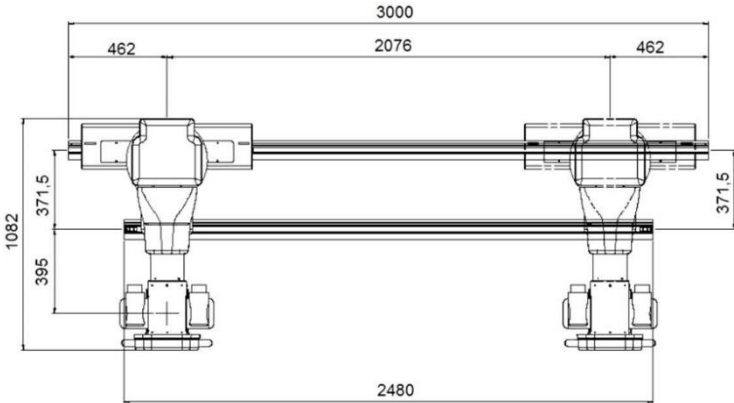

LATERAL VIEW

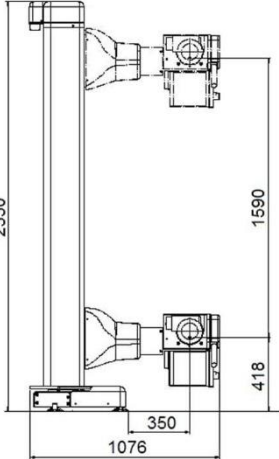

**ACCESSORIES**

**ACCESSORIES FOR BS45 VERTICAL BUCKY (\*)**

Accessory for stitching exams: it supports the patient during several expositions. With double footrest and optional compression band



**ACCESSORIES FOR BT/BTE HORIZONTAL BUCKY (\*)**

Compression band  
Handles (couple)  
Leg support (couple)



Lateral wireless detector holder for lateral projection on lying patient



(\*) Optional

**ACCESSORIES**

**ACCESSORIES FOR WIRELESS DETECTOR (\*)**

Wireless detector holder for weight bearing examinations



Snap-on Grid System, including 80 lp/cm grid



(\*) Optional

**ITALRAY reserves the right to make modifications without any prior notice.**



Via Del Parlamento Europeo 9/D 50018 Scandicci  
Firenze  
Tel. +39/055/7228511 fax. +39/055/7228512

[info@italray.it](mailto:info@italray.it)  
italray.it