

CHM[®]

CHARFIX *system*

INTRAMEDULLARY OSTEOSYNTHESIS OF TIBIA

- *IMPLANTS*
- *INSTRUMENT SET 40.5000.600*
- *SURGICAL TECHNIQUE*

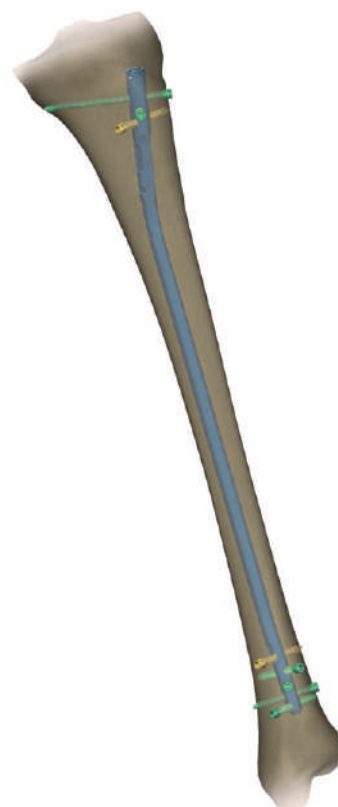

SYMBOLS DESCRIPTION



Caution - pay attention to a special procedure.



Perform the activity under X-Ray control.



Information about the next stages of a procedure.



Proceed to the next stage.



Return to the specified stage and repeat the activity.

www.chm.eu

Document No ST/25C
Date of issue 20.10.2010
Review date P-002-19.11.2020

*The manufacturer reserves the right to introduce design changes.
Updated INSTRUCTIONS FOR USE are available at the following website: ifu.chm.eu*

I. INTRODUCTION	5
II. IMPLANTS	8
III. LOCKING ELEMENTS	10
IV. INSTRUMENT SET	11
V. SURGICAL TECHNIQUE	13
V.1. INTRODUCTION	13
V.2. OPENING THE MEDULLARY CANAL.....	14
V.3. PREPARATION OF INTRAMEDULLARY CANAL FOR NAIL INSERTION	14
V.4. NAIL INSERTION	16
V.5. DISTAL LOCKING OF INTRAMEDULLARY NAIL.	18
<i>V.5.1. OPTION I: X-Ray control</i>	<i>18</i>
<i>V.5.2. OPTION II: Whitout X-Ray control.....</i>	<i>21</i>
<i>V.5.3. Insertion of instrument devices into slider holes of Distal targeter</i>	<i>27</i>
V.6. PROXIMAL NAIL LOCKING	28
<i>V.6.1. Dynamic method and dynamic method with compression</i>	<i>28</i>
<i>V.6.2. Static method</i>	<i>30</i>
VI. SURGICAL TECHNIQUE - RECONSTRUCTIVE METHOD	32
VI.1. PROXIMAL LOCKING OF THE RECONSTRUCTION INTRAMEDULLARY NAIL.....	32
VI.2. INSERTING COMPRESSION SCREW OR END CUP	35
VII. LOCKING OF INTRAMEDULLARY NAIL USING TARGETER D [40.1344] AND TARGETER ARM B [40.5301].....	36
VII.1. DISTAL LOCKING OF THE NAIL USING TARGETER D [40.1344] – „FREEHAND TECHNIQUE“.....	36
VIII. NAIL EXTRACTION	38

I. INTRODUCTION

CHARFIX_{system} - INTRAMEDULLARY OSTEOSYNTHESIS OF TIBIA consists of:

- implants (*intramedullary nail, locking screws, end cap or compression screw*),
- instrument set for implants insertion and extraction,
- instruction for use (*surgical technique*).

Intramedullary osteosynthesis of tibia provides stable fixation of tibia shaft fractures.

Indications:

- multi-fragmental fractures of the shaft of the tibia
- tibia and fibula fractures,
- fractures with knee ligaments injury,
- tibia fractures with compartment syndrome,
- open fractures I, II, IIIA degree by Gustillo-Anderson,
- pathological fractures,
- malunion of tibia shaft fractures treated with other methods.

CHARFIX_{system} provides the following methods:

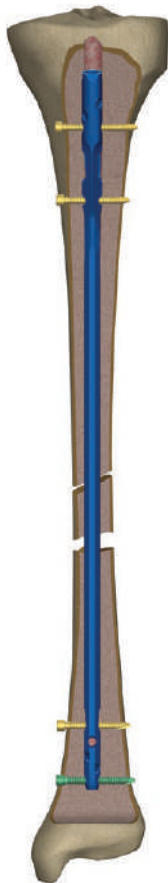

Static Method

Static fixation is used in multi-fragmental fractures with bone fragments mal-alignment.

In the static fixation to lock the nail with the screws, two distal holes and two or all proximal holes should be used.

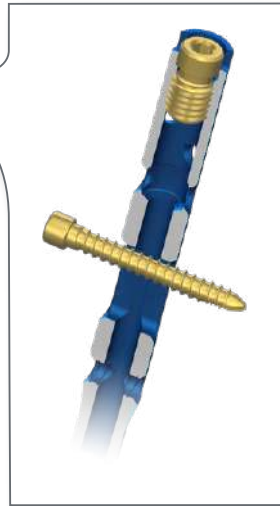

Dynamic Method

Dynamic fixation may be used in the case of good cortical contact of bone fragments in transverse or oblique fractures, and in false joints.

One oval shaped proximal and two distal holes of intramedullary nail should be used.

Dynamic fixation enables axial movements of bone fragments during the limb loading and stimulates creating bone scar and its reconstruction into the lamellar bone.

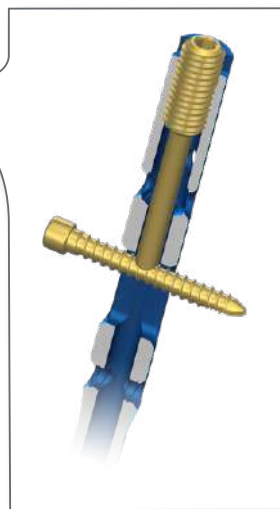

Dynamic Method with Compression

In the dynamic fixation with compression, the compression screw is axially inserted to put pressure on screw locking the nail. Compressive fixation eliminates all micromovements in early stage of treatment.

Reconstruction Method

Threaded reconstructive holes in proximal part enable stable fixation of the tibial condyle.

Threaded holes enable optional locking using:

- proximal screw 4.5;

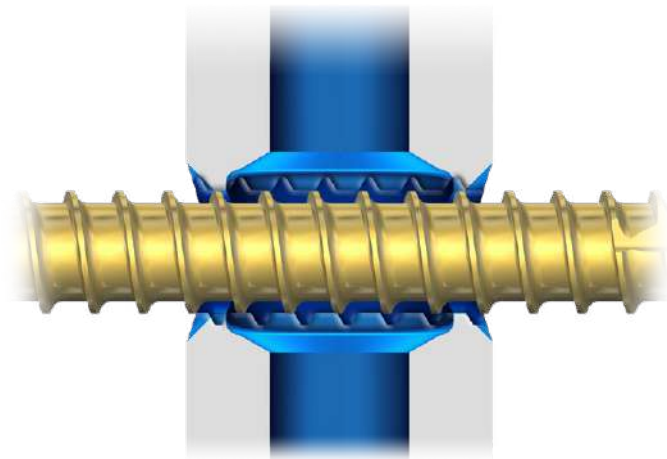

- locking distal screw 5.0 which prevents angular displacement of bone fragments (*using threaded hole in the nail*).

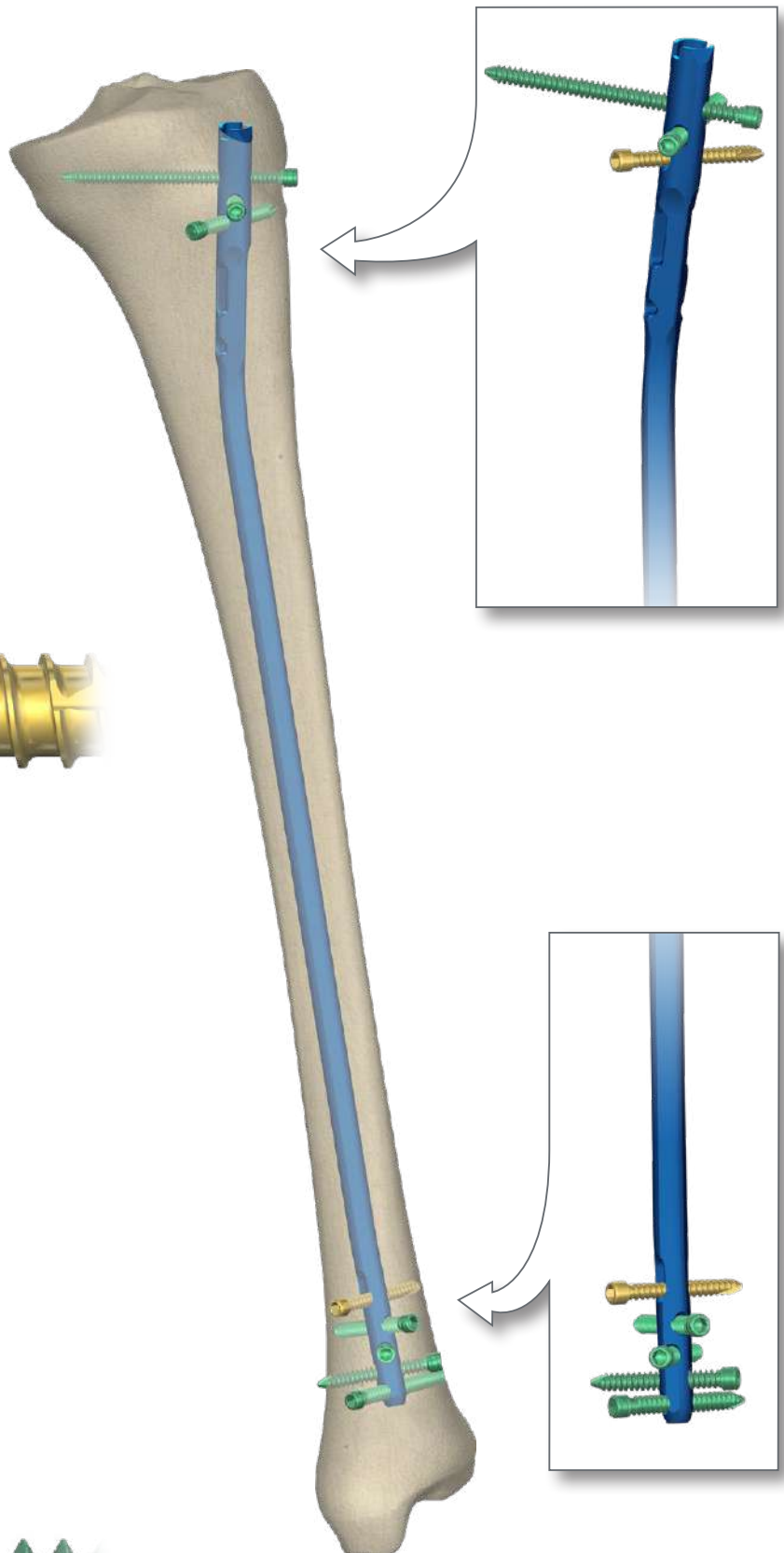
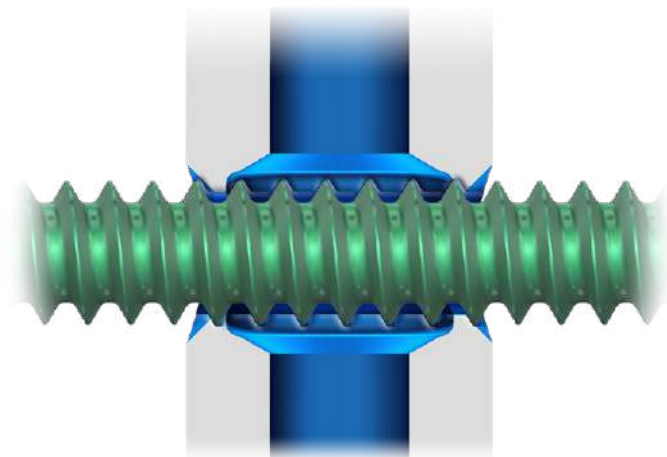

II. IMPLANTS

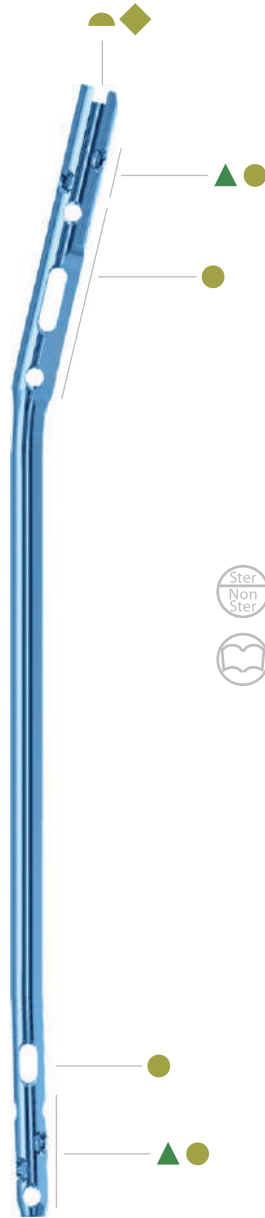
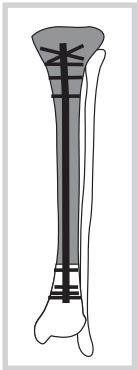
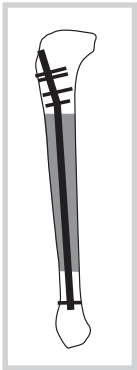





	Len	Ti
8	270	3.2623.270
	285	3.2623.285
	300	3.2623.300
	315	3.2623.315
	330	3.2623.330
	345	3.2623.345
	360	3.2623.360
	375	3.2623.375
9	390	3.2623.390
	270	3.2624.270
	285	3.2624.285
	300	3.2624.300
	315	3.2624.315
	330	3.2624.330
	345	3.2624.345
	360	3.2624.360
10	375	3.2624.375
	390	3.2624.390
	270	3.2625.270
	285	3.2625.285
	300	3.2625.300
	315	3.2625.315
	330	3.2625.330
	345	3.2625.345
11	360	3.2625.360
	375	3.2625.375
	390	3.2625.390
	270	3.2626.270
	285	3.2626.285
	300	3.2626.300
	315	3.2626.315
	330	3.2626.330
12	345	3.2626.345
	360	3.2626.360
	375	3.2626.375
	390	3.2626.390
	270	3.2627.270
	285	3.2627.285
	300	3.2627.300
	315	3.2627.315
	330	3.2627.330
	345	3.2627.345
	360	3.2627.360
	375	3.2627.375
	390	3.2627.390

	Ti					
	3.1657.xxx	✓	✓	5.0	26÷80	▲
	3.1654.xxx	✓		4.5	25÷80	●
	3.2106.002	✓				◐
	3.2104.1xx	✓	✓	0÷15		◆

St

St	Ø	pitch
available	7 mm ÷ 14 mm	1 mm
	L 210 mm ÷ 600 mm	5 mm

		
	Len	Ti
8	270	3.2637.270
	285	3.2637.285
	300	3.2637.300
	315	3.2637.315
	330	3.2637.330
	345	3.2637.345
	360	3.2637.360
	375	3.2637.375
	390	3.2637.390
9	270	3.2638.270
	285	3.2638.285
	300	3.2638.300
	315	3.2638.315
	330	3.2638.330
	345	3.2638.345
	360	3.2638.360
	375	3.2638.375
	390	3.2638.390
10	270	3.2639.270
	285	3.2639.285
	300	3.2639.300
	315	3.2639.315
	330	3.2639.330
	345	3.2639.345
	360	3.2639.360
	375	3.2639.375
	390	3.2639.390

				
	St			
available		Ø	7 mm ÷ 14 mm	pitch 1 mm
		L	210 mm ÷ 600 mm	5 mm

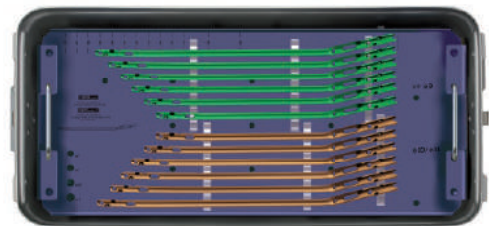

Stand for tibial nails CHARFIX/CHARFIX2 (implants not included)

40.5750.000

III. LOCKING ELEMENTS

CHARFIX DISTAL SCREW 4.5



25	3.1654.025
30	3.1654.030
35	3.1654.035
40	3.1654.040
45	3.1654.045
50	3.1654.050
55	3.1654.055
60	3.1654.060
65	3.1654.065
70	3.1654.070
75	3.1654.075
80	3.1654.080



CHARFIX DISTAL SCREW 5.0



26	3.1657.026
30	3.1657.030
35	3.1657.035
40	3.1657.040
45	3.1657.045
50	3.1657.050
55	3.1657.055
60	3.1657.060
65	3.1657.065
70	3.1657.070
75	3.1657.075
80	3.1657.080



CHARFIX COMPRESSION SCREW M8x1.25



3.2106.002



CHARFIX END CAP M8

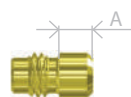

A	
0	3.2104.100
+5	3.2104.105
+10	3.2104.110
+15	3.2104.115



Stand for CHARFIX nail locking elements (set with a box without implants)

40.4686.200















IV. INSTRUMENT SET



















Instrument set [40.5000.600] is used for tibia shaft fixation, and implant removal after finished treatment. All instruments are placed in a stand with a lid to facilitate sterilization and transportation to the surgical suite.

Instrument set consists of:

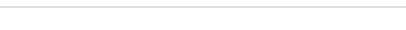
INSTRUMENT SET FOR TIBIAL NAILS 40.5000.600



40.5000.600	Name	Pcs	Catalogue No.
	Targeter arm B	1	40.5301.000
	Distal targeter D	1	40.5322.000
	Targeter B	1	40.5373.000
	Wrench S8	1	40.5304.000
	Connecting screw M8x1.25 L-91	1	40.5325.000
	Reconstruction targeter	1	40.5377.000
	Impactor-extractor	1	40.5308.000
	Connector M8x1.25/M14	1	40.5309.000
	Compression screw	1	40.5324.000
	Curved awl 8.0	1	40.5523.000
	Mallet	1	40.3667.000
	Protective guide 9/6.5	2	40.3614.000
	Drill guide 6.5/3.5	2	40.3615.000
	Set block 9/4.5	2	40.3616.000

40.5000.600	Name	Pcs	Catalogue No.
	Trocar 6.5	1	40.3617.000
	Drill guide 6.5/4.5	1	40.3696.000
	Screw length measure	1	40.1374.000
	Hole depth measure	1	40.2665.000
	Nail length measuring	1	40.4798.500
	Targeter D	1	40.1344.000
	Trocar short 7	1	40.1354.000
	Drill guide short 7/3.5	1	40.1358.000
	Guide rod handle	1	40.1351.000
	Teflon pipe guide 8/400	1	40.3700.000
	Aiming insert 9.0	2	40.5065.009
	Guide rod 2.5/580	1	40.3673.580
	Hexagonal screwdriver S 3.5	1	40.3619.000
	Drill with scale 3.5/270	2	40.5330.001
	Drill with scale 3.5/150	1	40.5343.001
	Drill 4.5/270	1	40.1387.001
	Perforated aluminum cover 1/1 595x275x15mm gray	1	12.0750.200
	Stand	1	40.5379.500
	Container with solid bottom 1/1 595x275x135mm	1	12.0750.102

To perform the surgery, some other basic devices each operating room should be equipped with are needed:

- electric drive,
 - set of flexible intramedullary reamers ($\varnothing 8.0-13.0\text{ mm}$) with the drill guide and handle,
 - set of surgical drills,
 - Kirschner wires,
 - set of awls (*standard and cannulated*),
 - mallets
- and others.



There is additional place for the Targeter B-D [40.5372] and the Lateral targeter [40.5378] in the Instrument Stand. The devices may be used for osteosynthesis of the tibia using retrograde tibial nail.



Additional devices are not included in the Instrument Set [40.5000.600].

V. SURGICAL TECHNIQUE

V.1. INTRODUCTION

Each surgical procedure must be carefully planned.

X-Ray of the tibial fracture in AP and lateral position shall be performed before starting the operation in order to define the type of fracture and the size of intramedullary nail (*length, diameter*). To define the length of the nail, measuring the length of the fibula can be helpful. The operation shall be performed on operating table equipped with traction and C-arm device.

When patient is placed supine, the operated limb should be bent in the hip at an angle of 70-90°, abducted at an angle of 10-20° and bent at 80-90° in the knee joint; the ankle joint should stay in neutral position (*foot perpendicular to tibia*).

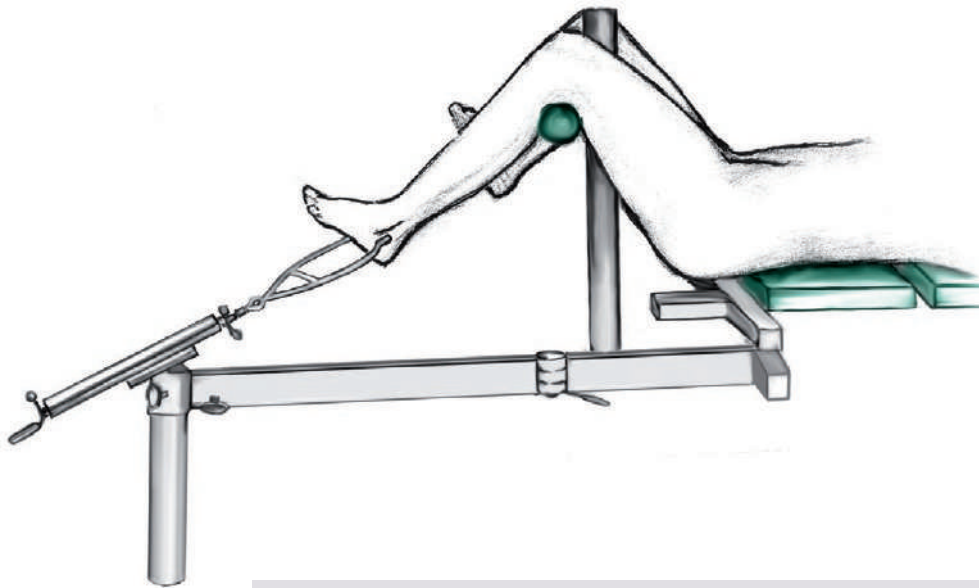

Supine position shall enable X-Ray control in AP and lateral position.

Surgical approach should be prepared by:

- longitudinal skin incision from the lower pole of patella to the point placed medially from tuberosity of tibia,
- longitudinal incision along medial edge of patella tendon and its aside move.

Insertion point is placed on extension of the line proceeding in the middle of medullary canal (*X-Ray in AP position*) and on the tuberosity edge of tibia and its front epiphysis edge.

Intramedullary canal should be 1.5-2.0 mm wider than the diameter of tibial nail.

In the case of reaming the canal, the intramedullary canal should be wider 1.5-2 mm then the diameter of the nail. The proximal part of the canal shall be widened for 12 mm at the depth of 5 cm.

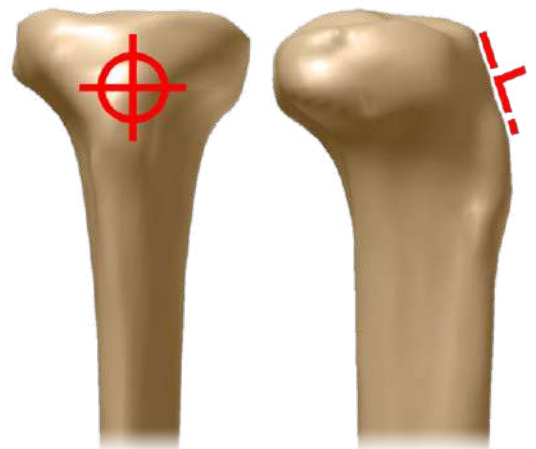

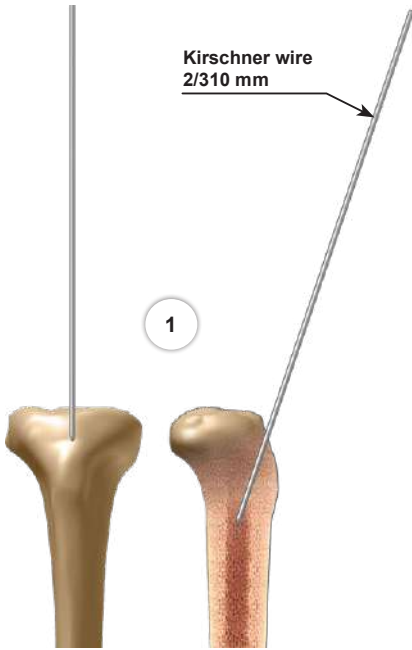

V.2. OPENING THE MEDULLARY CANAL

- 1 After preparing the surgical approach and locating insertion point for the nail (*description: chapter III.1. Introduction*), use the electrical drive to insert Kirschner wire (*recommended 2/310 mm*) into intramedullary canal at an angle appropriate to the deflection of the nail shaft to the main axis (*13 degrees*).



The process should be controlled with image intensifier.

Kirschner wire acts as the guide for the Curved Awl.
Kirschner wire is a single use instrument.

- 2 Open the intramedullary canal leading the Curved Awl [40.5523] via Kirschner Wire.

Remove the Curved Awl and Kirchner Wire.



Note:
It is recommended to open the intramedullary canal with technique described in step 1 and 2. However, the surgeon may use different technique depending on equipment of the surgical suite.

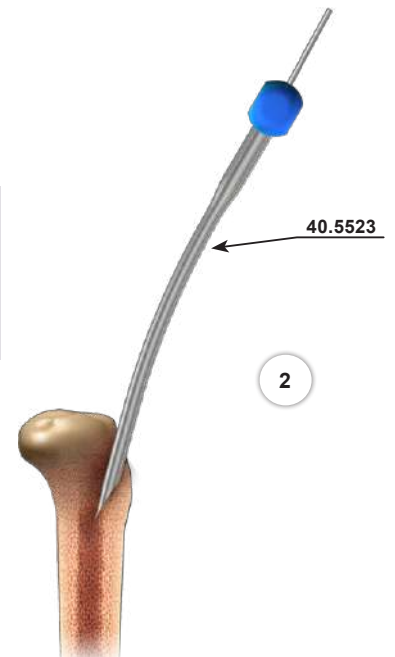

V.3. PREPARATION OF INTRAMEDULLARY CANAL FOR NAIL INSERTION

OPTION I: Reamed canal

- 3 Insert the Guide Rod 2.5/580 [40.3673.580] into the medullary canal until its tip reaches the distal epiphysis of tibia, reducing the fracture at the same time. Gradually widen intramedullary canal using the flexible reamers with steps of 0.5 mm until it reaches the diameter 1.5 to 2 mm wider than the nail, to the depth at least equal to the nail length. In the case of using the nail 10 mm or smaller diameter, widen proximal part of intramedullary canal with reamer to the 12 mm diameter to the depth approx. 5 cm.

Remove the flexible reamer.
Leave the flexible reamer guide in the medullar canal.

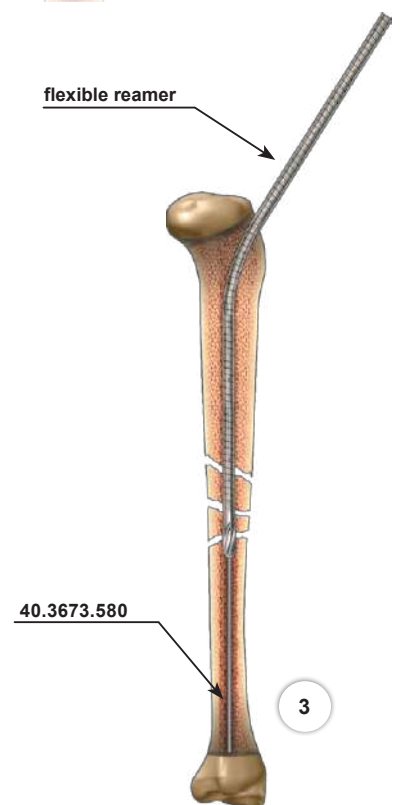

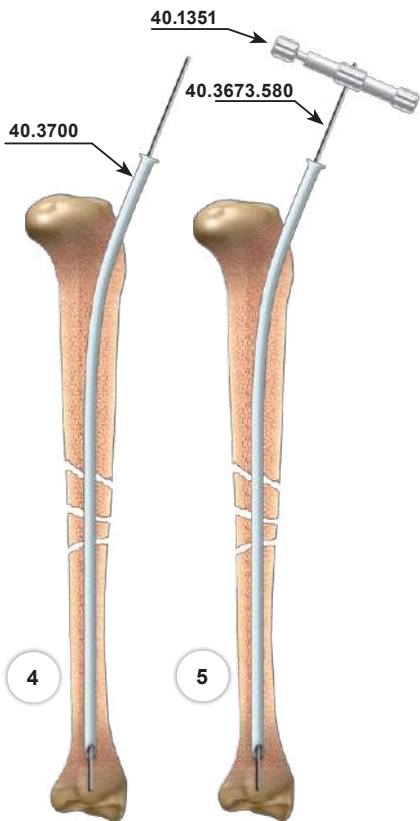

- 4 In the case of using other guide for the reamer then the Guide Rod, insert the Teflon Pipe Guide 8/400 [40.3700] into the medullary canal.

Remove the Reamer Guide.

- 5 Mount the Guide rod handle [40.1351] on the Guide Rod (for cannulated nail) [40.3673.580] and advance into the Teflon Pipe Guide 8/400 [40.3700] until its tip reaches the distal epiphysis of tibia.

Remove the Guide rod handle.
Remove the Teflon Pipe Guide 8/400.

- 5a Insert the Nail Length Measure [40.4798.500] via the Guide Rod. The tip of the measure should be placed in the desired depth. Read the nail length on the measure.

Remove the Measure from the Guide Rod.

In the case of using solid nail, remove the Guide Rod from the intramedullary canal.



OPTION II: Unreamed canal

- 3 Mount the Guide rod handle [40.1351] on the Guide Rod [40.3673.580] and advance into intramedullary canal until its tip reaches the distal epiphysis of tibia, reducing the fracture at the same time.

Remove the Guide rod handle from the Guide Rod.

Widen the proximal part of the intramedullary canal with flexible reamers to the depth approx. 5 cm. In the case of using the nail 10 mm or smaller diameter, widen proximal part of medullary canal to the 12 mm diameter; for nail 11 mm or larger – the diameter 1.5 to 2 mm wider then the diameter of the nail.

Remove the Flexible Reamer.
Leave the Guide Rod in medullary canal.

- 4 Insert the Nail Length Measure [40.4798.500] via the Guide Rod. The tip of the Measure should be placed in desired depth of nail insertion. Read the length of the nail on the measure. Remove the Nail Length Measure from the Guide Rod.

In the case of solid nail, remove the Guide Rod from the medullary canal. The medullary canal is prepared for the nail insertion.

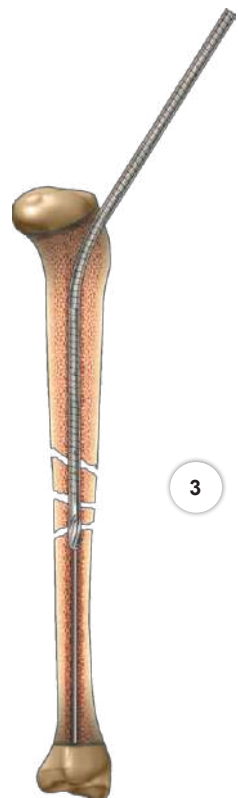
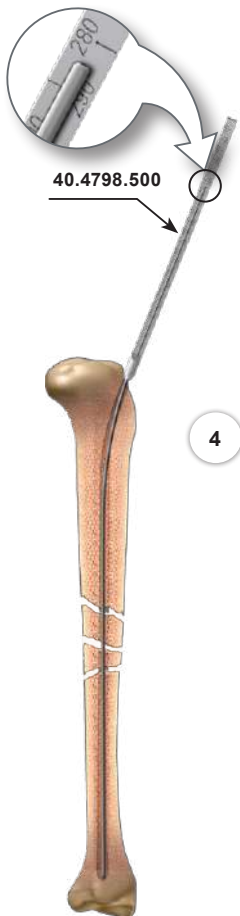

V.4. NAIL INSERTION

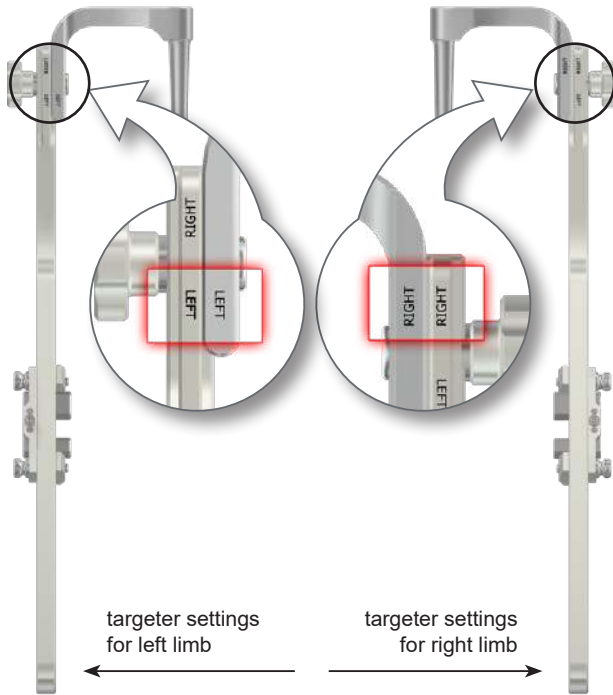

Note:
 The way of mounting the Targeter arm B [40.5301] with the Distal targeter D [40.5322] and the position of the slider in distal part depends on the operated limb (left or right).
 It is recommended to place the targeter in such way that its proximal part is directed to the operator and the distal bent part is directed upward.

Then:

Right leg:

- connective part of the Distal targeter D should be inserted into socket of the Targeter arm from the right side and mounted using nut.
- the slider of the Distal targeter D in distal part should be arranged in such way, that its adjusting and mounting elements are placed on the left side.

Left leg:

- connective part of Distal targeter D should be inserted into socket of the Targeter arm from left side and mounted using nut.
- slider of the Distal targeter D in distal part should be arranged in such a way, that its adjusting and mounting elements are placed on the right side.

- 6 Using the Socket Wrench S8 [40.5304] fix the intramedullary nail to the Targeter arm B [40.5301] with the Connecting Screw M8x1.25 L-91 [40.5325].



IMPORTANT!
 The accordance in direction of deflection of the nail distal part and the Distal targeter D [40.5322] proves the mounting correctness.



- 7 Setting the Distal targeter D [40.5322] to the nail. Using the Hexagonal Screwdriver 3.5 [40.3619] adjust the sliding element of the targeter in the middle of the slider plate. With a pair of two Set Blocks 9/4.5 [40.3616] place the slider of targeter in line with distal locking holes of the intramedullary nail. Secure the slider of targeter with screw using the Hexagonal Screwdriver 3.5 [40.3619].



VERIFY:
If the slider is properly set and secured, the set blocks should smoothly pass through the nail holes.

Remove set blocks from the targeter slider. Dismount the Distal targeter D [40.5322] from the Targeter arm B [40.5301].

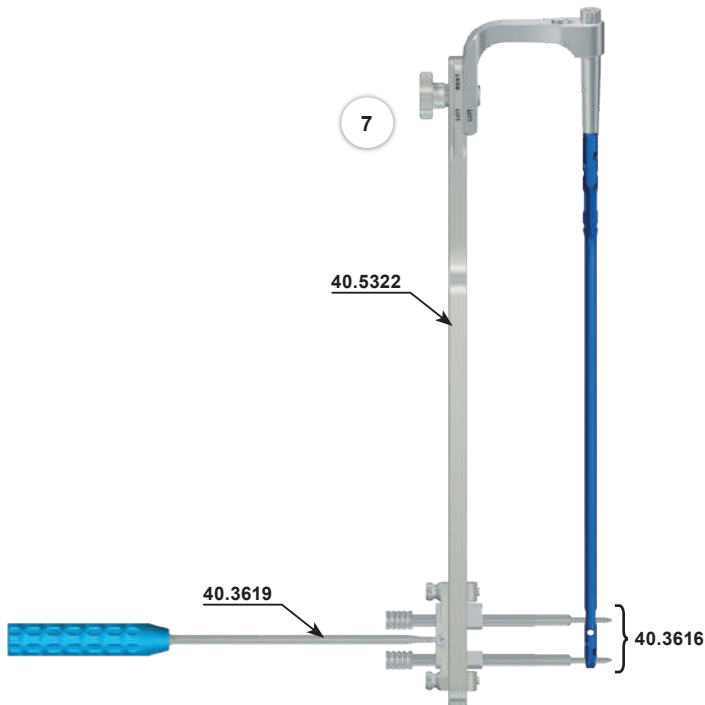

- 8 Connect the Impactor-Extractor [40.5308] with the Targeter arm B [40.5301].

- 9 Insert the nail into medullary canal to the appropriate depth using the Mallet [40.3667].



Attention!
Cannulated nail should be inserted into the medullary canal via the Guide Rod [40.3673.580].
Solid nail should be inserted directly into the medullary canal (without use of guide rod).

Dismount the Impactor – Extractor [40.5308] from the guide.
Remove the Guide Rod (when cannulated nail was used).

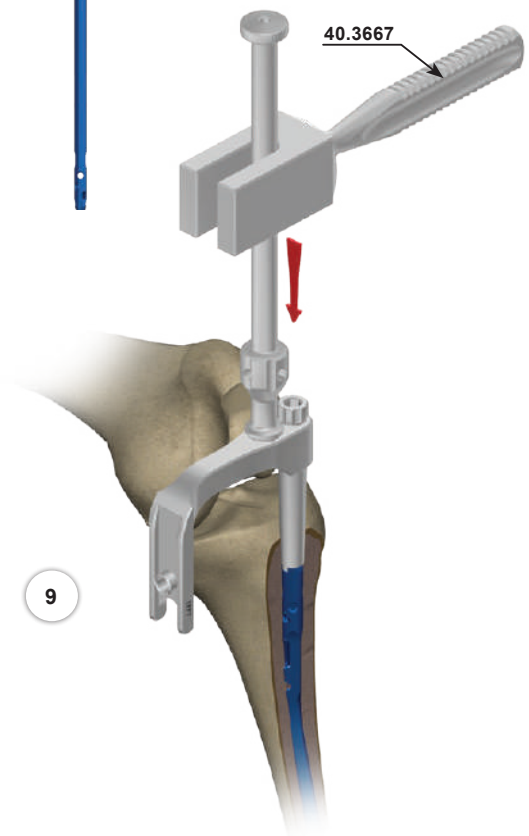

V.5. DISTAL LOCKING OF INTRAMEDULLARY NAIL.

V.5.1. **OPTION I: X-Ray control**

10 Verify the position of holes in the targeter slider and in the distal part of the nail using image intensifier.

- Mount the Distal targeter D [40.5322] onto the Targeter arm [40.5301].
- Place image intensifier in such way, that the image on display shows round shaped holes (*proximal or distal*) in the nail.
- Insert the Protective Guide [40.3614] into the appropriate hole of targeter slider until its tip reaches the soft tissue.
- Verify with X-Ray mutual position of the hole in the Drill Guide and the hole in the intramedullary nail.



The holes in the nail and the drill guide are to be congruent on the display – circle shape should be shown (*shape similar to circle is accepted*). The position of targeter should be corrected in the case shape on the display is different from circle. Then using the Hexagonal Screwdriver 3.5 [40.3619], shift targeter slider (by turning the screw to the left or to the right) to the position when circle shape are shown on the display (*shape similar to circle is accepted*).

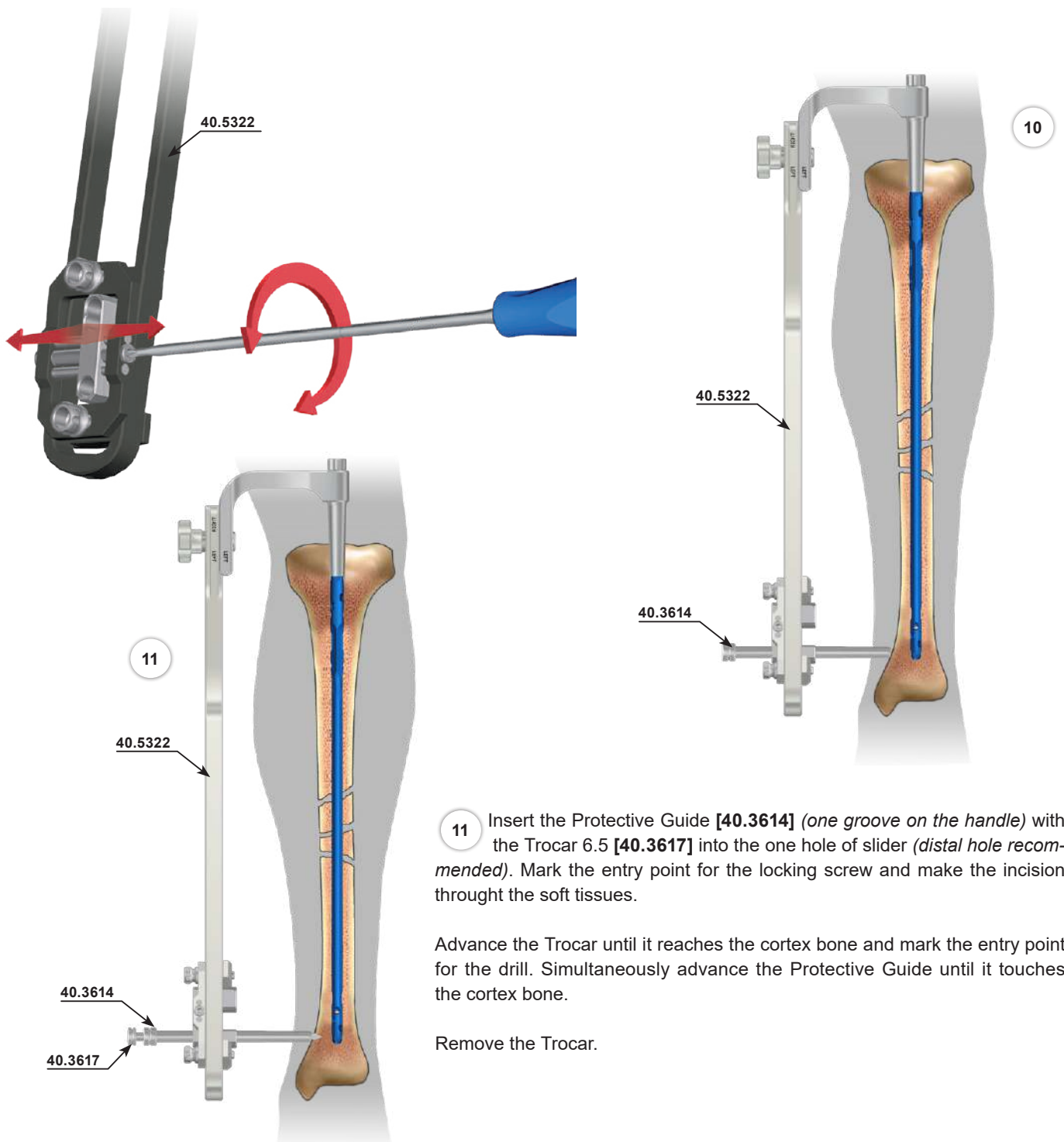

11 Insert the Protective Guide [40.3614] (one groove on the handle) with the Trocar 6.5 [40.3617] into the one hole of slider (*distal hole recommended*). Mark the entry point for the locking screw and make the incision through the soft tissues.

Advance the Trocar until it reaches the cortex bone and mark the entry point for the drill. Simultaneously advance the Protective Guide until it touches the cortex bone.

Remove the Trocar.

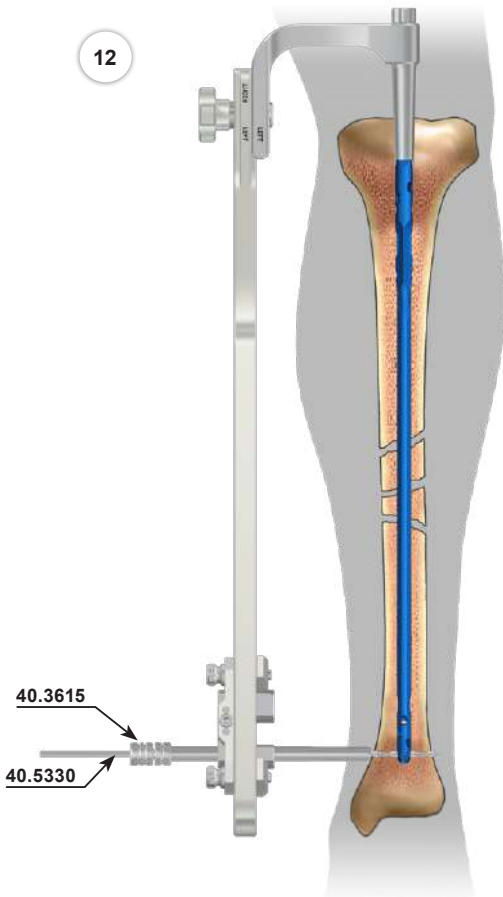

- 12 Insert the Drill Guide 6.5/3.5 [40.3615] (with two grooves) into the Protective Guide left in the slider hole. Mount the Drill With Scale 3.5/270 [40.5330.001] on the surgical drive and advance it through the Drill Guide. Drill the hole in the tibia through both cortex layers and the nail hole. The scale on the Drill shows the length of locking element.



The drilling process should be controlled with image intensifier.

Dismount the Surgical Drive.
Leave the Drill in the reamed hole.

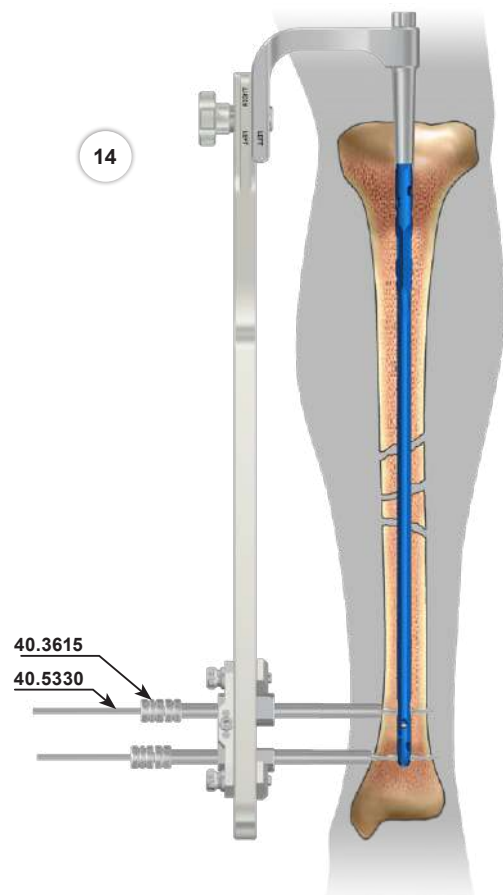

- 13 Insert the Protective Guide 9/6.5 [40.3614] with the Trocar 6.5 [40.3617] into the second (distal) slider hole of the Distal targeter D [40.5322]. Advance the Protective Guide with Trocar until it reaches the cortex bone. Using the Trocar mark the entry point for insertion of locking screw.

Remove the Trocar.
Leave the Protective Guide in the slider hole.

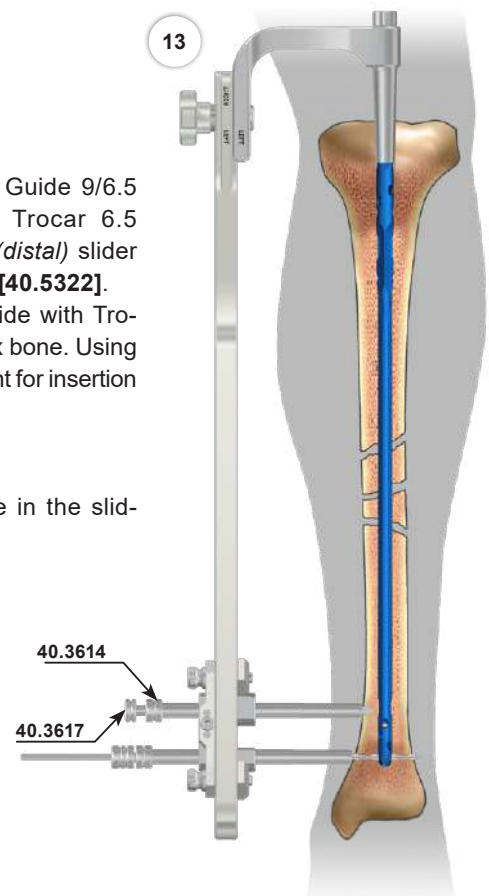

- 14 Insert the Drill Guide 6.5/3.5 [40.3615] into the Protective Guide 9/6.5 [40.3614]. Mount the Drill With Scale 3.5/270 [40.5330.001] on the surgical drive and advance it through the drill guide. Drill the hole in the tibia through both cortex layers and the nail hole. The scale on the drill indicates the length of locking elements.



The drilling process should be controlled with image intensifier.

Remove the Drill and Drill Guide.
Leave the Protective Guide in the slider.

15

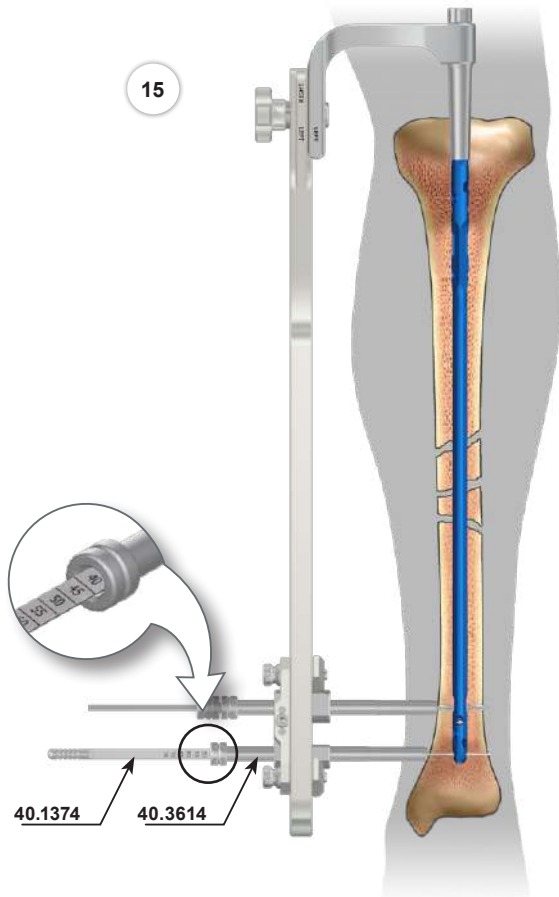

15 Insert the Screw Length Measure [40.1374] through the Protective Guide 9/6.5 [40.3614] into the drilled hole until its hook reaches the „exit” plane of the hole.

Read the length of the locking screw on the B-D scale. The tip of the protective guide should rest on the cortex during the measurement.

Remove the Screw Length Measure.

Leave the Protective Guide in the slider hole.

16

16 Insert the tip of the Hexagonal Screwdriver 3.5 [40.3619] into the socket of the definite locking screw. Advance such system into the Protective Guide 9/6.5 [40.3614] and insert the locking screw into prepared hole until the head of the screw reaches the cortex bone (the groove on the Hexagonal Screwdriver 3.5 shaft matches the edge of protective guide).

Remove the Hexagonal Screwdriver 3.5.

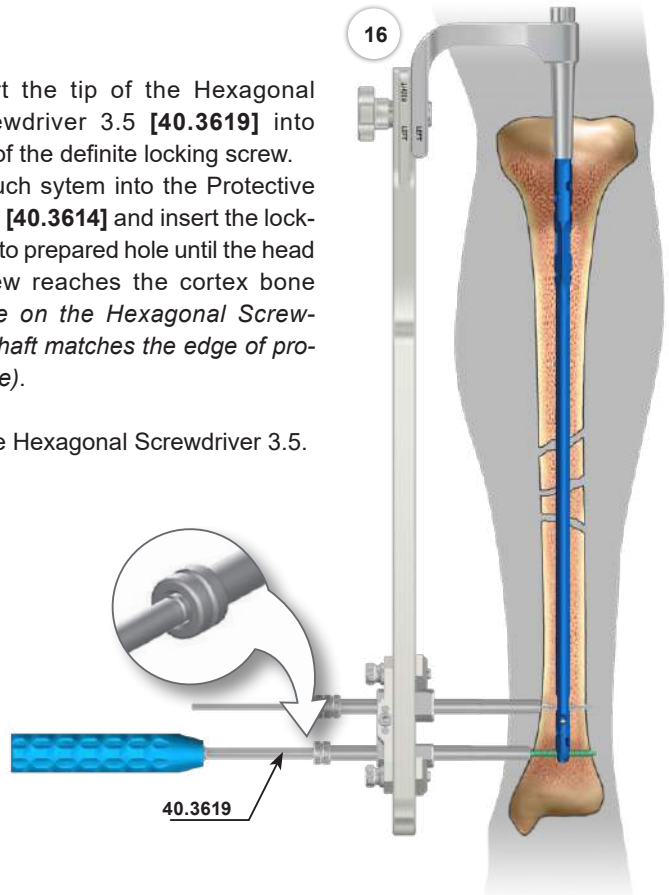

17

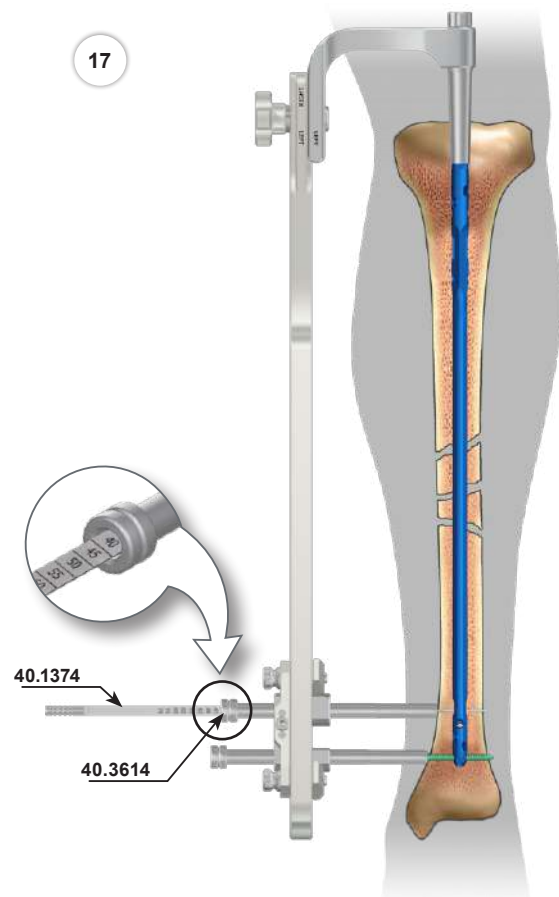

17 Remove the Drill With Scale 3.5/270 [40.5330.001] and the Drill Guide 6.5/3.5 [40.3615] from the second hole of slider. Leave the Protective Guide [40.3614] in the slider hole. Insert the Screw Length Measure [40.1374] through the Protective Guide [40.3614] into the drilled hole until its hook reaches “exit” plane of the hole.

Read the length of locking screw on the B-D scale.

The tip of the Protective Guide should rest on the cortex during the measurement.

Remove the Screw Length Measure.

Leave the Protective Guide in the slider hole.

- 18 Insert the tip of the Hexagonal Screwdriver 3.5 [40.3619] into socket of the definite locking screw. Advanced such system into the Protective Guide [40.3614] and insert the locking screw into prepared hole in the bone until the head of the screw reaches the cortex bone (*the groove on the Hexagonal Screwdriver 3.5 shaft matches the edge of protective guide*).

Remove the Hexagonal Screwdriver 3.5 and the Protective Guide.

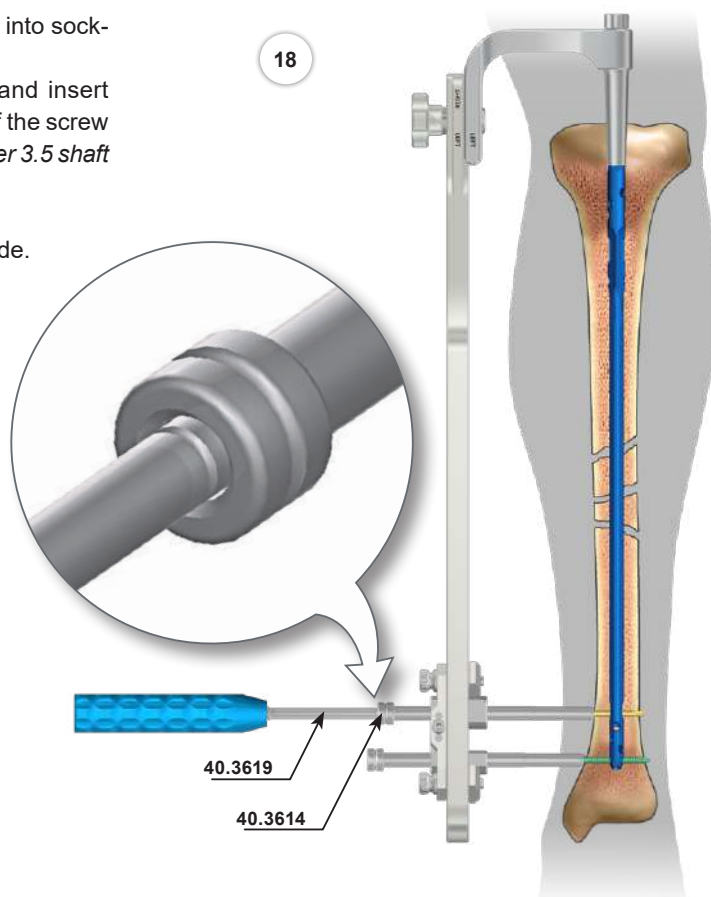

V.5.2. OPTION II: Without X-Ray control

Setting nail holes by adjusting position of targeter D slider

- 19 Mount the Distal targeter D [40.5322] onto the Targeter arm. Insert the Protective Rod into the nail via the Connecting Screw until it reaches the end of the nail. Mount the Guide rod handle [40.1351] onto the Guide Rod next to the head of the Connecting Screw. Then reverse the Guide Rod to the distance of 5-7 cm.

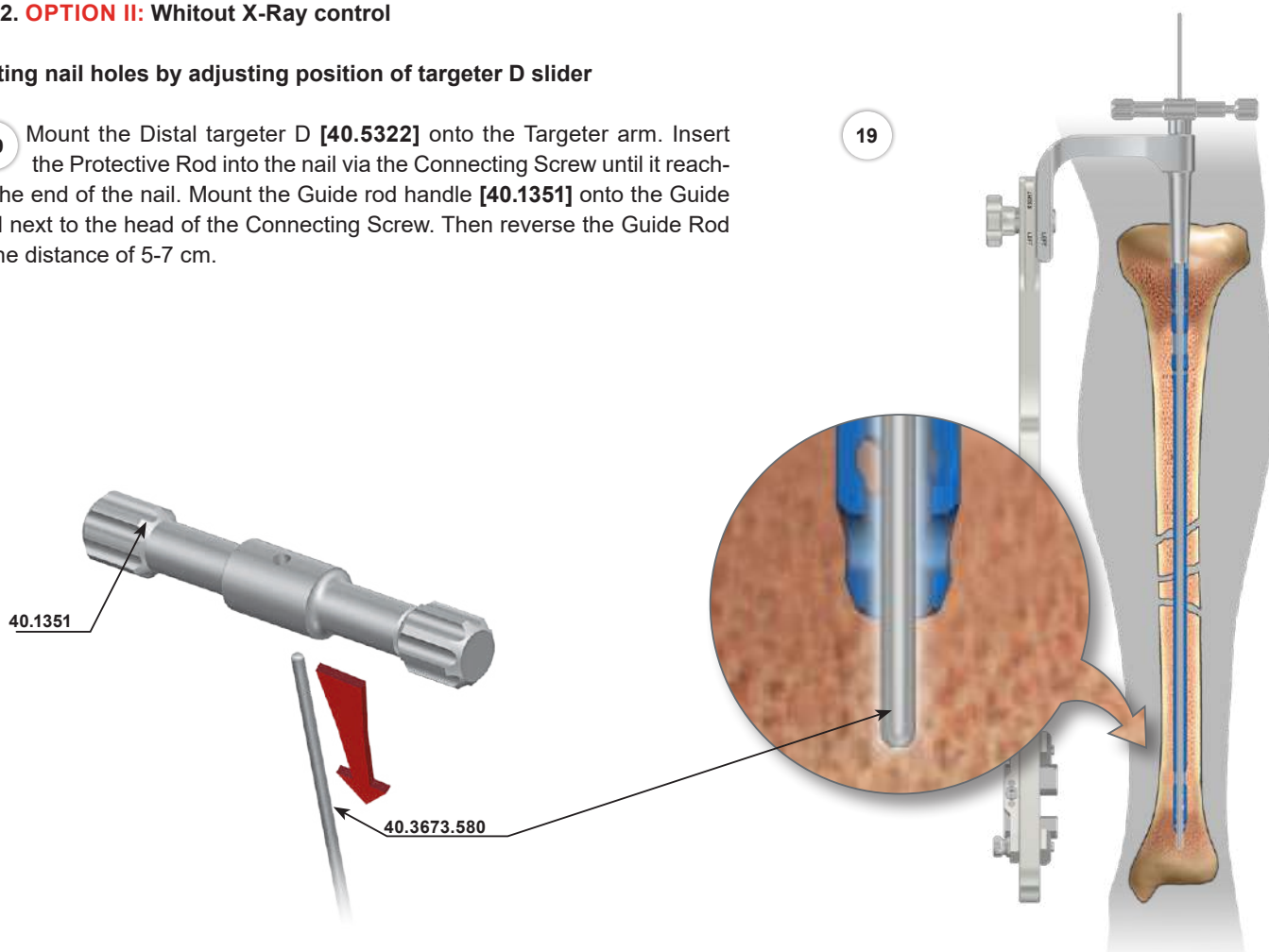



20 Insert the Protective Guide [40.3614] with the Trocar [40.3617] into the slider hole (*preferred distal one*). Mark on the skin the entry point and make the incision through the soft tissues. Advance the Protective Guide with the Trocar until it reaches the cortex bone and mark the entry point for the drill.

Remove the Trocar.

21 Insert the Drill Guide 3.5mm [40.3615] into the Protective Guide left in the slider hole. The end of the Drill Guide should rest on the soft tissues. Mount the Drill With Scale 3.5/270 [40.5330.001] on the surgical drive and advance it through the Drill Guide. Drill the hole in the tibia through first cortex layers and the nail hole.

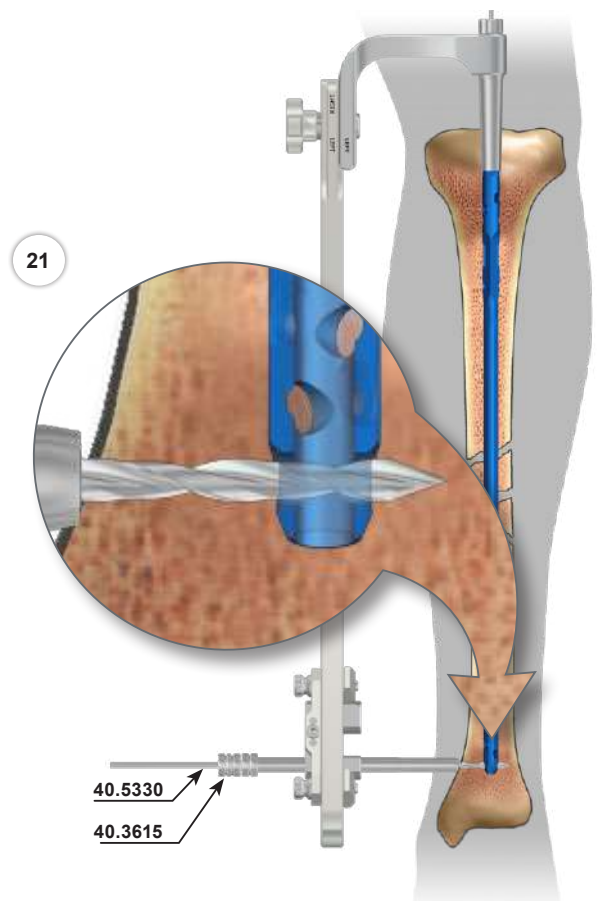

22 Use the Guide Rod [40.3673.580] to verify if the drill properly hit the nail hole. If the drill properly hits the nail hole, the Guide Rod rests on the drill but the Guide rod handle does not reach the Connecting Screw. If the Drill passes through the first cortical layer but does not pass the nail hole:

- withdraw the Drill to enable movements of the slider,
- into the second hole of the Distal targeter D [40.5322] insert the Protective Guide [40.3614] with the Trocar [40.3617] and advance until the Protective Guide rests on the cortex bone. Use the Trocar to mark the entry point for the drill.

Remove the Trocar but leave the Protective Guide in the slider hole.

- Insert the Protective Drill 3.5 [40.3615] into Protective Guide [40.3614] until its tip rests on the soft tissues.
- Mount the Drill Guide 3.5/270 [40.5330.001] on the surgical drive and drill hole through the first cortex layer and the nail hole.

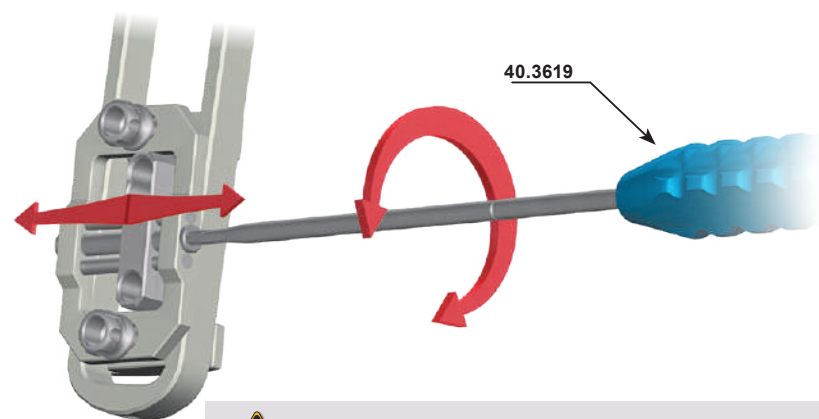

! If one of the holes (distal or proximal) is localized, locating another hole is not necessary.

If the drill passes the nail hole, the second cortex layer should be drilled through. After dismantling the surgical drive, leave the drill in the hole. The scale on the drill shows the length of the locking elements.

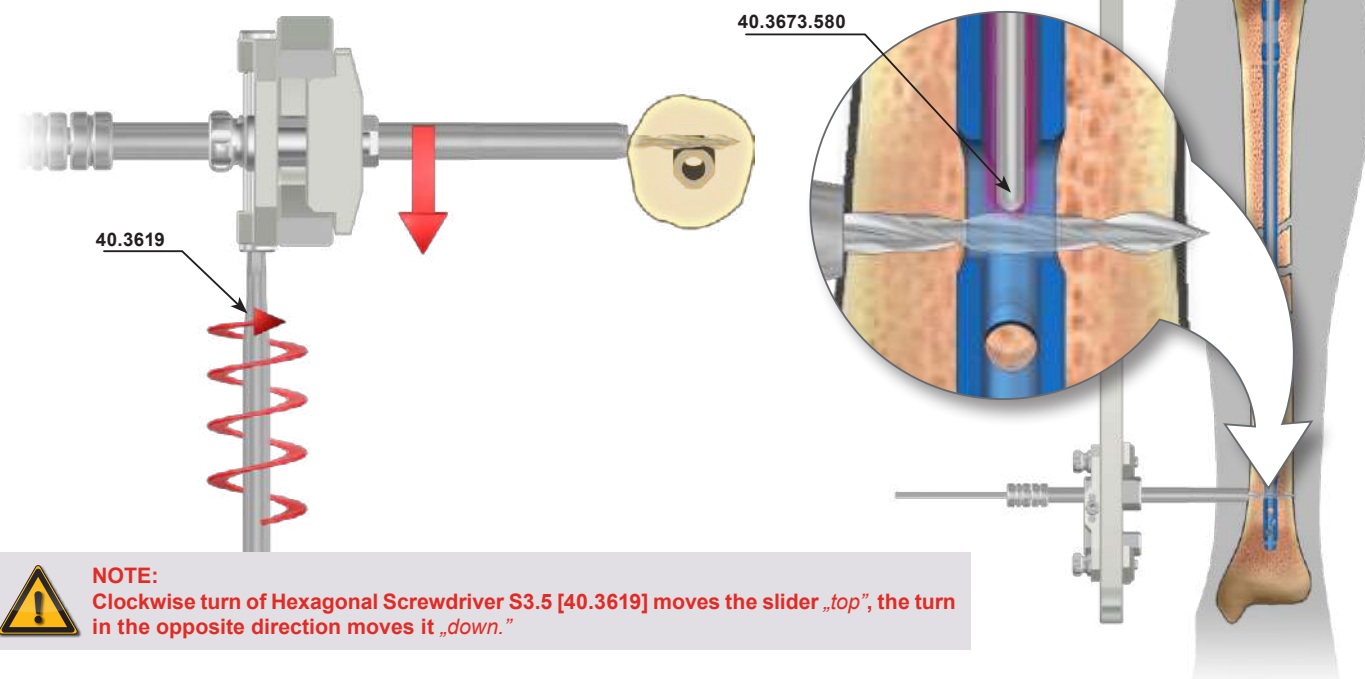

! NOTE: Clockwise turn of Hexagonal Screwdriver S3.5 [40.3619] moves the slider „top”, the turn in the opposite direction moves it „down.”

- 24 Insert the Protective Guide [40.3614] with the Trocar [40.3617] into the second (distal) slider hole of the Distal targeter D [40.5322]. Advance the Protective Guide with the Trocar until it rests on the cortex bone. Use the Trocar to mark the entry point to insert the Drill.

Remove the Trocar.
Leave the Protective Guide in the slider hole.

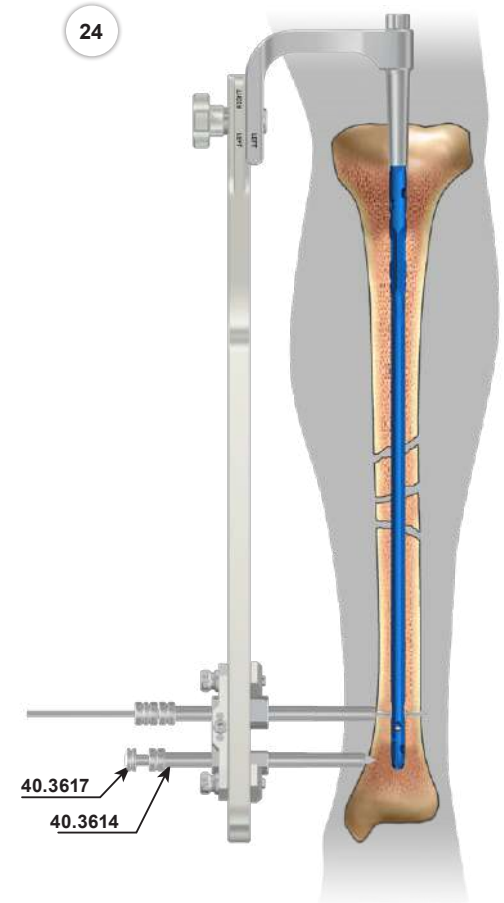

- 25 Insert the Drill Guide 3.5 [40.3615] into the Protective Guide [40.3614]. Mount the Drill With Scale 3.5/270 [40.5330.001] on the surgical drive and advance it through the Drill Guide. Drill the hole in tibia through first cortex layer and the nail hole.

Verify if the drill is located in the hole using the rod. The tip of the Guide Rod should rest on the drill.

If the drill passes through the nail hole, drill it through the second cortex layer. The scale on the drill indicates the length of the locking elements.

Remove the Drill and the Drill Guide.
Leave the Protective Guide in the slider hole.

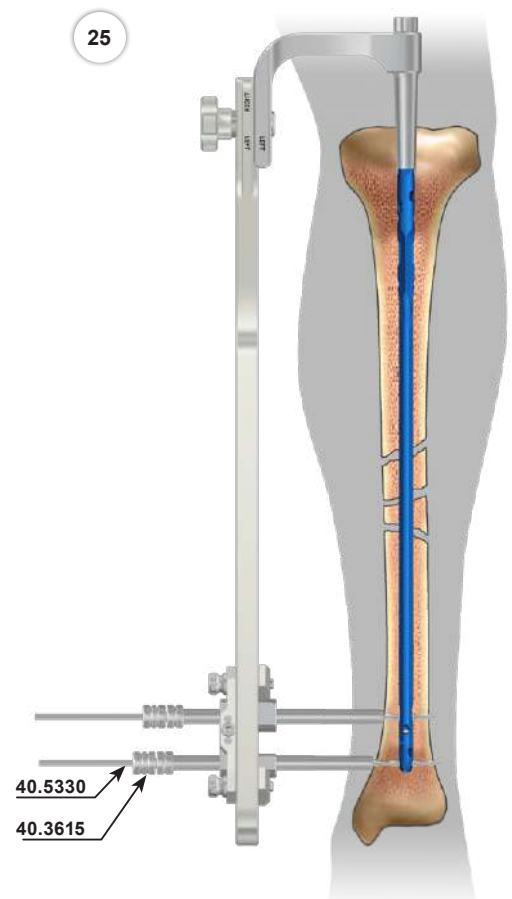

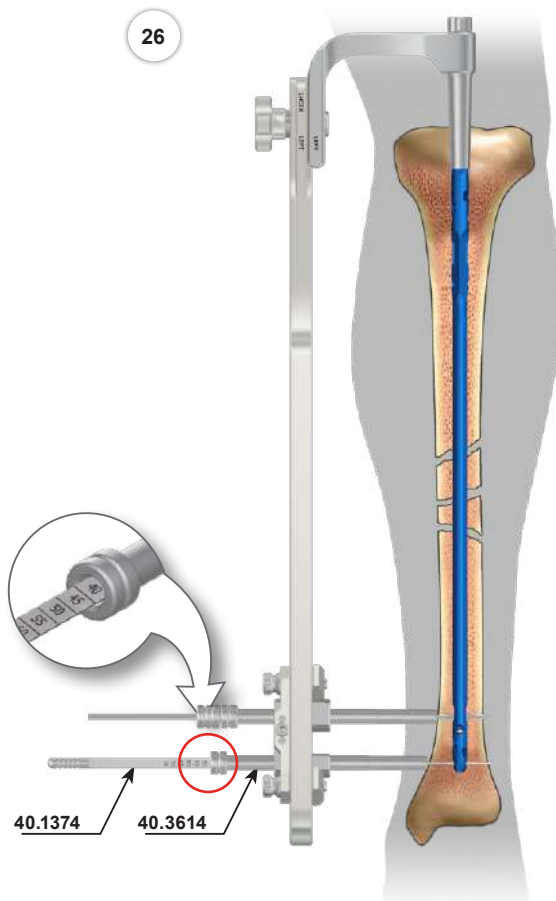

26 Insert the Screw Length Measure [40.1374] through the Protective Guide [40.3614] into the drilled hole until its hook reaches the „exit” plane of the hole. Read the length of the locking screw on the B-D scale.

The tip of the Protective Guide should rest on the cortex during the measurement.

Remove the Screw Length Measure. Leave the Protective Guide in the slider hole.

27 Insert the tip of the Hexagonal Screwdriver 3.5 [40.3619] into socket of the definite locking screw. Then advance such combined system into the Protective Guide [40.3614] and insert the locking screw into prepared hole in the bone until the head of the screw reaches the cortex bone (*the groove on the hexagonal screwdriver 3.5 matches the edge of protective guide*).

Remove the Hexagonal Screwdriver 3.5 and the Protective Guide.



27

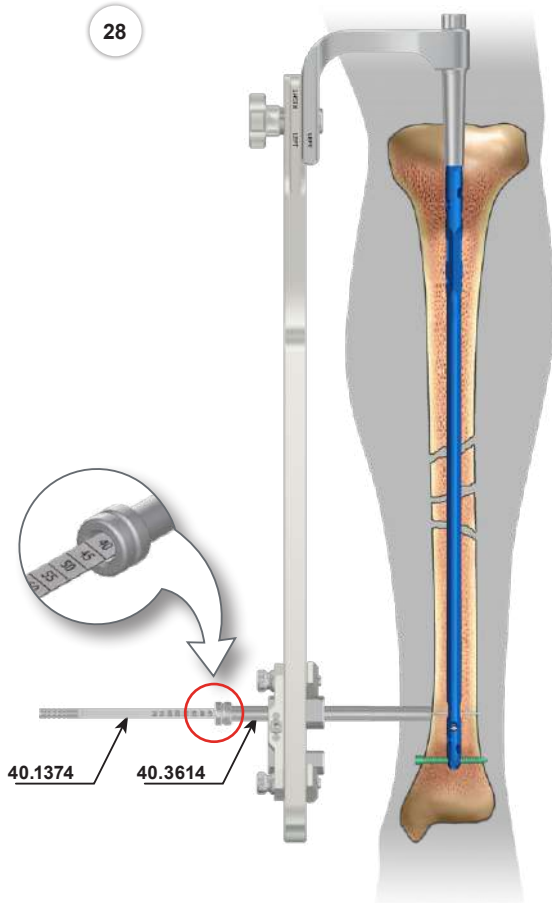

28 Remove the Drill With Scale 3.5/270 [40.5330.001] and the Drill Guide 6.5/3.5 [40.3615] from the slider hole but leave the Protective Guide 9/6.5 [40.3614]. Insert the Screw Length Measure [40.1374] through the Protective Guide 9/6.5 [40.3614] into the drilled hole until its hook reaches the „exit” plane of the hole. Read the length of locking screw on the B-D scale.

The tip of the Protective Guide should rest on the cortex during the measurement.

Remove the Screw Length Measure.
Leave the Protective Guide in the slider hole.

29 Insert the tip of the Hexagonal Screwdriver 3.5 [40.3619] into the socket of definite locking screw. Then advance such combined system into the Protective Guide 9/6.5 [40.3614] and insert the locking screw into prepared hole in the bone until the head of the screw reaches the cortex bone (*the groove on the Hexagonal Screwdriver 3.5 matches the edge of Protective Guide*).

Remove the Hexagonal Screwdriver 3.5 and the Protective Guide.

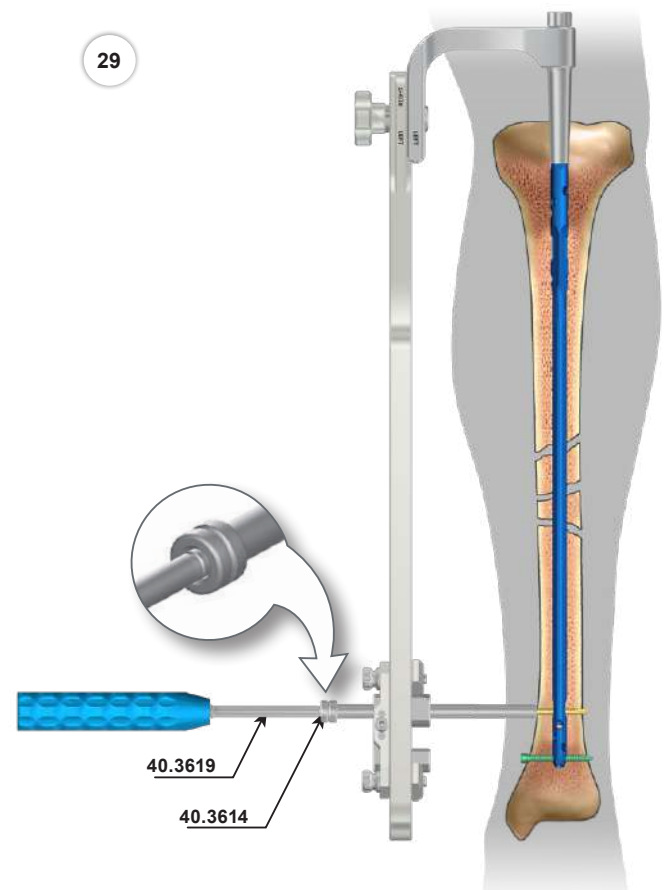

29

V.5.3. Insertion of instruments into slider holes of Distal targeter

Insertion of the devices into the slider hole of the Distal targeter is possible and depends on the chosen method.

I. static method:

The instruments [40.5000.600] should be inserted into the distal slider hole and in proximal part of the double hole.

II. dynamic and compressive method:

The instruments [40.5000.600] should be inserted into the distal slider hole and in distal part of the double hole.

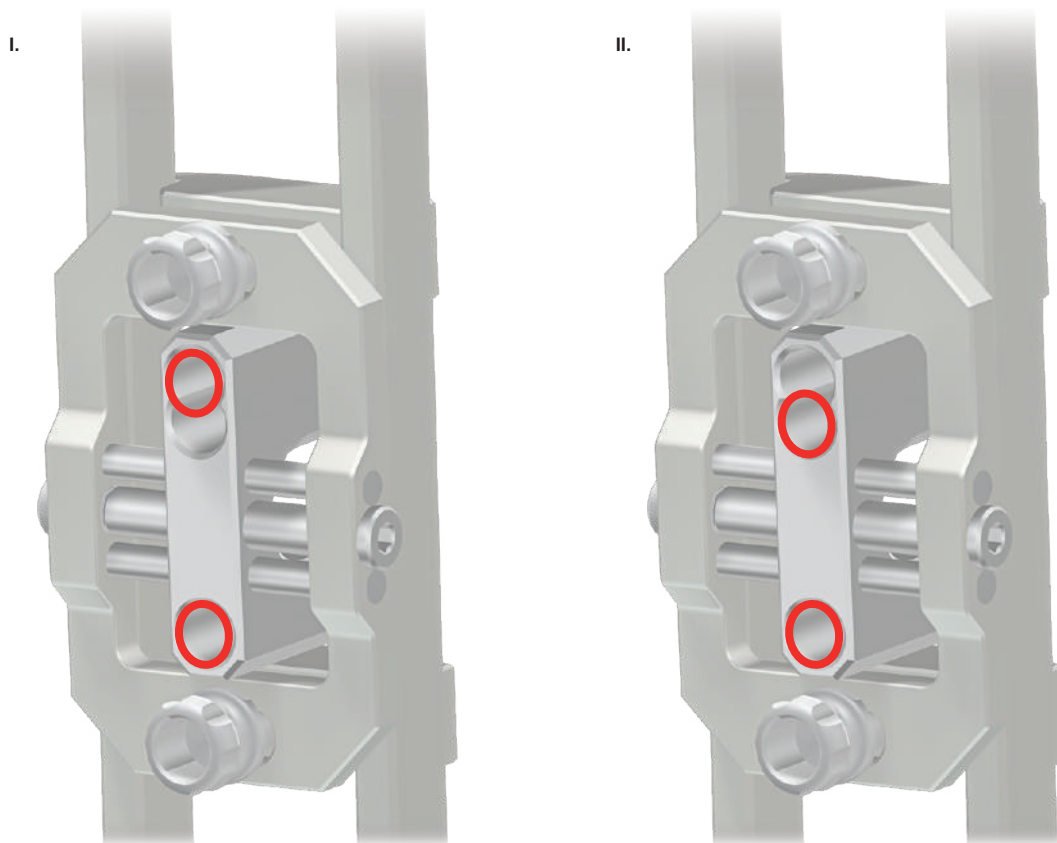

V.6. PROXIMAL NAIL LOCKING

V.6.1. Dynamic method and dynamic method with compression



IMPORTANT!

There are four holes in proximal part of the targeter for locking the nail. The central hole of the targeter, marked **COMPRESSION**, should be used in dynamic or compression method for locking the nail in proximal part (correspondingly oval shaped hole in the intramedullary nail).

30 Insert the Protective Guide [40.3614] with the Trocar 6.5 [40.3617] into the hole (marked: „compression”). Mark on the skin the entry point for locking screw and make adequate approx. 1.5 cm long incision through soft tissues. Insert the Protective Guide with the Trocar until it reaches the cortex bone. Mark the point for drill insertion using the Trocar.

Remove the Trocar.
Leave the Protective Guide in the hole of the targeter.

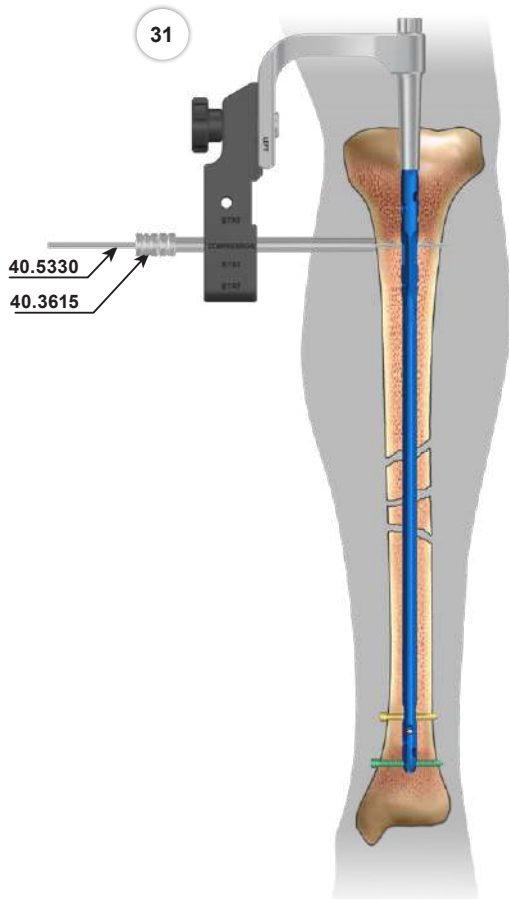

31 Insert the Drill Guide 6.5/3.5 [40.3615] into the Protective Guide 9/6.5 [40.3614]

Mount the Drill With the Scale 3.5/270 [40.5330.001] on the surgical drive and advance it through the Drill Guide. Drill the hole in the tibia through both cortex layers. Scale on the drill indicates the length of the locking elements.



The process should be controlled with image intensifier.

Remove the Drill and the Drill Guide.
Leave the Protective Guide in the slider hole.

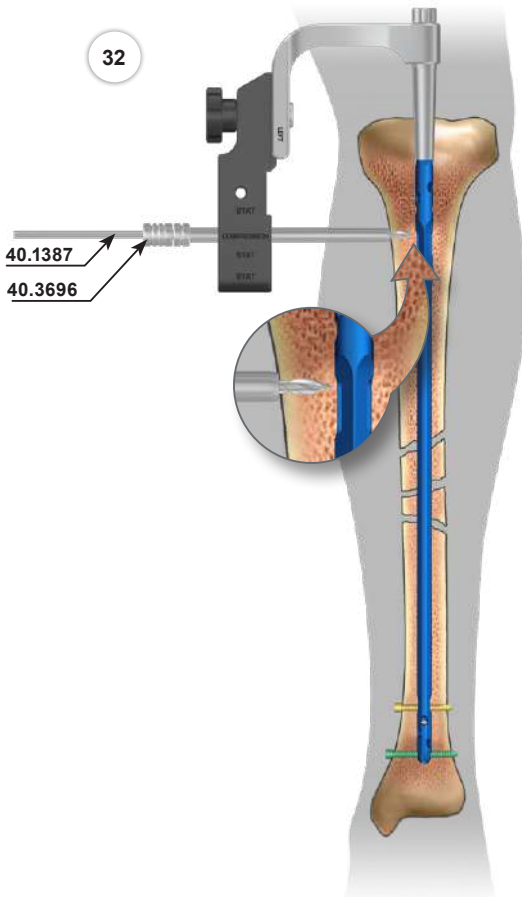

- 32 Insert the Drill Guide 6.5/4.5 [40.3696] into the Protective Guide 9/6.5 [40.3614]. Insert the Drill 4.5/270 [40.1387.001] into the Drill Guide and widen the hole in first cortex layer.



The widening process should be controlled with image intensifier.

Remove the Drill and the Drill Guide.
Leave the Protective Guide in the targeter hole.

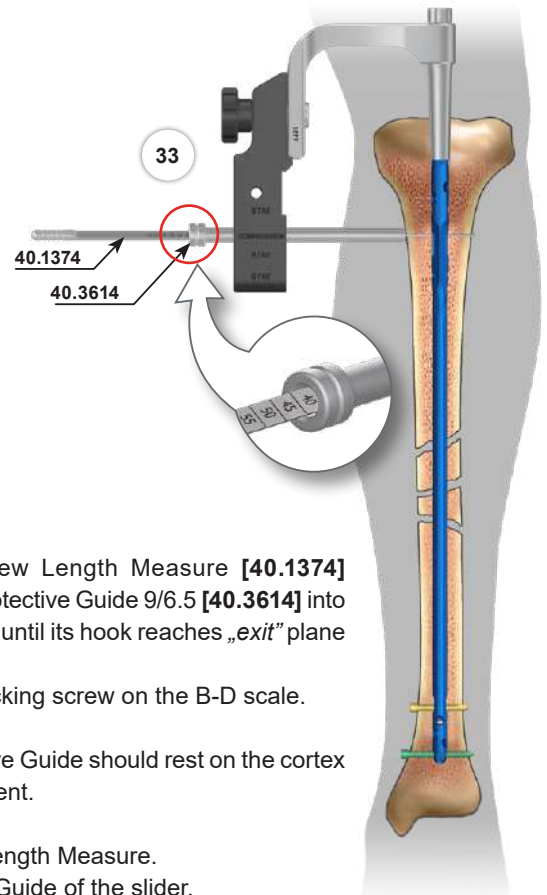

- 33 Insert the Screw Length Measure [40.1374] through the Protective Guide 9/6.5 [40.3614] into the drilled hole until its hook reaches „exit“ plane of the hole.

Read the length of locking screw on the B-D scale.

The tip of the Protective Guide should rest on the cortex during the measurement.

Remove the Screw Length Measure.
Leave the Protective Guide of the slider.

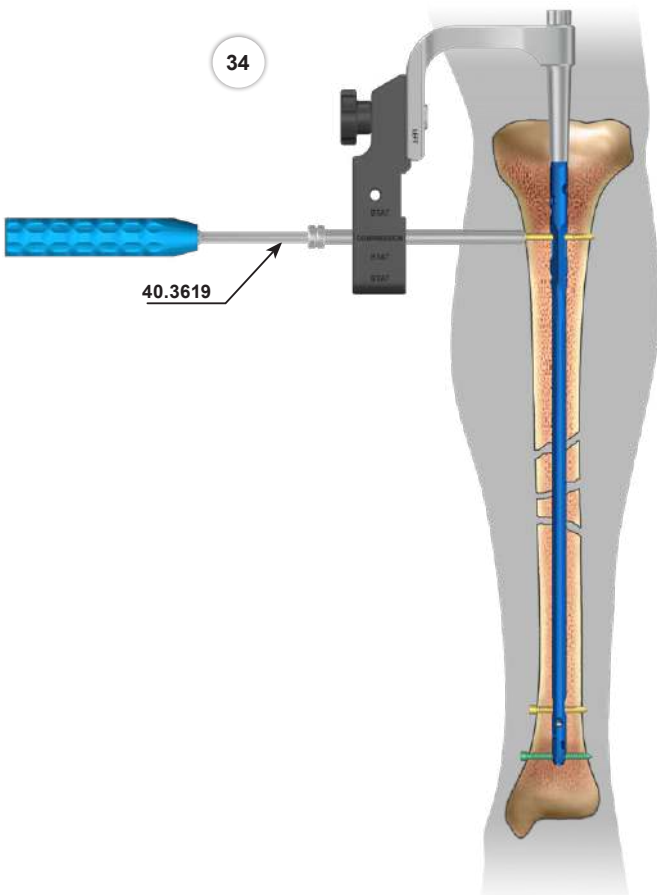

IMPORTANT!
Use the proximal screw to lock the nail.

- 34 Insert the tip of the Hexagonal Screwdriver 3.5 [40.3619] into the socket of the defined proximal screw.

Advance such combined system into the Protective Guide 9/6.5 [40.3614] and insert the locking screw into prepared hole in the bone until the head of the screw reaches the cortex bone (*the groove on the Hexagonal Screwdriver 3.5 matches the edge of the Protective Guide*).

Remove the Hexagonal Screwdriver 3.5 and the Protective Guide.

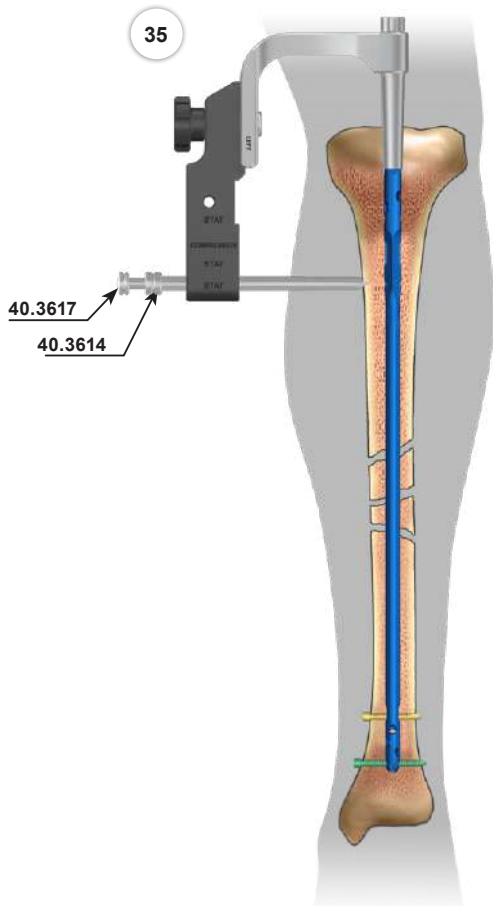

V.6.2. Static method

It is recommended to lock a nail in proximal part using two screws. One of round holes should be used in every case of nail locking.

- 35** Insert the Protective Guide 9/6.5 [40.3614] with the Trocar 6.5 [40.3617] into the hole of the Targeter B [40.5373]. Mark on the skin the entry point for the locking screw and make adequate 1.5 cm long incision through the soft tissues. Insert the Protective Guide with the Trocar until it reaches the cortex bone. Mark the entry point for drill insertion using the Trocar.

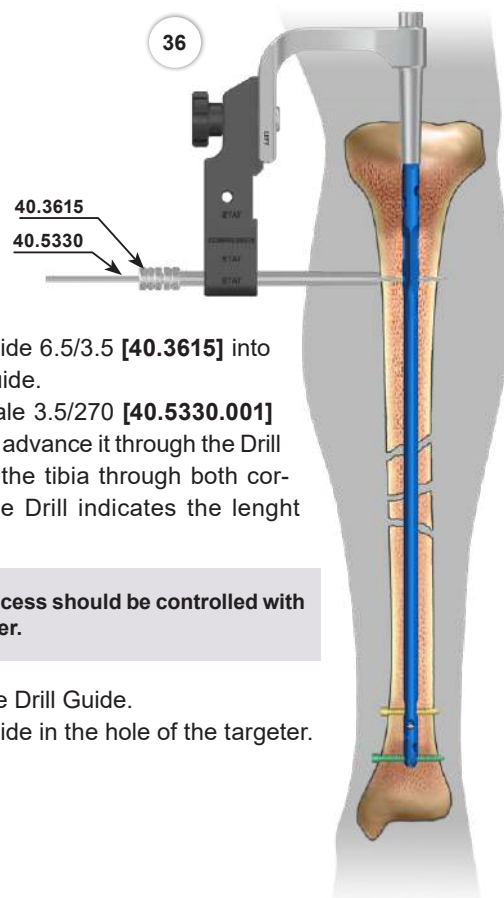

- 36** Insert the Drill Guide 6.5/3.5 [40.3615] into the Protective Guide. Mount the Drill With Scale 3.5/270 [40.5330.001] on the surgical drive and advance it through the Drill Guide. Drill the hole in the tibia through both cortex layers. Scale on the Drill indicates the length of the locking elements.



The drilling process should be controlled with image intensifier.

Remove the Drill and the Drill Guide. Leave the Protective Guide in the hole of the targeter.

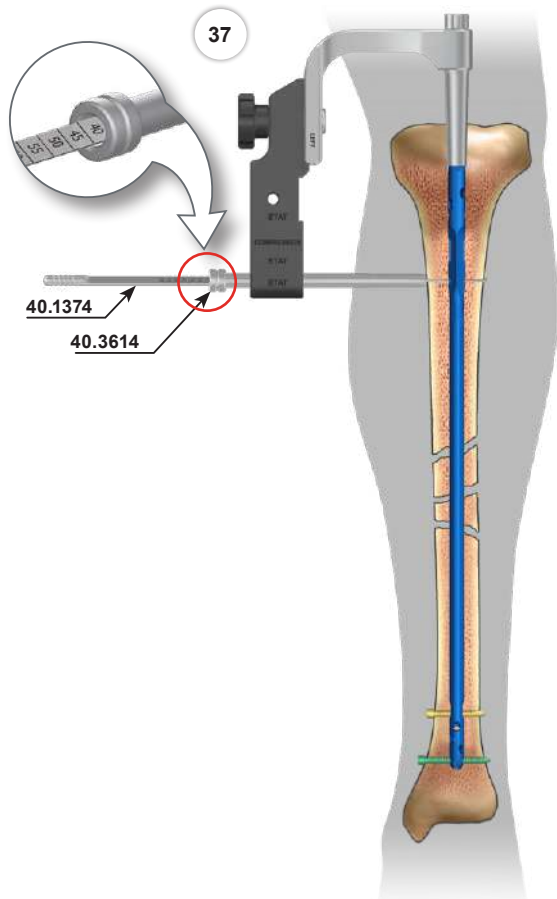

- 37** Insert the Screw Length Measure [40.1374] through the Protective Guide 9/6.5 [40.3614] into the drilled hole until its hook reaches „exit” plane of the hole. Read the length of the locking screw on the B-D scale.

The tip of the Protective Guide should rest on the cortex during the measurement.

Remove the Screw Length Measure. Leave the Protective Guide in the hole of the targeter.

38 Insert the tip of the Hexagonal Screwdriver 3.5 [40.3619] into the head of the definite locking screw and then advance such system into the Protective Guide 9/6.5 [40.3614] and insert the locking screw into prepared hole in the bone until the head of the screw reaches the cortex bone (*the groove on the Hexagonal Screwdriver 3.5 matches the edge of the Protective Guide*). Remove the Hexagonal Screwdriver 3.5 and the Protective Guide.

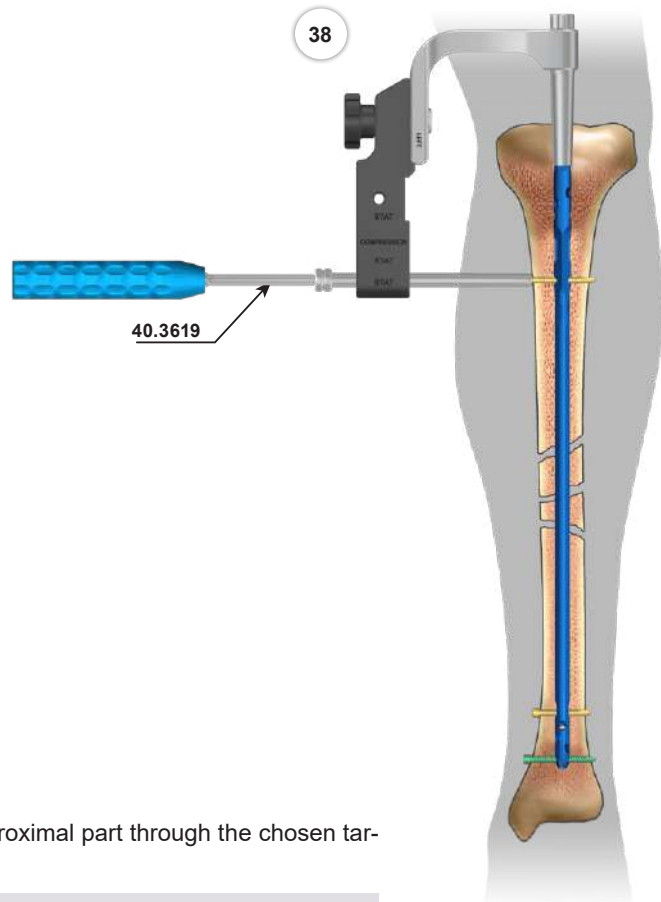

39 Use the second locking screw to lock the nail in the proximal part through the chosen target hole.

i To lock the nail follow the steps from 35 to 38.

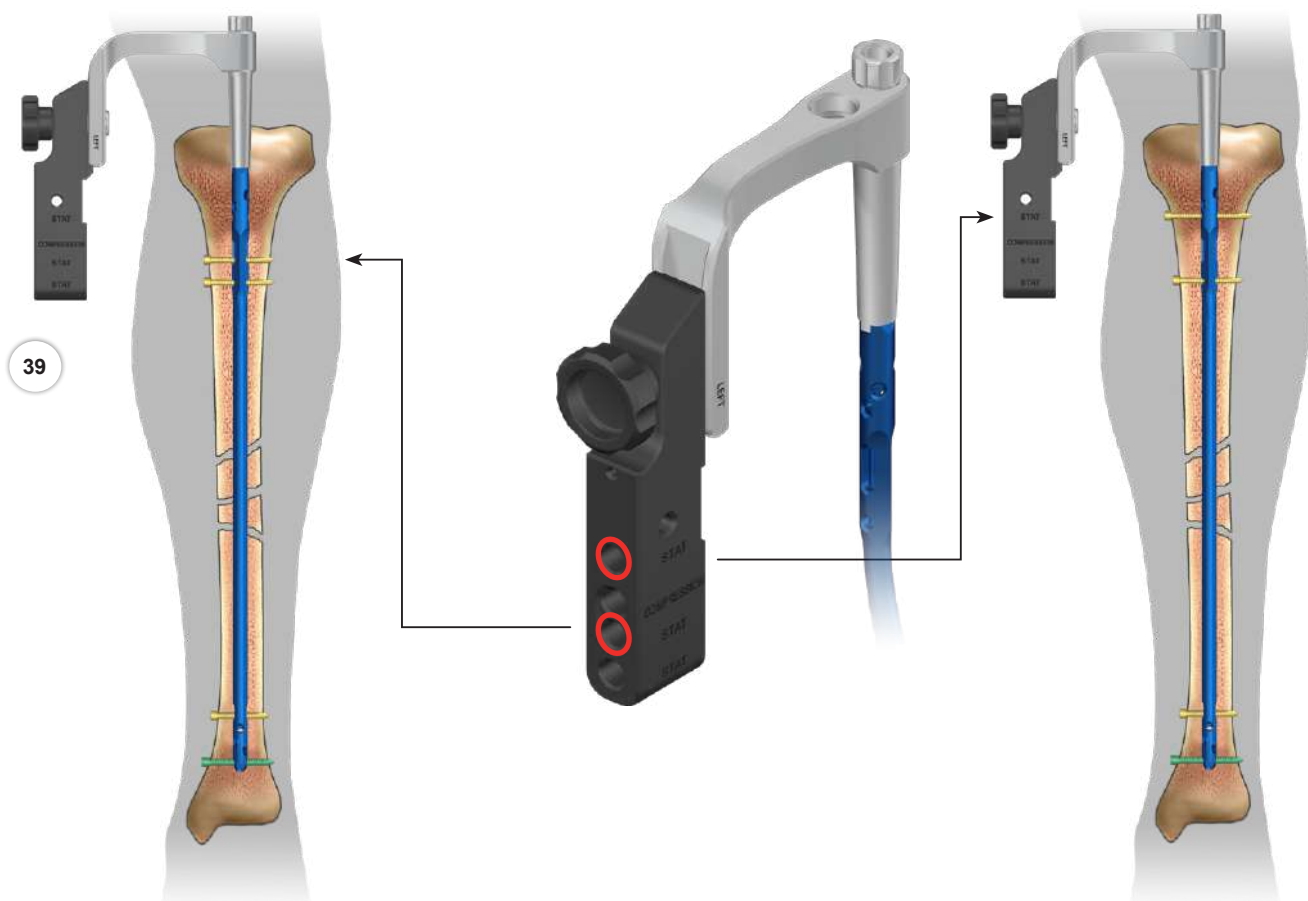

VI. SURGICAL TECHNIQUE - RECONSTRUCTIVE METHOD

VI.1. PROXIMAL LOCKING OF THE RECONSTRUCTION INTRAMEDULLARY NAIL

40 Reconstruction nail has 5 holes in proximal part. Decision about insertion site and number of used screws is to be made by surgeon and depends on the type of fracture. It is not necessary to lock reconstruction tibial nail in the reconstruction holes. In such case, lock the nail as in the compression method. It is important to pay attention to lack of compression possibilities in the case of using the reconstruction holes. In the case of locking the reconstruction tibial nail in the proximal part follow steps [30]-[39].

41 Mount the Reconstruction targeter [40.5377] on the Target B [40.5373] to lock the nail using reconstruction holes. Insert threaded arbor of the Reconstruction targeter into lateral hole of the Targeter arm B [40.5301] and connect both elements using the nut.

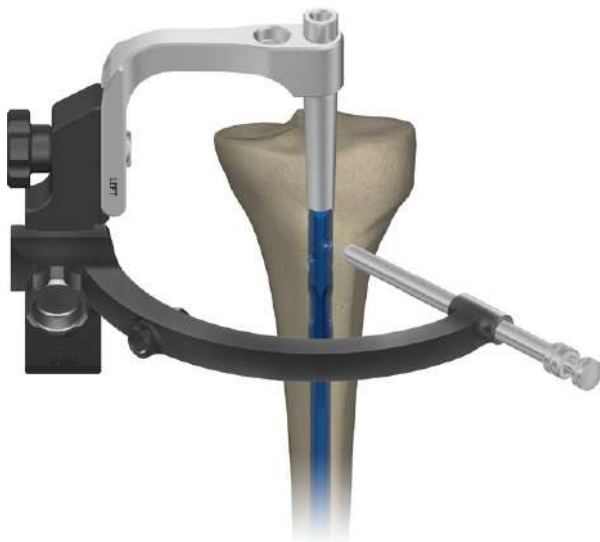

42 Insert the Protective Guide 9/6.5 [40.3614] with the Trocar 6.5 [40.3617] into the hole of the Reconstruction targeter. Mark on the skin the entry point for locking screw and make 1.5 cm long incision of the soft tissues. Advance the Protective Guide together with the Trocar until it reaches the cortex bone. Use the Trocar to mark the entry point for the drill .

Remove the Trocar.
Leave the Protective Guide in the hole of the targeter.

43 Insert the Drill Guide 6.5/3.5 [40.3615] into the Protective Guide 9/6.5 [40.3614] left in the hole of the targeter. Mount the Drill With Scale 3.5/270 [40.5330.001] on the surgical drive and advance it through the Drill Guide. Drill the hole in the tibia to the appropriate depth. The scale on the Drill indicates the locking elements.

Leave the Protective Guide together with Drill and Drill Guide in the hole of the targeter.



44

44 Insert the Protective Guide 9/6.5 [40.3614] with the Trocar 6.5 [40.3617] into second reconstruction hole of the targeter. Mark on skin entry point for the locking screw and 1.5 cm long incision of the soft tissues across the point. Advance the Protective Guide together with Trocar until it reaches the cortex bone. Use the Trocar to mark the entry point for the drill .

Remove the Trocar.
Leave the Protective Guide in the hole of the targeter.

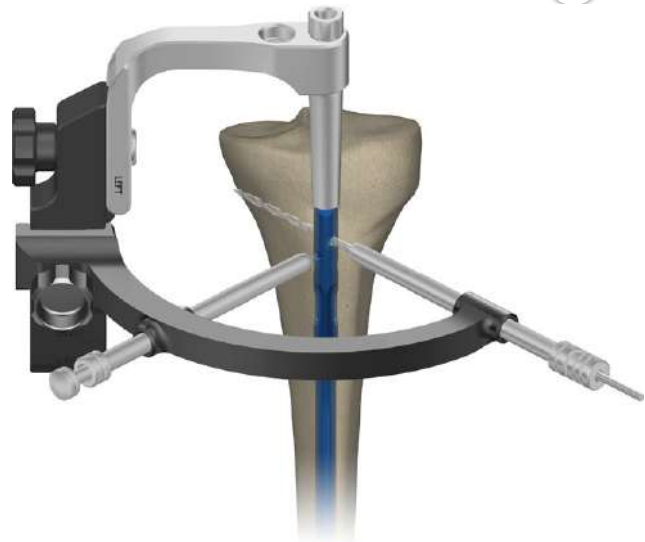

45

45 Insert the Drill Guide 6.5/3.5 [40.3615] into the Protective Guide 9/6.5 [40.3614] left in the hole of the targeter. Mount the Drill With Scale 3.5/270 [40.5330.001] on the surgical drive and advance it through the Drill Guide. Drill the hole in the tibia to the appropriate depth. The scale on the drill indicates the locking elements

Leave the Protective Guide together with Drill and Drill Guide in the hole of the targeter.

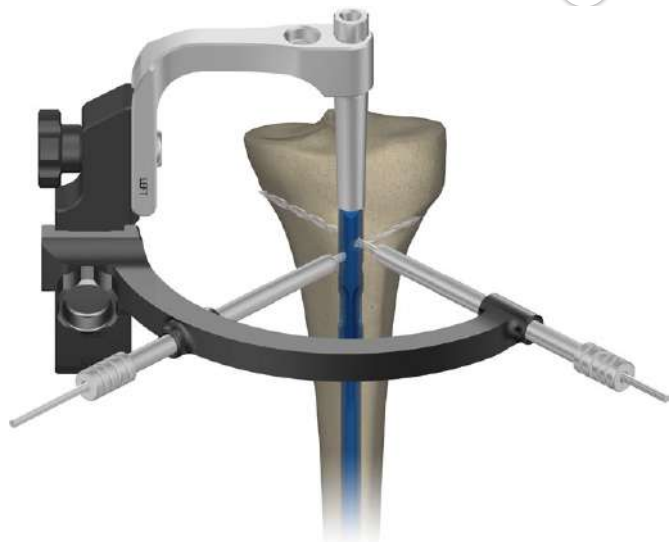

46

46 Remove the Drill With Scale 3.5/270 [40.5330.001] and the Drill Guide 6.5/3.5 [40.3615] from one of the targeter holes. Leave the Protective Guide 9/6.5 mm [40.3614] in the targeter hole.

Insert the Screw Length Measure [40.1374] through the Protective Guide into the drilled hole until its tip reaches the end of hole. Read the length of the locking screw on the B-D scale. During the measurement the end of the Protective Guide should rest on the cortex.

Remove the Screw Length Measure.
Leave the Protective Guide in the hole of the targeter.

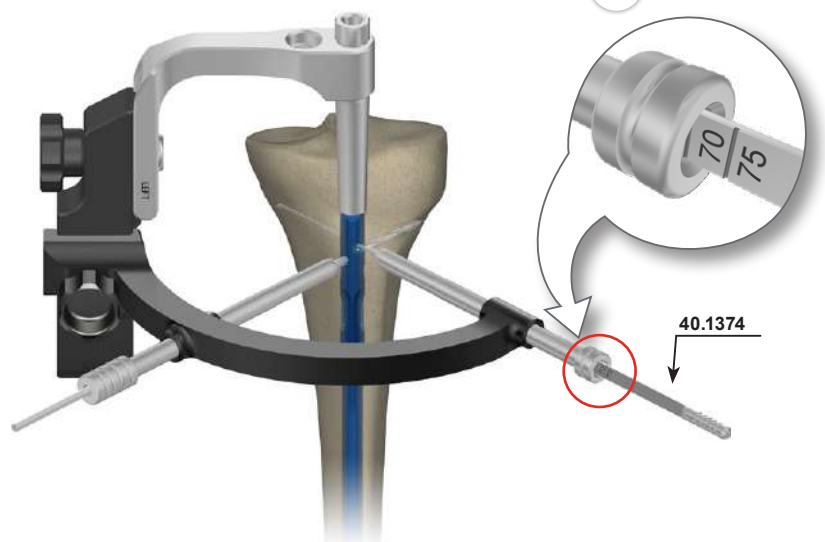

47

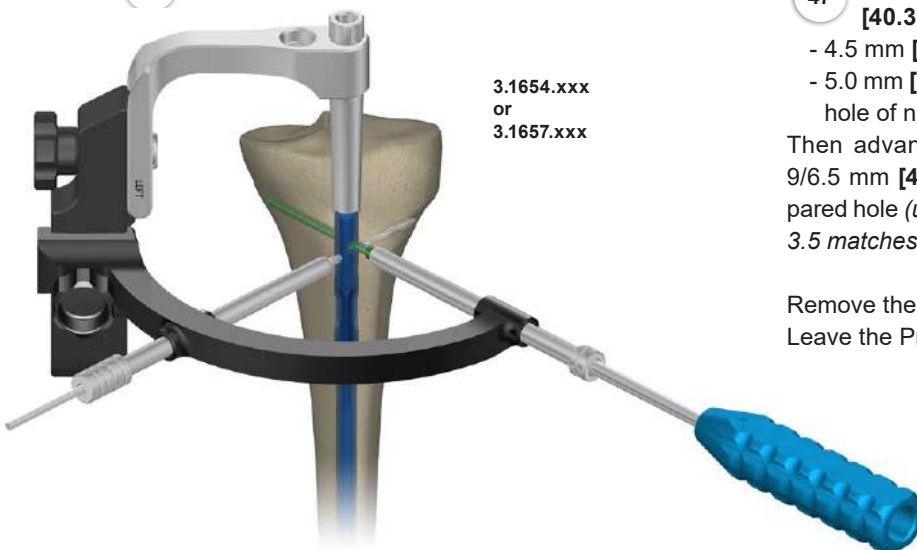

47

Insert the tip of the Hexagonal Screwdriver 3.5 [40.3619] into the socket of the locking screw:
 - 4.5 mm [3.1654.xxx] in the case of standard locking,
 - 5.0 mm [3.1657.xxx] in the case of locking in threaded hole of nail.

Then advance such system into the Protective Guide 9/6.5 mm [40.3614]. Insert the locking screw in the prepared hole (until the groove on the Hexagonal Screwdriver 3.5 matches the edge of the Protective Guide).

Remove the Hexagonal Screwdriver 3.5.
 Leave the Protective Guide.

48

Remove the Drill With Scale 3.5/270 [40.5330.001] and the Drill Guide 6.5/3.5 [40.3615] from the second hole of the reconstruction targeter. Leave the Protective Guide 9/6.5 mm [40.3614] in the targeter hole. Insert the Screw Length Measure [40.1374] through the Protective Guide into the drilled hole until its tip reaches the end of hole. Read the length of the locking screw on the B-D scale. During the measurement the end of the Protective Guide should rest on the cortex.

Remove the Screw Length Measure.
 Leave the Protective Guide in the hole of the targeter.

48

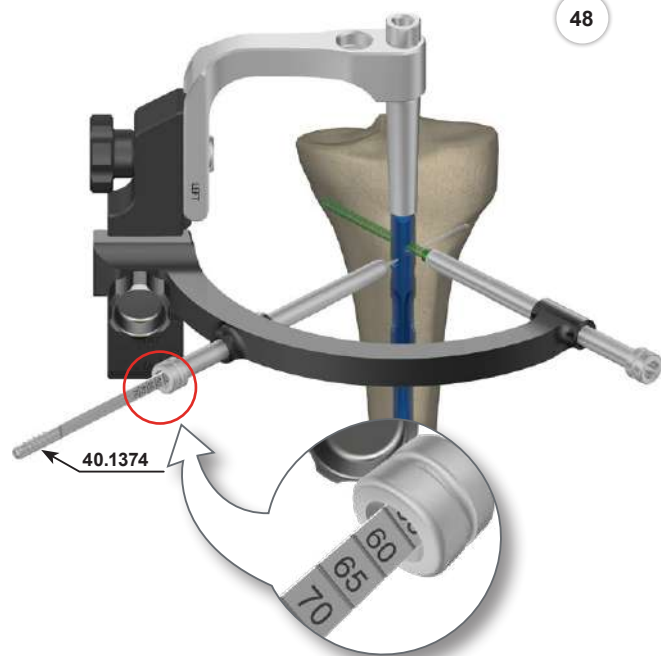

49

Insert the tip of the Hexagonal Screwdriver 3.5 [40.3619] into the socket of the locking screw:
 - 4.5 mm [1.1653.xxx] in the case of standard locking,
 - 5.0 mm [3.1657.xxx] in the case of locking in threaded hole of nail.

Then advance such system into the Protective Guide 9/6.5 mm [40.3614]. Insert the locking screw in the prepared hole (until the groove on the Hexagonal Screwdriver 3.5 matches the edge of protective guide).

Remove the Hexagonal Screwdriver 3.5 and the Protective Guide.

49

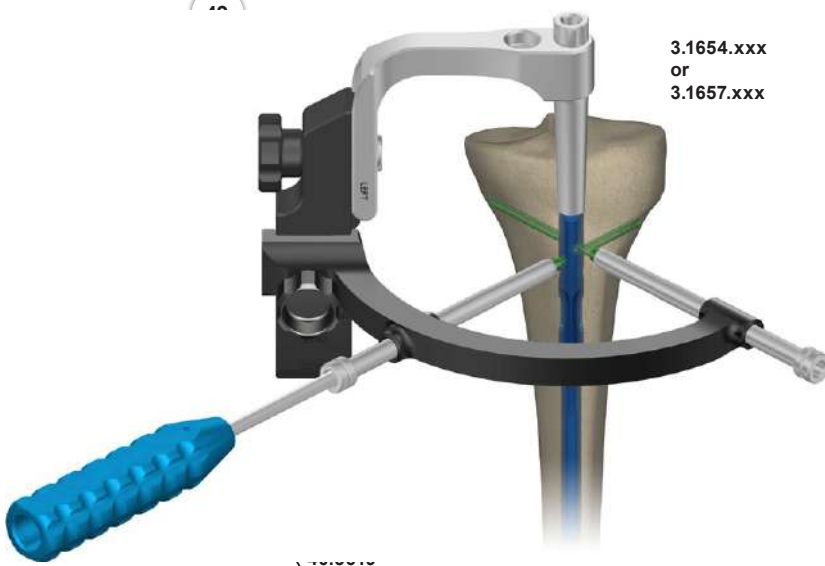

VI.2. INSERTING COMPRESSION SCREW OR END CUP

- 50 Unscrew the Connecting screw M8x1.25 L-91 [40.5325] using the Socket Wrench S 8 [40.5304].
Dismount the the Targeter arm [40.5301] from the nail.

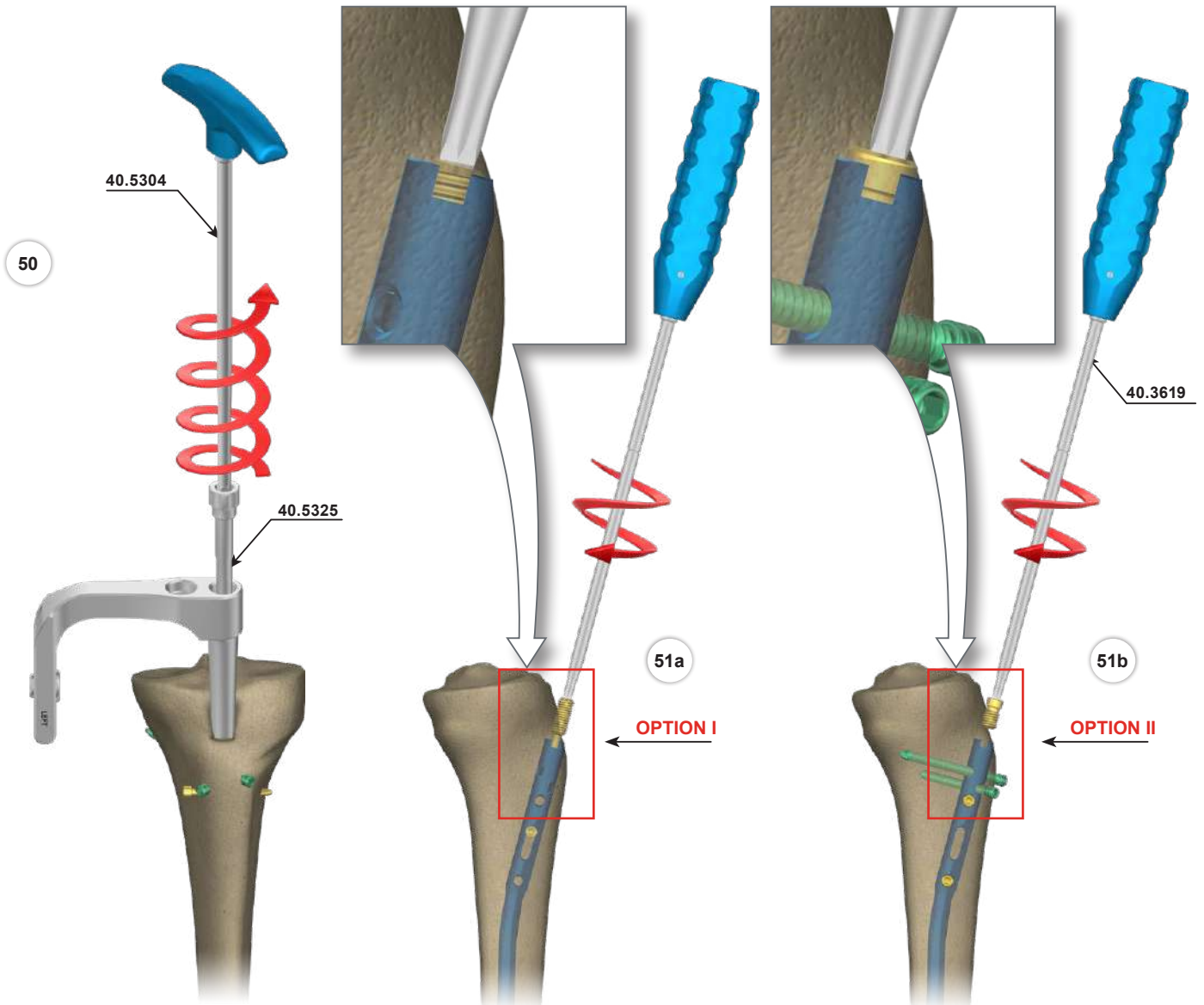

- 51 Insertion of Compression Screw or End Cap.

OPTION I: Inserting the Compression Screw refers to dynamic method with compression.

Use the Screwdriver [40.3619] to insert the Compression Screw (*implant*) into the threaded hole of the nail.

OPTION II: Inserting the End Cap refers to dynamic and static methods.

To secure the inner thread of the nail form bone ingrowth, insert the End Cap (*implant*) using the Screwdriver [40.3619].

VII. LOCKING OF INTRAMEDULLARY NAIL USING TARGETER D [40.1344] AND TARGETER ARM B [40.5301]

VII.1. DISTAL LOCKING OF THE NAIL USING TARGETER D [40.1344] – „FREEHAND TECHNIQUE”

In this technique an image intensifier is used to verify the entry points for the Drill and to control the drilling processes. It is recommended to use angular attachment with the surgical drive while drilling the holes, so that surgeon's hands are not directly exposed to X-rays. After marking the entry points on the skin, make incisions through the soft tissues, each about 1.5 cm in length.

- 52 Use the image intensifier to establish the place of the Targeter D [40.1344] in line with the nail hole.
The centers of the holes in the targeter and the nail have to match. The teeth of the targeter have to be merged in the cortex. Insert the Short Trocar [40.1354] into the Targeter D hole, advance it until it reaches cortex and mark the entry point for the drill.

Remove the Trocar.
Leave the Targeter D in place.

- 53 Insert the Drill Guide Short 7/3.5 [40.1358] into the hole in Targeter D [40.1344]. Mount the Drill 3.5/150 mm [40.5341.001] or Drill 3.5/250 3.5/270 [40.5330.001] on the surgical drive and advance such system through the Drill Guide. Drill the hole through both cortex layers.



The drilling process should be controlled with image intensifier.

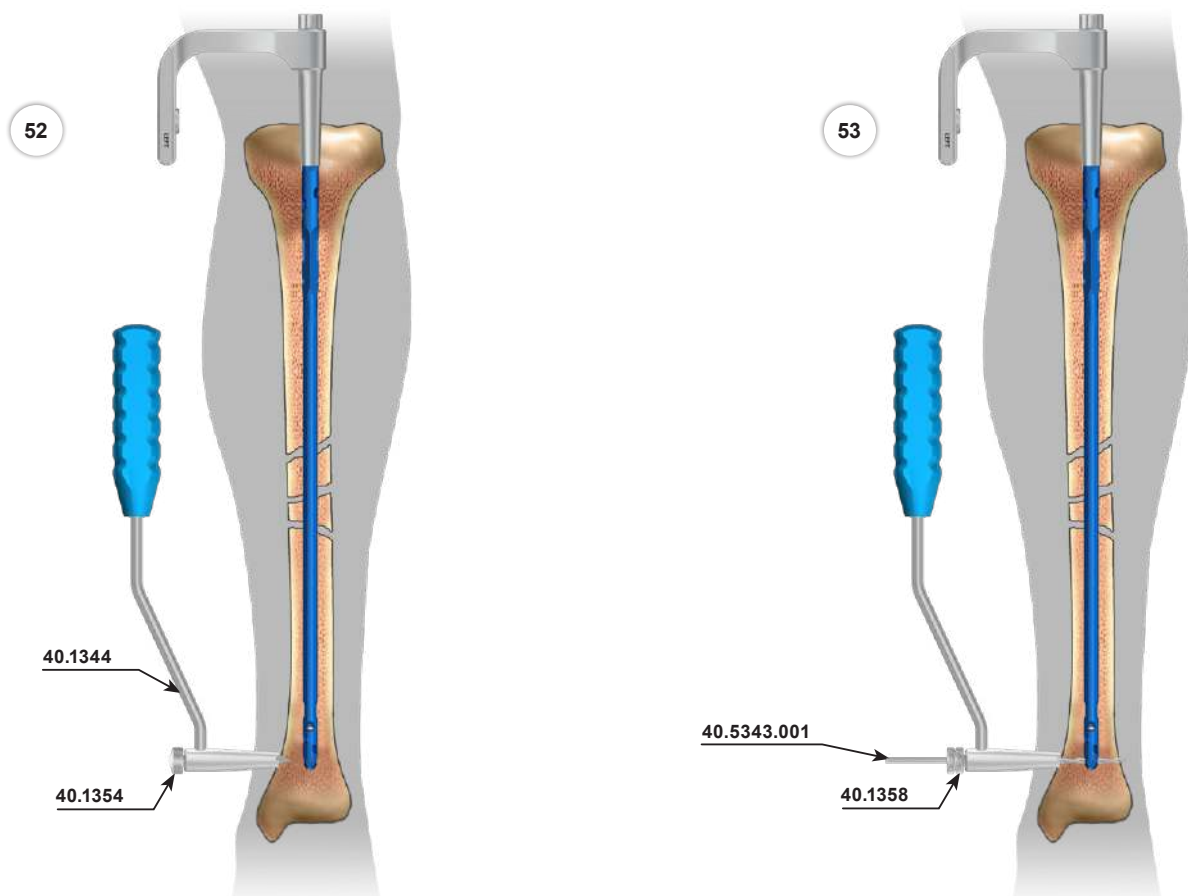

- 54 Insert the Screw Length Measure [40.1374] through the Targeter D hole [40.1344] into the drilled hole until its hook reaches the "exit" plane of the hole. Read the length of the locking screw on the D scale.

Remove the Screw Length Measure.
Leave the Targeter D.

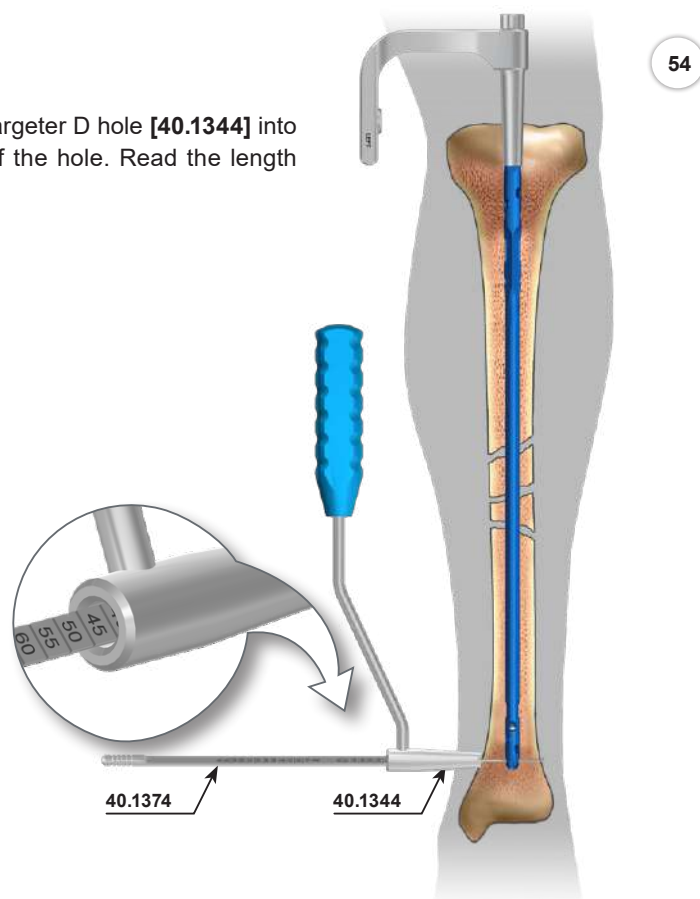

- 55 Insert the tip of the Hexagonal Screwdriver 3.5 [40.3619] into the socket of the selected locking screw. Then advance such system into the hole of Targeter D [40.1344]. Insert the locking screw into the prepared hole until its head reaches the cortex of the bone.

Remove the Hexagonal Screwdriver 3.5 and the Targeter D.



NOTE!!!
In order to lock the nail in the second distal hole follow the steps [32] to [35].

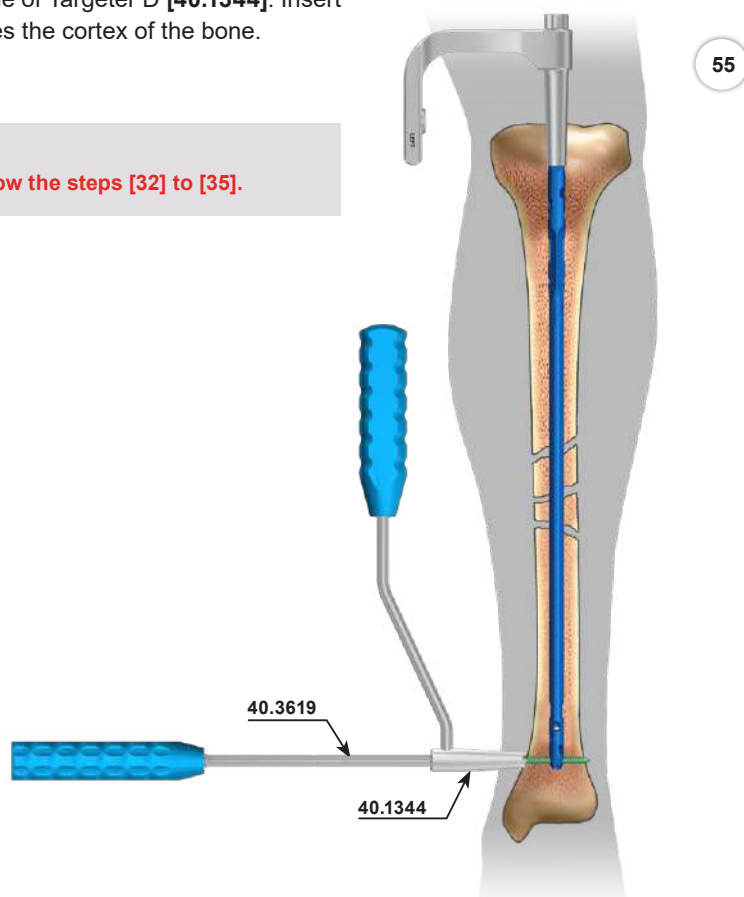

VIII. NAIL EXTRACTION

- 56 Use the Hexagonal Screwdriver 3.5 [40.3619] to remove the End Cap (or compression screw) and all locking screws.
 Insert the Connector M8x1.25 [40.5309] into the threaded nail hole.
 Attach the Impactor-Extractor [40.5308] to the Connector and using the Mallet [40.3667] remove the nail from the medullary canal.

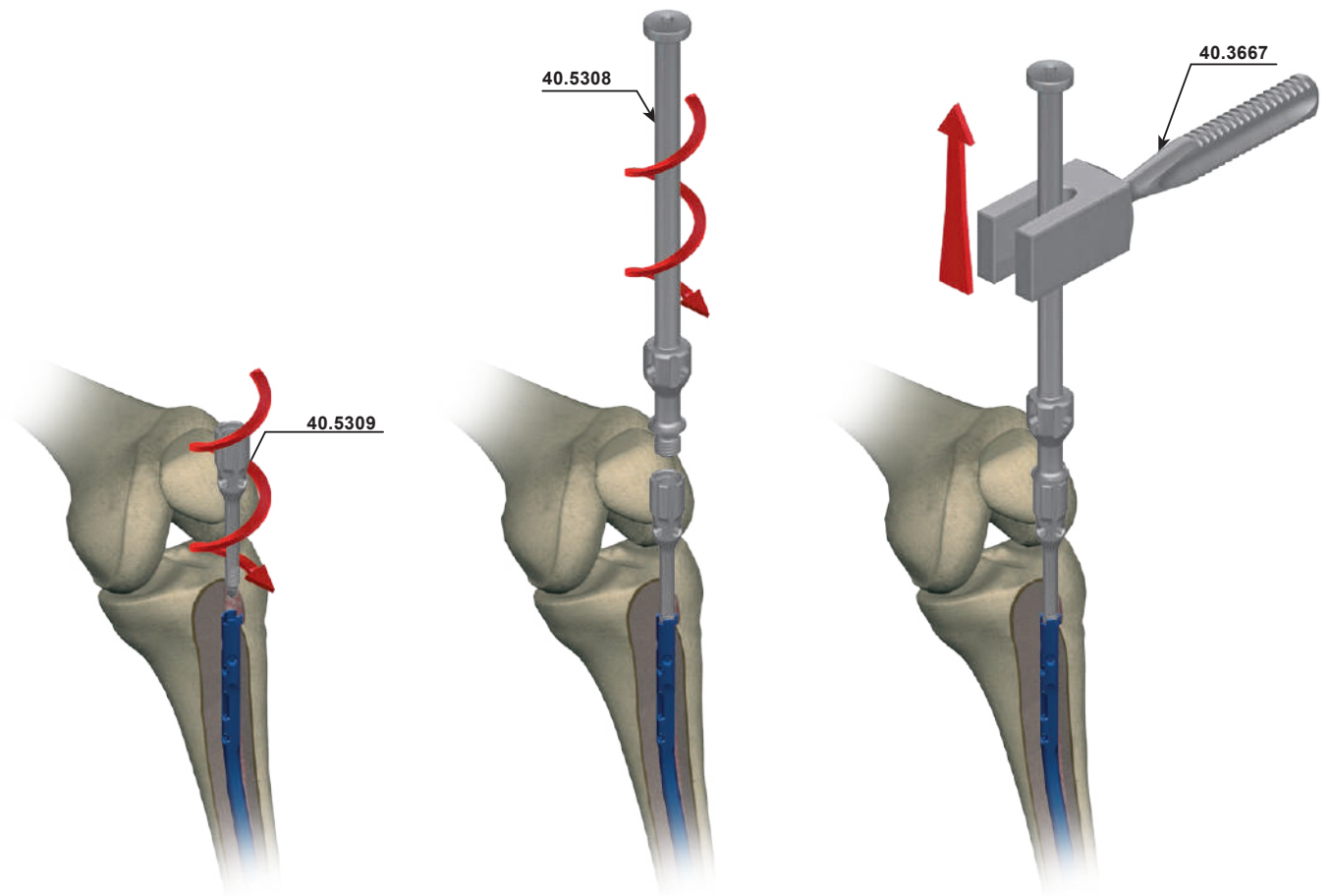
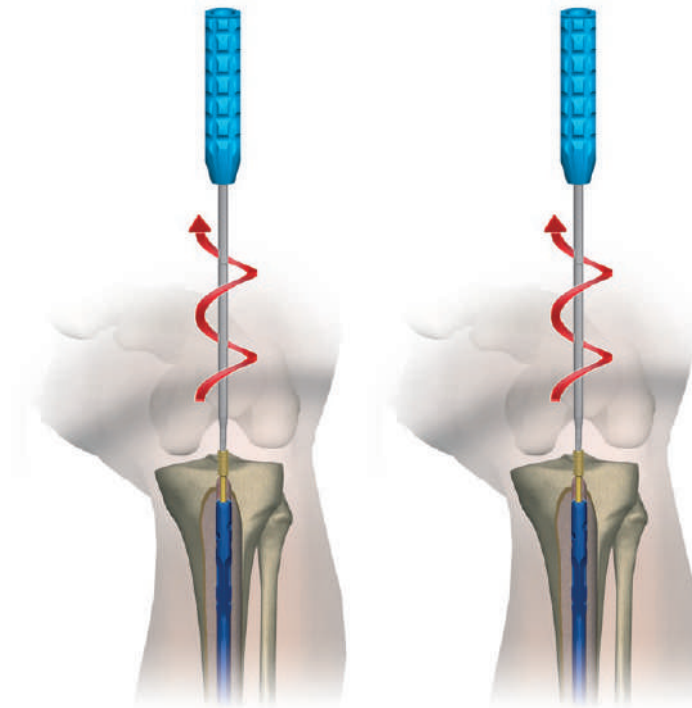

ChM sp. z o.o.

Lewickie 3b
16-061 Juchnowiec Kościelny
Poland

tel. +48 85 86 86 100

fax +48 85 86 86 101

chm@chm.eu

www.chm.eu



CE 0197