

# CHM<sup>®</sup>

























Charfix Femoral Nail  
**ChFN** system

## INTRAMEDULLARY OSTEOSYNTHESIS OF FEMUR WITH ChFN TROCHANTERIC NAILS

- *IMPLANTS*
- *INSTRUMENT SET 40.5520.600*
- *SURGICAL TECHNIQUE*



## SYMBOLS DESCRIPTION

	Titanium or titanium alloy		Cannulated
	Steel		Locking
	Left		Diameter
	Right		Inner diameter
	Available versions: left/right		Recommended length range for a particular nail
	Length		Angle
	Torx drive		Available lengths
	Torx drive cannulated		Available in sterile/ non- sterile condition
	Hexagonal drive		
	Hexagonal drive cannulated		
	Caution - pay attention to a special procedure.		
	Perform the activity under X-Ray control.		
	Information about the next stages of a procedure.		
	Proceed to the next stage.		
	Return to the specified stage and repeat the activity.		
	Before using the product, carefully read the Instructions for Use. It contains, among others, indications, contraindications, side effects, recommendations and warnings related to the use of the product.		
	The above description is not a detailed instruction of conduct. The surgeon decides about choosing the operating procedure.		

**www.chm.eu**

Document No ST/28D-2  
 Date of issue 02.08.2010  
 Review date P-010-24.11.2020

*The manufacturer reserves the right to introduce design changes.*

*Updated INSTRUCTIONS FOR USE are available at the following website: ifu.chm.eu*

---

I. INTRODUCTION	5
II. IMPLANTS	5
III. SURGICAL TECHNIQUE	15
III.1. INTRODUCTION	15
III.2. PREPARATION FOR IMPLANTATION OF SHORT TROCHANTERIC NAIL 120°,125°,130° OR 135°	16
III.3. POSITIONING OF TARGETER D SLIDER	17
III.4. OPENING AND PREPARING THE MEDULLARY CANAL FOR INSERTION OF TROCHANTERIC NAIL ( <i>SHORT AND LONG</i> )	17
III.5. NAIL INSERTION INTO MEDULLARY CANAL ( <i>SHORT AND LONG NAILS</i> )	19
III.6. LOCKING THE TROCHANTERIC NAIL IN THE PROXIMAL PART	20
III.6A. LOCKING THE TROCHANTERIC NAIL ( <i>SHORT AND LONG</i> ) IN THE PROXIMAL PART USING TWO JOIN SCREWS	20
III.6B. LOCKING THE TROCHANTERIC NAIL IN THE PROXIMAL PART USING THE JOIN SCREW WITH ANTIROTARY PROTECTION	25
III.7. LOCKING THE SHORT TROCHANTERIC NAIL IN DISTAL PART	28
III.8. LOCKING THE LONG TROCHANTERIC NAIL IN THE DISTAL PART	31
III.9. THE NAIL EXTRACTION ( <i>LONG AND SHORT</i> )	33



## I. INTRODUCTION



Intramedullary Osteosynthesis of Femur with **CHARFIX FEMORAL NAIL** consists of:

- implants (*intramedullary nails, locking screws, join screws, end caps*),
- instrument sets for implants insertion and removal,
- Instructions for Use

Intramedullary osteosynthesis of femur with **ChFN** nails allows for stable reduction of femur peritrochanteric fractures. Application of two join screws eliminates rotation of femur neck.

The presented range of implants is made of titanium and its alloys and implantable steel in accordance with ISO 5832 standard. Compliance with the requirements of quality management systems and the requirements of Directive 93/42/EEC concerning medical devices guarantee high quality of the offered implants.

Application of the nail:

- subtrochanteric fractures,
- intertrochanteric fractures,
- pertrochanteric fractures.



Examples of femur fractures treated with ChFN nail

Good result are obtained for:

- Pathological damage (*one-place*) as well as damage to ipsilateral intertrochanteric area.
- Pathological damage (*one-place*) as well as ipsilateral fractures of femoral shaft.
- Multifragmental fractures of near-trochanter area.
- Basic fractures of femoral neck.

## II. IMPLANTS

Implants consist of:

- solid and cannulated trochanteric nails 8÷19mm diameter graded by 1mm and length 200÷600mm graded by 5mm;
- distal screws 4.5,
- distal screws 5.0,
- end cap M8,
- end cap M12,
- join screw 11,
- join screw 6.5,
- compression screw (*locking option using one join screw*).

ChFN TROCHANTERIC NAIL

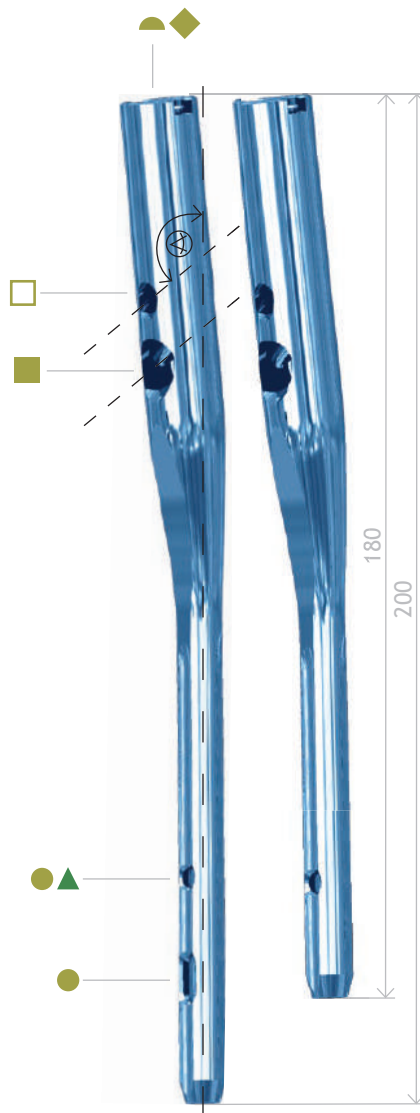
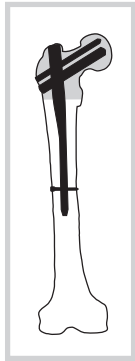
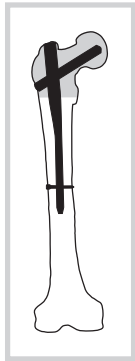

			Ti
130°	10	180	3.4876.180
		200	3.4876.200
	11	180	3.4877.180
		200	3.4877.200
	12	180	3.4878.180
		200	3.4878.200
130°	Recommended		

available		Ø 10 mm ±12 mm	pitch 1 mm
		L 180 mm ± 240 mm	5 mm



	Ti						
	3.1938.xxx			✓	11	70÷120	■
	3.2104.003	✓		✓			
	3.1935.xxx	✓		✓	6.5	70÷120	□
	3.1657.xxx	✓	✓		5.0	30÷60	▲
	3.1654.xxx	✓			4.5	30÷60	●
	3.2106.008	✓					◐
	3.2104.6xx	✓		✓		0÷15	◆

ChFN TROCHANTERIC NAIL



		Len	Ti
125°	10	180	3.4864.180
		200	3.4864.200
	11	180	3.4865.180
		200	3.4865.200
	12	180	3.4866.180
		200	3.4866.200
135°	10	180	3.4888.180
		200	3.4888.200
	11	180	3.4889.180
		200	3.4889.200
	12	180	3.4890.180
		200	3.4890.200

available		Ø	10 mm ÷ 12 mm	pitch	1 mm
		L	180 mm ÷ 240 mm		5 mm



Stand for ChFN trochanteric nails-  
 (set with a box without implants)  
 Подставка для вертельных стержней ChFN-  
 (комплект с контейнером без имплантатов)

40.4687.200

ChFN TROCHANTERIC NAIL

Charfix Femoral Nail  
**ChFN system**

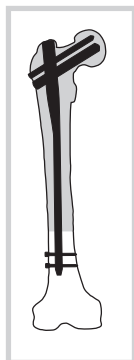
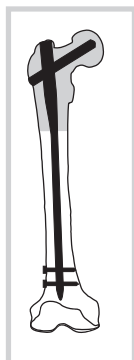

		Len	L	R
10		340	3.4951.340	3.4950.340
		360	3.4951.360	3.4950.360
		380	3.4951.380	3.4950.380
		400	3.4951.400	3.4950.400
		420	3.4951.420	3.4950.420
130°		340	3.4953.340	3.4952.340
		360	3.4953.360	3.4952.360
		380	3.4953.380	3.4952.380
		400	3.4953.400	3.4952.400
		420	3.4953.420	3.4952.420
12		340	3.4955.340	3.4954.340
		360	3.4955.360	3.4954.360
		380	3.4955.380	3.4954.380
		400	3.4955.400	3.4954.400
		420	3.4955.420	3.4954.420

130°	Recommended									
available		<table border="1"> <tr> <td>Ø</td> <td>10 mm ÷ 12 mm</td> <td rowspan="2">pitch</td> <td>1 mm</td> </tr> <tr> <td>L</td> <td>280 mm ÷ 480 mm</td> <td>5 mm</td> </tr> </table>	Ø	10 mm ÷ 12 mm	pitch	1 mm	L	280 mm ÷ 480 mm	5 mm	
Ø	10 mm ÷ 12 mm	pitch	1 mm							
L	280 mm ÷ 480 mm		5 mm							

	Ti					
	3.1938.xxx		✓	11	70÷120	■
	3.2104.003	✓				
	3.1935.xxx	✓		6.5	70÷120	□
	3.1657.xxx	✓	✓	5.0	30÷80	▲
	3.1654.xxx	✓		4.5	30÷80	●
	3.2106.008	✓				◐
	3.2104.6xx	✓	✓	0÷15		◆



## ChFN TROCHANTERIC NAIL



		Len	L	R	
		340	3.4927.340	3.4926.340	
		360	3.4927.360	3.4926.360	
	10	380	3.4927.380	3.4926.380	
		400	3.4927.400	3.4926.400	
		420	3.4927.420	3.4926.420	
		340	3.4929.340	3.4928.340	
		360	3.4929.360	3.4928.360	
	125°	380	3.4929.380	3.4928.380	
		400	3.4929.400	3.4928.400	
		420	3.4929.420	3.4928.420	
		340	3.4931.340	3.4930.340	
		360	3.4931.360	3.4930.360	
	12	380	3.4931.380	3.4930.380	
		400	3.4931.400	3.4930.400	
		420	3.4931.420	3.4930.420	
		340	3.4975.340	3.4974.340	
		360	3.4975.360	3.4974.360	
	10	380	3.4975.380	3.4974.380	
		400	3.4975.400	3.4974.400	
		420	3.4975.420	3.4974.420	
		340	3.4977.340	3.4976.340	
		360	3.4977.360	3.4976.360	
	135°	380	3.4977.380	3.4976.380	
		400	3.4977.400	3.4976.400	
		420	3.4977.420	3.4976.420	
		340	3.4979.340	3.4978.340	
		360	3.4979.360	3.4978.360	
	12	380	3.4979.380	3.4978.380	
		400	3.4979.400	3.4978.400	
		420	3.4979.420	3.4978.420	

available		Ø	10 mm ±12 mm	pitch	1 mm
		L	280 mm ± 480 mm		5 mm

## LOCKING ELEMENTS



CHARFIX DISTAL SCREW 4.5



30	3.1654.030
35	3.1654.035
40	3.1654.040
45	3.1654.045
50	3.1654.050
55	3.1654.055
60	3.1654.060
65	3.1654.065
70	3.1654.070
75	3.1654.075
80	3.1654.080



CHARFIX DISTAL SCREW 5.0



30	3.1657.030
35	3.1657.035
40	3.1657.040
45	3.1657.045
50	3.1657.050
55	3.1657.055
60	3.1657.060
65	3.1657.065
70	3.1657.070
75	3.1657.075
80	3.1657.080



ChFN JOIN CANNULATED TROCHANTERIC SCREW COLLAR 6.5



70	3.1935.070
75	3.1935.075
80	3.1935.080
85	3.1935.085
90	3.1935.090
95	3.1935.095
100	3.1935.100
105	3.1935.105
110	3.1935.110
115	3.1935.115
120	3.1935.120

ChFN JOIN CANNULATED TROCHANTERIC SCREW COLLAR 11



70	3.1938.070
75	3.1938.075
80	3.1938.080
85	3.1938.085
90	3.1938.090
95	3.1938.095
100	3.1938.100
105	3.1938.105
110	3.1938.110
115	3.1938.115
120	3.1938.120

## LOCKING ELEMENTS



ChFN END CAP M12X1.75

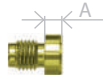

A	
0	3.2104.600
+5	3.2104.605
+10	3.2104.610
+15	3.2104.615

ChFN END CAP M8X1.25



3.2104.003
------------

ChFN COMPRESSION SCREW M8X1.25



















3.2106.008
------------



## INSTRUMENT SET FOR ChFN FEMORAL NAILS 40.5520.600





















40.5520.600	Name	Pcs.	Catalogue no.
	Targeter arm	1	40.5541.000
	Targeter 120/130	1	40.5542.100
	Targeter 125/135	1	40.5543.100
	Distal targeter D	1	40.5546.000
	Drill guide 14/12	1	40.5544.100
	Protective guide 12/2.8	1	40.5545.100
	Connecting screw M12x1.75 L-34	1	40.5547.000
	Drill guide 9.0/7.0	1	40.5537.100
	Protective guide 7.0/2.8	1	40.5538.100
	Drill with scale 3.5/350	2	40.5339.001
	Drill guide 7/3.5	2	40.5511.100
	Protective guide 9/7	2	40.5510.100
	Compression wrench	1	40.5532.300
	Screwdriver S3.5	1	40.5525.100
	Cannulated screwdriver S4	1	40.5524.300
	Drill 6.5	1	40.5529.000
	Gradual drill 11/6.5	1	40.5528.000







## INSTRUMENT SET FOR ChFN FEMORAL NAILS 40.5520.600

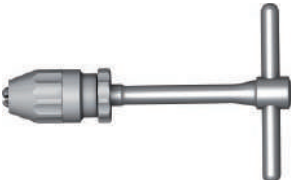

40.5520.600	Name	Pcs.	Catalogue no.
	Screwdriver S10	1	40.5521.000
	Mallet	1	40.3667.000
	Wrench S10	1	40.5526.100
	Impactor-extractor	1	40.5507.000
	Curved awl 8.0	1	40.5523.000
	Protective guide 20.0/17.0	1	40.4711.000
	Guide 17.0/2.8	1	40.4712.100
	Set block 9/4.5	2	40.5533.000
	Cannulated drill 17.0	1	40.4715.000
	Connector of extractor M12x1.75	1	40.4731.000
	Trocar 2.8	1	40.5527.000
	Trocar 6.5	1	40.5534.000
	Screw length measure	1	40.5530.000
	Cannulated screw length measure	1	40.4724.000
	Nail length measure	1	40.4798.500
	Teflon pipe guide	1	40.1348.000
	Guide rod 3.0/580	1	40.3925.580
	Guide rod 2.8/385	4	40.5531.000

## INSTRUMENT SET FOR TROCHANTERIC NAILS ChFN 40.5520.600



40.5520.600	Name	Pcs.	Catalogue no.
	Steinmann handle	1	40.0987.200
	Wrench for self-aligning joint S4	1	40.5540.000
	Perforated aluminum cover 1/1 595x275x15mm gray	1	12.0750.200
	Stand f/instr.set of ChFN trochanteric nails	1	40.5549.600
	Container with solid bottom 1/1 595x275x185mm	1	12.0750.103

### III. SURGICAL TECHNIQUE

#### III.1. INTRODUCTION

When the patient cannot be operated at the day of femoral fracture, it is recommended to apply strong traction for 2 to 3 days to spread the fragments. This will considerably facilitate fracture reduction and nail insertion. Positioning patient on the traction table is an integral part of the operating procedure. Presented method of intramedullary osteosynthesis requires image intensifier control.



Each operating procedure must be carefully planned. X-Ray of the entire femur is essential as to not overlook the injuries in its proximal or distal part. It is especially important in the cases of pathological subtrochanteric fractures. Special attention should be paid to concurrent neck fractures or proximal epiphysis multi-fragment fractures, and the possibility of its occurrence during the procedure.

During the operation, secondary fractures of main fragments may occur. The condition of hip joint is also important. In advanced artrosis or contracture, fixation may be difficult or even impossible to perform. In addition, it should be checked whether alloplasty of hip or knee has ever been performed on the fractured limb before. The procedure has to be carried out on the operating table with traction with the patient placed supine or on the side. Side position facilitates the approach to the greater trochanter, which is especially important with overweight patients. Supine position provides less favorable access to the greater trochanter, but makes all other stages of the operation considerably easier (*especially rotary corrections*).

In the presented method, supine position is recommended with traction applied on the condyles of the operated femur.

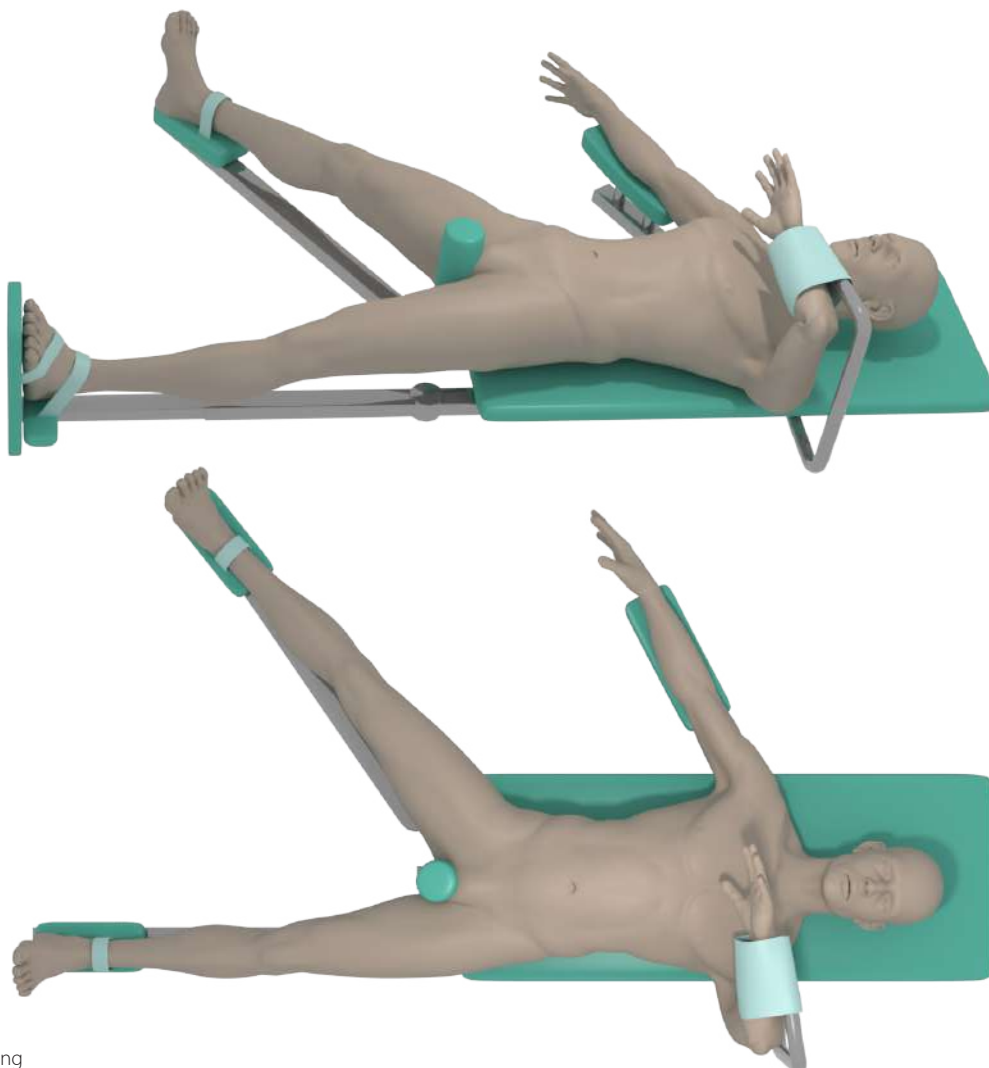

Fig.1. Patient positioning

Lateral surgical approach shall be applied starting the incision near the tip of greater trochanter in line with the femoral shaft axis for 8 cm. The incision should be longer in patients with overweight. Perform similar incision in fascia. Fibres of greater gluteal muscle are then split, thus providing approach to the tip of greater trochanter.

The trochanteric nail should be introduced in such a way that its axis is approximately in line with the medullary canal axis. This beneficially influences loads distribution that transmits mechanical loads in the case of patient who has already started to walk.

On the basis of X-Rays images of fractured femur and the healthy one, the surgeon decides about the type of nail, its length, angle and diameter.

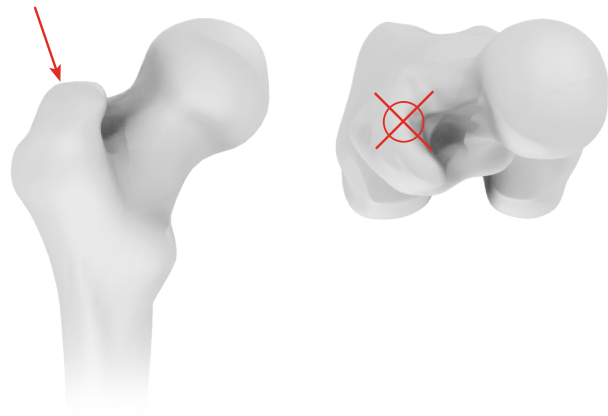

Fig.2. Location of the entry point for femoral nail



The following paragraphs describe most important steps during implantation of ChFN trochanteric nails; nevertheless it is not a detailed instruction of use. The surgeon decides about choosing the surgical technique and its application in each individual case.

### III.2. PREPARATION FOR IMPLANTATION OF SHORT TROCHANTERIC NAIL 120°,125°,130° OR 135°

**1** Mount trochanteric nail to the targeter arm [40.5541] using the connecting screw M12x1.75 L-34 [40.5547] and the screwdriver S10 with pilot [40.5521].

Mount specified targeter onto the targeter arm depending on selected nail angle.

- for nail 120° and 130° use targeter 120/130 [40.5542.100],
- for nail 125° and 135° use targeter 125/135 [40.5543.100].

		40.5521.000
		40.5547.000
		40.5541.000
120°/130°		40.5542.100
125°/135°		40.5543.100





### III.3. POSITIONING OF TARGETER D SLIDER

2 In case of long nail implantation, mount the distal targeter D [40.5546] to the targeter arm [40.5541]. Then set correct position of the targeter slider in relation to the nail locking holes in distal part using two set blocks 9/4.5 [40.5533]. Lock the position of slider using the screwdriver S3.5 [40.5525.100].



**CHECK:** Correctly positioned and locked slider should allow easy insertion of the set blocks into the nail holes.

Remove the set blocks.

Dismount the distal targeter D from the targeter arm.

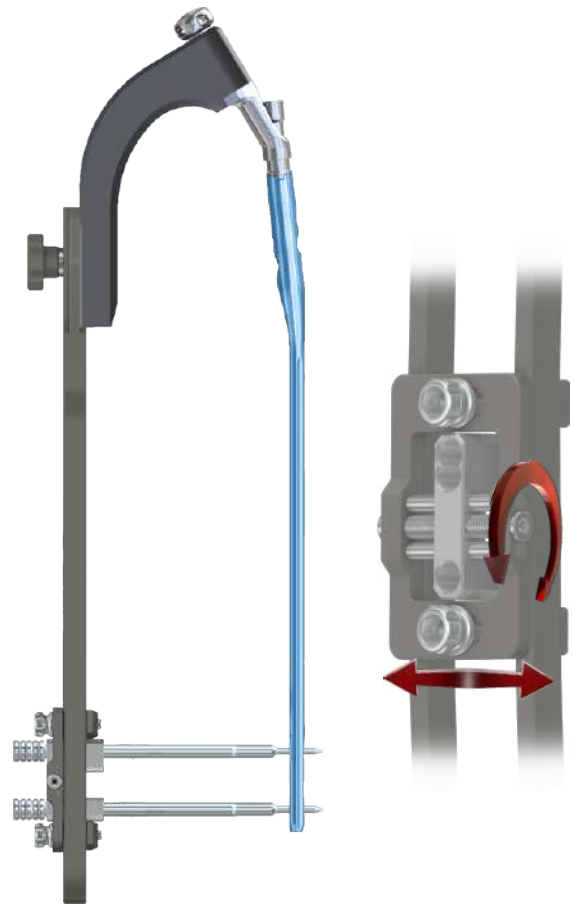

### III.4. OPENING AND PREPARING THE MEDULLARY CANAL FOR INSERTION OF TROCHANTERIC NAIL (SHORT AND LONG)

3 Make the skin incision near the tip of a greater trochanter. Having localized the nail entry point, using the drive insert the guide rod 2.8/385 [40.5531] into the medullary canal. The rod should be inserted in the angle corresponding to the deviation angle of the nail shaft from the main axis (about 6 degrees).



The process should be controlled with image intensifier.

40.5531.000

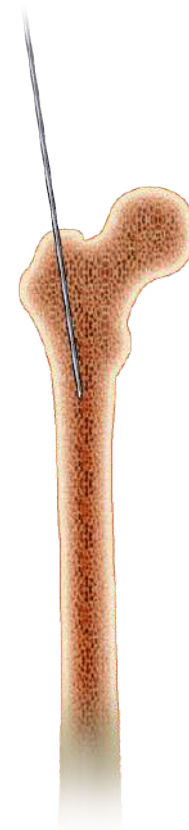

**4** Using guide rod 2.8/385 [40.5531], insert into the medullary canal curved awl 8.0 [40.5523] to the depth at which the awl blade goes along the medullary canal, allowing proper insertion of guide rod 3.0/580 [40.3925.580]. Having opened medullary canal, remove guide rod 2.8/385 [40.5531].

Mount guide rod 3.0/580 [40.3925.580] to Steinmann handle [40.0987.200] and enter the guide into the medullary canal through curved awl 8.0 [40.5523] cannulated hole to the depth required for the proper fixation of bone fragments. While guide rod insertion, control the fracture reduction and make sure the guide rod passes through all the bone fragments. Remove Steinmann handle [40.0987.200] and curved awl 8.0 [40.5523]. Leave guide rod 3.0/580 [40.3925.580] in place.

Open the medullary canal using cannulated drill 17.0 [40.4715] inserted into protective guide 20.0/17.0 [40.4711] via guide rod 3.0/580 [40.3925.580].

Slowly ream the medullary canal using cannulated drill until it rests on the protective guide. Remove protective guide, cannulated drill.

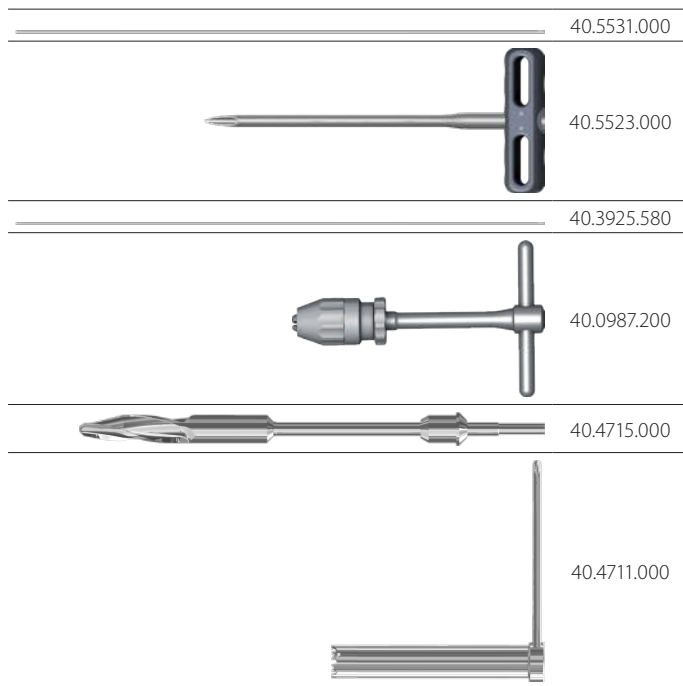

**5** In the case medullary canal is reamed, gradually increase the diameter of reamers with steps of 0.5 mm, until the diameter 1.5 to 2.0 mm wider than the diameter of the nail is reached, for the depth at least equal to the nail length (*but not lesser*).

In both cases, when the medullary canal was reamed or not, the proximal part of the canal should be reamed using 17 mm reamer to the depth of approx. 6 cm.

Remove flexible reamer.

Should a different reamer guide than provided guide rod 3.0/580 [40.3925.580] be used, for nail length measuring, the reamer guide must be replaced with the guide rod 3.0/580 [40.3925.580].

Insert teflon pipe guide [40.1348] into the medullary canal via flexible reamer guide. Remove flexible reamer guide. Insert guide rod 3.0/580 [40.3925.580] (*guide for cannulated nail*) using Steinmann handle [40.0987.200] into the teflon pipe guide [40.1348] for the appropriate length.

Remove Steinmann handle and teflon pipe guide

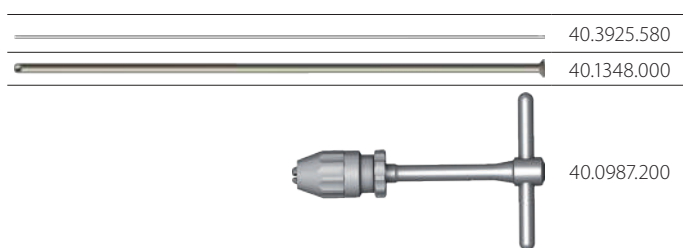



The below step concerns long trochanteric nails.

Insert nail length measure [40.4798.500] via guide rod. The beginning of the measure should be set in the place of depth insertion of the nail. Read the length of the nail on a scale.

Remove nail length measure.

Remove guide rod if solid nail has been chosen.



Medullary canal has been prepared for nail insertion.



### III.5. NAIL INSERTION INTO MEDULLARY CANAL (SHORT AND LONG NAILS)

- 6 Connect the targeter arm [40.5541] with the impactor-extractor [40.5507] and using the mallet [40.3667] insert the nail into the medullary canal.

Remove the guide rod.



### III.6. LOCKING THE TROCHANTERIC NAIL IN THE PROXIMAL PART

#### III.6A. LOCKING THE TROCHANTERIC NAIL (*SHORT AND LONG*) IN THE PROXIMAL PART USING TWO JOIN SCREWS



**NOTE:**  
Nail must be locked with two join screws.

- 7** Mount the targeter 120/130 [40.5542.100] or targeter 125/135 [40.5543.100] to the targeter arm. Insert the drill guide 9.0/7.0 [40.5537.100] and the protective guide 7.0/2.8 [40.5538.100], and trocar 2.8 [40.5527] into the smaller hole of the targeter. Advance the trocar until it reaches the cortex and mark the entry point for the guide rod. Advance the drill guide [40.5537.100] together with the trocar in such a way that its end is placed as close to the bone as possible. Remove the trocar. Insert the drill guide 14/12 [40.5544.100] and the protective guide 12/2.8 [40.5545.100], and trocar 2.8 [40.5527] into the bigger hole of the targeter. Advance the trocar until it reaches the cortex and mark the entry point for the guide rod. Advance the drill guide [40.5544.100] together with the trocar in such a way that its end is placed as close to the bone as possible. Remove the trocar.



40.5542.100



40.5543.100



40.5537.100



40.5538.100



40.5527.000



40.5544.100



40.5545.100

- 8** Correct nail placement needed for the insertion of the join screws can be verified by the screw position measure [40.5522]. In such case, mount the screw position measure [40.5522] onto the drill guide 14/12 [40.5540.100] and position the nail under the control of image intensifier in two projections (*AP and lateral*).



40.5522.000



The instrument set does not include the screw position measure [40.5522].

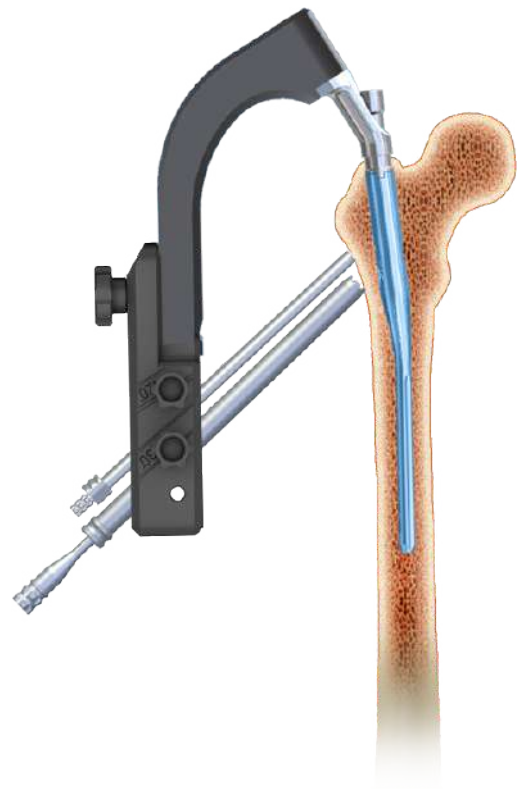

To perform the nail positioning in the lateral plane for the join screws insertion, the screw position measure [40.5522] shall be set perpendicular to the plane of projection. Simultaneously, set the screw position measure in such way that two outer lines match with the hole edges that are seen in the X-Ray.

Rotate the nail with the targeter and set the nail in such way to enable insertion of join screws according to the angle of anteversion of femur neck.

To perform the nail positioning in the AP plane in order to define the screw insertion place in relation to femur neck, rotate the screw position measure [40.5522] on the drill guide and set perpendicular to the plane of projection. Simultaneously, set the screw position measure in such way that two outer lines match with the hole edges of intramedullary nail. Establish the depth of nail insertion to enable insertion of the join screws in the central part of femoral neck.



**IMPLANT PLACED TOO HIGH**



**CORRECT PLACEMENT**



**IMPLANT PLACED TOO LOW**

- 9 Connect the guide rod [40.5531] with electric drive and advance such system into the protective guide 7.0/2.8 [40.5538.100].

Connect the guide rod [40.5531] with electric drive and advance such system into the protective guide 12/2.8 [40.5545.100].



The guide rod [40.5531] shall be inserted into the femoral head at the distance of 5-10mm to the cartilage.

	40.5538.100
	40.5531.000
	40.5545.100

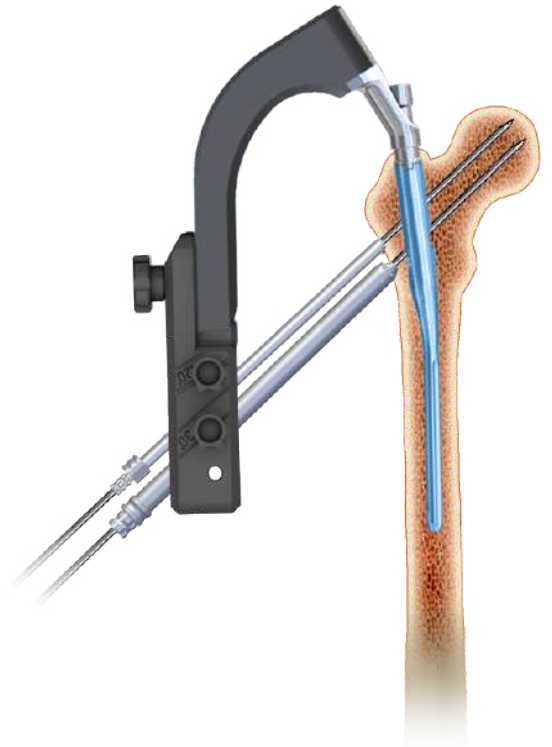

- 10 Insert the cannulated screw length measure [40.4724] via the guide rod 2.8/385 [40.5531] (placed into the protective guide 7.0/2.8 [40.5538.100]) Read the length of the joint screw on the scale indicated by end of the guide rod. During the measurement the tip of the cannulated screw length measure should rest on the protective guide 7.0/2.8, and the guide on cortex bone. Remove the screw length measure and the protective guide 7.0/2.8. Leave the guide rod.

	40.5531.000
	40.4724.000

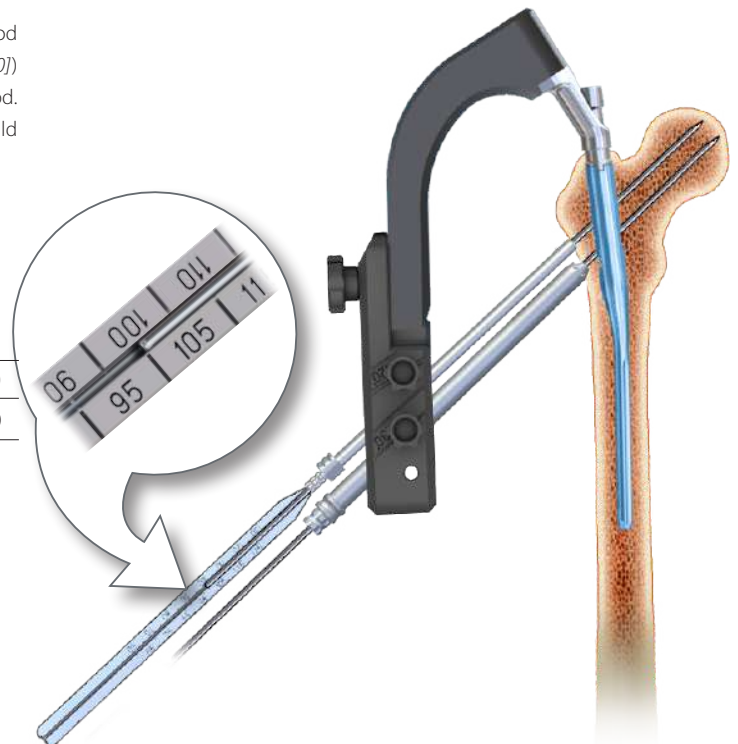

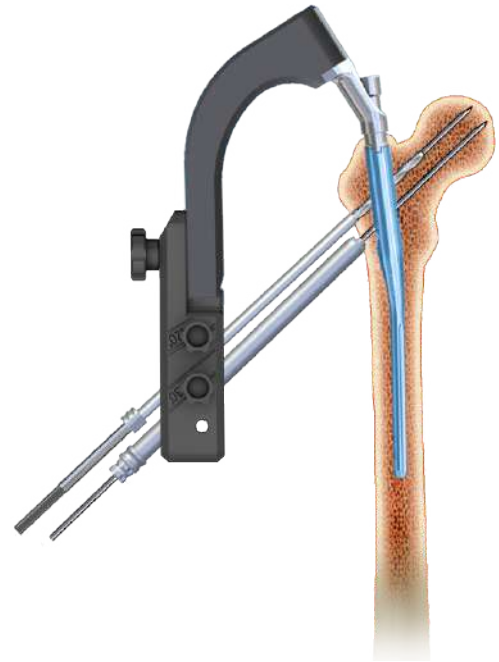

- 11 Connect the drill 6.5 [40.5529] with the electric drive, and insert such system onto the guide rod 2.8/385 [40.5531] and via the drill guide 9.0/7.0 [40.5537.100] ream the hole in first cortex layer (up to the inserted nail).  
Remove the drill.  
Leave the guide rod.

	40.5529.000
	40.5531.000
	40.5537.100

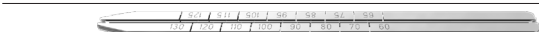

- 12 Insert the join cannulated screw 6.5, defined by the cannulated screw length measure [40.4724], onto the guide rod 2.8/385 [40.5531]. Use the cannulated screwdriver S4 [40.5524.300] to advance the screw via the guide rod into the femur neck until the screwdriver tip rests on the drill guide 9.0/7.0 [40.5537.100].  
Remove the screwdriver, the guide rod and the drill guide 9.0/7.0.  
Guide rod 2.8/385 [40.5531] is single use instrument.

	40.5531.000
	40.4724.000
	40.5524.300
	40.5537.100

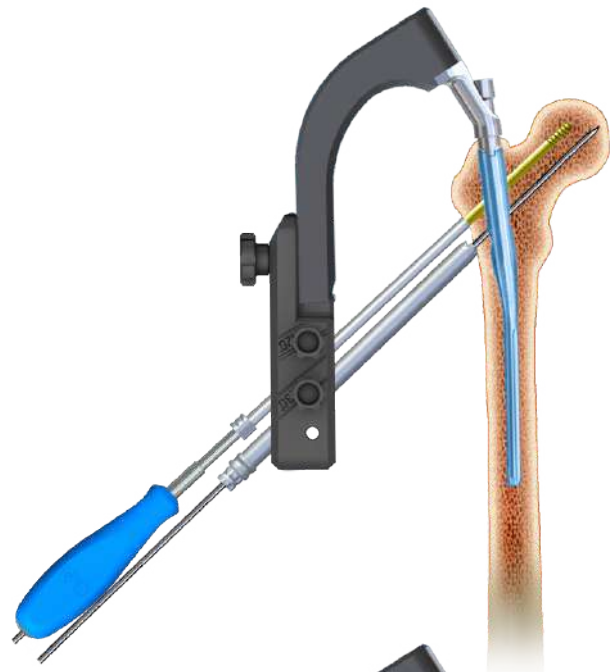

- 13 Onto the guide rod 2.8/385 [40.5531], insert the cannulated screws length measure [40.4724] until its tip rests on the protective guide 12/2.8 [40.5545.100]. Read the length of the join cannulated screw on measure scale, indicated by end of the guide rod.  
When measuring, the end of the screw length measure should rest on the guide 12/2.8  
Remove the cannulated screw length measure and the guide 12/2.8.  
Leave the guide rod.

	40.5531.000
	40.4724.000

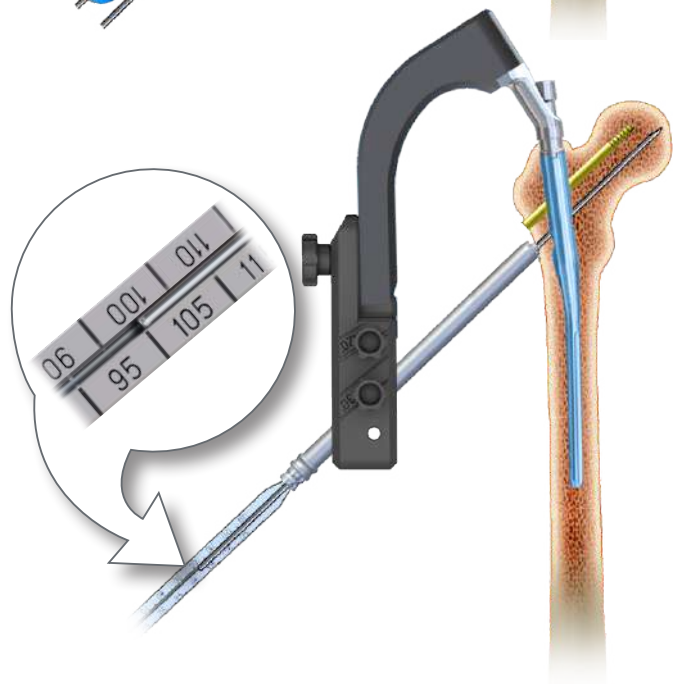

- 14 Use the adjusting bolt to set the depth of drilling (corresponding to the join screw) on the gradual drill 11/6.5 [40.5528]. Connect the gradual drill with electric drive, and advance such system onto the guide rod 2.8/385 [40.5531] until the bolt set rests on the drill guide 14/12 [40.5544.100].

Remove the gradual drill.  
Leave the guide rod and the drill guide.

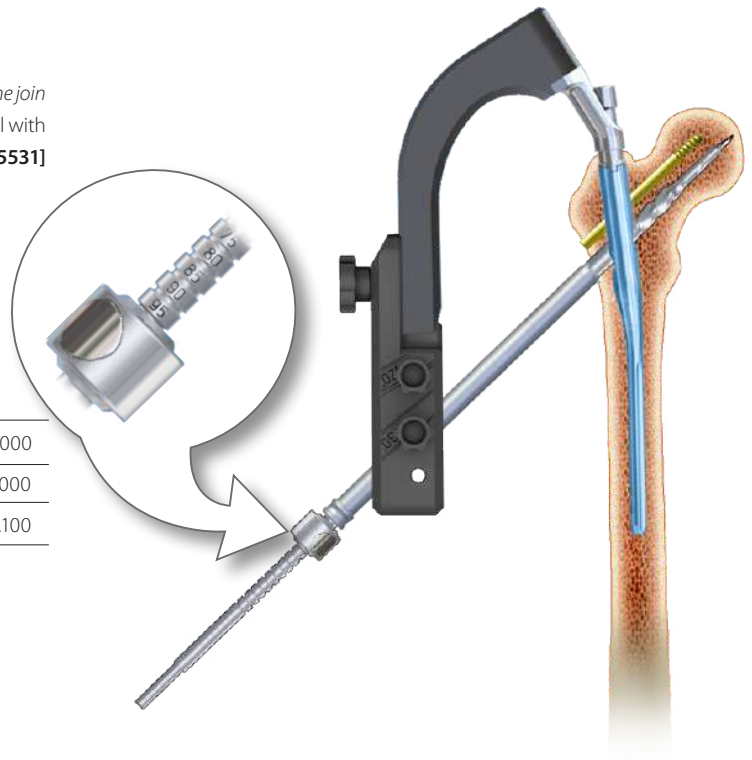
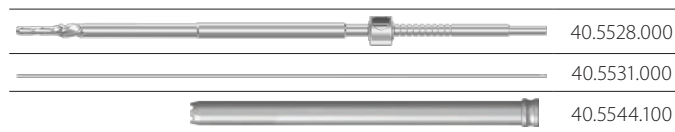

- 15 Mount the join screw (previously determined by the cannulated screw length measure [40.4724]) onto the compression wrench [40.5532.300]. Move back the nut of the wrench until it rests on the sleeve of wrench. Insert the join screw onto guide rod 2.8/385 [40.5531]. Advance the join screw into femur neck using the compression wrench until the wrench nut rests on the drill guide 14/12 [40.5544.100]. If necessary, fracture compression should be made by the wrench nut.

Remove the compression wrench, guide rod and drill guide.  
Guide rod 2.8/385 [40.5531] is single-use device

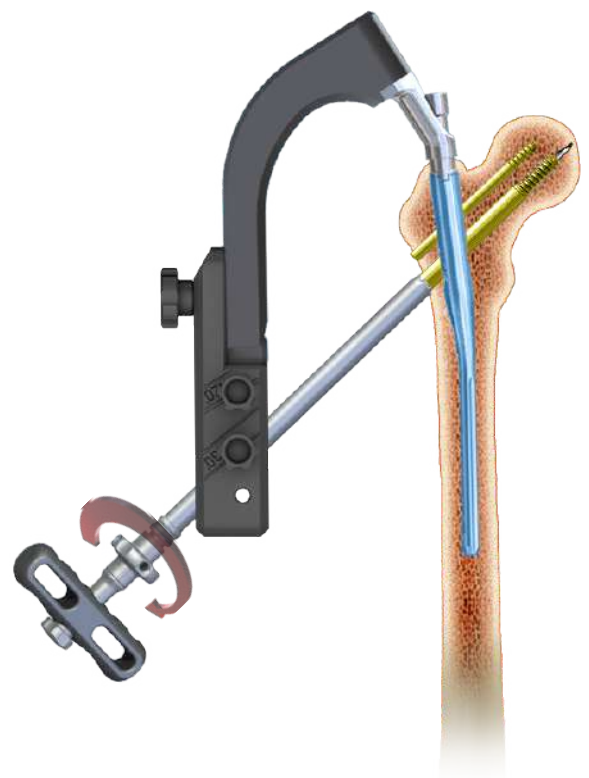
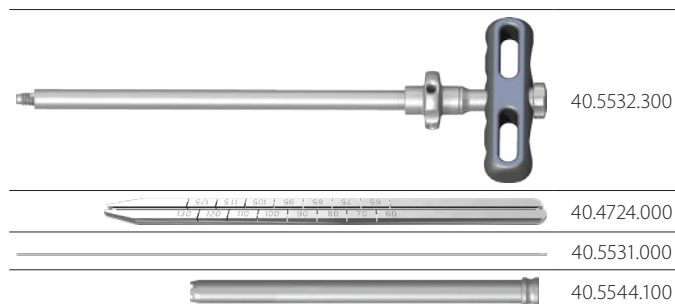



III.6B. LOCKING THE TROCHANTERIC NAIL IN THE PROXIMAL PART USING THE JOIN SCREW WITH ANTIROTARY PROTECTION

**16** Mount previously chosen targeter [40.5542.100] or [40.5543.100] on the targeter arm. Insert the drill guide 9.0/7.0 [40.5537.100] and the protective guide 7.0/2.8 [40.5538.100] into smaller targeter hole. Insert the drill guide 14/12 [40.5544.100] and the protective guide 12/2.8 [40.5545.100] into bigger targeter hole.

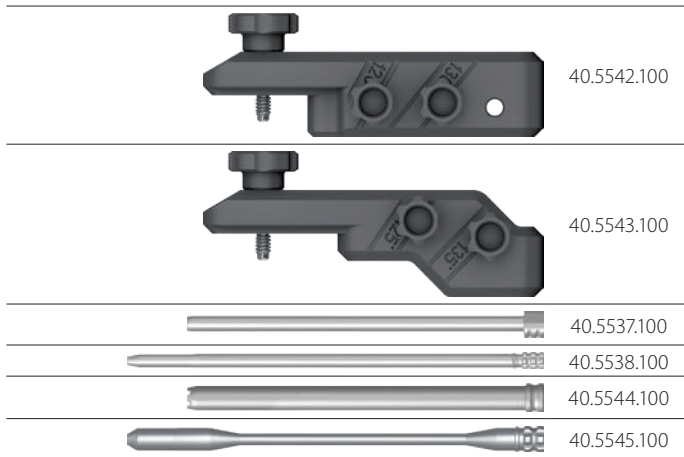

**17** Connect the guide rod [40.5531] with electric drive and advance such system into the protective guide 7.0/2.8 [40.5538.100].

Connect the guide rod [40.5531] with electric drive and advance such system into the protective guide 12/2.8 [40.5545.100].



The guide rod [40.5531] shall be inserted into the femoral head at the distance of 5-10mm to the cartilage.

In the case of inappropriate positioning of the guide rod, repeat the step. Leave the guide rod and guides in the holes.

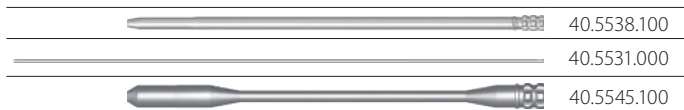

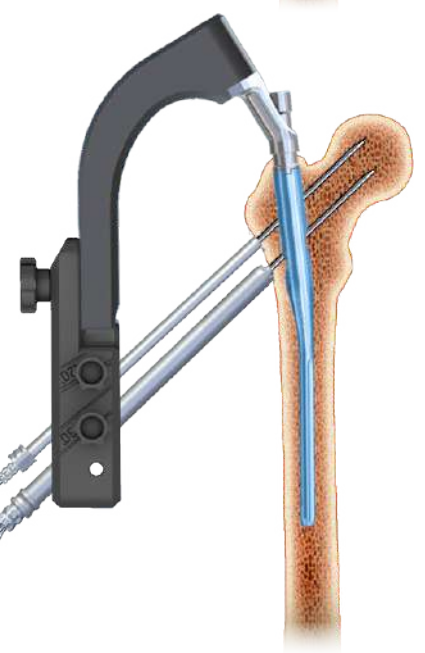
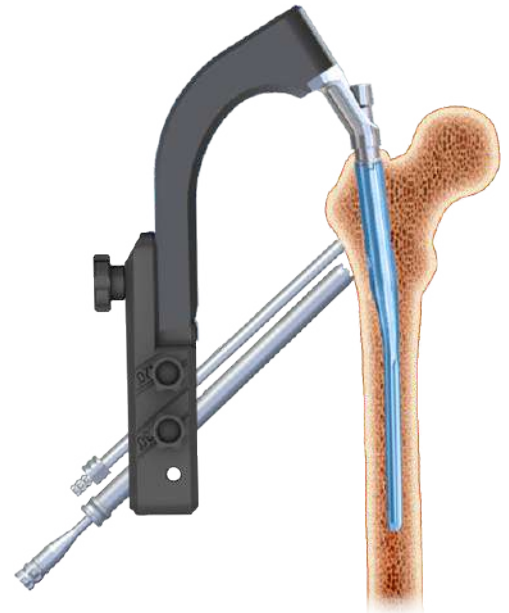
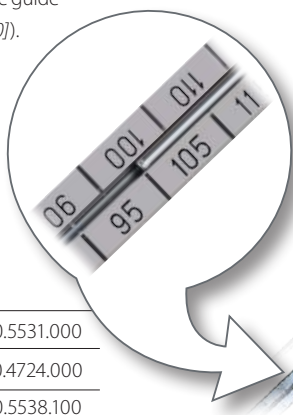
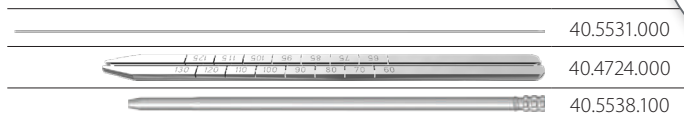

**18** Insert the cannulated screw length measure [40.4724] onto the guide rod 2.8/385 [40.5531] (placed into the guide 12/2.8 [40.5545.100]). Read the length of the join cannulated screw on the scale. The tip of the cannulated screw length measure should rest on the guide 12/2.8 during the measurement.

Remove the cannulated screw length measure, Guide 12/2.8 and protective guide 7.0/2.8 [40.5538.100]. Leave the guide rod.





**19** Define the drilling depth corresponding to the previously chosen join screw on drill 11/6.5 [40.5528] using the adjusting bolt. Connect the gradual drill 11/6.5 with electric drive, and insert such system onto the guide rod 2.8/385 [40.5531] and advance into the femur neck until the slider rests on the drill guide 14/12 [40.5544.100]. Remove the gradual drill 11/6.5. Leave the guide rod and the drill guide.

	40.5528.000
	40.5531.000
	40.5544.100

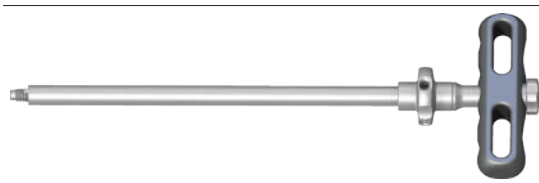

**20** Mount the join screw [3.1949] previously determined by the cannulated screw length measure [40.4724] onto the compression wrench [40.5532.300]. Screw the wrench nut until it rests on the wrench sleeve. Insert the the join cannulated screw onto the guide rod 2.8/385 [40.5531]. Insert the screw into femur neck using the compression wrench leading via guide rod. Handle of the wrench should be set in the plane corresponding to the main axis of the femur. It allows for the correct placement of the implant and facilitates insertion of the compression screw. If necessary, the fracture compression should be made by the nut. Remove upper guide rod.

	40.5532.300
	40.4724.000
	40.5531.000

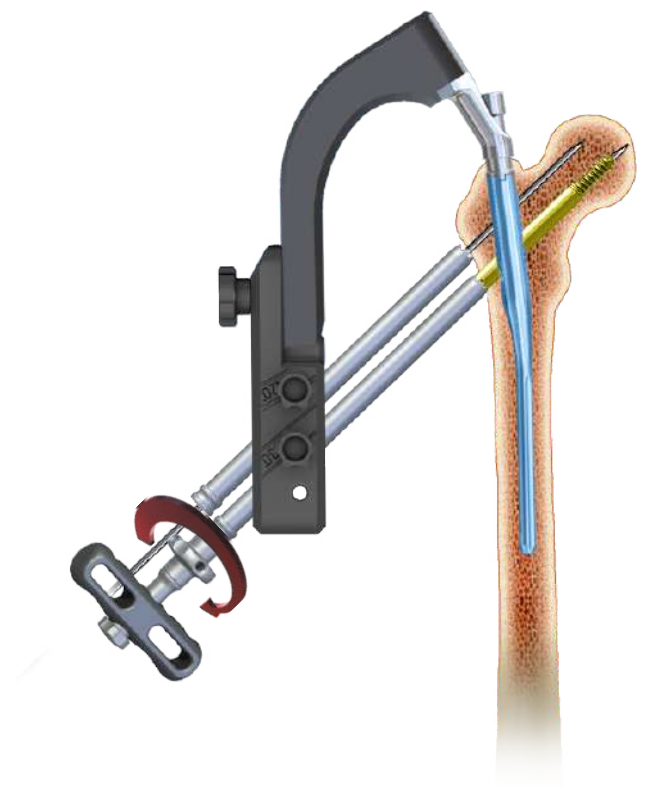

- 21 Compression screw [3.2106.008] should be inserted using wrench for self-aligning joint S4 [40.5540] through the hole in the connecting screw in the targeter in such way to match in 1 of 4 grooves in join screw.

Join screw can be set in two positions:

- dynamic - compression screw is not tightened up and allows join screw for sliding inside the nail without possibility of turn. (*compression screw is maximally tightened up, and next loosened by ¼ turn*)
- static - after interfragmental compression, compression screw is maximally tightened up.

Remove the compression wrench, guide rod and drill guide.

Secure the inner thread of the join screw against tissue overgrowth by insertion of end cap [3.2104.003] using screwdriver S3,5 [40.5525.100].



III.7. LOCKING THE SHORT TROCHANTERIC NAIL IN DISTAL PART

**22** Insert the protective guide 9.0/7.0 [40.5510.100] and the trocar 6.5 [40.5534.100] into the proximal hole of the targeter [40.5542.100] or [40.5543.100]. Mark the entry point for the locking screw, then make an incision of the soft tissues. Advance the trocar until it reaches the cortex and mark the entry point for the drill. Advance the protective guide together with the trocar in such a way that its end is placed as close to the bone as possible. Remove the trocar. Leave the protective guide 9.0/7.0 in the targeter hole.

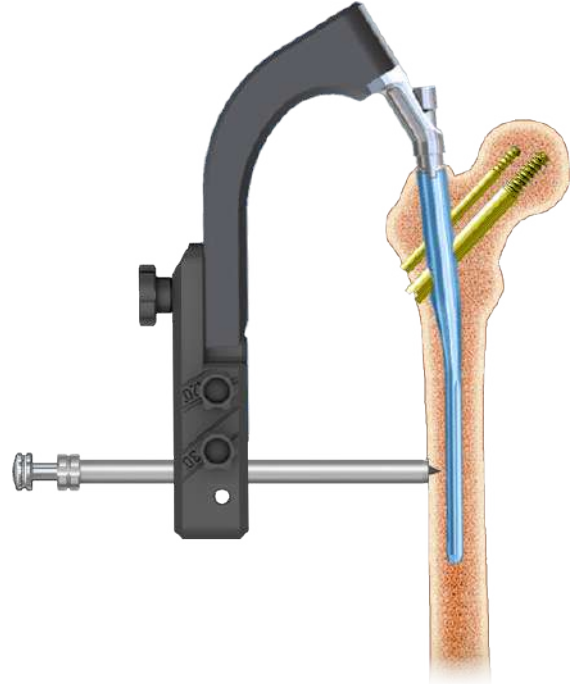
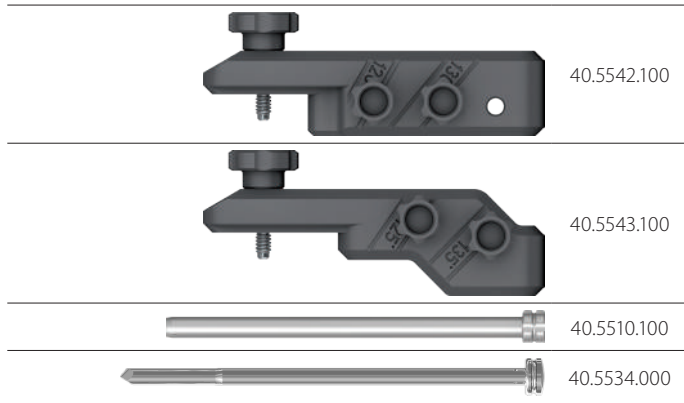

**23** Insert the drill guide 7/3.5 [40.5511.100] into the protective guide 9.0/7.0 [40.5510.100]. Using electric drive, lead the drill with scale 3.5/350 [40.5339.001] into the drill guide and throughout both cortex layers and the nail hole. The scale on the drill indicates the length of locking elements.



Drilling should be controlled with an image intensifier.

Remove electric drive.  
Leave drill, drill guide and protective guide.

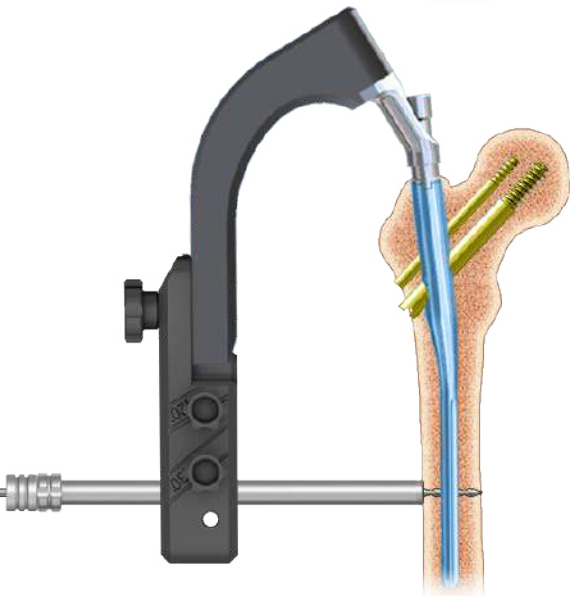

**24** Insert the protective guide 9.0/7.0 [40.5510.100] and the trocar 6.5 [40.5534] into the second (distal) hole of the targeter. Advance the trocar until it reaches the cortex and mark the entry point for the drill. Advance the protective guide with the trocar in such way that its end is placed as close to the bone as possible. Remove the trocar. Leave the protective guide 9.0/7.0 in the targeter hole.

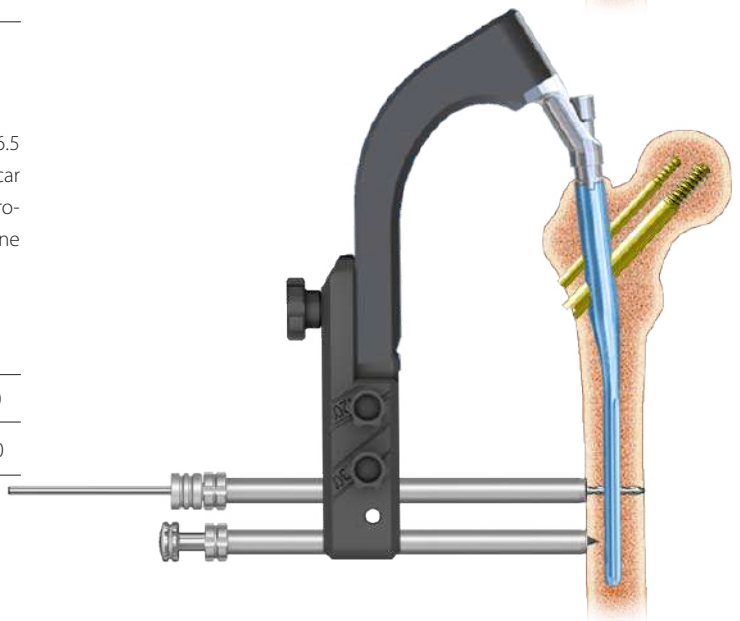
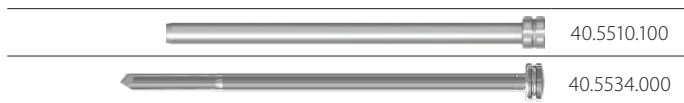

**25** Insert drill guide 7/3.5 **[40.5511.100]** into the protective guide 9.0/7.0 **[40.5510.100]**. Use electric drive to lead drill with scale 3.5/350 **[40.5339.001]** into the drill guide, and drill hole in femur throughout both cortex layers and the nail hole. The scale of the drill indicates the length of locking elements.



Drilling process should be controlled with image intensifier.

Remove the drill and the drill guide.  
Leave the protective guide 9.0/7.0.

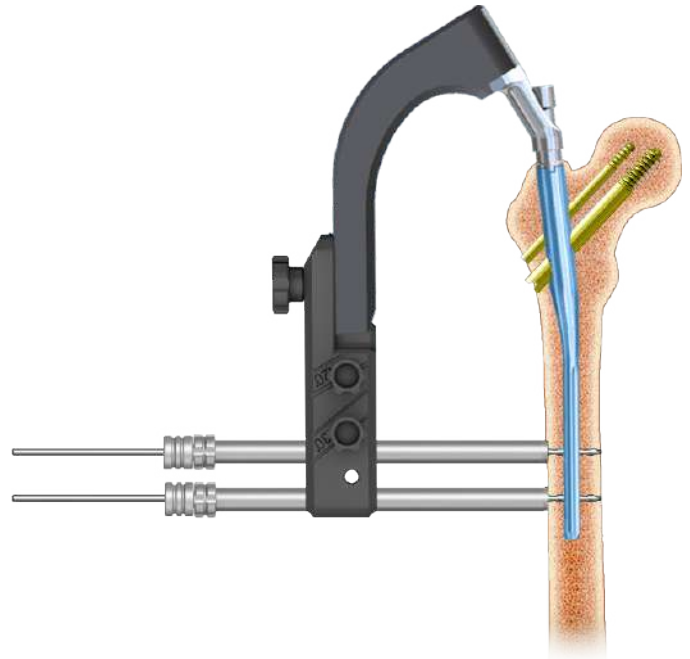
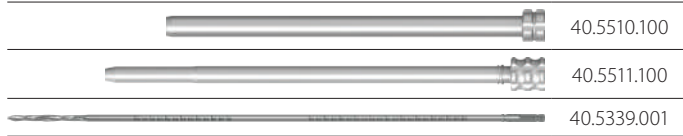

**26** Insert into drilled hole the screw length measure **[40.5530]** through the protective guide 9.0/7.0 **[40.5510.100]** until its hook reaches the exit hole.

Read the length of locking screw on the B-D scale.  
During measurements the protective guide 9.0/7.0 should rest on the cortex bone.  
Remove the screw length measure.  
Leave the protective guide 9.0/7.0 in the targeter hole.

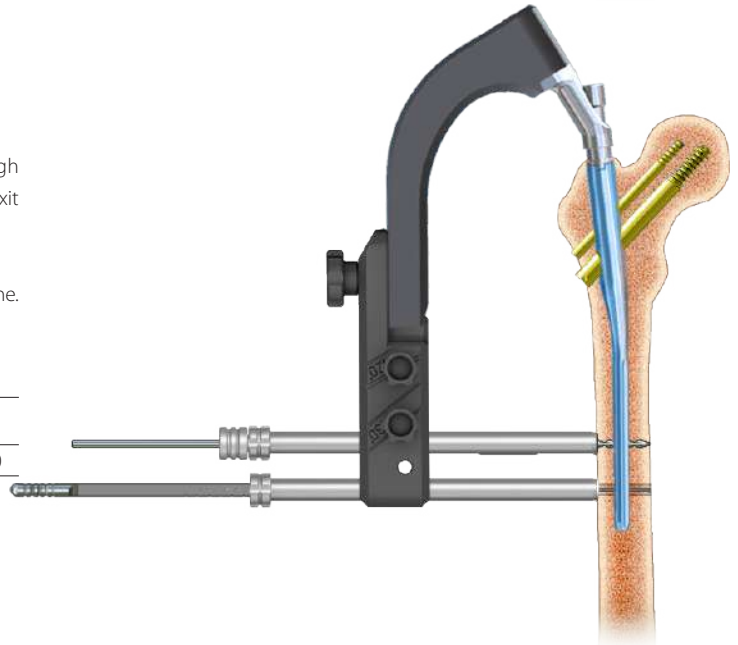
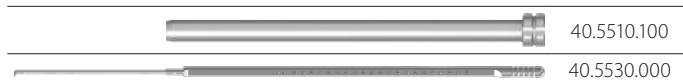



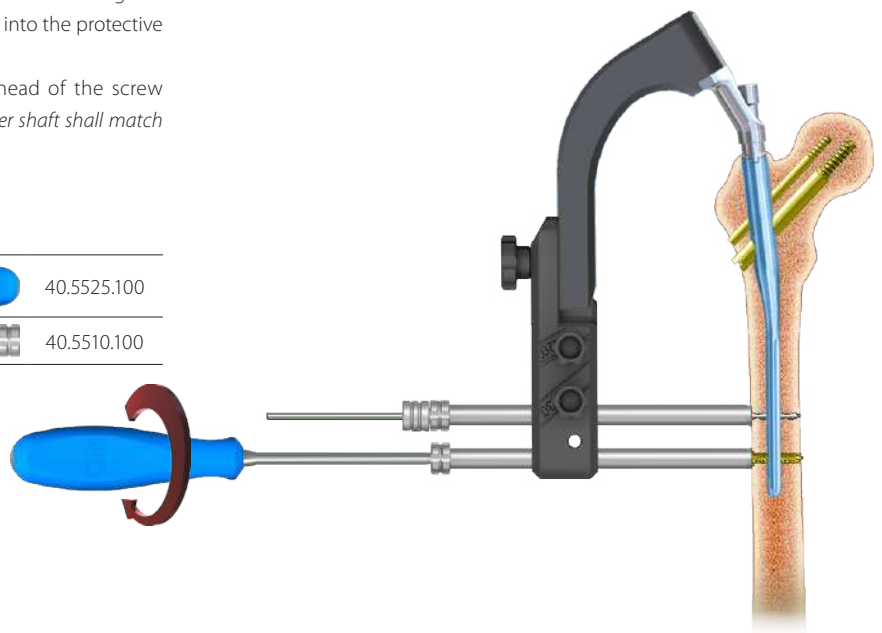
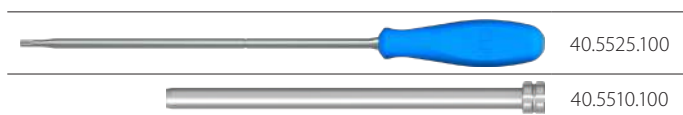

**27** Insert the tip of the screwdriver S3.5 **[40.5525.100]** into the hexagonal socket of selected locking screw. Then advance both into the protective guide 9.0/7.0 **[40.5510.100]**.

Insert the locking screw in the prepared hole until the head of the screw reaches the cortex of the bone (*the groove on the screwdriver shaft shall match the edge of protective guide*).  
Remove the screwdriver and the protective guide 9.0/7.0.





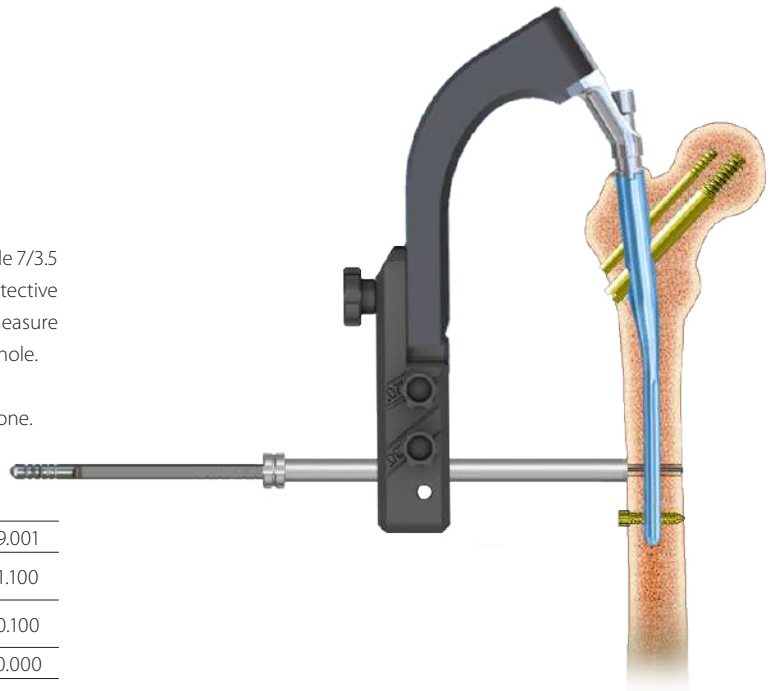

- 28** Remove the drill with scale 3.5/350 [40.5339.001] and the drill guide 7/3.5 [40.5511.100] out of proximal hole in the targeter. Leave the protective guide 9.0/7.0 [40.5510.100] in targeter hole. Insert the screw length measure [40.5530] into the drilled hole until its hook reaches the exit plain of the hole. Read the length of the screw on the B-D scale. During measurement the protective guide should rest on the cortex of bone. Remove the screw length measure. Leave the protective guide in the hole of targeter.

	40.5339.001
	40.5511.100
	40.5510.100
	40.5530.000



- 29** Insert the tip of the screwdriver S3.5 [40.5525.100] into the hexagonal socket of selected locking screw. Then advance both into the protective guide 9.0/7.0 [40.5510.100]. Insert the locking screw into the prepared hole until the head of the screw reaches the cortex of the bone (*the groove on the screwdriver shaft shall match the edge of the protective guide*).

Remove the screwdriver, protective guide and targeter [40.5542.100] or [40.5543.100].

	40.5525.100
	40.5510.100
	40.5542.100
	40.5543.100

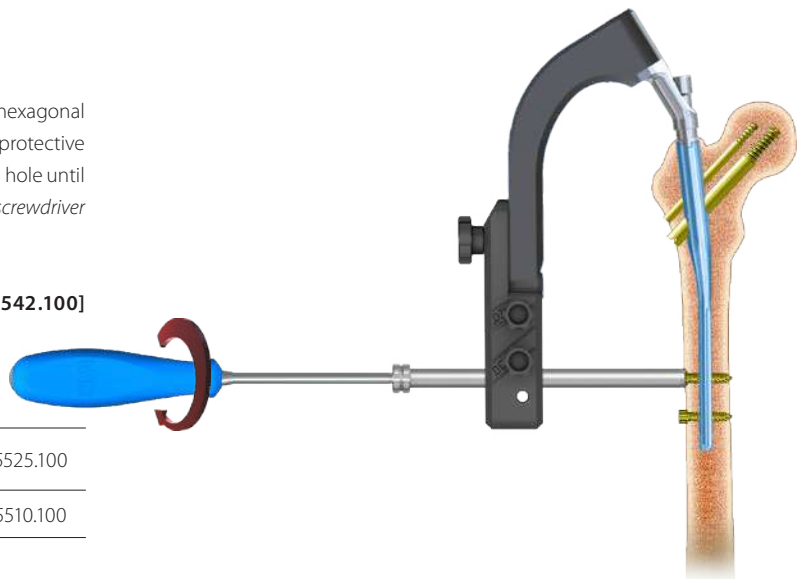

## III.8. LOCKING THE LONG TROCHANTERIC NAIL IN THE DISTAL PART

- 30** After locking the long trochanteric nail in proximal part and dismounting the targeter [40.5542.100] or [40.5543.100]; mount the distal targeter D [40.5546] onto the targeter arm [40.5541]. Verify with the image intensifier the position of the holes in targeter slider and distal holes in trochanteric nail. The image intensifier should be positioned in such a way, that nail locking holes (*proximal or distal*) pictures on the screen are circles. Insert the protective guide 9.0/7.0 [40.5510.100] and the drill guide [40.5511.100] into the slider hole of Distal targeter D. Check with the X-Ray the position of the drill guide hole and the nail hole. The holes in the nail and drill guide must overlap. The circle image shall appear (*image close to circle is acceptable*) on the screen. If the image appeared on the screen is not a circle, settings of D targeter must be corrected. To do so, use the screw in the distal targeter D [40.5546] to move the slider (*turn the screw left or right*) until the circle appears on the screen (*image close to circle is acceptable*).

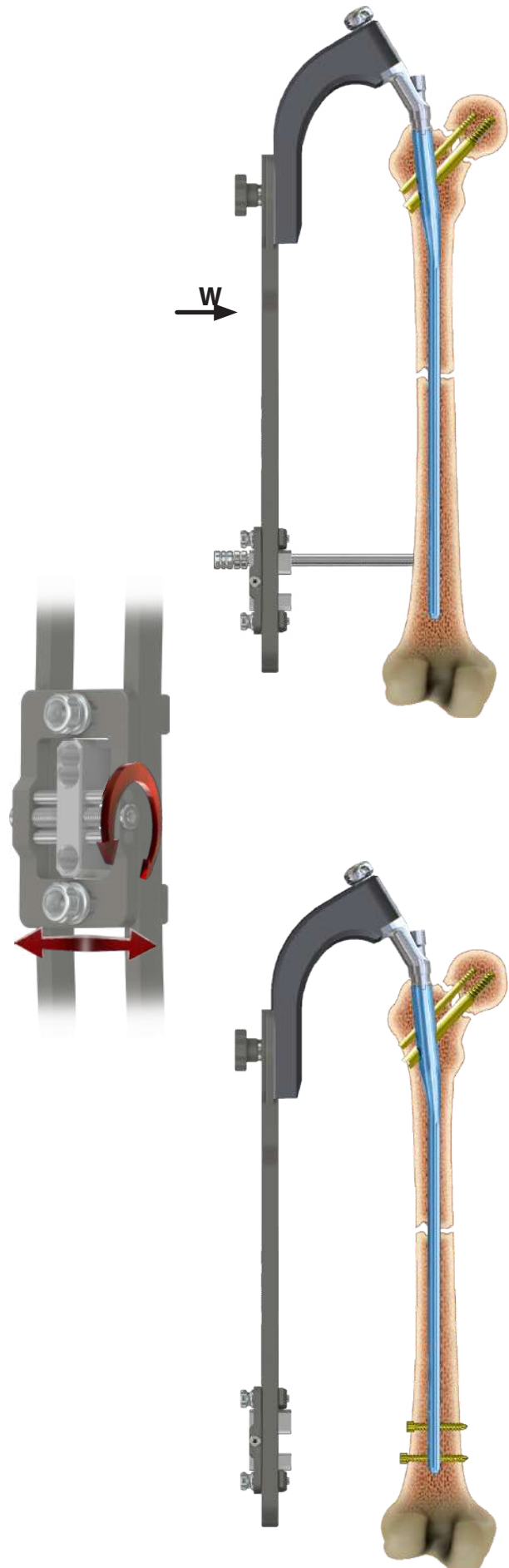
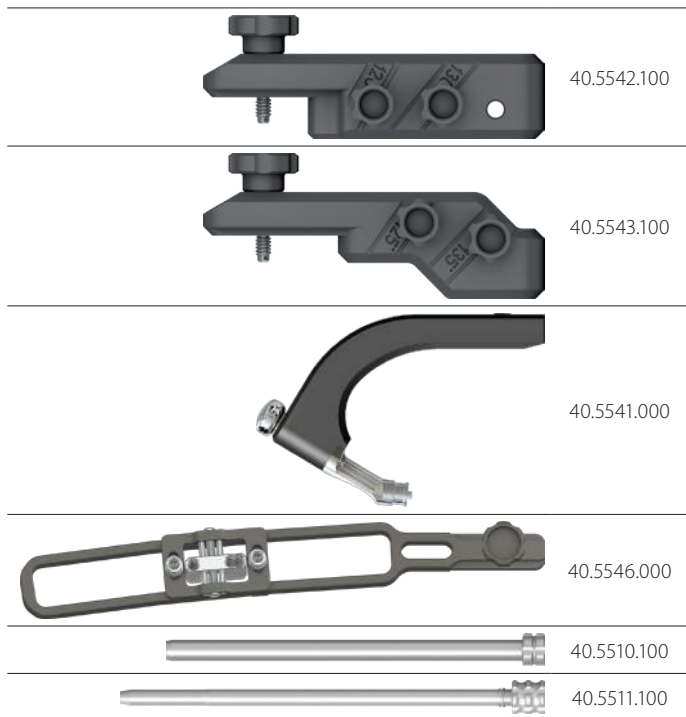

- 31** Remove the drill guide 7/3.5 [40.5511.100] out of the protective guide 9.0/7.0 [40.5510.100].



Locking the nail by the screws shall proceed in accordance with steps 22-29 presented on page 28.



- 32** Remove the connecting screw M12x1.75 L-34 [40.5547] from the nail using the wrench S10 [40.5526]. Dismount the targeter arm [40.5541] from the nail locked the medullary canal.

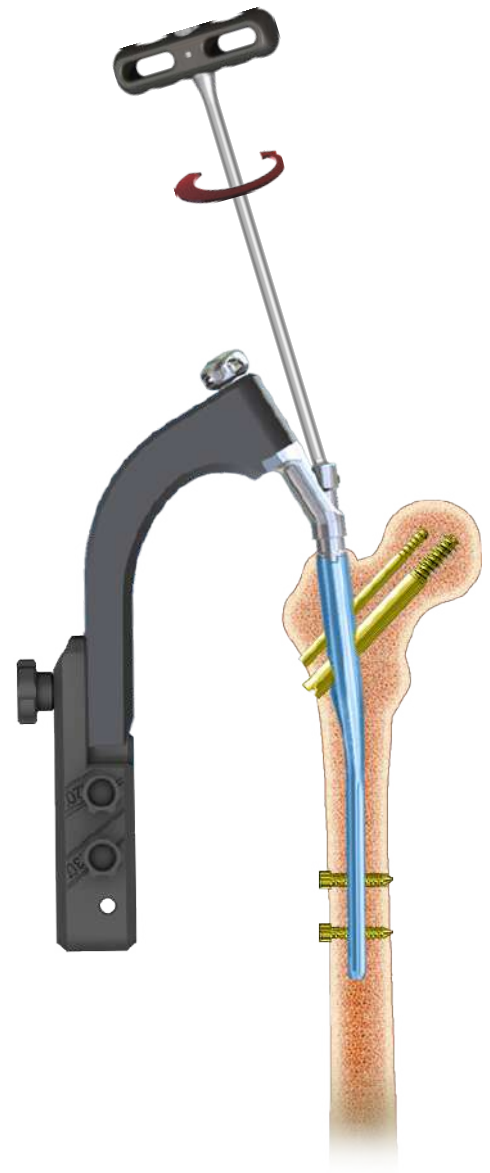
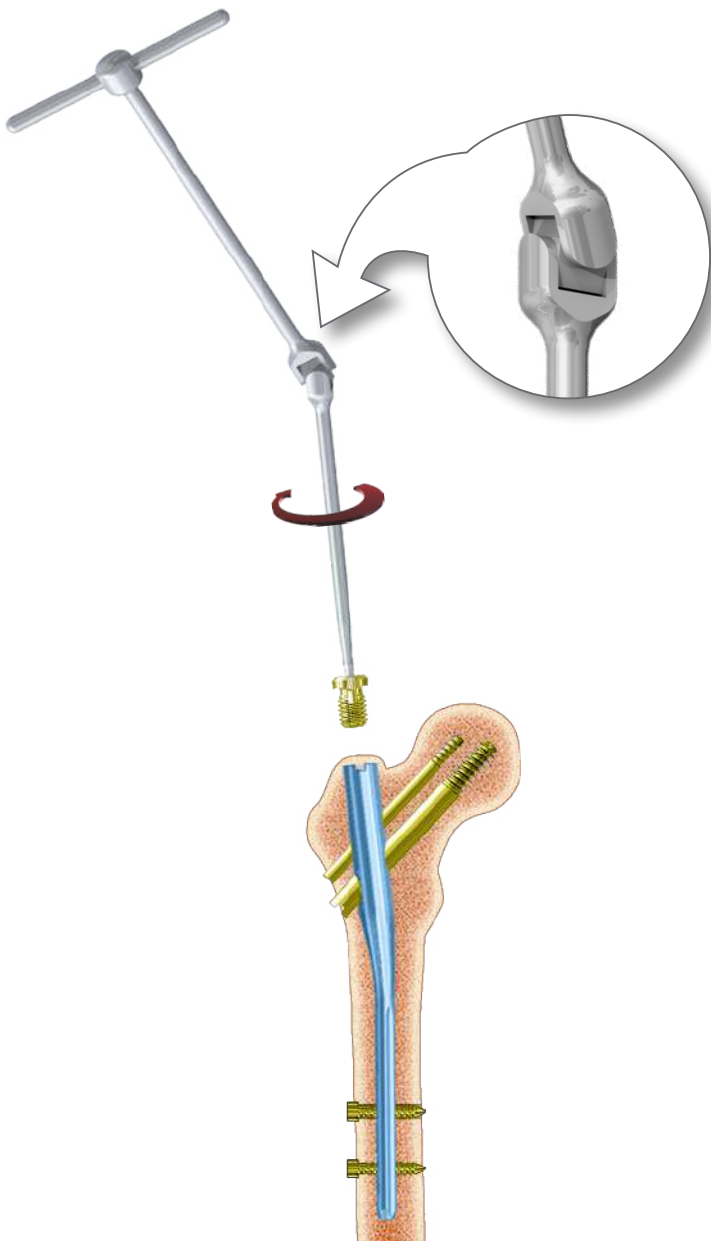

- 33** In order to secure the inner thread of the nail from bone ingrowth, insert the end cap [3.2104.600-615] implant using the wrench for self-aligning joint S4 [40.5540].

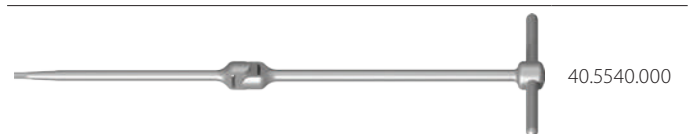



## III.9. THE NAIL EXTRACTION (LONG AND SHORT)

- 34 Using the wrench for self-aligning joint S4 [40.5540] remove the end cap, compression screw, join screw 6.5mm. Using the screwdriver S3.5 [40.5525.100] remove all locking screws. Insert the connector of extractor M12/1.75 [40.4731] into the threaded nail hole. Using compression wrench [40.5532.300], remove join screw 11mm. Insert the impactor-extractor [40.5507] onto the connector of extractor and remove the nail from the medullary canal using the mallet [40.3667].

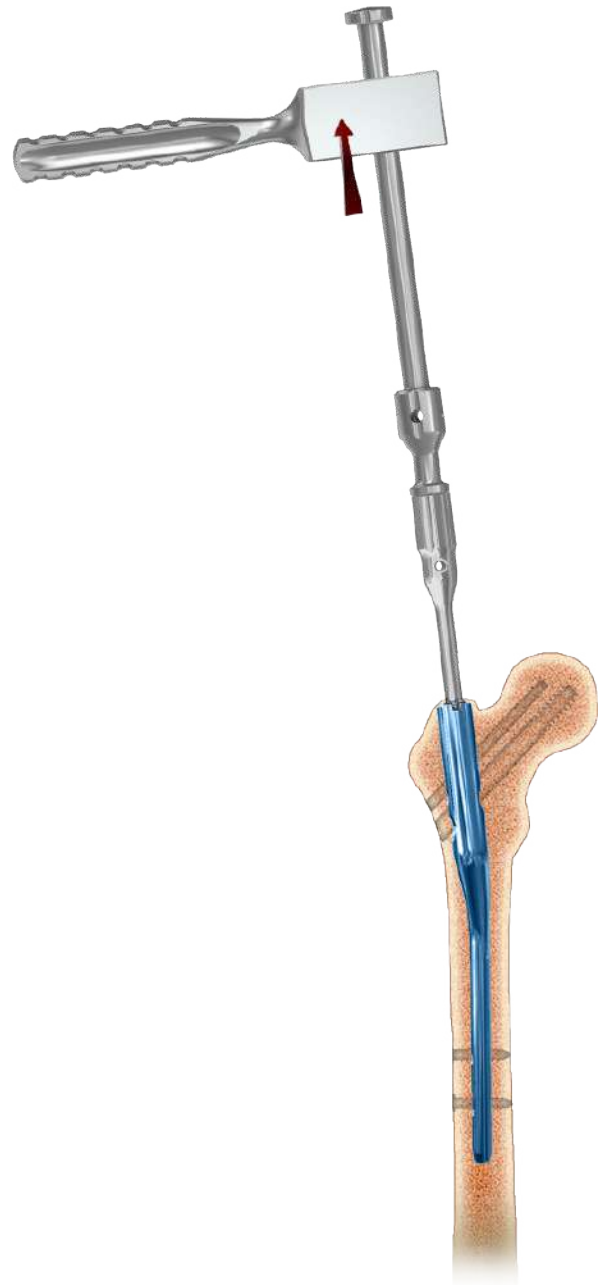
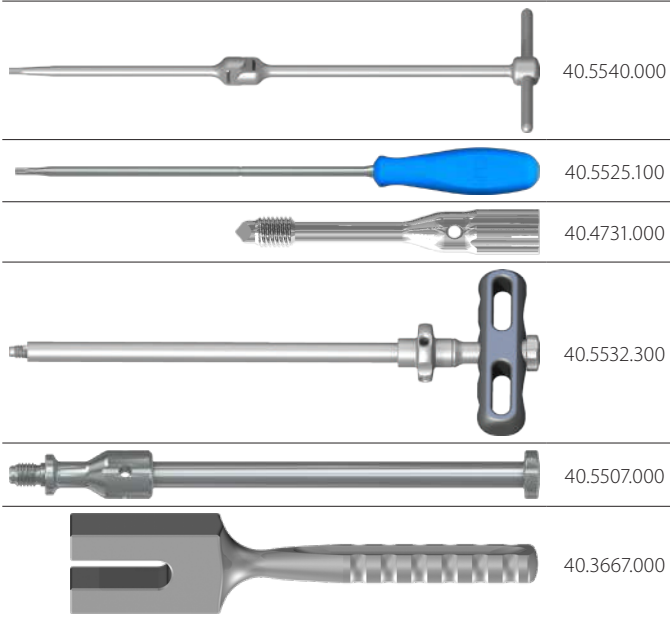

**ChM sp. z o.o.**

Lewickie 3b  
16-061 Juchnowiec Kościelny  
Poland

tel. +48 85 86 86 100

fax +48 85 86 86 101

chm@chm.eu

www.chm.eu



CE 0197