

## Scissors, acc. to Perwitschky

### Scissors, acc. to Perwitschky

for salivary duct, 10 cm total length

WT543010 Scissors, acc. to Perwitschky,  
for salivary duct, size 100

WT543011 Scissors, acc. to Perwitschky,  
sharp/sharp, for salivary duct,  
size 100

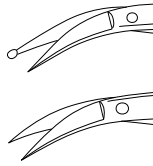
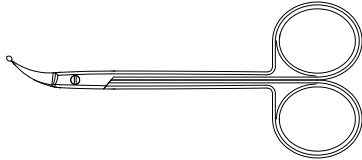

## Dilators

### Dilator, acc. to Ruedemann

for salivary duct, for infants,  
tip 0.5 mm, 8 cm total length

WT543300 Dilator, acc. to Ruedemann, for salivary duct,  
for children, size 0.5 x 80

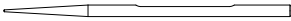

### Dilator, acc. to Wilde

4 mm diameter, 11 cm total length

WT543301 Dilator, acc. to Wilde, for salivary duct,  
size 1, 4 x 110



## Probes

### Probe, acc. to Bowman

silver plated,  
total length 13 cm

WT543430 Probe, acc. to Bowman,  
cylindrical, silver plated, size 000/0000

WT543400 Probe, acc. to Bowman,  
cylindrical, silver plated, size 00/0

WT543401 Probe, acc. to Bowman,  
cylindrical, silver plated, size 0/1

WT543402 Probe, acc. to Bowman,  
cylindrical, silver plated, size 1/2

WT543404 Probe, acc. to Bowman,  
cylindrical, silver plated, size 3/4

WT543406 Probe, acc. to Bowman,  
cylindrical, silver plated, size 5/6

WT543408 Probe, acc. to Bowman,  
cylindrical, silver plated, size 7/8



### Probe, acc. to Seiffert

extra delicate, silver, 18 cm total length

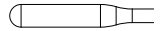

WT543518 Probe, acc. to Seiffert, silver, size 180



### Faulkner Antrum Curette

**Curette, acc. to Faulkner**

double ended, 21 cm total length,  
5.5 and 7.5 mm inner diameter



WT504000 Curette, acc. to Faulkner,  
double-ended, size 5.5/7.5 x 210

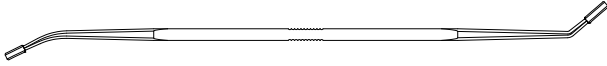

### Halle Antrum Curette

**Curette, acc. to Halle**

malleable,  
21 cm total length,  
various oval sizes (length, width, mm)

WT506001 Curette, acc. to Halle, malleable,  
size 8.0 x 5.5 210



WT506002 Curette, acc. to Halle, malleable,  
size 9.0 x 6.0 210



WT506003 Curette, acc. to Halle, malleable,  
size 10 x 7.0 210

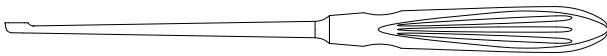
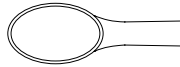

### Sinuscopy Trocars

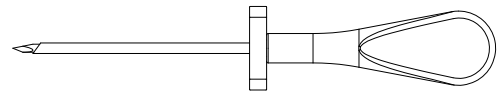

**Trocar**

for use with 2.7 mm telescopes,  
oblique beak,  
7 cm cannula length, 3.4 mm outer diameter

WT518503 Trocar, oblique, for endoscopes,  
size 2.7 x 70

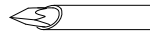

**Trocar**

for use with 3 mm telescopes,  
7 cm cannula length, 4 mm outer diameter

WT518504 Trocar, oblique, for endoscopes,  
size 3.0 x 70



**Trocar**

for use with 4 mm telescopes,  
5 mm outer diameter, 8 cm cannula length

WT518400 Trocar, beak-shaped,  
for endoscopes, size 4 x 80



WT518500 Trocar, oblique,  
for endoscopes, size 4 x 80



# PORTFOLIO OVERVIEW

## Telescopes for Larynx Surgery



### 4 mm OES ELITE Telescopes

<b>Telescope</b> WA2T400A	· Diameter: ..... 4 mm · Working length: ..... 280 mm · Direction of view: ..... 0°		
<b>Telescope</b> WA2T412A	· Diameter: ..... 4 mm · Working length: ..... 280 mm · Direction of view: ..... 12°		
<b>Telescope</b> WA2T430A	· Diameter: ..... 4 mm · Working length: ..... 282 mm · Direction of view: ..... 30°		
<b>Telescope</b> WA2T43WA	· Diameter: ..... 4 mm · Working length: ..... 283 mm · Direction of view: ..... 30° Wide angle		
<b>Telescope</b> WA2T470A	· Diameter: ..... 4 mm · Working length: ..... 284 mm · Direction of view: ..... 70°		



### 5 mm Telescopes

<b>Telescope</b> WA50372B	· Diameter: ..... 5.4 mm · Working length: ..... 299 mm · Direction of view: ..... 0°		
<b>Telescope</b> WA50373B	· Diameter: ..... 5.4 mm · Working length: ..... 299 mm · Direction of view: ..... 30°		
<b>Telescope</b> WA50374B	· Diameter: ..... 5.4 mm · Working length: ..... 299 mm · Direction of view: ..... 45°		

## Imaging Systems

<b>VISERA ELITE Light Source</b>	<b>CLV-S190</b> N3643950 	· Dimensions: ..... Width: 370 mm Height: 150 mm Depth: 474 mm · Weight: ..... 14.9 kg · Examination lamp: ..... xenon short-arc lamp, 300 W	
----------------------------------	---------------------------------	--	--

<b>VISERA ELITE Video System Center</b>	<b>OTV-S190</b> N3643860 	· Dimensions: ..... Width: 370 mm Height: 150 mm Depth: 474 mm · Weight: ..... 14.9 kg	
---	---------------------------------	---	--

<b>Trolley</b>	<b>WM-NP2</b> K10021613	· Mobile workstation	
----------------	----------------------------	----------------------	--

<b>Monitor</b>	<b>26" full HD OEV-262H</b> N5374360	· Full 10 bit (1.07billion color) display (10 bit LCD panel and 10 bit processing) · Advanced LCD panel with LED backlight · 26" full HD (instead of WUXGA), contrast 1400:1 (instead of 1000:1), luminance · 450cd/m <sup>2</sup> (instead of 400), 16:9 aspect ratio · A.I.M.E. (advanced image multiple enhancer) without compromising resolution	
----------------	---	--	--

<b>Video System Center</b>	<b>CV-170</b> 	· Deliver sharp and clear details, boosting observation capabilities when viewing mucosal structures and other vessel patterns. · Compatibility to NBI (see chapter xxxx) · All-in-one design condenses its performance into a compact and convenient size. · Long-life LED lamp minimizes lamp replacement and as a result maintenance is much easier. · Ensuring long hours of operation while reducing energy and noise.	
----------------------------	-------------------	---	--

E0497606	· CV-170 with ENF-V3
E0497607	· CV-170 with ENF-VH
E0497647	· CV-170 with ENF-VT2

## 4 mm ULTRA Sinusscopes

A Powerful Solution for Sinus Surgery



# 4 mm ULTRA Sinusscopes

## ED Glass Lenses – Razor-Sharp Images

High contrast at high spatial frequencies

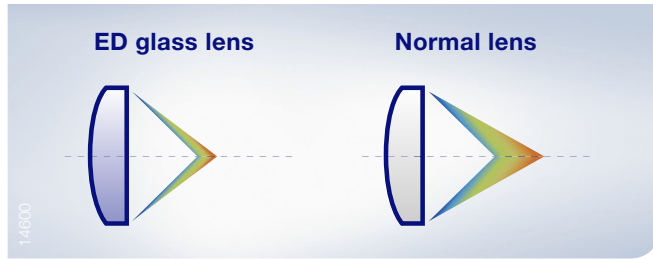

## Compatibility







Mechanical compatibility to current generations of camera heads and light guide cables by Olympus and other manufacturers that correspond to DIN 58105.

## Eco-Friendly/ Fully Autoclavable

Reduced waste due to full reusability of the sinusscopes.



## Ordering Information

Order Number	Outer Diameter	Direction of View (DOV)	
WA4KS400	4 mm	0°	 15379
WA4KS430	4 mm	30°	 15378
WA4KS431	4 mm	30° inverse	 15382
WA4KS445	4 mm	45°	 15366
WA4KS446	4 mm	45° inverse	 15367
WA4KS470	4 mm	70°	 15821
WA4KS471	4 mm	70° inverse	 15372

All products come with an approximate working length of 177 mm and have a maximal insertions portion width of 4.05 mm.

## Specifications

<b>Operating Conditions</b>	Ambient temperature	10 to 35°C (50 to 95°F)
	Relative humidity	30 to 85%
	Atmospheric pressure	700 to 1060 hPa
<b>Storage Conditions</b>	Temperature	10 to 40°C (50 to 104°F)
	Relative humidity	30 to 85%
<b>Transport Conditions</b>	Temperature	-40 to 70°C (-40 to 158°F)
	Relative humidity	10 to 95%

Specifications, design, and accessories are subject to change without any notice or obligation on the part of the manufacturer.



**OLYMPUS EUROPA SE & CO. KG**  
 Postbox 10 49 08, 20034 Hamburg, Germany  
 Wendenstrasse 14-18, 20097 Hamburg, Germany  
 Phone: +49 40 23773-0, Fax: +49 40 233765  
 www.olympus-europa.com



## Basic Set

**Nasal speculum, acc. to Hartmann**  
14 cm total length, 34 mm blade length

WT143001 Nasal speculum, acc. to Hartmann,  
for adults, size 33.5 x 135

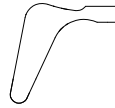
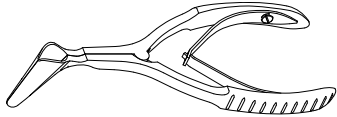

**Nasal speculum, acc. to Killian-Struycken**  
14 cm total length, various blade length (mm)

WT142255 Nasal speculum, acc. to Killian-Struycken,  
size 55 x 140

WT142290 Nasal speculum, acc. to Killian-Struycken,  
size 90 x 140

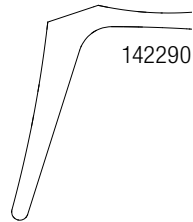
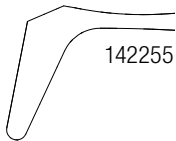
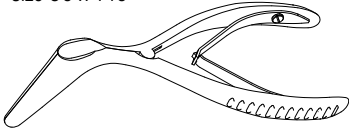

**Nasal speculum, acc. to Cottle**  
13,5 cm total length, with set screw,  
55 mm blade length

WT400002 Nasal speculum, acc. to Cottle, size 50 x 135

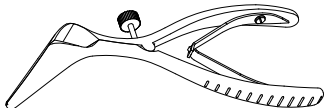

**Elevator, acc. to Freer**  
20 cm, double-ended, 20 cm total length,  
USA model, sharp/blunt, 4.5 mm width

WT315000 Elevator, acc. to Freer,  
double-ended, american type, size 200

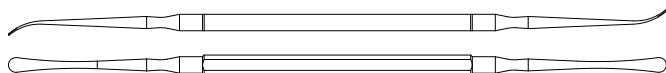

## Basic Set (cont.)

**Probe, acc. to Bowman**  
silver plated,  
total length 13 cm

WT543430 Probe, acc. to Bowman, cylindrical,  
silver plated, size 000/0000

WT543400 Probe, acc. to Bowman, cylindrical,  
silver plated, size 00/0

WT543402 Probe, acc. to Bowman, cylindrical,  
silver plated, size 1/2

WT543404 Probe, acc. to Bowman, cylindrical,  
silver plated, size 3/4



**Punch forceps, acc. to Moriyama**  
through-cutting, 4.5 mm jaw width,  
10.5 cm working length

WT326810 Punch forceps, acc. to Moriyama, through-cutting,  
straight, size 105

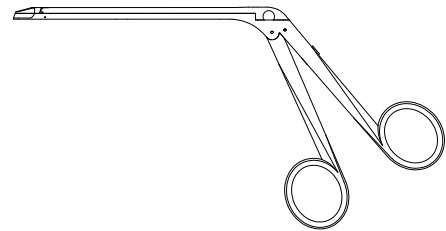
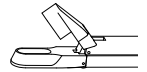

**Punch forceps, acc. to Kerrison**  
bite 2 mm, 40° upbiting,  
18 cm working length, detachable

WT512922 Punch forceps, acc. to Kerrison, 40 cutting upward,  
detachable, size 2.0 x 180

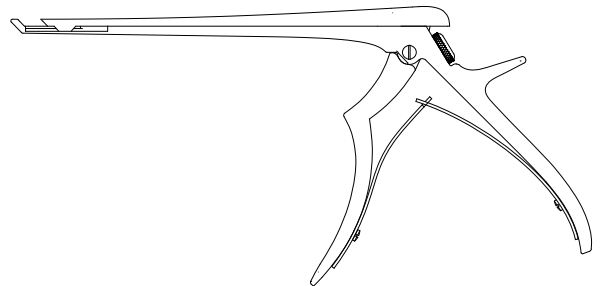

## Cutting Forceps, Double-Action Jaws

### Cutting forceps

round cupped jaws 5 mm diameter, double-action, straight, 23 cm working length

WT632046 Laryngeal forceps, cupped jaws, heavy design, straight, size 230

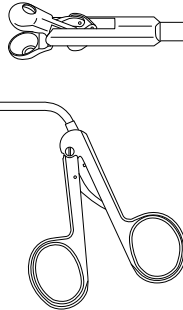

## Cutting Forceps

### Forceps

2 mm cupped jaws, standard, 23 cm working length

WT632001 Laryngeal forceps, cupped jaws, straight, size 2 x 23



WT632002 Laryngeal forceps, cupped jaws, curved up, size 2 x 23

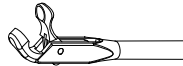

WT632003 Laryngeal forceps, cupped jaws, curved to right, size 2 x 23

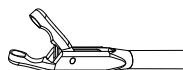

WT632004 Laryngeal forceps, cupped jaws, curved to left, size 2 x 23

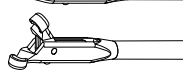

WT632050 Laryngeal forceps, cupped jaws, curved up to right, size 2 x 23 (not shown)

WT632051 Laryngeal forceps, cupped jaws, curved up to left, size 2 x 23

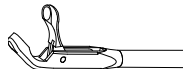

WT632052 Laryngeal forceps, cupped jaws, horizontal opening, curved up right, size 2 x 23



WT632053 Laryngeal forceps, cupped jaws, horizontal opening, curved up left, size 2 x 23



## Cutting Forceps (2)

### Cutting forceps

long oval cupped jaws, 23 cm working length

WT632150 Laryngeal forceps, oval cups, curved up, opening upward, size 2 x 23

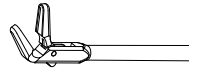

WT632151 Laryngeal forceps, oval cups, curved up, opening to the right, size 230

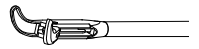

WT632152 Laryngeal forceps, oval cups, curved up, opening to the left, size 230

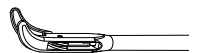

### Cutting forceps

oval cupped jaws 3 x 5 mm, heavy, conical shaft, 23 cm working length, straight

WT632040 Laryngeal forceps, oval cups, for biopsies, straight, size 230

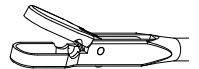

### Cutting forceps

round cupped jaws 4 mm diameter, heavy, conical shaft, 23 cm working length

WT632041 Laryngeal forceps, cupped jaws, heavy design, straight, size 4 x 23

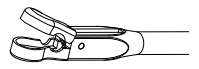

WT632042 Laryngeal forceps, cupped jaws, heavy design, curved up, size 4 x 23

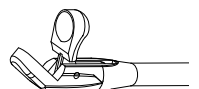

WT632043 Laryngeal forceps, cupped jaws, heavy design, curved right, size 4 x 23

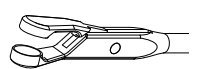

WT632044 Laryngeal forceps, cupped jaws, heavy design, curved left, size 4 x 23

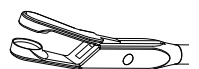



## Laryngeal Scissors for Adults



### Laryngeal scissors

standard model, conical shaft,  
23 cm working length

- WT632008 Laryngeal scissors, micro, straight, size 230
- WT632009 Laryngeal scissors, micro, curved up, size 230
- WT632115 Laryngeal scissors, micro, curved up 15, size 230
- WT632010 Laryngeal scissors, micro, curved to right, size 230
- WT632011 Laryngeal scissors, micro, curved to left, size 230
- WT632057 Laryngeal scissors, micro, horizontal cutting, straight, size 230

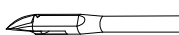
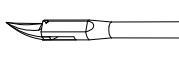
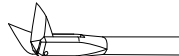
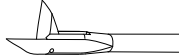

### Miniature scissors

very delicate, conical shaft,  
23 cm working length

- WT632080 Laryngeal scissors, miniature, straight, size 230
- WT632081 Laryngeal scissors, miniature, curved up 45, size 230
- WT632082 Laryngeal scissors, miniature, curved to right, size 230
- WT632083 Laryngeal scissors, miniature, curved to left, size 230

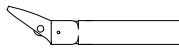
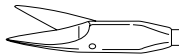

### Scissors

23 cm working length

- WT632108 Laryngeal scissors, sheath curved up, straight, size 230
- WT632109 Laryngeal scissors, sheath curved up, curved up 45, size 230
- WT632110 Laryngeal scissors, sheath curved up, curved to right, size 230
- WT632111 Laryngeal scissors, sheath curved up, curved to left, size 230

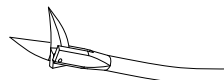
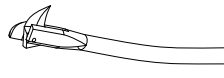
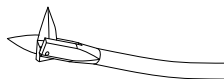

## Pediatric Laryngeal Scissors

### Laryngeal scissors

working length 18 cm

- WT631920 Laryngeal scissors, micro, straight, size 180
- WT631921 Laryngeal scissors, micro, curved up 45, size 180
- WT631922 Laryngeal scissors, micro, curved to right, size 180
- WT631923 Laryngeal scissors, micro, curved to left, size 180
- WT632012 Laryngeal scissors, curved up, size 230

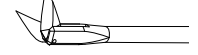
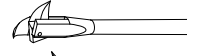
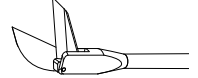
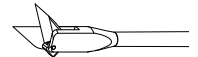



## Laryngeal Knives

### Round knife

2.5 mm diameter, angled 45°,  
23 cm working length

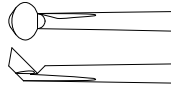

WT632013 Round knife, angled 45,  
size 2.5 x 230

### Round knife

round, vertical cutting,  
23 cm working length



WT632014 Round knife, vertical cutting,  
size 230

### Knife

oval, straight,  
23 cm working length

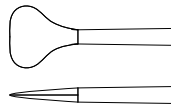

WT632015 Knife, oval, straight, size 230

### Sickle knife

straight cutting,  
23 cm working length

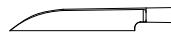

WT632016 Sickle knife, pointed, straight,  
size 230

WT632116 Sickle knife, pointed, curved,  
size 230



### Knife

golf club shaped,  
23 cm working length

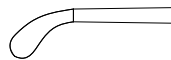

WT632017 Knife, golfstick shape, size 230

### Laryngeal knife

lancet shape, 33 cm working length



WT637570 Laryngeal knife, lancet shape,  
with grip plate, size 330

## Laryngeal Hooks

### Hook

23 cm working length

WT632018 Hook, with ball end, blunt,  
size 230

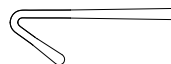

WT632019 Hook, sharp,  
size 230



WT632024 Hook, with ball end,  
angled 90, size 230



## Laryngeal Needles

### Needle

curved to right, 23 cm working length

WT632020 Needle, curved right,  
size 230

WT632021 Needle, curved left, size 250

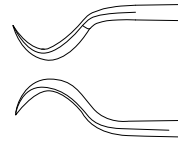

## Laryngeal Elevator, Knot Tier

### Elevator

22 cm working length

WT637560 Elevator, curved right, size 220

WT637561 Elevator, curved left, size 220

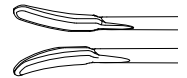

### Elevator

23 cm working length

WT632022 Elevator, with suction channel,  
size 230

WT632049 Elevator, curved, size 230

WT637710 Elevator, curved right 90, size 220

WT637711 Elevator, curved left 90, size 220

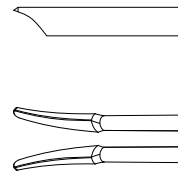

### Knot pusher

23 cm working length

WT632023 Knot pusher, size 230

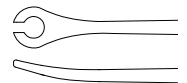

## Handles for Micro-Laryngeal Instruments

### Handle

WT632025 Handle, for WT632013-WT632116

WT000805 Spare screw, for handle (not shown)

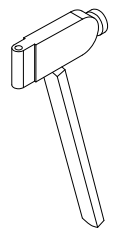

WT264100 Handle, acc. to Heermann,  
black, for Heermann gouges/  
micro larynx instruments

WT000804 Spare screw,  
for handle acc. to Heermann (not shown)

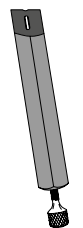

WT840212 Handle, round,  
for endoscopes, size 4.0



**Trokare** | Trocars  
**Trocars** | Trócares  
 Trocar

**Trokarhülse mit Automatik-Ventil, manueller Klappenöffnung und Hahn**  
*Trocar sheath with multifunctional valve and stopcock*

Gainé de trocart avec valve automatique, ouverture manuelle et robinet  
*Vaina de trócar con valvula automatica, apertura manual y robinete*  
 Camicia con valvola automatica con leva apriporta e rubinetto

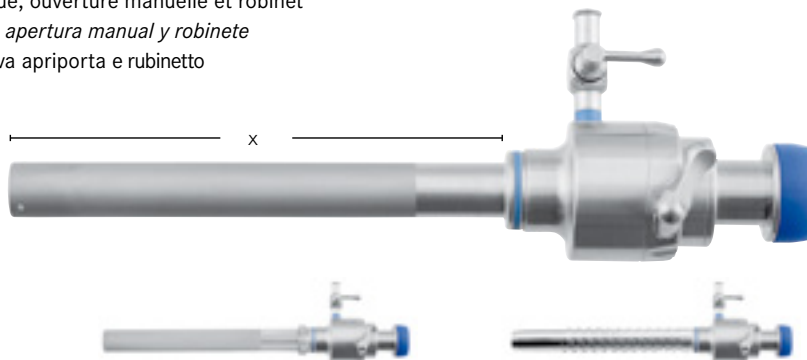

**SLIMSLI**

Ø 5.5 mm ○	x = 103 mm	<b>tk 704-360</b>	<b>tk 704-670</b>
Ø 11.0 mm ●	x = 105 mm	<b>tk 704-365</b>	<b>tk 704-673</b>
Ø 13.0 mm ●	x = 102 mm	<b>tk 704-295</b>	<b>tk 704-676</b>

Metallrohr, glatt  
*Metal tube, smooth*  
 Tube metalique, lisse  
*Tubo de metal, lisa*  
 Tubo metallico, liscio

Metallrohr mit Gewinde  
*Metal tube, threaded*  
 Tube metallique avec filetage  
*Tubo de metal con rosca*  
 Tubo metallico con filetto



**SLIMSLI**

Ø 5.5 mm ○	x = 95 mm	<b>tk 704-671</b>	<b>tk 704-672</b>
Ø 11.0 mm ●	x = 97 mm	<b>tk 704-674</b>	<b>tk 704-675</b>
Ø 13.0 mm ●	x = 94 mm	<b>tk 704-677</b>	<b>tk 704-678</b>

Kunststoffrohr, glatt  
*Plastic tube, smooth*  
 Tube plastique, lisse  
*Tubo plastico, lisa*  
 Tubo di plastica, liscia

Kunststoffrohr mit Gewinde  
*Plastic tube, threaded*  
 Tube plastique avec filetage  
*Tubo de plastico con rosca*  
 Tubo di plastica con filetto



**SLIMSLI-XL**

Ø 5.5 mm ○	x = 150 mm	<b>tk 704-4002-15</b>
Ø 11.0 mm ●	x = 150 mm	<b>tk 704-4010-15</b>
Ø 13.0 mm ●	x = 150 mm	<b>tk 704-4012-15</b>

Metallrohr, glatt  
*Metal tube, smooth*  
 Tube metalique, lisse  
*Tubo de metal, lisa*  
 Tubo metallico, liscio

Trokare | Trocarts  
 Trocars | Trócares  
 Trocar

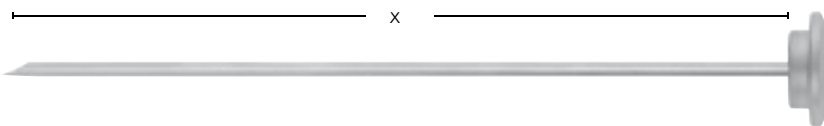

Ø 2.8 mm	x = 108 mm	x = 148 mm
	<b>tk 730-171</b>	<b>tk 730-161</b>
	<b>tk 730-172</b>	<b>tk 730-162</b>

für tk 730-170  
 for tk 730-170  
 pour tk 730-170  
 para tk 730-170  
 per tk 730-170

für tk 730-160  
 for tk 730-160  
 pour tk 730-160  
 para tk 730-160  
 per tk 730-160



Ø 3.5 mm		<b>tk 704-070</b>	<b>tk 730-220</b>	<b>tk 704-072</b>
Ø 5.5 mm		<b>tk 704-016</b>	<b>tk 704-022</b>	<b>tk 704-031</b>
Ø 7.0 mm		<b>tk 704-014</b>	<b>tk 704-018</b>	-
Ø 10.0 mm		-	-	<b>tk 704-033</b>
Ø 11.0 mm		<b>tk 704-006</b>	<b>tk 704-026</b>	<b>tk 704-035</b>
Ø 12.5 mm		-	-	<b>tk 704-036</b>
Ø 13.0 mm		<b>tk 704-093</b>	<b>tk 704-092</b>	-
Ø 15.0 mm		<b>tk 704-015</b>	<b>tk 704-028</b>	-
Ø 20.0 mm		<b>tk 704-020</b>	<b>tk 704-029</b>	-

Ø 5.5 mm		<b>tk 704-016-15</b>	<b>tk 704-022-15</b>	-
Ø 11.0 mm		<b>tk 704-006-15</b>	<b>tk 704-026-15</b>	-
Ø 13.0 mm		<b>tk 704-012-15</b>	<b>tk 704-027-15</b>	-

Für Trokar-System  
 For trocar system  
 Pour système trocar  
 Para el sistema de trócares  
 Sistema per trocar

Trokar (dreikant)  
 Trocar (pyramidal)  
 Trocart (pyramidal)  
 Trócar (piramidal)  
 Trocar (piramidale)

Trokar (Kegelform)  
 Trokar (conical tip)  
 Trocart (conique)  
 Trócar (conico)  
 Trocar (conico)

Trokar (stumpf)  
 Trocar (blunt)  
 Trocart (mousse)  
 Trócar (romo)  
 Trocar (smusso)

Zubehör für Trokare  
Accessories for trocars

Accessoires pour trocars  
Accesorios para trócares  
Accessorio per trocar



Ø 3.5 mm	<b>tk 704-395 K</b>
Ø 5.5 mm	<b>tk 704-397 K</b>
Ø 10.0 mm	<b>tk 704-398 K</b>
Ø 11.0 mm	<b>tk 704-399 K</b>
Ø 12.5 mm	<b>tk 704-389 K</b>
Ø 13.0 mm	<b>tk 704-390 K</b>

Ø Trokar **Hassonkonus fixierbar mit Fadenhaltern**  
 Ø Trocar **Hassoncone fixable with suture holder**  
 Ø Trocart **Conus de Hasson à fixer, avec porte-fils**  
 Ø Trócar **Cono de Hasson fijable, con porta suturas**  
 Ø Trocar **Cono di Hasson con levette porta sutura**



Ø 3.5 mm	<b>tk 704-0022</b>	●
Ø 5.5 mm	<b>tk 704-0023</b>	●
Ø 10.0 mm	<b>tk 704-0024</b>	●
Ø 11.0 mm	<b>tk 704-0025</b>	●
Ø 12.5 mm	<b>tk 704-0026</b>	●
Ø 13.0 mm	<b>tk 704-0027</b>	●

Ø Trokar **Dichtkappe (Farbe), Pack mit 10 Stück**  
 Ø Trocar **Sealing cap (colour), pack of 10 pieces**  
 Ø Trocart **Capuchon (couleur), paquet de 10 pièces**  
 Ø Trócar **Capuchón (color), paquetes de 10 piezas**  
 Ø Trocar **Cappuccio (colore), conf. da 10 pezzi**



Ø 10.0 mm	Ø 5.5 mm	<b>tk 704-235</b>
Ø 11.0 mm	Ø 5.5 mm	
Ø 11.0 mm	Ø 10.0 mm	
Ø 12.5 mm	Ø 5.5 mm	
Ø 13.0 mm	Ø 5.5 mm	
Ø 12.5 mm	Ø 10.0 mm	<b>tk 704-238</b>
Ø 13.0 mm	Ø 10.0 mm	

Ø Trokar **Schiebereducierer verwendbar für alle TEKNO Automatiktrocarhülsen**  
 Ø Trocar **Reduction piece for all TEKNO automatic trocars**  
 Ø Trocart **Réducteur pour tous les trocars automatiques de TEKNO**  
 Ø Trócar **Reductor para todos trócares automaticos de TEKNO**  
 Ø Trocar **Riduttore per tutti trocar automatici TEKNO**

Glasfaser-Kaltlichtkabel  
*Fiberoptic cables*

Cables de lumière froide  
*Cables de fibra óptica*  
Cavi luce in fibra ottica

autoclavable  
134°C / 273°F



			Xenon / LED	Xenon (TEKNO/Storz)	LED (TEKNO-Wolf)
< Ø 5mm	Ø 3.5 mm	1800 mm	<b>tk 39522-18</b>	<b>tk 39532-18</b>	<b>tk 39560-18</b>
	Ø 3.5 mm	2300 mm	<b>tk 39522-23</b>	<b>tk 39532-23</b>	<b>tk 39560-23</b>
	Ø 3.5 mm	3000 mm	<b>tk 39522-30</b>	<b>tk 39532-30</b>	<b>tk 39560-30</b>
≥ Ø 5mm	Ø 4.8 mm	1800 mm	<b>tk 39523-18</b>	<b>tk 39533-18</b>	<b>tk 39561-18</b>
	Ø 4.8 mm	2300 mm	<b>tk 39523-23</b>	<b>tk 39533-23</b>	<b>tk 39561-23</b>
	Ø 4.8 mm	3000 mm	<b>tk 39523-30</b>	<b>tk 39533-30</b>	<b>tk 39561-30</b>
für Optiken <i>for scopes</i>	Faserbündel <i>Fiber bundle</i>	Länge <i>Length</i>	Kabel ohne Adapter <i>Cable without adapters</i>	komplett mit 2 Adaptern <i>complete with 2 adapters</i>	komplett mit 2 Adaptern <i>complete with 2 adapters</i>

- Speziell für XENON & LED-Lichtquellen

Unsere Hochleistungs-Kaltlichtkabel werden durch ein Spezialverfahren am Lichteintritt komprimiert und können so mehr Licht transportieren. Sie sind speziell für hochenergetische Xenon & LED-Lichtquellen geeignet!

- adaptierbar an alle gängigen Systeme mittels Adapter

- Especially for XENON & LED light sources

Our high density fiber optic cables are specially prepared at the light entrance for transporting more light. They are suited for high energy XENON & LED light sources.

- suitable for all common systems with adapter



**Adapter  
Adapters** | Adaptateurs  
Adaptadores  
Adattatori

Projektor-Seite  
Projector-side

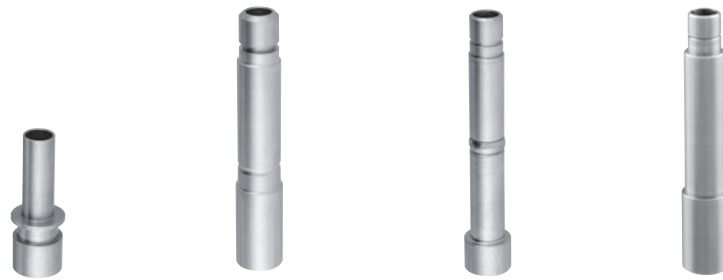

<b>tk 39525-00</b>	<b>tk 39528-00</b>	<b>tk 39527-00</b>	<b>tk 39530-00</b>
TEKNO Storz Aesculap	Wolf HSW Dyonics Medicon Comeg Linvatec TEKNO-LED	Olympus	ACMI Stryker

Endoskop-Seite  
Endoscope-side



<b>tk 39525-10</b>	<b>tk 39528-20</b>	<b>tk 39530-10</b>
TEKNO Storz Aesculap Olympus	Wolf HSW Dyonics Medicon Comeg Stryker	ACMI Linvatec



Weitere Adapter auf Anfrage erhältlich  
Further adapters available on request



**EC Certificate**  
**Directive 93/42/EEC Annex II, excluding Section 4**  
**Full Quality Assurance System**  
**Medical Devices**

**Registration No.:** HD 60123878 0001

**Report No.:** 12018179 022

**Manufacturer:** OLYMPUS MEDICAL SYSTEMS CORP.  
2951 Ishikawa-cho,  
Hachioji-shi, Tokyo 192-8507  
Japan

**Products:** Design and Development, Manufacture of Medical Endoscopy  
Systems, Diagnostic, Operation and Treatment Products  
  
(see attachments for products and additional sites included)  
  
Replaces Approval, Registration No.: HD 60078827 0001

**Expiry Date:** 2022-11-02

The Notified Body hereby declares that the requirements of Annex II, excluding section 4 of the directive 93/42/EEC have been met for the listed products. The above named manufacturer has established and applies a quality assurance system, which is subject to periodic surveillance, defined by Annex II, section 5 of the aforementioned directive. For placing on the market of class III devices covered by this certificate an EC design-examination certificate according to Annex II, section 4 is required.

**Effective Date:** 2017-11-03

**Date:** 2017-10-12



Notified Body

M.Sc. M. Aihara

**TÜV Rheinland LGA Products GmbH - Tillystraße 2 - 90431 Nürnberg**

TÜV Rheinland LGA Products GmbH is a Notified Body according to Directive 93/42/EEC concerning medical devices with the identification number 0197.



**TÜV Rheinland**  
**LGA Products GmbH**  
**Tillystraße 2, 90431 Nürnberg**

**Attachment to  
Certificate**

**Registration No.:** HD 60123878 0001

**Report No.:** 12018179 022

**Manufacturer:** OLYMPUS MEDICAL SYSTEMS CORP.  
2951 Ishikawa-cho,  
Hachioji-shi, Tokyo 192-8507  
Japan

Products included:

Medical Endoscopy Systems:

- Endoscopes
- Endotherapy Devices
- Imaging Processors
- Pumps for Endoscopy
- Light Sources
- Position Detecting Units
- Electrothermal Cautery Units
- Integrated Endosurgery Systems
- Endoscopic Regulation/Control Units

Electrosurgical Equipment

Probes and Transducers for Ultrasonic Lithotriptors

Laparoscopic Insufflators

Ultrasound Surgical Equipment

Disinfecting Units

Capsule Endoscopes and Systems

Ultrasound Diagnostic Imaging Systems



Notified Body

*M. Aihara*  
M.Sc. M. Aihara

**Date:** 2017-10-12

Traducere din limba engleza



**APROBARE**  
**Directiva CE 93/42/CEE Anexa II, excluzând Secțiunea 4**  
**Sistem complet de asigurare a calității**  
**Echipeamente medicale**

Nr. Înregistrare: HD 60123878 0001  
Nr. Raport: 12018179 022

**Producător:** Olympus Medical Systems Corp.  
2951 Ishikawa-cho  
HACHIOJI-SHI, TOKIO 192-8507  
JAPONIA

**Produse:** Proiectare și dezvoltare, producție de sisteme de endoscopie medicală, produse de diagnostic, operație și tratament.  
(a se vedea atasamentele pentru produse și locații suplimentare incluse)  
Înlocuiește Aprobarea cu nr. de înregistrare: HD 60078827 0001

Data expirării: 02.11.2022

Organismul Notificat declară prin prezenta că au fost îndeplinite cerințele Anexei II, excluzând secțiunea 4 a directivei 93/42/CEE pentru produsele specificate. Producătorul mai sus menționat a stabilit și aplică un sistem de asigurare a calității, care este supus unei supravegheri periodice, definită în Anexa II, secțiunea 5 a directivei menționate anterior. Pentru comercializarea echipamentelor din clasa III acoperite de acest certificat, este necesar un certificat CE de examinare proiectare în conformitate cu Anexa II, secțiunea 4.

Data intrării în vigoare: 03-11-2017

Data: 12.10.2017

Organism notificat  
Ștampilă:  
TUV Rheinland LGA Products GmbH  
Zertifizierungsstelle  
M.Sc. M. Aihara  
(semnătură indescifrabilă)

**TÜV Rheinland LGA Products GmbH – Tillystraße 2 – 90431 Nürnberg**  
TÜV Rheinland LGA Products GmbH este un Organism Notificat în conformitate cu Directiva  
93/42/CEE cu privire la echipamentele medicale, cu numărul de identificare 0197

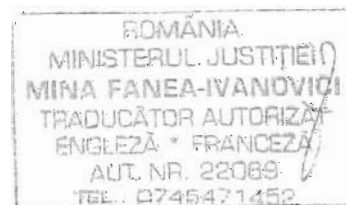

TÜV Rheinland  
LGA Products GmbH  
Tillystraße 2, 90431 Nürnberg

Atasament la  
Certificat

Nr. de înregistrare: HD 60123878 0001  
Nr. raport: 12018179 022

**Producător:** Olympus Medical Systems Corp.  
2951 Ishikawa-cho  
HACHIOJI-SHI, TOKIO 192-8507  
JAPONIA

Produse incluse:

- Sisteme medicale de endoscopie:
  - Endoscoape
  - Echipamente endoterapie
  - Procesoare de imagine
  - Pompe pentru endoscopie
  - Surse de lumină
  - Unități de detectare poziție
  - Unități de cauterizare electrotermică
  - Sisteme endochirurgicale integrate
  - Unitati de control/reglare endoscopice
- Echipamente electrochirurgicale
- Sonde și traductoare pentru litotriptoare cu ultrasunete
- Insuflatoare laparoscopice
- Echipamente chirurgicale cu ultrasunete
- Unitati de sterilizare
- Sisteme și endoscoape capsulă
- Sisteme de imagistica pentru diagnostic cu ultrasunete

Data: 12.10.2012

Organism notificat  
Ștampilă:  
TUV Rheinland LGA Products GmbH  
Zertifizierungsstelle  
M.Sc. M. Aihara  
(semnătură indescifrabilă)





**EC Certificate**  
**Directive 93/42/EEC Annex V**  
**Production Quality Assurance**  
**Medical Devices**

**Registration No.:** DD 60123877 0001

**Report No.:** 12018179 022

**Manufacturer:** OLYMPUS MEDICAL SYSTEMS CORP.  
2951 Ishikawa-cho,  
Hachioji-shi, Tokyo 192-8507  
Japan

**Products:** Sterile Endotherapy Devices used in conjunction with Endoscopes, Sterile Non Active Instruments used in conjunction with Endoscopes and Sterile Non Active Instruments used in conjunction with Medical Ultrasound Diagnostic Imaging Systems  
Replaces Approval, Registration No.: DD 60116725 0001

**Expiry Date:** 2022-11-02

The Notified Body hereby declares that the requirements of Annex V of the directive 93/42/EEC have been met for the listed products. The above named manufacturer has established and applies a quality assurance system, which is subject to periodic surveillance, defined by Annex V, section 4 of the aforementioned directive. For placing on the market of class IIb and class III devices covered by this certificate an EC type-examination certificate according to Annex III is required.

**Effective Date:** 2017-11-03

**Date:** 2017-10-12



Notified Body

M.Sc. M. Aihara

**TÜV Rheinland LGA Products GmbH - Tillystraße 2 - 90431 Nürnberg**

TÜV Rheinland LGA Products GmbH is a Notified Body according to Directive 93/42/EEC concerning medical devices with the identification number 0197.

Traducere din limba engleza



**CERTIFICAT CE**  
**Directiva CE 93/42/CEE Anexa V**  
**Asigurarea calității producției**  
**Echipamente medicale**

Nr. Înregistrare: DD 60123877 0001  
Nr. Raport: 12018179 022

**Producător:** Olympus Medical Systems Corp.  
2951 Ishikawa-cho  
HACHIOJI-SHI, TOKIO 192-8507  
JAPONIA

**Produse:** Echipamentelor sterile pentru endoterapie, utilizate împreună cu endoscoape, instrumente sterile non-active utilizate împreună cu endoscoape și instrumente sterile non-active utilizate împreună cu sisteme medicale de imagistică diagnostic cu ultrasunete.  
Înlocuiește Aprobarea. nr. înregistrare: DD 60116725 0001

Data expirării: 02.11.2022

Organismul Notificat declară prin prezenta că au fost îndeplinite cerințele Anexei V a directivei 93/42/CEE pentru produsele specificate. Producătorul mai sus menționat a stabilit și aplică un sistem de asigurare a calității, care este supus unei supravegheri periodice, definită în Anexa V, secțiunea 4 a directivei menționate anterior. Pentru comercializarea echipamentelor din clasa IIb și clasa III acoperite de acest certificat, este necesar un certificat CE de examinare tip în conformitate cu Anexa III.

Data intrării în vigoare: 03-11-2017

Data: 12.10.2017

Organism notificat  
Ștampilă:  
TUV Rheinland LGA Products GmbH  
Zertifizierungsstelle  
M.Sc. M. Aihara  
(semnătură indescifrabilă)

**TÜV Rheinland LGA Products GmbH – Tillystraße 2 – 90431 Nürnberg**  
TÜV Rheinland LGA Products GmbH este un Organism Notificat în conformitate cu Directiva 93/42/CEE cu privire la echipamentele medicale, cu numărul de identificare 0197

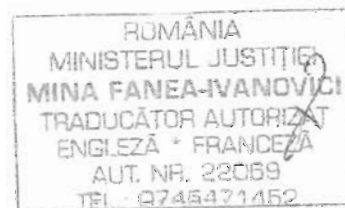

# Certificate

Standard **ISO 9001:2015**

Certificate Registr. No. 01 100 080127/01

Certificate Holder:

**OLYMPUS**

**Olympus Europa SE & Co. KG**

Wendenstr. 14-18  
D - 20097 Hamburg

Scope:

Marketing, sales and servicing of optical, opto-digital, electronic and mechanical systems as well as associated accessories and consumables in the field of imaging and audio products, endoscopy, microscopy and industry

Proof has been furnished by means of an audit that the requirements of ISO 9001:2015 are met.

Validity:

The certificate is valid in conjunction with the main certificate from 2017-07-16 until 2020-07-15.

2017-06-30



TÜV Rheinland Cert GmbH  
Am Grauen Stein · 51105 Köln

# Certificate

The Certification Body of  
TÜV Rheinland LGA Products GmbH

hereby certifies that the organization  
**OLYMPUS MEDICAL SYSTEMS CORP.**  
2951 Ishikawa-cho,  
Hachioji-shi, Tokyo 192-8507  
Japan

has established and applies a quality management system for medical devices  
for the following scope:

**See attachments for scope**

Proof has been furnished that the requirements specified in

**EN ISO 13485:2016**

are fulfilled. The quality management system is subject to yearly surveillance.

Effective Date: 2018-11-04  
Certificate Registration No.: SX 60133824 0001  
An audit was performed. Report No.: 12018179 027  
This Certificate is valid until: 2021-07-26

Certification Body



Date 2018-10-30



M.Sc. M. Aihara

**TÜV Rheinland LGA Products GmbH - Tillystraße 2 - 90431 Nürnberg**

Tel.: +49 221 806-1371 Fax: +49 221 806-3935 e-mail: cert-validity@de.tuv.com <http://www.tuv.com/safety>



**TÜV Rheinland**  
**LGA Products GmbH**  
**Tillystraße 2, 90431 Nürnberg**

**Attachment to  
Certificate**

**Registration No.:** SX 60133824 0001  
**Report No.:** 12018179 027

**Organization:** OLYMPUS MEDICAL SYSTEMS CORP.  
2951 Ishikawa-cho,  
Hachioji-shi, Tokyo 192-8507  
Japan

**Scope:**

Design and Development, Manufacture, Distribution, Service, Quality Assurance, Planning and Delivery support of Endoscopes, Endotherapy devices, Light Sources, Imaging Processors, Endoscope Position Detecting Units, Electrothermal Cautery Units, Integrated Endosurgery Systems, Endoscopic Regulation/Control Units, Camera Heads/Pumps/Monitors/ Recorders for Endoscopy, Electrosurgical Equipment, Capsule Endoscopes and Systems, Laparoscopic Insufflators, Ultrasound Diagnostic Imaging Systems, Disinfecting Units and Ultrasound Surgical Equipment, Probes and Transducers for Ultrasonic Lithotriptors, Sterile Non Active Instruments used in conjunction with Endoscopes, Sterile Endotherapy Devices used in conjunction with Endoscopes, Sterile Non Active Devices used in conjunction with Medical Ultrasound Diagnostic Imaging Systems and Water Container, Water Supply Tube, Water Feeding valve and Foot Switch for Pump

**Certification Body**



**Date:** 2018-10-30

  
**M.Sc. M. Aihara**



# Certificat

Organismul de certificare al TÜV Rheinland LGA Products GmbH

certifică prin prezenta faptul că organizația

**OLYMPUS MEDICAL SYSTEMS CORP.**  
**2951 Ishikawa-cho**  
**Hachioji-shi, Tokyo 192-8507**  
**Japonia**

a implementat și aplică un sistem de management al calității pentru dispozitive medicale pentru următoarele domenii:

**A se vedea atașamentul pentru domeniul de aplicabilitate**

S-a furnizat dovada faptului ca au fost indeplinite cerintele specificate in

**EN ISO 13485:2016**

Sistemul de management al calității este supus unei supravegheri anuale.

Data intrării în vigoare: 04.11.2018

Nr. înregistrare certificat: SX 60133824 0001

A fost efectuat auditul, raport nr. 12018179 027

Acest certificat este valabil până la 26.07.2021



Data, 30.10.2018

Organism de certificare  
(Semnătură indescifrabilă și ștampilă TÜV  
Rheinland LGA Products GmbH)  
M.Sc.M. Aihara

**TÜV Rheinland LGA Products GmbH – Tillystraße 2 – 90431 Nürnberg**

Tel: +49 221 806-1371 Fax: +49 221 806-3935 email: cert-validity@de.tuv.com <http://www.tuv.com/safety>

**TÜV Rheinland**  
**LGA Products GmbH**  
**Tillystraße 2, 90431 Nürnberg**

Atasament la  
Nr. inregistrare certificat SX 60133824 0001  
Nr. raport: 12018179 027

Organizatie:  
**Olympus Medical Systems Corp.**  
**2951 Ishikawa-cho**  
**Hachloji-shi, Tokyo 192-8507**  
**Japonia**

Domeniul de aplicabilitate: **Proiectare și dezvoltare, producție, distribuție, service, asigurarea calității, planificare și furnizare asistență pentru endoscoape, echipamente endoterapie, surse de lumină, procesoare de imagine, unități de detectare a poziției endoscopului, unități de cauterizare electrotermică, sisteme endochirurgicale integrate, unitati de control/reglare endoscopice, capete cameră/pompe/sisteme monitorizare/sisteme înregistrare pentru endoscopie, echipamente electrochirurgicale, endoscoape capsulă și sisteme, insuflatoare laparoscopice, sisteme de imagistica pentru diagnostic ecografic, unități dezinfectare și echipamente chirurgicale cu ultrasunete, sonde și traductoare pentru litotriptoare cu ultrasunete, instrumente sterile inactive utilizate împreună cu endoscoape, echipamente sterile pentru endoterapie utilizate împreună cu endoscoape, echipamente sterile inactive utilizate împreună cu sisteme medicale de imagistica pentru diagnostic ecografic și recipiente apă, tuburi alimentare apă, supape apă și întrerupătoare de picior pentru pompe.**



Data, 30.10.2018

Organism de certificare  
(Semnătură indescifrabilă și ștampilă TÜV  
Rheinland LGA Products GmbH)  
M.Sc.M. Aihara



# Certificate

**mdc medical device certification GmbH**  
certifies that

**Tekno-Medical Optik-Chirurgie GmbH**  
**Sattlerstraße 11**  
**78532 Tuttlingen**  
**Germany**

for the scope

**development, manufacturing and distribution of  
surgical instruments and accessories, endoscopic instruments and  
devices with accessories, dental instruments, instruments and implants for osteosynthesis,  
OR-lamps, OR-tables and accessories and repair service for rigid endoscopes**

has introduced and applies a

## Quality Management System

The mdc audit has proven that this quality management system  
meets all requirements of the following standard

**EN ISO 13485**

Medical devices – Quality management systems –  
Requirements for regulatory purposes

EN ISO 13485:2016 + AC:2016 - ISO 13485:2016

Valid from	2018-07-05
Valid until	2021-07-04
Registration no.	D1043500073
Report no.	P18-00452-117473
Stuttgart	2018-06-27



Head of Certification Body



# EC Certificate

**mdc medical device certification GmbH**

Notified Body 0483  
herewith certifies that

**Tekno-Medical Optik-Chirurgie GmbH**  
**Sattlerstraße 11**  
**78532 Tuttlingen**  
**Germany**

for the scope

**sterile scalpel knives UMDNS 12-252;**  
**shaver blades, UMDNS 17-117;**  
**saw blades for orthopedics, UMDNS 13-447**

has introduced and applies a

## Quality System

for the manufacture of the products concerned and carries out a  
final inspection as specified in Annex V, Section 3.

The mdc audit has proven that this quality system  
meets all requirements according to

## Annex V – Section 3 of the Council Directive 93/42/EEC

of 14 June 1993 concerning medical devices.

The surveillance will be held as specified in Annex V, Section 4.

Valid from	2018-07-05
Valid until	2023-07-04
Registration no.	D1043500072
Report no.	P18-00452-117481
Stuttgart	2018-06-27



Head of Certification Body



Benannt durch/Designated by  
Zentralstelle der Länder  
für Gesundheitsschutz  
bei Arzneimitteln und  
Medizinprodukten  
www.zlg.de  
ZLG-BS-246.10.06



# EC Certificate

**mdc medical device certification GmbH**

Notified Body 0483  
herewith grants

**Tekno-Medical Optik-Chirurgie GmbH**  
**Sattlerstraße 11**  
**78532 Tuttlingen**  
**Germany**

for the scope

**aneurysm clip**  
**(sterile and non-sterile, temporary and permanent,**  
**made of titanium and steel),**  
**UMDNS 10-905**

the

## EC Design Examination Certificate

The examination of the design of the product by mdc has proven  
that the design meets the requirements according to

### Annex II – Section 4 of the Council Directive 93/42/EEC

of 14 June 1993 concerning medical devices.

This certificate is only valid in connection with a valid  
mdc certificate according to Annex II – excluding section 4 for the  
above mentioned products.

Valid from	2018-11-22
Valid until	2023-11-22
Registration no.	D1043500074
Report no.	P18-00455-117538
Stuttgart	2018-11-22



Head of Certification Body



# EC Certificate

**mdc medical device certification GmbH**

Notified Body 0483  
herewith certifies that

**Tekno-Medical Optik-Chirurgie GmbH**  
**Sattlerstraße 11**  
**78532 Tuttlingen**  
**Germany**

for the scope

**instruments for high frequency surgery,  
endoscopic instruments and devices with accessories,  
suction- and irrigation units, battery operated units  
(see attachment)**

has introduced and applies a

**Quality System**

for the design, manufacture and final inspection.

The mdc audit has proven that this quality system  
meets all requirements according to

**Annex II – excluding Section 4  
of the Council Directive 93/42/EEC**

of 14 June 1993 concerning medical devices.

The surveillance will be held as specified in Annex II, Section 5.

Valid from	2018-11-19
Valid until	2023-07-04
Registration no.	D1043500076
Report no.	P18-00452-133952
Stuttgart	2018-11-19



Head of Certification Body





**Attachment of the certificate**

**No. D1043500076**

Date 2018-11-19

Page 1 of 1

Product category	Product	Class	Product code
Battery operated units	Drill, battery operated and accessories Saw, battery operated and accessories	Ila	16-868
Instruments for high frequency surgery	Electrosurgical units with accessories	Ilb	11-490
	HF-handles	Ilb	11-499
	Bipolar coagulation forceps, bipolar coagulation grippers Bipolar and monopolar forceps	Ilb	11-502
	Monopolar and bipolar electrodes Coagulation electrodes, coagulation grippers, scissors	Ilb	16-206
	Electrodes, electrosurgical, sterile and non sterile Bipolar coagulation forceps EVO II Bipolar clamps and scissors-clamps Monopolar laparoscopic electrodes	Ilb	16-860
	Endoscopic instruments and devices with accessories	Morcellator handpiece complete	Ila
Morcellator		Ila	11-333
Arthroscopic shaver systems with accessories		Ila	17-918
Laparoscopic instruments for electrosurgery		Ilb	11-502
Resectoscopes monopolar and bipolar		Ilb	13-335
Insufflators, laparoscopy with accessories		Ilb	16-849
Suction- and irrigation units	Suction- /irrigation unit MULTI PUMP and accessories Pump for arthroscopy ART PUMP II and accessories Pump for arthroscopy ART PUMP II D and accessories Pump for hysteroscopy HYS PUMP II and accessories Pump for urology URO PUMP II and accessories	Ila	17-424



Head of Certification Body



## Konformitätserklärung Declaration of Conformity

**im Sinne der Richtlinie 93/42 EWG: Anhang VII**  
*according to the Medical Device Directive 93/42 /EEC: Annex VII*

**Wir, die Firma**  
*We, the company*

**Tekno – Medical**  
*Optik-Chirurgie GmbH*  
*Sattlerstr. 11*  
*78532 Tuttlingen*

**erklären in alleiniger Verantwortung, dass folgende Produktgruppe**  
*declare on our sole responsibility that the product group*

**Medizinprodukte / medical devices**

**Produktnummer: siehe Anhang Produktliste zur Konformitätserklärung**  
*Item numbers: see attached list Product list Declaration of Conformity*

**Klassifizierung nach 93/42/EWG nach Anhang IX: Klasse IIa**  
*Classification according to 93/42/EEC Annex IX: class IIa*

**allen Anforderungen der Richtlinie 93/42/EWG, zuletzt geändert durch die EU-Richtlinie 2007/47EG entsprechen.**  
*meet all the requirements of the Directive 93/42/EEC, last changed by the EU-Directive 2007/47/EC.*

**Zusätzliche Angaben/ Additional information:**

**Die Entwicklung, Herstellung und der Vertrieb der Produkte wird durch ein QM-System gemäß den Forderungen der ISO 13485, des Medizinproduktegesetzes und der FDA unterstützt.**  
*Development, manufacturing and distribution of the medical devices are supported by a QM-system in according with the requirements of ISO 13485, the act on medical devices and the FDA.*

**Das QM-System wird überwacht durch die Benannte Stelle 0483 mdc medical device certification GmbH, Kriegerstr. 6, D-70191 Stuttgart, Germany.**  
*The QM-system is controlled by the notified body 0483 mdc medical device certification GmbH, Kriegerstr. 6, D-70191 Stuttgart, Germany.*

**gültig bis 04.07.2023**  
*valid untill 04.07.2023*

**Ort: Tuttlingen**  
*Place:*

**Datum: 05.07.2018**  
*Date:*



**Geschäftsführer**  
*Managing Director*  
**-Florian Mattes-**

**Produktliste zur Konformitätserklärung**  
 Product List Declaration of Conformity

UMDNS UMDNS	UMDNS Beschreibung	UMDNS-Description	Klasse Class	Regel Rule
10-198	Arthroskop	Arthroscopes	KL2A	7
10-580	Kanüle, Uterin	Cannulae, Uterine	KL2A	5
11-114	Zystourethroskop	Cystourethroscope	KL2A	7
11-333	Drillbohrer, zervikal	Drills, cervikal	KL2A	9
11-497	Elektrodenhalter, HF-Chirurgie	Electrode Holders, Electrosurgical	KL2A	5
11-603	Ösophagoskop	Esophagoscopes	KL2A	7
12-081	Hysteroskop	Hysteroscopes	KL2A	7
12-252	Messer, Skalpell	Knives, Scalpel	KL2A	6
12-291	Laparoskop	Laparoscopes	KL2A	7
12-750	Nadel, pneumoperitoneal	Needles, Pneumoperitoneal	KL2A	7
12-849	Otoskop	Otoscopes	KL2A	7
13-447	Klinge, Säge	Sawblade	KL2A	6
14-047	Thorakoskop	Thoracoscopes	KL2A	7
15-074	Bronchoskop, starr	Bronchoscopes, Rigid	KL2A	7
15-076	Laryngoskop, starr	Laryngoscopes, Rigid	KL2A	7
15-206	Kanüle, sonstige	Cannulae, Other	KL2A	7
15-260	Trokar, sonstige	Sleeves	KL2A	7

15-290	Nephroskop, starr	Nephroscopes, rigid	KL2A	7
15-591	Nephroskop	Nephroscopes	KL2A	7
16-146	Hülse	Sleeves	KL2A	7
16-146	Hülse	Sleeves	KL2A	5
16-849	Insufflationsgerät	Insufflators, Laparoscopic	KL2A	2
16-868	Antrieb	Drive	KL2A	9
17-117	Schneideinstrument, Meniskus	Cutters, Meniscus	KL2A	6
17-145	Zystoskop, starr	Cystoscopes, Rigid	KL2A	7
17-424	Absauggerät, endoskopische Spülung	Aspirators, Endoscopic Irrigation	KL2A	11
17-575	Diskektomiesystem, perkutan, automatisch	Percutameous Discectomy System, Automated	KL2A	7
17-633	Urethrotom	Urethrotomes	KL2A	7
17-690	Ureterorenoskop	Ureterorenoscopes	KL2A	6
17-690	Ureterorenoskop	Ureterorenoscopes	KL2A	7
17-918	Rasiersystem, Arthroskopie	Shaver-System	KL2A	2+11
18-097	Laserführung, endoskopisch	Laserguide, endoscopic	KL2A	7

Stand: 29.01.2019