

Comprehensive solutions for healthcare providers

Product catalogue





1989 tradition since

ZARYS is a family-owned company with Polish capital, operating on the market since 1989

Evolution from a small enterprise to a leader in the sourcing industry is a process that led to the creation of more comprehensive offers and solutions that facilitate the work of medics and save the lives of patients. ZARYS is currently hiring over 250 people, who are working to serve thousands of clients operating in the field of health care worldwide.

comprehensive medical supplies for hospitals

The company's customers have many product groups at their disposal, starting from medical gloves, through dressing materials, to operating kits and treatment packages. Products from different categories have individual characteristics and specific purposes. In order to facilitate the identification of materials and improve the ordering process, 13 different categories were created in addition to the latest category „ZARYS kids“.

we provide
**medical
disposable
devices**
to cover over

900%

of the hospital's needs



basic medical devices



medical gloves



dressings



medical clothing



surgical drapes and gowns



surgical sets



personal protective equipment



patient hygiene



pharmaceutical line



sports & physiotherapy products

**being a manufacturer of disposable medical equipment,
ZARYS meets the highest required standards**

Part of ZARYS production plants are located in Silesia and combine sterile production - a cleanroom with an area of over 600 m² - a place for manufacturing dedicated operating sets, a sewing room and an automated production line.



**production
made in Poland**



**clean
room**

Zarys logistic center

The ZARYS logistic center is the largest warehouse of disposable medical equipment in Central Europe. Located in Zabrze area as part of Katowice Special Economic Zone. Modern, high-bay warehouse, occupies an area of over 22,850 m² that contains over 22,500 pallet spaces.

**the largest
warehouse**

22 850 m²

22 500 pallet places

**of medical
disposable
devices
in Central
Europe**





TABLE OF CONTENTS

MEDICAL GLOVES pp. 10-23

NITRILE GLOVES

- 13 **easyCARE** nitrile
- 13 **easyCARE** nitrile long **NEW**
- 14 **easyCARE** nitrile pink
- 14 **easyCARE** nitrile black
- 15 **easyCARE** nitrile Hydra+
- 16 **mediCARE** nitrile SafeDon
- 17 **mediCARE** nitrile SafeDon Compact

LATEX GLOVES AND VINYL GLOVES

- 19 **HIGH RISK** **NEW**
- 20 **easyCARE** latex
- 20 **easyCARE** latex PF
- 21 **easyCARE** vinyl PF

SURGICAL GLOVES

- 23 **SafeCARE** powdered **NEW**
- 23 **SafeCARE** pf powder-free **NEW**

BASIC MEDICAL DEVICES pp. 24-85

BASIC INJECTION EQUIPMENT

- 27 **dispoFINE** injection needle
- 27 **dispoGUARD** safety injection needle
- 28 **dispoSULIN** insulin pen needle
- 28 side hole needle
- 29 **dicoSPIKE, dicoSPIKE Chemo** withdrawal cannula
- 31 **duoNEX** single-use syringe, 2-part, Luer
- 31 **dicoNEX SN** single-use syringe, 3-part, Luer, with needle alongside the syringe
- 32 **dicoNEX** single-use syringe, 3-part, Luer
- 32 **dicoNEX** single-use syringe, 3-part, Luer-Lock
- 33 **dicoNEX** single-use syringe, 3-part, Luer-Lock + amber
- 33 **dicoNEX** single-use catheter syringe, 3-part
- 34 **dicoTUBER** tuberculin syringe
- 34 **dicoSULIN** insulin syringe

INFUSION THERAPY

- 36 **SANViflon** I.V. cannula
- 36 **SANViflon S** I.V. cannula without port
- 37 **easyFLOW IS PREMIUM** infusion set **NEW**
- 37 **easyFLOW IS** infusion set
- 38 **easyFLOW IS** infusion set (dual chamber) **NEW**
- 38 **easyFLOW IS ECO** infusion set
- 39 **easyFLOW IS SAFE** infusion set **NEW**
- 39 **easyFLOW IS AMBER** infusion set, amber **NEW**
- 40 **easyFLOW IS REG** infusion set with precision flow rate regulator **NEW**
- 40 precision flow regulator **NEW**
- 41 **easyFLOW TS PREMIUM** transfusion set **NEW**
- 41 **easyFLOW TS** transfusion set
- 42 **easyFLOW LINE** extension tube for infusion pump
- 42 needle-free valve
- 43 needle free valve with extension line **NEW**
- 43 3-way stopcock
- 44 3-way stopcock with extension tube
- 44 cannula stopper

OXYGEN THERAPY

- 46 nasal oxygen cannula
- 46 oxygen tubing
- 46 oxygen mask
- 47 non-rebreather mask
- 47 multi-vent mask
- 47 nebulizer mask
- 48 nebulizer

ANAESTHESIA PRODUCTS

- 50 endotracheal tube uncuffed
- 50 endotracheal tube uncuffed **NEW**
- 50 endotracheal tube cuffed
- 51 endotracheal tube cuffed **NEW**
- 51 reinforced endotracheal tube cuffed
- 52 intubation stylet
- 52 tracheal tube introducer
- 52 endotracheal tube holder
- 53 oropharyngeal airway/guedel airway
- 53 laryngeal mask PVC
- 54 laryngeal mask silicone
- 54 tracheostomy tube cuffed
- 55 air cushion anaesthetic mask
- 55 anaesthetic mask with open seal
- 56 catheter mount with double swivel elbow connector
- 56 dual-limb breathing circuit

SUCTION CATHETERS, STOMACH TUBES

- 58 suction catheter with vacuum control
- 58 suction catheter
- 59 suction catheter with frozen surface
- 59 feeding tube graduated, with X-ray contrast
- 60 stomach tube/duodenal tube

UROLOGICAL CATHETERS, URINE BAGS

- 62 Foley catheter 2-way, silicone-coated latex
- 63 Foley catheter 3-way, silicone-coated latex
- 63 Foley catheter 2-way with tiemann tip, silicone-coated latex
- 64 Foley catheter 2-way, 100% silicone
- 64 Foley catheter 3-way, 100% silicone
- 65 Nelaton catheter
- 65 Tiemann catheter
- 66 Pezzer catheter silicone-coated latex
- 66 samples taking urine bag
- 67 urine bag
- 67 urine bag with sample port
- 68 urine bag hanger
- 68 urine bag with sample port 2W

GENERAL SURGERY

- 70 Yankauer surgical suction cannula, standard CH21
- 70 Yankauer surgical suction cannula, bulb tip CH25
- 71 surgical suction tube
- 71 surgical suction set with Yankauer cannula, standard
- 72 surgical suction set with Yankauer cannula, bulb tip

BASIC PRODUCTS FOR GINECOLOGY

- 74 vaginal speculum, cusco type
- 74 cervical brush, standard
- 75 cervical brush, special
- 75 umbilical cord clamp

OTHER PRODUCTS

- 77 ID wristband
- 77 entrance mat
- 77 enema bag
- 78 enema bag
- 78 enema set
- 78 vomit bag
- 79 safELANCE, pressure-activated safety lancet
- 79 dental brush with suction
- 79 oral swab
- 80 tactical tourniquet CAT
- 80 automatic tourniquet
- 81 latex-free tourniquet
- 81 tongue depressor
- 82 electronic thermometer
- 82 wash glove
- 83 PE gloves
- 83 PE oversleeves **NEW**
- 84 medical waste container
- 85 hygienic pet underpad **NEW**

DRESSINGS pp. 86-125

TRADITIONAL DRESSING MATERIALS

gauze and non-woven dressings

- 89 **GAZA lux** dressing gauze, zig-zag folded
- 89 **GAZA lux** cutting gauze
- 89 **GAZA lux S** cutting gauze
- 90 **KOMPRI lux** gauze swabs **BESTSELLER**
- 91 **KOMPRI lux S** gauze swabs
- 92 **SERVI lux** gauze lap sponges
- 92 **SERVI lux S** gauze lap sponges
- 93 **TUPFER lux** gauze balls
- 93 **TUPFER lux S** gauze balls
- 94 **NONVI lux** non-woven swabs
- 94 **NONVI lux S** non-woven swabs
- 94 **NONVI lux** non-woven swabs, with Y-incision
- 95 **MULTIabsorb** ABD pads, multi-layer
- 95 **MULTIabsorb S** ABD pads, multi-layer
- 96 **elastoLUMENAL** eye pads
- 96 **elastoLUMENAL S** eye pads
- 96 **cellIPAD** cellulose swabs **NEW**

ADHESIVE TAPES AND PLASTERS WITH DRESSING

adhesive tapes

- 98 **SENSiplast** adhesive fabric tape, white
- 98 **PLASTiplast** adhesive fabric tape, skin colour
- 99 **SOFTplast** adhesive non-woven tape
- 99 **SILKplast** adhesive silk tape
- 100 **FILMplast** adhesive PE tape
- 100 **POREplast** adhesive perforated non-woven tape

plasters with dressing

- 101 **NONV|plast** non-woven plaster with dressing
- 101 **FABRIplast** fabric plaster with dressing

SPECIAL PURPOSE DRESSINGS

self-adhesive non-woven dressings

- 103 **elastopor, elastopor E** adhesive non-woven dressing tape
- 104 **elastopor STERIL** non-woven dressing with absorbent pad **BESTSELLER**
- 104 **elastoKIDS STERIL** non-woven dressing with absorbent pad
- 105 **elastopor IV** non-woven IV cannula dressing **BESTSELLER**
- 105 **elastoKIDS IV** non-woven IV cannula dressing
- 106 **elastopor STERIL D** non-woven dressing with absorbent pad, incision and O-hole
- 106 **elastoKIDS STERIL D** non-woven dressing with absorbent pad **NEW**
- 106 **elastopor EYE, elastoKIDS EYE** non-woven eye dressing with absorbent pad
- 107 **elastoKIDS** colorful kids plasters
- 107 set of injection plasters **NEW**

stabilizing tapes

- 108 elastoNASAL non-woven nasal cannula fixation plaster
- 108 elastoNASAL KIDS non-woven nasal cannula fixation plaster **NEW**
- 109 elastoFIXAL adhesive tape for catheter tubing fixation
- 109 elastoFIXAL KIDS adhesive tape for catheter tubing fixation **NEW**
- 109 elastoFIXAL Set adhesive tape for endotracheal tube
- 110 elastoFIXAL Set KIDS adhesive tape for endotracheal tube **NEW**
- 110 elastoFIXAL TUBE band for tracheostomy tube fixation
- 110 adhesive dressing pouch for dialysis catheters **NEW**

STABILIZING DRESSINGS

fixation of dressings

- 112 elastoBAND BASIC knitted supporting bandage
- 112 elastoBAND FLEX elastic supporting bandage, woven
- 113 elastoBAND FIX elastic supporting bandage, woven **NEW**
- 113 elastoBAND CREPP cohesive supporting bandage, non-woven **NEW**
- 114 elastoBAND KNITT elastic supporting bandage, knitted **NEW**
- 114 yellowBAND cohesive bandage
- 115 elastoNET elastic tubular net bandage

immobilizing dressings

- 116 orthoNATURAL orthopedic padding, natural
- 116 orthoSYNTHETIC orthopedic padding, synthetic
- 117 elastoSLING triangular sling
- 118 orthoBAND FAST P.O.P. bandages
- 118 orthoBAND NORMAL P.O.P. bandages
- 118 orthoBAND LONG P.O.P. bandages

SPECIALIST DRESSINGS

- 121 paraffiNET paraffin gauze dressing

foil dressings

- 121 elastoDERM foil dressing
- 122 elastoDERM F foil dressing with frame
- 122 elastoDERM F-IV IV cannula dressing with frame
- 122 elastoDERM IV IV cannula dressing
- 122 elastoDERM PAD foil dressing with absorbent pad

ADDITIONAL PRODUCTS

- 124 thermPAD cold/warm compress **NEW**
- 124 gynPAD gynaecological-maternity pad **NEW**
- 124 Alcohol Prep Pad gauze pad moistened with alcohol
- 125 ALKOPAD gauze pad moistened with alcohol
- 125 ALKOPAD DUO gauze pad moistened with alcohol
- 125 thermCARE rescue blanket, foil, termic



DELTA SET pp. 126-135

STANDARD DELTA SET SURGICAL KITS

- 131 puncture kit 1
- 132 suture removal kit 1
- 132 urinary bladder catheterization kit 1
- 133 urinary bladder catheterization kit 2
- 133 dialysis on kit 1a
- 134 dialysis off kit 1b

OMEGAPACK pp. 136-139

PROCEDURE SETS

- 138 advantages of using omegapack operating sets
- 139 components of our set

PERSONAL PROTECTIVE EQUIPMENTS pp. 140-141

BETASAFE

- 141 protective coverall **SAFE+**

SURGICAL SETS, DRAPES, GOWNS pp. 142-197

SURGICAL DRAPES

2-layer surgical drapes

- 151 sterile surgical drapes with cellulose layer
- 151 sterile surgical drapes (economic version)
- 151 sterile surgical drapes
- 151 sterile surgical drapes with adhesive edge (economic version)
- 152 sterile surgical drapes with adhesive edge
- 152 sterile surgical drapes with central fenestration (economic version)
- 152 sterile surgical drapes with central fenestration
- 152 sterile surgical drapes with adhesive central fenestration (economic version)
- 152 sterile surgical drapes with adhesive central fenestration
- 153 sterile surgical drapes with adhesive central adjustable fenestration (economic version)
- 153 sterile surgical drapes with adhesive central adjustable fenestration
- 153 sterile adhesive epidural drapes
- 153 sterile instrument table covers

3-layer surgical drapes

- 154 sterile surgical drapes
- 154 sterile surgical drapes with adhesive edge
- 154 sterile surgical drapes with central fenestration
- 155 sterile surgical drapes with adhesive central fenestration
- 155 sterile surgical drapes with adhesive fenestration, reinforced

specialistic surgical drapes

- 156 abdominal drape 1-IF
- 156 abdo-perineal drape 1
- 156 laparoscopy drape 3
- 157 orthopaedic drape 1
- 157 orthopaedic drape 2
- 157 orthopaedic drape 3
- 157 orthopaedic drape 4
- 158 extremity drape 1
- 158 extremity drape 2
- 158 extremity drape 3
- 158 extremity drape 4
- 159 extremity drape 5
- 159 gynaecology drape 1
- 159 gynaecology drape 2
- 159 delivery drape 1
- 160 ophthalmic drape 1-IF
- 160 ophthalmic drape 2-IF
- 160 ophthalmic drape 3-IF
- 160 ophthalmic drape 4-IF

SURGICAL COVERS, ACCESSORIES

surgical covers

- 162 sterile mayo stand cover, reinforced - red **BESTSELLER**
- 162 sterile set of limb cover
- 162 sterile limb cover
- 162 sterile camera cabs cover - perforated, with 2 adhesive tapes **BESTSELLER**
- 163 sterile camera cable cover - unperforated, with an adhesive tape

- 163 sterile circular banded covers for medical devices
- 163 sterile rectangular banded covers for medical devices
- 163 sterile c-arm cover set
- 163 sterile armboard cover set

accessories

- 164 sterile surgical tapes
- 164 sterile adhesive pouches
- 164 sterile adhesive fluid collection pouch
- 164 sterile absorbent drape
- 165 sterile absorbent drape
- 165 sterile incise film elastoFILM

SURGICAL SETS

universal sets

- 167 basic set 1
- 167 universal set 1
- 167 universal set 2
- 167 universal set 4 **BESTSELLER**
- 168 universal set 5 **BESTSELLER**
- 168 universal set 5-M **NEW**
- 169 universal set 5-G
- 169 universal set 5-GP
- 170 universal set 6 **BESTSELLER**
- 170 universal set 6-M **NEW**
- 171 universal set 7
- 171 universal set 8
- 172 pediatric universal set 9
- 172 universal set 10

general surgery

- 173 abdominal set 1-IF
- 173 abdo-perineal set 1
- 174 laparoscopy set 1-IF
- 174 laparoscopy set 2 **BESTSELLER**
- 175 laparoscopy set 3
- 175 varicose vein set 1
- 175 varicose vein set 2

orthopaedics and traumatology

- 176 extremity set 1
- 176 extremity set 2
- 177 arthroscopy set 1
- 177 arthroscopy set 2
- 178 arthroscopy set 2-IP
- 178 arthroscopy set 3
- 179 arthroscopy set 4-IP
- 179 arthroscopy set 5
- 180 hip set 1
- 180 hip set 2
- 181 hip set 3
- 181 shoulder set 1
- 182 shoulder set 2
- 182 dynamic hip screw set 1-IF **NEW**
- 182 vertical isolation set 1-IP **NEW**

gynaecology and urology

- 183 gynaecology set 1
- 183 gynaecology set 2 **BESTSELLER**
- 184 gynaecology set 3
- 184 cystoscopy set 1
- 184 uro/gynaecology set 2
- 185 uro/gynaecology set 3
- 185 tur set 1-IP
- 185 tur set 2-IP **BESTSELLER**
- 186 percutaneous lithotripsy set 1-IP **NEW**

obstetrics

- 186 c-section set 1
- 187 c-section set 1-IF
- 187 c-section set 2-IF
- 188 c-section set 3-IF
- 188 delivery set 1
- 188 delivery set 2
- 189 delivery set 3
- 189 delivery set 4
- 189 delivery set 5

ophthalmology

- 190 ophthalmic set 2-IF
- 190 ophthalmic set 3-IF

neurosurgery and otolaryngology

- 191 otolaryngology set 1
- 191 otolaryngology set 2
- 191 craniotomy set 1-IF

cardiosurgery and angiography

- 192 ablation set 1-IF
- 192 angiography set 2
- 192 angiography set 3 **NEW**

SURGICAL GOWNS

- 194 sterile gown NORMAL - 22
- 194 surgical gown STANDARD - 35 **BESTSELLER**
- 194 surgical gown STANDARD - 35 (economic version)
- 194 surgical gown STANDARD - 40 **NEW**
- 195 surgical gown STANDARD - 45
- 195 surgical gown STANDARD PLUS - 35 **BESTSELLER**
- 195 surgical gown STANDARD PLUS - 35 (economic version)
- 196 surgical gown STANDARD PLUS - 40 **NEW**
- 196 surgical gown STANDARD PLUS - 45
- 196 surgical gown EXTRA SAFE - 35 **BESTSELLER**
- 196 surgical gown COMFORT - 68
- 197 surgical gown COMFORT PLUS - 68

non-sterile surgical gowns

- 197 surgical gown STANDARD - 35
- 197 surgical gown PREMIUM - 35



MEDICAL CLOTHING pp. 198-221

MEDICAL GOWNS

- 201 medical gown with elastic cuffs, non-woven
- 201 medical gown with knitted cuffs, non-woven

SURGICAL CLOTHING

- 203 surgical suit, short-sleeved shirt+trousers, non-woven
- 204 surgical shirt, short-sleeved, non-woven
- 204 surgical shirt, long-sleeved, non-woven
- 205 surgical trousers, with ties, non-woven

CAPS, PROTECTIVE MASKS

- 207 medical bouffant cap, non-woven
- 207 DONA medical bouffant cap
- 207 LILI medical cap with rubber
- 208 POLA medical cap with rubber
- 208 SOL medical cap with ties
- 208 ABI medical cap with ties

- 209 NINO medical cap
- 209 KOKO long medical cap with snood
- 209 DORA long medical cap with snood
- 210 BEN medical cap with ties
- 210 TOM medical cap with ties
- 210 ROS medical cap with ties
- 210 OLAF medical cap with ties **NEW**
- 211 MAYA medical cap with rubber **NEW**
- 211 medical mask with ties
- 211 medical mask with earloops
- 211 medical mask with earloops **NEW**

PATIENT CLOTHING

- 213 patient's gown, tied-up, non-woven
- 213 patient's gown, Y-neck, non-woven
- 213 patient's gown, V-neck, non-woven
- 214 patient's gown, for delivery, non-woven
- 214 patient's gown, for children, non-woven **NEW**
- 214 colonoscopy boxers, SMS non-woven
- 215 colonoscopy boxers, PP non-woven
- 215 gynecological skirt, non-woven

SHOE COVERS

- 217 shoe covers
- 217 shoe covers, calf-high

CAPS, PROTECTIVE MASKS

- 219 disposable medical bed sheet
- 219 disposable medical pillow case
- 219 disposable medical quilt cover
- 219 disposable medical bedding set
- 220 disposable absorbent underpad
- 220 disposable absorbent underpad for operating table
- 220 absorbent underpad for children **NEW**
- 221 disposable medical bed sheet, reinforced
- 221 thermal patient cover soft
- 221 thermal patient cover



VITAHEALTH pp. 222-223

EXAMINATION GLOVES

The device is intended for patient diagnostics, providing a barrier to the transmission of microorganisms between the operator and the patient, minimizing the risk of cross-contamination.

NITRILE GLOVES are made of synthetic acrylonitrile butadiene rubber (NBR), they are an alternative to latex gloves. They do not contain latex proteins, and the content of chemical accelerators is minimized, so they are friendly to the skin.

They are characterized by:

- high **mechanical strength** (also for puncture),
- **chemical and biological resistance** (constitute a barrier for viruses and bacteria),
- **flexibility**, thanks to which they adjust to the hand, providing the work comfort to the user.

VINYL GLOVES made of PVC (polyvinyl chloride) are intended for low-risk procedures due to limited mechanical, chemical and biological resistance. The glove material does not cause Type I allergic reactions, ZARYS vinyl gloves are free of harmful phthalates.

LATEX GLOVES made of natural rubber are recognized as the best barrier against blood borne pathogens and part of hazardous chemical substances. They are also characterized by high flexibility, providing the work comfort to the user by fitting to the hand like a „second skin“. Latex gloves, due to the natural raw material, are biodegradable.

STERILE, SURGICAL AND PROTECTIVE GLOVES

Made from natural rubber latex, intended to be worn on hands in surgical settings to provide barrier against potentially infectious fluids or other contaminants, and to protect the patient by ensuring sterility of the wound area. These gloves are intended for single use only, and are classified as Medical Devices Class IIa as well as a Personal Protective Equipment Category III. The indicated Gloves are designed to protect against substances and mixtures which are hazardous and against harmful biological agents.

medical gloves

nitrile gloves | latex gloves
| vinyl gloves | surgical gloves



ZARYS



WWW.ZARYS.COM

NITRILE GLOVES

easyCARE nitrile

type	examination glove, nitrile
external surface	micro-textured with additional texturing at the fingertips
internal surface	chlorinated
cuff	beaded
AQL	1.0
classification	class I medical device personal protective equipment category III
length	245 mm
features	increased tactile sensitivity
packing unit/ bulk packing	100 pcs / 10 x 100 pcs 200 pcs / 10 x 200 pcs
REF	RNBXX10001 (XX:XS-XL) RNBXX20001 (XX:XS-XL)

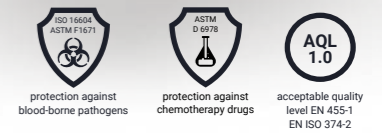

easyCARE nitrile long NEW

type	examination glove, nitrile , with extended cuff
external surface	micro-textured with additional texturing at the fingertips
internal surface	chlorinated
cuff	beaded
AQL	1.0
classification	class I medical device personal protective equipment category III
length	300 mm
features	increased tactile sensitivity, extended cuff
packing unit/ bulk packing	100 pcs / 10 x 100 pcs
REF	RNBXX10001 (XX:S-XL)

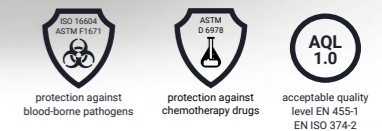

easyCARE nitrile pink

type	examination glove, nitrile
external surface	micro-textured with additional texturing at the fingertips
internal surface	chlorinated
cuff	beaded
AQL	1.0
classification	class I medical device personal protective equipment category III
length	240 mm
features	intense colour
packing unit/ bulk packing	100 pcs / 10 x 100pcs
REF	RNBRXX10001 (XX:XS-L)

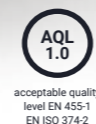

mediCARE nitrile Hydra+

Dermatology solution for skin problems

gloves that protect and nourish the hands, while providing long-lasting hydration



Almond oil

regenerates, moisturizes, slows the aging process of the skin, smoothes, firms and helps removing dead cells, brighten the skin, soothes irritations and accelerates healing skin lesions, strengthens the hydro-lipid layer of the skin



Vitamin E

natural antioxidant, vitamin of youth – fights off free radicals and prevents wrinkles, moisturizes for a long time



Glycerin

moisturizes, improves skin appearance, smoothes and soothes irritations



Anti-wrinkle effects proven in clinical test*

*mediCARE Hydra+ glove presents a better anti-wrinkle effect compared to a traditional nitrile glove with visible reduction of wrinkles from the first day of use with progressive increase in improvement until the end of the tests.

easyCARE nitrile black

type	examination glove, nitrile
external surface	micro-textured with additional texturing at the fingertips
internal surface	chlorinated
cuff	beaded
AQL	1.0
classification	class I medical device personal protective equipment category III
length	240 mm
features	increased endurance
packing unit/ bulk packing	100 pcs / 10 x 100pcs
REF	RNBCXX10001 (XX:XS-XL)



Nitrile gloves with moisturizing and nourishing coating

type	examination glove, nitrile
external surface	micro-textured with additional texturing at the fingertips
internal surface	chlorinated
cuff	beaded
AQL	1.0
classification	class I medical device personal protective equipment category III
length	240 mm
features	moisturizing and nourishing coating
packing unit/ bulk packing	100 pcs / 10 x 100 pcs
REF	RNBHXX10003 (XX:XS-XL)



mediCARE nitrile SafeDon™

type	examination glove, nitrile
external surface	micro-textured with additional texturing at the fingertips
internal surface	chlorinated
cuff	beaded
AQL	1.0
classification	class I medical device personal protective equipment category III
length	240 mm
features	single glove removal system always by the cuff
packing unit/ bulk packing	250 pcs (240 for XL) / 8 x 250 pcs (240 pcs)
REF	RNBSXX25001 (RNBSXL24001 for XL) (XX:XS-XL)



protection against
blood-borne pathogens



protection against
chemotherapy drugs



acceptable quality
level EN 455-1
EN ISO 374-2

SafeDon™ holder types

SINGLE

transparent

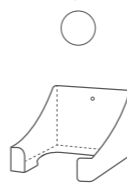

compatible with:
SafeDon 250 pcs
SafeDon compact 50 pcs

TRIPLE

white

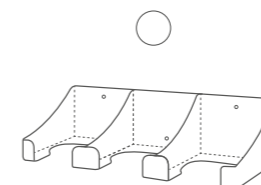

compatible with:
SafeDon 250 pcs
SafeDon compact 50 pcs

MODURA RAIL

transparent

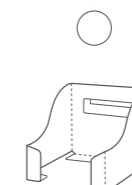

compatible with:
SafeDon 250 pcs
SafeDon compact 50 pcs

COMPACT

transparent

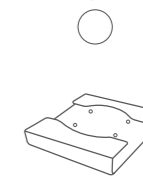

compatible with:
SafeDon compact 50 pcs

mediCARE nitrile SafeDon™ COMPACT

type	examination glove, nitrile
external surface	micro-textured with additional texturing at the fingertips
internal surface	chlorinated
cuff	beaded
AQL	1.0
classification	class I medical device personal protective equipment category III
length	240 mm
features	single glove removal system always by the cuff
packing unit/ bulk packing	50 pcs / 20 x 50 pcs
REF	RNBSXX5001 (XX:XS-XL)



protection against
blood-borne pathogens



protection against
chemotherapy drugs



acceptable quality
level EN 455-1
EN ISO 374-2

SafeDon™

HOSPITAL INFECTION PREVENTION SYSTEM

SINGLE GLOVE REMOVAL SYSTEM always by the cuff

reduced risk
of cross-infection by

up to **96%**

reduced glove
consumption by

more than **25%**

Gloves packaged under controlled
conditions of **microbiological purity**

Space-saving wall-mounted
holder keeps gloves away
from potential contamination

ZARYS



WWW.ZARYS.COM

LATEX AND VINYL GLOVES

HIGH RISK

INTENDED FOR: **DIAGNOSTIC PROCEDURES WHERE THERE IS AN INCREASED RISK OF INFECTION**

LENGTH OF GLOVE: **30 cm** NEW

ADDITIONAL TEXTURE ON FINGERTIPS
POWDER - FREE GLOVE, INTERNALLY CHLORINATED

EXTRA  **STRONG**

type	examination glove, latex
external surface	micro-textured with additional texturing at the fingertips
internal surface	powder-free, chlorinated
cuff	beaded
AQL	1.0
classification	class I medical device personal protective equipment category III
length	300 mm
features	increased endurance
packing unit/ bulk packing	50 pcs / 10 x 50 pcs
REF	RLBHRXX5008 (XX:S-XL)



easyCARE latex

type	examination glove, latex
external surface	micro-textured with additional texturing at the fingertips
internal surface	powdered
cuff	beaded
AQL	1.0
classification	class I medical device personal protective equipment category III
length	245 mm
features	biodegradable
packing unit/ bulk packing	100 pcs / 10 x 100 pcs
REF	RLPXX10007 (XX:XS-XL)



easyCARE vinyl PF

type	examination glove, vinyl
external surface	smooth
internal surface	powder-free
cuff	beaded
AQL	1.5
classification	class I medical device personal protective equipment category III
length	240 mm
packing unit/ bulk packing	100 pcs / 10 x 100 pcs
REF	RWBXX10001 (XX:XS-XL)



easyCARE latex PF

type	examination glove, latex
external surface	micro-textured with additional texturing at the fingertips
internal surface	powder-free, polymer coated
cuff	beaded
AQL	1.0
classification	class I medical device personal protective equipment category III
length	245 mm
features	easier donning due to inner polymer coating / biodegradable
packing unit/ bulk packing	100 pcs / 10 x 100 pcs
REF	RLBXX10007 (XX:XS-XL)



ZARYS



WWW.ZARYS.COM

SURGICAL GLOVES

GsafeCARE NEW

type	natural rubber latex , sterile
external surface	textured
internal surface	powdered
cuff	extended cuff, beaded
AQL	0.65
classification	class IIa medical device personal protective equipment category III
features	standard powdered latex surgical glove
packing unit/ bulk packing	1 pair / 1 x 50 pair
REF	RCHLP-XX-50-03 (XX:5.5-9.0)
sizes	5.5 - 9.0



GsafeCARE **pf** NEW

type	natural rubber latex , sterile
external surface	textured
internal surface	powder-free
cuff	extended cuff, beaded
AQL	0.65
classification	class IIa medical device personal protective equipment category III
features	standard powder-free latex surgical glove
packing unit/ bulk packing	1 pair / 1 x 50 pair
REF	RCHLB-XX-50-03 (XX:5.5-9.0)
sizes	5.5 - 9.0



ZARYS International Group prides itself on having a long lasting experience gained in the medical industry by being a leading manufacturer and supplier of single use medical devices.

A wide range of products and complex solutions makes it possible to successfully respond to our customers' needs and meet their expectations.

High standards of design, production, storing and transportation allow to maintain quality, safety and comfort of use to both the medical personnel and patients.

A wide range of single use products include basic medical devices and those dedicated to specialized procedures.

ZARYS branded products find a wide application in anesthesiology, urology, gynecology, oxygen and fluid therapy and in many other medical specialities. They make it possible to perform medical procedures including patient diagnostics, prophylaxis, treatment and care.

basic medical devices

basic injection equipment | infusion therapy
| oxygen therapy | anaesthesia products |
suction catheters, stomach tubes | urological
catheters, urine bags | general surgery
| basic products for gynecology | other products



ZARYS



WWW.ZARYS.COM

BASIC INJECTION EQUIPMENT

dispoFINE injection needle

features

- needle tube is made of smooth and durable stainless steel
- sheath and hub made of polypropylene
- thin walls assure adequate stream pace
- tip sharpened in three surfaces (back cut)
- bevel type: LB/BL standard long bevel
- surface of needle tube covered with sliding agent (silicone)
- glued needle elements to prevent their separation (glue - epoxy resin)
- hubs coloured in accordance with ISO code allowing fast recognition of needle size
- single-use
- non-toxic, non-pyrogenic
- packaging: 1 pc./paper-foil

indication

- device designed for intravenous, intramuscular and hypodermic injections



REF	size	colour	G	intermediate packaging
IN-03X13	0,3 mm x 13 mm	yellow	30	100 pcs
IN-04X19	0,4 mm x 19 mm	medium grey	27	100 pcs
IN-045X12	0,45 mm x 12 mm	brown	26	100 pcs
IN-045X16	0,45 mm x 16 mm	brown	26	100 pcs
IN-045X22	0,45 mm x 22 mm	brown	26	100 pcs
IN-05X16	0,5 mm x 16 mm	orange	25	100 pcs
*IN-05X20	0,5 mm x 20 mm	orange	25	100 pcs
IN-05X25	0,5 mm x 25 mm	orange	25	100 pcs
IN-05X40	0,5 mm x 40 mm	orange	25	100 pcs
IN-06X25	0,6 mm x 25 mm	deep blue	23	100 pcs
IN-06X30	0,6 mm x 30 mm	deep blue	23	100 pcs
IN-06X40	0,6 mm x 40 mm	deep blue	23	100 pcs
IN-07X30	0,7 mm x 30 mm	black	22	100 pcs
IN-07X40	0,7 mm x 40 mm	black	22	100 pcs
*IN-07X50	0,7 mm x 50 mm	black	22	100 pcs

REF	size	colour	G	intermediate packaging
IN-08X40	0,8 mm x 40 mm	deep green	21	100 pcs
*IN-08X50	0,8 mm x 50 mm	deep green	21	100 pcs
IN-09X25	0,9 mm x 25 mm	yellow	20	100 pcs
IN-09X40	0,9 mm x 40 mm	yellow	20	100 pcs
IN-11X40	1,1 mm x 40 mm	cream	19	100 pcs
IN-12X40	1,2 mm x 40 mm	pink	18	100 pcs
IN-12X50	1,2 mm x 50 mm	pink	18	100 pcs
IN-16X40	1,6 mm x 40 mm	white	16	100 pcs
IN-18X40	1,8 mm x 40 mm	blue-grey	15	100 pcs
IN-21X40	2,1 mm x 40 mm	pale green	14	100 pcs

 bulk packaging:
50 x 100 pcs

 available
on request



dispoGUARD safety injection needle

features

- safety cover can be activated with one hand and it shields needle immediately after injection
- cover integrated with needle
- tip sharpened in three surfaces (back cut)
- colour coding system for size, marked on hub
- activation of safety mechanism signalized by audible click
- needle is securely closed inside activated safety cover
- single-use
- non-toxic, non-pyrogenic
- packaging: 1 pc./paper-foil

indication

- device designed for intravenous, intramuscular and hypodermic injections

REF	size	colour	G	intermediate packaging
*INB-03X13	0,3 mm x 13 mm	yellow	30	50 pcs
INB-045X12	0,45 mm x 12 mm	brown	26	50 pcs
INB-05X25	0,5 mm x 25 mm	orange	25	50 pcs
INB-05X40	0,5 mm x 40 mm	orange	25	50 pcs
INB-06X25	0,6 mm x 25 mm	deep blue	23	50 pcs
*INB-06X30	0,6 mm x 30 mm	deep blue	23	50 pcs
*INB-07X30	0,7 mm x 30 mm	black	22	50 pcs
INB-07X40	0,7 mm x 40 mm	black	22	50 pcs
INB-08X40	0,8 mm x 40 mm	deep green	21	50 pcs
INB-09X40	0,9 mm x 40 mm	yellow	20	50 pcs
INB-11X40	1,1 mm x 40 mm	cream	19	50 pcs
INB-12X40	1,2 mm x 40 mm	pink	18	50 pcs



 bulk packaging:
50 x 50 pcs

 available
on request



dispoSULIN

insulin pen needle

features

- made of polypropylene, polyethylene and stainless steel
- triple-point needle blade allows easy and atraumatic skin penetration
- covering the needle with silicone lubricant reduces resistance during injection
- thin walls of needle ensure easy flow of medicine and the right flow rate
- coloured cap and paper cover of packaging make it easy to quickly recognize size of needle
- available in various sizes, allowing you to adapt to individual needs
- universal, compatible with all pen models
- single-use
- non-pyrogenic, non-toxic
- packaging: 100 pcs/box

indication

- for subcutaneous injection
- dedicated for use with pre-filled pens (insulin pens)



REF	size	colour	G	intermediate packaging
INP-033X12	0,33 mm x 12 mm	pink	29	100 pcs
INP-030X08	0,30 mm x 8 mm	yellow	30	100 pcs
INP-025X06	0,25 mm x 6 mm	purple	31	100 pcs
INP-025X08	0,25 mm x 8 mm	blue	31	100 pcs

 bulk packaging:
50 x 100 pcs



side hole needle

features

- made of stainless steel
- the needle hub ideally suited for Luer and Luer-Lock (to ensure full tightness of the connection with syringes)
- CE sign comply with PN-EN-ISO 7864
- individual packaging comply with PN-EN 556 and PN-EN 868, type blister-pack
- coloured cap and paper cover of packaging make it easy to quickly recognize
- single-use

indication

- made of high quality materials, using the latest technology, which guarantees its high quality and failure-free, intended usage
- special design needle with a pencil cut with a side hole, designed to withdraw medication from a vial, including vials with a rubber stopper
- needle construction prevents from accidental, unintended production of rubber scrubs, in order to avoid contamination of the drug
- side hole with special cut, placed on the top of the needle enables free dissolution of the drug and limits foaming by directing the fluid directly onto the walls of the vial



conallhealth
Your Partner In Healthcare

REF	size	colour	G	intermediate packaging
HPP-1830	1,2 x 30 mm	pink	18	100 pcs

 bulk packaging:
100 x 100 pcs



dicoSPIKE, dicoSPIKE Chemo

withdrawal cannula

features

- easy to use, ergonomic shape
- body with knurled surface for a secure grip
- sharp receiving spike enabling tight and safe connection with containers of different capacity
- receiving spike groove guarantees complete emptying of the container
- hermetic self-Locking cap securing the connector against contamination
- available in version with air filter and in version with air and particle filter
- air filter protects against microbiological contamination and against harmful aerosols
- particle filter is an effective barrier to protect drugs and liquids from contamination
- female Luer-Lock connector compatible with products with either male or female Luer-Lock
- non-pyrogenic
- single-use
- packaging: 1 pc./ paper-foil

indication

- device for needle-free dissolving and / or withdrawing drugs from multi-dose packages (bottles, vials, etc.) - in both directions
- dicoSPIKE Chemo model is designed for medicines releasing dangerous aerosols such as cytostatics

dicoSPIKE

REF	cap colour	air filter	particle filter	purpose	intermediate packaging
PPLZ	green	0,1 µm	-	standard medicines	100 pcs
PPLN	blue	0,1 µm	5 µm	standard medicines	100 pcs

dicoSPIKE Chemo

REF	cap colour	air filter	particle filter	purpose	intermediate packaging
PPLC	red	0,1 µm	5 µm	cytostatics	100 pcs



 bulk packaging:
10 x 100 pcs

construction of the syringe

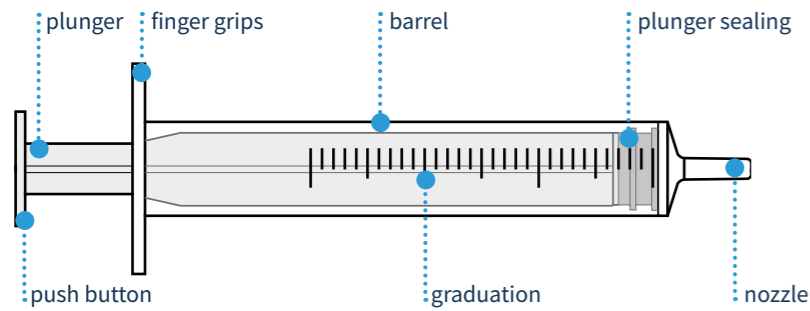

GET TO KNOW OUR SYRINGES

nozzle types:

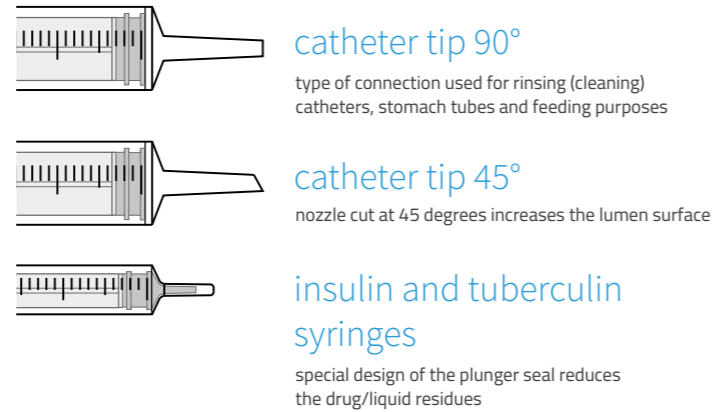
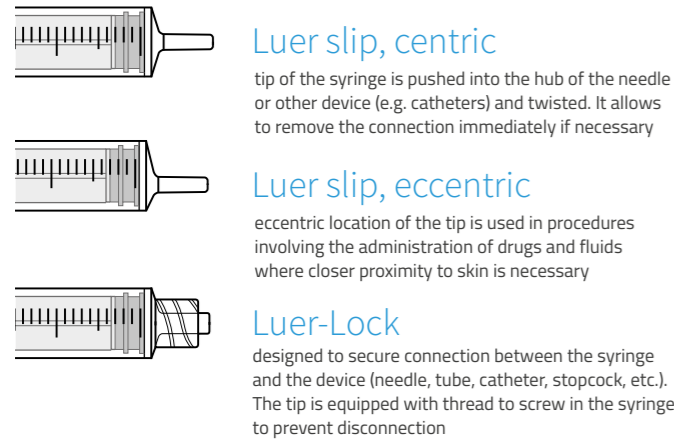

duoNEX

syringe type:



graduation type:

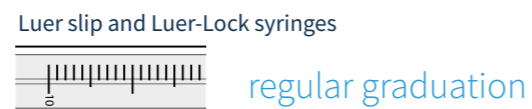

package colour and shape code:



duoNEX

single-use syringe, 2-part, Luer

features

- white line
- transparent barrel allows full visual control of content
- white contrasting plunger
- Luer nozzle centrally located in 2 ml syringe, eccentric in 5, 10, 20 ml syringes
- smooth plunger sliding
- limitation flange securing against accidental removal of plunger
- clear, legible and permanent black graduation facilitating dosage, adequately:
 - every 0,1 ml for capacity of 2 ml
 - every 0,2 ml for capacity of 5 ml
 - every 0,5 ml for capacity of 10 ml
 - every 1 ml for capacity of 20 ml
- extended graduation that includes a 10% extension of the nominal capacity
- name of syringe and manufacturer's logo placed on barrel
- non-pyrogenic, non-toxic
- packaging: 1 pc./paper-foil

indication

- 2-piece syringe for subcutaneous, intramuscular and intravenous infusions intended for drawing up and administering of medicines/liquids to patient and collecting body fluid samples from patient



REF	type	capacity	position of nozzle	intermediate packaging	bulk packaging
002ML-2CZ-B	Luer	2 ml	centric	100 pcs	30 x 100 pcs
005ML-2CZ-B	Luer	5 ml	eccentric	100 pcs	24 x 100 pcs
010ML-2CZ-B	Luer	10 ml	eccentric	100 pcs	16 x 100 pcs
020ML-2CZ-B	Luer	20 ml	eccentric	50 pcs	16 x 50 pcs



dicoNEX SN

single-use syringe, 3-part, Luer, with needle alongside the syringe

features

- in set with needle alongside the syringe
- transparent barrel allows full visual control of content, green contrasting plunger
- Luer nozzle placed centrally for 2 ml capacity, eccentric for 5, 10, 20, 50 ml capacity
- sealing in the form of double ring on plunger stopper situated on the top of plunger
- smooth plunger sliding thanks to rubber sealing
- limitation flange securing against accidental removal of plunger
- name of syringe and manufacturer's logo placed on barrel
- clear, legible and permanent black graduation facilitating dosage, adequately:
 - every 0,1 ml for capacity of 2 ml
 - every 0,2 ml for capacity of 5 ml (extended to 6 ml)
 - every 0,2 ml for capacity of 10 ml
 - every 0,5 ml for capacity of 20 ml
 - every 1 ml for capacity of 50 ml
- needle tube is made of smooth and durable stainless steel
- needle tip sharpened in three surfaces
- bevel type: LB/BL standard long bevel
- hubs coloured in accordance with ISO code
- non-toxic, non-pyrogenic

indication

- 3-piece syringe for subcutaneous, intramuscular and intravenous infusions

REF	type	capacity	position of nozzle	needle size	needle colour	intermediate packaging	bulk packaging
002ML-3CZ-SN	Luer	2 ml	centric	0,6mm x 30mm	deep blue	100 pcs	30 x 100 pcs
005ML-3CZ-SN	Luer	5 ml	eccentric	0,7mm x 30mm	black	100 pcs	24 x 100 pcs
010ML-3CZ-SN	Luer	10 ml	eccentric	0,8mm x 40mm	deep green	100 pcs	16 x 100 pcs
020ML-3CZ-SN	Luer	20 ml	eccentric	0,8mm x 40mm	deep green	50 pcs	16 x 50 pcs
050ML-3CZ-SN	Luer	50 ml	eccentric	0,8mm x 40mm	deep green	25 pcs	16 x 25 pcs



dicoNEX

single-use syringe, 3-part, Luer

features

- transparent barrel allows full visual control of content
- green contrasting plunger
- Luer nozzle
- sealing in the form of double ring on plunger stopper situated on the top of plunger
- smooth plunger sliding thanks to rubber sealing
- limitation flange securing against accidental removal of plunger
- special design of the 1 ml syringe plunger stopper reduces dead space
- name of syringe and manufacturer's logo placed on barrel
- clear, legible and permanent black graduation facilitating dosage, adequately:
 - every 0,01ml for capacity of 1ml
 - every 0,1 ml for capacity of 2 ml
 - every 0,2 ml for capacity of 5 ml
 - every 0,2 ml for capacity of 10 ml
 - every 0,5 ml for capacity of 20 ml
 - every 1 ml for capacity of 50/60 ml
- non-pyrogenic, non-toxic
- packaging: 1 pc./paper-foil

indication

- 3-piece syringe intended for drawing up and administering of medicines/liquids to patient and collecting body fluid samples from patient

REF	type	capacity	position of nozzle	intermediate packaging	bulk packaging
001ML-3CZ-BL	Luer	1 ml	centric	100 pcs	32 x 100 pcs
002ML-3CZ-BL	Luer	2 ml	centric	100 pcs	30 x 100 pcs
005ML-3CZ-BL	Luer	5 ml	centric	100 pcs	24 x 100 pcs
010ML-3CZ-BL	Luer	10 ml	centric	100 pcs	16 x 100 pcs
020ML-3CZ-BL	Luer	20 ml	eccentric	50 pcs	16 x 50 pcs
050ML-3CZ-BL	Luer	50/60 ml	eccentric	25 pcs	16 x 25 pcs



dicoNEX

single-use syringe, 3-part, Luer-Lock + amber

features

- transparent cylinder with a transparent or amber color
- green contrasting plunger (amber-coloured syringe - white contrasting plunger)
- Luer-Lock type termination
- sealing in the form of double ring on plunger stopper situated on the top of plunger
- smooth plunger sliding thanks to rubber sealing
- limitation flange securing against accidental removal of plunger
- name of syringe and manufacturer's logo placed on barrel
- clear, legible and permanent black graduation facilitating dosage
- scaling extension to 60 ml
- non-pyrogenic, non-toxic
- packaging: 1 pc./paper-foil

indication

- 3-piece syringe intended for drawing up and administering of medicines/liquids to patient and collecting body fluid samples from patient
- amber-coloured syringe is intended for drawing up and administering of photosensitive medicines

REF	type	capacity	position of nozzle	colour of plunger	intermediate packaging
050ML-3CZ-LL-PI	Luer-Lock	50/60 ml	centric	green	25 pcs

amber type

050ML-3CZ-LL-B-PI	Luer-Lock	50/60 ml	centric	white	25 pcs
-------------------	-----------	----------	---------	-------	--------

bulk packaging:
16 x 25 pcs



dicoNEX

single-use syringe, 3-part, Luer-Lock

features

- transparent barrel allows full visual control of content
- green contrasting plunger
- Luer-Lock nozzle
- sealing in the form of double ring on plunger stopper situated on the top of plunger
- smooth plunger sliding thanks to rubber sealing
- limitation flange securing against accidental removal of plunger
- name of syringe and manufacturer's logo placed on barrel
- clear, legible and permanent black graduation facilitating dosage, adequately:
 - every 0,1 ml for capacity of 3 ml
 - every 0,2 ml for capacity of 5 ml and of 10 ml
 - every 0,5 ml for capacity of 20 ml
 - every 1 ml for capacity of 30 ml
- non-pyrogenic, non-toxic
- packaging: 1 pc./paper-foil

indication

- 3-piece syringe intended for drawing up and administering of medicines/liquids to patient and collecting body fluid samples from patient

REF	type	capacity	position of nozzle	colour of plunger	intermediate packaging	bulk packaging
003ML-3CZ-LL-BL	Luer-Lock	3 ml	centric	green	100 pcs	30 x 100 pcs
005ML-3CZ-LL-BL	Luer-Lock	5 ml	centric	green	100 pcs	24 x 100 pcs
010ML-3CZ-LL-BL	Luer-Lock	10 ml	centric	green	100 pcs	16 x 100 pcs
020ML-3CZ-LL-BL	Luer-Lock	20 ml	centric	green	50 pcs	16 x 50 pcs
030ML-3CZ-LL-BL	Luer-Lock	30 ml	centric	green	50 pcs	16 x 50 pcs



dicoNEX

single-use catheter syringe, 3-part

features

- 3-piece syringe with centrally located nozzle for catheter
- made of polypropylene
- transparent barrel allows full visual control of content
- green contrasting plunger (capacity 50/60 ml)
- white contrasting plunger (capacity 100 ml)
- two Luer connectors attached
- sealing in the form of double ring on plunger stopper situated on the top of plunger
- smooth plunger sliding thanks to rubber sealing
- limitation flange securing against accidental removal of plunger
- nozzle cut at 90° (capacity 50/60 ml)
- nozzle cut at 45° (capacity 100 ml)
- catheter nozzle secured with cap (capacity 50/60 ml)
- name of syringe and manufacturer's logo placed on barrel
- extended graduation (capacity 50/60 ml)
- clear, legible and permanent black graduation facilitating dosage
- non-pyrogenic, non-toxic
- packaging: 1 pc./paper-foil

indication

- 3-piece syringe with catheter nozzle
- intended for drawing up and administering of medicines/liquids to patient and collecting body fluid samples from patient

REF	type	capacity	position of nozzle	intermediate packaging	bulk packaging
050ML-3CZ-CEW-BL	catheter tip	50/60 ml	centric	25 pcs	16 x 25 pcs
100ML-3CZ-CEW-BL	catheter tip	100 ml	centric	25 pcs	4 x 25 pcs



dicoTUBER

tuberculin syringe

features

- with bypacked needle 0,45 x 13 mm
- made entirely of polypropylene
- white contrasting plunger
- transparent barrel allows full visual control of content
- Luer nozzle
- smooth plunger sliding thanks to rubber sealing
- limitation flange securing against accidental removal of plunger
- clear, legible and permanent black graduation every 0,01 ml that allows precise dosing of medicine/liquid
- special design of plunger stopper reduces the residual volume of medicine/liquid
- name of syringe and manufacturer's logo placed on barrel
- single-use
- non-pyrogenic, non-toxic
- packaging: 1 pc./paper-foil

indication

- 3-piece syringe intended for precise drawing up and administering of medicines/liquids



REF	no. of units	capacity	intermediate packaging
TU-U20-1-BL	20	1 ml	100 pcs

 bulk packaging:
32 x 100 pcs



dicoSULIN

insulin syringe

features

- with bypacked needle 0,4 x 13 mm
- transparent barrel made of polypropylene allows full visual control of content
- sealing in the form of double ring on plunger stopper situated on the top of plunger
- smooth plunger sliding thanks to rubber sealing
- limitation flange securing against accidental removal of plunger
- special design of plunger stopper reduces the residual volume of medicine/liquid
- clear, legible and permanent black graduation facilitating dosage
- name of syringe and manufacturer's logo placed on barrel
- single-use
- non-pyrogenic, non-toxic
- packaging: 1 pc./paper-foil

indication

- 3-piece syringe for subcutaneous, intramuscular and intravenous infusions
- for insulin shots



REF	no. of units	capacity	colour of plunger	intermediate packaging
IN-U40-1-BL	40	1 ml	red	100 pcs
IN-U100-1-BL	100	1 ml	orange	100 pcs

 bulk packaging:
32 x 100 pcs



ZARYS



WWW.ZARYS.COM

INFUSION THERAPY

SANViflon

I.V. cannula

features

- needle (stylet) made of stainless steel with back-cut blade
- cannula catheter made of Teflon (FEP), equipped with 4 radiopaque lines
- cannula equipped with wings and hand-closed cap of the upper port colour coded according to size
- handle that allows you to insert with one hand
- valve that prevents blood leakage to outside after inserting the cannula into the vessel
- flashback chamber secured with a Luer-Lock cap
- available in various sizes from 14 G to 26 G
- single-use
- packaging: 1 pc. – hard blister (PVC + lacquered paper) with a colour print in accordance with the colour identification of the size

indication

- for cannulation of intravenous, peripheral vessels to:
- multiple injections of intravenous drugs
- intravenous infusion of solutions and parenteral nutrition suitable for peripheral veins
- maintain the patient's hydration and / or reduce dehydration if the patient is unable to take sufficient fluid orally
- blood transfusions and blood-like preparations
- ensuring vascular access in the event of the need for rapid drug delivery, especially during diagnostic and therapeutic procedures

REF	size [G]	size [mm]	colour	flow rate [ml/min]	intermediate packaging
KDF-06-19	26 x 3/4"	0,6 x 19	violet	17	100 pcs
KDF-07-19	24 x 3/4"	0,7 x 19	yellow	23	100 pcs
KDF-09-25	22 x 1"	0,9 x 25	blue	36	100 pcs
KDF-11-32	20 x 1 1/4"	1,1 x 32	pink	56	100 pcs
KDF-13-45	18 x 1 3/4"	1,3 x 45	green	90	100 pcs
KDF-15-45	17 x 1 3/4"	1,5 x 45	white	142	100 pcs
KDF-17-45	16 x 1 3/4"	1,7 x 45	grey	200	100 pcs
KDF-20-45	14 x 1 3/4"	2,0 x 45	orange	305	100 pcs

 bulk packaging:
10 x 100 pcs



SANViflon S

I.V. cannula without port

features

- needle (stylet) made of stainless steel with back-cut blade
- cannula catheter made of Teflon (FEP), equipped with 4 radiopaque lines
- cannula equipped with coloured fixing wings, without upper port
- handle that allows you to insert with one hand
- valve that prevents blood leakage to outside after inserting the cannula into the vessel
- flashback chamber secured with a Luer-Lock cap
- available in two sizes: 24 G and 26 G
- single-use
- packaging: 1 pc. – hard blister (PVC + lacquered paper) with a colour print in accordance with the colour identification of the size

indication

- for cannulation of intravenous, peripheral vessels to:
- multiple injections of intravenous drugs
- intravenous infusion of solutions
- maintain the patient's hydration and / or reduce dehydration if the patient is unable to take sufficient fluid orally
- ensuring vascular access in the event of the need for rapid drug delivery, especially during diagnostic and therapeutic procedures

REF	size [G]	size [mm]	colour	flow rate [ml/min]	intermediate packaging
KDFS-06-19	26 x 3/4"	0,6 x 19	violet	17	100 pcs
KDFS-07-19	24 x 3/4"	0,7 x 19	yellow	23	100 pcs

 bulk packaging:
10 x 100 pcs



easyFLOW IS PREMIUM

infusion set

NEW

features

- 2-way, sharp spike of the drip chamber with anti-slip surface that guarantees tight and reliable connection with fluid containers
- air-vent with anti-bacterial filter and blue flap
- flexible droplet chamber, size 6 cm, equipped with additional pressure wings to facilitate insertion into containers with liquids
- dropper: 20 drops = 1 ml ± 0,1 ml
- liquid filter protecting against larger particles with pore size 15 µm
- precise safe roll clamp with integrated spike holder and with a holder for securing the drain
- name of the manufacturer placed on the roll clamp
- soft, flexible drain
- universal Luer-Lock tip secured by an Air Pass plug with a hydrophobic filter, which allows the drain to be filled without accidental contamination and prevents fluid leakage
- single-use
- non-pyrogenic, non-toxic
- individual packaging: paper-foil with a colored code (blue) identifying the device type

indication

- device for fluid transfer in infusion therapy

REF	version	length
IS-BF-P	without phthalates	150 cm

 bulk packaging:
250 pcs



easyFLOW IS

infusion set

features

- 2-way sharp closure-piercing device of the drip chamber with anti-slip surface that guarantees tight and reliable connection with fluid containers/bags
- air inlet with anti-bacterial filter and coloured (blue) flap
- pliable drip chamber, size 6 cm, equipped with additional pressure wings to facilitate insertion into containers with liquids
- dropper: 20 drops = 1 ml +/- 0,1 ml
- fluid filter protecting against larger particles with pore size 15 µm
- soft, flexible tubing with Luer-Lock conical fitting
- precise safe flow regulator with integrated holder for the closure-piercing device and with hook for securing the tubing
- name of the manufacturer placed on the flow regulator
- both tips of the device additionally secured with protective caps
- single-use
- non-pyrogenic, non-toxic
- packaging: 1 pc./paper-foil with a coloured code (blue) identifying the device

indication

- device for fluid transfer in infusion therapy

REF	version	length
IS*	with phthalates	150 cm
IS-BF**	without phthalates	150 cm
NEW IS-BF-180**	without phthalates	180 cm

 bulk packaging:
250 pcs



easyFLOW IS infusion set (dual chamber)

NEW



features

- made of high quality materials, using the latest technology, which guarantees very high quality and trouble-free, intended use
- 2-way, 2-plane sharp closure-piercing device of the drip chamber with anti-slip surface that guarantees tight and reliable connection with fluid containers
- air-inlet with anti-bacterial filter and coloured (green) flap
- dropler chamber divided into a flexible lower part and a hard upper part with an additional pressure ring for easy insertion into fluid containers
- name of the manufacturer placed on the dropler chamber
- device in its entirety including the spike and tip transparent, allowing visual inspection of the flow along its entire length
- dropper: 20 drops = 1 ml ± 0,1 ml
- fluid filter protecting against larger particles with pore size 15 µm
- soft, flexible tubing with Luer-Lock conical fitting
- precise safe roll clamp with integrated spike holder and with a holder for securing the drain
- both tips of the device additionally secured with protective caps
- single-use
- non-pyrogenic, non-toxic
- individual packaging: paper-foil with a coloured code (blue) identifying the device type

indication

- device intended for connection to an intravenous line for the administration of fluids, photosensitive medicinal products solutions and other body fluids during infusion therapy

REF	version	length
IS-BF-D	without phthalates	180 cm

bulk packaging:
100 pcs



easyFLOW IS SAFE infusion set

NEW



features

- 2-way, sharp spike of the drip chamber with anti-slip surface that guarantees tight and reliable connection with fluid containers
- air-vent with anti-bacterial filter and blue flap
- flexible droplet chamber, size 6 cm, equipped with additional pressure wings to facilitate insertion into containers with liquids
- dropper: 20 drops = 1 ml ± 0,1 ml
- hydrophilic filter Liquid Lock with a mesh size of 8 µm, which automatically stops the flow when the chamber is emptied. Prevents air from entering the tubing to prevent air embolism
- soft, flexible drain with additional port for drug application
- precise safe roll clamp with integrated spike holder and with a holder for securing the drain
- universal Luer-Lock tip
- Air Pass plug with hydrophobic filter, which allows filling of the tubing without accidental contamination and protects against fluid leakage
- single-use
- non-pyrogenic, non-toxic
- individual packaging: paper-foil with a coloured code (blue) identifying the device type

indication

- device for fluid transfer in infusion therapy

REF	version	length
IS-BF-S	without phthalates	180 cm

bulk packaging:
100 pcs



easyFLOW IS ECO infusion set

features

- made of high quality materials
- 2-way sharp closure-piercing device of the drip chamber that guarantees tight and reliable connection with fluid containers
- air inlet with anti-bacterial filter and colored (blue) flap
- pliable drip chamber, size 4cm
- dropper: 20 drops = 1 ml +/- 0,1 ml
- fluid filter protecting against larger particles with pore size 15 µm
- soft, flexible tubing
- universal Luer-Lock conical fitting
- precise safe flow regulator
- both tips of the device additionally secured with protective caps
- packaging: 1pc./foil bag
- single-use
- non-pyrogenic, non-toxic

indication

- device for fluid transfer in infusion therapy

REF	version	length
IS-E*	with phthalates	150 cm
IS-BF-E**	without phthalates	150 cm
NEW IS-BF-E-180**	without phthalates	180 cm

bulk packaging:
400 pcs



easyFLOW IS AMBER infusion set, amber

NEW



features

- amber colouring of the tubing and drip chamber
- double-channel, sharp spike of the drip chamber with a matted surface with non-slip Surface guaranteeing tight and reliable connection with fluid containers/bags
- air inlet with anti-bacterial filter and coloured (blue) flap
- flexible drip chamber with length 6 cm, equipped with additional pressure wings to facilitating puncture into containers with liquids
- dropper: 20 drops = 1 ml +/- 0,1 ml
- fluid filter protecting against larger particles with pore size 15 µm
- soft and flexible drains with additional port for drug application
- precise safe roll clamp with integrated spike holder and with a holder for securing the drain with name of the manufacturer placed on the roll clamp
- single-use
- non-pyrogenic, non-toxic
- universal Luer-Lock tip
- packaging: 1 pc./paper-foil

indication

- device for fluid transfer photosensitive medicinal and other body fluids in infusion therapy

REF	version	length
IS-BF-A	without phthalates	150 cm

bulk packaging:
100 pcs



easyFLOW IS REG

infusion set with precision flow rate regulator



features

- 2-way, sharp closure-piercing device of the drip chamber with anti-slip surface that guarantees tight and reliable connection with fluid containers
- adjustable from 5 to 250 ml/h (dark blue digits on white background) for viscosities below 10% and adjustable from 5 to 200 ml/h (white digits on dark blue background) for viscosities 10%-40%
- ability to completely close (OFF) and open (ON) the flow rate
- air-inlet with anti-bacterial filter and coloured (blue) flap
- droplet chamber and drain made of phthalate-free PVC
- dropper: 20 drops = 1 ml ± 0.1 ml
- fluid filter protecting against larger particles with pore size 15 µm
- soft, flexible drain with additional port for drug application
- universal Luer-Lock tip secured by an Air Pass plug with a hydrophobic filter, which allows the drain to be filled without accidental contamination and prevents fluid leakage
- precise safe roll clamp with integrated spike holder and with a holder for securing the drain
- name of the manufacturer placed on the roll clamp
- both tips of the device additionally secured with protective caps
- single-use
- non-pyrogenic, non-toxic
- individual packaging: paper-foil with a coloured code (blue) identifying the device type

indication

- device intended for connection to an intravenous line for the administration of fluids, photosensitive medicinal products solutions and other body fluids during infusion therapy with adjustable flow control

REF	version	length
IS-RP-BF	without phthalates	180cm

bulk packaging:
100 pcs



precision flow regulator



features

- precision regulator to set the exact desired flow rate within a range of 5-250 ml/h with the possibility to completely close or open the flow rate
- two adjustment scales, differentiated by colour
- adjustment from 5 to 250 ml/h (dark blue digits on white background) for viscosities below 10% and adjustment from 5 to 200 ml/h (white digits on dark blue background) for viscosities of 10%-40%.
- additional Y port for drug administration
- luer lock termination
- both ends of the tube protected by protective caps
- single-use
- non-pyrogenic, non-toxic
- unit packaging: 1 piece paper/foil

indication

- dual scale regulator for precise administration of drugs and fluids as well as parenteral nutrition
- compatible with any infusion set model

REF	version	length
REG-BF-001	without phthalates	50 cm

bulk packaging:
200 pcs



conallhealth
Your Partner In Healthcare

easyFLOW TS PREMIUM

transfusion set



features

- 2-way sharp spike of the drip chamber with matted surface that guarantees tight and reliable connection with fluid containers
- air-vent with anti-bacterial filter and a coloured (red) flap
- flexible droplet chamber
- dropper: 20 drops = 1 ml +/- 0.1ml
- special blood filter with large area, pore size 200µm
- soft, flexible drain
- universal luer-lock drain tip secured by an Air Pass stopper with a hydrophobic filter that allow the drain to be filled without accidental contamination and protects against fluid leakage
- precise safe roll clamp with integrated spike holder and with a holder for securing the drain
- name of the manufacturer placed on the roll clamp
- both tips of the device additionally secured with protective caps
- single-use
- non-pyrogenic, non-toxic
- individual packaging: blister-pack with a coloured code (red) identifying the device type

indication

- device intended for connection to an intravenous line for the administration of blood and blood products

REF	version	length
TS-BF-P	without phthalates	150 cm

bulk packaging:
250 pcs



easyFLOW TS

transfusion set

features

- 2-way sharp closure-piercing device of the drip chamber with anti-slip surface that guarantees tight and reliable connection with containers/bags
- air inlet with anti-bacterial filter and a coloured (red) flap
- pliable drip chamber
- dropper: 20 drops = 1 ml +/- 0,1 ml
- special blood filter with large area, pore size 200 µm
- soft, flexible tubing
- universal Luer-Lock fitting at the end of tubing
- precise safe flow regulator with integrated holder for the closure-piercing device and with hook for securing the tubing
- name of the manufacturer placed on the flow regulator
- both tips of the device additionally secured with protective caps
- single-use
- non-pyrogenic, non-toxic
- packaging: 1 pc./paper-foil with a coloured code (red) identifying the device

indication

- device used for the administration of blood and blood products

REF	version	length
TS*	with phthalates	150 cm
TS-BF**	without phthalates	150 cm

bulk packaging:
250 pcs



easyFLOW LINE

extension tube for infusion pump

features

- tubing made of PVC
- device available in a transparent and amber version for photosensitive medicines
- diameter of the tubing - outer: 2,4 mm; inner: 1,24 mm
- Luer-Lock fitting - male and female
- single-use
- non-pyrogenic, non-toxic
- packaging: 1 pc./paper-foil

indication

- device used to extend infusion line

REF	colour of tube	length	intermediate packaging
P450-BF	transparent	45 cm	50 pcs
P1500-BF	transparent	150 cm	50 pcs
PB1500-BF	amber	150 cm	50 pcs

 bulk packaging:
24 x 50 pcs



needle free valve

with extension line



features

- housing made of transparent material - polycarbonate
- high-quality silicone membrane allows multiple port injections
- flat injection surface - smooth and evenly ended port membrane that facilitates disinfection
- extension line made of transparent polyurethane
- metal-free, suitable for MRI examination
- extension lines fitted with sliding clamps
- male connector protected with applicator
- total length 15 cm
- can be used for 7 days or 350 activations
- filling volume of needle-free port 0.09 ml
- dead space 0.001 ml
- resistance to injection fluid pressure 3 bar (44 PSI)
- resistance to back pressure 2 bar (29 PSI)
- single-use
- packaging: 1 pc. / paper-foil

indication

- device used to close infusion ports for multiple, needle-free injections and to protect the infusion line from contamination
- does not require using safety caps
- dedicated for standard Luer and Luer Lock connectors

REF	diameters of extension lines	flow	number of needle-free ports
PB-T/1-27	1,0 x 2,7 mm	115 ml/min	1
PB-T/1-40	3,0 x 4,0 mm	185 ml/min	1
PB-T/2-27	1,0 x 2,7 mm	100 ml/min	2
PB-T/2-40	3,0 x 4,0 mm	165 ml/min	2
PB-T/3-27	1,0 x 2,7 mm	100 ml/min	3
PB-T/3-40	3,0 x 4,0 mm	160 ml/min	3
PB-T/4-27	1,0 x 2,7 mm	65 ml/min	4
PB-T/4-40	3,0 x 4,0 mm	135 ml/min	4

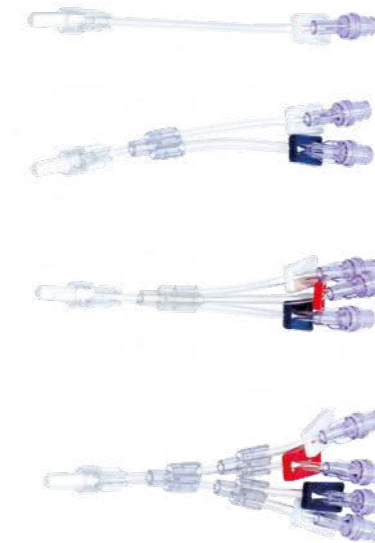

 bulk packaging:
20 x 50 pcs



needle-free valve

features

- body made of transparent material - polycarbonate
- high-quality silicone membrane allows multiple port injections
- flat injection surface - smooth and evenly ended port membrane that facilitates disinfection
- metal-free, suitable for MRI examination
- male connector of the transparent port is secured with a cap allowing for aseptic removal of the item from the packaging*
- may be used for 7 days or up to 350 activations
- priming capacity: 0.09 ml
- high flow rate: 350 ml/min
- withstands injection fluid pressure of 3 bars (44 PSI)
- withstands back pressure of 2 bars (29 PSI)
- single-use
- packaging: 1 pc./paper-foil

indication

- intended for closing infusion ports
- device intended for multiple, needle-free injections (liquid drug administration, blood sample taking)
- protects infusion lines from contamination and infection during infusion therapy
- does not require using safety caps
- dedicated for standard Luer and Luer Lock connectors

REF	colour	intermediate packaging
PB-N	blue	100 pcs
PB-T	transparent	100 pcs

 bulk packaging:
20 x 100 pcs



3-way stopcock

features

- made of polycarbonate
- transparent housing
- clear optical identifier of open/close position (marked flow directions) operating in 360 degrees
- consistent, straight flow channels and an optimal internal diameter ensure correct pressure measurement
- rotating male Luer-Lock
- all inlets protected with caps
- resistant to lipids
- single-use
- non-pyrogenic, non-toxic
- packaging: 1 pc./paper-foil

indication

- device designed for managing the flow of infusion fluids during administration
- enables switching the infusion flow path
- for blood pressure monitoring
- for direct medicine/fluid supply

REF	colour	intermediate packaging
KT-002	blue	50 pcs

 bulk packaging:
20 x 50 pcs



3-way stopcock with extension tube

features

- three-way stopcock with an extension tube of various lengths (from 7 cm to 100 cm)
- transparent housing
- clear optical identifier of open/close position (marked flow directions)
- three-way stopcock made of polycarbonate, extension tube made of PVC
- all inlets protected with caps
- resistant to lipids
- single-use
- non-pyrogenic, non-toxic
- packaging: 1 pc./paper-foil

indication

- device designed for managing the flow of infusion fluids during administration
- enables switching the infusion flow path
- for blood pressure monitoring
- for direct medicine/fluid supply

REF	length of tube	intermediate packaging
KTP-7	7 cm	50 pcs
KTP-10	10 cm	50 pcs
KTP-25	25 cm	50 pcs
KTP-50	50 cm	50 pcs
KTP-75	75 cm	50 pcs
KTP-100	100 cm	50 pcs

 bulk packaging:
20 x 50 pcs



ZARYS



WWW.ZARYS.COM

cannula stopper

features

- precisely and safely closes standard ports
- Luer-Lock stopper has only one male tip
- combi stopper with male and female tip especially dedicated for securing Luer Lock fitting in infusion and transfusion sets
- single-use
- non-pyrogenic
- packaging: 1 pc./paper-foil

indication

- as a stopper of intravenous cannulas, ports and catheters
- intended to be used in combination with other devices during infusion therapy, protecting against the outflow of blood through the cannula and protecting against contamination and infection

REF	type	intermediate packaging	bulk packaging
KDKLL	Luer-Lock	250 pcs	10 x 250 pcs
KDKC	combi	100 pcs	50 x 100 pcs



OXYGEN THERAPY

nasal oxygen cannula

features

- made of medical PVC
- very soft tips with smooth edges
- fastening under the chin with a soft, sliding adjustment ring
- various spacing of the nasal part of the cannula depending on the size
- universal connector compatible with any source of oxygen
- tubing with star cross-section that is resistant to bending
- available in 3 sizes: for adults, for children and for infants with 140 cm, 200 cm, 300 cm and 500 cm long tubing
- single-use
- packaging: 1 pc./foil

indication

- designed to deliver oxygen through the nose

REF	length of tubing	purpose	intermediate packaging	bulk packaging
CTNN-200	200 cm	for infants	25 pcs	10 x 25 pcs
CTNZ-200	200 cm	for children	25 pcs	10 x 25 pcs
CTND-140	140 cm	for adults	30 pcs	10 x 30 pcs
CTND-200	200 cm	for adults	25 pcs	10 x 25 pcs
CTND-300	300 cm	for adults	15 pcs	10 x 15 pcs
CTND-500	500 cm	for adults	10 pcs	10 x 10 pcs

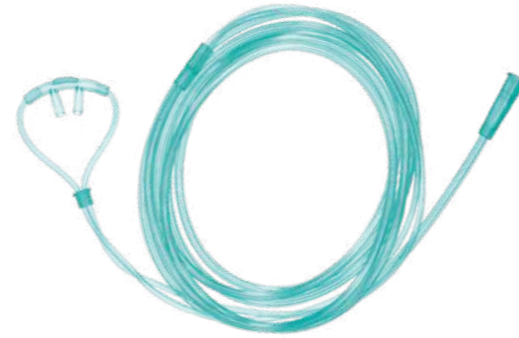

non-rebreather mask

with tubing

features

- made of transparent, non-toxic PVC
- adjustable nose metal plate and rubber fastening
- equipped with a 210 cm (+/- 5%) long tubing with universal connectors
- tubing with star cross-section that is resistant to bending
- 1000 ml oxygen reservoir
- revolving connector that allows adjusting to patient's position
- silicone valves on the connector and ventilation openings
- single-use
- packaging: 1 pc./paper-foil

indication

- designed to deliver oxygen with precise regulation of concentration, for high oxygen concentration

REF	length of tubing	size
MTW-S	210 cm +/- 5%	S
MTW-M	210 cm +/- 5%	M
MTW-L	210 cm +/- 5%	L
MTW-XL	210 cm +/- 5%	XL

bulk packaging:
50 x 1 pc.



oxygen tubing

features

- made of transparent, non-toxic PVC
- tubing with star cross-section that is resistant to bending, with reinforcing straps along the entire length
- standardized connectors at the end of the tubing allowing connection to oxygen devices
- single-use
- packaging: 1 pc./paper-foil

indication

- for transporting oxygen from an oxygen source to another medical device for oxygen supply, e.g. oxygen mask

REF	length of tubing	bulk packaging
DT2100	210 cm +/- 2%	100 x 1 pc.
DT4260	426 cm +/- 2%	50 x 1 pc.
DT7620	762 cm +/- 2%	25 x 1 pc.



multi-vent mask

with tubing

features

- made of transparent, non-toxic PVC
- adjustable nose metal plate and rubber fastening
- equipped with a 210 cm (+/- 5%) long tubing with universal connectors
- tubing with star cross-section that is resistant to bending
- equipped with 2 jets - white to set mid flow concentration (35%, 40% and 50%) and green to set low concentration (24%, 26%, 28% and 30%)
- single-use
- packaging: 1 pc./foil

indication

- designed to deliver oxygen with precise regulation of concentration, regardless of way of patient's breathing

REF	length of tubing	size
MTVR-L	210 cm +/- 5%	L
MTVR-XL	210 cm +/- 5%	XL

bulk packaging:
100 x 1 pc.



oxygen mask

with tubing

features

- made of transparent, non-toxic PVC
- adjustable nose metal plate and rubber fastening
- equipped with a 210 cm (+/- 5%) long tubing with universal connectors
- tubing with star cross-section that is resistant to bending
- revolving connector that allows adjusting to patient's position
- single-use
- packaging: 1 pc./paper-foil

indication

- designed to deliver oxygen with precise regulation of concentration, for medium oxygen concentration

REF	length of tubing	size
MTS-S	210 cm +/- 5%	S
MTS-M	210 cm +/- 5%	M
MTS-L	210 cm +/- 5%	L
MTS-XL	210 cm +/- 5%	XL

bulk packaging:
50 x 1 pc.



nebulizer mask

with tubing

features

- made of transparent, non-toxic PVC
- adjustable nose metal plate and rubber fastening
- equipped with a 210 cm (+/- 5%) long tubing with universal connectors
- tubing with star cross-section that is resistant to bending
- 8 ml nebulizer (graduated every 1 ml)
- average size of the molecule at a flow of 6l/min - 3,23 µm
- single-use
- packaging: 1 pc./paper-foil

indication

- for producing aerosol containing a comminuted medicine, that can be delivered directly to the respiratory system as the patient breathes

REF	length of tubing	size
MTN-S	210 cm +/- 5%	S
MTN-M	210 cm +/- 5%	M
MTN-L	210 cm +/- 5%	L
MTN-XL	210 cm +/- 5%	XL

bulk packaging:
50 x 1 pc.



nebulizer

with T F/M adaptor, mouthpiece,
corrugated tube and tubing

features

- made of non-toxic materials
- 210 cm long, bend-resistant tubing with star-shaped cross-section
- nebuliser with a 6ml capacity (graduated every 1ml), producing particles with an average size of MMAD = 3.91 µm at a flow rate of 6 l/min.
- nebuliser, tubing, T-adaptor, mouthpiece, one-way valve and corrugated tube included in a kit
- universal T-adaptor with a diameter of 22M/15F - 22F enables the kit to be connected to endotracheal, tracheostomy tube or breathing circuit and perform nebulisation on mechanically ventilated patients
- the universal (detachable) mouthpiece allows nebulisation to be given to patients who are breathing on their own
- silicone one-way valve (detachable) reduces medication waste during nebulisation
- single-use
- packaging: 1 pc./foil

indication

- device is designed to produce an aerosol containing fragmented medication, which can be delivered deep into the respiratory system with the patient's inhalation
- enables nebulisation to be carried out in mechanically ventilated patients by connecting directly to the endotracheal tube, tracheostomy tube or inspiratory arm of the ventilator breathing system
- allows you to perform nebulisation in patient „on one's own breath“

REF	length of tubing
NUTR	210 cm +/- 5%

 bulk packaging:
100 x 1 pc.



ZARYS



WWW.ZARYS.COM

ANAESTHESIA PRODUCTS

endotracheal tube

uncuffed

• features

- made of flexible PVC
- radiopaque line over the entire tube length
- equipped with lateral Murphy eye
- graduated every 1 cm
- double depth marker to control the position of the tube
- tube size marked in 3 places (on the connector and in two places on the tube body)
- detachable connector with an outer diameter of 15 mm
- single-use
- packaging: 1 pc./paper-foil

• indication

- for both oral and nasal intubation
- inserted into the trachea to prevent airway obstruction and respiratory failure



REF	size	intermediate packaging
RIB-20	I.D. (mm) 2.0	20 pcs
RIB-25	I.D. (mm) 2.5	20 pcs
RIB-30	I.D. (mm) 3.0	20 pcs
RIB-35	I.D. (mm) 3.5	20 pcs
RIB-40	I.D. (mm) 4.0	20 pcs
RIB-45	I.D. (mm) 4.5	20 pcs
RIB-50	I.D. (mm) 5.0	20 pcs
RIB-55	I.D. (mm) 5.5	20 pcs
RIB-60	I.D. (mm) 6.0	20 pcs
RIB-65	I.D. (mm) 6.5	20 pcs
RIB-70	I.D. (mm) 7.0	20 pcs
RIB-75	I.D. (mm) 7.5	20 pcs
RIB-80	I.D. (mm) 8.0	20 pcs
RIB-85	I.D. (mm) 8.5	20 pcs
RIB-90	I.D. (mm) 9.0	20 pcs
RIB-95	I.D. (mm) 9.5	20 pcs
RIB-100	I.D. (mm) 10.0	20 pcs



bulk packaging:
10 x 20 pcs

endotracheal tube

cuffed



• features

- made of thermoplastic flexible PVC
- radiopaque line over the entire tube length
- equipped with lateral Murphy eye
- graduated every 1 cm
- double depth marker to control the position of the tube – 2 rings
- equipped with a low-pressure, high-volume sealing cuff
- tube size marked in three places (on the connector and in two places on the body of the tube)
- name of the manufacturer affixed to the product
- control balloon, marked with batch and size number
- detachable connector with an external diameter of 15 mm
- banana-type packaging, maintaining the anatomical shape of the tube
- single-use
- packing: 1 pc / paper-foil

• indication

- for both oral and nasal intubation
- inserted into the trachea to prevent airway obstruction and respiratory failure

REF	size	intermediate packaging
ETTC25	I.D. (mm) 2.5	10 pcs
ETTC30	I.D. (mm) 3.0	10 pcs
ETTC35	I.D. (mm) 3.5	10 pcs
ETTC40	I.D. (mm) 4.0	10 pcs
ETTC45	I.D. (mm) 4.5	10 pcs
ETTC50	I.D. (mm) 5.0	10 pcs
ETTC55	I.D. (mm) 5.5	10 pcs
ETTC60	I.D. (mm) 6.0	10 pcs
ETTC65	I.D. (mm) 6.5	10 pcs
ETTC70	I.D. (mm) 7.0	10 pcs
ETTC75	I.D. (mm) 7.5	10 pcs
ETTC80	I.D. (mm) 8.0	10 pcs
ETTC85	I.D. (mm) 8.5	10 pcs
ETTC90	I.D. (mm) 9.0	10 pcs
ETTC95	I.D. (mm) 9.5	10 pcs
ETTC100	I.D. (mm) 10.0	10 pcs

bulk packaging:
10 x 10 pcs



endotracheal tube

uncuffed



• features

- made of thermoplastic flexible PVC
- radiopaque line over the entire tube length
- equipped with lateral Murphy eye
- graduated every 1 cm
- double depth marker to control the position of the tube – 2 rings
- tube size marked in three places (on the connector and in two places on the body of the tube)
- name of the manufacturer affixed to the product
- detachable connector with an external diameter of 15 mm
- banana-type packaging, maintaining the anatomical shape of the tube
- single-use
- packing: 1 pc / paper-foil

• indication

- for both oral and nasal intubation
- inserted into the trachea to prevent airway obstruction and respiratory failure



REF	size	intermediate packaging
ETT20	I.D. (mm) 2.0	10 pcs
ETT25	I.D. (mm) 2.5	10 pcs
ETT30	I.D. (mm) 3.0	10 pcs
ETT35	I.D. (mm) 3.5	10 pcs
ETT40	I.D. (mm) 4.0	10 pcs
ETT45	I.D. (mm) 4.5	10 pcs
ETT50	I.D. (mm) 5.0	10 pcs
ETT55	I.D. (mm) 5.5	10 pcs
ETT60	I.D. (mm) 6.0	10 pcs
ETT65	I.D. (mm) 6.5	10 pcs
ETT70	I.D. (mm) 7.0	10 pcs
ETT75	I.D. (mm) 7.5	10 pcs
ETT80	I.D. (mm) 8.0	10 pcs
ETT85	I.D. (mm) 8.5	10 pcs
ETT90	I.D. (mm) 9.0	10 pcs
ETT95	I.D. (mm) 9.5	10 pcs
ETT100	I.D. (mm) 10.0	10 pcs



bulk packaging:
10 x 10 pcs

reinforced endotracheal tube

cuffed

features

- made of flexible PVC
- reinforcing within the wall of the entire tube
- equipped with lateral Murphy eye and radiopaque line over the entire tube length
- graduated every 1 cm, double depth marker to control the position of the tube
- tube size marked in 4 places (on the connector, on the pilot balloon and in two places on the tube body)
- indissociable connector with an outer diameter of 15 mm
- single-use
- packaging: 1 pc./paper-foil

indication

- for both oral and nasal intubation
- inserted into the trachea to prevent airway obstruction and respiratory failure
- for intubation of the patient in an unusual position, with a high risk of kinking the endotracheal tube

REF	size	intermediate packaging
RIMZP-30	I.D. (mm) 3.0	10 pcs
RIMZP-35	I.D. (mm) 3.5	10 pcs
RIMZP-40	I.D. (mm) 4.0	10 pcs
RIMZP-45	I.D. (mm) 4.5	10 pcs
RIMZP-50	I.D. (mm) 5.0	10 pcs
RIMZP-55	I.D. (mm) 5.5	10 pcs
RIMZP-60	I.D. (mm) 6.0	10 pcs
RIMZP-65	I.D. (mm) 6.5	10 pcs
RIMZP-70	I.D. (mm) 7.0	10 pcs
RIMZP-75	I.D. (mm) 7.5	10 pcs
RIMZP-80	I.D. (mm) 8.0	10 pcs
RIMZP-85	I.D. (mm) 8.5	10 pcs
RIMZP-90	I.D. (mm) 9.0	10 pcs
RIMZP-95	I.D. (mm) 9.5	10 pcs
RIMZP-100	I.D. (mm) 10.0	10 pcs

bulk packaging:
10 x 10 pcs



bulk packaging:
10 x 20 pcs

endotracheal tube

cuffed

features

- made of flexible PVC
- equipped with lateral Murphy eye and radiopaque line over the entire tube length
- graduated every 1 cm, double depth marker to control the position of the tube
- low-pressure, high-volume cuff
- tube size marked in 4 places (on the connector, on the pilot balloon and in two places on the tube body)
- detachable connector with an outer diameter of 15 mm
- pilot balloon with LOT and size indication
- single-use
- packaging: 1 pc./paper-foil

indication

- for both oral and nasal intubation
- inserted into the trachea to prevent airway obstruction and respiratory failure



intubation stylet

features

- made of PVC-coated aluminium
- special material for both stiffness and pliability
- intended for use during difficult intubation
- size and diameter markings
- soft distal tip
- single-use
- packaging: 1 pc./paper-foil

indication

- allows you to give the endotracheal tube the right curvature
- introduced to the endotracheal tube facilitates intubation in routine and difficult cases, when the laryngeal inlet is not visible

REF	size	diameter	length	tube size	intermediate packaging
PRI-06	6 Fr	2,0 mm	310 mm (±10)	from 2,0 to 4,0	20 pcs
PRI-10	10 Fr	3,3 mm	390 mm (±10)	from 4,5 to 6,5	20 pcs
PRI-14	14 Fr	4,7 mm	390 mm (±10)	from 7,0 to 10,0	20 pcs

bulk packaging:
20 x 20 pcs



tracheal tube introducer

curved

features

- made of medical grade low density polyethylene
- curved and rounded tip enables safe intubation without damaging the soft tissues
- optimum flexibility and rigidity facilitate correct insertion and safe removal of the introducer after intubation
- imprint of the size, diameter and manufacturer's name on the device
- bright yellow body for increased visibility of the introducer in the tracheal tube canal
- clear, easy to read graduation every 1 cm
- available in three sizes and lengths
- single-use
- PVC free
- packaging: 1 pc./paper-foil

indication

- for use during difficult intubation procedures
- as an aid to facilitate the insertion of the endotracheal tube during standard intubation

REF	size	diameter O.D.	total length	tube size	graduation	intermediate packaging
PTIZ-06-535	6 Fr	2,0 mm	535 mm	from 2,0 to 4,0	10 - 45 mm	10 pcs
PTIZ-10-600	10 Fr	3,3 mm	600 mm	from 4,5 to 6,0	10 - 50 mm	10 pcs
PTIZ-10-800	10 Fr	3,3 mm	800 mm	from 4,5 to 6,0	10 - 60 mm	10 pcs
PTIZ-15-600	15 Fr	5,0 mm	600 mm	from 6,5 to 10,0	10 - 50 mm	10 pcs
PTIZ-15-800	15 Fr	5,0 mm	800 mm	from 6,5 to 10,0	10 - 60 mm	10 pcs

bulk packaging:
20 x 10 pcs



endotracheal tube holder

features

- made of high-quality materials
- universal Velcro fasteners enabling fast and effective fixing of the holder around the head
- adjustable handle allows for easy and fast fixation of every size of endotracheal tube
- special design of the bite-piece prevents patient trauma or damaging the tube (by biting)
- additional opening allows for chyme, saliva and blood suction from the oral cavity
- single-use
- packaging: 1 pc./paper-foil

indication

- to stabilize the position of the endotracheal tube after its insertion into the trachea

REF	version	colour
SRI-N	horizontal fixation	blue-red
SRI-A	vertical fixation	green

bulk packaging:
100 x 1 pc.



oropharyngeal airway/guedel airway

features

- made of high quality PE (polyethylene), free of PVC
- distinctive anatomical curve of airway tube allows for the opening of the upper respiratory tract and the free flow of anaesthetic gases, air
- colour coded sizes
- numeric marking of the size on the airway
- single-use
- packaging: 1 pc./foil

indication

- used during artificial ventilation procedures to ensure the airway patency
- as a tool for paramedic to assist in the management of a casualty's airway which increases the effectiveness of the rescue operation
- facilitates the stabilization of the endotracheal tube and protects it against biting

REF	size	number	colour	intermediate packaging
RG-40	40 mm	000	pink	50 pcs
RG-50	50 mm	00	dark blue	50 pcs
RG-60	60 mm	0	black	50 pcs
RG-70	70 mm	1	white	50 pcs
RG-80	80 mm	2	green	50 pcs
RG-90	90 mm	3	yellow	50 pcs
RG-100	100 mm	4	red	50 pcs
RG-110	110 mm	5	blue	50 pcs
RG-120	120 mm	6	orange	50 pcs

bulk packaging:
10 x 50 pcs



laryngeal mask

PVC

features

- made of medical PVC
- elastic mask body with description (size, cuff volume, suggested patient's weight)
- elliptic shape, flexible sealing cuff and universal, transparent connector: 15 mm
- colour-coded valve protection makes it easy to quickly recognize size
- single-use
- compatible with magnetic resonance (MR)
- no metal elements
- packaging: 1 pc./paper-foil

indication

- device inserted through the mouth, up to the back of the throat, forms a seal at the top of the glottis in order to:
 - direct protecting the patient's airway patency
 - artificial ventilation also during cardiopulmonary resuscitation
 - maintaining airway patency in: short-term surgical procedures, without the need of muscles relaxation, when endotracheal intubation is not necessary and under anesthesia for diagnostic procedures

REF	size	colour of valve protection	weight of patient	max. inflation	intermediate packaging
MKPJ-10	1	pink	≤ 5 kg	4 ml	5 pcs
MKPJ-15	1.5	orange	5-10 kg	7 ml	5 pcs
MKPJ-20	2	dark green	10-20 kg	10 ml	5 pcs
MKPJ-25	2.5	brown	20-30 kg	14 ml	5 pcs
MKPJ-30	3	green	30-50 kg	20 ml	5 pcs
MKPJ-40	4	purple	50-70 kg	30 ml	5 pcs
MKPJ-50	5	dark blue	70-100 kg	40 ml	5 pcs

bulk packaging:
10 x 5 pcs



laryngeal mask

silicone

features

- made of biocompatible silicone, which ensures excellent flexibility of the device
- elastic mask body with description (size, cuff volume, suggested patient's weight)
- elliptic shape, flexible sealing cuff and universal, transparent connector: 15 mm
- single-use
- compatible with magnetic resonance (MR)
- no metal elements
- packaging: 1 pc./paper-foil

indication

- device inserted through the mouth, up to the back of the throat, forms a seal at the top of the glottis in order to:
 - direct protecting the patient's airway patency
 - artificial ventilation also during cardiopulmonary resuscitation
 - maintaining airway patency in: short-term surgical procedures, without the need of muscles relaxation, when endotracheal intubation is not necessary and under anesthesia for diagnostic procedures

REF	size	weight of patient	max. inflation	intermediate packaging
MKSJ-10	1	≤ 5 kg	4 ml	5 pcs
MKSJ-15	1.5	5-10 kg	7 ml	5 pcs
MKSJ-20	2	10-20 kg	10 ml	5 pcs
MKSJ-25	2.5	20-30 kg	14 ml	5 pcs
MKSJ-30	3	30-50 kg	20 ml	5 pcs
MKSJ-40	4	50-70 kg	30 ml	5 pcs
MKSJ-50	5	70-100 kg	40 ml	5 pcs

 bulk packaging:
10 x 5 pcs



tracheostomy tube

cuffed

features

- made of medical, flexible PVC
- swivel 15 mm connector
- flexible neckplates with slits for strap insertion to secure tube position
- soft, low-pressure, thin-walled cuff
- pilot balloon in contrasting colour clearly indicates the level of the cuff's inflation
- 2 fixation straps protected with foil
- clear size marking on the neckplates
- atraumatic, soft rounded tip, curved cannula
- radiopaque line
- equipped with obturator
- single-use
- packaging: 1 pc./rigid blister

indication

- to control respiratory tracts in people after tracheostomy
- introduced to the airways by a surgical incision of the tracheal's front wall to allow ventilation
- provides free breathing bypassing the nose, throat and larynx

REF	size	intermediate packaging
RTM-40	4.0	10 pcs
RTM-45	4.5	10 pcs
RTM-50	5.0	10 pcs
RTM-60	6.0	10 pcs
RTM-65	6.5	10 pcs
RTM-70	7.0	10 pcs
RTM-75	7.5	10 pcs
RTM-80	8.0	10 pcs
RTM-85	8.5	10 pcs
RTM-90	9.0	10 pcs
RTM-95	9.5	10 pcs
RTM-100	10.0	10 pcs

 bulk packaging:
10 x 10 pcs



air cushion anaesthetic mask

features

- due to the high quality of materials used, ventilation is conducted in an atraumatic and safe way for the patient
- anatomically shaped inflatable cuff, ensures perfect tightness of the mask with minimal pressure
- device, when applied to the face, tightly covers the patient's mouth and nose without compressing the eyes
- clear shell provides continuous visual observation of the patient
- colour-coded retaining rings, easy for size recognition
- retaining ring can be removed when it is not needed
- full size range allows to properly choose the size of the mask depending on the age of the patient
- all sizes are equipped with inflatable check valve to adjust air amount for best cushion fitting auto patient's face
- single-use
- packaging: 1 pc./foil

indication

- intended for the administration of a gas mixture coming through devices for artificial ventilation
- enables performing medical procedures including artificial ventilation, administration of anesthetic gas and carrying out emergency treatment of an unconscious patient

REF	size	age of patient/size	colour	bulk packaging
MAP-0	0	neonate	white	200 x 1 pc.
MAP-1	1	infant	pink	200 x 1 pc.
MAP-2	2	pediatric	yellow	150 x 1 pc.
MAP-3	3	adult S	green	150 x 1 pc.
MAP-4	4	adult M	red	100 x 1 pc.
MAP-5	5	adult L	blue	100 x 1 pc.
MAP-6	6	adult XL	orange	80 x 1 pc.



anaesthetic mask with open seal

features

- due to the high quality of materials used, ventilation is conducted in an atraumatic and safe way for the patient
- anatomically shaped open seal made of TPE ensures perfect tightness of the mask with minimal pressure
- polypropylene, transparent mask dome allows continuous visual observation of the patient
- device, when applied to the face, tightly covers the patient's mouth and nose without compressing the eyes
- size embossed on the body and colour-coded seal
- full size range allows to properly choose the size of the mask depending on the age of the patient
- single-use
- packaging: 1 pc./medical foil

indication

- device intended for the administration of a gas mixture coming through devices for artificial ventilation
- enables performing medical procedures including artificial ventilation, administration of anesthetic gas and carrying out emergency treatment of an unconscious patient
- device used in hospitals (operating theaters, intensive care units, emergency departments) as well as during pre-hospital care by rescue teams carrying out rescue operations in an unconscious patient

catalogue number	size	age of patient	seal colour	connector	bulk packaging
MAO-1	1	infant	blue	15 mm	200 x 1 pc.
MAO-2	2	pediatric	orange	15 mm	150 x 1 pc.
MAO-3	3	small adult	pink	22 mm	150 x 1 pc.
MAO-4	4	medium adult	white	22 mm	100 x 1 pc.
MAO-5	5	large adult	yellow	22 mm	100 x 1 pc.
MAO-6	6	very large adult	green	22 mm	80 x 1 pc.



catheter mount with double swivel elbow connector

features

- smooth bore type made of medical PVC
- expandable type made of high quality PE, EVA
- universal patient connection: 22M/15F
- ventilation device side connector: 15M or 22F
- expandable version characterized by shape memorizing and by the ability to control the position of the connector
- double swivel elbow connector
- port for suctioning and bronchoscope secured with a stopper
- available in versions: smooth bore and expandable
- single-use
- packaging: 1 pc./paper-foil

indication

- used to connect the tracheostomy tube or endotracheal tube with the breathing circuit of the ventilation device
- provides greater mobility and rotation of the connection, increasing patient comfort and safety



REF	type	connection	length (without connectors)	intermediate packaging
PM-15-G	smooth bore (not expandable)	22M/15F-15M	15 cm	10 pcs
PM-22-G	smooth bore (not expandable)	22M/15F-22F	15 cm	10 pcs
PMR-15-K	expandable	22M/15F-15M	8-15 cm	10 pcs
PMR-22-K	expandable	22M/15F-22F	8-15 cm	10 pcs

 bulk packaging:
10 x 10 pcs



dual-limb breathing circuit

features

- made of high quality EVA material, without PVC
- 15F/22M and 22F universal connector fits compatible products and devices for mechanical ventilation or anesthesia machine
- expandable arms with maximum length of 160 cm
- adjustable length of circuit enabling adjustment of length of respiratory system and optimization of dead space
- equipped with latex-free breathing bag: 3l (for adults) or 1l (for children)
- additional expandable tube, length: 100 cm
- elbow with Luer-Lock port
- single-use
- packaging: 1 pc./foil

indication

- for patient's mechanical ventilation
- it enables transporting breathing mixture from equipment (ventilator, anesthesia machine) to respiratory protection device (e.g. tracheal tube, tracheostomy mask) and vice versa

with bag

REF	purpose	capacity of bag	 bulk packaging
OBWD-1601L	for children	1 liter	50x1 pc
OBWD-1603L	for adults	3 liters	40x1 pc

without bag

REF	purpose	length of circuit (min/max)	tube diameter
OBP-160	for children	60 cm / 160 cm	15 mm
OBD-160	for adults	60 cm / 160 cm	22 mm

 bulk packaging:
40 x 1 pc.



ZARYS



WWW.ZARYS.COM

SUCTION CATHETERS, STOMACH TUBES

suction catheter with vacuum control

features

- made of soft and flexible PVC, that is resistant to bending and kinking
- frozen surface prevents the catheter from sticking to the wall of the endotracheal tube
- full control over the suction
- atraumatic, soft rounded, open tip
- tip with two alternating lateral eyes with smooth edges
- colour-coded connectors for size recognition, numerical size identification on the packaging
- single-use
- packaging: 1 pc./paper-foil

indication

- device designed for suction of secretions from the upper respiratory tract

REF	size	length	colour	intermediate packaging
CO-A06-60	CH 6	600 mm	light green	50 pcs
CO-A08-60	CH 8	600 mm	blue	50 pcs
CO-A10-60	CH 10	600 mm	black	50 pcs
CO-A12-60	CH 12	600 mm	white	50 pcs
CO-A14-60	CH 14	600 mm	green	50 pcs
CO-A16-60	CH 16	600 mm	orange	50 pcs
CO-A18-60	CH 18	600 mm	red	50 pcs



bulk packaging:
10 x 50 pcs

suction catheter with frozen surface

features

- made of soft and flexible PVC, that is resistant to bending and kinking
- frozen surface enabling easy insertion
- atraumatic, soft rounded, open tip
- tip with two opposite lateral eyes with smooth edges
- colour-coded connectors for size recognition, numerical size identification on the packaging
- single-use
- packaging: 1 pc./paper-foil

indication

- device designed for suction of secretions from the upper respiratory tract
- recommended for source of suction with its own suction force regulation

REF	size	length	colour	intermediate packaging
CO-BF-ZP-B06-40	CH 6	400 mm	light green	50 pcs
CO-BF-ZP-B06-60	CH 6	600 mm	light green	50 pcs
CO-BF-ZP-B08-40	CH 8	400 mm	blue	50 pcs
CO-BF-ZP-B08-60	CH 8	600 mm	blue	50 pcs
CO-BF-ZP-B10-40	CH 10	400 mm	black	50 pcs
CO-BF-ZP-B10-60	CH 10	600 mm	black	50 pcs
CO-BF-ZP-B12-60	CH 12	600 mm	white	50 pcs
CO-BF-ZP-B14-60	CH 14	600 mm	green	50 pcs
CO-BF-ZP-B16-60	CH 16	600 mm	orange	50 pcs
CO-BF-ZP-B18-60	CH 18	600 mm	red	50 pcs
CO-BF-ZP-B20-60	CH 20	600 mm	yellow	50 pcs
CO-BF-ZP-B22-60	CH 22	600 mm	purple	50 pcs
CO-BF-ZP-B24-60	CH 24	600 mm	dark blue	50 pcs



bulk packaging:
10 x 50 pcs

suction catheter

features

- made of soft and flexible PVC, that is resistant to bending and kinking
- frozen surface prevents the catheter from sticking to the wall of the endotracheal tube
- atraumatic, soft rounded, open tip
- tip with two alternating lateral eyes with smooth edges
- colour-coded connectors for size recognition, numerical size identification on the packaging
- single-use
- packaging: 1 pc./paper-foil

indication

- device designed for suction of secretions from the upper respiratory tract
- recommended for source of suction with its own suction force regulation

REF	size	length	colour	intermediate packaging
CO-B06-40	CH 6	400 mm	light green	50 pcs
CO-B08-40	CH 8	400 mm	blue	50 pcs
CO-B10-40	CH 10	400 mm	black	50 pcs
CO-B12-50	CH 12	500 mm	white	50 pcs
CO-B12-60	CH 12	600 mm	white	50 pcs
CO-B14-50	CH 14	500 mm	green	50 pcs
CO-B14-60	CH 14	600 mm	green	50 pcs
CO-B16-50	CH 16	500 mm	orange	50 pcs
CO-B16-60	CH 16	600 mm	orange	50 pcs
CO-B18-50	CH 18	500 mm	red	50 pcs
CO-B18-60	CH 18	600 mm	red	50 pcs
CO-B20-50	CH 20	500 mm	yellow	50 pcs
CO-B20-60	CH 20	600 mm	yellow	50 pcs
CO-B22-50	CH 22	500 mm	purple	50 pcs
CO-B22-60	CH 22	600 mm	purple	50 pcs



bulk packaging:
10 x 50 pcs

feeding tube graduated, with X-ray contrast

features

- made of soft PVC with a frosted surface, resistant to bending and kinking due to the appropriate degree of hardness
- atraumatic, soft rounded, closed tip facilitates precise insertion of catheter
- two alternate end holes with gently stretched edges
- connector compatible with the conical tip of Luer syringe
- integrated stopper allows the tube to be closed tightly
- colour-coded connectors for size recognition, numerical size identification on packaging
- radiopaque line along the entire length of the catheter
- digital depth graduation every 1 cm (from 5 cm to 40 cm)
- length 50 cm
- name of the manufacturer placed on the catheter
- individually packed straight
- single-use
- packaging: 1 pc. / paper-foil

indication

- device inserted through patient's nose or mouth to perform enteral nutrition

REF	size	length	colour	intermediate packaging
CKS-04-50	CH 4	500 mm	red	100 pcs
CKS-05-50	CH 5	500 mm	grey	100 pcs
CKS-06-50	CH 6	500 mm	pink	100 pcs
CKS-08-50	CH 8	500 mm	pale green	100 pcs
CKS-10-50	CH 10	500 mm	black	100 pcs



bulk packaging:
10 x 100 pcs

stomach tube/duodenal tube

features

- made of PVC
- made of material that is resistant to bending and kinking due to the appropriate degree of hardness
- atraumatic, soft rounded closed tip
- four lateral eyes with smooth edges
- colour-coded connectors for size recognition, numerical size identification on packaging
- stomach tube is available in 3 lengths: 80 cm, 100 cm, 125 cm and duodenal tube is available in 150 cm length
- single-use
- packaging: 1 pc./paper-foil

indication

- inserted through nose or mouth into stomach or duodenum
- drainage of stomach/intestinal content
- decompression of stomach (air or food evacuation)
- gastric lavage
- taking samples of stomach content
- control of bleeding from the upper section of digestive tract
- evaluation of secretory function
- administration of medicines, fluids and/or food content into stomach or duodenum



REF	size	length	colour	intermediate packaging	bulk packaging
* ZZ-80/CH05	CH 5	800 mm	grey	35 pcs	20 x 35 pcs
* ZZ-80/CH06	CH 6	800 mm	light green	35 pcs	20 x 35 pcs
ZZ-80/CH08	CH 8	800 mm	blue	35 pcs	20 x 35 pcs
ZZ-80/CH10	CH 10	800 mm	black	35 pcs	20 x 35 pcs
ZZ-80/CH12	CH 12	800 mm	white	35 pcs	20 x 35 pcs
ZZ-80/CH14	CH 14	800 mm	green	30 pcs	20 x 30 pcs
ZZ-80/CH16	CH 16	800 mm	orange	30 pcs	20 x 30 pcs
ZZ-80/CH18	CH 18	800 mm	red	25 pcs	20 x 25 pcs
ZZ-80/CH20	CH 20	800 mm	yellow	15 pcs	20 x 15 pcs
ZZ-80/CH22	CH 22	800 mm	purple	15 pcs	20 x 15 pcs
ZZ-80/CH24	CH 24	800 mm	dark blue	15 pcs	20 x 15 pcs
* ZZ-100/CH05	CH 5	1000 mm	grey	30 pcs	20 x 30 pcs
* ZZ-100/CH06	CH 6	1000 mm	light green	30 pcs	20 x 30 pcs
ZZ-100/CH08	CH 8	1000 mm	blue	30 pcs	20 x 30 pcs
ZZ-100/CH10	CH 10	1000 mm	black	30 pcs	20 x 30 pcs
ZZ-100/CH12	CH 12	1000 mm	white	30 pcs	20 x 30 pcs
ZZ-100/CH14	CH 14	1000 mm	green	25 pcs	20 x 25 pcs
ZZ-100/CH16	CH 16	1000 mm	orange	20 pcs	20 x 20 pcs
ZZ-100/CH18	CH 18	1000 mm	red	15 pcs	20 x 15 pcs
ZZ-100/CH20	CH 20	1000 mm	yellow	15 pcs	20 x 15 pcs
ZZ-100/CH22	CH 22	1000 mm	purple	10 pcs	20 x 10 pcs
ZZ-100/CH24	CH 24	1000 mm	dark blue	10 pcs	20 x 10 pcs
* ZZ-125/CH05	CH 5	1250 mm	grey	30 pcs	20 x 30 pcs
* ZZ-125/CH06	CH 6	1250 mm	light green	30 pcs	20 x 30 pcs
ZZ-125/CH08	CH 8	1250 mm	blue	30 pcs	20 x 30 pcs
ZZ-125/CH10	CH 10	1250 mm	black	30 pcs	20 x 30 pcs
ZZ-125/CH12	CH 12	1250 mm	white	20 pcs	20 x 20 pcs
ZZ-125/CH14	CH 14	1250 mm	green	25 pcs	20 x 25 pcs
ZZ-125/CH16	CH 16	1250 mm	orange	20 pcs	20 x 20 pcs
ZZ-125/CH18	CH 18	1250 mm	red	20 pcs	20 x 20 pcs
ZZ-125/CH20	CH 20	1250 mm	yellow	15 pcs	20 x 15 pcs
ZZ-125/CH22	CH 22	1250 mm	purple	10 pcs	20 x 10 pcs
ZZ-125/CH24	CH 24	1250 mm	dark blue	10 pcs	20 x 10 pcs
* ZD-150/CH5	CH 5	1500 mm	grey	30 pcs	20 x 30 pcs
* ZD-150/CH6	CH 6	1500 mm	light green	30 pcs	20 x 30 pcs
* ZD-150/CH8	CH 8	1500 mm	blue	30 pcs	20 x 30 pcs
* ZD-150/CH10	CH 10	1500 mm	black	30 pcs	20 x 30 pcs
* ZD-150/CH12	CH 12	1500 mm	white	30 pcs	20 x 30 pcs
* ZD-150/CH14	CH 14	1500 mm	green	20 pcs	20 x 20 pcs
* ZD-150/CH16	CH 16	1500 mm	orange	15 pcs	20 x 15 pcs
* ZD-150/CH18	CH 18	1500 mm	red	15 pcs	20 x 15 pcs
ZD-150/CH20	CH 20	1500 mm	yellow	10 pcs	20 x 10 pcs
ZD-150/CH22	CH 22	1500 mm	purple	10 pcs	20 x 10 pcs
ZD-150/CH24	CH 24	1500 mm	dark blue	10 pcs	20 x 10 pcs

* 
available
on request



ZARYS



WWW.ZARYS.COM

UROLOGICAL CATHETERS, URINE BAGS

Foley catheter

2-way, silicone-coated latex

features

- made of soft and flexible latex, that is resistant to bending and kinking
- atraumatic, soft rounded, special tip facilitating insertion of the catheter to the bladder
- tip with two lateral eyes with smooth edges
- universal urine drainage port of the catheter fits into standard connectors in urine bags
- silicone-coated surface that allows atraumatic insertion of the catheter
- easy to fill and to empty, tear-resistant balloon of various capacities
- plastic or rubber valve to ensure balloon tightness
- CH 6, CH 8, CH 10 size has a guide to facilitate catheterization
- single-use
- packaging: 1 pc./double packaging: internal- foil, external- paper-foil

indication

- to drain urine from the bladder

with plastic valve

REF	length	balloon	size	colour	intermediate packaging
CFNL-2D-06-03-P	270 mm	3 ml	CH 6	light green	10 pcs
CFNL-2D-08-05-P	270 mm	3-5 ml	CH 8	blue	10 pcs
CFNL-2D-10-05-P	270 mm	3-5 ml	CH 10	black	10 pcs
CFNL-2D-12-10-P	400 mm	5-10 ml	CH 12	white	10 pcs
CFNL-2D-14-10-P	400 mm	5-10 ml	CH 14	green	10 pcs
CFNL-2D-16-10-P	400 mm	5-10 ml	CH 16	orange	10 pcs
CFNL-2D-18-10-P	400 mm	5-10 ml	CH 18	red	10 pcs
CFNL-2D-20-10-P	400 mm	5-10 ml	CH 20	yellow	10 pcs
CFNL-2D-22-10-P	400 mm	5-10 ml	CH 22	purple	10 pcs
CFNL-2D-24-10-P	400 mm	5-10 ml	CH 24	dark blue	10 pcs
CFNL-2D-12-30-P	400 mm	30 ml	CH 12	white	10 pcs
* CFNL-2D-26-30-P	400 mm	30 ml	CH 26	pink	10 pcs
CFNL-2D-28-30-P	400 mm	30 ml	CH 28	brown	10 pcs
* CFNL-2D-30-30-P	400 mm	30 ml	CH 30	grey	10 pcs
CFNL-2D-14-50-P	400 mm	30-50 ml	CH 14	green	10 pcs
CFNL-2D-16-50-P	400 mm	30-50 ml	CH 16	orange	10 pcs
CFNL-2D-18-50-P	400 mm	30-50 ml	CH 18	red	10 pcs
CFNL-2D-20-50-P	400 mm	30-50 ml	CH 20	yellow	10 szt.
CFNL-2D-22-50-P	400 mm	30-50 ml	CH 22	purple	10 pcs
CFNL-2D-24-50-P	400 mm	30-50 ml	CH 24	dark blue	10 pcs
CFNL-2D-26-50-P	400 mm	30-50 ml	CH 26	pink	10 pcs
CFNL-2D-28-50-P	400 mm	30-50 ml	CH 28	brown	10 pcs
CFNL-2D-30-50-P	400 mm	30-50 ml	CH 30	grey	10 pcs



with rubber valve

REF	length	balloon	size	colour	intermediate packaging
CFNL-2D-06-03-L	270 mm	3 ml	CH 6	light green	10 pcs
CFNL-2D-08-05-L	270 mm	3-5 ml	CH 8	blue	10 pcs
CFNL-2D-10-05-L	270 mm	3-5 ml	CH 10	black	10 pcs
CFNL-2D-12-10-L	400 mm	5-10 ml	CH 12	white	10 pcs
CFNL-2D-14-10-L	400 mm	5-10 ml	CH 14	green	10 pcs
CFNL-2D-16-10-L	400 mm	5-10 ml	CH 16	orange	10 pcs
CFNL-2D-18-10-L	400 mm	5-10 ml	CH 18	red	10 pcs
CFNL-2D-20-10-L	400 mm	5-10 ml	CH 20	yellow	10 pcs
CFNL-2D-22-10-L	400 mm	5-10 ml	CH 22	purple	10 pcs
CFNL-2D-24-10-L	400 mm	5-10 ml	CH 24	dark blue	10 pcs
CFNL-2D-26-10-L	400 mm	5-10 ml	CH 26	pink	10 pcs
CFNL-2D-16-30-L	400 mm	30 ml	CH 16	orange	10 pcs
CFNL-2D-18-30-L	400 mm	30 ml	CH 18	red	10 pcs
CFNL-2D-20-30-L	400 mm	30 ml	CH 20	yellow	10 pcs
CFNL-2D-22-30-L	400 mm	30 ml	CH 22	purple	10 pcs
CFNL-2D-24-30-L	400 mm	30 ml	CH 24	dark blue	10 pcs
CFNL-2D-26-30-L	400 mm	30 ml	CH 26	pink	10 pcs



bulk packaging:
40 x 10 pcs

* available
on request



bulk packaging:
50 x 10 pcs

Foley catheter

3-way, silicone-coated latex

features

- made of soft and flexible latex, that is resistant to bending and kinking
- universal urine drainage port of the catheter fits into standard connectors in urine bags
- additional inlet for flushing out the bladder
- atraumatic, soft rounded, special tip facilitating insertion of the catheter to the bladder
- tip with two lateral eyes with smooth edges
- silicone-coated surface that allows atraumatic insertion of the catheter
- easy to fill and to empty, tear-resistant balloon
- plastic valve to ensure balloon tightness
- single-use
- packaging: 1 pc./double packaging: internal- foil, external- paper-foil

indication

- to drain urine from the bladder

REF	length	balloon	size	colour	intermediate packaging
CFNL-3D-16-30-P	400 mm	30 ml	CH 16	orange	10 pcs
CFNL-3D-18-30-P	400 mm	30 ml	CH 18	red	10 pcs
CFNL-3D-20-30-P	400 mm	30 ml	CH 20	yellow	10 pcs
CFNL-3D-22-30-P	400 mm	30 ml	CH 22	purple	10 pcs
CFNL-3D-24-30-P	400 mm	30 ml	CH 24	dark blue	10 pcs
* CFNL-3D-26-30-P	400 mm	30 ml	CH 26	pink	10 pcs



bulk packaging:
40 x 10 pcs

* available
on request



Foley catheter

2-way with tiemann tip, silicone-coated latex

features

- made of soft and flexible latex, that is resistant to bending and kinking
- universal urine drainage port of the catheter fits into standard connectors in urine bags
- angled tip makes it easier to overcome obstacles in the urinary tract
- tip with two lateral eyes with smooth edges
- silicone-coated surface that allows atraumatic insertion of the catheter
- easy to fill and to empty, tear-resistant balloon
- plastic valve to ensure balloon tightness
- single-use
- packaging: 1 pc./double packaging: internal- foil, external- paper-foil

indication

- to drain urine from the bladder in the case of a narrowed urethra

REF	length	balloon	size	colour	intermediate packaging
CFTL-2D-12-10-P	400 mm	5-10 ml	CH 12	white	10 pcs
CFTL-2D-14-10-P	400 mm	5-10 ml	CH 14	green	10 pcs
CFTL-2D-16-10-P	400 mm	5-10 ml	CH 16	orange	10 pcs
CFTL-2D-18-10-P	400 mm	5-10 ml	CH 18	red	10 pcs
CFTL-2D-20-10-P	400 mm	5-10 ml	CH 20	yellow	10 pcs
CFTL-2D-22-10-P	400 mm	5-10 ml	CH 22	purple	10 pcs
CFTL-2D-24-10-P	400 mm	5-10 ml	CH 24	dark blue	10 pcs
CFTL-2D-12-30-P	400 mm	30 ml	CH 12	white	10 pcs
CFTL-2D-14-30-P	400 mm	30 ml	CH 14	green	10 pcs
CFTL-2D-16-30-P	400 mm	30 ml	CH 16	orange	10 pcs
CFTL-2D-18-30-P	400 mm	30 ml	CH 18	red	10 pcs
CFTL-2D-20-30-P	400 mm	30 ml	CH 20	yellow	10 pcs



bulk packaging:
40 x 10 pcs



Foley catheter

2-way, 100% silicone

features

- made of soft and flexible silicone, that reduces the allergic reaction of the mucous membranes and increases the patient's comfort
- atraumatic, soft rounded, special tip facilitating insertion of the catheter to the bladder
- tip with two lateral eyes with smooth edges
- universal urine drainage port of the catheter fits into standard connectors in urine bags
- radiopaque line along the entire length of the catheter
- easy to fill and to empty, tear-resistant balloon of various capacities
- plastic valve to ensure balloon tightness
- CH 6, CH 8, CH 10 size has a nylon guide to facilitate catheterization
- available in version with 10 ml sterile water pre-filled syringe with 10% glycerin to seal the balloon
- separately packed Catheter Spigot inside the packaging
- single-use
- packaging: 1 pc./double packaging: internal- foil, external- paper-foil
- intermediate packaging: 10 pcs for REF: CFNS-2D-XX-XX-P, 5 pcs for REF: CFNSG-2D-XX-XX-P
- bulk packaging: 40 x 10 pcs for REF: CFNS-2D-XX-XX-P, 50 x 5 pcs for REF: CFNSG-2D-XX-XX-P

indication

- to drain urine from the bladder
- recommended for patients with blood clots or sediment in their urine

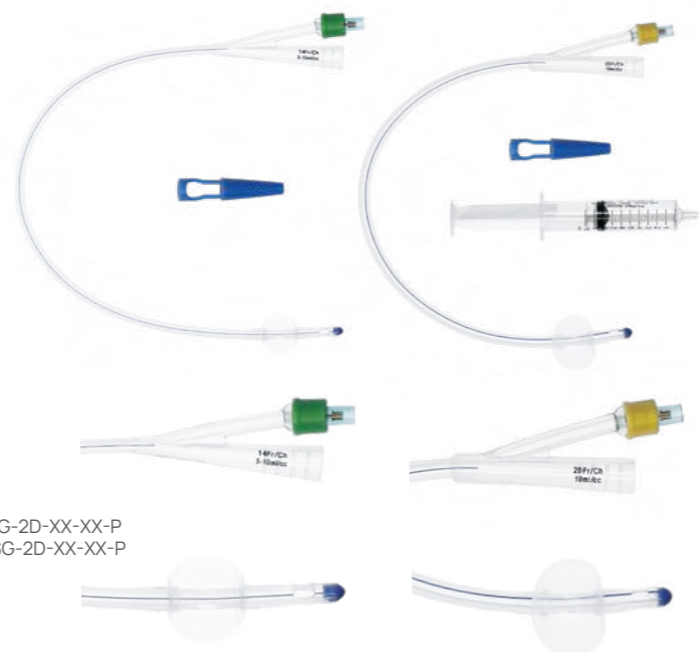

REF	intermediate packaging	REF for pre-filled syringe	intermediate packaging	length	balloon	size	colour
CFNS-2D-06-03-P*	10 pcs	CFNSG-2D-06-03-P	5 pcs	310 mm	3 ml	CH 6	pink
CFNS-2D-08-05-P*	10 pcs	CFNSG-2D-08-05-P	5 pcs	310 mm	3-5 ml	CH 8	black
CFNS-2D-10-05-P*	10 pcs	CFNSG-2D-10-05-P	5 pcs	310 mm	3-5 ml	CH 10	grey
CFNS-2D-12-10-P*	10 pcs	CFNSG-2D-12-10-P	5 pcs	400 mm	5-10 ml	CH 12	white
CFNS-2D-14-10-P*	10 pcs	CFNSG-2D-14-10-P	5 pcs	400 mm	5-10 ml	CH 14	green
CFNS-2D-16-10-P*	10 pcs	CFNSG-2D-16-10-P	5 pcs	400 mm	5-10 ml	CH 16	orange
CFNS-2D-18-10-P*	10 pcs	CFNSG-2D-18-10-P	5 pcs	400 mm	5-10 ml	CH 18	red
CFNS-2D-20-10-P*	10 pcs	CFNSG-2D-20-10-P	5 pcs	400 mm	5-10 ml	CH 20	yellow
CFNS-2D-22-10-P*	10 pcs	CFNSG-2D-22-10-P	5 pcs	400 mm	5-10 ml	CH 22	purple
CFNS-2D-24-10-P*	10 pcs	CFNSG-2D-24-10-P	5 pcs	400 mm	5-10 ml	CH 24	dark blue



bulk packaging:
50 x 5 pcs

bulk packaging:
*40 x 10 pcs

Nelaton catheter

features

- made of soft and flexible PVC, that is resistant to bending and kinking
- frozen surface for easier insertion
- semi-transparent tube (catheters available in a transparent version for better visual inspection)
- atraumatic, soft rounded, closed tip facilitating insertion of the catheter to the bladder
- tip with two lateral eyes with smooth edges
- colour-coded connectors for size recognition, numerical size identification on the packaging
- single-use
- packaging: 1 pc./paper-foil

indication

- for urinary bladder catheterization

REF for frozen tube	intermediate packaging	REF for NEW! transparent tube	intermediate packaging	length	size	colour
CN-06-40**	50 pcs	CNP-06-40*	50 pcs	400 mm	CH 6	light green
CN-08-40**	50 pcs	CNP-08-40*	50 pcs	400 mm	CH 8	blue
CN-10-40**	50 pcs	CNP-10-40*	50 pcs	400 mm	CH 10	black
CN-12-40**	50 pcs	CNP-12-40*	50 pcs	400 mm	CH 12	white
CN-14-40**	50 pcs	CNP-14-40*	50 pcs	400 mm	CH 14	green
CN-16-40**	50 pcs	CNP-16-40*	50 pcs	400 mm	CH 16	orange
CN-18-40**	50 pcs	CNP-18-40*	50 pcs	400 mm	CH 18	red
CN-20-40**	50 pcs	CNP-20-40*	50 pcs	400 mm	CH 20	yellow
CN-22-40**	50 pcs	CNP-22-40*	50 pcs	400 mm	CH 22	purple
CN-24-40**	50 pcs	CNP-24-40*	50 pcs	400 mm	CH 24	dark blue



bulk packaging:
10 x 50 pcs



Foley catheter

3-way, 100% silicone

features

- made of soft and flexible silicone, that reduces the allergic reaction of the mucous membranes and increases the patient's comfort
- universal urine drainage port of the catheter fits into standard connectors in urine bags
- additional inlet for flushing out the bladder
- atraumatic, soft rounded, special tip facilitating insertion of the catheter to the bladder
- tip with two lateral eyes with smooth edges
- radiopaque line along the entire length of the catheter
- easy to fill and to empty, tear-resistant balloon
- plastic valve to ensure balloon tightness
- separately packed Catheter Spigot inside the packaging
- single-use
- packaging: 1 pc./double packaging: internal- foil, external- paper-foil

indication

- to drain urine from the bladder
- recommended for patients with blood clots or sediment in their urine

REF	length	balloon	size	colour	intermediate packaging
CFNS-3D-16-30-P	400 mm	30 ml	CH 16	orange	10 pcs
CFNS-3D-18-30-P	400 mm	30 ml	CH 18	red	10 pcs
CFNS-3D-20-30-P	400 mm	30 ml	CH 20	yellow	10 pcs
CFNS-3D-22-30-P	400 mm	30 ml	CH 22	purple	10 pcs
CFNS-3D-24-30-P	400 mm	30 ml	CH 24	dark blue	10 pcs

bulk packaging:
40 x 10 pcs



Tiemann catheter

features

- made of soft and flexible PVC, that is resistant to bending and kinking
- atraumatic, soft rounded, special tip facilitating insertion of the catheter to the bladder
- tip with two lateral eyes with smooth edges
- cone-shaped angled tip, bent at an angle of 45°
- transparent tube allowing visual inspection of excreted urine
- colour-coded connectors for size recognition, numerical size identification on the packaging
- single-use
- packaging: 1 pc./paper-foil

indication

- to drain urine from the bladder in the case of a narrowed urethra

REF	length	size	colour	intermediate packaging	bulk packaging
CT-08-40	400 mm	CH 8	blue	60 pcs	10 x 60 pcs
CT-10-40	400 mm	CH 10	black	60 pcs	10 x 60 pcs
CT-12-40	400 mm	CH 12	white	50 pcs	10 x 50 pcs
CT-14-40	400 mm	CH 14	green	50 pcs	10 x 50 pcs
CT-16-40	400 mm	CH 16	orange	50 pcs	10 x 50 pcs
CT-18-40	400 mm	CH 18	red	40 pcs	10 x 40 pcs
CT-20-40	400 mm	CH 20	yellow	40 pcs	10 x 40 pcs
CT-22-40	400 mm	CH 22	purple	40 pcs	10 x 40 pcs
CT-24-40	400 mm	CH 24	dark blue	40 pcs	10 x 40 pcs



Pezzer catheter

silicone-coated latex

features

- made of soft and flexible silicone-coated latex, resistant to bending and kinking
- atraumatic, soft rounded, special tip facilitating insertion of the catheter to the bladder
- tip with three lateral eyes with smooth edges
- single-use
- packaging: 1 pc./double packaging: internal- foil, external- paper-foil

indication

- to secure proper urinary drainage directly from the bladder or kidney in patients after surgical procedures
- introduced by the surgical wound, it is used for permanent urinary drainage, facilitating wound healing

REF	length	size	intermediate packaging
CP-12-40	400 mm	CH 12	10 pcs
CP-14-40	400 mm	CH 14	10 pcs
CP-16-40	400 mm	CH 16	10 pcs
CP-18-40	400 mm	CH 18	10 pcs
CP-20-40	400 mm	CH 20	10 pcs
CP-22-40	400 mm	CH 22	10 pcs
CP-24-40	400 mm	CH 24	10 pcs
CP-26-40	400 mm	CH 26	10 pcs
CP-28-40	400 mm	CH 28	10 pcs
CP-30-40	400 mm	CH 30	10 pcs
CP-32-40	400 mm	CH 32	10 pcs
CP-34-40	400 mm	CH 34	10 pcs
CP-36-40	400 mm	CH 36	10 pcs
CP-38-40	400 mm	CH 38	10 pcs
CP-40-40	400 mm	CH 40	10 pcs

 bulk packaging:
40 x 10 pcs



samples taking urine bag

features

- latex-free bag with a capacity of 100 ml, size 19 cm x 7 cm
- made of delicate, durable PE foil
- easy-to-read scale, adequate for diuresis measurement, highly accurate - every 10 ml
- adhesive part of the bag coated with anti-allergic, high-quality glue
- additional sealing made of anti-allergic foam that protects against the wall sticking of the bag, thanks to which free flow of urine is possible
- single-use
- packaging: 1 pc./foil

indication

- for urine sample collection in infants and small children

REF	capacity	purpose	version	intermediate packaging
WMCH-001	100 ml	for boys	with sponge	100 pcs
WMCH-002	100 ml	for boys	without sponge	100 pcs
WMDZ-001	100 ml	for girls	with sponge	100 pcs
WMDZ-002	100 ml	for girls	without sponge	100 pcs

 bulk packaging:
25 x 100 pcs



urine bag

features

- latex-free 2000 ml bag made of 0,22 mm thick PVC (double wall)
- double sealed PVC for maximum protection against tearing the bag
- effective non-return valve
- tight T-valve, that can be easily operated with one hand
- connecting tubing with universal stepped connector, standard tubing length 90 cm and 150 cm
- tubing made of material that is resistant to bending and kinking and which ensures a free and effective urine outflow
- precise, easy-to-read scale (every 100 ml), adequate for diuresis measurement
- strengthened holes for hanging, matching standard hangers
- white back wall making urine easy to notice
- single-use
- packaging: 1 pc./foil

indication

- for 24-hour extracorporeal collection of urine and other body fluids
- maximum time of use - 24 hours

REF	capacity	length of tubing	intermediate packaging
WMD2000-90	2000 ml	90 cm	10 pcs
WMD2000-150	2000 ml	150 cm	10 pcs

 bulk packaging:
25 x 10 pcs



urine bag

with sample port

features

- latex-free 2000 ml bag made of 0,40 mm thick PVC (double wall)
- effective non-return valve
- tight T-valve, that can be easily operated with one hand
- connecting tubing with universal stepped connector, standard tubing length 120 cm (other lengths available: 90 cm, 150 cm)
- tubing made of material that is resistant to bending and kinking and which ensures a free and effective urine outflow
- self-tightening port for sample taking
- precise, easy-to-read scale, adequate for diuresis measurement, with high measurement accuracy from 25 ml, every 50 ml from 50 ml to 200 ml and every 100 ml to 2000 ml
- strengthened holes for hanging, matching standard hangers
- white back wall making urine easy to notice
- single-use
- packaging: 1 pc./paper-foil

indication

- for extracorporeal collection of urine and other body fluids
- maximum time of use - 7 days

REF	capacity	length of tubing	intermediate packaging
WMT2000-90	2000 ml	90 cm	10 pcs
WMT2000-120	2000 ml	120 cm	10 pcs
WMT2000-150	2000 ml	150 cm	10 pcs

 bulk packaging:
10 x 10 pcs



urine bag hanger

features

- made of strong and durable plastic
- special clamp that prevents tube bending
- suitable for round and square bed rails
- two handles on each side for hanging urine bags of various sizes
- manufacturer's name placed on the device
- single-use

indication

- for hanging standard urine collection bags



REF	intermediate packaging	bulk packaging:
WNM01	50 pcs	4 x 50 pcs



urine bag

with sample port 2W

features

- latex-free 2000 ml bag made of medical grade PVC
- white back wall making urine easy to notice
- effective non-return valve
- tight T-valve, that can be easily operated with one hand and which can be folded and tucked in a hard sheath
- Pasteur type droplet chamber providing a „dry“ air barrier
- two hydrophobic air filters (in a bag and chamber), which prevent sucking, balancing the pressure inside the system
- 120 cm long, large diameter tubing, ensuring a free and effective urinary outflow with a universal stepped connector
- self-tightening port for sample taking at the end of tubing
- tubing equipped with a sliding clamp and a fastening pin to stabilize the tubing
- at the place where the tubing connects to the chamber, an additional reinforcing element prevents bending and kinking the tubing
- precise, easy-to-read scale, adequate for diuresis measurement, with high measurement accuracy, every 25 ml from 25 ml to 100 ml and every 100 ml from 100 ml to 2000 ml
- tag to describe the patient's details and date
- integrated universal hanger system matching the round and square bed rails
- additional fixing with a string
- single-use
- packaging: 1 pc./paper-foil

indication

- device is intended for 14-days urine collection in a closed system



REF	capacity	length of tubing	bulk packaging:
WM2T2000-120	2000 ml	120 cm	40 pcs



ZARYS



WWW.ZARYS.COM

GENERAL SURGERY

Yankauer surgical suction cannula

standard CH21

features

- completely transparent for full possibility of observing the sucked secretion
- light and perfectly balanced handle ensures high comfort of work and reduces hand fatigue
- perfectly smooth inner surface prevents blocking or retaining the sucked content, ensuring correct and optimal flow
- cannula with double bend of curvature
- four lateral eyes, which prevent the tip from sticking to the tissues and one central opening
- universal stepped connector ensures tight connection with a wide range of suction connecting tubes
- single-use
- packaging: 1 pc./double packaging: internal- foil, external- paper-foil

indication

- evacuating secretions and body fluids from the operating field in general surgery

REF	features	packaging	intermediate packaging
KO-00204	without suction control	1 pc.	50 pcs
KO-00214	with suction control	1 pc.	50 pcs

bulk packaging:
4 x 50 pcs



Yankauer surgical suction cannula

bulb tip CH23

features

- cannula with bulb tip with four lateral eyes, which prevent the tip from sticking to the tissues and one central opening
- completely transparent for full possibility of observing the sucked secretion
- light and perfectly balanced handle ensures high comfort of work and reduces hand fatigue
- perfectly smooth inner surface prevents blocking or retaining the sucked content, ensuring correct and optimal flow
- cannula with double bend of curvature
- universal stepped connector ensures tight connection with a wide range of suction connecting tubes
- single-use
- packaging: 1 pc./double packaging: internal- foil, external- paper-foil

indication

- evacuating secretions and body fluids from the operating field in general surgery

REF	features	packaging	intermediate packaging
KO-00104	without suction control	1 pc.	50 pcs
KO-00114	with suction control	1 pc.	50 pcs

bulk packaging:
4 x 50 pcs



surgical suction tube

features

- made of soft and flexible PVC
- along the tube a special longitudinal reinforcement to prevent bending and sucking of the tube
- perfectly smooth inner surface of tube prevents the sucked content from settling on the walls, ensuring correct and optimal flow
- connector type funnel-funnel cut-to-fit with the possibility of cutting in the marked places of the connector and matching to any type of medical suction device (for the diameter of 8 mm to 18 mm)
- funnel connector equipped with a special bending system, enabling convenient manipulation of the tube
- tube connectors compatible with the standard suction cannulas, enabling their reliable, effective and tight connection
- single-use
- packaging: 1 pc./double packaging: internal- foil, external- paper-foil

indication

- device designed for connecting the suction cannula to medical suction device
- Kapkon connector – designed to connect the catheter for aspiration of upper respiratory tract to medical suction device

REF	size	length of tube	connector
DO-24201	CH24	210 cm	funnel-funnel
DO-24301	CH24	300 cm	funnel-funnel
DO-30201	CH30	210 cm	funnel-funnel
DO-30301	CH30	300 cm	funnel-funnel
DO-24204	CH24	210 cm	funnel-funnel cut-to-fit
DO-24202	CH24	210 cm	funnel-Kapkon

Connectors guide

bulk packaging:
50 x 1 pc.



FUNNEL-FUNNEL CONNECTOR



FUNNEL-FUNNEL CUT-TO-FIT CONNECTOR 3-STEP CONNECTOR TO CUT

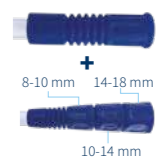

FUNNEL-KAPKON CONNECTOR



surgical suction set

with Yankauer cannula, standard

CANNULA

- completely transparent for full possibility of observing the sucked secretion
- light and perfectly balanced handle ensures high comfort of work and reduces hand fatigue
- perfectly smooth inner surface prevents blocking or retaining the sucked content, ensuring correct and optimal flow
- cannula with double bend of curvature
- four lateral eyes, which prevent the tip from sticking to the tissues and one central opening
- universal stepped connector ensures tight connection with a wide range of suction connecting tubes

TUBE

- made of soft and flexible PVC
- along the tube a special longitudinal reinforcement to prevent bending and sucking of the tube
- perfectly smooth inner surface of tube prevents the sucked content from settling on the walls, ensuring correct and optimal flow
- connector type funnel-funnel cut-to-fit with the possibility of cutting in the marked places of the connector and matching to any type of medical suction device (for the diameter of 8 mm to 18 mm)
- funnel connector equipped with a special bending system, enabling convenient manipulation of the tube
- tube connectors compatible with the standard suction cannulas, enabling their reliable, effective and tight connection

features

- available with or without suction control
- single-use
- packaging: 1 set/double packaging: internal- foil, external- paper-foil

indication

- evacuating secretions and body fluids from the operating field in general surgery

REF	size	length of tube	connector
ZO-212400104	CH21/CH24	210 cm	without suction control, funnel-funnel
ZO-212400114	CH21/CH24	210 cm	with suction control, funnel-funnel
ZO-402423104	CH21/CH24	400 cm	without suction control, funnel-funnel
ZO-402423114	CH21/CH24	400 cm	with suction control, funnel-funnel
ZO-2124001041	CH21/CH24	210 cm	without suction control, funnel-funnel cut-to-fit
ZO-2124001141	CH21/CH24	210 cm	with suction control, funnel-funnel cut-to-fit



bulk packaging:
50 x 1 set

surgical suction set

with Yankauer cannula, bulb tip

CANNULA

- cannula with bulb tip with four lateral eyes, which prevent the tip from sticking to the tissues and one central opening
- completely transparent for full possibility of observing the sucked secretion
- light and perfectly balanced handle ensures high comfort of work and reduces hand fatigue
- perfectly smooth inner surface prevents blocking or retaining the sucked content, ensuring correct and optimal flow
- cannula with double bend of curvature
- universal stepped connector ensures tight connection with a wide range of suction connecting tubes

TUBE

- made of soft and flexible PVC
- along the tube a special longitudinal reinforcement to prevent bending and sucking of the tube
- perfectly smooth inner surface of tube prevents the sucked content from settling on the walls, ensuring correct and optimal flow
- connector type funnel-funnel cut-to-fit with the possibility of cutting in the marked places of the connector and matching to any type of medical suction device (for the diameter of 8 mm to 18 mm)
- funnel connector equipped with a special bending system, enabling convenient manipulation of the tube
- tube connectors compatible with the standard suction cannulas, enabling their reliable, effective and tight connection

features

- available with or without suction control
- single-use
- packaging: 1 set/double packaging: internal- foil, external- paper-foil

indication

- evacuating secretions and body fluids from the operating field in general surgery



REF	size	length of tube	connector
ZO-2124002041	CH23/CH24	210 cm	without suction control, funnel-funnel cut-to-fit
ZO-2124002141	CH23/CH24	210 cm	with suction control, funnel-funnel cut-to-fit
ZO-3024002041	CH23/CH24	300 cm	without suction control, funnel-funnel cut-to-fit
ZO-3024002141	CH23/CH24	300 cm	with suction control, funnel-funnel cut-to-fit

 bulk packaging:
50 x 1 set



ZARYS



WWW.ZARYS.COM

BASIC PRODUCTS FOR GYNECOLOGY

vaginal speculum

cusco type

features

- both blades made of transparent polystyrene
- locking bolt made of polyethylene
- blades position blocked by a quarter turn of the Locking bolt (without screwing in the bolt)
- perfectly smooth and streamlined edges
- colour coded bolts depending on the size
- single-use
- packaging: 1 pc./foil

indication

- device designed for gynecological examination of the cervix and vagina

REF	width	colour	size
WG-XXS	16 mm	yellow	XXS
WG-XS	20 mm	white	XS
WG-S	24 mm	blue	S
WG-M	26 mm	red	M
WG-L	30 mm	green	L
WG-XL	32 mm	black	XL

 bulk packaging:
100 pcs



cervical brush

special

features

- broom type enables obtaining samples from the cervix, cervical canal and transformation zone
- soft bristle tips enables precise collection of material for examination
- made entirely of polyethylene
- optimal outreach thanks to the long handle
- single-use
- packaging: 1 pc./paper-foil

indication

- device designed for obtaining cell samples from the cervix, cervical canal and transformation zone in smear tests

REF	type	intermediate packaging
SC-002	special	100 pcs

 bulk packaging:
10 x 100 pcs



cervical brush

standard

features

- straight shape enables obtaining samples from the cervical canal
- soft bristle tips to prevent irritation
- optimal outreach thanks to the long handle
- single-use
- packaging: 1 pc./paper-foil

indication

- device designed for obtaining cell samples from the cervix, cervical canal and transformation zone in smear tests

REF	type	intermediate packaging
SC-001	standard	100 pcs

 bulk packaging:
10 x 100 pcs



umbilical cord clamp

features

- made of polypropylene
- safe clamping teeth with rounded edges do not cut the umbilical cord
- serrated clamping surface of the arms stabilize the clamp on the umbilical cord, after closing it is not possible to open the clamp again
- double Lock catch prevents accidental opening
- universal size
- single-use
- non-pyrogenic
- packaging: 1 pc./paper-foil

indication

- device is designed for clamping the umbilical cord of a newborn in a labour ward in order to close the lumen of the umbilical blood vessels after cutting it off of the placenta

REF	size	colour	intermediate packaging
ZDPB	universal	white	50 pcs

 bulk packaging:
50 x 50 pcs





OTHER PRODUCTS

ID wristband

features

- durable wristband coating characterized by high humidity resistance and resistance to the activity of soaps, hand disinfectants and other liquids used in hospitals
- made of soft and delicate vinyl
- flexible, delicate, very light and easy to put on
- rounded edges prevent from injuring
- high tensile strength
- colour marking depending on the purpose
- single-use fastening resistant to accidental break
- hypoallergenic, latex-free, phthalate-free
- available in a version with a description field directly on the band and with an insert card
- packaging: 100 pcs/box

indication

- for identification of patients in hospital wards

REF	purpose	colour	version	intermediate packaging
OPD-B-01	for children and adults	white	insert card	100 pcs
OPN-R-01	for infants	pink	insert card	100 pcs
OPN-N-01	for infants	blue	insert card	100 pcs

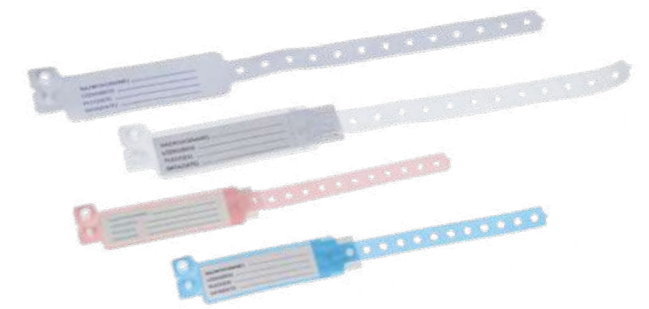

bulk packaging:
50 x 100 pcs



entrance mat

features

- blue mat consisting of 30 layers - thin sticky sheets
- each of the sticky sheets made of polyethylene resin
- does not contain heavy metals
- excellent adhesive properties
- the first and last sheets secured with a non-adhesive foil
- low mat profile: app. 2 mm thick
- the bottom surface adheres very well to the floor over the entire surface, preventing adverse movement of the mat, allowing trouble-free passage of trolleys with equipment or beds, without the risk of curling up the mat or tearing
- no need to clean the mat - as soon as the surface of the mat is contaminated, it should be torn off to uncover a new, clean sheet
- there is numbering of sheets on a white non-adhesive material in the mat corner facilitate quick identification and easy removal of subsequent sheets
- light, easy to spread

indication

- preventing spreading of contamination brought on shoe soles and wheelchairs to operating rooms

REF	dimensions	intermediate packaging
M001	45 cm x 115 cm	10 pcs

bulk packaging:
5 x 10 pcs



enema bag

features

- bag with a capacity of 1750 ml with two holes for hanging
- made of medical PVC
- scaled from 50 ml to 1750 ml
- linear scale every 100 ml, digital scale every 200 ml
- tube with a length of 150 cm with a sliding clamp, ended with an atraumatic opening and one lateral opening
- tube end is secured with a tube cap
- upper part of the bag is reinforced with an additional flange stabilizing the inlet during filling with liquid
- flange is equipped with a non-return valve
- single-use
- packaging: 1 pc./foil

indication

- bag that allows introduction of fluid into the large bowel through the anus to remove fecal material and stimulate peristaltic bowel movement

REF
WLS

bulk packaging:
150 x 1 pc.



enema bag

features

- bag with a capacity of 1500 ml with a hole for hanging
- made of medical PVC
- digitally scaled every 250 ml
- tube with a length of 115 cm with a sliding clamp, ended with an atraumatic opening and one lateral opening
- greased end of the tube secured with a cap
- single-use

indication

- bag that allows introduction of fluid into the large bowel through the anus to remove fecal material and stimulate peristaltic bowel movement



REF					
WLN	bulk packaging: 100 pcs	NON STERILE	LATEX	PHT DEHP	5 YEARS SHELF LIFE

enema set

features

- bag with a capacity of 1500 ml with a hole for hanging
- made of medical PVC
- digitally scaled every 250 ml
- tube with a length of 115 cm with a sliding clamp, ended with an atraumatic opening and one lateral opening
- greased end of the tube secured with a cap
- drape 42 cm x 45 cm
- liquid soap (9 ml)
- PE gloves - 1 pair
- single-use
- packaging: 1 set/foil

indication

- set that allows introduction of fluid into the large bowel through the anus to remove fecal material and stimulate peristaltic bowel movement



REF					
ZLN	bulk packaging: 50 x 1 set	NON STERILE	LATEX	PHT DEHP	5 YEARS SHELF LIFE

vomit bag

features

- bag is made of durable, transparent blue foil, enabling the observation of secretions
- total bag capacity: 2000 ml
- exact measuring graduation (from 10 ml to 100 ml every 10 ml and from 100 to 2000 ml every 100 ml) placed on the bag allows accurate estimation of fluid volume
- direction of graduation reading for small volumes is marked with the tip
- wide bag inlet protected by a plastic collar
- circle-shaped collar ensures a firm grip, makes it easier to maneuver the bag, reducing the risk of content contamination
- collar equipped with a special incision to close the bag and hygienic disposal of the vomit - „twist and hook“
- device name, manufacturer's name and pictorial instructions for use printed directly on the bag
- single-use
- class I non-sterile medical device
- packaging: 20 pcs/foil bag

indication

- recommended in uncomfortable situations, in cases of gastroesophageal reflux requiring immediate action
- used in hospitals, outpatient departments, ambulances, etc.



REF	colour	intermediate packaging			
WW-01	blue	20 pcs	bulk packaging: 30 x 20 pcs	NON STERILE	LATEX PHT 5 YEARS SHELF LIFE

safeLANCE

pressure-activated safety lancet

features

- easy to use, minimizes unpleasant feelings
- special construction allows lancet tip to be automatically inserted into finger pad and then to be retracted so that needle is not visible before or after puncturing
- correctly matched size of lancet allows you to get optimal amount of blood with minimal patient's pain
- design ensures safety for medical personnel and patient by eliminating accidental puncture and infection
- perfect guidance of lancet needle inside housing reduces vibration, thus decreases patient's pain and prevents damage to skin tissue
- available in two sizes:
 - 23 G, puncture depth 1,8 mm - green, dedicated for women and children
 - 21 G, puncture depth 2,4 mm - pink, dedicated for men
- single-use
- packaging: 100 pcs/box

indication

- capillary blood sampling from fingertip or ear flap for testing, for example, glucose level



REF	size / puncture depth	colour	intermediate packaging
NA-18	23 G / 1,8 mm	green	100 pcs
NA-24	21 G / 2,4 mm	pink	100 pcs

bulk packaging: 20 x 100 pcs	STERILE R	LATEX	PHT	5 YEARS SHELF LIFE
---------------------------------	-----------	-------	-----	-----------------------

dental brush

with suction

features

- made of polypropylene
- soft bristles on one side, foam on the other side
- total length 18 cm
- length of the cleaning part 2,5 cm
- suction opening from both the bristle side and the space between the foam and the bristles
- controlled suction connector at 45° angle for convenient manipulation
- single-use
- packaging: 1 pc./foil

indication

- hygiene of the patient's oral cavity
- function for simultaneous brushing, rinsing and suction



REF	intermediate packaging	bulk packaging:			
HJM-SO	50 pcs	10 x 50 pcs	NON STERILE	LATEX	PHT 5 YEARS SHELF LIFE

oral swab

features

- overall length 15 cm (+/- 2 mm)
- length of the foam part 2,5 cm
- handle made of polyester
- swab made of polypropylene
- single-use
- packaging: 1 pc./foil

indication

- intended for oral hygiene in patients partially or completely dependent on medical personnel
- allows the oral mucosa to be kept in proper humidity
- allows you to perform a procedure to prevent pathological changes in the mouth



REF	intermediate packaging	bulk packaging:			
HJM-GB	50 pcs	10 x 50 pcs	NON STERILE	LATEX	PHT 5 YEARS SHELF LIFE

tactical tourniquet CAT

features

- made of soft and breathable material to prevent chafing and skin burns
- additional element to secure the tourniquet and control blood flow
- locking system to prevent accidental opening of the tourniquet
- one-handed mechanism
- durable loop system with internal, free-moving strap that provides circumferential compression to the limb
- the unique double fastening system allows to avoid the use of screws and clips
- high quality of workmanship
- place to write down the time of establishment
- weight: 82g
- folded dimensions: 16 cm x 6 cm x 4cm
- unfolded dimensions: 96 cm x 4 cm
- individually wrapped in foil packaging
- single-use

indication

- tactical tourniquet used in case of limb injuries with massive arterial or venous bleeding that cannot be controlled by traditional techniques



REF	dimensions	intermediate packaging
ST-001	96 cm x 4 cm	1 pc.

 bulk packaging:
100 x 1 pcs



automatic tourniquet

features

- components: blue stretchy strap and white ABS plastic buckle
- length 480 mm +/- 10 mm, width 25 mm +/- 10 mm
- wide, stretchable band put above the venipuncture site reduces the pressure intensity
- protects against the congestion of the arm, minimizes unpleasant sensations, improves the quality of the blood sample
- reusable
- packaging: 1 pc./double packaging: internal- foil, external- box

indication

- used to induce venous stasis and to make a vein selected for puncture more prominent



REF	intermediate packaging
SA-001	21 pcs

 bulk packaging:
20 x 21 pcs



for children

features

- components: polyester stretch strap and ABS plastic items
- length 450 mm +/- 5 mm, width 25 mm +/- 1 mm
- wide stretch strap to minimise pressure build-up during compression
- significantly protects against arm congestion, improves the quality of the blood sample for examination
- reduces unpleasant sensations during compression
- a simple one-handed mechanism for easy fastening and unfastening with gradual release of pressure
- reusable

indication

- device used to induce venous stasis and to make a vein selected for puncture more prominent



REF	intermediate packaging	intermediate packaging
SA-002	21 pcs	yellow + imprint

 bulk packaging:
20 x 21 pcs



latex-free tourniquet

features

- made of a wide stretch TPE strap (thermoplastic elastomer)
- latex-free material prevents allergic reactions and skin irritation
- high tensile strength
- single-use bands reduce the risk of infection
- total roller length 11,25 m
- single-use
- individual packaging contains: 25 tourniquets
- packaging: 1 roll/paper dispenser that allows convenient sharing of perforated tourniquets

indication

- used to induce venous stasis and to make a vein selected for puncture more prominent

REF	size	colour
S001	25 mm x 450 mm	blue
S002	25 mm x 450 mm	pink

 bulk packaging:
100 rolls



tongue depressor

wooden

features

- made of birch wood
- rounded edges preventing injuries
- natural colour
- long outreach thanks to appropriate length
- durable
- single-use
- packaging: 1 pc./paper

indication

- diagnostic examination of the oral cavity



REF	version	dimensions	bulk packaging
SLS-001	sterile	150 mm x 17 mm	20 x 100 pcs



tongue depressor

wooden

features

- made of birch wood
- rounded edges preventing injuries
- natural colour
- long outreach thanks to appropriate length
- durable
- single-use
- packaging: 100 pcs/box

indication

- diagnostic examination of the oral cavity

REF	version	dimensions	bulk packaging
SLN-001	non-sterile	150 mm x 17 mm	50 x 100 pcs



electronic thermometer

features

- digital thermometer
- fast, safe and reliable
- temperature readings
- waterproof
- measurement in 10 seconds
- range 32.0°C-42.9°C (90.0°F-109.9°F)
- accuracy ±0.1°C (±0.2°F)
- has a soft, flexible measuring tip
- sound signal
- automatic turning off
- memory of the last measurement
- low battery indicator
- battery life: approximately 200 hours
- package: 1 piece / plastic cover and paper box

indication

- for measuring body temperature in the mouth, armpit and rectal area

REF	intermediate packaging	bulk packaging:
DMT-437	10 pcs	30 x 10 pcs



wash glove molton

features

- wash glove in the form of a glove to put on a hand
- made of MOLTON material
- ultrasonic sewing
- soft, smooth, gentle and absorbent
- dry, without cleaning agents
- tear resistant
- single-use

REF	grammage	dimensions	unit packaging
MB11	75 g/m ²	160 mm x 220 mm	50 pcs

bulk packaging:
20 x 50 pcs



wash glove Spunlace

features

- wash glove in the form of a glove to put on a hand
- made of SPUNLACE material
- ultrasonic sewing
- very soft, gentle and absorbent
- dry, without cleaning agents
- tear resistant
- single-use

REF	grammage	dimensions	unit packaging
MB12	80 g/m ²	160 mm x 220 mm	50 pcs

bulk packaging:
20 x 50 pcs



vitahealth



wash glove with film lining

features

- wash glove with film lining in the form of a glove to put on a hand
- made of Air laid material + PE
- ultrasonic sewing
- gentle and absorbent
- dry, without cleaning agents
- tear resistant
- single-use

REF	grammage	dimensions	unit packaging
MB13PE	80 g/m ²	160 mm x 220 mm	50 pcs

bulk packaging:
20 x 50 pcs



PE gloves

features

- made of polyethylene
- coarse surface and tear-resistant weld
- ambidextrous
- elongation min. 130%, tensile strength min. 10 MPa
- approved for contact with food
- single-use
- packaging: 100 pcs/foil bag enabling individual removal of gloves

indication

- intended for use as a contribution to other gloves (double-gloving) and for minimally invasive procedures such as drug preparation, feeding the patient

REF	size	length
BS-RF-M	M (women)	280 mm
BS-RF-L	L (men)	300 mm

bulk packaging:
100 x 100 pcs



PE oversleeves

NEW

features

- made of polyethylene
- ended with a rubber band on bot sides
- colour: blue
- approved for contact with food
- disposable

REF	dimensions	weight	unit packaging
BS-ZF01	22 x 40 cm	2,6 g	100 pcs



BETA safe

medical waste container

features

- blow-moulded container made of high density polyethylene (HDPE), lid made of polypropylene (PP)
- lid equipped with a rosette insertion hole and two holes to separate blades from handles, needles from syringes, etc.
- dual-function lid for temporary or permanent closure of the container
- high resistance to mechanical deformation
- manufactured in red warning colour, other colours (yellow, blue) available on request
- supplied with a BML-type label, injected during blowing, with an international warning sign and place for easily writing the waste data, even with a pen
- resistant to UV radiation, formalin and ethyl alcohol
- it is approved by the National Institute of Public Health
- according to the requirements of the standards: ASTM F2132-01 (puncture resistance) and EN ISO 175 (resistance to immersion in liquid chemicals)
- single-use
- MOQ 5000 pcs

indication

- intended for the collection of solid, hazardous medical waste such as needles, intravenous cannulas, syringes, disposable gloves, etc.
- the container enables the safe storage, transport and disposal of medical waste, ensuring safety in terms of hygiene and sanitary standards, as well as mechanical safety to prevent unwanted events such as punctures and cuts when medical staff dispose of sharp waste

REF	capacity	colour	bottom diameter	upper diameter	height
*POM-00700R	0,7L	red	93 mm	109 mm	97 mm
*POM-00700Y	0,7L	yellow	93 mm	109 mm	97 mm
*POM-00700B	0,7L	blue	93 mm	109 mm	97 mm
*POM-02000R	2L	red	95 mm	109 mm	246 mm
*POM-02000Y	2L	yellow	95 mm	109 mm	246 mm
*POM-02000B	2L	blue	95 mm	109 mm	246 mm

bulk packaging:
20 pcs

* available
on request



hygienic pet underpad

NEW

features

- underpad with quilted absorbent pad containing superabsorbent
- white colour
- equipped with 4 adhesives for sticking the underpad to the substrate
- absorbs fluid and holds it inside
- foil outer layer prevents leakage
- protects against contamination and soiling of the substrate
- soft
- disposable

REF	dimensions	packaging unit	bulk packaging
PHZ1	60 cm x 60 cm	30 pcs	10 x 30 pcs
PHZ2	60 cm x 90 cm	15 pcs	10 x 15 pcs



medical waste container

features

- container entirely made of polypropylene (PP)
- lid equipped with a rosette insertion hole and two holes to separate blades from handles, needles from syringes, etc.
- dual-function lid for temporary or permanent closure of the container
- high resistance to mechanical deformation
- manufactured in red warning colour, other colours (yellow, blue) available on request
- supplied with label with an international warning sign and place for easily writing the waste data
- single-use
- MOQ 5000 pcs

indication

- intended for the collection of solid, hazardous medical waste such as needles, intravenous cannulas, syringes, disposable gloves, etc.
- the container enables the safe storage, transport and disposal of medical waste, ensuring safety in terms of hygiene and sanitary standards, as well as mechanical safety to prevent unwanted events such as punctures and cuts when medical staff dispose of sharp waste

REF	capacity	colour	bottom diameter	upper diameter	height
*POM-01000R	1L	red	92,5 mm	109 mm	140 mm
*POM-01000Y	1L	yellow	92,5 mm	109 mm	140 mm
*POM-01000B	1L	blue	92,5 mm	109 mm	140 mm
*POM-05000R	5L	red	190 mm	230 mm	210 mm
*POM-05000Y	5L	yellow	190 mm	230 mm	210 mm
*POM-05000B	5L	blue	190 mm	230 mm	210 mm

bulk packaging:
20 pcs

* available
on request



Dressing materials have for years been the core of patient care. Constant development in this field causes more advanced products to appear next to the basic ones.

Dressing does not translate into using only the basic compresses and tapes any more. Naturally the function of each dressing depends on the requirements, overall patient health and the conditions in which the product is to be used.

The offer of ZARYS International Group falls into few categories and encompasses a complex range of solutions such as:

- gauze and non-woven dressings, compresses and drapes whose main function is to absorb the exudate and dress the wound in hospital and home care conditions,
- adhesive tapes made of various materials used for dressing and drain fixation as well as dressings with absorbent pads that enable fast dressing of minor injuries,
- special purpose dressings composing of solutions dedicated to specific conditions such as the dressing of post-operative wounds, cannula and drain fixation,
- supporting dressings- including products such as knitted and elastic bandages and tapes,
- stiffening dressings- including padding and P.O.P. bandages.

dressings

traditional dressings materials | adhesive tapes and plasters with dressing | special purpose dressings | stabilizing dressings | specialist dressings | additional products





GAUZE AND NON-WOVEN DRESSINGS

DRESSING GAUZE

features

- 100% hydrophilic cotton
- bleached with the use of hydrogen peroxide
- soft and very absorbent
- increase in absorption capacity with increasing number of gauze threads
- homogeneous structure through a strong twist of fibers eliminates the risk of loose fibers on the surface

indication

- general wound dressing in out-patient clinics, surgical sites, procedure department



dressing gauze, zig-zag folded

GAZA lux

Before use on open wounds, the device must be sterilized in accordance with a validated sterilization method. It can be sterilized with steam, ethylene oxide or radiation.

REF	dimensions	no. of threads	packaging unit foil bag	bulk packaging carton
NEW GR1709100-XR	0,9 m x 100 m	17	1 pc.	5 x 1 pc.
GR1309100	0,9 m x 100 m	13	1 pc.	5 x 1 pc.
GR1709100	0,9 m x 100 m	17	1 pc.	5 x 1 pc.



cutting gauze

GAZA lux

Before use on open wounds, the device must be sterilized in accordance with a validated sterilization method. It can be sterilized with steam, ethylene oxide or radiation.

REF	size	no. of threads	packaging unit paper-foil	bulk packaging carton
*CG1325SQM	1/4 m ²	13	1 pc.	100 x 1 pc.
*CG1305SQM	1/2 m ²	13	1 pc.	50 x 1 pc.
CG1315SQM	1 m ²	13	1 pc.	25 x 1 pc.
*CG1725SQM	1/4 m ²	17	1 pc.	100 x 1 pc.
*CG1705SQM	1/2 m ²	17	1 pc.	50 x 1 pc.
CG1715SQM	1 m ²	17	1 pc.	25 x 1 pc.



edges ES-type folded



* available on request



GAZA lux S

REF	size	no. of threads	packaging unit paper-foil	bulk packaging carton
NEW CG1748255-SS	25 cm x 25 cm	17	5 pcs	25 x 5 pcs
*CG1325SQM-S	1/4 m ²	13	1 pc.	100 x 1 pc.
CG1305SQM-S	1/2 m ²	13	1 pc.	50 x 1 pc.
CG1315SQM-S	1 m ²	13	1 pc.	25 x 1 pc.
*CG1725SQM-S	1/4 m ²	17	1 pc.	100 x 1 pc.
CG1705SQM-S	1/2 m ²	17	1 pc.	50 x 1 pc.
CG1715SQM-S	1 m ²	17	1 pc.	25 x 1 pc.



TRADITIONAL DRESSING MATERIALS

GAUZE SWABS

features

- 100% hydrophilic cotton
- bleached with the use of hydrogen peroxide
- edges ES-type folded, which prevents fraying of loose threads
- available with a sewed in X-ray detectable thread, which enables fast and non-invasive identification of the swab left in the operating field

indication

- general wound dressing in out-patient clinics, surgical sites, procedure departments

gauze swabs

KOMPRI lux

without X-ray detectable thread

REF	dimensions	no. of threads	no. of plies	packaging unit paper bag	bulk packaging carton
GS1305081	5 cm x 5 cm	13	8	100 pcs	250 x 100 pcs
GS1375081	7,5 cm x 7,5 cm	13	8	100 pcs	60 x 100 pcs
GS1310081	10 cm x 10 cm	13	8	100 pcs	40 x 100 pcs
GS1305121	5 cm x 5 cm	13	12	100 pcs	80 x 100 pcs
GS1305125	5 cm x 5 cm	13	12	500 pcs	4 x 500 pcs
GS1375121	7,5 cm x 7,5 cm	13	12	100 pcs	40 x 100 pcs
GS1375125	7,5 cm x 7,5 cm	13	12	500 pcs	4 x 500 pcs
GS1310121	10 cm x 10 cm	13	12	100 pcs	20 x 100 pcs
GS1310125	10 cm x 10 cm	13	12	500 pcs	4 x 500 pcs
GS1705081	5 cm x 5 cm	17	8	100 pcs	80 x 100 pcs
GS1775081	7,5 cm x 7,5 cm	17	8	100 pcs	90 x 100 pcs
GS1710081	10 cm x 10 cm	17	8	100 pcs	40 x 100 pcs
GS171020081	10 cm x 20 cm	17	8	100 pcs	40 x 100 pcs
GS1705121	5 cm x 5 cm	17	12	100 pcs	96 x 100 pcs
GS1705125	5 cm x 5 cm	17	12	500 pcs	4 x 500 pcs
GS1775121	7,5 cm x 7,5 cm	17	12	100 pcs	60 x 100 pcs
GS1775125	7,5 cm x 7,5 cm	17	12	500 pcs	4 x 500 pcs
GS1710121	10 cm x 10 cm	17	12	100 pcs	20 x 100 pcs
GS1710125	10 cm x 10 cm	17	12	500 pcs	4 x 500 pcs
GS171020121	10 cm x 20 cm	17	12	100 pcs	20 x 100 pcs
GS1705161	5 cm x 5 cm	17	16	100 pcs	96 x 100 pcs
GS1775161	7,5 cm x 7,5 cm	17	16	100 pcs	60 x 100 pcs
GS1710161	10 cm x 10 cm	17	16	100 pcs	40 x 100 pcs
GS171020161	10 cm x 20 cm	17	16	100 pcs	20 x 100 pcs

with X-ray detectable thread

REF	dimensions	no. of threads	no. of plies	packaging unit paper bag	bulk packaging carton
*GS1705081X	5 cm x 5 cm	17	8	100 pcs	80 x 100 pcs
GS1775081X	7,5 cm x 7,5 cm	17	8	100 pcs	90 x 100 pcs
GS1710081X	10 cm x 10 cm	17	8	100 pcs	40 x 100 pcs
*GS1705121X	5 cm x 5 cm	17	12	100 pcs	96 x 100 pcs
GS1775121X	7,5 cm x 7,5 cm	17	12	100 pcs	60 x 100 pcs
GS1710121X	10 cm x 10 cm	17	12	100 pcs	20 x 100 pcs
GS171020121X	10 cm x 20 cm	17	12	100 pcs	20 x 100 pcs
GS1705161X	5 cm x 5 cm	17	16	100 pcs	96 x 100 pcs
GS1775161X	7,5 cm x 7,5 cm	17	16	100 pcs	60 x 100 pcs
GS1710161X	10 cm x 10 cm	17	16	100 pcs	40 x 100 pcs
GS171020161X	10 cm x 20 cm	17	16	100 pcs	20 x 100 pcs



Before use on open wounds, the device must be sterilized in accordance with a validated sterilization method. It can be sterilized with steam or ethylene oxide.

* available on request



vitahealth



✓ self-adhesive labels for medical documentation

* available on request

KOMPRI lux S

without X-ray detectable thread

REF	dimensions	no. of threads	no. of plies	packaging unit paper-foil / paper-paper *	intermediate packaging box	bulk packaging carton
GS1705081-S*	5 cm x 5 cm	17	8	1 pc.	50 x 1 pc.	30 x 50 pcs
GS1705082-S	5 cm x 5 cm	17	8	2 pcs	50 x 2 pcs	16 x 50 pcs
GS1705083-S	5 cm x 5 cm	17	8	3 pcs	50 x 3 pcs	16 x 50 pcs
GS1705085-S	5 cm x 5 cm	17	8	5 pcs	20 x 5 pcs	16 x 20 pcs
GS17050810-S	5 cm x 5 cm	17	8	10 pcs	40 x 10 pcs	10 x 40 pcs
GS17050820-SS	5 cm x 5 cm	17	8	20 pcs	20 x 20 pcs	10 x 20 pcs
GS1775081-S*	7,5 cm x 7,5 cm	17	8	1 pc.	50 x 1 pc.	30 x 50 pcs
GS1775082-S	7,5 cm x 7,5 cm	17	8	2 pcs	50 x 2 pcs	12 x 50 pcs
GS1775083-S	7,5 cm x 7,5 cm	17	8	3 pcs	50 x 3 pcs	12 x 50 pcs
GS1775085-S	7,5 cm x 7,5 cm	17	8	5 pcs	20 x 5 pcs	12 x 20 pcs
GS17750810-S	7,5 cm x 7,5 cm	17	8	10 pcs	40 x 10 pcs	10 x 40 pcs
GS17750820-SS	7,5 cm x 7,5 cm	17	8	20 pcs	20 x 20 pcs	10 x 20 pcs
GS1710081-S*	10 cm x 10 cm	17	8	1 pc.	50 x 1 pc.	30 x 50 pcs
GS1710082-SS	10 cm x 10 cm	17	8	2 pcs	50 x 2 pcs	8 x 50 pcs
GS1710083-S	10 cm x 10 cm	17	8	3 pcs	50 x 3 pcs	8 x 50 pcs
GS1710085-S	10 cm x 10 cm	17	8	5 pcs	50 x 5 pcs	8 x 50 pcs
GS17100810-S	10 cm x 10 cm	17	8	10 pcs	40 x 10 pcs	10 x 40 pcs
GS17100820-SS	10 cm x 10 cm	17	8	20 pcs	10 x 20 pcs	6 x 20 pcs
GS1705122-SS	5 cm x 5 cm	17	12	2 pcs	50 x 2 pcs	16 x 50 pcs
GS1705123-S	5 cm x 5 cm	17	12	3 pcs	50 x 3 pcs	16 x 50 pcs
GS1705123-S-IP*	5 cm x 5 cm	17	12	3x1 pcs	20 x 3 pcs	20 x 20 pcs
GS1705125-SS	5 cm x 5 cm	17	12	5 pcs	20 x 5 pcs	16 x 20 pcs
GS17051210-SS	5 cm x 5 cm	17	12	10 pcs	20 x 10 pcs	12 x 20 pcs
GS1775122-SS	7,5 cm x 7,5 cm	17	12	2 pcs	50 x 2 pcs	18 x 50 pcs
GS1775123-SS	7,5 cm x 7,5 cm	17	12	3 pcs	50 x 3 pcs	12 x 50 pcs
GS1775123-S-IP*	7,5 cm x 7,5 cm	17	12	3x1 pcs	20 x 3 pcs	20 x 20 pcs
GS1775125-SS	7,5 cm x 7,5 cm	17	12	5 pcs	20 x 5 pcs	12 x 20 pcs
GS17751210-SS	7,5 cm x 7,5 cm	17	12	10 pcs	40 x 10 pcs	10 x 40 pcs
GS17751220-SS	7,5 cm x 7,5 cm	17	12	20 pcs	20 x 20 pcs	10 x 20 pcs
GS1710123-SS	10 cm x 10 cm	17	12	3 pcs	50 x 3 pcs	8 x 50 pcs
GS1710123-S-IP*	10 cm x 10 cm	17	12	3x1 pcs	20 x 3 pcs	20 x 20 pcs
GS1710125-S	10 cm x 10 cm	17	12	5 pcs	20 x 5 pcs	8 x 20 pcs
GS17101210-SS	10 cm x 10 cm	17	12	10 pcs	20 x 10 pcs	6 x 20 pcs
GS17101220-SS	10 cm x 10 cm	17	12	20 pcs	20 x 20 pcs	4 x 20 pcs
GS171020123-SS	10 cm x 20 cm	17	12	3 pcs	50 x 3 pcs	8 x 50 pcs
GS1710201210-SS	10 cm x 20 cm	17	12	10 pcs	10 x 10 pcs	8 x 10 pcs
GS171020125-SS	10 cm x 20 cm	17	12	5 pcs	20 x 5 pcs	8 x 20 pcs
GS1705163-SS	5 cm x 5 cm	17	16	3 pcs	50 x 3 pcs	16 x 50 pcs
GS1705165-SS	5 cm x 5 cm	17	16	5 pcs	30 x 5 pcs	12 x 30 pcs
GS1775163-SS	7,5 cm x 7,5 cm	17	16	3 pcs	50 x 3 pcs	12 x 50 pcs
GS1775165-SS	7,5 cm x 7,5 cm	17	16	5 pcs	20 x 5 pcs	12 x 20 pcs
GS17751610-SS	7,5 cm x 7,5 cm	17	16	10 pcs	16 x 10 pcs	12 x 16 pcs
GS1710163-SS	10 cm x 10 cm	17	16	3 pcs	50 x 3 pcs	8 x 50 pcs
GS1710165-SS	10 cm x 10 cm	17	16	5 pcs	30 x 5 pcs	6 x 30 pcs
GS17101610-SS	10 cm x 10 cm	17	16	10 pcs	20 x 10 pcs	8 x 20 pcs
GS171020163-SS	10 cm x 20 cm	17	16	3 pcs	50 x 3 pcs	4 x 50 pcs
GS1710201610-SS	10 cm x 20 cm	17	16	10 pcs	10 x 10 pcs	8 x 10 pcs
GS179020062-SS	90 cm x 20 cm	17	6	2 pcs	40 x 2 pc.	4 x 40 pcs
GS179020065-SS	90 cm x 20 cm	17	6	5 pcs	16 x 5 pc.	4 x 16 pcs
GS179040062-SS	90 cm x 40 cm	17	6	2 pcs	20 x 2 pc.	4 x 20 pcs

with X-ray detectable thread

REF	dimensions	no. of threads	no. of plies	packaging unit paper-foil	bulk packaging box
GS17750810-SSXR	7,5 cm x 7,5 cm	17	8	10 pcs	40 x 10 pcs
GS17750820-SSXR	7,5 cm x 7,5 cm	17	8	20 pcs	20 x 20 pcs
✓ GS17100810-SSXR	10 cm x 10 cm	17	8	10 pcs	40 x 10 pcs
* GS1705125-SSXR	5 cm x 5 cm	17	12	5 pcs	20 x 5 pcs
* GS17051210-SSXR	5 cm x 5 cm	17	12	10 pcs	40 x 10 pcs
✓ GS1775125-SSXR	7,5 cm x 7,5 cm	17	12	5 pcs	20 x 5 pcs
✓ GS17751210-SSXR	7,5 cm x 7,5 cm	17	12	10 pcs	10 x 10 pcs
✓ GS17101210-SSXR	10 cm x 10 cm	17	12	10 pcs	20 x 10 pcs
✓ GS17101220-SSXR	10 cm x 10 cm	17	12	20 pcs	20 x 20 pcs
✓ GS17101240-SSXR	10 cm x 10 cm	17	12	40 pcs	10 x 40 pcs
✓ GS1710201210-SSXR	10 cm x 20 cm	17	12	10 pcs	10 x 10 pcs
✓ GS1710201220-SSXR	10 cm x 20 cm	17	12	20 pcs	6 x 20 pcs
* GS17051610-SSXR	5 cm x 5 cm	17	16	10 pcs	30 x 10 pcs
✓ GS1775165-SSXR	7,5 cm x 7,5 cm	17	16	5 pcs	20 x 5 pcs
✓ GS17751610-SSXR	7,5 cm x 7,5 cm	17	16	10 pcs	16 x 10 pcs
* GS1710165-SSXR	10 cm x 10 cm	17	16	5 pcs	20 x 5 pcs
✓ GS17101610-SSXR	10 cm x 10 cm	17	16	10 pcs	20 x 10 pcs

GAUZE LAP SPONGES

features

- 100% hydrophilic cotton
- bleached with the use of hydrogen peroxide
- with a sewed in X-ray detectable thread or chip, which enables fast and non-invasive identification of the lap sponge left in the operating field
- with a belt to fix the lap sponge beyond the operating field

indication

- as a surgical invasive dressing material for intraoperative absorption of large amounts of blood and body fluids from surgical wounds



Before used on open wounds, the device must be sterilized in accordance with a validated sterilization method. It can be sterilized with steam or ethylene oxide.



gauze lap sponges

SERVI lux

with X-ray thread

	REF	dimensions	no. of threads	no. of plies	packaging unit foil bag	bulk packaging carton
NEW	LS1745458-X	45 cm x 45 cm	17	8	20 pcs	10 x 20 pcs
NEW	LS1745704-X	45 cm x 70 cm	17	4	20 pcs	10 x 20 pcs
NEW	LS1730304-X	30 cm x 30 cm	17	4	50 pcs	10 x 50 pcs
NEW	LS1745454-X	45 cm x 45 cm	17	4	20 pcs	10 x 20 pcs
NEW	LS1775904-X	75 cm x 90 cm	17	4	20 pcs	6 x 20 pcs

with X-ray thread and belt

	REF	dimensions	no. of threads	no. of plies	packaging unit foil bag	bulk packaging carton
	LS1745454-XB	45 cm x 45 cm	17	4	20 pcs	10 x 20 pcs
	LS1745704-XB	45 cm x 70 cm	17	4	20 pcs	10 x 20 pcs
	LS1745456-XB	45 cm x 45 cm	17	6	20 pcs	10 x 20 pcs
	LS1745706-XB	45 cm x 70 cm	17	6	20 pcs	10 x 20 pcs
	LS1745458-XB	45 cm x 45 cm	17	8	20 pcs	10 x 20 pcs
	LS2045454-XB	45 cm x 45 cm	20	4	20 pcs	10 x 20 pcs
NEW	LS1775904-XB	75 cm x 90 cm	17	4	20 pcs	6 x 20 pcs
NEW	LS1730454-XB	30 cm x 45 cm	17	4	50 pcs	10 x 50 pcs
NEW	LS1730306-XB	30 cm x 30 cm	17	6	50 pcs	10 x 50 pcs
NEW	LS1775752-XB	75 cm x 75 cm	17	2	20 pcs	10 x 20 pcs
NEW	LS1730304-XB	30 cm x 30 cm	17	4	50 pcs	10 x 50 pcs

pre-washed with X-ray chip and belt

	REF	dimensions	no. of threads	no. of plies	packaging unit foil bag	bulk packaging carton
	LS2045454-XB-PW	45 cm x 45 cm	20	4	20 pcs	10 x 20 pcs



The advantages of self-adhesive labels for medical documentation:

- fast data transport without the need to rewrite
- safe identification of the device - elimination of the possibility of errors.
- improvement of the preparation of medical documentation.



SERVI lux S

with X-ray thread and belt

self-adhesive labels for medical documentation

	REF	dimensions	no. of threads	no. of plies	packaging unit paper-foil	bulk packaging box
✓	LS17454542-SSXB	45 cm x 45 cm	17	4	2 pcs	20 x 2 pcs
✓	LS17454545-SSXB	45 cm x 45 cm	17	4	5 pcs	8 x 5 pcs
✓	LS17457042-SSXB	45 cm x 70 cm	17	4	2 pcs	20 x 2 pcs
✓	LS17454563-SSXB	45 cm x 45 cm	17	6	3 pcs	10 x 3 pcs
✓	LS17454582-SSXB	45 cm x 45 cm	17	8	2 pcs	10 x 2 pcs
✓	LS17454585-SSXB	45 cm x 45 cm	17	8	5 pcs	5 x 5 pcs
✓	LS17457043-SSXB	45 cm x 70 cm	17	4	3 pcs	10 x 3 pcs
✓	LS17759041-SSXB	75 cm x 90 cm	17	4	1 pc.	15 x 1 pcs

pre-washed with X-ray chip and belt

	REF	dimensions	no. of threads	no. of plies	packaging unit foil bag	bulk packaging carton
NEW	LS17454542-SSXB-PW	45 cm x 45 cm	17	4	2 pcs	20 x 2 pcs
NEW	LS17454543-SSXB-PW	45 cm x 45 cm	17	4	3 pcs	15 x 3 pcs
NEW	LS17454545-SSXB-PW	45 cm x 45 cm	17	4	5 pcs	10 x 5 pcs



Before use on open wounds, the device must be sterilized in accordance with a validated sterilization method. It can be sterilized with steam or ethylene oxide.



gauze balls

TUPFER lux

features

- 100% hydrophilic cotton
- bleached with the use of hydrogen peroxide
- available in a version with or without X-ray detectable thread, which enables fast and non-invasive identification of the gauze ball left in the operating field

indication

- absorption of blood and body fluids from surgical wounds and hard to reach places

without X-ray thread

	REF	size of gauze	diameter approx.	shape	packaging unit foil bag	bulk packaging carton
	TK1515250	15 cm x 15 cm	2,5 cm	ball	250 pcs	24 x 250 pcs
	TK2020250	20 cm x 20 cm	3 cm	ball	250 pcs	24 x 250 pcs
	TK3030100	30 cm x 30 cm	4 cm	ball	100 pcs	10 x 100 pcs
NEW	TFT1515100	15 cm x 15 cm	2,5 cm	bean	1000 pcs	60 x 1000 pcs
	TF1515100	15 cm x 15 cm	2,5 cm	bean	100 pcs	60 x 100 pcs

with X-ray thread

	REF	size of gauze	diameter approx.	shape	packaging unit foil bag	bulk packaging carton
	TK1515250X	15 cm x 15 cm	2,5 cm	ball	250 pcs	24 x 250 pcs
	TK2020250X	20 cm x 20 cm	3 cm	ball	250 pcs	24 x 250 pcs
	TK2525250X	25 cm x 25 cm	3,5 cm	ball	250 pcs	8 x 250 pcs
	TK3030100X	30 cm x 30 cm	4 cm	ball	100 pcs	10 x 100 pcs
	TK3040100X	30 cm x 40 cm	4,5 cm	ball	100 pcs	10 x 100 pcs
	TK5050100X	50 cm x 50 cm	5 cm	ball	100 pcs	10 x 100 pcs
NEW	TFT1515100X	15 cm x 15 cm	2,5 cm	bean	1000 pcs	10 x 1000 pcs
NEW	TF1515100X	15 cm x 15 cm	2,5 cm	bean	100 pcs	60 x 100 pcs



TUPFER lux S

self-adhesive labels for medical documentation

	REF	size of gauze	diameter approx.	shape	packaging unit paper-foil	bulk packaging carton
✓	TF959505-SSXR	9,5 cm x 9,5 cm		bean	5 pcs	50 x 5 pcs
✓	TF959510-SSXR	9,5 cm x 9,5 cm		bean	10 pcs	25 x 10 pcs
✓	TF151505-SSXR	15 cm x 15 cm		bean	5 pcs	25 x 5 pcs
✓	TF151510-SSXR	15 cm x 15 cm		bean	10 pcs	20 x 10 pcs
✓	TR121205-SSXR	12 cm x 12 cm		triangular	5 pcs	15 x 5 pcs
✓	TR181810-SSXR	18 cm x 18 cm		triangular	10 pcs	15 x 10 pcs
✓	TK151510-SSXR	15 cm x 15 cm	2,5 cm	ball	10 pcs	20 x 10 pcs
✓	TK202010-SSXR	20 cm x 20 cm	3 cm	ball	10 pcs	20 x 10 pcs
✓	TK303010-SSXR	30 cm x 30 cm	4 cm	ball	10 pcs	10 x 10 pcs



non-woven swabs

NONVI lux

Before use on open wounds, the device must be sterilized in accordance with a validated sterilization method. It can be sterilized with steam, ethylene oxide or radiation.

REF	dimensions	grammage	packaging unit paper bag	bulk packaging carton
NL50-100	5 cm x 5 cm	30 g/m ²	100 pcs	50 x 100 pcs
NL50-100-40	5 cm x 5 cm	40 g/m ²	100 pcs	50 x 100 pcs
NL75-100	7,5 cm x 7,5 cm	30 g/m ²	100 pcs	40 x 100 pcs
NL75-100-40	7,5 cm x 7,5 cm	40 g/m ²	100 pcs	40 x 100 pcs
NL100-100	10 cm x 10 cm	30 g/m ²	100 pcs	40 x 100 pcs
NL100-100-40	10 cm x 10 cm	40 g/m ²	100 pcs	20 x 100 pcs
NL1020-100	10 cm x 20 cm	30 g/m ²	100 pcs	20 x 100 pcs



NONVI lux S

REF	dimensions	grammage	packaging unit paper-foil	intermediate packaging box	bulk packaging box
NL052-S	5 cm x 5 cm	30 g/m ²	2 pcs	25 x 2 pcs	60 x 25 pcs
NL053-S	5 cm x 5 cm	30 g/m ²	3 pcs	25 x 3 pcs	45 x 25 pcs
NL055-S	5 cm x 5 cm	30 g/m ²	5 pcs	25 x 5 pcs	36 x 25 pcs
NL0510-S	5 cm x 5 cm	30 g/m ²	10 pcs	10 x 10 pcs	32 x 10 pcs
NL052-S-40	5 cm x 5 cm	40 g/m ²	2 pcs	25 x 2 pcs	60 x 25 pcs
NL053-S-40	5 cm x 5 cm	40 g/m ²	3 pcs	25 x 3 pcs	45 x 25 pcs
NL055-S-40	5 cm x 5 cm	40 g/m ²	5 pcs	25 x 5 pcs	24 x 25 pcs
NL0510-S-40	5 cm x 5 cm	40 g/m ²	10 pcs	10 x 10 pcs	32 x 10 pcs
NL752-S	7,5 cm x 7,5 cm	30 g/m ²	2 pcs	25 x 2 pcs	48 x 25 pcs
NL753-S	7,5 cm x 7,5 cm	30 g/m ²	3 pcs	25 x 3 pcs	36 x 25 pcs
NL755-S	7,5 cm x 7,5 cm	30 g/m ²	5 pcs	25 x 5 pcs	24 x 25 pcs
NL7510-S	7,5 cm x 7,5 cm	30 g/m ²	10 pcs	10 x 10 pcs	12 x 10 pcs
NL752-S-40	7,5 cm x 7,5 cm	40 g/m ²	2 pcs	25 x 2 pcs	48 x 25 pcs
NL753-S-40	7,5 cm x 7,5 cm	40 g/m ²	3 pcs	25 x 3 pcs	24 x 25 pcs
NL755-S-40	7,5 cm x 7,5 cm	40 g/m ²	5 pcs	25 x 5 pcs	18 x 25 pcs
NL7510-S-40	7,5 cm x 7,5 cm	40 g/m ²	10 pcs	10 x 10 pcs	12 x 10 pcs
* NL7520-S-40	7,5 cm x 7,5 cm	40 g/m ²	20 pcs	5 x 20 pcs	12 x 5 pcs
NL102-S	10 cm x 10 cm	30 g/m ²	2 pcs	25 x 2 pcs	30 x 25 pcs
NL103-S	10 cm x 10 cm	30 g/m ²	3 pcs	25 x 3 pcs	24 x 25 pcs
NL105-S	10 cm x 10 cm	30 g/m ²	5 pcs	20 x 5 pcs	12 x 20 pcs
NL1010-S	10 cm x 10 cm	30 g/m ²	10 pcs	10 x 10 pcs	12 x 10 pcs
NL102-S-40	10 cm x 10 cm	40 g/m ²	2 pcs	25 x 2 pcs	30 x 25 pcs
NL103-S-40	10 cm x 10 cm	40 g/m ²	3 pcs	25 x 3 pcs	18 x 25 pcs
NL105-S-40	10 cm x 10 cm	40 g/m ²	5 pcs	20 x 5 pcs	12 x 25 pcs
NL1010-S-40	10 cm x 10 cm	40 g/m ²	10 pcs	10 x 10 pcs	12 x 25 pcs
NL1020-S-40	10 cm x 10 cm	40 g/m ²	20 pcs	5 x 20 pcs	12 x 25 pcs

NON-WOVEN SWABS

features

- hydrophilic medical non-woven, 30 or 40 g/m²
- 4-ply
- soft, non-fraying, durable

indication

- general wound dressing in out-patient clinics, surgical sites, procedure department

* available on request



NONVI lux S with Y-incision

features

- hydrophilic medical non-woven 40 g/m²
- 4-ply
- Y-incision for precise, aseptic protection of the outlet of various types of medical drains

indication

- securing the outlet of drains, catheters, tracheostomy tubes etc.

REF sterilized by EO	REF sterilized by steam	dimensions	packaging unit paper-foil	bulk packaging box
NL105-S-40Y	* NL105-SS-40Y	10 cm x 10 cm	5 pcs	20 x 5 pcs
	NL104-SS-Y	10 cm x 10 cm	4 pcs	30 x 4 pcs

NEW

Y swab with „Y“ incision

* available on request



ABSORBENT WOUND DRESSINGS

features

- layered structure: non-woven - cellulose - cellulose pulp
- increased absorption capacity due to the high absorbent cellulose layer
- bottom layer of the dressing covered with waterproof blue non-woven

indication

- removing the exudate from strongly oozing wounds
- covering wounds after surgical procedures

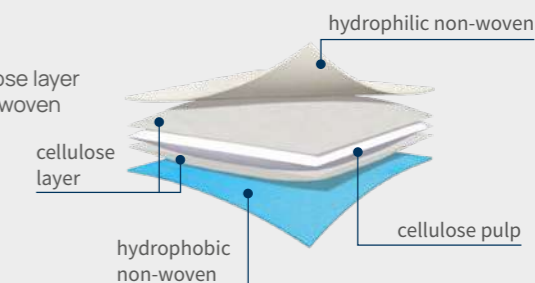

ABD pads, multi-layer

MULTIabsorb

Before use on open wounds, the device must be sterilized in accordance with a validated sterilization method. It can be sterilized with ethylene oxide or radiation.

REF	dimensions	packaging unit foil bag	bulk packaging carton
ABD1010	10 cm x 10 cm	50 pcs	40 x 50 pcs
ABD1020	10 cm x 20 cm	50 pcs	20 x 50 pcs
ABD2025	20 cm x 25 cm	50 pcs	12 x 50 pcs



MULTIabsorb S

REF	dimensions	packaging unit paper-foil	intermediate packaging box	bulk packaging carton
ABD1010-S	10 cm x 10 cm	1 pc.	25 x 1 pc.	24 x 25 pcs
ABD1020-S	10 cm x 20 cm	1 pc.	25 x 1 pc.	18 x 25 pcs
ABD2025-S	20 cm x 25 cm	1 pc.	15 x 1 pc.	18 x 15 pcs
ABD2040-S	20 cm x 40 cm	1 pc.	8 x 1 pc.	12 x 8 pcs



EYE DRESSINGS

features

- layered structure: non-woven + cellulose pulp
- needs to be fixed with a secondary dressing e.g. with adhesive tape or tubular net bandage
- hypoallergenic

indication

- covering an eye and its area after ophthalmic procedures and surgical procedures
- sight correction in strabismus therapy



eye pads

elastoLUMENAL

Before use on open wounds, the device must be sterilized in accordance with a validated sterilization method. It can be sterilized with ethylene oxide or radiation.

REF	dimensions	packaging unit paper-paper	intermediate packaging box	bulk packaging carton
803311	5,5 cm x 7,5 cm	1 pc.	50 x 1 pc.	24 x 50 pcs



elastoLUMENAL S

Conforms well to facial contours thanks to the oval shape.

REF	dimensions	packaging unit paper-paper	intermediate packaging box	bulk packaging carton
803310	5,5 cm x 7,5 cm	1 pc.	50 x 1 pc.	24 x 50 pcs



cellulose swabs cellPAD



REF	dimensions	packaging unit foil bag	bulk packaging carton
KC4050	4 cm x 5 cm	2 rolls (2 x 500 pcs)	16 x 2 rolls



features

- regular perforations to facilitate tearing off individual pieces as small swabs
- each roll contains 500 pieces of individual swabs

indication

- device used for absorbing minor exudates, dressing minor cuts, abrasions on the skin and injection sites

ZARYS



WWW.ZARYS.COM

ADHESIVE TAPES AND PLASTERS WITH DRESSING

ADHESIVE TAPES

features

- flexible, conforms to the body's contours, guarantees freedom of movement
- characterized by adequate air and water vapour permeability
- good adhesion
- can be divided lengthwise and widthwise without the use of scissors
- hypoallergenic

indication

- stabilization, protection and fixation of primary, non-adhesive dressings, applied directly to wounds and skin damages
- stabilization, protection and fixation of drains, catheters, medical tubes that do not require specialized fixing in the place of their insertion



adhesive non-woven tape

SOFTplast

REF	dimensions	packaging unit box	bulk packaging carton
SNW12505W	1,25 cm x 5 m	24 pcs	30 x 24 pcs
SNW25005W	2,5 cm x 5 m	12 pcs	30 x 12 pcs
SNW50005W	5 cm x 5 m	6 pcs	30 x 6 pcs
SNW12509W	1,25 cm x 9,14 m	24 pcs	30 x 24 pcs
SNW25009W	2,5 cm x 9,14 m	12 pcs	30 x 12 pcs
SNW50009W	5 cm x 9,14 m	6 pcs	30 x 6 pcs



adhesive fabric tape, white

SENSIplast

REF	dimensions	packaging unit box	bulk packaging carton
STA12505W	1,25 cm x 5 m	24 pcs	30 x 24 pcs
STA25005W	2,5 cm x 5 m	12 pcs	30 x 12 pcs
STA50005W	5 cm x 5 m	6 pcs	30 x 6 pcs
STA12509W	1,25 cm x 9,14 m	24 pcs	30 x 24 pcs
STA25009W	2,5 cm x 9,14 m	12 pcs	30 x 12 pcs
STA50009W	5 cm x 9,14 m	6 pcs	30 x 6 pcs
NEW STA25005W-L	2,5 cm x 5 m	12 pcs	30 x 12 pcs



adhesive silk tape

SILKplast

REF	dimensions	packaging unit box	bulk packaging carton
SS12505W	1,25 cm x 5 m	24 pcs	30 x 24 pcs
SS25005W	2,5 cm x 5 m	12 pcs	30 x 12 pcs
SS50005W	5 cm x 5 m	6 pcs	30 x 6 pcs
SS12509W	1,25 cm x 9,14 m	24 pcs	30 x 24 pcs
SS25009W	2,5 cm x 9,14 m	12 pcs	30 x 12 pcs
SS50009W	5 cm x 9,14 m	6 pcs	30 x 6 pcs



adhesive fabric tape, beige colour

PLASTIplast

REF	dimensions	packaging unit box	bulk packaging carton
SZO12505S	1,25 cm x 5 m	24 pcs	30 x 24 pcs
SZO25005S	2,5 cm x 5 m	12 pcs	30 x 12 pcs
SZO50005S	5 cm x 5 m	6 pcs	30 x 6 pcs
NEW SZO25005S-L*	2,5 cm x 5 m	12 pcs	30 x 12 pcs



adhesive PE tape

FILMplast



REF	dimensions	packaging unit box	bulk packaging carton
SPE12505W	1,25 cm x 5 m	24 pcs	30 x 24 pcs
SPE25005W	2,5 cm x 5 m	12 pcs	30 x 12 pcs
SPE50005W	5 cm x 5 m	6 pcs	30 x 6 pcs
SPE12509W	1,25 cm x 9,14 m	24 pcs	30 x 24 pcs
SPE25009W	2,5 cm x 9,14 m	12 pcs	30 x 12 pcs
SPE50009W	5 cm x 9,14 m	6 pcs	30 x 6 pcs



Microporous structure permeable to air and water vapor, allowing proper gas exchange between the foil and the skin, which prevents maceration of the skin.

adhesive perforated non-woven tape

POREplast



REF	dimensions	colour	packaging unit box / cover*	bulk packaging carton
SPW25009W	2,5 cm x 9,14 m	white	12 pcs	30 x 12 pcs
NEW VH-POPP *	2,5 cm x 5 m	pink	1 pc	24 x 24 pcs
NEW VH-POPG *	2,5 cm x 5 m	green	1 pc	24 x 24 pcs



vitahealth

PLASTERS WITH DRESSING

PLASTERS WITH DRESSING

features

- self-adhesive plasters with absorbent pads
- centrally situated absorbent pad absorbs a small and medium amount of exudate and protects from external factors
- absorbent pad coated with a polyethylene mesh that prevents sticking to the wound
- characterized by adequate air and water vapour permeability
- flexible, conforms to the body's contours, guarantees freedom of movement
- silicone backing paper facilitates precise, painless and efficient application
- hypoallergenic

indication

- protection of small skin injuries, cuts, abrasions and lacerations

non-woven plaster with dressing

NONVIplast



REF	dimensions	packaging unit box	bulk packaging carton
NP6100	6 cm x 1 m	1 pc.	200 x 1 pc.
NP6500	6 cm x 5 m	1 pc.	100 x 1 pc.
NP8100	8 cm x 1 m	1 pc.	200 x 1 pc.
NP8500	8 cm x 5 m	1 pc.	100 x 1 pc.



fabric plaster with dressing

FABRIplast



REF	dimensions	packaging unit box	bulk packaging carton
FP6100	6 cm x 1 m	1 pc.	200 x 1 pc.
FP6500	6 cm x 5 m	1 pc.	100 x 1 pc.
FP8100	8 cm x 1 m	1 pc.	200 x 1 pc.
FP8500	8 cm x 5 m	1 pc.	100 x 1 pc.





SPECIAL PURPOSE DRESSINGS

SELF-ADHESIVE NON-WOVEN DRESSINGS

DRESSING TAPE

features

- made of hydrophobic non-woven
- covered with hypoallergenic acrylic glue
- micropores in the structure of the non-woven provide adequate vapor permeability, thanks to which a proper gas exchange between the dressing and the skin takes place
- flexible, conforms to the body's contours, guarantees freedom of movement
- backing layer made of silicone paper
- backing paper with metric scale facilitates the division of the tape and precise, painless and efficient application
- packed in a cardboard box - a dispenser that allows dosing without removing the tape from the packaging

indication

- stabilization, protection and fixation of primary, non-adhesive dressings, applied directly to wounds and skin damages
- stabilization, protection and fixation of drains, catheters, medical tubes

adhesive non-woven dressing tape

elastopor



REF	dimensions	packaging unit box	bulk packaging carton
806009	2,5 cm x 10 m	1 pc.	200 x 1 pc.
806010	5 cm x 10 m	1 pc.	100 x 1 pc.
806011	10 cm x 10 m	1 pc.	50 x 1 pc.
806012	15 cm x 10 m	1 pc.	50 x 1 pc.
806013	20 cm x 10 m	1 pc.	25 x 1 pc.
806014	25 cm x 10 m	1 pc.	25 x 1 pc.
806015	30 cm x 10 m	1 pc.	25 x 1 pc.



elastopor E



REF	dimensions	packaging unit box	bulk packaging carton
* 806009E	2,5 cm x 10 m	1 pc.	200 x 1 pc.
806010E	5 cm x 10 m	1 pc.	100 x 1 pc.
806011E	10 cm x 10 m	1 pc.	50 x 1 pc.
806012E	15 cm x 10 m	1 pc.	50 x 1 pc.
806013E	20 cm x 10 m	1 pc.	25 x 1 pc.
806014E	25 cm x 10 m	1 pc.	25 x 1 pc.
806015E	30 cm x 10 m	1 pc.	25 x 1 pc.

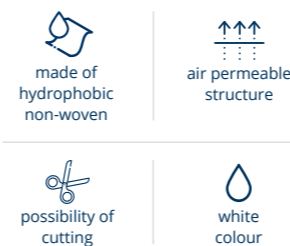

SELF-ADHESIVE DRESSINGS WITH ABSORBENT PAD

features

- self-adhesive dressings with centrally situated absorbent pad, made of hydrophobic non-woven, covered with acrylic glue
- absorbent pad coated with a polyethylene mesh that prevents sticking to the wound, absorbs a small and medium amount of exudate and protects against the influence of external factors
- rounded edges prevent accidental removal of the dressing
- silicone backing paper facilitates the precise, painless and efficient application
- micropores in the structure of the non-woven provide adequate vapor permeability, thanks to which a proper gas exchange between the dressing and the skin takes place
- hypoallergenic



non-woven dressing with absorbent pad

elastopor STERIL

indication

- especially recommended for covering surgical wounds
- for treating wounds with a small and medium amount of exudate

REF	dimensions	packaging unit paper-paper	intermediate packaging box	bulk packaging carton
801001	801001E	5 cm x 7,2 cm	1 pc.	100 x 1 pc.
801012	801012E	6 cm x 10 cm	1 pc.	50 x 1 pc.
801002	801002E	8 cm x 10 cm	1 pc.	30 x 1 pc.
801013	801013E	10 cm x 10 cm	1 pc.	30 x 1 pc.
801021	801021E	10 cm x 12 cm	1 pc.	30 x 1 pc.
801014	801014E	10 cm x 15 cm	1 pc.	30 x 1 pc.
801003	801003E	6 cm x 15 cm	1 pc.	50 x 1 pc.
801004	801004E	8 cm x 15 cm	1 pc.	30 x 1 pc.
801005	801005E	8 cm x 20 cm	1 pc.	30 x 1 pc.
801015	801015E	10 cm x 20 cm	1 pc.	25 x 1 pc.
801016	801016E	10 cm x 25 cm	1 pc.	25 x 1 pc.
801017	801017E	10 cm x 30 cm	1 pc.	25 x 1 pc.
801018	801018E	10 cm x 35 cm	1 pc.	25 x 1 pc.

indexes without the ending E - cutting the securing paper along the long edge (exception 801001; 801012)
indexes with the ending E - the intersection of the securing paper for all indexes along the short edge

non-woven dressing with absorbent pad

elastoKIDS STERIL

indication

- especially recommended for covering surgical wounds
- treating wounds with a small and medium amount of exudate



REF	dimensions	packaging unit paper-paper	intermediate packaging box	bulk packaging carton
801012A	6 cm x 10 cm	1 pc.	50 x 1 pc.	45 x 50 pcs
NEW 801004A	8 cm x 15 cm	1 pc.	30 x 1 pc.	24 x 30 pcs
NEW 801015A	10 cm x 20 cm	1 pc.	25 x 1 pc.	18 x 25 pcs

SELF-ADHESIVE DRESSINGS FOR KIDS

features

- self-adhesive dressing with absorbent pad, made of hydrophobic non-woven material with color overprint, covered by hypoallergenic glue
- absorbent pad coated with polyethylene mesh to prevent sticking to the wound, absorbing small and medium amounts of exudate and protecting against external influences
- rounded edges to prevent accidental removal of the dressing
- protective layer of silicone paper for precise, painless and effective application
- micropores in the non-woven material structure provide an adequate rate of moisture vapour permeability so correct gas exchange between the dressing and skin is guaranteed



non-woven IV cannula dressing

elastopor IV

features

- centrally situated absorbent pad protects the non-woven material from sticking to the injection site
- non-woven lining should be placed under cannula's wings, which prevents it from causing damage to the skin

indication

- dressing application around the inserted cannula
- stabilization, protection and fixation of intravenous cannulas

REF	dimensions	packaging unit paper-paper	intermediate packaging box	bulk packaging carton
811013	811013C 811013E	6 cm x 8 cm	1 pc.	100 x 1 pc.
811012	811012C 811012E	5,1 cm x 7,6 cm	1 pc.	100 x 1 pc.
811023	n/a 811023E	6 cm x 8 cm	1 pc.	50 x 1 pc.
811022	n/a 811022E	5,1 cm x 7,6 cm	1 pc.	50 x 1 pc.

non-woven IV cannula dressing

elastoKIDS IV

features

- centrally situated absorbent pad protects the non-woven material from sticking to the injection site
- non-woven lining should be placed under cannula's wings, which prevents it from causing damage to the skin

indication

- application of the dressing around the cannula
- stabilization, protection and fixation of intravenous cannulas



REF	dimensions	packaging unit paper-paper	intermediate packaging box
811001A	5,1 cm x 7,6 cm	1 pc.	100 x 1 pc.

bulk packaging:
20 x 100 pcs



non-woven dressing with absorbent pad, incision and O-hole

elastopor STERIL D

indication

- dressing application around the inserted drain
- securing the outlet of drains and catheters
- for treating wounds with a small and medium amount of exudate

REF		dimensions	packaging unit paper-paper	intermediate packaging box	bulk packaging carton
801031	801031E	9 cm x 10 cm	1 pc.	30 x 1 pc.	24 x 30 pcs
801030	801030E	12 cm x 14 cm	1 pc.	25 x 1 pc.	16 x 25 pcs

indexes without the ending E - cutting the securing paper along the long edge (exception 801001; 801012)
indexes with the ending E - the intersection of the securing paper for all indexes along the short edge



elastoKIDS STERIL D



indication

- protection of the site of drain or catheter application

REF		dimensions	packaging unit paper-paper	intermediate packaging box
801031A		9 cm x 10 cm	1 pc.	30 x 1 pc.

bulk packaging:
24 x 30 pcs



non-woven eye dressing with absorbent pad

elastopor EYE

indication

- covering an eye and its area after ophthalmic procedures and surgical procedures
- sight correction in strabismus therapy

bulk packaging:
24 x 50 pcs

REF	dimensions	shape	colour	packaging unit paper-paper	intermediate packaging box
803010	5,8 cm x 8,3 cm		absorbent pad - white	1 pc.	50 x 1 pc.
803011	6,5 cm x 9,4 cm		non-woven material - white	1 pc.	50 x 1 pc.
803212	5 cm x 7,5 cm		absorbent pad - white non-woven material - beige colour	1 pc.	50 x 1 pc.

Conforms well to facial contours thanks to the oval shape.



elastoKIDS EYE

NEW 803012A	5 cm x 7,5 cm		absorbent pad - white non-woven material - colourful print	1 pc.	50 x 1 pc.
-------------	---------------	--	---	-------	------------



vitahealth



Colorful kids plasters

elastoKIDS

features

- made of polyethylene film with colourful print
- centrally situated absorbent pad that absorbs small and medium amounts of exudate and protects against external factors
- absorbent pad coated with polyethylene mesh to prevent sticking to the wound
- flexible, conforms to the body contours, guarantees freedom of movement and proper application
- hypoallergenic
- good air and water vapour permeability provides the right conditions for wound healing
- each plaster individually protected by paper-paper packaging

indication

- for protection against contamination of small wounds, skin injuries, cuts, abrasions, lacerations with small to medium amount of exudate

REF	dimensions	packaging unit paper-paper	intermediate packaging box
VH-PDP7219	7,2 cm x 1,9 cm	1 pc.	100 x 1 pc.

bulk packaging:
100 x 100 pcs



conallhealth
Your Partner In Healthcare



set of injection plasters



features

- made of polyurethane film - transparent
- centrally placed absorbent pad - absorbs small and medium wound exudate and protecting from external influences
- absorbent pad coated with polyethylene mesh protects against external factors' influence and does not stick to the wound as well as facilitates removal of the dressing
- flexible, adapting to the shape of the body, provides freedom of movement and proper application
- silicone paper backing facilitates precise, painless and efficient application
- hypoallergenic
- covered with hypoallergenic acrylic glue
- good air and steam permeability provides the right conditions to promote wound healing processes

indication

- for protection against contamination of minor wounds, injuries, cuts, abrasions, cuts, lacerations on the skin with a small and medium amount of exudate

REF	dimensions	packaging unit paper-paper	intermediate packaging box
PI2572	2,5 cm x 7,2 cm	1 pc.	100 x 1 pc.

bulk packaging:
20 x 100 pcs



HOW TO CHOOSE A DRESSING PROPERLY?

When choosing the proper type of dressing, pay special attention to:

- absorption rate and absorption capacity,
- vapor permeability,
- possibility of an atraumatic dressing change,
- safety of use.

STABILIZING TAPES

non-woven nasal cannula fixation plaster

elastoNASAL

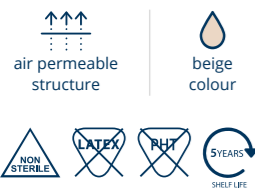
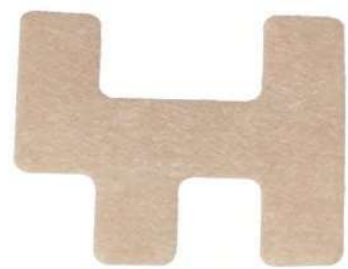

features

- flexible fixation plaster made of non-woven
- covered with acrylic glue
- adequate vapor permeability, thanks to which a proper gas exchange between the dressing and the skin takes place
- thin and flexible plaster is comfortable for the patient, conforms to the body's contours
- "two-stage" application type facilitates precise and efficient application
- self-adhesive
- hypoallergenic

indication

- stabilization of catheters and stomach tubes fixed in the nasal area

REF	dimensions	purpose	packaging unit box
811014	7 cm x 7,1 cm	for adults	50 x 1 pc.
811015	5,9 cm x 6,2 cm	for children	50 x 1 pc.
811016	3,6 cm x 4 cm	for infants	50 x 1 pc.

bulk packaging:
40 x 50 pcs

elastoNASAL KIDS

NEW

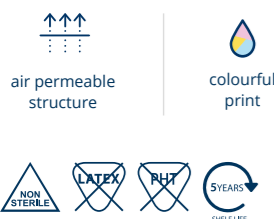

features

- micropores in the non-woven fabric structure provide appropriate vapour-permeability rate, thanks to which proper gas exchange between the dressing and the skin takes place
- elastic - adheres well, conforms to the body contours
- does not absorb X-rays
- acrylic adhesive applied continuously over the entire surface of the plaster
- backing layer of siliconised paper
- two-step application system facilitating precise and effective application
- hypoallergenic

indication

- stabilization of catheters and stomach tubes fixed in the nasal area

REF	dimensions	purpose	packaging unit box
811015A	5,9 cm x 6,2 cm	for children	50 x 1 pc.

bulk packaging:
40 x 50 pcs

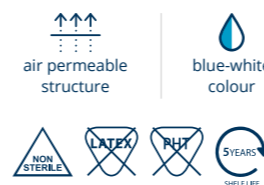

adhesive tape for catheter tubing fixation

elastoFIXAL

features

- two-part fixing tape consisting of a part attached to the skin and a part fastening the drain
- part attached to the patient's skin made of non-woven fabric
- drain fixing part is integrated with a part adhered to the patient's skin and has an additional adhesive tape - Velcro and adhesive field for better drain stabilization
- possibility of reposition and correction of the drain position thanks to Velcro
- covered with hypoallergenic glue

indication

- stabilization of various types of drains and catheters

REF	dimensions	packaging unit paper-foil	intermediate packaging box
816101	9 cm x 4 cm	1 pc.	50 x 1 pc.

bulk packaging:
20 x 50 pcs

elastoFIXAL KIDS

NEW

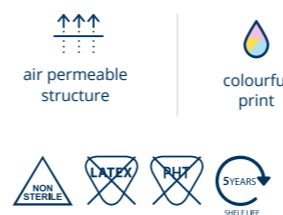

features

- two-part fixing tape consisting of a part attached to the skin and a part fastening the drain
- part attached to the patient's skin made of adhesive colorful non-woven
- drain fixing part is integrated with a part adhered to the patient's skin and has an additional adhesive tape - Velcro and adhesive field for better drain stabilization
- possibility of reposition and correction of the drain position thanks to Velcro
- micropores in the non-woven fabric structure provide appropriate vapour-permeability rate, thanks to which proper gas exchange between the dressing and the skin takes place
- elastic - adheres well, conforms to the body contours
- acrylic adhesive applied continuously over the entire surface of the tape

indication

- device intended for stabilisation and protection of all types of drains, catheters and tubes

REF	dimensions	packaging unit paper-foil	intermediate packaging box
816101A	9 cm x 4 cm	1 pc.	50 x 1 pc.

bulk packaging:
20 x 50 pcs

adhesive tape for endotracheal tube

elastoFIXAL Set

features

- set consisting of 2 self-adhesive non-woven pads and a fastening strap
- self-adhesive non-woven pads attached to the patient's cheeks with an adhesive part with Velcro on the other side
- a strap for stabilization of the endotracheal or oropharyngeal tube made of non-woven fabric which should be attached to the velcro layer with which the pads are covered
- adhesive area in the middle of the strip for better stabilization of the medical tube
- the possibility of repositioning and correcting the position of the tube thanks to the Velcro
- pads and strap covered with hypoallergenic glue
- has excellent adhesive properties and high mechanical strength which prevents premature and accidental detachment from the skin

indication

- long-term stabilization of the endotracheal or oropharyngeal tube

REF	kit composition	packaging unit paper-foil	intermediate packaging box
816102	2 self-adhesive non-woven pads 1 fastening strap	1 set	30x1 set

bulk packaging:
24 x 30 sets



elastoFIXAL Set KIDS

NEW

features

- micropores in the non-woven fabric structure provide appropriate vapour-permeability rate, thanks to which proper gas exchange between the dressing and the skin takes place
- elastic - adheres well, conforms to the body contours
- does not absorb X-rays
- acrylic adhesive applied continuously over the entire surface of the plaster
- backing layer of siliconised paper
- two-step application system facilitating precise and effective application
- hypoallergenic

indication

- device intended for stabilisation of catheters and stomach tubes fixed in the nasal area

REF	kit composition	packaging unit paper-foil	intermediate packaging box
816102A	2 self-adhesive non-woven pads 1 fastening strap	1 set	30 x 1 set

bulk packaging:
24 x 30 sets



ZARYS



WWW.ZARYS.COM



band for tracheostomy tube fixation elastoFIXAL TUBE

features

- stabilising band consisting of two parts made of gentle hydrophobic non-woven fabric in flesh-coloured
- on each part there are fastening strips with Velcro on one side enabling to attach it to the fastening wings of the tracheostomy tube
- shorter part of the stabilising band is additionally equipped with a second Velcro strap attached to an elastic white rubber band which makes it possible to adjust and determine the total length of the band stabilising the tracheostomy tube
- hypoallergenic
- single use

indication

- device intended for stabilisation of tracheostomy tube

REF	dimensions	packaging unit paper-foil	intermediate packaging box	bulk packaging box
EFT2520	25cm x 2,0 cm	1 set	30 x 1 set	20 x 30 sets
EFT4325	43cm x 2,5cm	1 set	20 x 1 set	20 x 20 sets

made of a delicate material
beige colour



adhesive dressing pouch for dialysis catheters

NEW

features

- self-adhesive dressing with a pocket to protect dialysis catheters
- the upper fixing part is made of self-adhesive, breathable, waterproof polyurethane film which is a barrier against contact with water and contamination
- breathable, non-sticky pocket with an outer layer resistant to contact with water and microorganisms provides adequate protection for the tips of dialysis catheters
- lower part stabilizing the pocket made of hydrophobic non-woven fabric

indication

- protective dressing is used to fix dialysis catheters quickly and safely
- dressing protect dialysis catheters against mechanical stress and contamination

REF	dimensions	packaging unit paper-foil	intermediate packaging box
811501	24 cm x 10 cm	1 pc.	25 x 1 pc.

bulk packaging:
4 x 25 pcs



conallhealth
Your Partner In Healthcare



STABILIZING DRESSINGS



FIXATION OF DRESSINGS

SUPPORTING BANDAGES

features

- delicate, light, air and X-ray permeable
- conforms good to the body's contours
- hypoallergenic

indication

- fixation of all types of non-adhesive dressings

knitted supporting bandage

elastoBAND BASIC

features

- contains viscose
- single-use

REF	dimensions	packaging unit paper	bulk packaging carton
OD05400	5 cm x 4 m	1 pc.	250 x 1 pc.
OD10400	10 cm x 4 m	1 pc.	150 x 1 pc.
OD15400	15 cm x 4 m	1 pc.	100 x 1 pc.



elastic supporting bandage, woven

elastoBAND FLEX



features

- supporting bandage, elastic, woven
- high cotton content makes the bandage safe for the skin and well-tolerated by people with allergic tendency
- equipped with a clip for fixing

indication

- fixation of all types of non-adhesive dressings, especially where a non-elastic bandages can slide down
- in session therapy to facilitate correct blood circulation
- stabilization at bone-articular system damage, e.g. dislocation, joint twisting, weakness of muscles, tendons and ligaments
- as a sports bandage
- securing and strengthening integument after surgery

REF - cardboard box	REF - paper pouch	dimensions	packaging unit box/paper	bulk packaging carton
OE08400-E	OE08400P-E	8 cm x 4 m	1 pc.	124 x 1 pc.
OE10400-E	OE10400P-E	10 cm x 4 m	1 pc.	108 x 1 pc.
OE12400-E	OE12400P-E	12 cm x 4 m	1 pc.	96 x 1 pc.
OE15400-E	OE15400P-E	15 cm x 4 m	1 pc.	72 x 1 pc.
OE08500-E	OE08500P-E	8 cm x 5 m	1 pc.	124 x 1 pc.
OE10500-E	OE10500P-E	10 cm x 5 m	1 pc.	108 x 1 pc.
OE12500-E	OE12500P-E	12 cm x 5 m	1 pc.	96 x 1 pc.
OE15500-E	OE15500P-E	15 cm x 5 m	1 pc.	72 x 1 pc.



elastic supporting bandage, woven

elastoBAND FIX



features

- one-layer, woven elastic bandage
- breathable
- bandage does not have therapeutic properties, it is a product supporting the healing process
- packaged in foil-coated paper packaging from underneath

indication

- device intended for holding dressings and for supporting and compressing body parts to treat sprains and strains, and to strengthen skin layers after surgery

REF	dimensions	packaging unit paper	intermediate packaging box	bulk packaging carton
BET06400	6 cm x 4 m	1 pc.	20 x 1 pc.	54 x 20 pcs
BET08400	8 cm x 4 m	1 pc.	20 x 1 pc.	45 x 20 pcs
BET10400	10 cm x 4 m	1 pc.	20 x 1 pc.	36 x 20 pcs
BET12400	12 cm x 4 m	1 pc.	20 x 1 pc.	27 x 20 pcs
BET15400	15 cm x 4 m	1 pc.	20 x 1 pc.	27 x 20 pcs

cohesive supporting bandage, non-woven

elastoBAND CREPP



features

- one-layer, non-woven bandage
- cohesive - adheres to itself (no need for fasteners), does not adhere to skin, hair, etc.
- breathable
- bandage does not have therapeutic properties, it is a product supporting the healing process
- can be divided into smaller sections, no need to use scissors, the bandage can be torn in the hands
- packaged in foil package or cardboard box

indication

- device intended for holding dressings and for supporting and compressing body parts to treat sprains and strains, and to strengthen skin layers after surgery

REF	dimensions	packaging unit foil/box*	intermediate packaging box	bulk packaging carton
OK04400	4 cm x 4 m	1 pc.	10 x 1 pc.	28 x 10 pcs
OK06400	6 cm x 4 m	1 pc.	10 x 1 pc.	20 x 10 pcs
OK062000	6 cm x 20 m	1 pc.*	-	48 x 1 pc.
OK08400	8 cm x 4 m	1 pc.	10 x 1 pc.	16 x 10 pcs
OK082000	8 cm x 20 m	1 pc.*	-	36 x 1 pc.
OK10400	10 cm x 4 m	1 pc.	10 x 1 pc.	12 x 10 pcs
OK102000	10 cm x 20 m	1 pc.*	-	18 x 1 pc.
OK12400	12 cm x 4 m	1 pc.	10 x 1 pc.	8 x 10 pcs
OK122000	12 cm x 20 m	1 pc.*	-	12 x 1 pc.





elastic supporting bandage, knitted

elastoBAND KNITT



features

- one-layer, woven elastic bandage
- breathable
- bandage does not have therapeutic properties, it is a product supporting the healing process
- packaged in foil-coated paper packaging from underneath

indication

- device intended for holding dressings and for supporting and compressing body parts to treat sprains and strains, and to strengthen skin layers after surgery

REF	dimensions	packaging unit paper	intermediate packaging box	bulk packaging carton
BED06400	6 cm x 4 m	1 pc.	20 x 1 pc.	54 x 20 pcs
BED08400	8 cm x 4 m	1 pc.	20 x 1 pc.	45 x 20 pcs
BED10400	10 cm x 4 m	1 pc.	20 x 1 pc.	36 x 20 pcs
BED12400	12 cm x 4 m	1 pc.	20 x 1 pc.	27 x 20 pcs
BED15400	15 cm x 4 m	1 pc.	20 x 1 pc.	27 x 20 pcs



cohesive bandage

yellowBAND

features

- 1-layer, breathable, made of non-woven
- cohesive - it coheres to itself, does not adhere to skin, hair or other materials

indication

- fixation of all types of non-adhesive dressings, especially where the elastic band slides
- fixation of splinting rails
- in compression therapy
- reducing joints mobility after an injury



AVAILABLE SIZES AND COLOURS:



bulk packaging carton

Size	Color	Code	Quantity
2,5cm x 4,5m	White	YCB-2545-X	16 x 36 pcs
5cm x 4,5m	White	YCB-545-S	24 x 12 pcs
	Yellow	YCB-545-Y	
	Green	YCB-545-G	
	Black	YCB-545-X	
	Red	YCB-545-R	
	Blue	YCB-545-B	
	White	YCB-545-W	
	Blue	YCB-545-BC	
	Orange	YCB-545-IO	
	Green	YCB-545-IG	
7,5cm x 4,5m	White	YCB-7545-S	16 x 12 pcs
	Yellow	YCB-7545-Y	
	Green	YCB-7545-G	
	Black	YCB-7545-X	
	Red	YCB-7545-R	
	Blue	YCB-7545-B	
	White	YCB-7545-W	
	Blue	YCB-7545-BC	
	Orange	YCB-7545-IO	
	Green	YCB-7545-IG	
10cm x 4,5m	White	YCB-1045-S	12 x 12 pcs
	Yellow	YCB-1045-Y	
	Green	YCB-1045-G	
	Black	YCB-1045-X	
	Red	YCB-1045-R	
	Blue	YCB-1045-B	
	White	YCB-1045-W	
	Blue	YCB-1045-BC	
	Orange	YCB-1045-IO	
	Green	YCB-1045-IG	
15cm x 4,5m	White	YCB-1545-X	8 x 12 pcs
	Red	YCB-1545-R	
	Blue	YCB-1545-B	



bulk packaging carton

Size	Color	Code	Quantity
2,5cm x 4,5m	White	YCB-2545-LB	16 x 36 pcs
5cm x 4,5m	White	YCB-545-LB	24 x 12 pcs
	Yellow	YCB-545-IP	
	Green	YCB-545-JG	
	Black	YCB-545-V	
	Red	YCB-545-GC	
	Blue	YCB-545-GP	
	White	YCB-545-VP	
	Blue	YCB-545-XP	
	Orange	YCB-545-PH	
	Green	YCB-545-IG	
7,5cm x 4,5m	White	YCB-7545-LB	16 x 12 pcs
	Yellow	YCB-7545-IP	
	Green	YCB-7545-JG	
	Black	YCB-7545-V	
	Red	YCB-7545-GC	
	Blue	YCB-7545-GP	
	White	YCB-7545-VP	
	Blue	YCB-7545-XP	
	Orange	YCB-7545-PH	
	Green	YCB-7545-IG	
10cm x 4,5m	White	YCB-1045-LB	12 x 12 pcs
	Yellow	YCB-1045-IP	
	Green	YCB-1045-JG	
	Black	YCB-1045-V	
	Red	YCB-1045-GP	
	Blue	YCB-1045-VP	
	White	YCB-1045-XP	
	Orange	YCB-1045-PH	
	Green	YCB-1045-IG	
	15cm x 4,5m	White	
Red		YCB-1545-R	
Blue		YCB-1545-B	



elastic tubular net bandage

elastoNET

features

- elastic net bandage in the form of a tube
- contains polyamide and elastomer
- high stretchability and strength of returning to pre-stretch state
- elastic and very soft
- easy and quick to use
- length before stretching:
 - 1 m, stretched: 2,5 m
 - 10 m, stretched: 25 m

indication

- fixation of all dressings on the patient's body, replacing the traditional bandage
- the use of tubular net bandage reduces the time of wound dressing and makes it easier to fix the dressing to the patient's body



REF	length before stretching	size	indication	packaging unit box - dispenser	bulk packaging carton
SO-0101	1 m	1	finger	1 pc.	64 x 1 pc.
SO-0110	10 m	1	finger	1 pc.	6 x 1 pc.
SO-0201	1 m	2	hand, toe	1 pc.	64 x 1 pc.
SO-0210	10m	2	hand, toe	1 pc.	6 x 1 pc.
SO-0301	1 m	3	hand, foot	1 pc.	64 x 1 pc.
SO-0310	10 m	3	hand, foot	1 pc.	6 x 1 pc.
SO-0401	1 m	4	lower leg, knee, arm, foot, elbow	1 pc.	64 x 1 pc.
SO-0410	10 m	4	lower leg, knee, arm, foot, elbow	1 pc.	6 x 1 pc.
SO-0601	1 m	6	head, shoulder, lower leg, knee	1 pc.	64 x 1 pc.
SO-0610	10 m	6	head, shoulder, lower leg, knee	1 pc.	6 x 1 pc.
SO-0801	1 m	8	thigh, head, hips	1 pc.	64 x 1 pc.
SO-0810	10 m	8	thigh, head, hips	1 pc.	6 x 1 pc.
SO-1001	1 m	10	hips, trunk	1 pc.	32 x 1 pc.
SO-1010	10 m	10	hips, trunk	1 pc.	4 x 1 pc.
SO-1401	1 m	14	chest, trunk	1 pc.	32 x 1 pc.
SO-1410	10 m	14	chest, trunk	1 pc.	4 x 1 pc.

FIRST AID FOR DRESSING WOUNDS USING BANDAGES

Hippocrates' achievements in treating head wounds were so widespread and advanced that they are still used today. The Hippocrates cap also called "mitra" is a headgear that allows you to hold the dressing and stop bleeding of the head wound. It is made of two bandage tapes. The main purpose of using the Hippocrates cap is to hold the dressing directly protecting the bleeding head wound, seal and warm the head, hold the compress applied to the skull area, compression, strengthening and immobilization after surgery and additional protection against the external environment. This solution is used in the absence of access to dressings such as elastic dressings and scarves.



How to make a HIPOCRATES CAP?

RULES FOR BANDAGING

1. Prepare a two-head bandage about 5-6 cm wide by sewing together two bands or by twisting the free end to the middle.
2. Put the two-headed bandage on the back of the head and drive bandage to the forehead a circular move.
3. Cross the bandages on the forehead and drive one through the top of the head towards the occiput by a longitudinal move.
4. Drive the other bandage above the ear to the occiput also (half-round).
5. Scroll the longitudinal course through the circular course bandage.
6. Drive back the longitudinal course bandage across the top of the head to the forehead.
7. Drive the circular course bandage around the other ear to the forehead
8. Continue longitudinal and circular moves, the circular course bandage wraps around the scalp
9. Little by little, move the longitudinal course bandage towards the temples
10. After covering the whole area with a two-head bandage, fix the ends of bandage

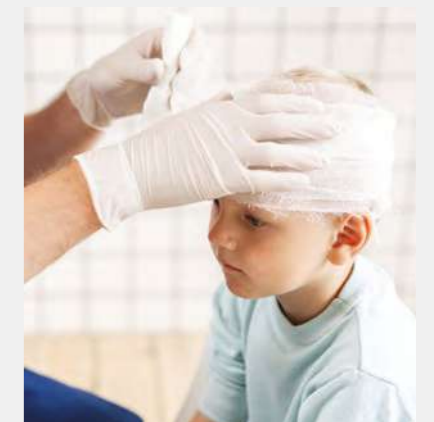

IMMOBILIZING DRESSINGS

ORTHOPEDIC PADDINGS

features

- very soft and fluffy
- adhere well and adjusts to the shape of the body
- coherent structure resistant to stratification makes it easier placement of the immobilizing dressing
- minimize the risk of skin abrasions and irritations under the P.O.P. bandage
- do not absorb moisture and thus do not allow for its contact with the skin
- hypoallergenic

indication

- as a protective layer put under plaster of Paris bandages
- in compression therapy as a padding under the bandages of various elasticity



made of viscose

white colour

* available on request

orthopedic padding, natural

orthoNATURAL

REF	dimensions	packaging unit paper cover	intermediate packaging foil bag	bulk packaging box
*ON-63	6 cm x 3 m	1 pc.	12 x 1 pc.	40 x 12 pcs
*ON-83	8 cm x 3 m	1 pc.	12 x 1 pc.	40 x 12 pcs
ON-103	10 cm x 3 m	1 pc.	12 x 1 pc.	20 x 12 pcs
ON-123	12 cm x 3 m	1 pc.	6 x 1 pc.	40 x 6 pcs
ON-153	15 cm x 3 m	1 pc.	6 x 1 pc.	30 x 6 pcs
*ON-203	20 cm x 3 m	1 pc.	6 x 1 pc.	20 x 6 pcs
*ON-253	25 cm x 3 m	1 pc.	6 x 1 pc.	10 x 6 pcs



made of polyester

white colour

orthopedic padding, synthetic

orthoSYNTHETIC

REF	dimensions	packaging unit paper cover	intermediate packaging foil bag	bulk packaging box
OS-63	6 cm x 3 m	1 pc.	12 x 1 pc.	40 x 12 pcs
OS-83	8 cm x 3 m	1 pc.	12 x 1 pc.	40 x 12 pcs
OS-103	10 cm x 3 m	1 pc.	12 x 1 pc.	20 x 12 pcs
OS-123	12 cm x 3 m	1 pc.	6 x 1 pc..	40 x 6 pcs
OS-153	15 cm x 3 m	1 pc.	6 x 1 pc.	30 x 6 pcs
OS-203	20 cm x 3 m	1 pc.	6 x 1 pc.	20 x 6 pcs
OS-253	25 cm x 3 m	1 pc.	6 x 1 pc.	10 x 6 pcs



white colour

triangular sling

elastoSLING

features

- triangle shaped sling made of non-woven or cotton
- thin, light and elastic - comfortable for the patient, adjusts to the shape of the body, provides freedom of movement
- possibility of connecting several slings to achieve bigger immobilization
- hypoallergenic

indication

- short-term immobilization and support of the upper limb in case of various injuries e.g. dislocation or fracture of collar bone, humerus, forearm or hand bone

REF	dimensions	description	packaging unit zipper pouch	intermediate packaging foil bag
CHTW9696136	96 cm x 96 cm x 136 cm	non-woven	1 pc.	12 x 1 pc.
CHTB9696130	96 cm x 96 cm x 130 cm	cotton	1 pc.	12 x 1 pc.



bulk packaging: 20 x 12 pcs



HOW TO PROPERLY PUT ON A TRIANGULAR SLING?

1. Place the triangular sling on the patient's body so that one of the corners of the sling is at the level of the elbow of the immobilized hand.
2. Place the second corner of the sling on the opposite arm in relation to the immobilized hand.
3. Carefully place the sick / injured limb on the sling.
4. Wrap the sick/injured limb with dangling, third corner of the sling.
5. Make sure that the hand is in the right position, and then tie the corners of the sling around the neck.

P.O.P. BANDAGES

features

- made of cotton gauze coated with natural plaster of Paris on both sides
- on a plastic roll
- enable fast and durable immobilization
- before fixing need to be soaked in a container with water at 20°C temperature
- do not absorb X-rays

indication

- large and small immobilizing dressings in orthopedic, ambulatory and surgical procedures



P.O.P. bandage orthoBAND FAST



fast-setting

setting time approx. **3 minutes**
fully dry after approx. **24 hours**

REF	dimensions	type of edge	packaging unit foil bag	bulk packaging carton
OB06300-F	6 cm x 3 m	straight	1 pc.	48 x 1 pc.
OB08300-F	8 cm x 3 m	straight	1 pc.	48 x 1 pc.
OB10300-F	10 cm x 3 m	serrated	1 pc.	48 x 1 pc.
OB12300-F	12 cm x 3 m	serrated	1 pc.	48 x 1 pc.
OB14300-F	14 cm x 3 m	serrated	1 pc.	36 x 1 pc.
OB15300-F	15 cm x 3 m	serrated	1 pc.	36 x 1 pc.
OB20300-F	20 cm x 3 m	serrated	1 pc.	24 x 1 pc.



orthoBAND NORMAL



fast-setting

setting time approx. **5-6 minutes**
fully dry after approx. **24 hours**

REF	dimensions	type of edge	packaging unit foil bag	bulk packaging carton
OB06300-N	6 cm x 3 m	straight	1 pc.	48 x 1 pc.
OB08300-N	8 cm x 3 m	straight	1 pc.	48 x 1 pc.
OB10300-N	10 cm x 3 m	serrated	1 pc.	48 x 1 pc.
OB12300-N	12 cm x 3 m	serrated	1 pc.	48 x 1 pc.
OB14300-N	14 cm x 3 m	serrated	1 pc.	36 x 1 pc.
OB15300-N	15 cm x 3 m	serrated	1 pc.	36 x 1 pc.
OB20300-N	20 cm x 3 m	serrated	1 pc.	24 x 1 pc.



orthoBAND LONG



slow-setting

setting time approx. **8-12 minutes**
fully dry after approx. **24 hours**

REF	dimensions	type of edge	packaging unit foil bag	bulk packaging carton
OB10400-L	10 cm x 4 m	serrated	1 pc.	48 x 1 pc.
OB12400-L	12 cm x 4 m	serrated	1 pc.	36 x 1 pc.
OB15400-L	15 cm x 4 m	serrated	1 pc.	24 x 1 pc.



RULES FOR BANDAGING



Select a bandage of proper type and size for the part of the body to be bandaged.



With your right hand, grasp the beginning of the band, and with your left hand hold the rolled part so called "head".

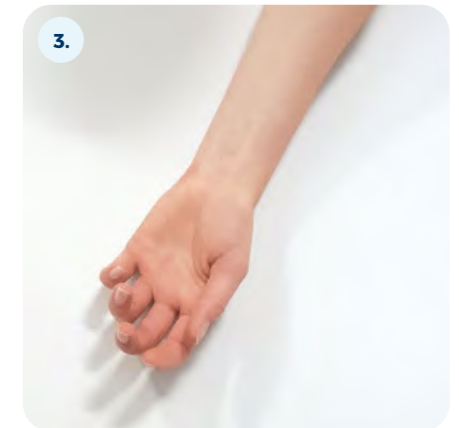

Put the patient in a comfortable position supporting the bandaged lower or upper limb.



For proper stabilization of dressing, start bandaging with a circular wrap, each subsequent layer covers exactly the previous one in a durable and aesthetic way. Little by little unroll the band during bandaging. Finish the bandaging with a circular wrap, end of the dressing secure with a clip or tie it.



The bandage should adhere correctly to the patient's body and be rolled up with adequate power – too much pressure can lead to impaired circulation, too loose it will slide and fall.



Remove the bandage by transferring it from one hand to other to minimize patient movement.

ZARYS



WWW.ZARYS.COM

SPECIALIST DRESSINGS

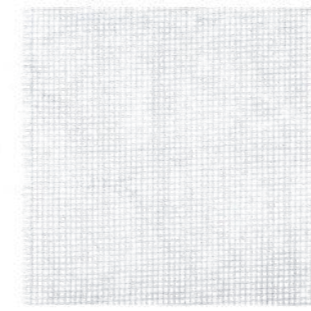

soaked with paraffin



possibility of cutting



paraffin gauze dressing

paraffiNET

features

- wide-mesh dressing made of cotton gauze covered with paraffin
- structure of the carrier material allows exudate to be freely drained to the covering secondary dressing
- covering with a layer of paraffin reduces risk of adhesion to the wound and allows a painless change of dressing
- neutral properties of paraffin allow for using the dressing in combination with other preparations containing medicinal substances or antiseptics
- can be shaped and cut according to the needs aseptically
- needs to be covered with a dressing with absorbent properties, e.g. compress, high-absorption dressing, polyurethane foam
- non-adhesive, necessary fixing with a tape, bandage or net tubular dressing
- hypoallergenic

indication

- keeping proper moisture in the wound
- preventing the wound edges from drying and maceration
- recommended for uninfected wounds
- treatment of chronic wounds: various ulcers, bedsores
- treatment of surgical and burn wounds, skin donor and grafting sites, skin damage, cuts
- protection against radiation skin damage

REF	dimensions	packaging unit paper-aluminum foil	intermediate packaging box
PAR-01	5 cm x 5 cm	1 pc.	10 x 1 pc.
PAR-02	10 cm x 10 cm	1 pc.	10 x 1 pc.
PAR-06	10 cm x 40 cm	1 pc.	10 x 1 pc.
PAR-07	15 cm x 20 cm	1 pc.	10 x 1 pc.

FOIL DRESSINGS

bulk packaging:
50 x 10 pcs

FOIL DRESSINGS

features

- made of polyurethane film
- covered with hypoallergenic acrylic glue
- transparent - they allow observation of the dressed place without the need to remove the dressing
- vapour permeability guarantees correct gas exchange between the dressing and the skin, and prevents it from excessive moisture accumulation and maceration
- barrier against microorganisms and bacteria, minimizing the risk of infection
- very thin and elastic - adjust to the shape of the body, guarantee freedom of movement
- waterproof
- self-adhesive
- hypoallergenic

elastoDERM

dressing without absorbent pad, with "three-stage" application type



REF	dimensions	shape	indication	packaging unit paper-paper	intermediate packaging box
811210	6 cm x 7 cm		- fixing and securing intravenous cannulas - secondary dressing - bed sore prevention, works as so-called „second skin“ - for small epidermal abrasions and damages of the skin surface	1 pc.	100 x 1 pc.

bulk packaging:
30 x 100 pcs





1. Remove the back paper protection.



2. Apply the dressing to the desired place.



3. Remove the paper protection on the outer side of the dressing starting from the cut.



4. Put the notes on the tape to describe the dressing and apply it on the dressing without covering the wound/ the place of needle insertion.

features

- "frame" or three-stage" application system makes dressing placement precise and accurate
- available in several sizes and options:
 - with a central absorbent pad
 - with notch enabling the dressing to fit the cannulas
 - without notch and absorbent pad

elastoDERM F

dressing without absorbent pad, with "frame" application type

REF	dimensions	shape	indication	packaging unit paper-paper	intermediate packaging box	bulk packaging box
812003	4,4 cm x 4,4 cm		- fixing and securing intravenous cannulas - secondary dressing	1 pc.	100 x 1 pc.	36 x 100 pcs
812005	6 cm x 7 cm		- bed sore prevention, works as so-called "second skin" - for small epidermal abrasions and damages of the skin surface	1 pc.	100 x 1 pc.	30 x 100 pcs
with special area to write notes						
812008	10 cm x 12 cm		- fixing and securing central venous catheters - fixing epidural catheters - secondary dressing	1 pc.	100 x 1 pc.	20 x 100 pcs
with special area to write notes						
812011	10 cm x 15 cm		- bed sore prevention, works as so-called "second skin" - for small epidermal abrasions and damages of the skin surface	1 pc.	100 x 1 pc.	20 x 100 pcs
with special area to write notes						



elastoDERM F-IV

IV cannula dressing, with "frame" application type

REF	dimensions	shape	indication	packaging unit paper-paper	intermediate packaging box
812006	6 cm x 7 cm		- fixing and securing peripheral cannulas in adults - securing cannulas inserted into central veins	1 pc.	100 x 1 pc.
with special area to write notes					



bulk packaging:
30 x 100 pcs

elastoDERM IV

IV cannula dressing, with "three-stage" application type

REF	dimensions	shape	indication	packaging unit paper-paper	intermediate packaging box
811301	5,8 cm x 8 cm		- fixing and securing peripheral cannulas in adults	1 pc.	100 x 1 pc.
with special area to write notes					



bulk packaging:
20 x 100 pcs

elastoDERM PAD

dressing with central absorbent pad, with "three-stage" application type

REF	dimensions	shape	indication	packaging unit paper-paper	intermediate packaging box	bulk packaging box
802012	6 cm x 7 cm		- protection of post-operative wounds and stitches	1 pc.	100 x 1 pc.	12 x 100 pcs
802014	9 cm x 10 cm			1 pc.	50 x 1 pc.	24 x 50 pcs
802015	9 cm x 15 cm			1 pc.	50 x 1 pc.	24 x 50 pcs
802016	10 cm x 20 cm			1 pc.	50 x 1 pc.	18 x 50 pcs
802018	10 cm x 25 cm			1 pc.	50 x 1 pc.	15 x 50 pcs



ZARYS



WWW.ZARYS.COM

ADDITIONAL PRODUCTS



cold/warm compress

thermPAD



features

- cold/warm gel compress made of non-toxic durable film with gel insert
- presence of a fabric cover to prevent external damage
- ability to store and return accumulated heat or cold for a long time
- remains flexible after freezing, allowing the compress to be easily shaped to the body area
- reusable

indication

- device used for the local cooling or heating of specific areas of the body to combat pain/neuralgia and reduce swelling and puffiness

REF	dimensions	packaging unit foil bag	bulk packaging carton
KCZ7513	7,5 cm x 13 cm	1 pc.	100 x 1 pc.
KCZ7552	7,5 cm x 52 cm	1 pc.	30 x 1 pc.
KCZ1229	12 cm x 29 cm	1 pc.	25 x 1 pc.
KCZ1314	13 cm x 14 cm	1 pc.	50 x 1 pc.
KCZ1626	16 cm x 26 cm	1 pc.	20 x 1 pc.
KCZ2138	21 cm x 38 cm	1 pc.	10 x 1 pc.
KCZ3040	30 cm x 40 cm	1 pc.	8 x 1 pc.



gynaecological-maternity pad

gynPAD



features

- an absorbent pad with an adhesive layer
- it has a layered construction
- pink foil sheet placed in the lower part of the pad as an insulating part to protect against wetness
- provides increased absorption capacity due to the highly absorbent cellulose pad
- structure of the dressing allows free passage of exudate to the absorbent pad inside
- can be used as a primary as well as a secondary dressing
- can be sterilised with ethylene oxide

indication

- device used to absorb bodily fluids resulting from surgery, childbirth to protect the patient from contamination and infection

REF	dimensions	packaging unit foil bag	intermediate packaging box
PG34090	34 cm x 9 cm	1 pc.	25 x 1 pc.

bulk packaging:
50 x 25 pcs



Alcohol Prep Pad

features

- made of non-woven
- each gauze pad is packed separately, in aluminum foil - paper
- soaked with isopropyl alcohol (70%)
- two pouches connected in one-piece packaging can be separated thanks to perforation (without L-06)

indication

- disinfection low surface

REF	dimensions	packaging unit paper-aluminum foil	bulk packaging box
P2-IA-1	M 65 mm x 55 mm (unfolded) 32,5 mm x 27,5 mm (folded)	2 x 1 pc.	100 x 1 pc. (50 x 2 pcs.)
P2-IA-2	XL 110 mm x 90 mm (unfolded) 55 mm x 45 mm (folded)	2 x 1 pc.	100 x 1 pc. (50 x 2 pcs.)



gauze pad moistened with alcohol

ALKOPAD

features

- made of non-woven
- each gauze pad is packed separately, in aluminum foil - paper
- soaked with isopropyl alcohol (70%)
- two pouches connected in one-piece packaging can be separated thanks to perforation (without L-06)

indication

- disinfection low surface

REF	dimensions	packaging unit paper-aluminum foil	bulk packaging box
L-06	XXL 190 mm x 140 mm (unfolded)	2 x 1 pc.	50 x 1 pc. (25 x 2 pcs.)



ALKOPAD DUO

features

- made of non-woven
- each gauze pad is packed separately, in aluminum foil - paper
- gauze pad wet soaked with isopropyl alcohol (70%) and gauze pad dry
- two pouches connected in one-piece packaging can be separated thanks to perforation

indication

- disinfection low surface

REF	dimensions	packaging unit paper-aluminum foil	bulk packaging box
L-05DUO	125 mm x 125 mm	2 x 1 pc.	50 x 2 pcs



gauze pad moistened with alcohol

Alcohol Prep Pad

features

- made of non-woven
- soaked with isopropyl alcohol (70%)
- two pouches connected in one-piece packaging can be separated thanks to perforation

indication

- disinfection of small surfaces

REF	dimensions	no. of plies	packaging unit paper-aluminum foil	bulk packaging box
P1-IA-2	30 mm x 65 mm (unfolded) 30 mm x 32,5 mm (folded)	2	2 x 1 pc.	100 x 1 pc. 50 x 2 pcs



rescue blanket, foil, termic

features

- made of metallized PE foil
- protects against adverse weather conditions - cold, rain, heat, wind, depending on the side, which is applied towards the victim's body, prevents the life-threatening heat disorders and reduces the risk of shock
- resistant to damage

indication

- protection against hypothermia and overheating of the victim's body
- in emergency cases such as car accidents, ski accidents, in mountain tourism, in sport

REF	dimensions	purpose	packaging unit zipper pouch	intermediate packaging foil bag
KR160210	160 cm x 210 cm	for adults	1 pc.	12 x 1 pc.



bulk packaging:
20 x 12 pcs

surgical kits

The company's offer also includes small procedure packs under the deltaset brand. They are used in treatment rooms, emergencies, hospital wards or dialysis units. They contain all disposable products necessary to perform the procedure in aseptic manner.

Deltaset packages are dedicated to a specific procedure, e.g. for changing a dressing, catheterization, dialysis or anaesthesia. The set includes: disposable equipment, dressings, surgical drapes, surgical instruments, accessories, medical gloves and many more.



standard surgical kits

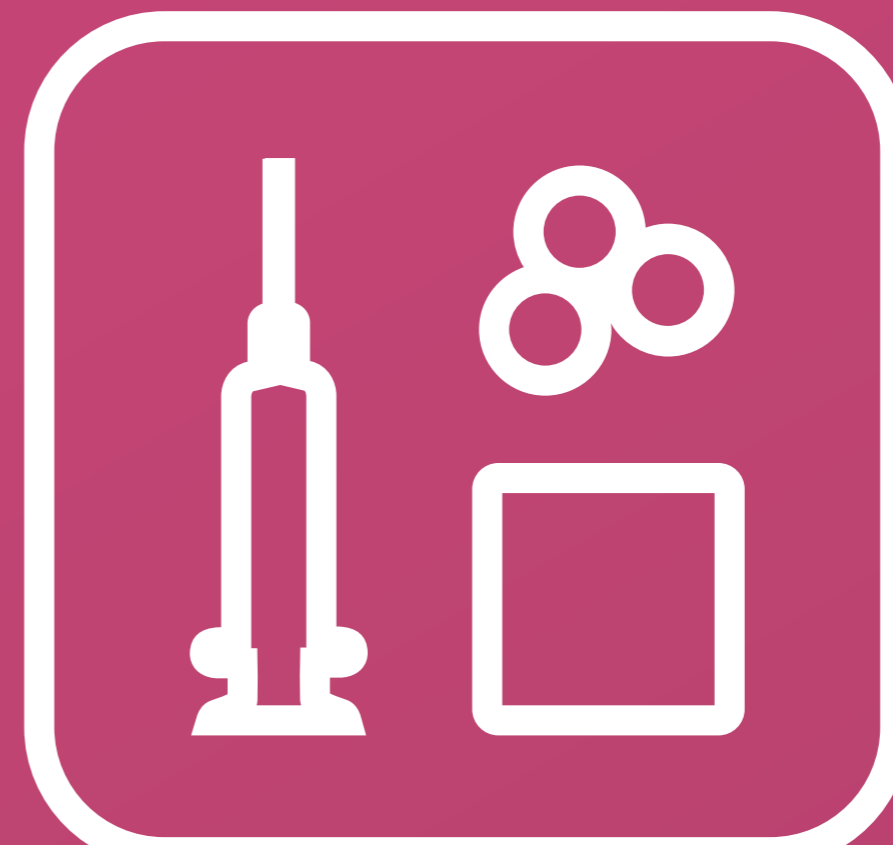

deltaset label

name of the set/product

set components

open here

information pictograms

TAG stickers

TAG STICKER

LOT number

REF number

expiration date

manufacturer

barcode

Features of hard blister packaging along with the most important advantages, deltaxet used in the operating room

safe packing of the package components

protection against damage to the components of the package

containers for liquids and waste

easy identification of the contents of the package

rounded edges of the blister

orderly arrangement of the package components

segregation of clean and dirty material

1-chamber blister



2-chamber blister



3-chamber blister



ZARYS



WWW.ZARYS.COM

STANDARD DELTASET SURGICAL KITS

DS-WKL-O-01 PUNCTURE KIT 1



features

- single-use
- for short-term use
- shelf life: 3 years
- label with 2 adhesive tag labels for data archiving; the following information is available on each adhesive tag label: REF number, expiry date, batch number, manufacturer's data and barcode
- packaging: double-chamber hard blister

indication

- intended for use in treatment rooms, emergency services or hospital wards
- it contains auxiliary disposable medical devices necessary to perform the central puncture procedure

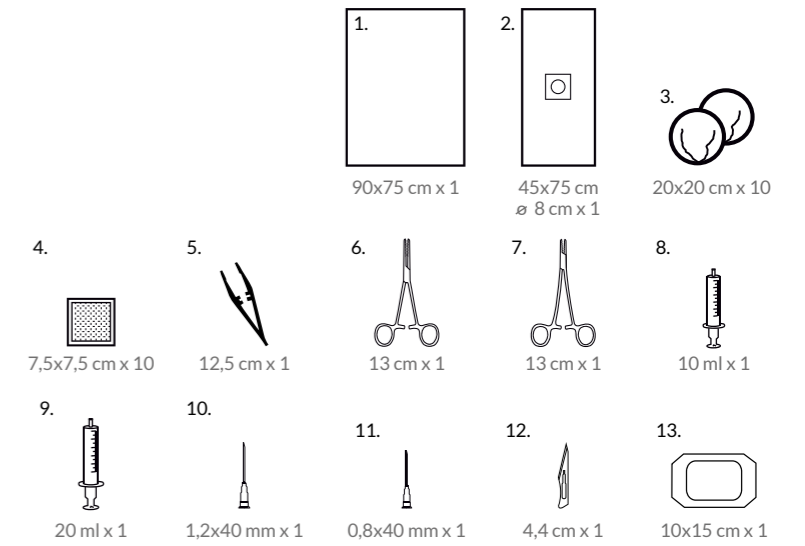

no.	quantity	component	specification	individual packaging
1.	1 pc.	2-layer surgical drape	90 cm x 75 cm cellulose layer + waterproof polyethylene film; blue colour	1 kit double-chamber hard blister
2.	1 pc.	2-layer surgical drape with central adhesive fenestration	45 cm x 75 cm fenestration dia. 8 cm, cellulose layer + waterproof polyethylene film; blue colour	
3.	10 pcs	gauze ball without X-ray thread	20 cm x 20 cm 17-thread cotton gauze; white colour	
4.	10 pcs	gauze swab	7,5 cm x 7,5 cm 17-thread cotton gauze, 8-ply; white colour	
5.	1 pc.	plastic tweezers	length 12,5 cm, polypropylene; blue colour	
6.	1 pc.	metal grasper (Pean)	length 13 cm, stainless steel	
7.	1 pc.	metal needle holder MAYO-HEGAR	length 13 cm, stainless steel	
8.	1 pc.	two-piece syringe in paper-foil packaging	capacity 10 ml, Luer	
9.	1 pc.	two-piece syringe in paper-foil packaging	capacity 20 ml, Luer	
10.	1 pc.	injection needle in paper-foil packaging	1,2 mm x 40 mm	
11.	1 pc.	injection needle in paper-foil packaging	0,8 mm x 40 mm	
12.	1 pc.	surgical blade	no. 11	
13.	1 pc.	foil dressing with frame and tape for description in paper-foil packaging	10 cm x 15 cm, polyethylene film	



DS-USZ-O-01 SUTURE REMOVAL KIT 1



features

- single-use
- for short-term use
- shelf life: 3 years
- label with 2 adhesive tag labels for data archiving; the following information is available on each adhesive tag label: REF number, expiry date, batch number, manufacturer's data and barcode
- packaging: single-chamber hard blister

indication

- intended for use in treatment rooms, emergency services, hospital wards or dialysis stations
- it contains auxiliary disposable medical devices necessary to perform the suture removal procedure

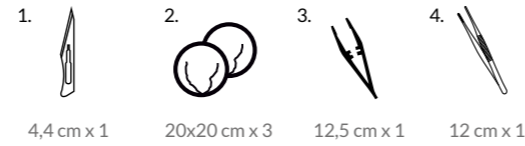

no.	quantity	component	specification	individual packaging
1.	1 pc.	surgical blade	no. 11	1 kit single-chamber hard blister
2.	3 pcs	non-woven ball without X-ray thread	20cm x 20cm, non-woven 30G, white colour	
3.	1 pc.	plastic tweezers	length 12,5cm, polypropylene, blue colour	
4.	1 pc.	anatomic metal tweezers	length 12cm, stainless steel	

DS-CEW-O-01 URINARY BLADDER CATHETERIZATION KIT 1



features

- single-use
- for short-term use
- shelf life: 3 years
- label with 2 adhesive tag labels for data archiving; the following information is available on each adhesive tag label: REF number, expiry date, batch number, manufacturer's data and barcode
- packaging: single-chamber hard blister

indication

- intended for use in treatment rooms, emergency services or hospital wards
- it contains auxiliary disposable medical devices necessary to perform the urinary bladder catheterisation procedure

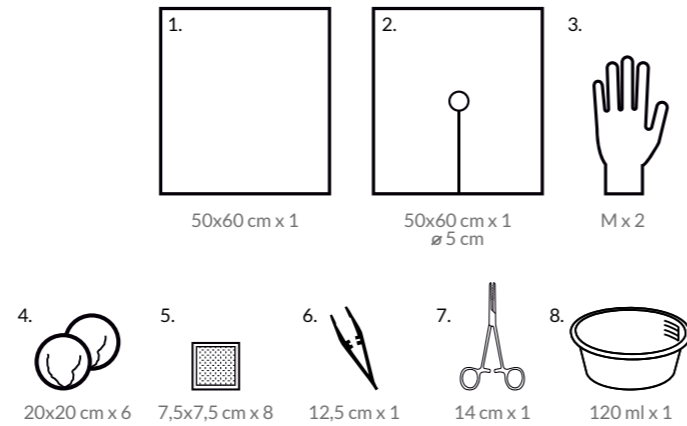

no.	quantity	component	specification	individual packaging
1.	1 pc.	2-layer surgical drape	50cm x 60cm non-woven polypropylene + waterproof, polyethylene film; blue colour	1 kit single-chamber hard blister
2.	1 pc.	2-layer surgical drape with central, fenestration and incision	50cm x 60cm fenestration: diameter 5cm, non-woven polypropylene + waterproof, polyethylene film; blue colour	
3.	2 pcs	examination gloves, nitrile, powderfree, in paper packaging	size. M, 100% nitrile; light blue colour	
4.	6 pcs	gauze ball without X-ray thread	20cm x 20cm, 17-thread cotton gauze; white colour	
5.	8 pcs	gauze swab	7,5cm x 7,5cm, 17-thread cotton gauze, 8-ply; white colour	
6.	1 pc.	plastic tweezers	length 12,5cm, polypropylene; green colour	
7.	1 pc.	plastic grasper (Pean)	length 14cm, polypropylene; blue colour	
8.	1 pc.	sponge bowl	capacity 120ml, polypropylene; transparent colour	

DS-CEW-O-02 URINARY BLADDER CATHETERIZATION KIT 2



features

- single-use
- for short-term use
- shelf life: 3 years
- label with 2 adhesive tag labels for data archiving; the following information is available on each adhesive tag label: REF number, expiry date, batch number, manufacturer's data and barcode
- packaging: single-chamber hard blister

indication

- intended for use in treatment rooms, emergency services or hospital wards
- it contains auxiliary disposable medical devices necessary to perform the urinary bladder catheterisation procedure

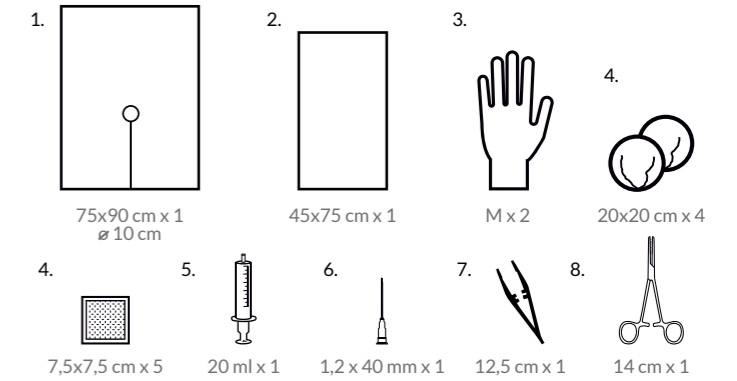

no.	quantity	component	specification	individual packaging
1.	1 pc.	2-layer surgical drape with central, fenestration and incision	75cm x 90cm, fenestration: diameter 10 cm non-woven polypropylene + waterproof polyethylene film; blue colour	1 kit single-chamber hard blister
2.	1 pc.	2-layer surgical drape	45cm x 75cm, non-woven polypropylene + waterproof, polyethylene film; blue colour	
3.	2 pcs	examination gloves, nitrile, powderfree, in paper packaging	size. M, 100% nitrile; light blue colour	
4.	4 pcs	gauze ball without X-ray thread	20cm x 20cm, 17-thread cotton gauze; white colour	
5.	5 pcs	gauze swab	7,5cm x 7,5cm, 17-thread cotton gauze, 8-ply; white colour	
6.	1 pc.	two-piece syringe in paper-foil packaging	capacity 20ml, Luer	
7.	1 pc.	injection needle in paper-foil packaging	1,2mm x 40mm	
8.	1 pc.	plastic tweezers	length 12,5cm, polypropylene; green colour	
9.	1 pc.	plastic grasper (Pean)	length 14cm, polypropylene; blue colour	

DS-DIA-O-01A DIALYSIS ON KIT 1A



features

- single-use
- for short-term use
- shelf life: 3 years
- label with 2 adhesive tag labels for data archiving; the following information is available on each adhesive tag label: REF number, expiry date, batch number, manufacturer's data and barcode
- packaging: soft blister paper-foil

indication

- intended for use in treatment rooms, emergency services, hospital wards or dialysis stations
- it contains auxiliary disposable medical devices necessary to perform the dialysis procedure

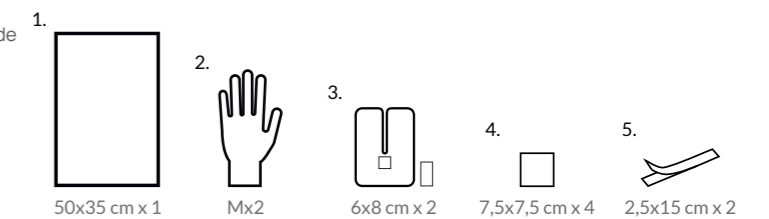

no.	quantity	component	specification	individual packaging
1.	1 pc.	2-layer surgical drape	50cm x 35cm cellulose layer + waterproof polyethylene film; blue colour	1 kit soft blister paper-foil
2.	2 pcs	examination gloves, nitrile, powderfree in paper packaging	size. M, 100% nitrile; light blue colour	
3.	2 pcs	IV cannula dressing, self-adhesive	6cm x 8cm, hydrophobic non-woven	
4.	4 pcs	non-woven swab	7,5cm x 7,5cm, non-woven 30G, 4 ply; white colour	
5.	2 pcs	dressing tape, self-adhesive	2,5cm x 15cm	

DS-DIA-O-01B DIALYSIS OFF KIT 1B



features

- single-use
- for short-term use
- shelf life: 3 years
- label with 2 adhesive tag labels for data archiving; the following information is available on each adhesive tag label: REF number, expiry date, batch number, manufacturer's data and barcode
- packaging: soft blister paper-foil

indication

- intended for use in treatment rooms, emergency services, hospital wards or dialysis stations
- it contains auxiliary disposable medical devices necessary to perform the dialysis procedure

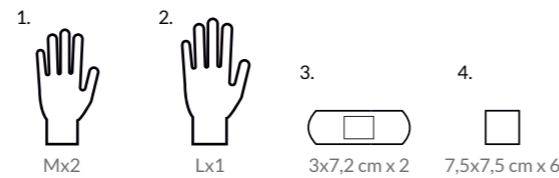

no.	quantity	component	specification	individual packaging
1.	2 pcs	examination gloves, nitrile, powderfree in paper packaging	size. M 100% nitrile; light blue colour	1 kit soft blister paper-foil
2.	1 pc.	examination gloves, nitrile	size. L 100% nitrile; white colour	
3.	2 pcs	post-injection dressing, self-adhesive	3cm x 7,2cm polyethylene film; transparent	
4.	6 pcs	non-woven swab	7,5cm x 7,5cm non-woven 30G, 4 ply; colour white	

DS-DIA-O-02 DIALYSIS ON/OFF KIT 2



features

- single-use
- for short-term use
- shelf life: 3 years
- label with 2 adhesive tag labels for data archiving; the following information is available on each adhesive tag label: REF number, expiry date, batch number, manufacturer's data and barcode
- packaging: two-piece soft blister with perforation, paper-foil

indication

- intended for use in treatment rooms, emergency services or hospital wards
- it contains auxiliary disposable medical devices necessary to perform the puncture procedure e.g. central venepuncture, subarachnoid puncture

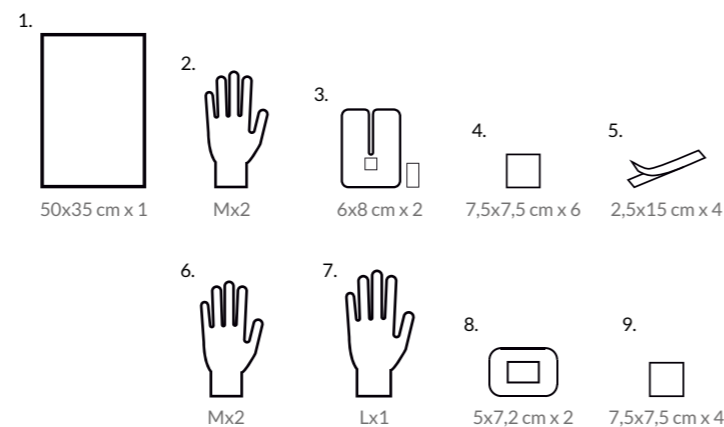

no.	quantity	component	specification	individual packaging
1.	1 pc.	2-layer surgical drape	50cm x 35cm; cellulose layer + waterproof polyethylene film; blue colour	1 kit two-piece soft blister with perforation, paper-foil
2.	2 pcs	examination gloves, nitrile, powderfree in paper packaging	size. M, 100% nitrile; light blue colour	
3.	2 pcs	IV cannula dressing, self-adhesive	6cm x 8cm, hydrophobic non-woven	
4.	6 pcs	non-woven swab	7,5cm x 7,5cm, non-woven 30G, 4 ply; white colour	
5.	4 pcs	dressing tape, self-adhesive	2,5cm x 15cm	
6.	2 pcs	examination gloves, nitrile, powderfree in paper packaging	size. M, 100% nitrile; light blue colour	
7.	1 pc.	examination gloves, nitrile	size. L, 100% nitrile; white colour	
8.	2 pcs	dressing with absorbent pad, selfadhesive	5cm x 7,2cm	
9.	4 pcs	non-woven swab	7,5cm x 7,5cm, non-woven 30G, 4 ply; colour white	

DS-ZNI-O-01 ANASTHESIA KIT 1



features

- single-use
- for short-term use
- shelf life: 3 years
- label with 2 adhesive tag labels for data archiving; the following information is available on each adhesive tag label: REF number, expiry date, batch number, manufacturer's data and barcode
- packaging: three-chamber hard blister

indication

- intended for use in treatment rooms, emergency services or hospital wards
- it contains auxiliary disposable medical devices necessary to perform procedures of conduction anesthesia

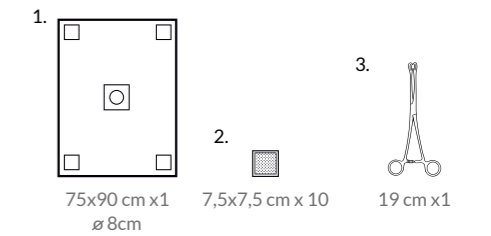

no.	quantity	component	specification	individual packaging
1.	1 pc.	2-layer surgical drape with central fenestration and adhesive corners	75cm x 90cm; fenestration: diameter 8 cm; non-woven polypropylene + waterproof polyethylene film; blue colour	1 kit three-chamber hard blister
2.	10 pcs	gauze swab	7,5cm x 7,5cm, 17-thread cotton gauze, 8 ply; white colour	
3.	1 pc.	plastic window forceps, Korcang type, wrapped in a 2-layer drape with a cellulose layer	length 19 cm, 45cm x 45cm, cellulose layer + waterproof polyethylene film, blue colour	

DS-SZY-O-01 SUTURE APPLICATION KIT 1



features

- single-use
- for short-term use
- shelf life: 3 years
- label with 2 adhesive tag labels for data archiving; the following information is available on each adhesive tag label: REF number, expiry date, batch number, manufacturer's data and barcode
- packaging: double-chamber hard blister

indication

- intended for use in treatment rooms, emergency services or hospital wards
- it contains auxiliary disposable medical devices necessary to perform the puncture procedure e.g. central venepuncture, subarachnoid puncture

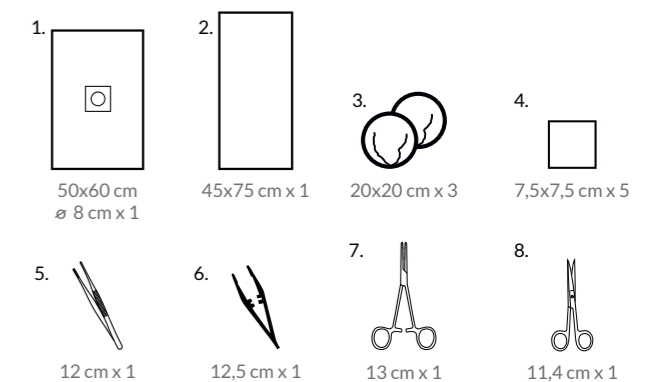

no.	quantity	component	specification	individual packaging
1.	1 pc.	2-layer surgical drape with central adhesive fenestration	50cm x 60cm, fenestration: diameter 8 cm; non-woven polypropylene + waterproof polyethylene film; blue colour	1 kit double-chamber hard blister
2.	1 pc.	2-layer surgical drape	45cm x 75cm, non-woven polypropylene + waterproof polyethylene film; blue colour	
3.	3 pcs	gauze ball without X-ray thread	20cm x 20cm 17-thread cotton gauze; white colour	
4.	5 pcs	non-woven swab	7,5cm x 7,5cm non-woven 30G, 4 ply; white colour	
5.	1 pc.	anatomic metal tweezers	length 12cm stainless steel	
6.	1 pc.	plastic tweezers	length 12,5cm polypropylene; green colour	
7.	1 pc.	metal needle holder MAYO-HEGAR	length 13 cm stainless steel	
8.	1 pc.	metal scissors sharp/sharp	length 11,4cm stainless steel	

 omegapack

surgical sets

Surgical sets are medical devices personalized according to customer needs, dedicated to a selected medical procedure.





The sets are assembled on the basis of individual requirements and preferences of Customers

PROCEDURE SETS

Operating theatre is a specific environment where time is the most valuable factor influencing the success of the operation. It is a place where every minute - or even a second - counts, because it can affect the patient's life. To meet the expectations of medicine, ZARYS introduces operating sets to its offer that meet the highest standards, helping to improve the preparation of the operating theatre before the procedure

ADVANTAGES of using omegapack operating sets

 <p>TIME</p> <p>unpacking the set and preparing the operating theatre takes about 30% less time than selecting individual products and improving work at operating block</p>	 <p>QUALITY</p> <p>properly selected composition of the set according to individual needs for a specific medical procedure in line with the Customer's order</p>	
<p>REDUCING COST</p> 	 <p>EPIDEMIOLOGICAL SAFETY</p> <p>reduced risk of patient infection by minimizing the time of contact of medical staff with devices during the preparation of the theatre and the patient</p>	
 <p>EFFECTIVENESS</p> <p>increasing work productivity, so that you can perform more surgical procedures in one day, improvement of work of medical staff</p>	 <p>ENVIRONMENT</p> <p>the amount of generated waste is reduced to a minimum</p> <p>- one packaging</p>	 <p>SAVING THE STOCKS</p> <p>reduced number of supplies, saving space in the warehouse</p>
 <p>REDUCTION OF ERRORS</p> <p>the complete set contains all disposable medical devices necessary for the surgical operation, which eliminates the possibility of errors during the selection of individual products</p>	 <p>STANDARDIZATION OF PROCEDURES</p> <p>correct and schematic conduct during the procedure.</p> <p>one package - one treatment</p>  <p>EASY RECORD KEEPING</p> <p>optimization of record keeping - one self-adhesive label with the identification of the used set, instead of each used product separately</p>	 <p>WIDE RANGE OF PRODUCTS</p> <p>a wide range of medical devices selected individually in accordance with the Customer's preferences</p>



Medical devices under the omegapack brand by ZARYS are operating sets containing complete equipment with all disposable products necessary to perform a given medical procedure to which the set is dedicated. The operating set contains carefully selected disposable components, such as:

- surgical drapes, pads
- accessories, e.g. fluid collection bags, tapes
- surgical gowns
- surgical gloves
- covers for equipment
- shoe covers, masks, caps
- gauze balls
- gauze and non-woven swabs
- bandages, dressings
- catheters, urine collection bags
- trays, bowls
- taps, three-way stopcocks
- manifolds, connectors
- infusion sets
- suction sets
- disposable surgical instruments
- injection needles and syringes
- disposable electrosurgical electrodes and accessories
- and many more...



Personal protective equipments (PPE) are products that protect against one or more risks to the user's health or safety. These products must comply with Regulation (EU) 2016/425 of the European Parliament and of the Council. PPE is classified into three categories according to the degree of risk.

The coverall is a PPE category III in accordance with the Regulation (EU) 2016/425 of the European Parliament and of the Council



The category III covers products of complex construction, intended to protect health or life against risks that may cause death or irreversible damage to health.

Standards:



Coverall is personal protective equipment of category III in conformity with Regulation (EU) 2016/425 of the European Parliament and of the Council

EN ISO 13688:2013 Protective clothing. General requirements



EN 14605:2005+A1:2009 Protective clothing against liquid chemicals. Performance requirements for clothing with liquid-tight (Type 3) or spray-tight (Type 4) connections, including items providing protection to parts of the body only (Types PB [3] and PB [4])



EN ISO 13982-1:2004+A1:2010 Protective clothing for use against solid particulates. Part 1: Performance requirements for chemical protective clothing providing protection to the full body against airborne solid particulates (type 5 clothing)



EN 13034:2005+A1:2009 Protective clothing against liquid chemicals. Performance requirements for chemical protective clothing offering limited protective performance against liquid chemicals (Type 6 and Type PB [6] equipment)



EN 1073-2:2002 Protective clothing against radioactive contamination. Part 2: Requirements and test methods for non-ventilated protective clothing against particulate radioactive contamination



EN 14126:2003 + AC:2004 Protective clothing. Performance requirements and tests methods for protective clothing against infective agents

class 6 Resistance to penetration of contaminated liquids under the influence of hydrostatic pressure
class 6 Resistance to penetration by infective agents due to mechanical contact with substances
class 3 Resistance to penetration of contaminated liquid aerosols
class 3 Resistance to penetration of contaminated solid particles



EN 1149-5:2018 Protective clothing. Electrostatic properties. Part 5: Material performance and design requirements

EN 14325:2004 Protective clothing against chemicals. Test methods and performance classification of chemical protective clothing materials, seams, joins and assemblages

features:

- made of a laminate (non-woven polypropylene and polyethylene) with a weight of 63 g/m²
- polyester seams additionally covered with tape
- equipped with a hood with elastic trim
- equipped with an elastic waist band, wrists and ankles
- zipper covered with a self-adhesive flap
- available in version with boots



SIZE	86-94	94-102	102-110	110-118	118-129	129-141
cm						
158-166	S					
166-174		M				
174-182			L			
182-190				XL		
190-198					XXL	
198-206						XXXL

REF	size	version	packaging unit
BS-KCB02-S	S	without boots	1 pc.
BS-KCB02-M	M	without boots	1 pc.
BS-KCB02-L	L	without boots	1 pc.
BS-KCB02-XL	XL	without boots	1 pc.
BS-KCB02-XXL	XXL	without boots	1 pc.
BS-KCB02-XXXL	XXXL	without boots	1 pc.
BS-KCB02-B-S	S	with boots	1 pc.
BS-KCB02-B-M	M	with boots	1 pc.
BS-KCB02-B-L	L	with boots	1 pc.
BS-KCB02-B-XL	XL	with boots	1 pc.
BS-KCB02-B-XXL	XXL	with boots	1 pc.
BS-KCB02-B-XXXL	XXXL	with boots	1 pc.

Preventing infections in the operating field is a priority for all medicals. Thanks to our complex offer of single-use protective solutions of ALPHAtex STANDARD, STANDARD+, COMFORT, the post-procedural complications and risk of infection in the operating field are minimized while increasing the protection barrier against the potentially pathogenic germs residing in the human skin layers. We offer:

- patient and equipment drapes
- sets of surgical drapes
- incise films
- surgical covers
- adhesive tapes
- accessories such as fluid collection pouches
- surgical gowns

Properly selected features of surgical drapes provide safety and comfort of use to medical staff and patients. A variety of multi-layer non-woven and laminates reinforced in critical areas in lines STANDARD+ and COMFORT allow to adjust our solutions to particular surgical procedures with maximal cost efficiency.

ALPHAtex products are characterized by parameters frequently exceeding the requirements of EN 13795 for 'Surgical drapes, gowns and clean air suits, used as medical devices for patients, clinical staff and equipment'.

Moreover, they provide a successful protection against the risk of infection in the operating field. Practical solutions and composition of our sets enable their quick and simple application while performing medical procedures.

 ALPHAtex

surgical
**sets, drapes,
gowns**

surgical drapes | surgical covers and accessories
| surgical sets | surgical gowns



Prevention of surgical site infection



Surgical site infection (SSI)

is defined as infection occurring up to 30 days after surgery, when there is a possibility of microorganisms penetration into the open surgical wound. Microorganisms could have various sources EXOGENOUS (carried by an external factor as medical staff or medical devices) or ENDOGENOUS (patient's bacterial flora from the closest area surrounding the surgical postoperative wound). The most important routes of infections are airway or contact path. Various type of barriers are used to minimize the surgical site infections: surgical drapes, surgical gowns and medical equipment covers.



Surgical drapes

(the names are based on the EN 13795 standard)

Surgical drapes are used to ensure clean microbiological surgical wound surrounding, minimize the microorganisms migration from patient skin to surgical wound and to supervise the spreading of body fluids from the wound area. Surgical drapes meet the requirements of medical device in accordance with the Directive 93/42/EEC.

Surgical gowns

(the names are based on the EN 13795 standard)

Surgical gowns are used to prevent direct microorganisms transmission from medical staff to patient. Moreover, surgical gowns prevent spreading of exfoliated epidermis in the air of the operating room.

The wide range of ALPHAtex products is a result of over 30 years of ZARYS International Group existence on medical market. Sharing our experience and knowledge we are convinced that using ALPHAtex products will provide comfort, safety and economic effectiveness during daily work in the operating room.

Complex offer of ALPHAtex products contains:

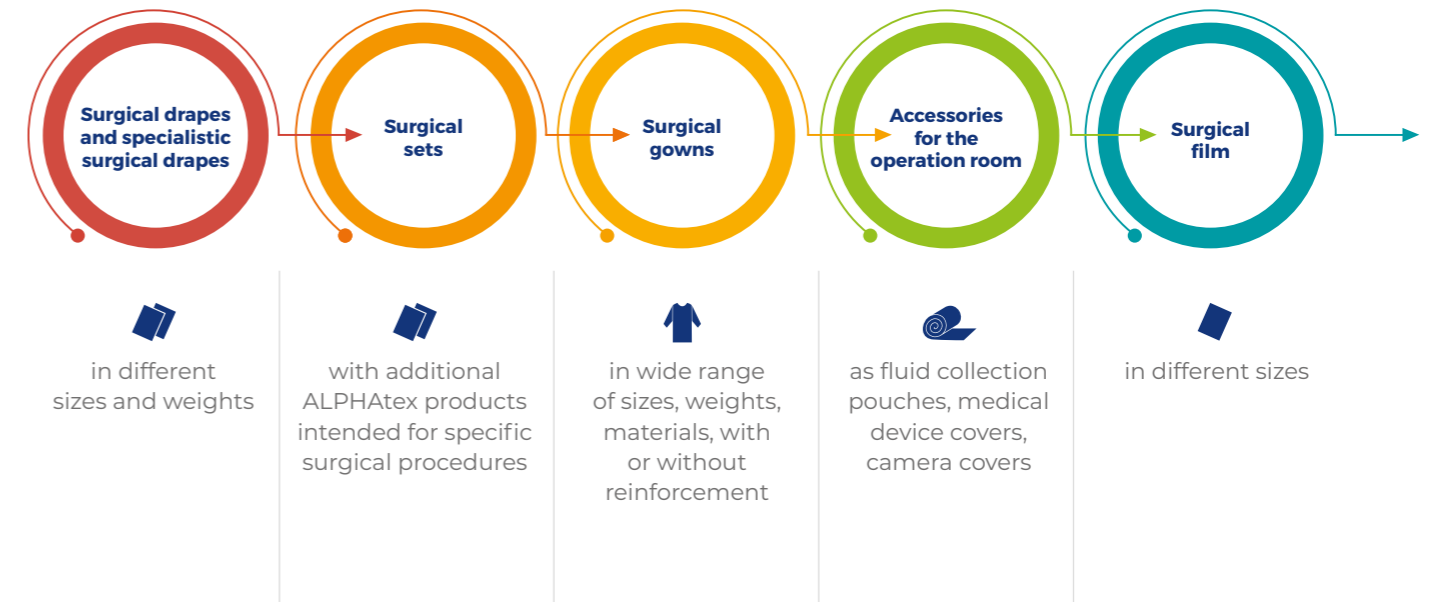

ZONES OF SURGICAL DRAPES ON PATIENT

on the operating room

ZONE 4

NOT HAVING ANY CONTACT WITH PATIENT'S BODY performs the function of anaesthetic cover and operating table cover

ZONE 2

DIRECT SURROUNDINGS OF OPERATING FIELD in this zone surgical drape has got contact with not disinfected patient's body

ZONE 3

PARTIAL CONTACT WITH NOT OPERATED PARTS OF PATIENT'S BODY occasionally exposed to body fluids

ZONE 1

OPERATING FIELD disinfected patient's skin in direct surroundings of surgical wound, mostly protected by incise film

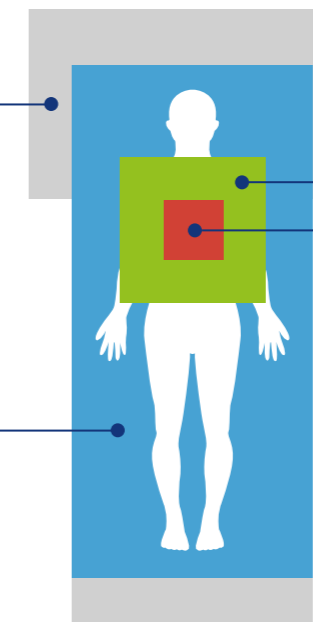

Surgical sets ALPHAtex

contains different disposable medical devices

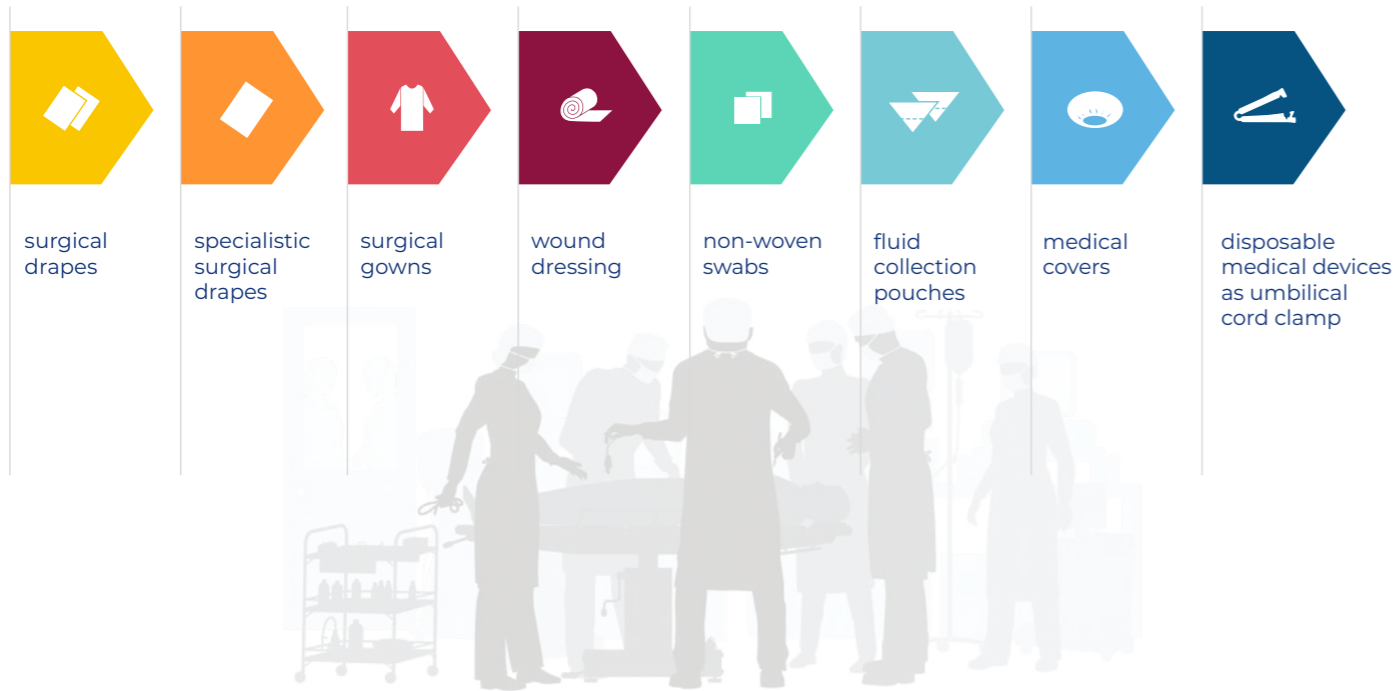

ALPHAtex label



TAG STICKER

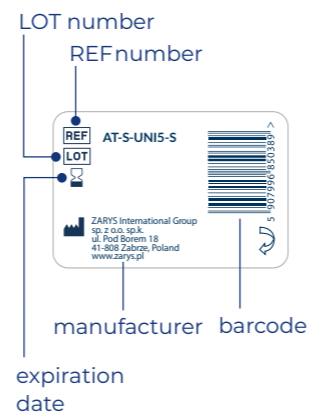









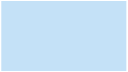



Features of disposable surgical drapes ALPHAtex used in the operating room



Materials legend:

detailed information and material structures available in **material template ALPHAtex**

	2-ply surgical drape with non-woven (PP+PE)		polypropylene
	table cover		neoprene
	SMS surgical drape		adhesive tape
	2-ply surgical drape with spunlace non-woven		PE foil
	Mayo stand cover red		PE foil blue
	Mayo stand cover blue		incise film
	reinforcement in the critical area		

> SURGICAL DRAPEs

CHARACTERISTICS	STANDARD	UNIT	REQUIREMENT			
			STANDARD REQUIREMENT		HIGH REQUIREMENT	
			CRITICAL PRODUCT AREA	LESS CRITICAL PRODUCT AREA	CRITICAL PRODUCT AREA	LESS CRITICAL PRODUCT AREA
microbial penetration - dry	EN ISO 22612	CFU	not required	≤ 300 ^a	not required	≤ 300 ^a
microbial penetration - wet	EN ISO 22610	I _B	≥ 2,8 ^b	not required	6,0 ^{bc}	not required
cleanliness - microbial bioburden	EN ISO 11737-1	CFU/100 cm ²	≤ 300	≤ 300	≤ 300	≤ 300
particulate release	EN ISO 9073-10	log ₁₀ (lint count)	≤ 4,0	≤ 4,0	≤ 4,0	≤ 4,0
liquid penetration	EN ISO 811	cm H ₂ O	≥ 30	≥ 10	≥ 100	≥ 10
bursting strength - dry	EN ISO 13938-1	kPa	≥ 40	≥ 40	≥ 40	≥ 40
bursting strength - wet	EN ISO 13938-1	kPa	≥ 40	not required	≥ 40	not required
tensile strength - dry	EN 29073-3	N	≥ 15	≥ 15	≥ 20	≥ 20
tensile strength - wet	EN 29073-3	N	≥ 15	not required	≥ 20	not required

STANDARDS GUIDE

> SURGICAL GOWNs

CHARACTERISTICS	STANDARD	UNIT	REQUIREMENT			
			STANDARD REQUIREMENT		HIGH REQUIREMENT	
			CRITICAL PRODUCT AREA	LESS CRITICAL PRODUCT AREA	CRITICAL PRODUCT AREA	LESS CRITICAL PRODUCT AREA
microbial penetration - dry	EN ISO 22612	CFU	not required	≤ 300 ^a	not required	≤ 300 ^a
microbial penetration - wet	EN ISO 22610	I _B	≥ 2,8 ^b	not required	6,0 ^{bc}	not required
cleanliness - microbial bioburden	EN ISO 11737-1	CFU/100 cm ²	≤ 300	≤ 300	≤ 300	≤ 300
particulate release	EN ISO 9073-10	log ₁₀ (lint count)	≤ 4,0	≤ 4,0	≤ 4,0	≤ 4,0
liquid penetration	EN ISO 811	cm H ₂ O	≥ 20	≥ 10	≥ 100	≥ 10
bursting strength - dry	EN ISO 13938-1	kPa	≥ 40	≥ 40	≥ 40	≥ 40
bursting strength - wet	EN ISO 13938-1	kPa	≥ 40	not required	≥ 40	not required
tensile strength - dry	EN 29073-3	N	≥ 20	≥ 20	≥ 20	≥ 20
tensile strength - wet	EN 29073-3	N	≥ 20	not required	≥ 20	not required

Standard EN 13795-1:2019

Essential requirements for surgical drapes and surgical gowns results from directive 93/42/EEC and have been included in EN 13795 standard "Surgical drapes, gowns and clean air suits, used as medical devices for patients, clinical staff and equipment". The purpose of EN 13795 standard is to maintain stable level of surgical drapes and surgical gowns safety for the whole using period as well as minimalization of direct microorganisms transmission from medical staff to patient during surgical procedures.



ZARYS



WWW.ZARYS.COM

BASIC TYPES OF MATERIALS USED IN SURGICAL DRAPES:

PF DRAPE - two layer material of the drape containing absorbency layer of cellulose on top and PE foil layer of the drape on back

NF, NFA, NFF, NFFA, NFFAR DRAPE - two layer material of the drape containing absorbency layer of non-woven material on top and PE foil layer on back of the drape

NFN, NFNA, NFNF, NFNFA DRAPE - three layer material on the drape containing absorbency non-woven layer on top, PE foil layer in the middle and non-woven absorbency layer on the back of the drape

SURGICAL DRAPES

SURGICAL DRAPES 2-LAYER DRAPES

STERILE DRAPES WITH CELLULOSE LAYER - 2-LAYERED

REF	dimensions	packaging unit	bulk packaging
AT-PF-S 1	50cm x 50cm	1 pc.	2 x 250 pcs
AT-PF-S 3	50cm x 70cm	1 pc.	2 x 200 pcs
AT-PF-S 5	80cm x 80cm	1 pc.	2 x 100 pcs
AT-PF-S 6	75cm x 90cm	1 pc.	2 x 100 pcs
AT-PF-S 8	90cm x 150cm	1 pc.	2 x 50 pcs

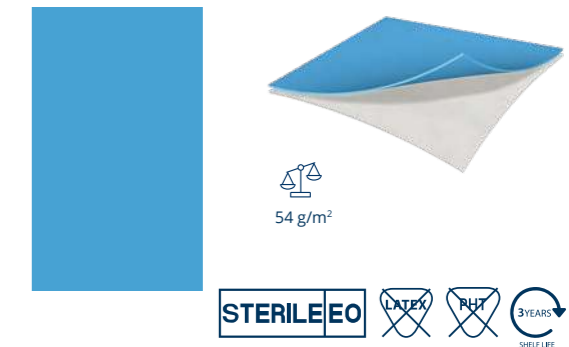

STERILE SURGICAL DRAPES - 2-LAYERED

REF	dimensions	packaging unit	bulk packaging
AT-NF-S 1 E	45cm x 45cm	100 pcs	4 x 100 pcs
AT-NF-S 3 E	45cm x 60cm	100 pcs	4 x 100 pcs
AT-NF-S 4 E	45cm x 75cm	100 pcs	4 x 100 pcs
AT-NF-S 5 E	75cm x 75cm	50 pcs	4 x 50 pcs
AT-NF-S 9 E	75cm x 90cm	50 pcs	4 x 50 pcs
AT-NF-S 13 E	100cm x 150cm	50 pcs	4 x 50 pcs
AT-NF-S 15 E	150cm x 180cm	20 pcs	4 x 20 pcs
AT-NF-S 21 E	37cm x 45cm	100 pcs	4 x 100 pcs

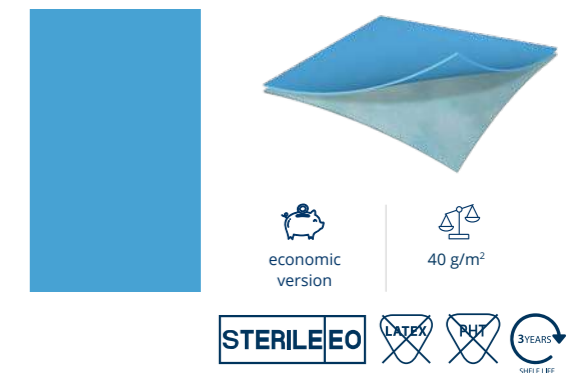

STERILE SURGICAL DRAPES - 2-LAYERED

REF	dimensions	packaging unit	bulk packaging
AT-NF-S 1	45cm x 45cm	1 pc.	2 x 240 pcs
AT-NF-S 2	50cm x 50cm	1 pc.	2 x 200 pcs
AT-NF-S 3	50cm x 60cm	1 pc.	2 x 280 pcs
AT-NF-S 4	50cm x 75cm	1 pc.	2 x 160 pcs
AT-NF-S 5	75cm x 75cm	1 pc.	2 x 150 pcs
AT-NF-S 8	80cm x 90cm	1 pc.	2 x 150 pcs
AT-NF-S 9	75cm x 90cm	1 pc.	2 x 150 pcs
AT-NF-S 10	90cm x 120cm	1 pc.	2 x 80 pcs
AT-NF-S 12	75cm x 140cm	1 pc.	2 x 50 pcs
AT-NF-S 13	100cm x 150cm	1 pc.	2 x 50 pcs
AT-NF-S 14	120cm x 150cm	1 pc.	2 x 50 pcs
AT-NF-S 15	150cm x 180cm	1 pc.	2 x 20 pcs
AT-NF-S 16	150cm x 200cm	1 pc.	2 x 20 pcs
AT-NF-S 19	160cm x 220cm	1 pc.	2 x 20 pcs
AT-NF-S 20	150cm x 240cm	1 pc.	2 x 20 pcs
AT-NF-S 22	170cm x 300cm	1 pc.	2 x 20 pcs

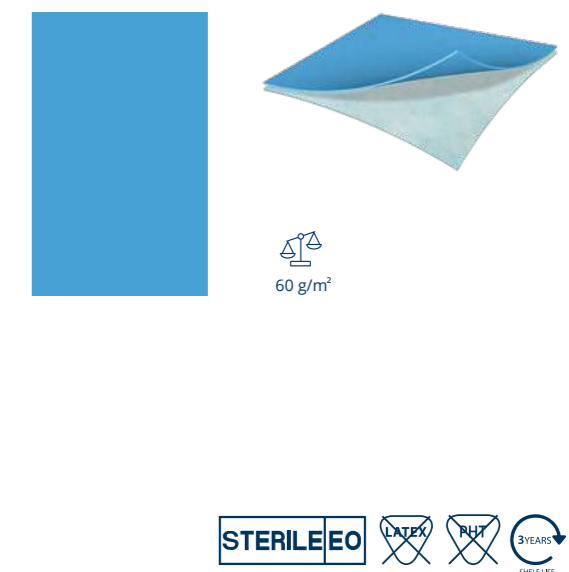

STERILE SURGICAL DRAPES WITH ADHESIVE EDGE - 2-LAYERED

REF	dimensions	packaging unit	bulk packaging
AT-NFA-S 4 E	45cm x 75cm	100 pcs	4 x 100 pcs
AT-NFA-S 9 E	75cm x 90cm	50 pcs	4 x 50 pcs
AT-NFA-S 10 E	90cm x 120cm	50 pcs	4 x 50 pcs
AT-NFA-S 13 E	100cm x 150cm	50 pcs	4 x 50 pcs
AT-NFA-S 15 E	150cm x 180cm	20 pcs	4 x 20 pcs
AT-NFA-S 16 E	150cm x 200cm	20 pcs	4 x 20 pcs
AT-NFA-S 20 E	150cm x 240cm	20 pcs	4 x 20 pcs

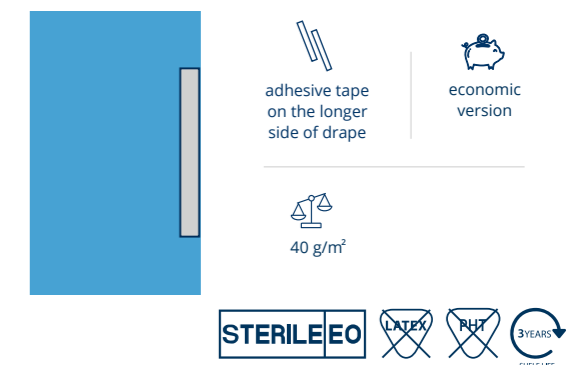

STERILE SURGICAL DRAPES WITH ADHESIVE EDGE - 2-LAYERED

REF	dimensions	packaging unit	 bulk packaging
AT-NFA-S 1	45cm x 45cm	1 pc.	2 x 230 pcs
AT-NFA-S 3	50cm x 60cm	1 pc.	2 x 100 pcs
AT-NFA-S 4	50cm x 75cm	1 pc.	2 x 210 pcs
AT-NFA-S 5	75cm x 75cm	1 pc.	2 x 135 pcs
AT-NFA-S 9	75cm x 90cm	1 pc.	2 x 125 pcs
AT-NFA-S 10	90cm x 120cm	1 pc.	2 x 80 pcs
AT-NFA-S 13	100cm x 150cm	1 pc.	2 x 50 pcs
AT-NFA-S 15	150cm x 180cm	1 pc.	2 x 20 pcs
AT-NFA-S 16	150cm x 200cm	1 pc.	2 x 20 pcs
AT-NFA-S 20	150cm x 240cm	1 pc.	2 x 20 pcs
AT-NFA-S 22	170cm x 300cm	1 pc.	2 x 20 pcs

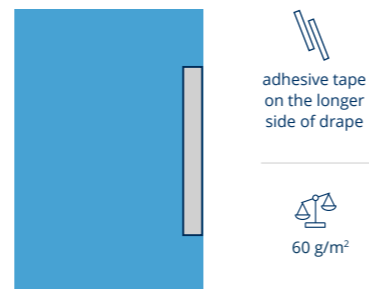

STERILE SURGICAL DRAPES WITH CENTRAL FENESTRATION - 2-LAYERED

REF	dimensions	fenestration	packaging unit	 bulk packaging
AT-NFF-S 2 E	45cm x 75cm	6cm x 8cm	100 pcs	4 x 100 pcs
AT-NFF-S 3 E	45cm x 60cm	ø 6cm	100 pcs	4 x 100 pcs
AT-NFF-S 4 E	75cm x 90cm	ø 7cm	50 pcs	4 x 50 pcs
AT-NFF-S 5 E	75cm x 90cm	6cm x 8cm	50 pcs	4 x 50 pcs

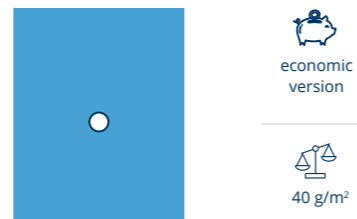

STERILE SURGICAL DRAPES WITH CENTRAL FENESTRATION - 2-LAYERED

REF	dimensions	fenestration	packaging unit	 bulk packaging
AT-NFF-S 1	45cm x 45cm	ø 6cm	1 pc.	2 x 200 pcs
AT-NFF-S 2	50cm x 75cm	6cm x 8cm	1 pc.	2 x 120 pcs
AT-NFF-S 3	50cm x 75cm	ø 7cm	1 pc.	2 x 120 pcs
AT-NFF-S 4	75cm x 90cm	ø 7cm	1 pc.	2 x 120 pcs
AT-NFF-S 5	75cm x 90cm	6cm x 8cm	1 pc.	2 x 120 pcs
AT-NFF-S 21	50cm x 60cm	ø 7cm	1 pc.	2 x 300 pcs

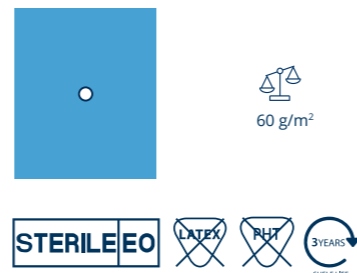

STERILE SURGICAL DRAPES WITH ADHESIVE CENTRAL FENESTRATION - 2-LAYERED

REF	dimensions	fenestration	packaging unit	 bulk packaging
AT-NFFA-S 1 E	45cm x 45cm	ø 5cm	100 pcs	4 x 100 pcs
AT-NFFA-S 2 E	45cm x 75cm	6cm x 8cm	100 pcs	4 x 100 pcs
AT-NFFA-S 3 E	50cm x 60cm	ø 6cm	100 pcs	4 x 100 pcs
AT-NFFA-S 4 E	75cm x 90cm	ø 7cm	50 pcs	4 x 50 pcs
AT-NFFA-S 5 E	75cm x 90cm	6cm x 8cm	50 pcs	4 x 50 pcs
AT-NFFA-S 6 E	90cm x 120cm	ø 8cm	50 pcs	4 x 50 pcs



STERILE SURGICAL DRAPES WITH ADHESIVE CENTRAL FENESTRATION - 2-LAYERED

REF	dimensions	fenestration	packaging unit	 bulk packaging
AT-NFFA-S 1	45cm x 45cm	ø 6cm	1 pc.	2 x 200 pcs
AT-NFFA-S 2	50cm x 75cm	6cm x 8cm	1 pc.	2 x 120 pcs
AT-NFFA-S 3	50cm x 75cm	ø 7cm	1 pc.	2 x 120 pcs
AT-NFFA-S 4	75cm x 90cm	ø 7cm	1 pc.	2 x 100 pcs
AT-NFFA-S 5	75cm x 90cm	6cm x 8cm	1 pc.	2 x 100 pcs
AT-NFFA-S 6	90cm x 120cm	ø 10cm	1 pc.	2 x 60 pcs
AT-NFFA-S 7	120cm x 150cm	ø 7cm	1 pc.	2 x 50 pcs
AT-NFFA-S 8	120cm x 150cm	ø 10cm	1 pc.	2 x 50 pcs
AT-NFFA-S 11	50cm x 60cm	6cm x 8cm	1 pc.	2 x 200 pcs

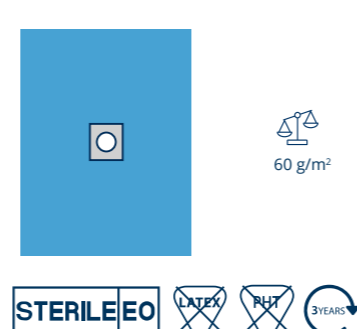

STERILE SURGICAL DRAPES WITH ADHESIVE CENTRAL ADJUSTABLE FENESTRATION - 2-LAYERED

REF	dimensions	fenestration	packaging unit	 bulk packaging
AT-NFFAR-S 2 E	45cm x 75cm	6cm x 8cm	100 pcs	4 x 100 pcs
AT-NFFAR-S 4 E	75cm x 90cm	ø 7cm	50 pcs	4 x 50 pcs



STERILE SURGICAL DRAPES WITH ADHESIVE CENTRAL ADJUSTABLE FENESTRATION - 2-LAYERED

REF	dimensions	fenestration	packaging unit	 bulk packaging
AT-NFFAR-S 2	45cm x 75cm	6cm x 8cm	1 pc.	2 x 150 pcs
AT-NFFAR-S 4	75cm x 90cm	ø 7cm	1 pc.	2 x 90 pcs

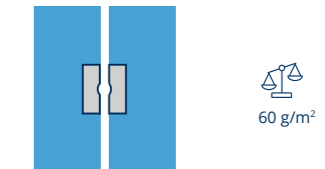

STERILE ADHESIVE EPIDURAL DRAPES - 2-LAYERED

REF	dimensions	fenestration	packaging unit	 bulk packaging
AT-NFZRS-S 1	75cm x 80cm	6cm x 15cm	1 pc.	2x60 pcs
AT-NFZRS-S 2	60cm x 75cm	6cm x 9,5cm	1 pc.	2x120 pcs
AT-NFZRS-S 11	75cm x 90cm	10cm x 15cm	1 pc.	2x60 pcs

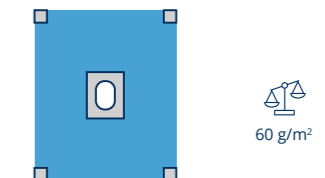

indication: epidural anesthesia

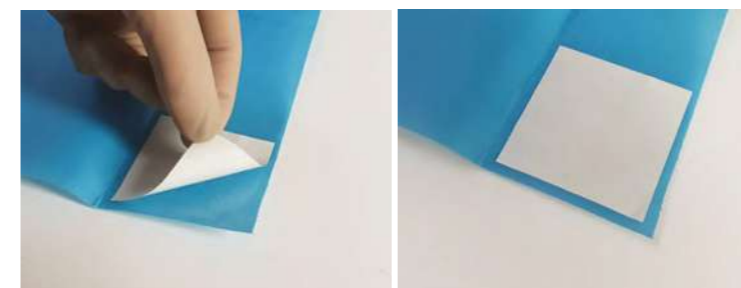

adhesive tape in the corners of drape

STERILE INSTRUMENT TABLE COVERS

REF	dimensions	packaging unit	 bulk packaging
AT-SD-S 3	100cm x 150cm	1 pc.	100 pcs
AT-SD-S 4	150cm x 190cm	1 pc.	60 pcs
AT-SD-S 5	150cm x 260cm	1 pc.	50 pcs

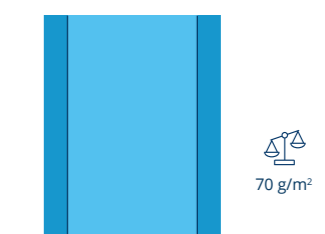

SURGICAL DRAPES
3-LAYER DRAPES

STERILE SURGICAL DRAPES - 3-LAYERED

REF	dimensions	packaging unit	bulk packaging
AT-NFN-S 1	45cm x 45cm	1 pc.	300 pcs
AT-NFN-S 2	50cm x 50cm	1 pc.	300 pcs
AT-NFN-S 3	50cm x 60cm	1 pc.	150 pcs
AT-NFN-S 4	50cm x 70cm	1 pc.	160 pcs
AT-NFN-S 5	75cm x 75cm	1 pc.	100 pcs
NEW AT-NFN-S 8	80cm x 90cm	1 pc.	80 pcs
AT-NFN-S 9	75cm x 90cm	1 pc.	80 pcs
AT-NFN-S 10	90cm x 120cm	1 pc.	75 pcs
AT-NFN-S 13	100cm x 150cm	1 pc.	50 pcs
NEW AT-NFN-S 14	120cm x 150cm	1 pc.	50 pcs
AT-NFN-S 15	150cm x 180cm	1 pc.	50 pcs
AT-NFN-S 16	150cm x 210cm	1 pc.	25 pcs
NEW AT-NFN-S 19	160cm x 220cm	1 pc.	25 pcs
AT-NFN-S 20	150cm x 240cm	1 pc.	25 pcs

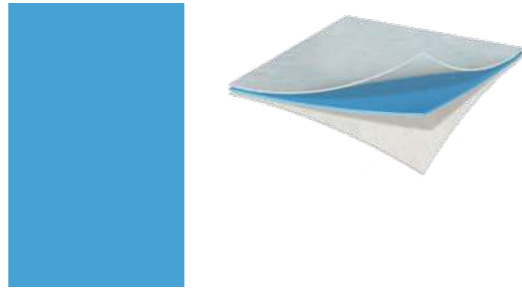

STERILE SURGICAL DRAPES WITH ADHESIVE CENTRAL FENESTRATION - 3-LAYERED

REF	dimensions	fenestration	packaging unit	bulk packaging
AT-NFNFA-S 2	50cm x 70cm	6cm x 8cm	1 pc.	200 pcs
AT-NFNFA-S 3	50cm x 75cm	ø 7cm	1 pc.	100 pcs
AT-NFNFA-S 4	75cm x 90cm	ø 7cm	1 pc.	100 pcs
AT-NFNFA-S 5	75cm x 90cm	6cm x 8cm	1 pc.	100 pcs
AT-NFNFA-S 6	90cm x 120cm	ø 10cm	1 pc.	63 pcs

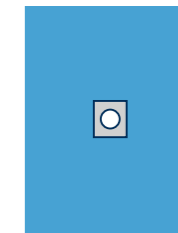

STERILE SURGICAL DRAPES WITH ADHESIVE FENESTRATION, REINFORCED

REF	dimensions	fenestration	packaging unit	bulk packaging
AT-NFZRF-S 1	120cm x 170cm	ø 12cm	1 pc.	50 pcs
AT-NFZRF-S 2	200cm x 280cm	ø 10cm	1 pc.	20 pcs
AT-NFZRF-S 3	200cm x 320cm	ø 15cm	1 pc.	20 pcs

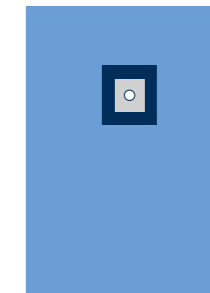
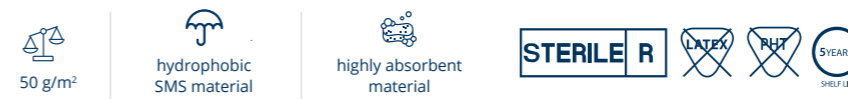

STERILE SURGICAL DRAPES WITH ADHESIVE EDGE - 3-LAYERED

REF	dimensions	packaging unit	bulk packaging
AT-NFNA-S 2	50cm x 50cm	1 pc.	256 pcs
AT-NFNA-S 4	50cm x 70cm	1 pc.	160 pcs
AT-NFNA-S 5	75cm x 75cm	1 pc.	100 pcs
NEW AT-NFNA-S 8	80cm x 90cm	1 pc.	80 pcs
AT-NFNA-S 9	75cm x 90cm	1 pc.	90 pcs
AT-NFNA-S 13	100cm x 150cm	1 pc.	80 pcs
AT-NFNA-S 15	150cm x 180cm	1 pc.	25 pcs
AT-NFNA-S 16	150cm x 210cm	1 pc.	50 pcs
NEW AT-NFNA-S 19	160cm x 220cm	1 pc.	25 pcs
AT-NFNA-S 20	150cm x 240cm	1 pc.	25 pcs



STERILE SURGICAL DRAPES WITH CENTRAL FENESTRATION - 3-LAYERED

REF	dimensions	fenestration	packaging unit	bulk packaging
AT-NFNF-S 1	45cm x 45cm	ø 6cm	1 pc.	300 pcs
AT-NFNF-S 2	50cm x 75cm	6cm x 8cm	1 pc.	160 pcs
AT-NFNF-S 3	50cm x 75cm	ø 7cm	1 pc.	200 pcs
AT-NFNF-S 4	75cm x 90cm	ø 7cm	1 pc.	80 pcs
AT-NFNF-S 5	75cm x 90cm	6cm x 8cm	1 pc.	80 pcs
AT-NFNF-S 6	90cm x 120cm	ø 10cm	1 pc.	100 pcs

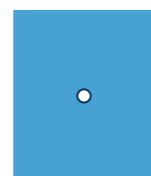

SURGICAL DRAPES
SPECIALISTIC DRAPES

GENERAL SURGERY

AT-SD-ABD1-IF-C ABDOMINAL DRAPE 1-IF

REF	dimensions	quantity	component
AT-SD-ABD1-IF-C	200cm x 320cm	1 pc.	drape with adhesive fenestration 25cm x 30cm filled with an incise film, reinforced
AT-SD-S 4	150cm x 190cm	1 pc.	instrument table cover, reinforced

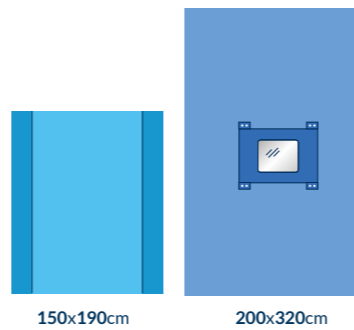

AT-SD-ABPER1-S ABDO-PERINEAL DRAPE 1

REF	dimensions	quantity	component
AT-SD-ABPER1-S	180/280cm x 220cm	1 pc.	drape integrated with limb covers, adhesive trapezium-shaped fenestration 30cm x 20cm x 20cm and perineal fenestration 10cm x 15cm with covering flap
AT-SD-S 4	150cm x 190cm	1 pc.	instrument table cover, reinforced

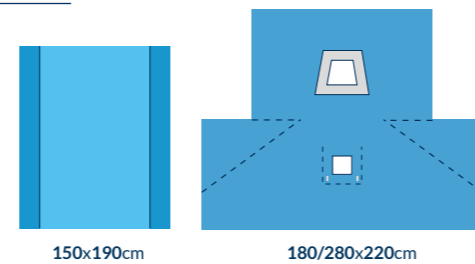

AT-SD-LAP3-SP LAPAROSCOPY DRAPE 3

REF	dimensions	quantity	component
AT-SD-LAP3-SP	200/270cm x 300cm	1 pc.	drape integrated with limb covers, adhesive fenestration 25cm x 30cm, reinforced, with 8 cable holders Velcro type
AT-SD-S 4	150cm x 190cm	1 pc.	instrument table cover, reinforced

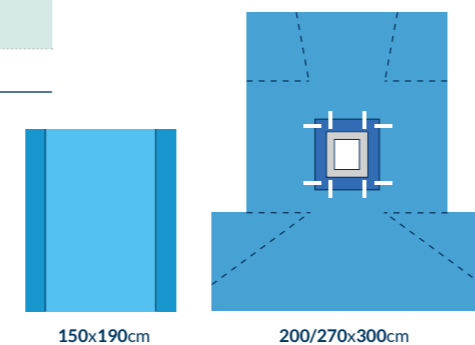

ORTHOPEDICS AND TRAUMATOLOGY

AT-SD-ORT1-SP ORTHOPAEDIC DRAPE 1

REF	dimensions	quantity	component
AT-SD-ORT1-SP	150cm x 250cm	1 pc.	drape with adhesive U-split 7cm x 70cm, reinforced
AT-SD-S 4	150cm x 190cm	1 pc.	instrument table cover, reinforced

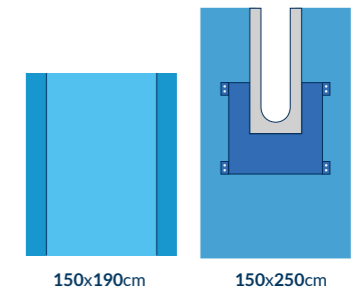

AT-SD-ORT2-SP ORTHOPAEDIC DRAPE 2

REF	dimensions	quantity	component
AT-SD-ORT2-SP	230cm x 260cm	1 pc.	drape with adhesive U-split 20cm x 100cm, reinforced
AT-SD-S 4	150cm x 190cm	1 pc.	instrument table cover, reinforced

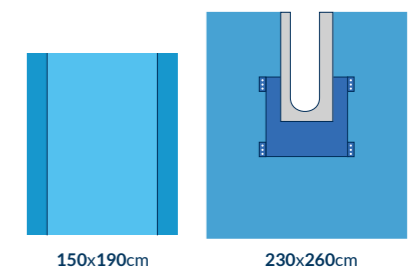

AT-SD-ORT3-C ORTHOPAEDIC DRAPE 3

REF	dimensions	quantity	component
AT-SD-ORT3-C	150cm x 200cm	1 pc.	drape with adhesive U-split 6cm x 65cm, reinforced
AT-SD-S 4	150cm x 190cm	1 pc.	instrument table cover, reinforced

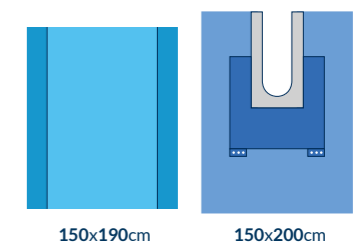

AT-SD-ORT4-C ORTHOPAEDIC DRAPE 4

REF	dimensions	quantity	component
AT-SD-ORT4-C	200cm x 260cm	1 pc.	drape with adhesive U-split 8.5cm x 85cm, reinforced
AT-SD-S 4	150cm x 190cm	1 pc.	instrument table cover, reinforced

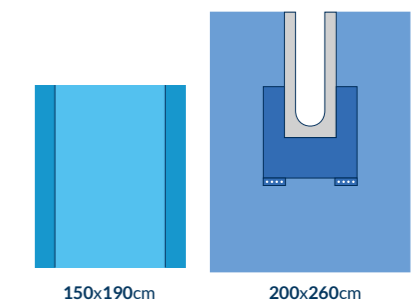

AT-SD-EXT1-SP EXTREMITY DRAPE 1



REF	dimensions	quantity	component
AT-SD-EXT1-SP	150cm x 180cm	1 pc.	drape with elastic fenestration ø 3,5cm, reinforced
AT-SD-S 4	150cm x 190cm	1 pc.	instrument table cover, reinforced

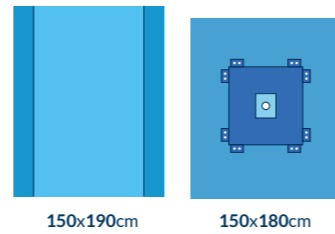

bulk packaging: 24 pcs

STERILE R

AT-SD-EXT5-C EXTREMITY DRAPE 5



REF	dimensions	quantity	component
AT-SD-EXT5-C	200cm x 300cm	1 pc.	drape with elastic fenestration ø 3,5cm, reinforced
AT-SD-S 4	150cm x 190cm	1 pc.	instrument table cover, reinforced

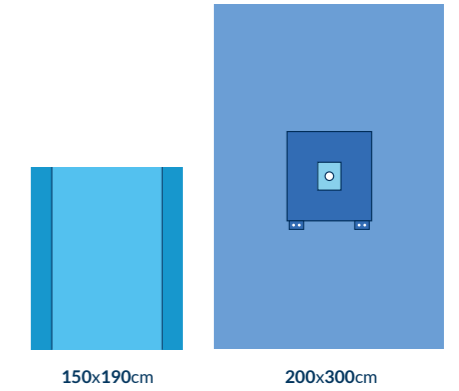

bulk packaging: 20 pcs

STERILE R

AT-SD-EXT2-SP EXTREMITY DRAPE 2



REF	dimensions	quantity	component
AT-SD-EXT2-SP	230cm x 300cm	1 pc.	drape with elastic fenestration ø 3,5cm, reinforced
AT-SD-S 4	150cm x 190cm	1 pc.	instrument table cover, reinforced

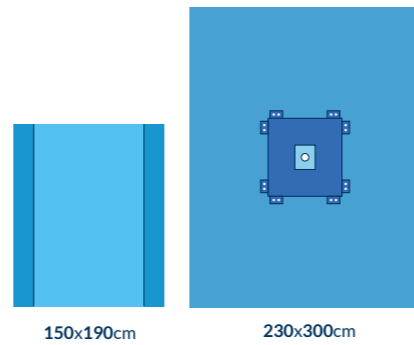

bulk packaging: 18 pcs

STERILE R

GYNAECOLOGY AND UROLOGY



AT-SD-GYN1-S GYNAECOLOGY DRAPE 1



REF	dimensions	quantity	component
AT-SD-GYN1-S	160/240cm x 180cm	1 pc.	drape integrated with limb covers, adhesive perineal fenestration 10cm x 15cm
AT-SD-S 4	150cm x 190cm	1 pc.	instrument table cover, reinforced

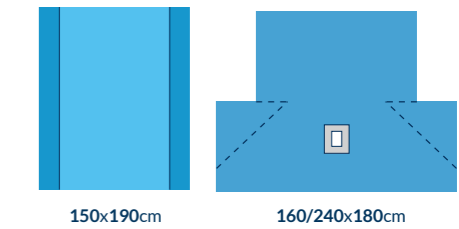

bulk packaging: 16 pcs

STERILE R

AT-SD-EXT3-SP EXTREMITY DRAPE 3



REF	dimensions	quantity	component
AT-SD-EXT3-SP	230cm x 300cm	1 pc.	drape with elastic fenestration ø 7cm, reinforced
AT-SD-S 4	150cm x 190cm	1 pc.	instrument table cover, reinforced

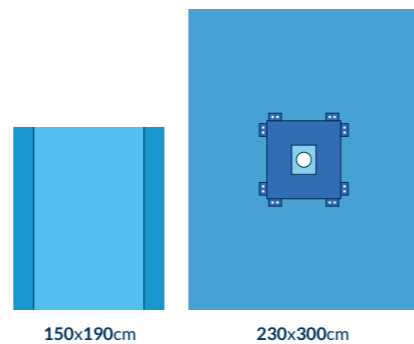

bulk packaging: 18 pcs

STERILE R

AT-SD-GYN2-S GYNAECOLOGY DRAPE 2



REF	dimensions	quantity	component
AT-SD-GYN2-S	160/240cm x 180cm	1 pc.	drape integrated with limb covers, adhesive perineal fenestration 10cm x 15cm, integrated fluid collection pouch 35cm x 50cm with formable mold, filter and tubing port
AT-SD-S 4	150cm x 190cm	1 pc.	instrument table cover, reinforced

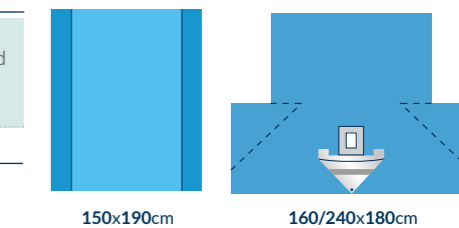

bulk packaging: 8 pcs

STERILE R

AT-SD-EXT4-C EXTREMITY DRAPE 4



REF	dimensions	quantity	component
AT-SD-EXT4-C	200cm x 320cm	1 pc.	drape with elastic fenestration 6cm x 8cm, reinforced
AT-SD-S 4	150cm x 190cm	1 pc.	instrument table cover, reinforced

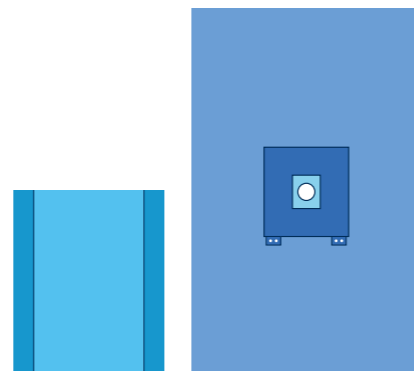

bulk packaging: 15 pcs

STERILE R

AT-SD-DEL1-SP DELIVERY DRAPE 1



REF	dimensions	quantity	component
AT-SD-DEL1-SP	114cm x 150cm	1 pc.	delivery drape integrated with fluid collection pouch 78cm x 80cm with formable mold, filter and tubing port, reinforced

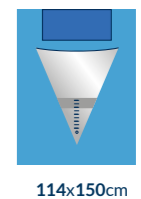

bulk packaging: 45 pcs

without instrument table cover wrapping

STERILE R



OPHTHALMOLOGY



AT-SD-OPHT1-IF-S OPTHALMIC DRAPE 1-IF

REF	dimensions	quantity	component
AT-SD-OPHT1-IF-S	100cm x 100cm	1 pc.	ophthalmic drape with fenestration 10cm x 10cm filled with an incise film
AT-SD-S 3	100cm x 150cm	1 pc.	instrument table cover, reinforced

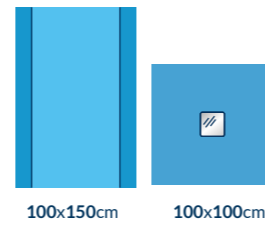

AT-SD-OPHT2-IF-C OPTHALMIC DRAPE 2-IF

REF	dimensions	quantity	component
AT-SD-OPHT2-IF-C	100cm x 100cm	1 pc.	ophthalmic drape with fenestration 10cm x 10cm filled with an incise film, integrated with fluid collection pouch and with 2 formable molders, reinforced
AT-SD-S 3	100cm x 150cm	1 pc.	instrument table cover, reinforced

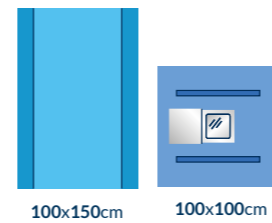

AT-SD-OPHT3-IF-C OPTHALMIC DRAPE 3-IF

REF	dimensions	quantity	component
AT-SD-OPHT3-IF-C	120cm x 170cm	1 pc.	ophthalmic drape with fenestration 10cm x 10cm filled with an incise film, integrated with 2 fluid collection pouches and with 1 formable molder, reinforced
AT-SD-S 3	100cm x 150cm	1 pc.	instrument table cover, reinforced

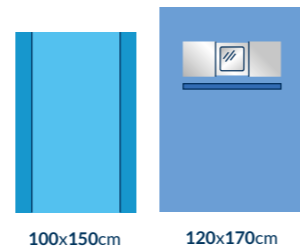

formable molder to fit the patient's face



AT-SD-OPHT4-IF-C OPTHALMIC DRAPE 4-IF

REF	dimensions	quantity	component
AT-SD-OPHT4-IF-C	140cm x 240cm	1 pc.	reinforced ophthalmic drape with a fenestration of 10cm x 10cm filled with an incise film, integrated with 2 fluid collection pouches and 1 formable molder
AT-SD-S 4	150cm x 190cm	1 pc.	instrument table cover, reinforced

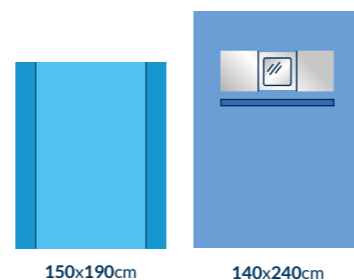

ZARYS



WWW.ZARYS.COM

SURGICAL COVERS, ACCESSORIES

STERILE MAYO STAND COVER, REINFORCED - RED  **BESTSELLER**

REF	dimensions	packaging unit	bulk packaging
AT-SD-S 1 RED	80cm x 145cm	1 pc.	80 pcs
AT-SD-S 2 RED	80cm x 140cm	1 pc.	80 pcs



STERILE SET OF LIMB COVERS

REF	dimensions	packaging unit	bulk packaging
AT-SD-S 9	70cm x 120cm	2 pcs	20 pcs

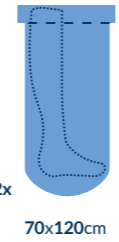

STERILE LIMB COVERS

REF	dimensions	packaging unit	bulk packaging
AT-SD-S 6	30cm x 60cm	1 pc. + OP tape 10cm x 50cm	200 pcs
AT-SD-S 7	30cm x 80cm	1 pc. + OP tape 10cm x 50cm	120 pcs
AT-SD-S 8	35cm x 120cm	1 pc. + OP tape 10cm x 50cm	100 pcs

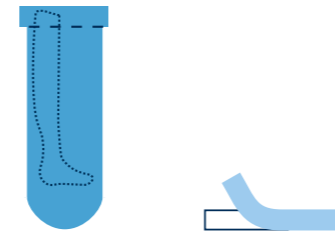

STERILE CAMERA CABLE COVERS - PERFORATED, WITH 2 ADHESIVE TAPES  **BESTSELLER**

REF	dimensions	packaging unit	bulk packaging
AT-SP-S 3	14cm x 250cm	1 pc.	160 pcs
AT-SP-S 4	16cm x 200cm	1 pc.	200 pcs
AT-SP-S 5	16cm x 250cm	1 pc.	160 pcs
AT-SP-S 6	16cm x 300cm	1 pc.	200 pcs



sterile camera cover

STERILE CAMERA CABLE COVER - UNPERFORATED, WITH AN ADHESIVE TAPE

REF	dimensions	packaging unit	bulk packaging
AT-SP-S 7	7cm x 120cm	1 pc.	200 pcs
AT-SP-S 8	7cm x 170cm	1 pc.	200 pcs



STERILE CIRCULAR BANDED COVERS FOR MEDICAL DEVICES

REF	dimensions in stretched state	maximum size of covered device	packaging unit	bulk packaging
AT-SP-S 9	65cm x 85cm	35cm x 45cm	1 pc.	200 pcs
AT-SP-S 10	85cm x 85cm	50cm x 50cm	1 pc.	100 pcs
AT-SP-S 11	105cm x 105cm	60cm x 60cm	1 pc.	100 pcs
AT-SP-S 12	120cm x 120cm	70cm x 70cm	1 pc.	100 pcs
AT-SP-S 13	140cm x 140cm	80cm x 80cm	1 pc.	50 pcs

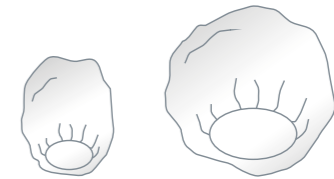

STERILE RECTANGULAR BANDED COVERS FOR MEDICAL DEVICES

REF	dimensions	packaging unit	bulk packaging
AT-SP-S 14	70cm x 80cm	1 pc.	100 pcs
AT-SP-S 15	90cm x 100cm	1 pc.	50 pcs
AT-SP-S 16	80cm x 150cm	1 pc.	50 pcs

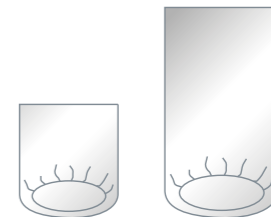

STERILE C-ARM COVER SET

REF	dimensions	packaging unit	bulk packaging
AT-SP-S 17	100cm x 160cm 80cm x 150cm 3cm x 100cm	1 set	32 pcs

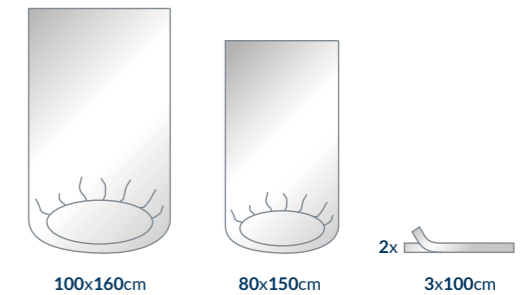

STERILE ARMBOARD COVER SET

REF	dimensions	packaging unit	bulk packaging
AT-AC	35cm x 75cm	2 pcs	80 pcs

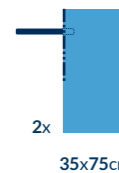

STERILE SURGICAL TAPES

REF	dimensions	description	packaging unit	bulk packaging
AT-SP-S 1	10cm x 50cm	surgical tape, OP tape	1 pc.	1100 pcs
AT-SP-S 2	2cm x 22cm	surgical tape, Velcro type	1 pc.	100 pcs

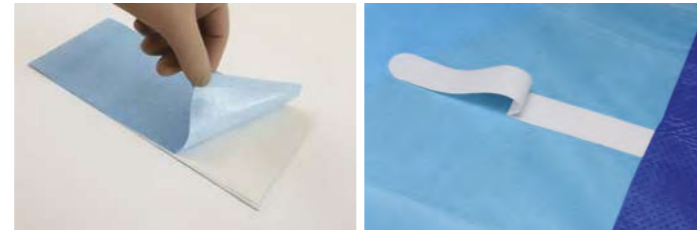
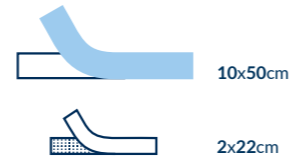

OP tape

Velcro surgical tape

STERILE ADHESIVE POUCHES

REF	dimensions	description	packaging unit	bulk packaging
AT-SP-S 20	30cm x 40cm	adhesive pouch, one-chamber	1 pc.	180 pcs
AT-SP-S 21	50cm x 60cm	adhesive pouch, one-chamber	1 pc.	180 pcs
AT-SP-S 22	40cm x 30cm	adhesive pouch, two-chamber 15cm x 30cm left chamber 25cm x 30cm right chamber	1 pc.	250 pcs

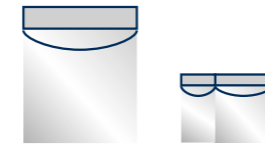

STERILE ADHESIVE FLUID COLLECTION POUCH

REF	dimensions	packaging unit	description	bulk packaging
AT-SP-S 18	60cm x 100cm	1 pc.	arthroscopy cone-shaped pouch with self-sealing fenestration and suction port	36 pcs
AT-SP-S 19	50cm x 50cm	1 pc.	cone-shaped pouch with filter and tubing port	65 pcs

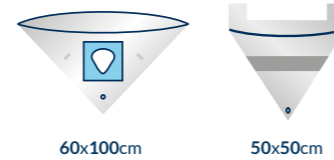

STERILE ABSORBENT DRAPE

REF	dimensions	packaging unit	bulk packaging
AT-HT	40cm x 40cm	1 pc.	500 pcs



40x40cm



STERILE ABSORBENT DRAPE

REF	dimensions	packaging unit	bulk packaging
AT-BT	75cm x 80cm	1 pc.	80 pcs

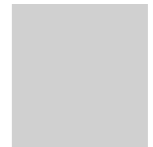

75x80cm



STERILE INCISE FILM ELASTOFILM

REF	total dimensions	adhesive filed dimensions	packaging unit	bulk packaging
808068	84cm x 56cm	84cm x 50cm	1 pc.	6 pcs
808066	40cm x 42cm	40cm x 36cm	1 pc.	20 pcs
808065	45cm x 55cm	45cm x 49cm	1 pc.	20 pcs
808064	45cm x 28cm	45cm x 22cm	1 pc.	20 pcs
808063	30cm x 28cm	30cm x 22cm	1 pc.	20 pcs
808062	15cm x 28cm	15cm x 22cm	1 pc.	40 pcs
808061	14cm x 25cm	14cm x 21cm	1 pc.	40 pcs
805018	55cm x 55cm	55cm x 51cm	1 pc.	20 pcs
805025	30cm x 40cm	30cm x 36cm	1 pc.	20 pcs
805016	20cm x 30cm	20cm x 26cm	1 pc.	30 pcs

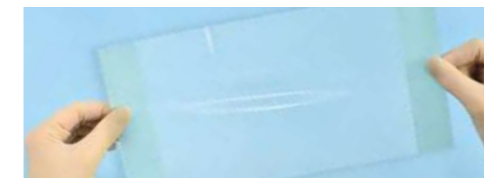

- thin incise film made of polyurethane
- flexible
- perfectly fits the patient's body
- double packed: externally paper-foil, internally paper

ZARYS



WWW.ZARYS.COM

SURGICAL SETS

UNIVERSAL SETS

AT-S-BASIC1-S BASIC SET 1

quantity	dimensions	component
1 pc.	75cm x 90cm	drape with central adhesive fenestration
1 pc.	10cm x 17cm	tray
10 pcs	10cm x 10cm	gauze swab
5 pcs	30cm x 30cm	gauze ball
1 pc.	100cm x 150cm	instrument table cover, reinforced

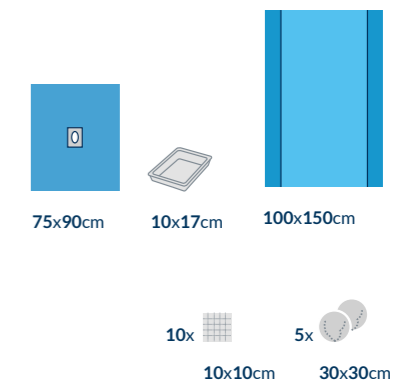

AT-S-UNI1-S UNIVERSAL SET 1

quantity	dimensions	component
4 pcs	75cm x 90cm	drape with adhesive edge
1 pc.	150cm x 190cm	instrument table cover, reinforced

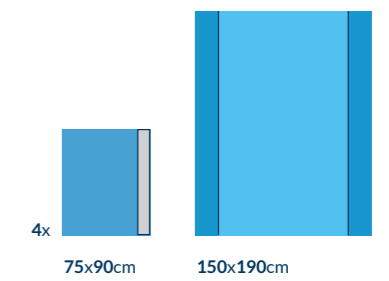

AT-S-UNI2-S UNIVERSAL SET 2

quantity	dimensions	component
2 pcs	150cm x 180cm	drape with adhesive edge
2 pcs	75cm x 90cm	drape with adhesive edge
4 pcs	30cm x 30cm	absorbent towel
1 pc.	150cm x 190cm	instrument table cover, reinforced

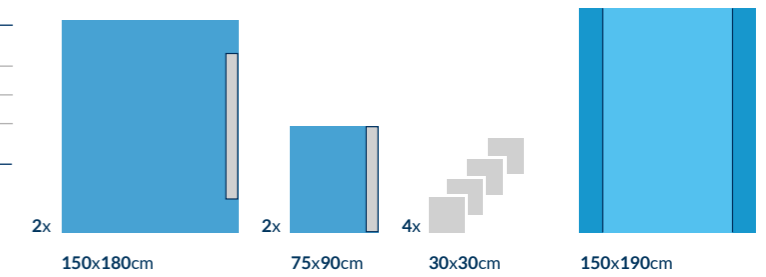

AT-S-UNI4-C UNIVERSAL SET 4 BESTSELLER

quantity	dimensions	component
1 pc.	170cm x 240cm	drape with adhesive edge, reinforced
1 pc.	170cm x 180cm	drape with adhesive edge, reinforced
2 pcs	75cm x 90cm	highly absorbent drape with adhesive edge
4 pcs	30cm x 30cm	absorbent towel
1 pc.	10cm x 50cm	OP tape
1 pc.	80cm x 145cm	Mayo stand cover, reinforced - red
1 pc.	150cm x 190cm	instrument table cover, reinforced

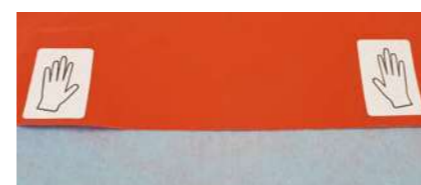

Mayo stand cover, reinforced - red

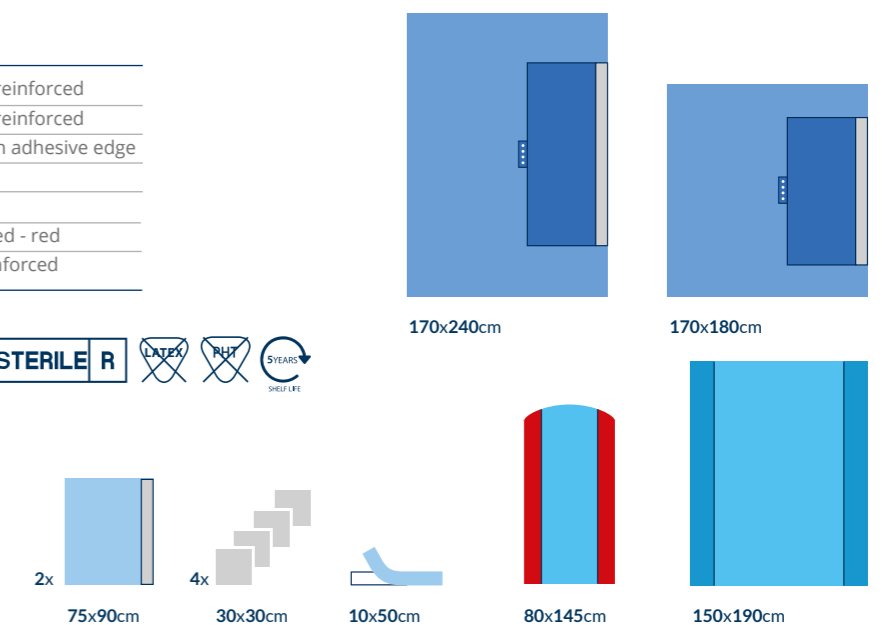

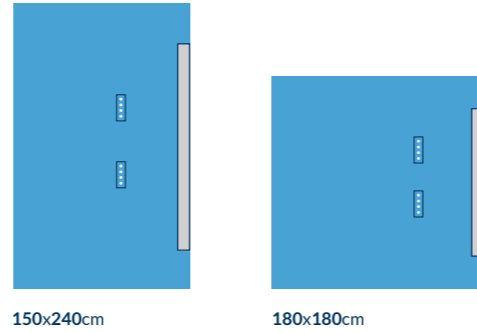

AT-S-UNI5-S UNIVERSAL SET 5  **BESTSELLER**

quantity	dimensions	component
1 pc.	150cm x 240cm	drape with adhesive edge
1 pc.	180cm x 180cm	drape with adhesive edge
2 pcs	75cm x 90cm	drape with adhesive edge
4 pcs	30 cmx30 cm	absorbent towel
1 pc.	10cm x 50cm	OP tape
1 pc.	80cm x 145cm	Mayo stand cover, reinforced - red
1 pc.	150cm x 190cm	instrument table cover, reinforced



150x240cm 180x180cm

 bulk packaging:
10 sets  60 g/m²

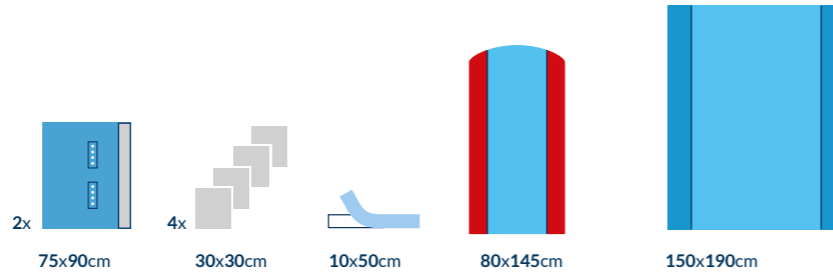

2x 75x90cm 4x 30x30cm 10x50cm 80x145cm 150x190cm

AT-S-UNI5-G-S UNIVERSAL SET 5-G

quantity	dimensions	component
1 pc.	150cm x 240cm	drape with adhesive edge
1 pc.	180cm x 180cm	drape with adhesive edge
2 pcs	75cm x 90cm	drape with adhesive edge
4 pcs	30cm x 30cm	absorbent towel
1 pc.	10cm x 50cm	OP tape
1 pc.	80cm x 145cm	Mayo stand cover, reinforced - red
1 pc.	150cm x 190cm	instrument table cover, reinforced
1 pc.	L	surgical gown STANDARD
2 pcs	XL	surgical gown STANDARD

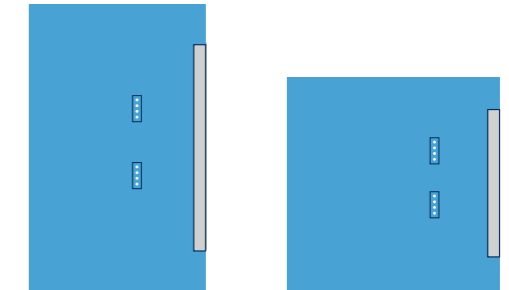

150x240cm 180x180cm

 bulk packaging:
6 sets **STERILE R**   

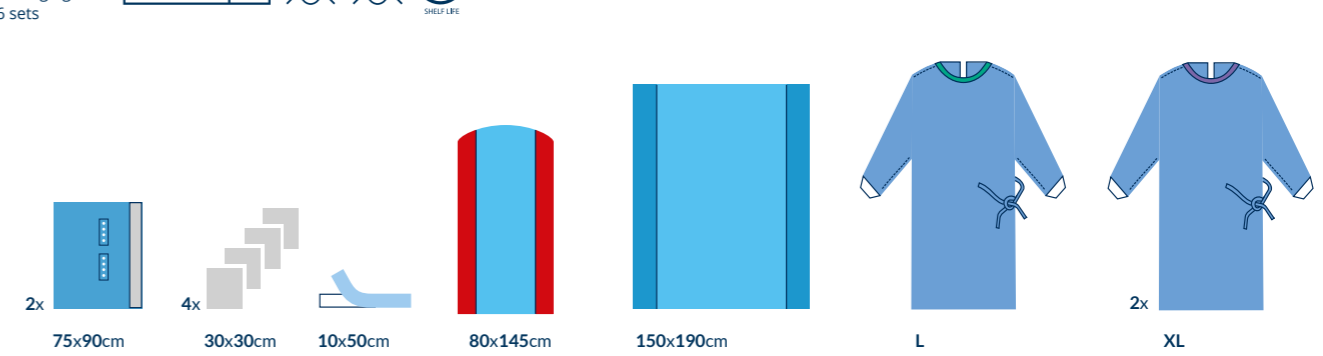



2x 75x90cm 4x 30x30cm 10x50cm 80x145cm 150x190cm L XL

AT-S-UNI5-M-S UNIVERSAL SET 5-M 

quantity	dimensions	component
1 pc.	150cm x 240cm	drape with adhesive edge
1 pc.	180cm x 180cm	drape with adhesive edge
2 pcs	75cm x 90cm	drape with adhesive edge
4 pcs	30 cmx30 cm	absorbent towel
1 pc.	10cm x 50cm	OP tape
1 pc.	80cm x 145cm	Mayo stand cover, reinforced - red
1 pc.	150cm x 190cm	instrument table cover, reinforced



150x240cm 180x180cm

 bulk packaging:
15 sets  56 g/m²

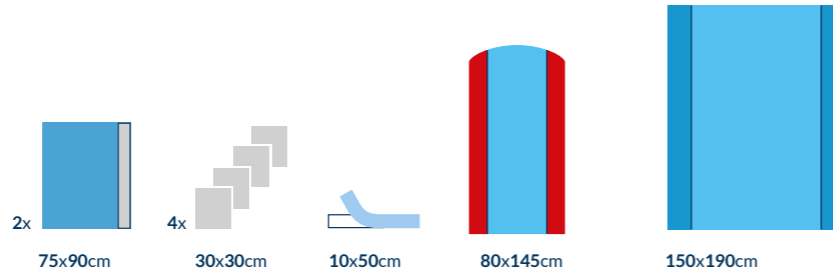

2x 75x90cm 4x 30x30cm 10x50cm 80x145cm 150x190cm

AT-S-UNI5-GP-S UNIVERSAL SET 5-GP

quantity	dimensions	component
1 pc.	150cm x 240cm	drape with adhesive edge
1 pc.	180cm x 180cm	drape with adhesive edge
2 pcs	75cm x 90cm	drape with adhesive edge
4 pcs	30cm x 30cm	absorbent towel
1 pc.	10cm x 50cm	OP tape
1 pc.	80cm x 145cm	Mayo stand cover, reinforced - red
1 pc.	150cm x 190cm	instrument table cover, reinforced
1 pc.	XL	surgical gown STANDARD
1 pc.	XXL	surgical gown, reinforced STANDARD PLUS
1 pc.	30cm x 40cm	adhesive pouch, one-chamber

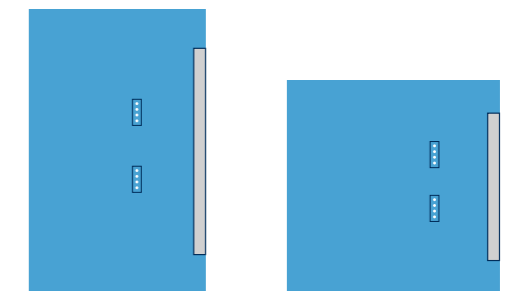

150x240cm 180x180cm

 bulk packaging:
7 sets **STERILE R**   

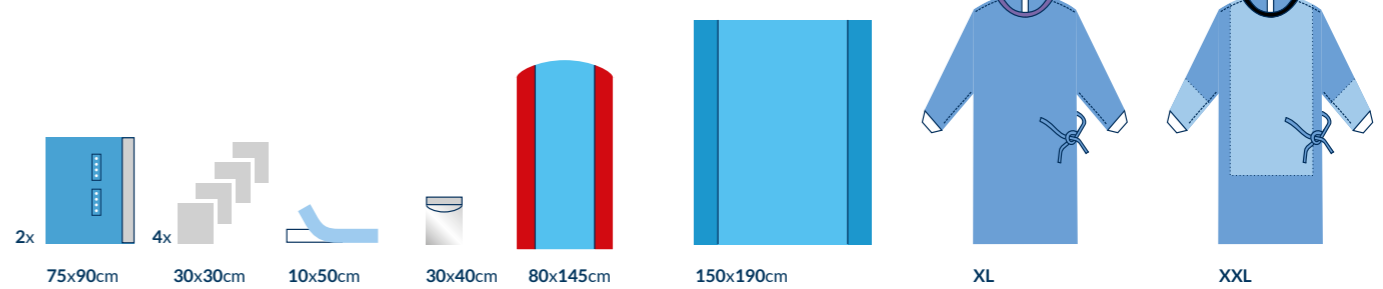

2x 75x90cm 4x 30x30cm 10x50cm 30x40cm 80x145cm 150x190cm XL XXL

AT-S-UNI6-SP UNIVERSAL SET 6  **BESTSELLER**

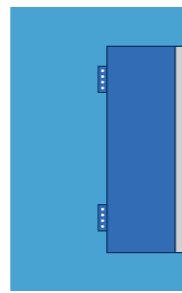

quantity	dimensions	component
1 pc.	150cm x 240cm	drape with adhesive edge, reinforced
1 pc.	180cm x 180cm	drape with adhesive edge, reinforced
2 pcs	75cm x 90cm	drape with adhesive edge, reinforced
4 pcs	30cm x 30cm	absorbent towel
1 pc.	10cm x 50cm	OP tape
1 pc.	80cm x 145cm	Mayo stand cover, reinforced - red
1 pc.	150cm x 190cm	instrument table cover, reinforced

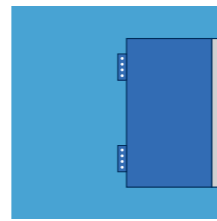

150x240cm



180x180cm

 bulk packaging: 9 sets
 highly absorbent material
 60 g/m²

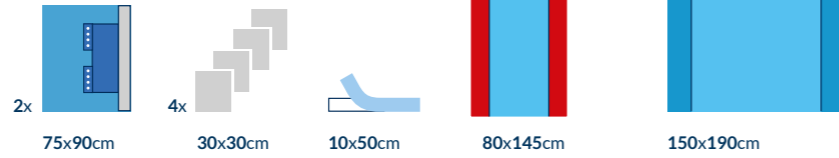

AT-S-UNI7-C UNIVERSAL SET 7

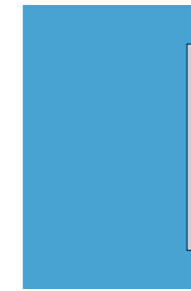

quantity	dimensions	component
1 pc.	150cm x 240cm	drape with adhesive edge
1 pc.	180cm x 180cm	drape with adhesive edge
2 pcs	75cm x 90cm	drape with adhesive edge
4 pcs	30cm x 30cm	absorbent towel
1 pc.	10cm x 50cm	OP tape
1 pc.	80cm x 145cm	Mayo stand cover, reinforced - red
1 pc.	150cm x 190cm	instrument table cover, reinforced

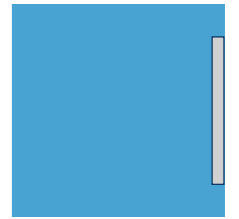

150x240cm



180x180cm

 bulk packaging: 8 sets
 3-layer drapes PREMIUM
 highly absorbent material

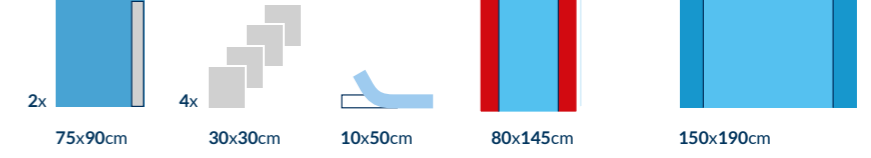

AT-S-UNI6-M-SP UNIVERSAL SET 6-M 

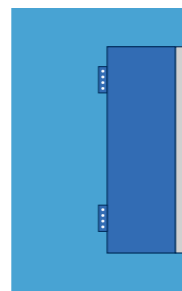

quantity	dimensions	component
1 pc.	150cm x 240cm	drape with adhesive edge, reinforced
1 pc.	180cm x 180cm	drape with adhesive edge, reinforced
2 pcs	75cm x 90cm	drape with adhesive edge, reinforced
4 pcs	30cm x 30cm	absorbent towel
1 pc.	10cm x 50cm	OP tape
1 pc.	80cm x 145cm	Mayo stand cover, reinforced - red
1 pc.	150cm x 190cm	instrument table cover, reinforced

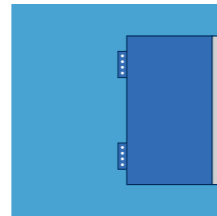

150x240cm



180x180cm

 bulk packaging: 12 sets
 highly absorbent material
 56 g/m²

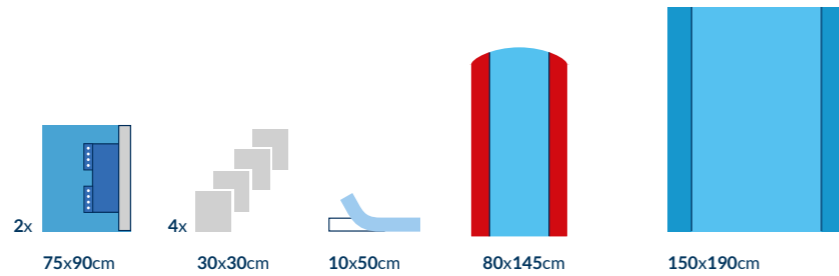

AT-S-UNI8-C UNIVERSAL SET 8

quantity	dimensions	component
1 pc.	150cm x 240cm	drape with adhesive edge, reinforced
1 pc.	180cm x 180cm	drape with adhesive edge, reinforced
2 pcs	75cm x 90cm	drape with adhesive edge, reinforced
4 pcs	30cm x 30cm	absorbent towel
1 pc.	10cm x 50cm	OP tape
1 pc.	80cm x 145cm	Mayo stand cover, reinforced - red
1 pc.	150cm x 190cm	instrument table cover, reinforced

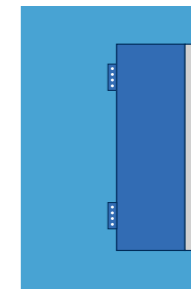

150x240cm

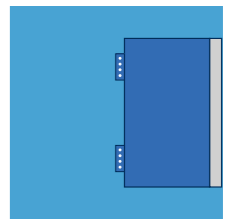

180x180cm

 bulk packaging: 7 sets
 3-layer drapes PREMIUM
 highly absorbent material

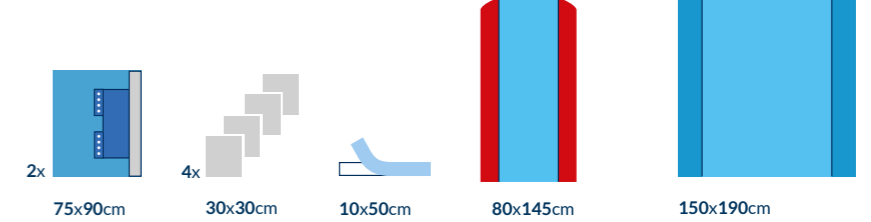

AT-S-UNI9-SP PEDIATRIC UNIVERSAL SET 9

quantity	dimensions	component
1 pc.	150cm x 240cm	drape with adhesive edge
1 pc.	180cm x 180cm	drape with adhesive edge
2 pcs	75cm x 75cm	drape with adhesive edge, reinforced
4 pcs	30cm x 30cm	absorbent towel
1 pc.	10cm x 50cm	OP tape
1 pc.	80cm x 145cm	Mayo stand cover, reinforced - red
1 pc.	150cm x 190cm	instrument table cover, reinforced

bulk packaging: 8 sets
pediatric set



thinner tape in drapes - 2.5cm

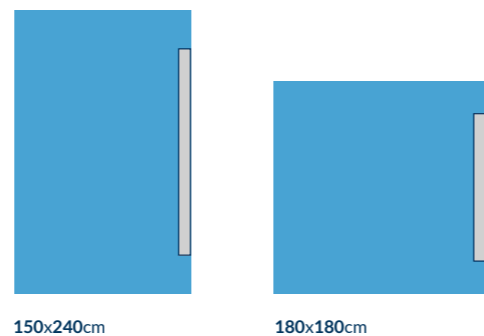
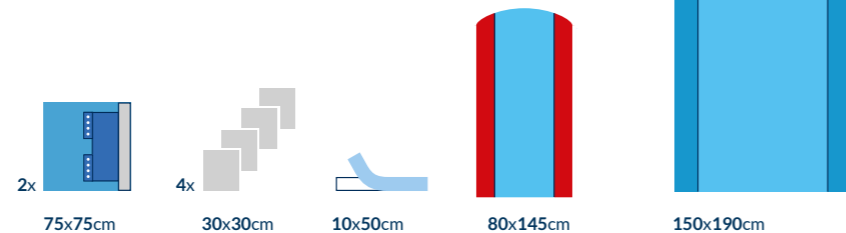

150x240cm 180x180cm

AT-S-UNI10-S UNIVERSAL SET 10

quantity	dimensions	component
1 pc.	150cm x 230cm	drape with adhesive edge
1 pc.	150cm x 180cm	drape with adhesive edge
2 pcs	75cm x 90cm	drape with adhesive edge
4 pcs	30cm x 30cm	absorbent towel
1 pc.	10cm x 50cm	OP tape
1 pc.	80cm x 145cm	Mayo stand cover, reinforced - red
1 pc.	150cm x 190cm	instrument table cover, reinforced

bulk packaging: 10 sets

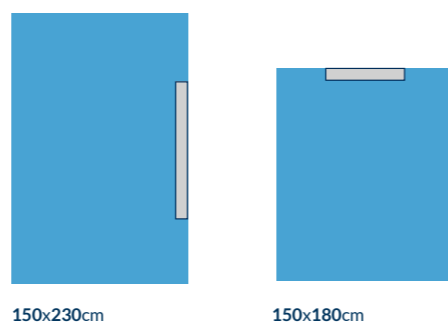
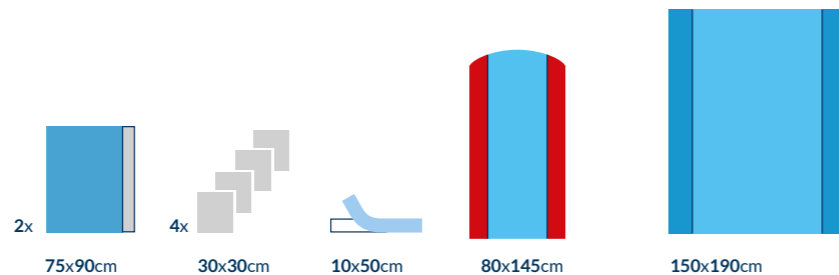

150x230cm 150x180cm

GENERAL SURGERY

AT-S-ABD1-IF-C ABDOMINAL SET 1-IF

quantity	dimensions	component
1 pc.	200cm x 320cm	drape with adhesive fenestration 25cm x 30cm filled with an incise film, reinforced
4 pcs	30cm x 30cm	absorbent towel
1 pc.	10cm x 50cm	OP tape
1 pc.	80cm x 145cm	Mayo stand cover, reinforced - red
1 pc.	150cm x 190cm	instrument table cover, reinforced

bulk packaging: 10 sets
hydrophobic SMS material
highly absorbent material

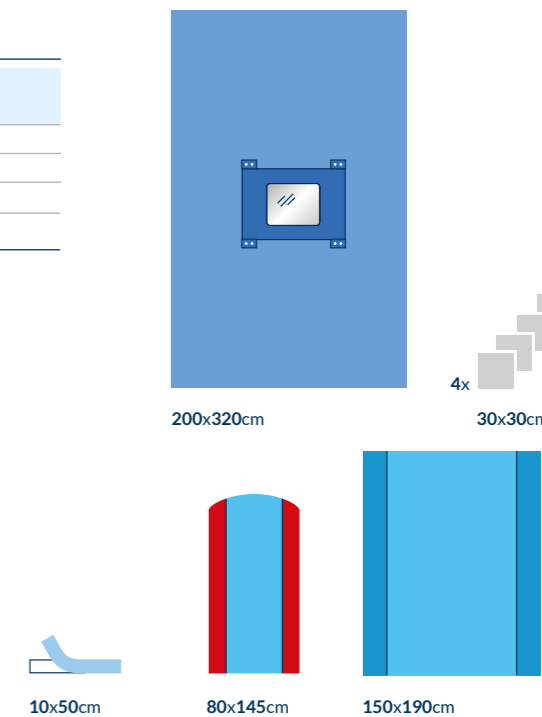

200x320cm 30x30cm

AT-S-ABPER1-S ABDO-PERINEAL SET 1

quantity	dimensions	component
1 pc.	180/270cm x 220cm	drape integrated with limb covers, adhesive trapezium-shaped fenestration 30cm x 20cm x 20cm and perineal fenestration 10cm x 15cm with covering flap
4 pcs	30cm x 30cm	absorbent towel
1 pc.	10cm x 50cm	OP tape
1 pc.	2cm x 22cm	surgical tape, Velcro type
1 pc.	14cm x 250cm	camera cable cover
1 pc.	80cm x 145cm	Mayo stand cover, reinforced - red
1 pc.	150cm x 190cm	instrument table cover, reinforced

bulk packaging: 12 sets
STERILE R, LATEX, PH, 5 YEARS SHELF LIFE



flap to secure the fenestration

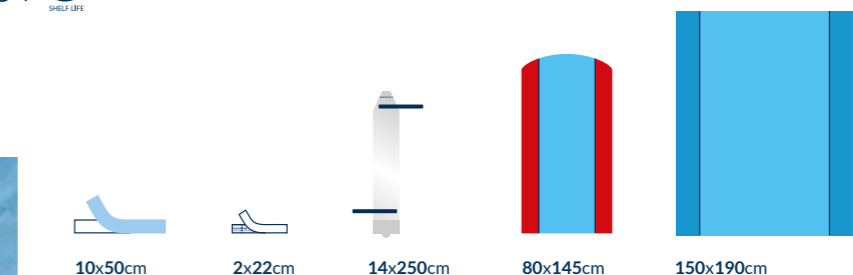

180/270x220cm 30x30cm

AT-S-LAP1-IF-C LAPAROSCOPY SET 1-IF

quantity	dimensions	component
1 pc.	200cm x 260cm	drape T-shaped with adhesive fenestration 30cm x 30cm filled with an incise film
4 pcs	30cm x 30cm	absorbent towel
1 pc.	10cm x 50cm	OP tape
1 pc.	14cm x 250cm	camera cable cover
2 pcs	70cm x 120cm	limb cover
1 pc.	80cm x 140cm	Mayo stand cover, reinforced - red
1 pc.	150cm x 190cm	instrument table cover, reinforced

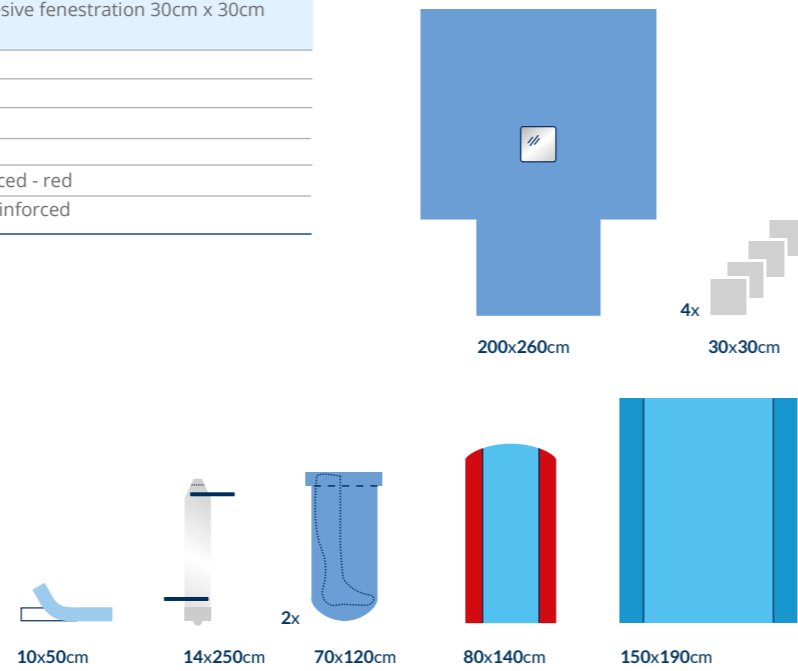

AT-S-LAP2-SP LAPAROSCOPY SET 2 BESTSELLER

quantity	dimensions	component
1 pc.	200/270cm x 300cm	drape integrated with limb covers, adhesive fenestration 25cm x 30cm, reinforced, with 8 cable holders Velcro type
4 pcs	30cm x 30cm	absorbent towel
1 pc.	10cm x 50cm	OP tape
1 pc.	2cm x 22cm	surgical tape, Velcro type
1 pc.	14cm x 250cm	camera cable cover
1 pc.	80cm x 145cm	Mayo stand cover, reinforced - red
1 pc.	150cm x 190cm	instrument table cover, reinforced

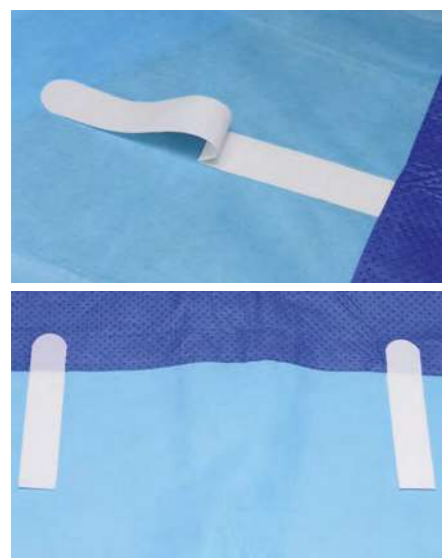
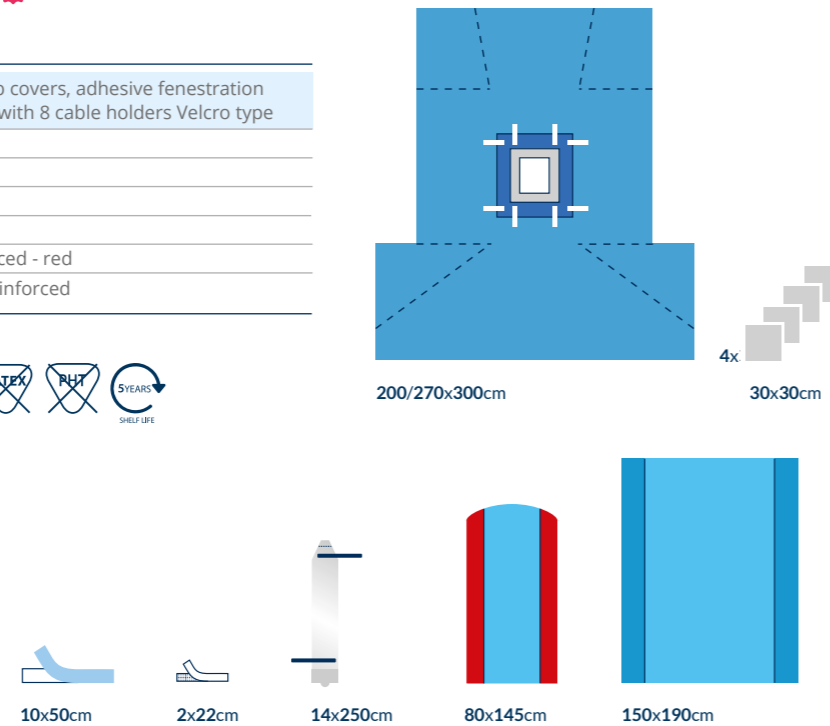

cable holders, Velcro type

AT-S-LAP3-C LAPAROSCOPY SET 3

quantity	dimensions	component
1 pc.	200/270cm x 300cm	drape integrated with limb covers, adhesive fenestration 25cm x 30cm, reinforced, with 8 cable holders Velcro type
4 pcs	30cm x 30cm	absorbent towel
1 pc.	10cm x 50cm	OP tape
1 pc.	2cm x 22cm	surgical tape, Velcro type
1 pc.	14cm x 250cm	camera cable cover
1 pc.	30cm x 40cm	adhesive pouch, one-chamber
1 pc.	80cm x 145cm	Mayo stand cover, reinforced - red
1 pc.	150cm x 190cm	instrument table cover, reinforced

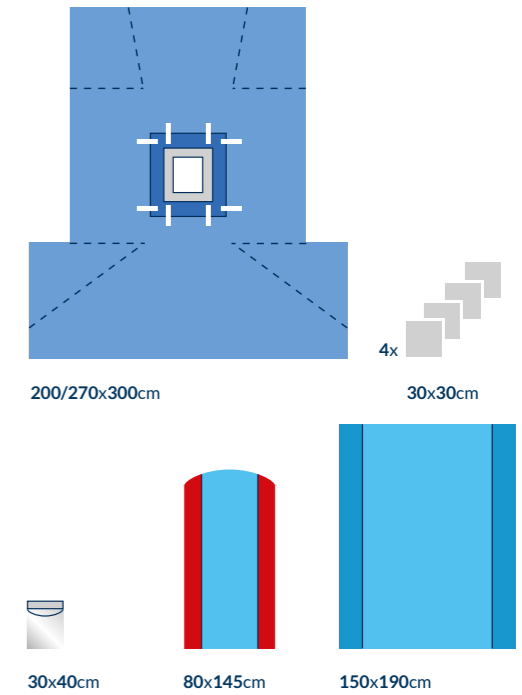

AT-S-VAR1-S VARICOSE VEIN SET 1

quantity	dimensions	component
1 pc.	200cm x 260cm	drape with adhesive U-split 8,5cm x 85cm
1 pc.	160cm x 180cm	drape with adhesive edge
4 pcs	30cm x 30cm	absorbent towel
1 pc.	80cm x 140cm	Mayo stand cover, reinforced - red
1 pc.	150cm x 190cm	instrument table cover, reinforced

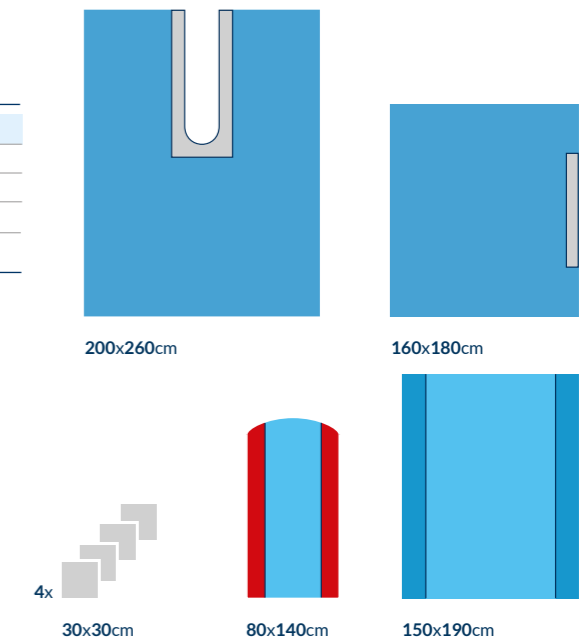

AT-S-VAR2-C VARICOSE VEIN SET 2

quantity	dimensions	component
1 pc.	200cm x 260cm	drape with adhesive U-split 8,5cm x 95cm, integrated genital area cover, reinforced
1 pc.	170cm x 180cm	drape with adhesive edge, reinforced
4 pcs	30cm x 30cm	absorbent towel
1 pc.	80cm x 140cm	Mayo stand cover, reinforced - red
1 pc.	150cm x 190cm	instrument table cover, reinforced

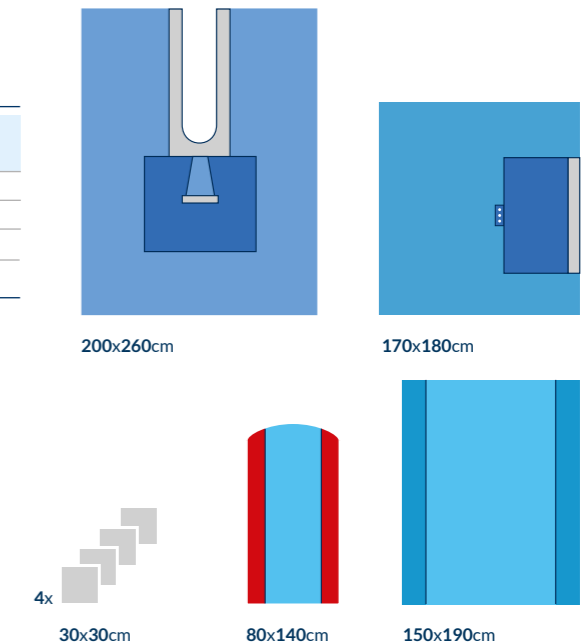



ORTHOPAEDICS AND TRAUMATOLOGY

AT-S-EXT1-C EXTREMITY SET 1

quantity	dimensions	component
1 pc.	200cm x 300cm	drape with elastic fenestration \varnothing 3,5cm, reinforced
1 pc.	80cm x 145cm	Mayo stand cover, reinforced - red
1 pc.	150cm x 190cm	instrument table cover, reinforced

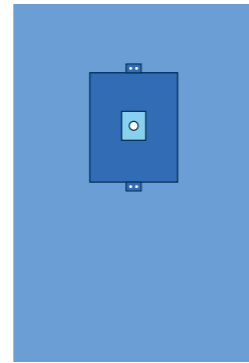

200x300cm



80x145cm

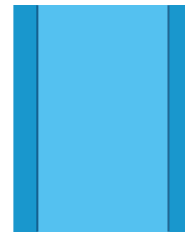

150x190cm

AT-S-EXT2-C EXTREMITY SET 2

quantity	dimensions	component
1 pc.	200cm x 300cm	drape with elastic fenestration \varnothing 3,5cm, reinforced
1 pc.	160cm x 180cm	drape with adhesive edge
4 pcs	30cm x 30cm	absorbent towel
1 pc.	10cm x 50cm	OP tape
1 pc.	80cm x 145cm	Mayo stand cover, reinforced - red
1 pc.	150cm x 190cm	instrument table cover, reinforced

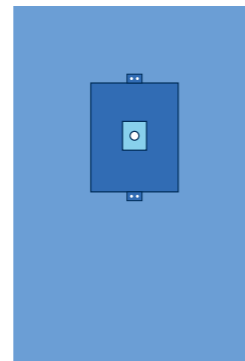

200x300cm

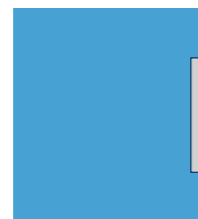

160x180cm

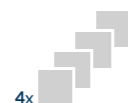

4x 30x30cm



10x50cm



80x145cm

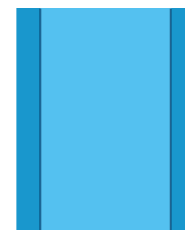

150x190cm

AT-S-ART1-C ARTHROSCOPY SET 1

quantity	dimensions	component
1 pc.	200cm x 320cm	drape with elastic fenestration 6cm x 8cm, reinforced
4 pcs	30cm x 30cm	absorbent towel
1 pc.	10cm x 50cm	OP tape
1 pc.	30cm x 60cm	elastic limb cover
1 pc.	80cm x 145cm	Mayo stand cover, reinforced - red
1 pc.	150cm x 190cm	instrument table cover, reinforced

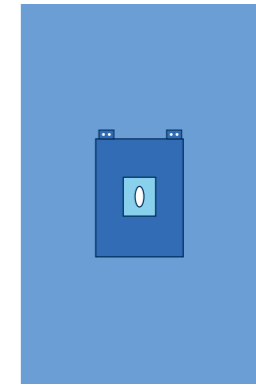

200x320cm

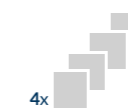

4x 30x30cm



10x50cm



30x60cm



80x145cm

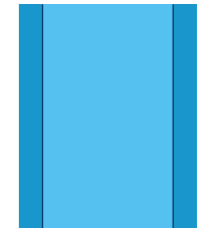

150x190cm

AT-S-ART2-C ARTHROSCOPY SET 2

quantity	dimensions	component
1 pc.	200cm x 320cm	drape with elastic fenestration 6cm x 8cm, reinforced
2 pcs	30cm x 30cm	absorbent towel
2 pcs	10cm x 50cm	OP tape
1 pc.	14cm x 250cm	camera cable cover
1 pc.	30cm x 60cm	elastic limb cover
1 pc.	60cm x 100cm	fluid collection pouch with elastic fenestration, formable molder and tubing port
1 pc.	80cm x 145cm	Mayo stand cover, reinforced - red
1 pc.	150cm x 190cm	instrument table cover, reinforced

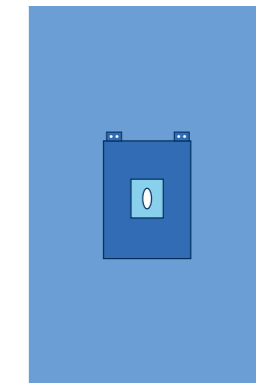

200x320cm

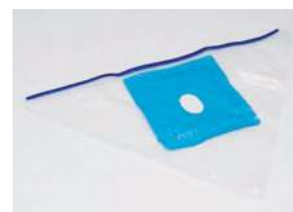

arthroscopy pouch



2x 30x30cm



2x 10x50cm



14x250cm



30x60cm



60x100cm



80x145cm

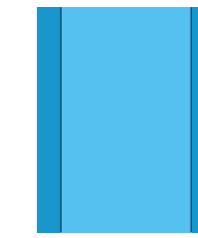

150x190cm

AT-S-ART2-IP-C ARTHROSCOPY SET 2-IP

quantity	dimensions	component
1 pc.	200cm x 320cm	drape with elastic fenestration 6cm x 8cm, integrated fluid collection pouch, reinforced
2 pcs	30cm x 30cm	absorbent towel
3 pcs	10cm x 50cm	OP tape
1 pc.	14cm x 250cm	camera cable cover
1 pc.	30cm x 60cm	elastic limb cover
1 pc.	80cm x 145cm	Mayo stand cover, reinforced - red
1 pc.	150cm x 190cm	instrument table cover, reinforced

bulk packaging: 10 sets

hydrophobic SMS material

highly absorbent material

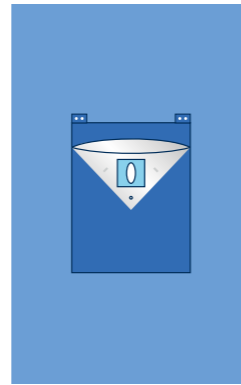

200x320cm

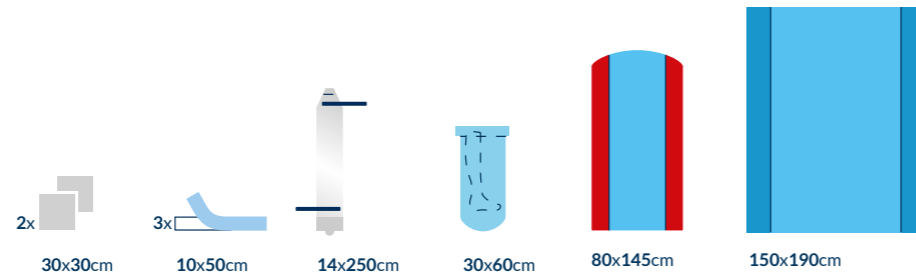

AT-S-ART4-IP-S ARTHROSCOPY SET 4-IP

quantity	dimensions	component
1 pc.	230cm x 320cm	drape with elastic fenestration ø 7cm, integrated fluid collection pouch
4 pcs	30cm x 30cm	absorbent towel
3 pcs	10cm x 50cm	OP tape
1 pc.	22cm x 75cm	elastic limb cover
1 pc.	80cm x 145cm	Mayo stand cover, reinforced - red
2 pcs	150cm x 190cm	instrument table cover, reinforced

bulk packaging: 7 sets

2x double instrument table cover

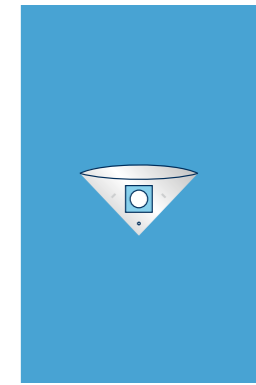

230x320cm

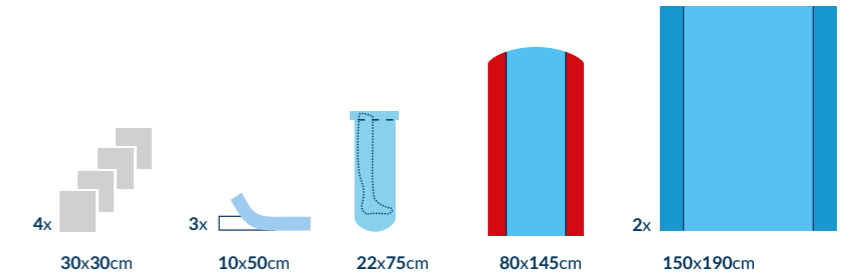

AT-S-ART3-C ARTHROSCOPY SET 3

quantity	dimensions	component
1 pc.	200cm x 320cm	drape with elastic fenestration 6cm x 8cm, reinforced
2 pcs	30cm x 30cm	absorbent towel
3 pcs	10cm x 50cm	OP tape
1 pc.	14cm x 250cm	camera cable cover
1 pc.	30cm x 60cm	elastic limb cover
1 pc.	80cm x 145cm	Mayo stand cover, reinforced - red
1 pc.	150cm x 190cm	instrument table cover, reinforced

bulk packaging: 12 sets

hydrophobic SMS material

highly absorbent material

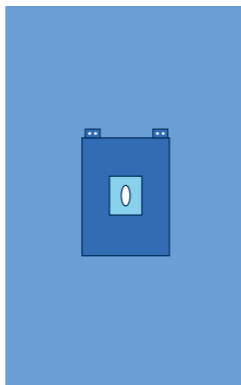

200x320cm

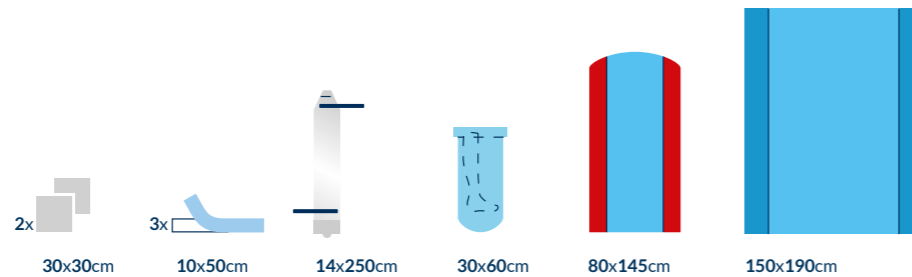

AT-S-ART5-SP ARTHROSCOPY SET 5

quantity	dimensions	component
1 pc.	230cm x 300cm	drape with elastic fenestration ø 7cm, reinforced
4 pcs	30cm x 30cm	absorbent towel
3 pcs	10cm x 50cm	OP tape
1 pc.	22cm x 75cm	elastic limb cover
1 pc.	80cm x 145cm	Mayo stand cover, reinforced - red
2 pcs	150cm x 190cm	instrument table cover, reinforced

bulk packaging: 7 sets

highly absorbent material

2x double instrument table cover

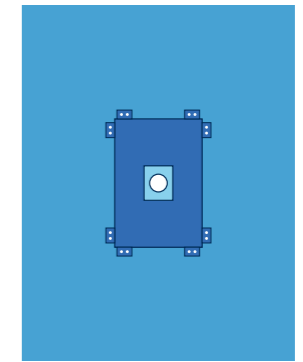

230x300cm

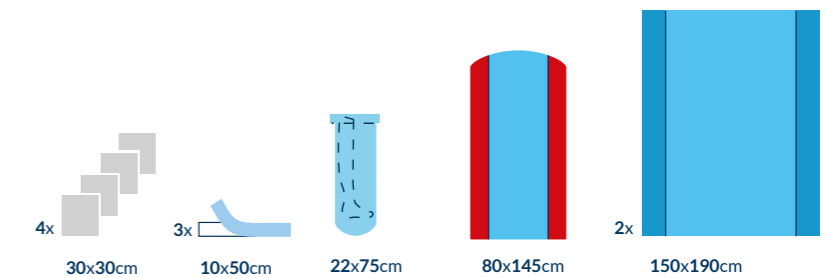

AT-S-HIP1-C HIP SET 1

quantity	dimensions	component
1 pc.	200cm x 260cm	drape with adhesive U-split 8,5cm x 85cm, reinforced
1 pc.	170cm x 240cm	drape with adhesive edge, reinforced
4 pcs	30cm x 30cm	absorbent towel
2 pcs	10cm x 50cm	OP tape
1 pc.	35cm x 120cm	elastic limb cover
1 pc.	80cm x 145cm	Mayo stand cover, reinforced - red
1 pc.	150cm x 190cm	instrument table cover, reinforced

- bulk packaging: 8 sets
- hydrophobic SMS material
- highly absorbent material
- drape with U-split

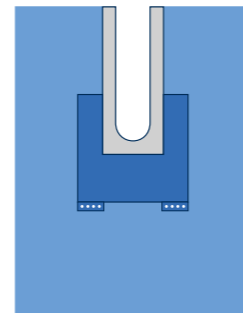

200x260cm

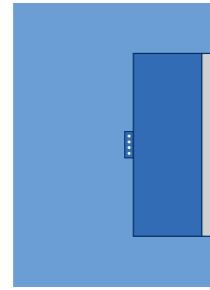

170x240cm

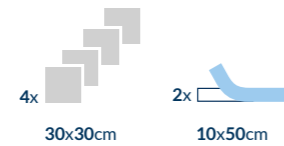

4x 30x30cm

2x 10x50cm



35x120cm



80x145cm

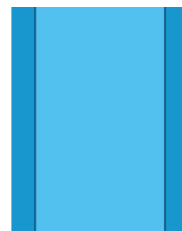

150x190cm



AT-S-HIP2-C HIP SET 2

quantity	dimensions	component
1 pc.	200cm x 260cm	drape with adhesive U-split 8,5cm x 85cm, reinforced
1 pc.	170cm x 300cm	drape with adhesive edge, reinforced
1 pc.	160cm x 180cm	drape with adhesive edge
4 pcs	30cm x 30cm	absorbent towel
2 pcs	10cm x 50cm	OP tape
1 pc.	35cm x 120cm	elastic limb cover
1 pc.	80cm x 145cm	Mayo stand cover, reinforced - red
1 pc.	150cm x 190cm	instrument table cover, reinforced

- bulk packaging: 8 sets
- hydrophobic SMS material
- highly absorbent material
- drape with U-split

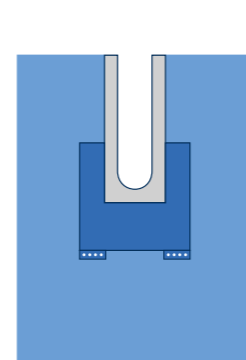

200x260cm

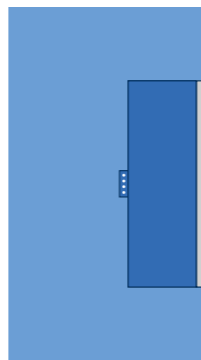

170x300cm

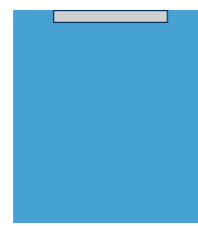

160x180cm

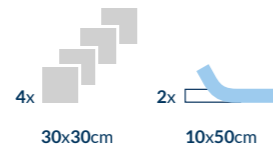

4x 30x30cm

2x 10x50cm



35x120cm



80x145cm

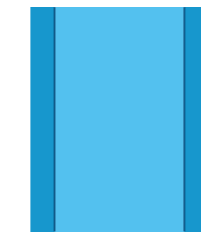

150x190cm



AT-S-HIP3-SP HIP SET 3

quantity	dimensions	component
1 pc.	230cm x 260cm	drape with adhesive U-split 20cm x 100cm, reinforced
1 pc.	150cm x 240cm	drape with adhesive edge, reinforced
1 pc.	180cm x 180cm	drape with adhesive edge, reinforced
2 pcs	75cm x 90cm	drape with adhesive edge, reinforced
4 pcs	30cm x 30cm	absorbent towel
3 pcs	10cm x 50cm	OP tape
1 pc.	35cm x 120cm	elastic limb cover
1 pc.	10cm x 450cm	elastic bandage
1 pc.	80cm x 145cm	Mayo stand cover, reinforced - red
1 pc.	150cm x 190cm	instrument table cover, reinforced

- bulk packaging: 5 sets
- highly absorbent material
- drape with U-split

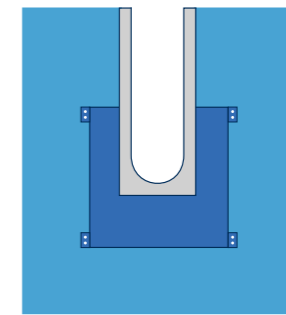

230x260cm

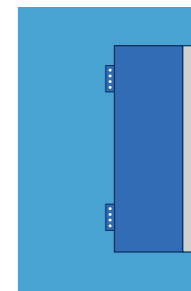

150x240cm

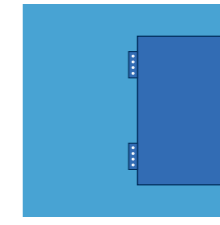

180x180cm

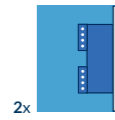

2x 75x90cm



4x 30x30cm

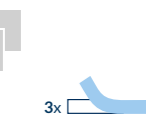

3x 10x50cm



elastic bandage



35x120cm



10x450cm



80x145cm

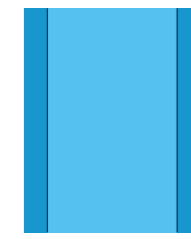

150x190cm



AT-S-SHLR1-C SHOULDER SET 1

quantity	dimensions	component
1 pc.	200cm x 260cm	drape with adhesive U-split 8,5cm x 85cm, reinforced
1 pc.	170cm x 180cm	drape with adhesive edge, reinforced
1 pc.	150cm x 180cm	drape with adhesive edge
4 pcs	30cm x 30cm	absorbent towel
1 pc.	10cm x 50cm	OP tape
1 pc.	30cm x 60cm	elastic limb cover
1 pc.	80cm x 145cm	Mayo stand cover, reinforced - red
1 pc.	150cm x 190cm	instrument table cover, reinforced

- bulk packaging: 8 sets
- hydrophobic SMS material
- highly absorbent material
- drape with U-split

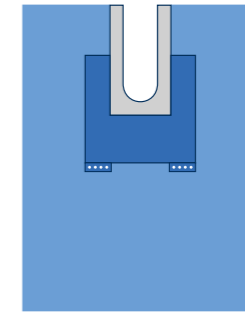

200x260cm

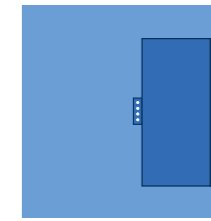

170x180cm



150x180cm

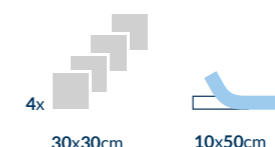

4x 30x30cm

10x50cm



30x60cm



80x145cm

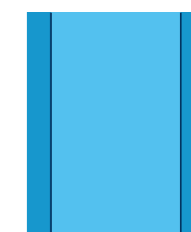

150x190cm



AT-S-SHLR2-S SHOULDER SET 2

quantity	dimensions	component
1 pc.	263cm x 406cm	drape with elastic fenestration 13cm x 14cm, integrated fluid collection pouch
4 pcs	30cm x 30cm	absorbent towel
2 pcs	10cm x 50cm	OP tape
1 pc.	22cm x 75cm	elastic limb cover
1 pc.	80cm x 145cm	Mayo stand cover, reinforced - red
1 pc.	150cm x 190cm	instrument table cover, reinforced

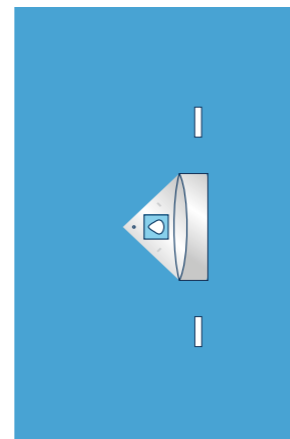
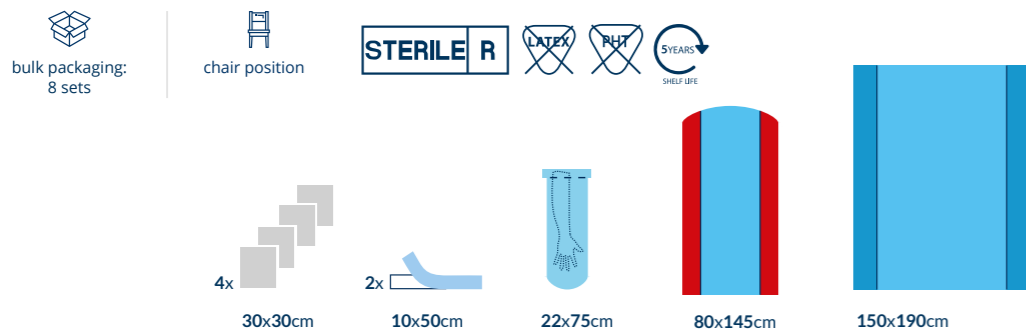

263x406cm

AT-S-DHS1-IF-SP DYNAMIC HIP SCREW SET 1-IF



quantity	dimensions	component
1 pc.	250cm x 300cm	drape integrated with limb covers and screen cover, two fenestration 14cm x 40cm filled with an incise film, reinforced
1 pc.	50cm x 60cm	adhesive pouch, one-chamber
4 pcs	30cm x 30cm	absorbent towel
1 pc.	10cm x 50cm	adhesive tape
1 pc.	80cm x 145cm	Mayo stand cover, reinforced - red
1 pc.	150cm x 190cm	instrument table cover, reinforced

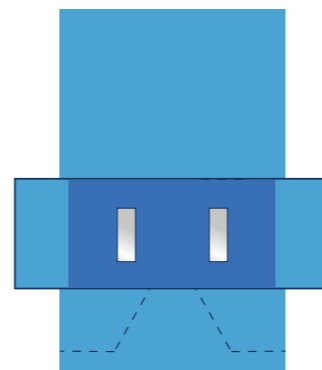
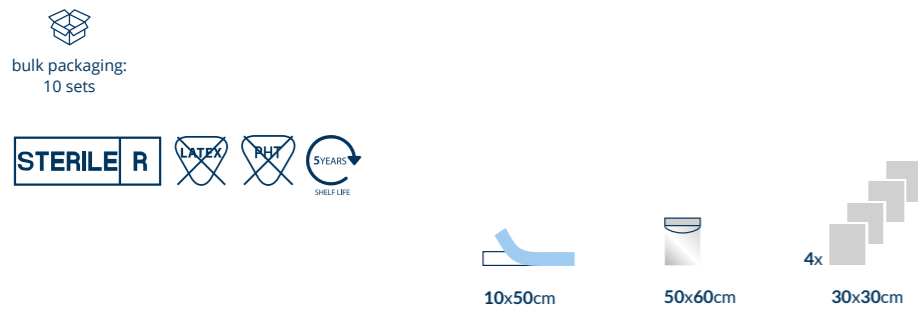

250x300cm

AT-S-VER1-IP-S VERTICAL ISOLATION SET 1-IP



quantity	dimensions	component
1 pc.	240cm x 340cm	drape integrated with limb covers and screen cover, two fenestration 14cm x 40cm filled with an incise film, reinforced
4 pcs	30cm x 30cm	absorbent towel
1 pc.	80cm x 145cm	Mayo stand cover, reinforced - red
1 pc.	150cm x 190cm	instrument table cover, reinforced

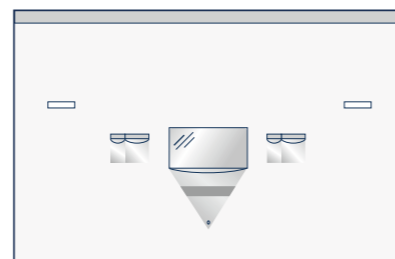

340x240cm

GYNAECOLOGY AND UROLOGY

AT-S-GYN1-S GYNAECOLOGY SET 1

quantity	dimensions	component
1 pc.	160/240cm x 180cm	drape integrated with limb covers, adhesive perineal fenestration 10cm x 15cm, integrated fluid collection pouch 35cm x 50cm with formable mold, filter and tubing port
1 pc.	75cm x 90cm	drape without adhesive edge
4 pcs	30cm x 30cm	absorbent towel
1 pc.	10cm x 50cm	OP tape
1 pc.	150cm x 190cm	instrument table cover, reinforced

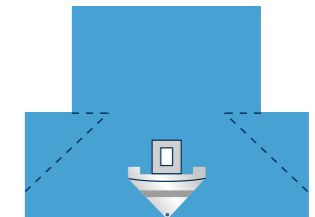

160/240x180cm



fluid collection pouch with filter and tubing port

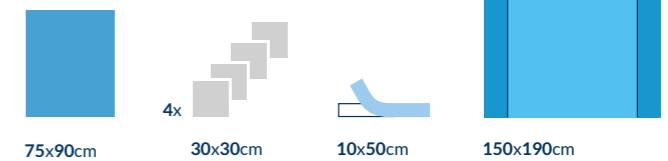

AT-S-GYN2-C GYNAECOLOGY SET 2



quantity	dimensions	component
1 pc.	160/240cm x 180cm	drape integrated with limb covers, adhesive perineal fenestration 10cm x 15cm, integrated fluid collection pouch 35cm x 50cm with formable mold, filter and tubing port, reinforced
1 pc.	75cm x 90cm	drape without adhesive edge
4 pcs	30cm x 30cm	absorbent towel
1 pc.	10cm x 50cm	OP tape
1 pc.	80cm x 145cm	Mayo stand cover, reinforced - red
1 pc.	150cm x 190cm	instrument table cover, reinforced

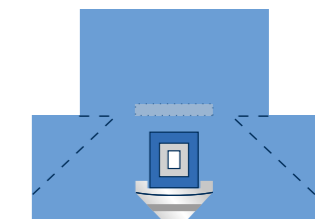
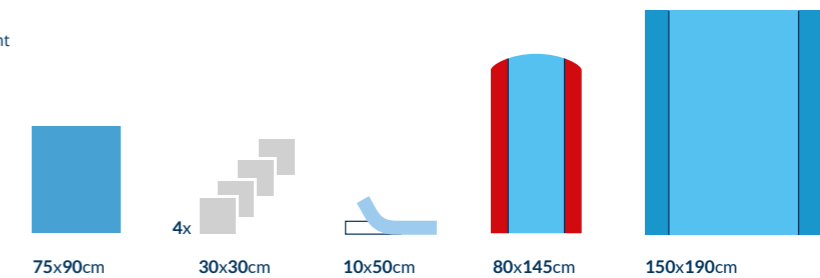

160/240x180cm



fluid collection pouch with filter and tubing port

AT-S-GYN3-C GYNAECOLOGY SET 3

quantity	dimensions	component
1 pc.	170cm x 180cm	drape with adhesive edge, reinforced
2 pcs	100cm x 150cm	drape with adhesive edge
1 pc.	75cm x 90cm	drape with adhesive edge
1 pc.	100cm x 150cm	drape without adhesive edge
4 pcs	30cm x 30cm	absorbent towel
1 pc.	10cm x 50cm	OP tape
2 pcs	70cm x 120cm	limb cover
1 pc.	80cm x 140cm	Mayo stand cover, reinforced - red
1 pc.	150cm x 190cm	instrument table cover, reinforced

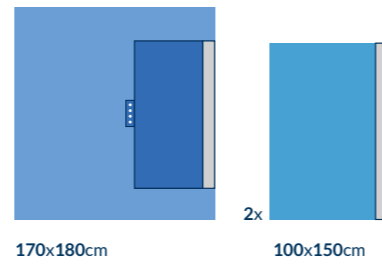

bulk packaging: 10 sets

STERILE R LATEX RHT 5 YEARS SHELF LIFE

hydrophobic SMS material

highly absorbent material

AT-S-UROG3-S URO/GYNAECOLOGY SET 3

quantity	dimensions	component
1 pc.	75cm x 200cm	drape with adhesive diamond-shaped fenestration 8cm x 12cm
4 pcs	30cm x 30cm	absorbent towel
2 pcs	70cm x 120cm	limb cover
1 pc.	100cm x 150cm	instrument table cover, reinforced

bulk packaging: 20 sets

STERILE R LATEX RHT 5 YEARS SHELF LIFE

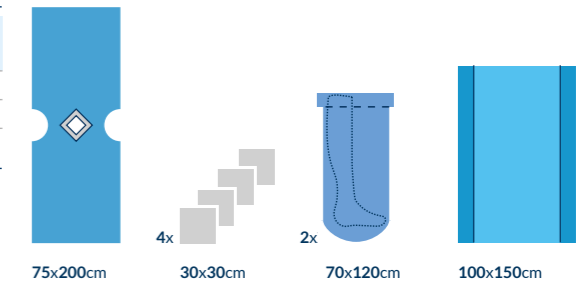

AT-S-TUR1-IP-C TUR SET 1-IP

quantity	dimensions	component
1 pc.	190cm x 230cm	drape integrated with limb covers, adhesive abdominal fenestration ø 6cm and adhesive perineal fenestration ø 6cm, finger coat, fluid collection pouch with formable mold, filter and tubing port
4 pcs	30cm x 30cm	absorbent towel
1 pc.	10cm x 50cm	OP tape
1 pc.	150cm x 190cm	instrument table cover, reinforced

bulk packaging: 12 sets

hydrophobic SMS material

STERILE R LATEX RHT 5 YEARS SHELF LIFE

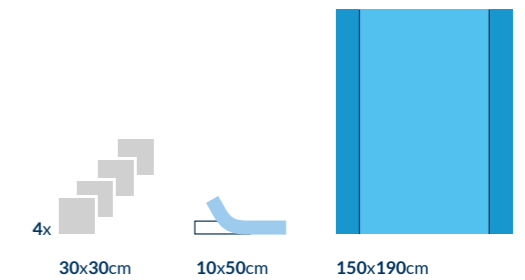
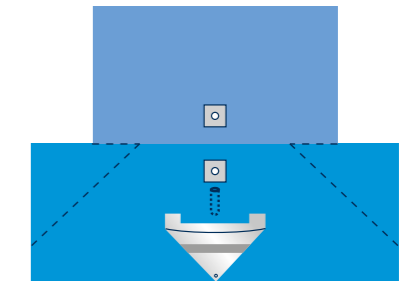

AT-S-CYST1-S CYSTOSCOPY SET 1

quantity	dimensions	component
1 pc.	75cm x 90cm	drape with adhesive fenestration 6cm x 8cm
2 pcs	70cm x 120cm	limb cover
1 pc.	100cm x 150cm	instrument table cover, reinforced

bulk packaging: 20 sets

STERILE R LATEX RHT 5 YEARS SHELF LIFE

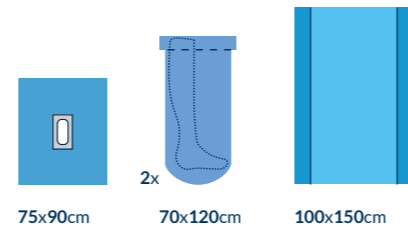

AT-S-UROG2-S URO/GYNAECOLOGY SET 2

quantity	dimensions	component
1 pc.	160cm x 180cm	drape with adhesive edge
1 pc.	75cm x 100cm	drape with adhesive fenestration 6cm x 14cm
1 pc.	10cm x 50cm	OP tape
2 pcs	70cm x 120cm	limb cover
1 pc.	80cm x 140cm	Mayo stand cover, reinforced - red
1 pc.	150cm x 190cm	instrument table cover, reinforced

bulk packaging: 10 sets

STERILE R LATEX RHT 5 YEARS SHELF LIFE

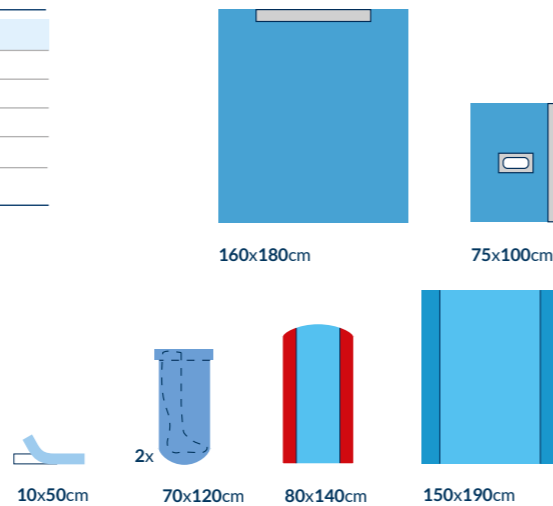

AT-S-TUR2-IP-C TUR SET 2-IP BESTSELLER

quantity	dimensions	component
1 pc.	175cm x 240cm	drape with integrated leggings, abdominal fenestration, perineal fenestration with finger coat and fluid collection pouch
2 pcs	30cm x 30cm	absorbent towel
1 pc.	2cm x 22cm	surgical tape, Velcro type
1 pc.	150cm x 190cm	instrument table cover, reinforced

bulk packaging: 15 sets

3-layer drapes PREMIUM

STERILE R LATEX RHT 5 YEARS SHELF LIFE

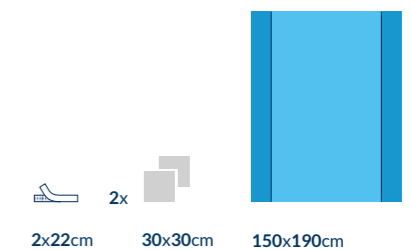
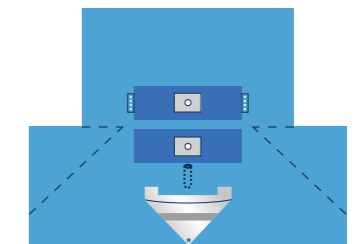

AT-S-PCNL1-IP-S PERCUTANEOUS LITHOTRIPSY SET 1-IP



quantity	dimensions	component
1 pc.	180cm x 300cm	drape with adhesive fenestration 21,5cm x 24cm, integrated with long fluid collection pouch
1 pc.	150cm x 190cm	instrument table cover, reinforced

bulk packaging: 12 sets
kidney stone removal set

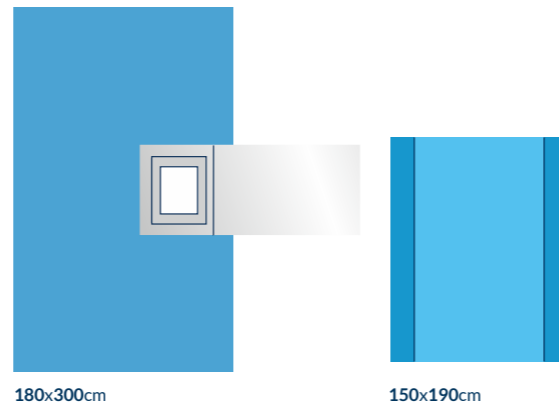

AT-S-CSEC1-IF-C C-SECTION SET 1-IF

quantity	dimensions	component
1 pc.	200cm x 320cm	drape with adhesive fenestration 25cm x 30cm filled with an incise film, integrated with fluid collection pouch 75cm x 85cm with tubing ports
4 pcs	30cm x 30cm	absorbent towel
1 pc.	10cm x 50cm	OP tape
1 pc.	75cm x 80cm	absorbent baby towel
1 pc.	80cm x 145cm	Mayo stand cover, reinforced - red
1 pc.	150cm x 190cm	instrument table cover, reinforced

bulk packaging: 10 sets
hydrophobic SMS material
fluid collection pouch 360°

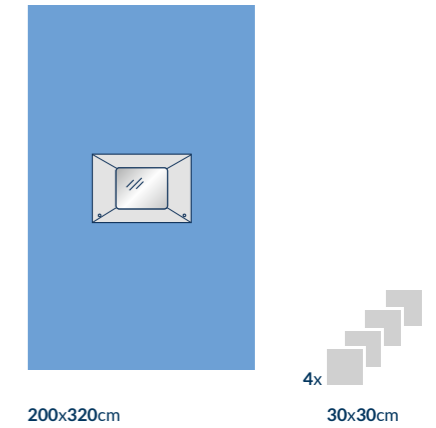

OBSTETRICS

AT-S-CSEC1-C C-SECTION SET 1

quantity	dimensions	component
1 pc.	200cm x 320cm	drape with adhesive fenestration 25cm x 30cm, integrated with fluid collection pouch 75cm x 85cm with tubing ports
4 pcs	30cm x 30cm	absorbent towel
1 pc.	10cm x 50cm	OP tape
1 pc.	75cm x 80cm	absorbent baby towel
1 pc.	80cm x 145cm	Mayo stand cover, reinforced - red
1 pc.	150cm x 190cm	instrument table cover, reinforced

bulk packaging: 10 sets
hydrophobic SMS material
fluid collection pouch 360°

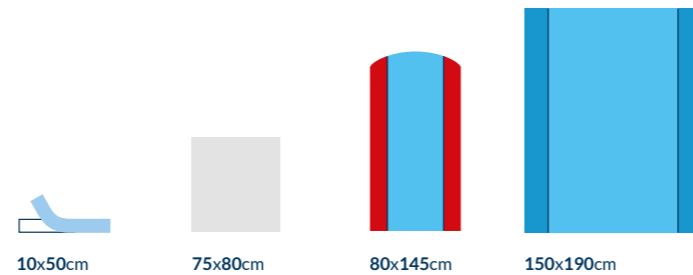
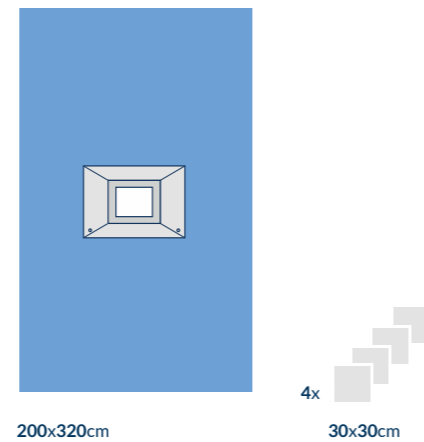

AT-S-CSEC2-IF-C C-SECTION SET 2-IF

quantity	dimensions	component
1 pc.	200cm x 320cm	drape with adhesive fenestration 25cm x 30cm filled with an incise film, integrated with fluid collection pouch 75cm x 85cm with tubing ports
4 pcs	30cm x 30cm	absorbent towel
1 pc.	10cm x 50cm	OP tape
1 pc.	2cm x 22cm	surgical tape, Velcro type
1 pc.	75cm x 80cm	absorbent baby towel
10 pcs	40cm x 40cm	gauze lap sponge with X-ray thread and belt
20 pcs	30cm x 30cm	gauze ball
1 pc.	L	surgical gown STANDARD
3 pcs	XL	surgical gown STANDARD
1 pc.	80cm x 140cm	Mayo stand cover, reinforced - red
1 pc.	150cm x 190cm	instrument table cover, reinforced

bulk packaging: 6 sets
hydrophobic SMS material
fluid collection pouch 360°
PREMIUM set

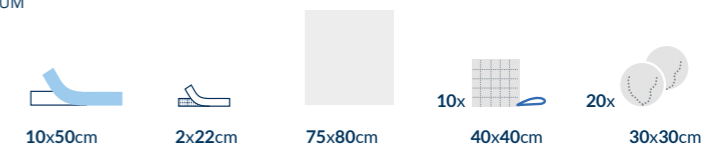
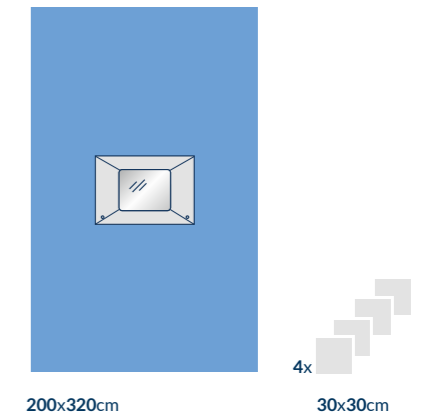

AT-S-CSEC3-IF-SP C-SECTION SET 3-IF

quantity	dimensions	component
1 pc.	180/240cm x 215cm	drape integrated with limb covers, adhesive fenestration 23,5cm x 23,5cm x 22,5cm x 33cm filled with an incise film, integrated with fluid collection pouch 56cm x 80cm with tubing port, reinforced
4 pcs	30cm x 30cm	absorbent towel
1 pc.	10cm x 50cm	OP tape
1 pc.	75cm x 80cm	absorbent baby towel
1 pc.	80cm x 140cm	Mayo stand cover, reinforced - red
1 pc.	150cm x 190cm	instrument table cover, reinforced

bulk packaging: 10 sets

highly absorbent material

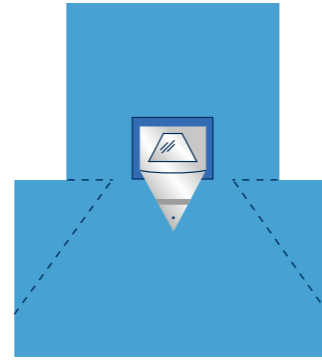

180/240x215cm

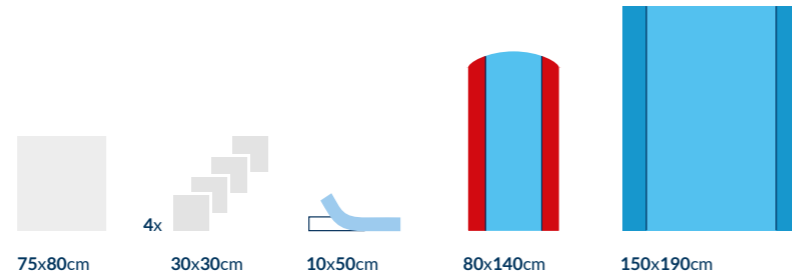

AT-S-DEL1-S DELIVERY SET 1

quantity	dimensions	component
1 pc.	90cm x 120cm	drape without adhesive edge
2 pcs	30cm x 30cm	absorbent towel
3 pcs	75cm x 80cm	absorbent baby towel
1 pc.	60cm x 90cm	absorbent underpad
1 pc.	80cm x 130cm	foil apron
2 pcs	-	umbilical cord clamp

bulk packaging: 20 sets

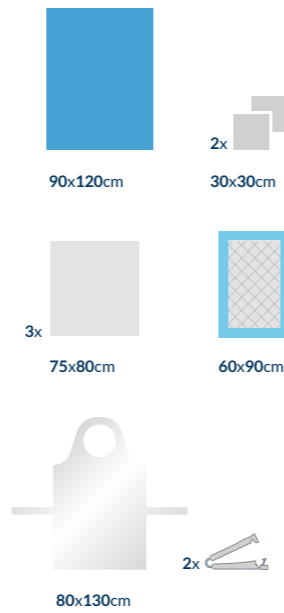

AT-S-DEL2-S DELIVERY SET 2

quantity	dimensions	component
2 pcs	90cm x 120cm	drape without adhesive edge
6 pcs	30cm x 30cm	absorbent towel
1 pc.	75cm x 80cm	absorbent baby towel
2 pcs	60cm x 90cm	absorbent underpad

bulk packaging: 20 sets

STERILE R, LATEX, PHZ, 5 YEARS SHELF LIFE

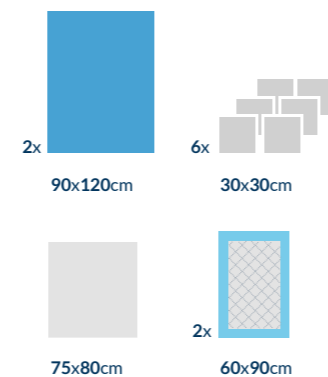

AT-S-DEL3-S DELIVERY SET 3

quantity	dimensions	component
1 pc.	90cm x 120cm	drape without adhesive edge
2 pcs	30cm x 30cm	absorbent towel
3 pcs	75cm x 80cm	absorbent baby towel
1 pc.	60cm x 90cm	absorbent underpad
1 pc.	80cm x 130cm	foil apron
2 pcs	-	umbilical cord clamp
10 pcs	30cm x 30cm	gauze ball

bulk packaging: 20 sets

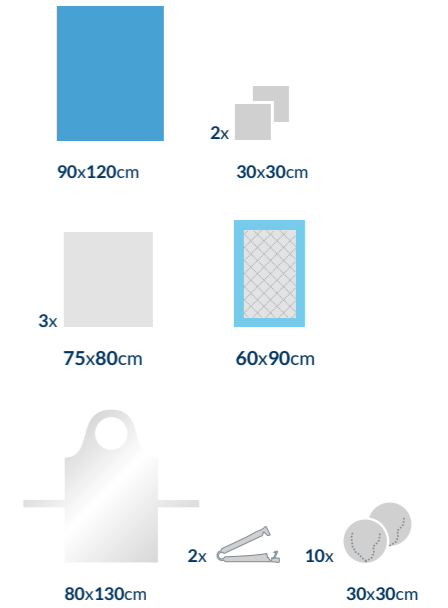

AT-S-DEL4-S DELIVERY SET 4

quantity	dimensions	component
2 pcs	90cm x 120cm	drape without adhesive edge
6 pcs	30cm x 30cm	absorbent towel
1 pc.	75cm x 80cm	absorbent baby towel
1 pc.	60cm x 90cm	absorbent underpad
1 pc.	80cm x 130cm	foil apron
2 pcs	-	umbilical cord clamp

bulk packaging: 22 sets

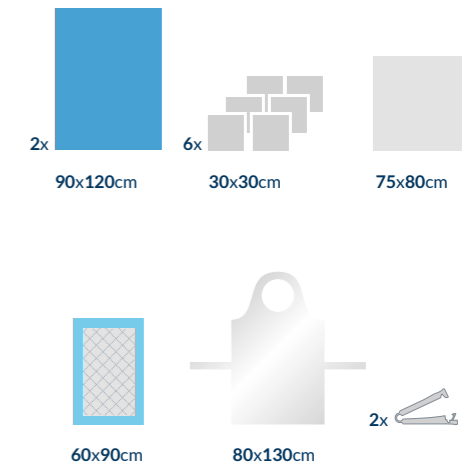

AT-S-DEL5-SP DELIVERY SET 5

quantity	dimensions	component
1 pc.	114cm x 150cm	delivery drape integrated with fluid collection pouch 78cm x 80cm with formable moldler, filter and tubing port, reinforced
2 pcs	30cm x 30cm	absorbent towel
1 pc.	75cm x 80cm	absorbent baby towel
1 pc.	150cm x 190cm	instrument table cover, reinforced

bulk packaging: 18 sets

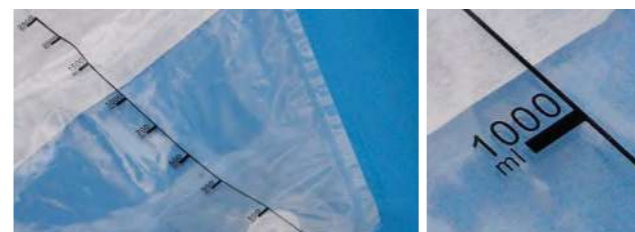

pouch with a very large scale

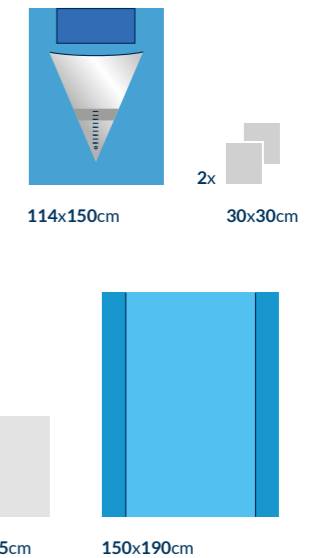

AT-S-OPHT2-IF-C OPTHALMIC SET 2-IF

quantity	dimensions	component
1 pc.	120cm x 170cm	ophthalmic drape with fenestration 10cm x 10cm filled with an incise film, integrated with 2 fluid collection pouches and with 1 formable molder, reinforced
2 pcs	30cm x 30cm	absorbent towel
1 pc.	40cm x 65cm	Phaco tray cover
2 pcs	35cm x 75cm	armboard cover
1 pc.	80cm x 145cm	Mayo stand cover, reinforced - red
1 pc.	150cm x 190cm	instrument table cover, reinforced

bulk packaging: 12 sets
hydrophobic SMS material

STERILE R LATEX PHIT 5 YEARS SHELF LIFE

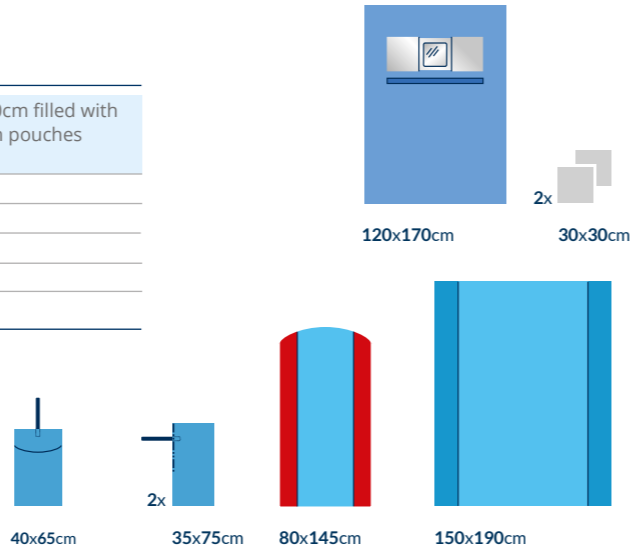

AT-S-OPHT3-IF-C OPTHALMIC SET 3-IF

quantity	dimensions	component
1 pc.	140cm x 240cm	ophthalmic drape with fenestration 10cm x 10cm filled with an incise film, integrated with 2 fluid collection pouches and with 1 formable molder, reinforced
4 pcs	30cm x 30cm	absorbent towel
1 pc.	40cm x 65cm	Phaco tray cover
2 pcs	35cm x 75cm	armboard cover
1 pc.	L	surgical gown STANDARD
1 pc.	XL	surgical gown STANDARD
1 pc.	80cm x 145cm	Mayo stand cover, reinforced - red
1 pc.	150cm x 190cm	instrument table cover, reinforced

bulk packaging: 10 sets
hydrophobic SMS material

PREMIUM set

STERILE R LATEX PHIT 5 YEARS SHELF LIFE

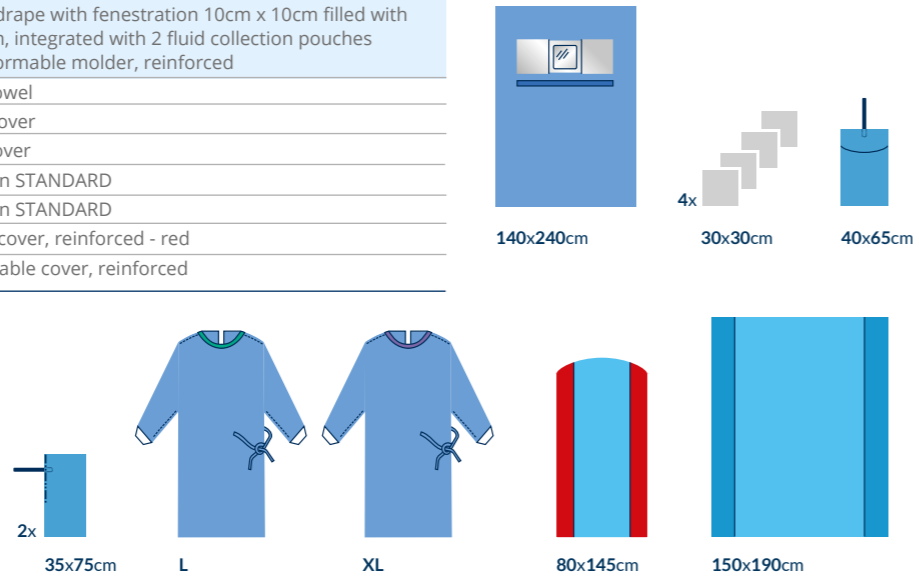

AT-S-OTOL1-C OTOLARYNGOLOGY SET 1

quantity	dimensions	component
1 pc.	200cm x 280cm	drape with adhesive fenestration ø 10cm, reinforced
2 pcs	30cm x 30cm	absorbent towel
1 pc.	10cm x 50cm	OP tape
1 pc.	150cm x 190cm	instrument table cover, reinforced

bulk packaging: 20 sets
hydrophobic SMS material
highly absorbent material

STERILE R LATEX PHIT 5 YEARS SHELF LIFE

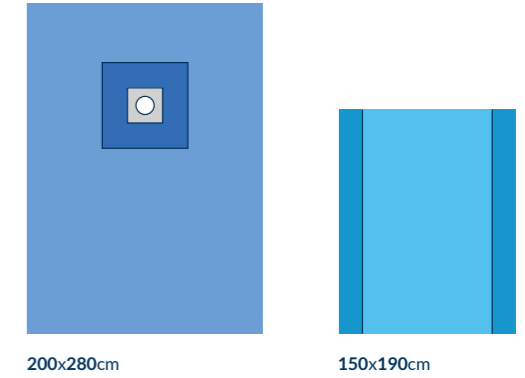

AT-S-OTOL2-C OTOLARYNGOLOGY SET 2

quantity	dimensions	component
1 pc.	150cm x 200cm	drape with adhesive U-split 6cm x 65cm, reinforced
1 pc.	150cm x 180cm	drape with adhesive edge
1 pc.	75cm x 90cm	drape with adhesive edge
4 pcs	30cm x 30cm	absorbent towel
1 pc.	10cm x 50cm	OP tape
1 pc.	80cm x 145cm	Mayo stand cover, reinforced - red
1 pc.	150cm x 190cm	instrument table cover, reinforced

bulk packaging: 12 sets
hydrophobic SMS material
highly absorbent material

STERILE R LATEX PHIT 5 YEARS SHELF LIFE

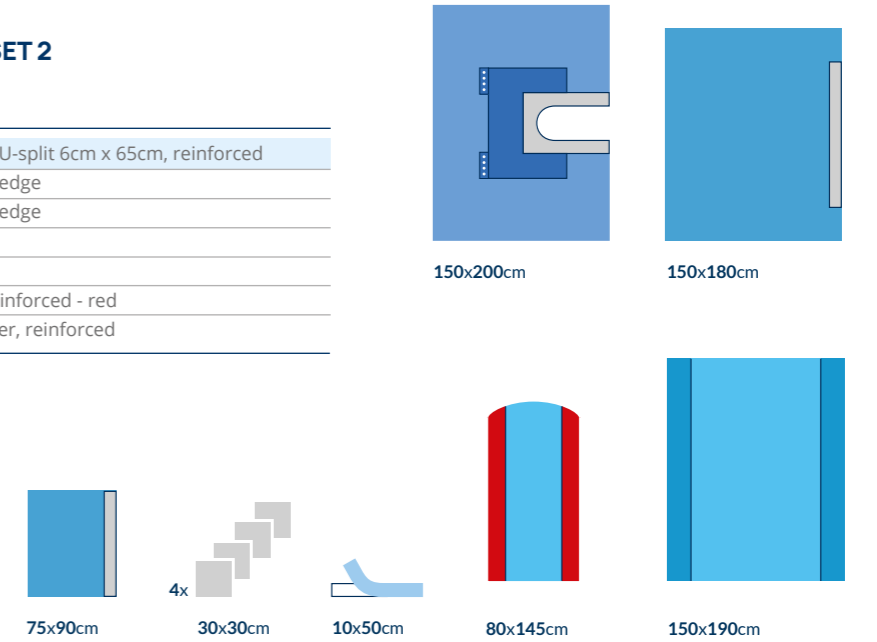

AT-S-CRA1-IF-SP CRANIOTOMY SET 1-IF

quantity	dimensions	component
1 pc.	230cm x 300cm	drape with adhesive fenestration 20cm x 30cm filled with an incise film, with fluid collection pouch, reinforced
4 pcs	50cm x 50cm	drape with adhesive edge
2 pcs	30cm x 30cm	absorbent towel
1 pc.	10cm x 50cm	OP tape
1 pc.	2cm x 25cm	surgical tape, velcro type
1 pc.	80cm x 145cm	Mayo stand cover, reinforced
1 pc.	150cm x 190cm	instrument table cover, reinforced

bulk packaging: 16 sets
head surgery
highly absorbent material

STERILE R LATEX PHIT 5 YEARS SHELF LIFE

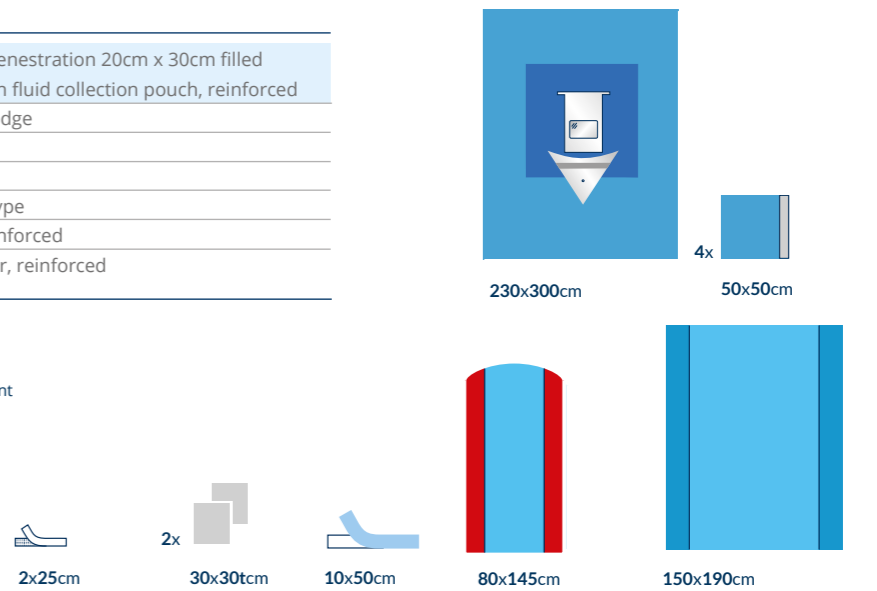

**CARDIOSURGERY
AND ANGIOGRAPHY**

AT-S-ABL1-IF-SP ABLATION SET 1-IF

quantity	dimensions	component
1 pc.	180cm x 305cm	drape with 2 adhesive fenestrations 12cm x 15cm filled with an incise film, reinforced
2 pcs	30cm x 30cm	absorbent towel
1 pc.	ø 80cm	circular banded cover for medical equipment
1 pc.	XL	surgical gown STANDARD
1 pc.	150cm x 190cm	instrument table cover, reinforced

bulk packaging: 12 sets

highly absorbent material

STERILE R

LATEX FREE

RHT

5 YEARS SHELF LIFE

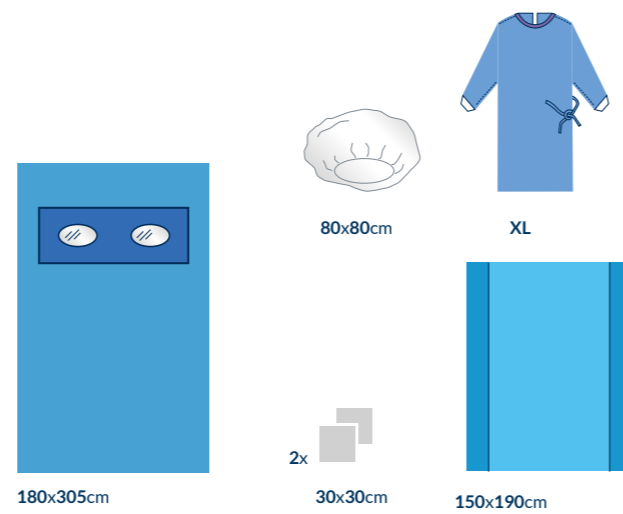

ZARYS



WWW.ZARYS.COM

AT-S-ANG2-C ANGIOGRAPHY SET 2

quantity	dimensions	component
1 pc.	220cm x 320cm	drape with 2 adhesive fenestrations ø 10cm, integrated with transparent foil inserts protecting the control panel reinforced
1 pc.	10cm x 50cm	OP tape
1 pc.	XL	surgical gown STANDARD
1 pc.	100cm x 150cm	drape without adhesive edge
1 pc.	100cm x 150cm	instrument table cover, reinforced

bulk packaging: 10 sets

hydrophobic SMS material

highly absorbent material

STERILE R

LATEX FREE

RHT

5 YEARS SHELF LIFE

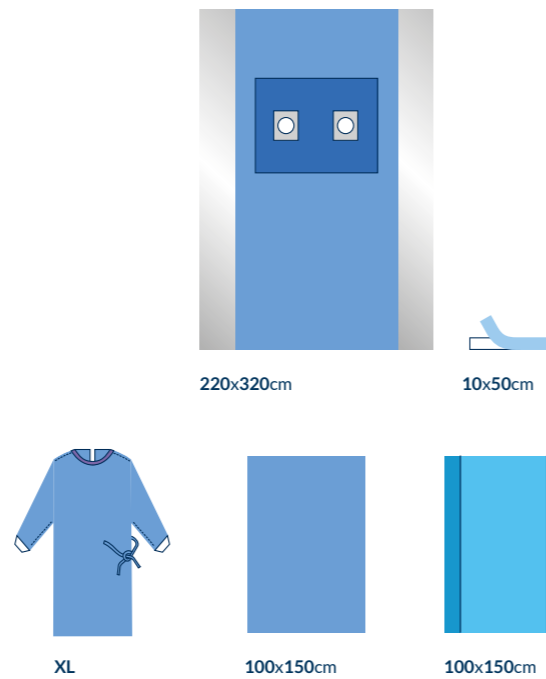

AT-S-ANG3-SP ANGIOGRAPHY SET 3



quantity	dimensions	component
1 pc.	240cm x 350cm	drape with 2 adhesive femoral fenestrations ø 9,5cm and 2 adhesive radial fenestrations of 6cm x 9cm, integrated with transparent foil inserts protecting the control panel, reinforced
1 pc.	30cm x 30cm	absorbent towel
1 pc.	100cm x 150cm	instrument table cover, reinforced

bulk packaging: 20 sets

hydrophobic SMS material

highly absorbent material

drape available in a Omegapack

STERILE R

LATEX FREE

RHT

5 YEARS SHELF LIFE

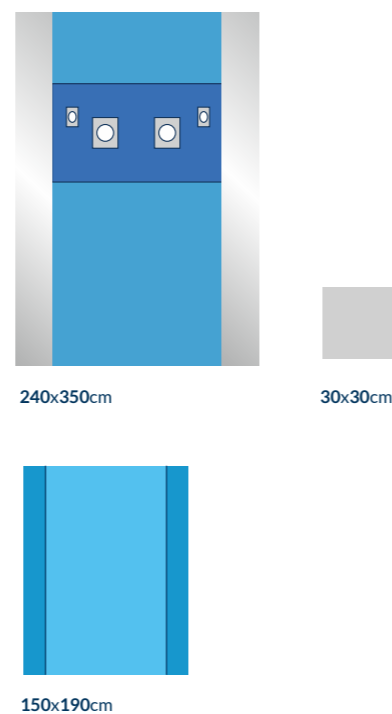

**SURGICAL
GOWNS**

STERILE GOWN NORMAL

REF	size	trimming	packaging unit
AT-SGN-L	L		1 pc.
AT-SGN-XL	XL		1 pc.

bulk packaging: 25 pcs

includes 1 absorbent towel 40cm x 40cm

22 g/m²

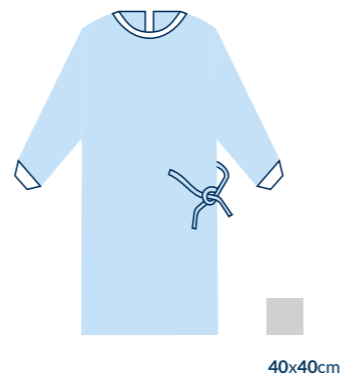

40x40cm

STERILE SURGICAL GOWN STANDARD

REF	size	trimming	packaging unit
AT-SGS-M	M		1 pc.
AT-SGS-L	L		1 pc.
AT-SGS-XL	XL		1 pc.
AT-SGS-XXL	XXL		1 pc.

bulk packaging: 25 pcs

includes 2 absorbent towels 30cm x 30cm

45 g/m²

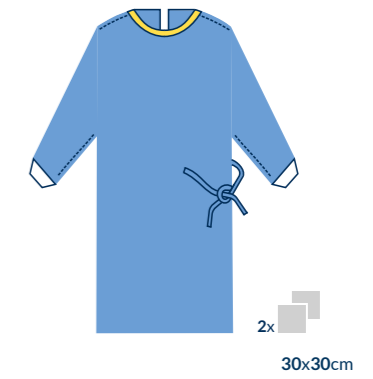

2x 30x30cm

STERILE SURGICAL GOWN STANDARD

REF	size	trimming	packaging unit
AT-SGS-M 1	M		1 pc.
AT-SGS-L 1	L		1 pc.
AT-SGS-XL 1	XL		1 pc.
AT-SGS-XXL 1	XXL		1 pc.
AT-SGS-XXXL 1	XXXL		1 pc.

bulk packaging: 25 pcs

includes 2 absorbent towels 30cm x 30cm

35 g/m²

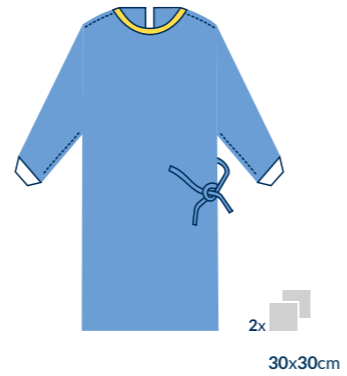

2x 30x30cm

STERILE SURGICAL GOWN STANDARD PLUS

REF	size	trimming	packaging unit
AT-SGSP-M 1	M		1 pc.
AT-SGSP-L 1	L		1 pc.
AT-SGSP-XL 1	XL		1 pc.
AT-SGSP-XXL 1	XXL		1 pc.
AT-SGSP-XXXL 1	XXXL		1 pc.

bulk packaging: 25 pcs

includes 2 absorbent towels 30cm x 30cm

35 g/m²

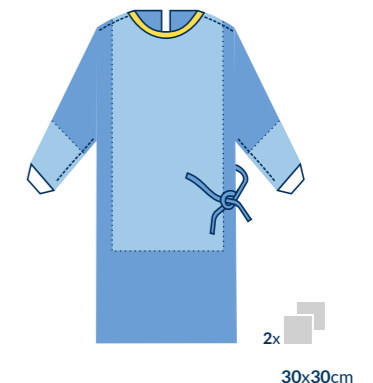

2x 30x30cm

STERILE SURGICAL GOWN STANDARD

REF	size	trimming	packaging unit
AT-SGS-M 1E	M		1 pc.
AT-SGS-L 1E	L		1 pc.
AT-SGS-XL 1E	XL		1 pc.
AT-SGS-XXL 1E	XXL		1 pc.

bulk packaging: 25 pcs

without 2 absorbent towels 30cm x 30cm

economic version

35 g/m²

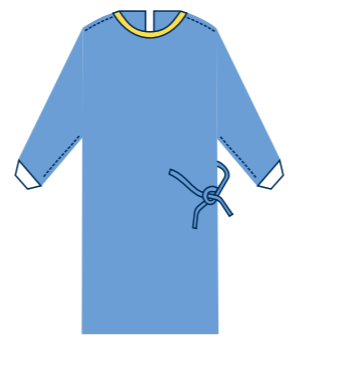

STERILE SURGICAL GOWN STANDARD PLUS

REF	size	trimming	packaging unit
AT-SGSP-M 1E	M		1 pc.
AT-SGSP-L 1E	L		1 pc.
AT-SGSP-XL 1E	XL		1 pc.
AT-SGSP-XXL 1E	XXL		1 pc.

bulk packaging: 25 pcs

without 2 absorbent towels 30cm x 30cm

economic version

35 g/m²



STERILE SURGICAL GOWN STANDARD

REF	size	trimming	packaging unit
AT-SGS-M 2	M		1 pc.
AT-SGS-L 2	L		1 pc.
AT-SGS-XL 2	XL		1 pc.
AT-SGS-XXL 2	XXL		1 pc.

bulk packaging: 25 pcs

includes 2 absorbent towels 30cm x 30cm

40 g/m²

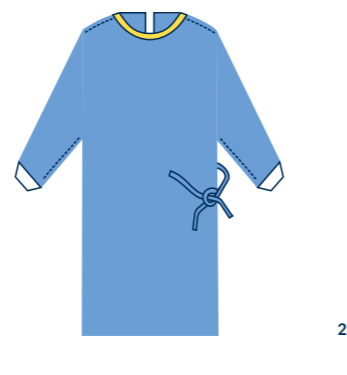

2x 30x30cm

STERILE SURGICAL GOWN STANDARD PLUS



REF	size	trimming	packaging unit
AT-SGSP-M 2	M		1 pc.
AT-SGSP-L 2	L		1 pc.
AT-SGSP-XL 2	XL		1 pc.
AT-SGSP-XXL 2	XXL		1 pc.

bulk packaging: 25 pcs

includes 2 absorbent towels 30cm x 30cm

40 g/m²

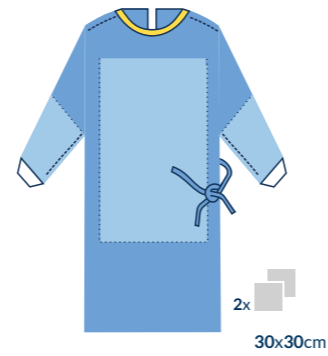

2x
30x30cm

STERILE SURGICAL GOWN COMFORT PLUS

REF	size	trimming	packaging unit
AT-SGCP-M	M		1 pc.
AT-SGCP-L	L		1 pc.
AT-SGCP-XL	XL		1 pc.
AT-SGCP-XXL	XXL		1 pc.

bulk packaging: 25 pcs

includes 2 absorbent towels 30cm x 30cm

68 g/m²

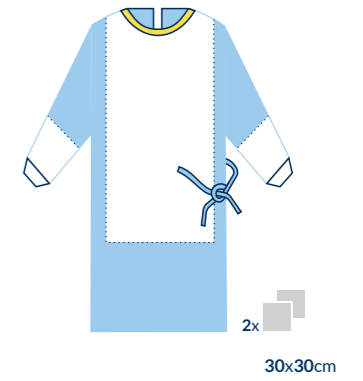

2x
30x30cm

STERILE SURGICAL GOWN STANDARD PLUS

REF	size	trimming	packaging unit
AT-SGSP-M	M		1 pc.
AT-SGSP-L	L		1 pc.
AT-SGSP-XL	XL		1 pc.
AT-SGSP-XXL	XXL		1 pc.

bulk packaging: 25 pcs

includes 2 absorbent towels 30cm x 30cm

45 g/m²

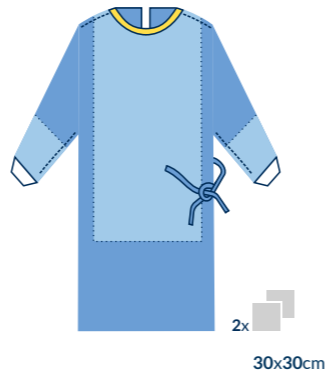

2x
30x30cm

NON-STERILE SURGICAL GOWNS

REF	size	trimming	packaging unit
AT-NS-SGS-M 1E	M		1 pc.
AT-NS-SGS-L 1E	L		1 pc.
AT-NS-SGS-XL 1E	XL		1 pc.
AT-NS-SGS-XXL 1E	XXL		1 pc.

bulk packaging: 50 pcs

35 g/m²

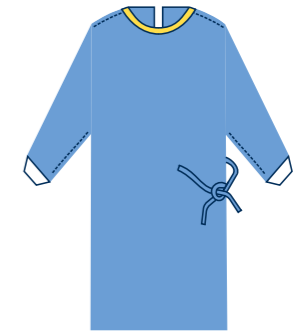

STERILE SURGICAL GOWN EXTRA SAFE BESTSELLER

REF	size	trimming	packaging unit
AT-SGES-XXL 1	XXL		1 pc.

bulk packaging: 25 pcs

includes 2 absorbent towels 30cm x 30cm

extended style

35 g/m²



2x
30x30cm

NON-STERILE SURGICAL GOWN PREMIUM

REF	size	trimming	packaging unit
AT-NS-SGP-L 1E	L		10 pcs
AT-NS-SGP-XL 1E	XL		10 pcs

bulk packaging: 10 x 10 pcs

fully reinforced PP+PE

meet the standards of EN 14126

35 g/m²

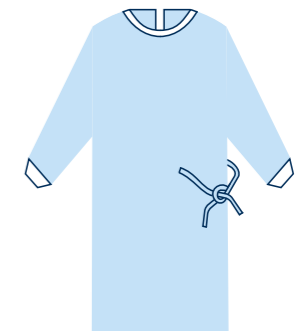

STERILE SURGICAL GOWN COMFORT

REF	size	trimming	packaging unit
AT-SGC-M	M		1 pc.
AT-SGC-L	L		1 pc.
AT-SGC-XL	XL		1 pc.
AT-SGC-XXL	XXL		1 pc.

bulk packaging: 25 pcs

includes 2 absorbent towels 30cm x 30cm

68 g/m²

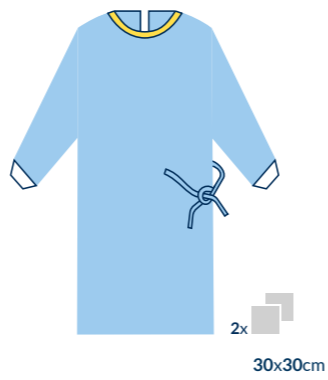

2x
30x30cm

It is extremely important for us to offer our clients products that ensure high standards of working conditions and comfort of use.

In order to achieve this goal, we have created a line of high quality products made of different types of non-woven materials:

- polypropylene non-woven
- SMS non-woven
- Spunlace non-woven
- viscose non-woven
- Spunlace Mesh non-woven

A combination of several factors such as optimal design, perfect fit, breathability and structure makes BETAtex products comfortable and reliable. A wide range of solutions will certainly meet our clients' individual preferences and secure extreme comfort and safety for the Medical Personnel and the Patients.

 **BETAtex**
medical
clothing

medical gowns | surgical clothing | caps and protective masks | patient clothing | shoe covers | bedclothes and absorbent underpads



ZARYS



WWW.ZARYS.COM

MEDICAL GOWNS

MEDICAL GOWN with elastic cuffs, non-woven

features

- made of polypropylene non-woven 20 g/m², 25 g/m², 30 g/m² or 40 g/m²
- ties at waist and neck
- long sleeves with elastic cuffs
- breathable
- available sizes: L, XL
- single-use

REF	grammage	size	colour	packaging unit
BT-019-20B3-L	20 g/m ²	L	blue	10 pcs
BT-019-20B4-XL	20 g/m ²	XL	blue	10 pcs
BT-019-20G3-L	20 g/m ²	L	green	10 pcs
BT-019-20G4-XL	20 g/m ²	XL	green	10 pcs
*BT-019-20W3-L	20 g/m ²	L	white	10 pcs
BT-019-25B3-L	25 g/m ²	L	blue	10 pcs
BT-019-25B4-XL	25 g/m ²	XL	blue	10 pcs
BT-019-25G3-L	25 g/m ²	L	green	10 pcs
BT-019-25G4-XL	25 g/m ²	XL	green	10 pcs
*BT-019-25W3-L	25 g/m ²	L	white	10 pcs
*BT-019-30W3-L	30 g/m ²	L	white	10 pcs
*BT-019-30G3-L	30 g/m ²	L	green	10 pcs
*BT-019-30G4-XL	30 g/m ²	XL	green	10 pcs
*BT-019-30B3-L	30 g/m ²	L	blue	10 pcs
*BT-019-40B3-L	40 g/m ²	L	blue	10 pcs
*BT-019-40G3-L	40 g/m ²	L	green	10 pcs

bulk packaging:
10 x 10 pcs

available colours:
● ● ●

* available
on request



MEDICAL GOWN with knitted cuffs, non-woven

features

- made of polypropylene non-woven 20 g/m², 25 g/m², 30 g/m² or 40 g/m²
- ties at waist and neck
- long sleeves with knitted cuffs
- breathable
- available sizes: L, XL, XXL
- single-use

REF	grammage	size	colour	packaging unit
BT-015-20G3-L	20 g/m ²	L	green	10 pcs
BT-015-20G4-XL	20 g/m ²	XL	green	10 pcs
BT-015-25G3-L	25 g/m ²	L	green	10 pcs
BT-015-25B3-L	25 g/m ²	L	blue	10 pcs
BT-015-25G4-XL	25 g/m ²	XL	green	10 pcs
BT-015-30G3-L	30 g/m ²	L	green	10 pcs
BT-015-30G4-XL	30 g/m ²	XL	green	10 pcs
BT-015-30G5-XXL	30 g/m ²	XXL	green	10 pcs
BT-015-40G3-L	40 g/m ²	L	green	10 pcs
BT-015-40B3-L	40 g/m ²	L	blue	10 pcs
BT-015-40G4-XL	40 g/m ²	XL	green	10 pcs

bulk packaging:
10 x 10 pcs

available colours:
● ●



ZARYS



WWW.ZARYS.COM

SURGICAL CLOTHING

SURGICAL SUIT

PP short-sleeved shirt+trousers, non-woven

features

- made of SMS non-woven 35 g/m²
- short-sleeved shirt with V-neck and 3 pockets
- trousers with guiding ties
- blue shirt and trousers available also in individual packaging
- single-use

SET (SHIRT + TROUSERS)

REF	size	colour	packaging unit
BT-017-S35B1-S-SMS	S	blue	1 set
BT-017-S35B2-M-SMS	M	blue	1 set
BT-017-S35B3-L-SMS	L	blue	1 set
BT-017-S35B4-XL-SMS	XL	blue	1 set
BT-017-S35B5-XXL-SMS	XXL	blue	1 set
BT-017-S35B6-XXXL-SMS	XXXL	blue	1 set
BT-017-S35B7-XXXXL-SMS	XXXXL	blue	1 set
BT-017-S35G1-S-SMS	S	green	1 set
BT-017-S35G2-M-SMS	M	green	1 set
BT-017-S35G3-L-SMS	L	green	1 set
BT-017-S35G4-XL-SMS	XL	green	1 set
BT-017-S35G5-XXL-SMS	XXL	green	1 set
BT-017-S35V1-S-SMS	S	purple	1 set
*BT-017-S35V2-M-SMS	M	purple	1 set
*BT-017-S35V3-L-SMS	L	purple	1 set
*BT-017-S35V4-XL-SMS	XL	purple	1 set
*BT-017-S35V5-XXL-SMS	XXL	purple	1 set

SHIRT

REF	size	colour	packaging unit
*BT-018-S35B1-S-SMS	S	blue	1 pc.
*BT-018-S35B2-M-SMS	M	blue	1 pc.
*BT-018-S35B3-L-SMS	L	blue	1 pc.
*BT-018-S35B4-XL-SMS	XL	blue	1 pc.
*BT-018-S35B5-XXL-SMS	XXL	blue	1 pc.

TROUSERS

REF	size	colour	packaging unit
*BT-018-T35B1-S-SMS	S	blue	1 pc.
*BT-018-T35B2-M-SMS	M	blue	1 pc.
*BT-018-T35B3-L-SMS	L	blue	1 pc.
*BT-018-T35B4-XL-SMS	XL	blue	1 pc.
*BT-018-T35B5-XXL-SMS	XXL	blue	1 pc.

 bulk packaging:
50 x 1 set

 available colours:

 available
on request



SURGICAL SHIRT SHORT-SLEEVED

non-woven

features

- made of soft polypropylene non-woven 47 g/m²
- short sleeves
- 3 big pockets
- **snap fastener at the neck**
- single-use

REF	size	packaging unit
BT-018-S47B0-XS-SOFT2	XS	1 pc.
BT-018-S47B1-S-SOFT2	S	1 pc.
BT-018-S47B2-M-SOFT2	M	1 pc.
BT-018-S47B3-L-SOFT2	L	1 pc.
BT-018-S47B4-XL-SOFT2	XL	1 pc.
BT-018-S47B5-XXL-SOFT2	XXL	1 pc.
BT-018-S47B6-XXXL-SOFT2	XXXL	1 pc.
BT-018-S47B7-XXXXL-SOFT2	XXXXL	1 pc.

 bulk packaging:
50 x 1 pc.

 available colours:



SURGICAL TROUSERS, WITH TIES

non-woven

features

- made of soft polypropylene non-woven 47 g/m²
- trousers with guiding ties
- 1 big pocket with snap fastener
- single-use

REF	size	packaging unit
BT-018-T47B0-XS-SOFT1	XS	1 pc.
BT-018-T47B1-S-SOFT1	S	1 pc.
BT-018-T47B2-M-SOFT1	M	1 pc.
BT-018-T47B3-L-SOFT1	L	1 pc.
BT-018-T47B4-XL-SOFT1	XL	1 pc.
BT-018-T47B5-XXL-SOFT1	XXL	1 pc.
BT-018-T47B6-XXXL-SOFT1	XXXL	1 pc.
BT-018-T47B7-XXXXL-SOFT1	XXXXL	1 pc.

 bulk packaging:
50 x 1 pc.

 available colours:



SURGICAL SHIRT LONG-SLEEVED

non-woven

features

- made of soft polypropylene non-woven 47 g/m²
- long sleeves with knitted cuffs
- 2 big pockets
- **snap fasteners at the front**
- single-use

REF	size	packaging unit
BT-018-O47B1-S-SOFT3	S	1 pc.
BT-018-O47B2-M-SOFT3	M	1 pc.
BT-018-O47B3-L-SOFT3	L	1 pc.
BT-018-O47B4-XL-SOFT3	XL	1 pc.
BT-018-O47B5-XXL-SOFT3	XXL	1 pc.

 bulk packaging:
50 x 1 pc.

 available colours:





CAPS, PROTECTIVE MASKS

MEDICAL BOUFFANT CAP

PP non-woven

features

- cap with an elastic rubber band
- diameter: approx. 53 cm
- made of airy polypropylene non-woven
- excellent breathability and wearing comfort
- packaging: ergonomic cardboard box to remove individual pieces
- single-use

REF	colour	packaging unit
BT-008-18G	green	100 pcs
BT-008-18B	blue	100 pcs

 bulk packaging:
10 x 100 pcs

 available colours:
 



DONA

medical bouffant cap

features

- cap with an elastic rubber band
- diameter: approx. 47 cm
- made of perforated viscose non-woven
- excellent breathability and wearing comfort
- packaging: ergonomic cardboard box to remove individual pieces
- single-use

REF	colour	packaging unit
BT-008-25G-B1-V	green	100 pcs
BT-008-25B-B1-V	blue	100 pcs
BT-008-25G-B1-V-XL	green	100 pcs

 bulk packaging:
4 x 100 pcs

 available colours:
 



LILI

medical cap with rubber

features

- cap with an elastic rubber band in the back part
- made of perforated viscose non-woven
- excellent breathability and wearing comfort
- packaging: ergonomic cardboard box to remove individual pieces
- single-use

REF	colour	packaging unit
BT-001-25G-R1-V	green	100 pcs
BT-001-25B-R1-V	blue	100 pcs

 bulk packaging:
6 x 100 pcs

 available colours:
 



POLA

medical cap with rubber

features

- cap with an elastic rubber band in the back part
- made of durable Spunlace and polypropylene non-woven
- the used non-woven is characterized by good absorption properties and durability and additionally it is pleasant to the touch, which increases comfort while using
- excellent breathability and wearing comfort
- packaging: ergonomic cardboard box to remove individual pieces
- single-use

REF	packaging unit
BT-001-45B-SPN	100 pcs



NINO

medical cap

features

- cap without rubber or ties, designed for short-haired people
- two layers of non-woven fabric in the side part
- made of perforated viscose non-woven
- excellent breathability and wearing comfort
- packaging: ergonomic cardboard box to remove individual pieces
- single-use

REF	colour	packaging unit
BT-001-25G-D-V	green	100 pcs
BT-001-25B-D-V	blue	100 pcs



SOL

medical cap with ties

features

- cap with ties at the back
- made of perforated viscose non-woven
- excellent breathability and wearing comfort
- packaging: ergonomic cardboard box to remove individual pieces
- single-use

REF	colour	packaging unit
BT-007-25G-T1-V	green	100 pcs
BT-007-25B-T1-V	blue	100 pcs



KOKO long

medical cap with snood

features

- cap with snood and elastic rubber band in the back part
- optimal protection for long-haired people
- made of perforated viscose non-woven
- excellent breathability and wearing comfort
- packaging: ergonomic cardboard box to remove individual pieces
- single-use

REF	colour	packaging unit
BT-001-25G-S1-V	green	100 pcs
BT-001-25B-S1-V	blue	100 pcs



ABI

medical cap with ties

features

- deep cap with ties at the back
- being folded out, the front part creates an additional layer protecting against sweat
- made of perforated viscose non-woven
- excellent breathability and wearing comfort
- packaging: ergonomic cardboard box to remove individual pieces
- single-use

REF	colour	packaging unit
BT-007-25G-T2-V	green	100 pcs
BT-007-25B-T2-V	blue	100 pcs



DORA long

medical cap with snood

features

- cap with anti-sweat insert in the forehead area
- special design allows the cap to adjust to the shape of the head and keep one's hair in an excellent manner
- optimal protection for long-haired people
- made of Spunlace and polypropylene non-woven
- excellent breathability and wearing comfort
- packaging: ergonomic cardboard box to remove individual pieces
- single-use

REF	packaging unit
BT-001-45B-S-SPN	50 pcs

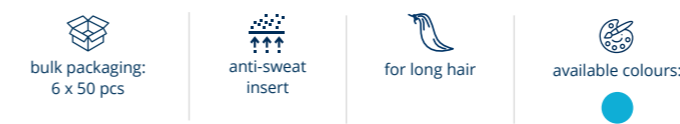

BEN

medical cap with ties

features

- forage cap with ties at the back
- made of perforated Spunlace Mesh non-woven
- excellent breathability and comfort of use
- single-use

REF	packaging unit
BT-007-35B-SPNM	100 pcs



MAYA

medical cap with rubber

NEW

features

- made of polypropylene non-woven 30 g/m²
- forage cap
- cap with an elastic rubber band in the back part
- packaging: ergonomic cardboard box to remove individual pieces
- single-use

REF	packaging unit
BT-007-30C-R1-PP	100 pcs

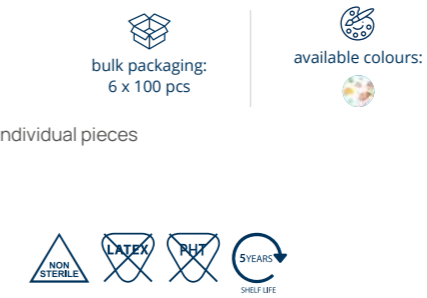

TOM

medical cap with ties

features

- cap with ties at the back
- anti-sweat insert on the whole circumference
- made of polypropylene non-woven 20 g/m²
- packaging: ergonomic cardboard box to remove individual pieces
- single-use

REF	packaging unit
BT-007-P20G	100 pcs



MEDICAL MASK with ties

features

- made of three layers of dust-free and hypoallergenic non-woven
- modelling nose-piece
- protects operative field against exfoliated epidermis, hair and droplet infections
- provides effective protection in patients against infections transmitted from personnel's mouths and noses
- packaging: ergonomic cardboard box to remove individual pieces
- single-use

REF	colour	packaging unit
BT-046-32G	green	50 pcs
BT-046-32B	blue	50 pcs

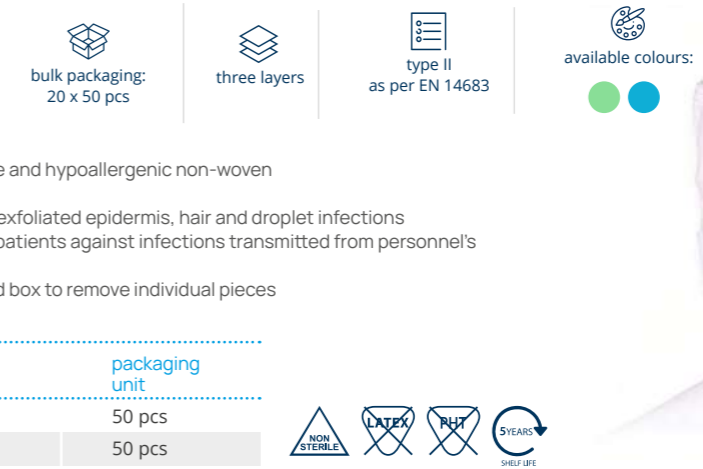

ROS

medical cap with ties

features

- cap with ties at the back
- anti-sweat insert in the forehead area
- made of Spunlace and polypropylene non-woven
- packaging: ergonomic cardboard box to remove individual pieces
- single-use

REF	packaging unit
BT-007-P45B	50 pcs



MEDICAL MASK with earloops

features

- made of three layers of dust-free and hypoallergenic non-woven
- modelling nose-piece
- splash resistant
- protects operative field against exfoliated epidermis, hair and droplet infections
- provides effective protection in patients against infections transmitted from personnel's mouths and noses
- packaging: ergonomic cardboard box to remove individual pieces
- single-use

REF	colour	type in accordance with the standard EN 14683	packaging unit
BT-046-31G	green	type II	50 pcs
BT-046-31B	blue	type II	50 pcs
BT-046-R31B	blue	type II R	50 pcs

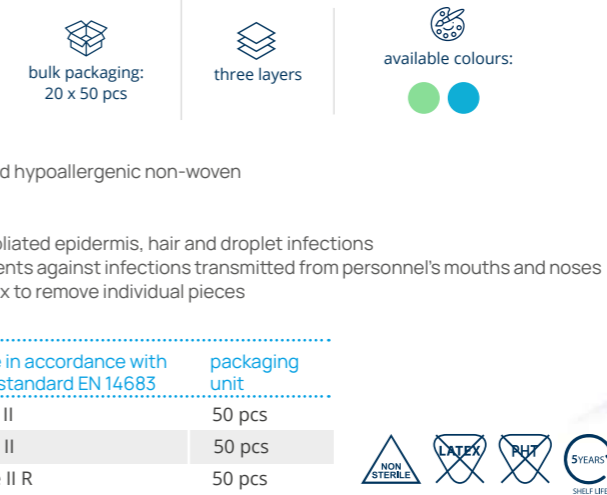

OLAF

medical cap with ties

NEW

features

- made of polypropylene non-woven 30 g/m²
- forage cap
- cap with ties at the back
- packaging: ergonomic cardboard box to remove individual pieces
- single-use

REF	packaging unit
BT-007-30C-T1-PP	100 pcs



MEDICAL MASK with earloops

NEW

features

- made of three layers of non-woven
- modeling nose-piece
- bacteria filtration efficiency BFE ≥ 98%
- packaging: ergonomic cardboard box to remove individual pieces
- single-use

REF	colour	type in accordance with the standard EN 14683	packaging unit
BT-046-31C	pattern	type II	50 pcs

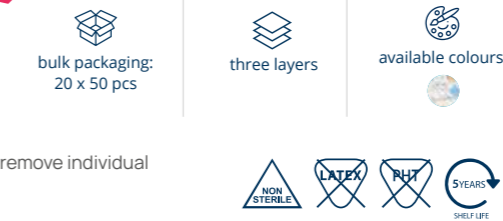

ZARYS



WWW.ZARYS.COM

PATIENT CLOTHING

PATIENT'S GOWN tied-up, non-woven

features

- made of SMS non-woven
- short sleeves
- white ties at waist and neck
- easy putting on and taking off in bed-ridden patients
- universal size
- single-use

REF	material	size	grammage	colour	packaging unit
BT-0022-33B-SMS	SMS non-woven	universal	33 g/m ²	blue	10 pcs

 bulk packaging:
10 x 10 pcs

available colours:



PATIENT'S GOWN Y-neck, non-woven

features

- made of polypropylene non-woven
- short sleeves and Y-neck
- slipover
- single-use

REF	material	size	grammage	colour	packaging unit
BT-0022-40DB-PP	PP non-woven	universal	40 g/m ²	dark blue	10 pcs

 bulk packaging:
10 x 10 pcs

available colours:





PATIENT'S GOWN V-neck, non-woven

features

- made of Spunlace non-woven
- the used non-woven is characterized by good absorption properties and durability and additionally it is pleasant to the touch, which increases comfort while wearing
- short sleeves and V-neck
- slipover
- single-use

REF	material	size	grammage	colour	packaging unit
BT-0022-45W-SPN	Spunlace non-woven	universal	45 g/m ²	white	10 pcs
BT-0022-45B-SPN	Spunlace non-woven	universal	45 g/m ²	blue	10 pcs

 pleasant for the skin

 bulk packaging:
10 x 10 pcs

available colours:



PATIENT'S GOWN

for delivery, SMS non-woven

features

- made of SMS non-woven
- short sleeves, ties at waist and neck (other models available on request)
- available in 5 sizes: S, M, L, XL, XXL
- single-use

REF	material	size	grammage	packaging unit
BT-0022-35B-SMS-DM-001-S	SMS non-woven	S	35 g/m ²	10 pcs
BT-0022-35B-SMS-DM-001-M	SMS non-woven	M	35 g/m ²	10 pcs
BT-0022-35B-SMS-DM-001-L	SMS non-woven	L	35 g/m ²	10 pcs
BT-0022-35B-SMS-DM-001-XL	SMS non-woven	XL	35 g/m ²	10 pcs
BT-0022-35B-SMS-DM-001-XXL	SMS non-woven	XXL	35 g/m ²	10 pcs



COLONOSCOPY BOXERS

PP non-woven

features

- made of polypropylene non-woven 40 g/m²
- boxers with a slit in the back part
- single-use

REF	material	size	grammage	packaging unit
BT-0023-40DB	PP non-woven	universal	40 g/m ²	10 pcs



PATIENT'S GOWN, FOR CHILDREN

non-woven



features

- made of SMS non-woven 35 g/m²
- white ties at waist and neck
- single-use

REF	size	grammage	packaging unit
BT-0022-35B-SMS-D1	72 cm x 100 cm	35 g/m ²	10 pcs



GYNECOLOGICAL SKIRT

non-woven

features

- made of polypropylene non-woven 40 g/m²
- dimensions: 160 cm (at the waist after stretching)
- single-use

REF	material	size	grammage	packaging unit
BT-0025-40DB	PP non-woven	universal	40 g/m ²	10 pcs



COLONOSCOPY BOXERS

SMS non-woven

features

- made of SMS non-woven 35 g/m²
- boxers with a slit in the back part
- completely opaque
- single-use

REF	material	size	grammage	packaging unit
BT-0023-35B-SMS	SMS non-woven	universal	35 g/m ²	10 pcs
BT-0023-35B-SMS-XL	SMS non-woven	XL	35 g/m ²	10 pcs





SHOE COVERS

SHOE COVERS

features

- made of polyethylene or polypropylene non-woven 30 g/m² or 40 g/m² (for shoe covers with anti-skid layer)
- elastic rubber band at the opening
- protection against contaminating rooms where higher cleanliness standards are required
- increased durability
- single-use

REF	material	grammage	size	colour	packaging unit	bulk packaging
BT-010-G	non-woven	30 g/m ²	38 cm x 17 cm	green	100 pcs	10 x 100 pcs
BT-010-B	non-woven	30 g/m ²	38 cm x 17 cm	blue	100 pcs	10 x 100 pcs
BT-011-B	non-woven with anti-skid layer	40 g/m ²	38 cm x 17 cm	blue	100 pcs	10 x 100 pcs
BT-002-PEB	polyethylene		41 cm x 15 cm	blue	100 pcs	20 x 100 pcs

available colours:



SHOE COVERS

calf-high

features

- made of polypropylene non-woven 30 g/m²
- elastic rubber band at the opening
- protection against contaminating rooms where higher cleanliness standards are required
- increased durability
- single-use

REF	material	grammage	size	packaging unit
BT-013-B	PP non-woven	30 g/m ²	47 cm x 38,5 cm	100 pcs
BT-013-G	PP non-woven	30 g/m ²	47 cm x 38,5 cm	100 pcs

bulk packaging:
10 x 100 pcs

available colours:





BEDCLOTHES, ABSORBENT UNDERPADS

DISPOSABLE MEDICAL BED SHEET

features

- made of polypropylene non-woven, laminated polypropylene non-woven or SMS non-woven
- dimensions: according to customer's specification
- unit packaging: foil, bulk packaging: cardboard box

REF	material	grammage	dimensions*	colour
BT-030-PP-17-„X“ x „Y“ - G (X - width, Y - length)	PP non-woven	17 g/m ²	X cm x Y cm X - width (cm) Y - length (cm)	green
BT-030-PP-25-„X“ x „Y“ - G (X - width, Y - length)	PP non-woven	25 g/m ²		green
BT-030-PP-35-„X“ x „Y“ - G (X - width, Y - length)	PP non-woven	35 g/m ²		green
BT-030-PF-25-„X“ x „Y“ - G (X - width, Y - length)	laminated PP non-woven	25 g/m ²		green
BT-030-PF-45-„X“ x „Y“ - G (X - width, Y - length)	laminated PP non-woven	45 g/m ²		green
BT-030-SMS-35-„X“ x „Y“ - B (X - width, Y - length)	SMS non-woven	35 g/m ²		blue

*according to customer's specification

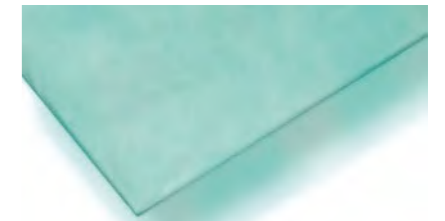

available colours:



DISPOSABLE MEDICAL PILLOW CASE

features

- made of polypropylene non-woven

 bulk packaging:
10 x 50 pcs

available colours:

REF	grammage	size	packaging unit
BT-PP-25G1	25 g/m ²	60cm x 80 cm	50 pcs
BT-PP-25G6	25 g/m ²	80cm x 90 cm	50 pcs



DISPOSABLE MEDICAL QUILT COVER

features

- made of polypropylene non-woven

 bulk packaging:
10 x 10 pcs

available colours:

REF	grammage	size	packaging unit
BT-PZ-25G1	25 g/m ²	160cm x 210 cm	10 pcs



DISPOSABLE MEDICAL BEDDING SET

features

- made of polypropylene non-woven
- components:
 - bed sheet: 150 cm x 210 cm
 - quilt cover: 160 cm x 210 cm
 - pillow case: 70 cm x 80 cm

 bulk packaging:
25 x 1 set

available colours:

REF	grammage	colour	packaging unit
BT-ZES-25G3	25 g/m ²	green	1 set
BT-ZES-40G3	40 g/m ²	green	1 set
BT-ZES-40W3	40 g/m ²	white	1 set



DISPOSABLE ABSORBENT UNDERPAD

features

- composed of five layers: laminate + cellulose wadding + cellulose pulp + cellulose wadding + PP nonwoven
- absorbent insert made of cellulose pulp
- impermeable foiled bottom
- single use

REF	dimensions	packaging unit
BT-PC4060	40 cm x 60 cm	25 pcs
BT-PC6060	60 cm x 60 cm	25 pcs
BT-PC6090	60 cm x 90 cm	25 pcs

 bulk packaging:
4 x 25 pcs



DISPOSABLE ABSORBENT UNDERPAD for operating table

features

- quilted absorbent layer with addition of SAP (superabsorbent)
- composed of five layers: polypropylene non-woven, cellulose wadding, cellulose pulp with superabsorbent SAP, cellulose wadding, PE foil
- impermeable foiled bottom
- single use

REF	dimensions	packaging unit
BT-PC100225	100 cm x 225 cm	10 pcs

 bulk packaging:
2 x 10 pcs



ABSORBENT UNDERPAD FOR CHILDREN

NEW

features

- quilted absorbent insert with SAP (superabsorbent)
- white absorbent insert
- film layer with pattern
- single-use

REF	dimensions	packaging unit	bulk packaging
BT-PC6060C	60 cm x 60 cm	30 pcs	10 x 30 pcs
BT-PC6090C	60 cm x 90 cm	15 pcs	10 x 15 pcs

available colours: 





DISPOSABLE MEDICAL BED SHEET, REINFORCED

features

- made of foil laminated paper
- reinforced with 8 or 48 threads
- grammage 40 g/m²
- soft, waterproof, absorbent, tough
- white with blue threads
- product put on mattresses, couches, armchairs and other elements that are the equipment of health care units, ie hospitals, outpatient clinics, clinics, etc.
- the products are designed to protect the patient during medical procedures, to prevent the transmission of contaminants and potentially pathogenic microorganisms located in medical rooms, treatment rooms and equipment that furnish these rooms and that may lead to complications of the patient's treatment process. They are a barrier to contamination
- non-sterile
- single use

REF	type	dimensions	packaging unit
BT-PW101	8 threads	80 cm x 210 cm	25 pcs
BT-PW401	48 threads	80 cm x 210 cm	25 pcs

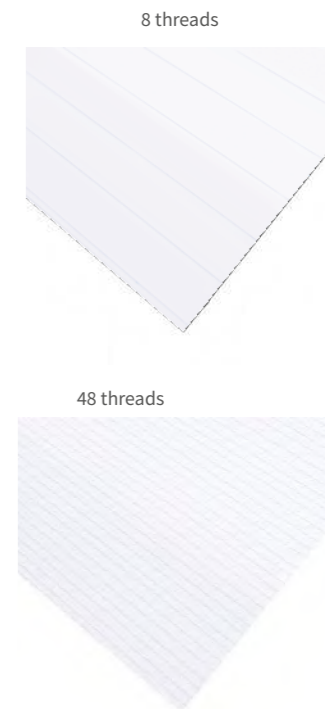
 bulk packaging:
4 x 25 pcs

THERMAL PATIENT COVER SOFT

features

- made of Spunlace non-woven with polyester filling
- ultrasonic seams over the entire surface
- can be heated up in the heating device
- maintaining patient temperature at a stable level
- single use

REF	dimensions	outer material	packaging unit	bulk packaging
BT-TOP-21S	110 cm x 120 cm	Spunlace non-woven	1 pc.	50 x 1 pcs
BT-TOP-22S	110 cm x 210 cm	Spunlace non-woven	1 pc.	25 x 1 pcs



THERMAL PATIENT COVER

features

- made of polypropylene non-woven with polyester filling
- ultrasonic seams over the entire surface
- can be heated up in the heating device
- maintaining patient temperature at a stable level
- single use

REF	dimensions	outer material	packaging unit	bulk packaging
BT-TOP-11P	110 cm x 120 cm	polypropylene non-woven	1 pc.	50 x 1 pcs
BT-TOP-12P	110 cm x 210 cm	polypropylene non-woven	1 pc.	25 x 1 pcs
BT-TOP-13P	150 cm x 210 cm	polypropylene non-woven	1 pc.	20 x 1 pcs



vitahealth line of adhesive plaster sets are designed to provide optimum protection in every situation and to satisfy the needs of the most demanding users. They are an indispensable element for everyday life.

Always with you and your loved ones

Adhesive plaster for cutting is by far the most often chosen form of dressings.

S.O.S.

Compact packaging

set of adhesive handbag plasters

- SLIM packaging
- #MustHave of each handbag

SENSITIVE

Dedicated to delicate skin
silicone adhesive

set of adhesive plasters for sensitive skin

- painless removal of the plaster
- correction of application

NONVIplast

NEW on the market - plaster with scissors

non-woven adhesive plaster for cutting



LIST OF ADHESIVE PLASTERS

name	ref	number of pieces in a set	individual packaging	bulk packaging
ACTIVE pro set of adhesive plasters for active people	VH-ZAC	12	1	60
AQUA pro set of adhesive waterproof plasters	VH-ZAQ	18	1	60
UNIVERSAL set of adhesive universal plasters	VH-ZUN	24	1	60
TRANSPARENT set of adhesive transparent plasters	VH-ZTR	24	1	60
HANDS pro set of adhesive hands plasters	VH-ZHA	12	1	60
FAMILY pro set of adhesive family plasters	VH-ZFA	28	1	60
KIDS pro G set of adhesive children's plasters - girl	VH-ZKG	16	1	60
KIDS pro B set of adhesive children's plasters - boy	VH-ZKB	16	1	60
SENSITIVE set of adhesive plasters for sensitive skin	VH-ZSE	12	1	30
S.O.S set of adhesive handbag plasters	VH-ZSO	8	1	1000
NONVI plast non-woven adhesive plaster for cutting	VH-NOP	1 + scissors	1	120
FABRI plast fabric adhesive plaster for cutting	VH-FAP	1+ scissors	1	120
SENSI plast adhesive fabric tape for cutting	VH-SEP	1	1	12x1 (box) 30x12 (carton)
SOFT plast adhesive non-woven tape for cutting	VH-SOP	1	1	12x1 (box) 30x12 (carton)





ZARYS International Group sp. z o.o. sp.k.

We create good solutions



headquarters

Poland





ZARYS worldwide

- ▷ Czech Republic
- ▷ Romania
- ▷ Italy
- ▷ Portugal
- ▷ United Arab Emirates

Please contact us if you require further details:

 Area	E-mail	Direct Line
Worldwide	export@zarys.pl	+48 327970579
Czech Republic	info@zarys.cz	+420 737954388
Italy	ufficio@zarys.it	+39 334 6591844
Portugal	geral@zarys.pt	+351 914183173
Romania	office@zarys.ro	+40 371485051
UAE	office@zarys.ae	+971 529047753

Export Department

-  Pod Borem 18, 41-808 Zabrze, Poland
-  +48 32 797 05 79
-  e-mail: export@zarys.pl

Rev. XI 30.09.2023

EC Certificate
Directive 93/42/EEC Annex V
Production Quality Assurance
Medical Devices

Registration No.: DD 60139535 0001

Report No.: 26300232 017

Manufacturer: ZARYS International Group
Spolka z ograniczona odpowiedzialnoscia,
spolka komandytowa
ul. Pod Borem 18
41-808 Zabrze
Polska

Products: (see attachments for products and sites included)

Replaces EC Certificate, Registration No.: DD 60117020 0001

Expiry Date: 2024-05-27

The Notified Body hereby declares that the requirements of Annex V of the directive 93/42/EEC have been met for the listed products. The above named manufacturer has established and applies a quality assurance system, which is subject to periodic surveillance, defined by Annex V, section 4 of the aforementioned directive. For placing on the market of class IIb and class III devices covered by this certificate an EC type-examination certificate according to Annex III is required.

Effective Date: 2019-06-09

Date: 2019-05-27

Notified Body

Rafal Byczkowski



TÜV Rheinland LGA Products GmbH - Tillystraße 2 - 90431 Nürnberg
TÜV Rheinland LGA Products GmbH is a Notified Body according to Directive 93/42/EEC
concerning medical devices with the identification number 0197.

TÜV Rheinland
LGA Products GmbH
Tillystraße 2, 90431 Nürnberg

**Attachment to
Certificate**

Registration No.: DD 60139535 0001
Report No.: 26300232 017

Manufacturer: **ZARYS International Group**
Spolka z ograniczona odpowiedzialnoscia,
spolka komandytowa
ul. Pod Borem 18
41-808 Zabrze
Polska

Products included:

- Sterile and non-sterile cutting gauze
- Non-sterile dressing gauze
- Sterile and non-sterile gauze swabs
(with or without X-ray thread)
- Sterile and non-sterile gauze lap sponges
(with X-ray thread/ with X-ray chip)
- Sterile and non-sterile gauze balls
(with or without X-ray thread)
- Sterile and non-sterile gauze rolls
(with or without X-ray thread)
- Sterile and non-sterile non-woven swabs
(with or without X-ray thread)
- Sterile paraffin gauze dressings
- Sterile three-way stopcocks
- Sterile transfusion sets for single use
- Sterile infusion sets for single use
- Sterile extension tubes for infusion pump

Notified Body



Date: 2019-05-27

Rafal Byczkowski

TÜV Rheinland
LGA Products GmbH
Tillystraße 2, 90431 Nürnberg

Doc. 2/6, Rev. 0

**Attachment to
Certificate**

Registration No.: DD 60139535 0001
Report No.: 26300232 017

Manufacturer: ZARYS International Group
Spolka z ograniczona odpowiedzialnoscia,
spolka komandytowa
ul. Pod Borem 18
41-808 Zabrze
Polska

Products included:

- Sterile endotracheal tubes
- Sterile tracheostomy tubes
- Sterile breathing circuits
- Sterile catheter mounts
- Non-sterile anaesthetic masks
- Sterile laryngeal masks
- Sterile oxygen masks
- Sterile Multi-Vent masks
- Sterile non-rebreath masks
- Sterile nebulizer masks
- Sterile nasal oxygen cannulas
- Sterile nebulizer sets
- Sterile oxygen tubing
- Sterile suction catheters
- Sterile abdominal drains
- Sterile feeding tubes
- Sterile stomach and duodenal tubes
- Sterile urology catheters
- Sterile surgical suction sets
- Sterile surgical suction cannulas
- Sterile syringes for single use

Date: 2019-05-27

Notified Body

Rafal Byczkowski



TÜV Rheinland
LGA Products GmbH
Tillystraße 2, 90431 Nürnberg

**Attachment to
Certificate**

Registration No.: DD 60139535 0001
Report No.: 26300232 017

Manufacturer: ZARYS International Group
Spolka z ograniczona odpowiedzialnoscia,
spolka komandytowa
ul. Pod Borem 18
41-808 Zabrze
Polska

Products included:

- Sterile insulin syringes
- Sterile tuberculin syringes
- Sterile hypodermic needles
- Sterile insulin pen needles
- Sterile blood lancets
- Sterile IV cannulas
- Sterile needle free valves
- Sterile surgical gloves

Date: 2019-05-27

Notified Body

Rafal Byczkowski



TÜV Rheinland
LGA Products GmbH
Tillystraße 2, 90431 Nürnberg

**Attachment to
Certificate**

Registration No.: DD 60139535 0001
Report No.: 26300232 017

Manufacturer: ZARYS International Group
Spolka z ograniczona odpowiedzialnoscia,
spolka komandytowa
ul. Pod Borem 18
41-808 Zabrze
Polska

Products included:

For the following medical devices the scope covers only the aspects of manufacture concerned with securing and maintaining sterile conditions:

- Adhesive cannula fixation dressings
- Adhesive wound dressings
- Eye pads
- Incise films
- Transparent film dressings
- Foam dressings
- Absorbent wound dressings
- Surgical gowns
- Surgical drapes
- Sets of surgical drapes
- Fluid collection pouches
- Nelaton catheters

Notified Body



Date: 2019-05-27

Rafal Byczkowski

TÜV Rheinland
LGA Products GmbH
Tillystraße 2, 90431 Nürnberg

**Attachment to
Certificate**

Registration No.: DD 60139535 0001
Report No.: 26300232 017

Manufacturer: ZARYS International Group
Spolka z ograniczona odpowiedzialnoscia,
spolka komandytowa
ul. Pod Borem 18
41-808 Zabrze
Polska

Products included:

For the following medical devices the scope covers only the aspects of manufacture concerned with securing and maintaining sterile conditions:

- Vaginal speculums
- Cervical brushes
- Urine bags
- Tongue depressors
- Guedel airways
- Intubation stylets
- Endotracheal tube holders
- Suction tubes
- Withdrawal cannulas
- Alginate dressings
- Cannula stoppers
- Umbilical cord clamps

Notified Body



Date: 2019-05-27

Rafal Byczkowski

TÜV Rheinland
LGA Products GmbH
Tillystraße 2, 90431 Nürnberg

**Attachment to
Certificate**

Registration No.: DD 60139535 0001
Report No.: 26300232 017

Manufacturer: ZARYS International Group
Spolka z ograniczona odpowiedzialnoscia,
spolka komandytowa
ul. Pod Borem 18
41-808 Zabrze
Polska

Products included:

ZARYS International Group
Spolka z ograniczona odpowiedzialnoscia,
spolka komandytowa
ul. Gustawa Eiffel'a 15
44-109 Gliwice
Poland

Activity: Production

Date: 2019-05-27

Notified Body

Rafal Byczkowski



Certificate

Quality Management System
EN ISO 13485:2016

Registration No.: SX 1023663-1

Organization: ZARYS International Group
Spółka z ograniczoną odpowiedzialnością,
spółka komandytowa
ul. Pod Borem 18
41-808 Zabrze
Poland

Scope: Design and development, manufacture and distribution of sterile:
surgical kits, procedure sets, surgical drapes and sets of surgical
drapes.
Manufacture and distribution of sterile and non-sterile disposable
medical devices and non-sterile reusable medical devices.
Distribution of in-vitro medical devices.

The Certification Body of TÜV Rheinland LGA Products GmbH certifies that the organization has established and applies a quality management system for medical devices.
Proof has been furnished that the requirements specified in the above mentioned standard are fulfilled. The quality management system is subject to yearly surveillance.

Report No.: 84947434 020

Effective date: 2020-06-10

Expiry date: 2023-06-08

Issue date: 2020-06-10



Rafał Byczkowski
TR LGA Products GmbH
Tillystraße 2 · 90431 Nürnberg · Germany