

BeneFusion uVP/uSP/uDSP
Infusion System

Ultimate care with ease





Simple design



Line management



3.5"
Colored capacitive touchscreen



2-50/60 ml

Utmost ease

Easy touch and interaction

- The intuitive UI with flat design presents critical parameters more prominently for efficient interaction
- The personalized large font view displays key information clearly, even from a distance



Departmental drug management

Departmental drug library

Customized drug library for varied care units to promote continuous optimization of infusion protocol.

Specialized infusion modes

Flexible drug administration modes for special care units, improving clinical infusion efficiency and quality.





Precise infusion performance

- High accuracy: uSP/uDSP $\pm 1.8\%$; uVP $\pm 4.5\%$
- Long-hour accuracy assured

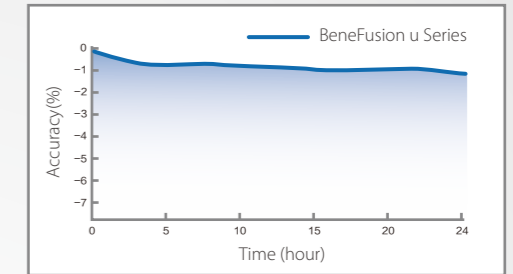

Flexible relay infusion

- BeneFusion u series supports both circular and customized relay to make sure the continuity of infusion
- Smooth relay workflow ensures stable and seamless drug-giving process.

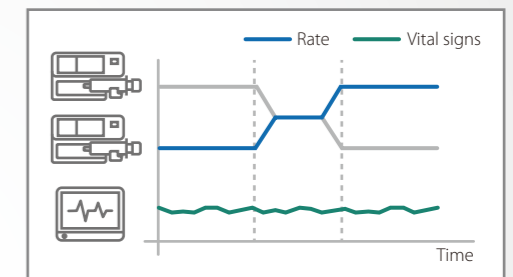

Unique ease

Real-time monitoring and automatic calibration of infusion accuracy by Smart accurate™ technology



- helps simplify the pump tube brand choice process and improve infusion efficiency
- resolves accuracy deviation concerns caused by tube fatigue and wrong tube brand choice, ensuring excellent accuracy and stability of long-term infusion

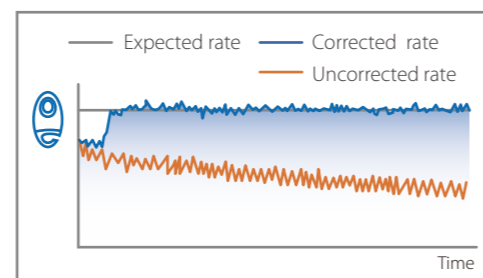

BolusGUARD, precise safety for every loading

Syringe loading may result in unintentional drug boluses. Equipped with BolusGUARD, the patent automatic clutch technology, BeneFusion uSP allows caregivers to load syringes safely and efficiently, safeguarding patients' infusion from beginning to end.





Unlimited ease

Comprehensive integration, better connectivity

- Centralized monitoring of infusion and patients' vital sign
- Able to obtain infusion and alarm information anywhere at anytime
- Access the HIS/CIS/EMR system through the HL7 protocol

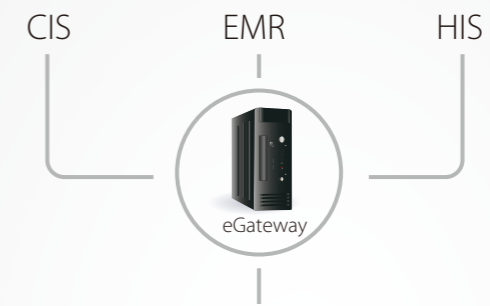

Utility ease

Outstanding reliability and utility

With the principle of easy-of-use, BeneFusion u series is designed to be compact, light, durable, and utility enough to well satisfy varied clinical environments and requirements.



Clinical transfer

Meet the clinical transfer scenario



IP44

Applicable to various clinical environments



Super battery life

Ultra-long duration: continuous dosing in emergency state



Premium material

Support up to 49 disinfectants

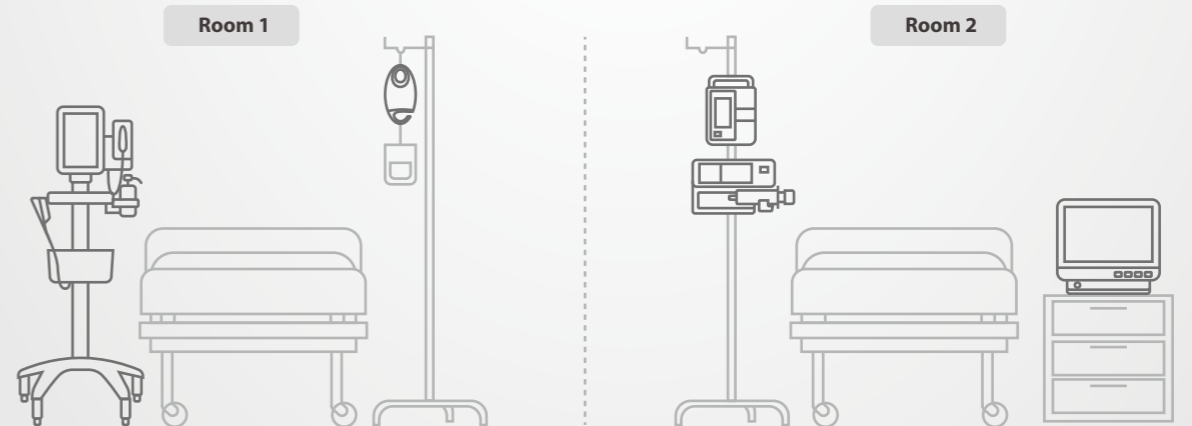

BeneFusion uSP

Syringe Pump

Data Sheet



Physical Specifications

Weight	≤ 1.7kg (with normal battery, without pole clamp) Pole clamp ≤ 0.15kg
Size	≤ 252x 118 x134mm
Screen	3.5 inch capacitive touchscreen, TFT color LCD, 320x480 pixels
Brightness	1-8 levels, adjustable
Display	Support large font view (customized information: flow rate, dose rate, VTBI, remaining time etc.); patient information, infusion information, alarm information, system status information
Syringe loading	Bolus GUARD: avoid accident bolus to patient when syringe loading

Parameters Specifications

Accuracy	≤ ±1.8%
Mode	Rate mode, Dose Mode, Time mode, Dose Time Mode, Sequential Mode, Intermittent Mode, Loading Dose Mode, Ramp Mode, Micro-infusion Mode, TIVA Mode Optional: TCI Mode
Flow rate	0.01-2300ml/h
Increment	0.01ml/h (0.01-99.99ml/h); 0.1ml/h (100.0-999.9ml/h); 1ml/h (1000-2300ml/h)
Preset volume (VTBI)	0.01 ml - 9999.99 ml, increment: 0.01ml
Preset time	00:00:01-99:59:59
Accumulated volume	0.00 ml - 99999.99 ml, increment: 0.01ml
KVO	0.01 to 5.0ml/h; increment: 0.01ml/h
Purge rate	0.01-2300ml/h
Bolus rate	0.01-2300ml/h (automatic or manual)
Bolus volume	0.01 ml to the maximum volume of current syringe
Occlusion detection	50-1125mmHg, support 1mmhg increment Default 15 levels, default 450 mmHg Customized alarm levels Pre-alarm: an alert will pop out when the pressure is going up Auto-restart: On/Off, restart the infusion when the pressure that caused the occlusion alarm is reduced. 4 units of pressure selectable: mmHg/kPa/bar/psi
Anti-bolus	Unexpected bolus reduced when the occlusion occurs
Dose rate units	ng/kg/min, ng/kg/h, ng/kg/24h, ug/kg/min, ug/kg/h, ug/kg/24h, mg/kg/min, mg/kg/h, mg/kg/24h, g/kg/min, g/kg/h, g/kg/24h, mU/kg/min, mU/kg/h, mU/kg/24h, U/kg/min, U/kg/h, U/kg/24h, kU/kg/min, kU/kg/h, kU/kg/24h, EU/kg/min, EU/kg/h, EU/kg/24h, mmol/kg/min, mmol/kg/h, mmol/kg/24h, mol/kg/min, mol/kg/h, mol/kg/24h, mcal/kg/min, mcal/kg/h, mcal/kg/24h, cal/kg/min, cal/kg/h, cal/kg/24h, kcal/kg/min, kcal/kg/h, kcal/kg/24h, mEq/kg/min, mEq/kg/h, mEq/kg/24h
Auto-lock time	1 - 5 minutes selectable; ON/OFF switchable
History log	Up to 5000 records
Volume collection	4 methods: 24H total, current total, period, timing volume, support history rate review

Para. Memory	Previous therapy parameters will be loaded
Drug library	Up to 5000 drugs, support color- coding drug name
DERS (Dose Error Reduction System)	Optional; definition of dose limits; automatic alarms when reaching dose limits

Syringes

Compatibility	2/3/5/10/20/30/50/60ml; Automatic recognition of syringe size
---------------	--

Alarms

Type	Audible and visual alarm
2 Levels	High: Occlusion/ Syringe empty/ Syringe Disengaged/ Plunger Grippers Error / Battery Depleted/ VTBI Complete/ KVO Finish/ Relay Invalid/ System Error/ No Syringe, etc. Low: KVO Running/ Battery in Use/ Battery Error/CMS/eGW Disconnected/ Standby Time Expired/ System Time Error/ Relay Invalid Soon/ Time Near End/ Reminder/ Low Battery/ Syringe Near Empty, etc.
Sound volume	1-8 levels selectable, default level 4
Reminder	1-5 minutes selectable; ON/OFF switchable

Connectivity

Communication	Wired/wireless
USB	Support drug library import, patient information loading, patient data export, history record export, calibration data import/export
Multifunctional connector (optional)	RS232, nurse call connector, DC adapter, etc.
Integration	Connect with BeneVision Central Monitoring System (CMS) Connect with BeneFusion nCS infusion central station Support HL7 protocol
Relay	Available (optional)

Battery

Operating time	≥ 6.5 hours at 5ml/h (≥ 12.5 hours at 5ml/h for smart battery)
Charging time	≤ 5 hours to full capacity (≤ 6 hours for smart battery)

Power Supply

AC: voltage	100-240 VAC; frequency 50/60Hz;
current	0.30-0.13A
DC: 10 VDC	to 16 VDC, 2.0A to 1.3A

Work Environment

Temperature	5-40°C for operating; -20-60 °C for storage
Relative humidity	15-95°C for operating; 10-95% for storage
Atmosphere pressure	57.0-107.4 kPa for operating; 16.0-107.4 kPa for storage
Classification	Type CF, Class I, IP44
Disinfection	Support 49 types of detergents
Transfer	Support ambulance transfer

Mindray Building, Keji 12th Road South,
High-tech Industrial Park, Nanshan, Shenzhen 518057, P.R.
China
Tel: +86 755 8188 8998 Fax: +86 755 26582680
E-mail: intl-market@mindray.com www.mindray.com

mindray | Healthcare with reach  registered trademarks or trademarks owned by Shenzhen Mindray Bio-medical Electronics Co., LTD
© 2023 Shenzhen Mindray Bio-medical Electronics Co., Ltd. All rights reserved. Specifications subject to changes without prior notice.
P/N: ENG-BeneFusion uSP Datasheet-210285x2P-20230103

mindray

BeneFusion uSP
BeneFusion uSP ex
Syringe Pump

Operator's Manual



© Copyright 2022-2023 Shenzhen Mindray Scientific Co., Ltd. All rights reserved.

Release date: January 2023

Revision: 3.0

Intellectual Property Statement

SHENZHEN MINDRAY SCIENTIFIC CO., LTD. (hereinafter called Mindray Scientific) owns the intellectual property rights to this product and this manual. This manual may refer to information protected by copyrights or patents and does not convey any license under the patent rights of Mindray Scientific, nor the rights of others.

Mindray Scientific intends to maintain the contents of this manual as confidential information. Disclosure of the information in this manual in any manner whatsoever without the written permission of Mindray Scientific is strictly forbidden.

Release, amendment, reproduction, distribution, rental, adaptation, translation of this manual in any manner whatsoever without the written permission of Mindray Scientific is strictly forbidden.

mindray,  **MINDRAY**, and **BeneFusion** are the registered trademarks or trademarks owned by Mindray in China and other countries. Mindray Scientific is authorized by Mindray to use above registered trademarks or trademarks.

Responsibility on the Manufacturer Party

Contents of this manual are subject to changes without prior notice.

All information contained in this manual is believed to be correct. Mindray Scientific shall not be liable for errors contained herein nor for incidental or consequential damages in connection with the furnishing, performance, or use of this manual.

Mindray Scientific is responsible for the effects on safety, reliability and performance of this product, only if:

- all installation operations, expansions, changes, modifications and repairs of this product are conducted by Mindray Scientific authorized personnel;
- the electrical installation of the relevant room complies with the applicable national and local requirements;
- the product is used in accordance with the instructions for use.

Warranty

THIS WARRANTY IS EXCLUSIVE AND IS IN LIEU OF ALL OTHER WARRANTIES, EXPRESSED OR IMPLIED, INCLUDING WARRANTIES OF MERCHANTABILITY OR FITNESS FOR ANY PARTICULAR PURPOSE.

Exemptions

Mindray Scientific's obligation or liability under this warranty does not include any transportation or other charges or liability for direct, indirect or consequential damages or delay resulting from the improper use or application of the product or the use of parts or accessories not approved by Mindray Scientific or repairs by people other than Mindray Scientific authorized personnel.

This warranty shall not extend to

- Malfunction or damage caused by improper use or man-made failure.
- Malfunction or damage caused by unstable or out-of-range power input.
- Malfunction or damage caused by force majeure such as fire and earthquake.
- Malfunction or damage caused by improper operation or repair by unqualified or unauthorized service people.
- Malfunction of the instrument or part whose serial number is not legible enough.
- Others not caused by instrument or part itself.

Company Contact



Manufacturer: Shenzhen Mindray Scientific Co., Ltd.
Address: 6/F, Bldg 2, 1203 Nanhuan Avenue, Yutang Block,
Guangming District, 518106 Shenzhen, P.R.China
Website: www.mindray.com
E-mail Address: service@mindray.com
Tel: +86 755 81888998
Fax: +86 755 26582680



EC-Representative: Shanghai International Holding Corp. GmbH (Europe)
Address: Eiffestraße 80, 20537 Hamburg, Germany
Tel: 0049-40-2513175
Fax: 0049-40-255726

Summary of Safety and Clinical Performance (SSIP): <https://www.mindray.com/content/dam/xpace/en/site/mdr-sscp/ivp-and-uvp/kf-h-046-024483-00-usp-instruction-for-use.pdf>

Notification of Adverse Events

As a health care provider, you may report the occurrence of certain events to SHENZHEN MINDRAY SCIENTIFIC CO., LTD., and possibly to the competent authority of the Member state in which the user and / or patient is established.

These events, include device-related death and serious injury or illness. In addition, as part of our Quality Assurance Program, SHENZHEN MINDRAY SCIENTIFIC CO., LTD. requests to be notified of device failures or malfunctions. This information is required to ensure that SHENZHEN MINDRAY SCIENTIFIC CO., LTD. provides only the highest quality products.

Preface

Manual Purpose

This manual contains the instructions necessary to operate the product safely and in accordance with its function and intended use. Observance of this manual is a prerequisite for proper product performance and correct operation and ensures patient and operator safety.

This manual is based on the maximum configuration and therefore some contents may not apply to your product. If you have any question, please contact us.

This manual is an integral part of the product. It should always be kept close to the equipment so that it can be obtained conveniently when needed.

Intended Audience

This manual is geared for clinical professionals who are expected to have a working knowledge of medical procedures, practices and terminology as required for monitoring of critically ill patients.

Illustrations

All illustrations in this manual serve as examples only. They may not necessarily reflect the setup or data displayed on your equipment.

Conventions

- ***Italic text*** is used in this manual to quote the referenced chapters or sections.
- ***Bold text*** is used to indicate the screen texts.
- → is used to indicate operational procedures.

Contents

1 Safety	1 - 1
1.1 Safety Information	1 - 1
1.2 Equipment Symbols	1 - 3
2 Equipment Introduction	2 - 1
2.1 Intended Purpose	2 - 1
2.2 Clinical Benefit	2 - 2
2.3 Applied Part	2 - 2
2.4 Main Unit	2 - 2
2.5 Screen Display	2 - 4
3 Equipment Preparation	3 - 1
3.1 Equipment Preparation Safety Information	3 - 1
3.2 Installation	3 - 2
3.3 Setting Up the Equipment	3 - 2
4 Getting Started	4 - 1
4.1 Turning on the Pump	4 - 1
4.2 Loading the Syringe	4 - 1
4.3 Purge	4 - 4
4.4 Starting Infusion	4 - 4
4.5 Relay Infusion	4 - 5
4.6 Bolus Infusion	4 - 5
4.7 Changing the Infusion Parameters	4 - 6
4.8 Pausing the Infusion	4 - 6
4.9 Setting Keep Vein Open (KVO) Rate	4 - 6
4.10 Unloading a Syringe	4 - 7
4.11 Viewing the Infused Volume	4 - 7
4.12 Entering the Standby Mode	4 - 8
4.13 Turning Off the Pump	4 - 8
5 Alarms	5 - 1
5.1 Alarm Safety Information	5 - 1
5.2 Understanding the Alarms	5 - 1
5.3 Alarm Screen	5 - 2
5.4 Resetting Alarms	5 - 2
5.5 Pausing Alarm Sound	5 - 3
5.6 Alarm Solutions	5 - 3
5.7 Occlusion Alarm	5 - 6

6 Menu Options	6 - 1
6.1 General Option	6 - 1
6.2 Department Management	6 - 2
6.3 System Options	6 - 2
6.4 User Maintenance	6 - 3
7 Infusion Modes	7 - 1
7.1 Rate Mode/Time Mode/Micro-infusion Mode	7 - 1
7.2 Dose Mode	7 - 1
7.3 Loading Dose Mode	7 - 2
7.4 Sequential Mode	7 - 2
7.5 Intermittent Mode	7 - 2
7.6 Ramp Mode	7 - 2
7.7 Dose Time Mode	7 - 3
7.8 TIVA Mode	7 - 3
7.9 TCI Mode	7 - 4
8 Drug Library/Drug Info Library	8 - 1
9 Networked Communication	9 - 1
9.1 Network Safety Information	9 - 1
9.2 Connecting the Equipment to the CMS	9 - 1
9.3 Connecting the Equipment to the eGateway	9 - 2
10 Maintenance	10 - 1
10.1 Maintenance Safety Information	10 - 1
10.2 Maintenance and Testing Schedule	10 - 2
10.3 Maintaining the Battery	10 - 3
10.4 Checking the History Record	10 - 4
10.5 Disposing of the Equipment	10 - 4
11 Care and Cleaning	11 - 1
11.1 Care and Cleaning Safety Information	11 - 1
11.2 Cleaning the Equipment	11 - 2
11.3 Disinfecting the Equipment	11 - 2
11.4 Cleaning the Pole Clamp	11 - 5
11.5 Disinfecting the Pole Clamp	11 - 5
11.6 Sterilization	11 - 6
12 Accessories	12 - 1
A Product Specifications	A - 1
A.1 Specifications	A - 1

A.2 Wireless Network	A - 2
A.3 Infusion Specifications	A - 3
A.4 Recommended Syringes	A - 5
A.5 Occlusion Alarm Delay and Bolus Volume	A - 6
A.6 Infusion Accuracy Graphs	A - 7
A.7 Operating Environment	A - 9
B EMC and Radio Regulatory Compliance	B - 1
B.1 EMC	B - 1
B.2 Radio Regulatory Compliance	B - 9
C Abbreviations	C - 1
D Declaration of Conformity	D - 1

This page intentionally left blank.

1 Safety

1.1 Safety Information

WARNING

- Indicates a potential hazard or unsafe practice that, if not avoided, could result in death, serious injury or damage to product/property.
-
-

CAUTION

- Indicates a potential hazard or unsafe practice that, if not avoided, could result in minor personal injury, product malfunction or damage to product/property.
-
-

NOTE

- Provides application tips or other useful information to ensure that you get the most out of the product.
-
-

1.1.1 Warnings

WARNING

- To avoid risk of electric shock, the equipment must only be connected to mains power with protective earth. If a protective earth conductor is not provided, operate it on battery power, if possible.
- To avoid explosion hazard, do not use the equipment in the presence of oxygen-rich atmospheres, flammable anesthetics, or other flammable agents.
- The equipment is not intended to be used within the Magnetic Resonance (MR) environment.
- Do not use the multiple portable socket outlets (MPSO) or AC mains extension cords. Ensure that the sum of the individual ground leakage currents does not exceed the allowable limits.

- **Do not open the equipment housings. All servicing and future upgrades must be carried out by trained and authorized personnel. Moreover, the servicing must be done only after the AC power supply is disconnected.**
 - **Do not place the equipment or accessories in any position that might cause it to fall on the patient.**
 - **Do not start an infusion unless the setup was verified to be correct.**
 - **To avoid inadvertent disconnection, route all cables in a way to prevent a stumbling hazard. Wrap and secure excess cabling to reduce risk of entanglement by patients or personnel.**
 - **Clearing the occlusion result from line kinks, filter coagulation, etc. may cause extra bolus to patients. Appropriate measures should be taken.**
 - **Check that the syringe and the extension set are securely connected and there is no leakage.**
 - **Do not touch the patient and device connectors simultaneously. Otherwise leakage current may result in patient injury.**
 - **To avoid electric shock, do not touch patient and other non-defibrillation proof equipments during defibrillation. Defibrillation will not affect the performance of the equipment.**
-
-

1.1.2 Cautions

CAUTION

- **When several infusion lines are connected to the same vascular access, there may be back flow or prolonged response time of occlusion alarm. Therefore, use check valve at the line end or follow local hospitals' instructions while in connection with other infusion system.**
- **Ensure that the equipment is supplied with continuous electric power during work. Sudden power failure may cause data loss.**
- **Electromagnetic fields may affect equipment performance. This makes it necessary for other equipment used in the vicinity of this equipment to meet EMC standards. Mobile phones, X ray and MRI equipment are all potential interference sources because of their high-intensity electromagnetic radiation.**
- **Always install or carry the equipment properly to avoid damage caused by drop, impact, strong vibration or other mechanical force. The equipment should be observed to verify normal operation after fall, otherwise it cannot be used.**
- **Dry the equipment immediately in case of rain or water spray.**

- Some settings are password protected and can only be changed by authorized personnel. Contact your department manager or biomedical engineering department for the passwords used at your facility.













1.1.3 Notes

















NOTE

- The software was developed in compliance with IEC62304.
- The equipment provides power-down storage. Alarms limit setting and history record are saved and will be maintained if the equipment is powered down suddenly. The storage time is equals to the equipment's service life. The alarm limit settings before power-down are reloaded when the equipment is restarted.
- This manual describes all features and options. Your equipment may not have all of them.

1.2 Equipment Symbols

Some symbols may not appear on your equipment.

	Refer to instruction manual/ booklet		Caution
	Alternating current		Input/output
	Both direct and alternating current		Direct current
	Battery		USB connector
	Stand-by		Stop
	Non-ionizing electromagnetic radiation		General warning sign

	Unique device identification		Medical Device
	Date of manufacture		Manufacturer
	Serial number		Authorized representative in the European Community
IP44	Protected against solid foreign objects with a diameter no less than 1.0 mm in diameter. Protected against splashing water.		DEFIBRILLATION-PROOF TYPE CF APPLIED PART
	Dispose of in accordance to your country's requirements		Temperature limitations
	Atmospheric pressure limitations		Humidity limitations
	THIS WAY UP		Keep dry
	Fragile, handle with care		STACKING LIMIT BY NUMBER
	The product bears CE mark indicating its conformity with the provisions of the REGULATION (EU) 2017/745 on medical devices and fulfills the general safety and performance requirements of Annex I of this regulation. Note: The product complies with the Council Directive 2011/65/EU.		CLASS II equipment

2 Equipment Introduction

2.1 Intended Purpose

The syringe pump is intended for use on adults, paediatrics, and neonates for the intermittent or continuous delivery of medications, solutions, parenteral nutrition, lipids indicated for infusion therapy through an intravenous or intra-arterial routes.

WARNING

- **This pump is intended for use only by clinical professionals or under their guidance. It must only be used by persons who have received adequate training in its use. Anyone unauthorized or untrained must not perform any operation on it.**
-
-

NOTE

- **According to the conclusion of clinical evaluation and residual risk evaluation, for the intended patients, there is no known side effects that can occur during or after the use of the medical device. And there is no need for the operator to make extra preparations. Thus, no residual risk associated with using the medical device should be disclosed.**
-
-

2.1.1 Indication for Use

Syringe pumps are for patients who need receive various types of medications, solutions, parenteral nutrition, lipids in controlled amounts through an intravenous or intra-arterial routes.

2.1.2 Intended Users

The syringe pump is intended to be used by trained healthcare professionals.

2.1.3 Intended Patient Population

The syringe pump is intended for use on adult, pediatric and neonate.

2.1.4 Intended Medical Conditions

The syringe pump is intended to be used in professional healthcare facilities.

2.1.5 Contra-indications

None.

2.1.6 Side-effects

None.

2.2 Clinical Benefit

The syringe pump allows administration of medications, solutions, parenteral nutrition, lipids accurately, evenly and continuously through an intravenous or intra-arterial routes.

2.3 Applied Part

The applied part of the equipment is the syringe.

2.4 Main Unit

2.4.1 Front View

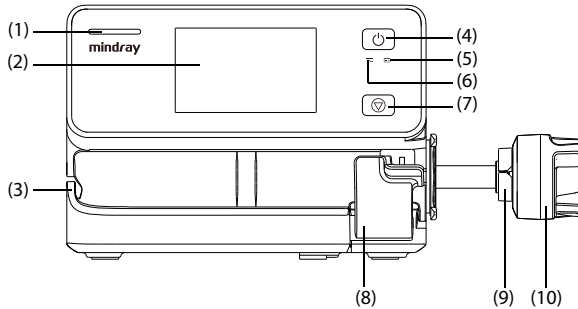

- | | |
|--------------------------|------------------------|
| (1) Alarm light | (2) Display |
| (3) Extension set holder | (4) Power switch |
| (5) Battery LED | (6) External power LED |
| (7) Stop key | (8) Barrel clamp |
| (9) Plunger grippers | (10) Driver head |

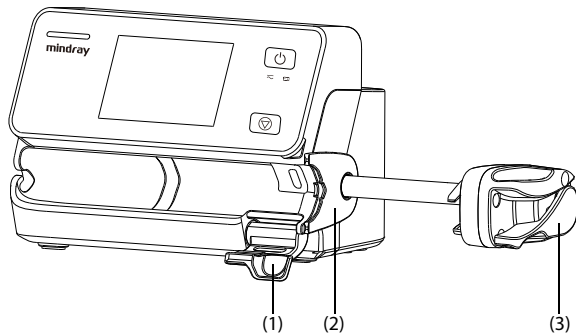

- | | |
|------------------|---------------------|
| (1) Barrel clamp | (2) Flange retainer |
| (3) Finger grips | |

2.4.2 Rear View

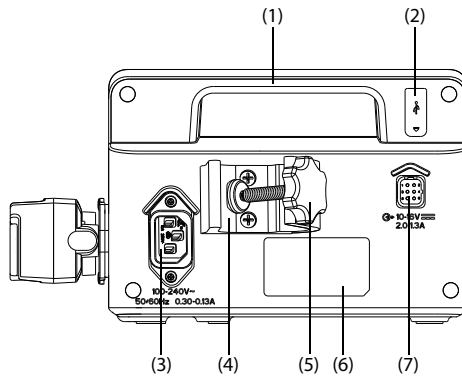

- | | |
|--|-------------------|
| (1) Handle | (2) USB connector |
| (3) AC power input connector | (4) Pole clamp |
| (5) Pole clamp handle | (6) Product label |
| (7) Multifunctional connector (optional) | |
- Uses as a DC power input connector.
 - Uses as a RS232 connector.
 - Connects to the hospital's nurse call system.

2.5 Screen Display

The screen may look slightly different in different infusion modes. The following figure shows the infusion screen of the rate mode:

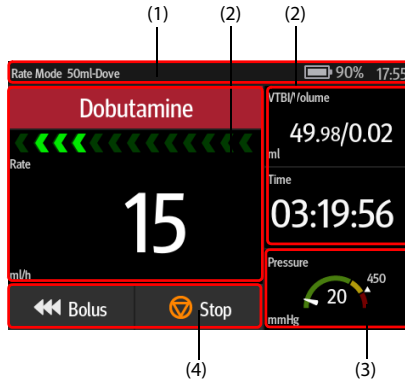







- (1) Alarm information and system status information area
- (2) Infusion status area
- (3) Pressure status area:
 - Green: Pressure is normal.
 - Yellow: Pressure is near the threshold for the infusion.
 - Red: Pressure is beyond the threshold for the infusion.
- (4) Key area

2.5.1 On-screen Symbols











The following table lists the on-screen symbols:











Symbol	Description	Symbol	Description
	Audible alarm tones are paused.		Alarms are acknowledged and the alarm is reset.
	Alarms are acknowledged and the reminder sound is given.		Night mode
	Wireless network is connected. The solid part indicates network signal strength.		Wireless network is not connected.

Symbol	Description	Symbol	Description
	Customized relay		Circular relay
	The battery works correctly. The solid portion represents the remaining charge.		The battery is being charged.
	The battery has low power and needs to be charged.		The battery has critically low charge and needs to be charged immediately. Otherwise, the equipment will automatically shut down.
	No battery is installed, battery fault, battery communication fault, or battery charging fault. Contact service personnel for help.		

2.5.2 Operation Keys

The equipment provides operation keys for you to access some functions. The following table shows available operation keys.

Symbol	Label	Function	Symbol	Label	Function
	AudioPause	Pauses alarm sound.		AlarmReset	Acknowledges the ongoing alarms.
	Lock	Locks the touchscreen.		Purge	Initiate a purge.
	Volume	Enters the Volume menu.		Menu	Enters the Menu .
	Link Code	Enters the Link Code menu.		End Prescription	Ends the current prescription.
	Exit	Returns to the main screen.		Bolus	Initiate a Bolus infusion.

Symbol	Label	Function	Symbol	Label	Function
	Start	Starts an infusion.		Stop	Pause an infusion.
	Back	Returns to the previous screen or the parameter setup screen.		Home	Returns to the main screen.
	Setup	Enters the Standby Time setup menu or the parameter setup screen.		Cancel	Cancels the shutdown and returns to the main screen.
	Turn Off	Turn off the pump.		Standby	Enters Standby.
	Extension key	Displays the current infusion information and TCI trend.		Extension key	Displays the current infusion information.
	Relay	Enters the Relay menu.			

2.5.3 Using the Touchscreen

You can use the touchscreen to select a screen element by pressing directly on the pump's screen.

To avoid misuse, the touchscreen is locked automatically if no operation is detected in the preset time. To manually lock the touchscreen, swipe the touchscreen from top down, and select **Lock**.





To unlock the touchscreen, select  on the touchscreen and swipe the slide as instructed.

NOTE

- **Wipe off any water on the touchscreen in case of rain or water spray.**

2.5.4 Using the On-Screen Keyboard

The on-screen keyboard enables you to enter information:

- Enter the information by selecting one character after another.
- Select the Backspace key  to delete single characters.
- Select the Caps Lock key  to switch uppercase letters and lowercase letters.
- Select the Enter key  to confirm the entry and close the on-screen keyboard.
- Select the Space bar  to enter a space.

This page intentionally left blank.

3 Equipment Preparation

3.1 Equipment Preparation Safety Information

WARNING

- Use only installation accessories specified by Mindray Scientific.
 - The equipment software copyright is solely owned by Mindray Scientific. No organization or individual shall resort to modifying, copying, or exchanging it or to any other infringement on it in any form or by any means without due permission.
 - Connect only approved devices to this equipment. Devices connected to the equipment must meet the requirements of the applicable IEC standards (e.g. IEC 60950 safety standards for information technology equipment and IEC 60601-1 safety standards for medical electrical equipment). The system configuration must meet the requirements of the IEC 60601-1 medical electrical systems standard. Any personnel who connect devices to the equipment's signal input/output port are responsible for providing evidence that the safety certification of the devices has been performed in accordance to the IEC 60601-1. If you have any questions, please contact Mindray Scientific.
 - If it is not evident from the equipment specifications whether a particular combination with other devices is hazardous, for example, due to summation of leakage currents, please consult the manufacturer or an expert in the field. A determination must be made that the proposed combination will not negatively affect the devices themselves or the patient's safety.
 - Ensure that the equipment is properly secured and positioned. Position change and severe shock may lead to changes to the delivery accuracy.
-
-

CAUTION

- The equipment should be installed by the authorized personnel.
 - Before use, verify whether the packages are intact. In case of any damage, do not apply it to patient.
-
-

NOTE

- **Save the packing case and packaging material as they can be used if the equipment must be reshipped.**
 - **This equipment is in accordance with the EN1789:2020 standard, and can be used to transport patient through road ambulance.**
-

3.2 Installation

By turning the pole clamp handle, the pole clamp secures the pump to either a horizontal or vertical bar of the medical supply unit or IV pole.

3.3 Setting Up the Equipment

Before getting started, ensure that the pump is properly set up:

- The pump is placed on a stable surface, or properly mounted to an IV pole using the pole clamp.
- The pump is plugged into a properly-grounded AC power outlet. When AC mains is connected, the external power LED is illuminated in green.
- If the pump is run on battery power, ensure that the battery is adequately charged.
- To ensure the history records are stored correctly, the system date and time should be checked before first use.

WARNING

- **Always use the accompanying power cord delivered with the pump.**
 - **Before connecting the equipment to the AC mains, check that the voltage and frequency ratings of the power line are the same as those indicated on the equipment.**
 - **Do not touch the power connector with wet hand. Eliminate the liquid or any residue inside of or at the surroundings of the AC power input connector and power cord connectors.**
 - **Use the battery if the integrity of the protective earth conductor or the protective earthing system in the installation is in doubt.**
-
-

CAUTION

- **When connected with the adapter, it is specified as a part of the equipment. Use only the specified adapter.**
-

4 Getting Started

4.1 Turning on the Pump

Press the power switch to turn on the pump. The pump automatically performs a self test at startup. Check that the alarm tone is heard and the alarm lamp illuminates, one after the other, in red and yellow. This indicates that the visible and audible alarm indicators function correctly. The loading guide screen displays.

WARNING

- **Before putting the system into operation, the operator must verify that the equipment, connecting cables and accessories are in correct working order and operating condition.**
 - **Check that visual and auditory alarm signals are presented correctly when the equipment is powered on. Do not use the equipment if you suspect it is not working properly, or if it is mechanically damaged. Contact your service personnel or us**
-
-

NOTE

- **Stay within 1 meter (39 inches) of the pump while setting it up and operating it, making sure that you have a clear view of the pump interface.**
 - **The equipment uses a mains plug as isolation means to the mains power. Do not locate the equipment in a place difficult to operate the mains plug.**
-
-

4.2 Loading the Syringe

1. Pull down the syringe clamp (1), squeeze the finger grips (2) together and slide the driver head (3) to the right.

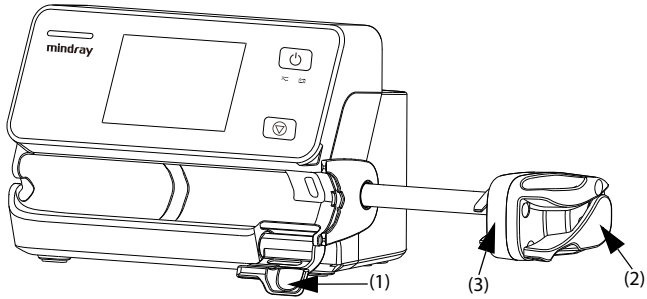

- Place the syringe into the syringe slot (4), ensuring that the barrel flange (5) is in the space between the pump and the flange retainer (6).

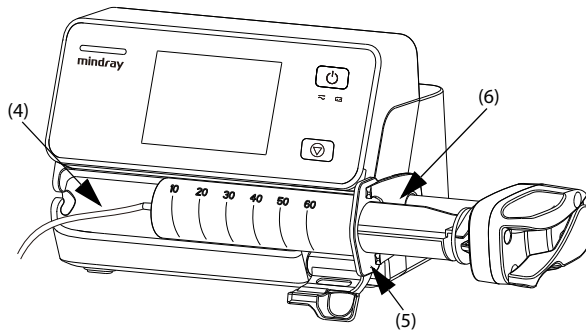

- Lift the syringe clamp (7) until it locks the syringe barrel (8). Squeeze the finger grips together and slide the driver head (9) to the left until it reaches the plunger (10) end. Release the finger grips, and the plunger grippers (11) automatically squeeze the plunger flange (12). Place the extension line into the extension set holder (13).

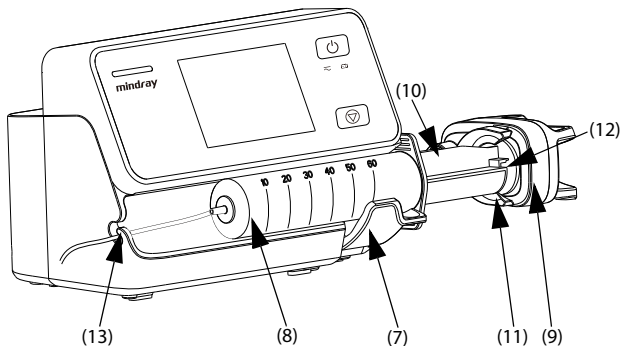

If the syringe is properly loaded, the syringe pump automatically identifies the syringe size and displays the volume in the brand selection area.

WARNING

- **Check that the syringe and the extension set are securely connected and there is no leakage.**
- **It is recommended that standard, single-use extension sets and syringes with Luer lock connections are used.**
- **We recommend you to use syringes and extension sets of the types and brands stated in this manual. If a non-recommended syringe must be used, perform the calibration and performance test before use. Otherwise, the accuracy of the infusion and the performance of the pump may be adversely affected.**
- **To ensure the accuracy of rate and alarm detection, the syringe size and brand should be calibrated using this pump before first use.**
- **The pump must be mounted within 51 ± 5 cm above the patient's heart. The most accurate pressure monitoring in the extension set is achieved when the pump is positioned close to the patients heart level.**
- **As the volume of fluid contained in the extension set and retained in the syringe at the end of infusion will not be infused, allow for this "dead space" volume when initially loading the syringe.**
- **Secure the extension set using the extension set holder. This provides protection against accidental dislodging of the syringe from the pump.**
- **Single use accessories are not designed to be reused. Reuse may cause a risk of contamination and affect the measurement accuracy.**

CAUTION



- **Ensure that the syringe is properly loaded. The barrel flange is in the space between the pump and the flange retainer. The plunger grippers squeeze the plunger flange. Failure to properly load the syringe could result in uncontrolled fluid flow.**
 - **To avoid possible uncontrolled fluid flow, disconnect the pump from the patient before loading or changing the syringe. And always keep the pump under close surveillance.**
 - **To avoid unexpected fluid flow due to height difference, place the syringe as close to the patient as possible.**
-

NOTE

- **The extension set and the pump should be placed in the same horizontal level before connected to the patient.**
-

4.3 Purge

The extension set and the syringe should be purged prior to being connected to a patient. If the extension set and the syringe are not purged before being loaded into the pump, proceed as follows to purge the line:

1. Ensure that the pump is disconnected from the patient.
2. Swipe the touchscreen from top down and select .
3. Select  to start purging.

NOTE

- **If required, set the purge rate after the purge starts. The initial purge rate is 1200 ml/h or the maximum rate that the pump can currently support according to the syringe size, whichever is smaller.**
 - **The volume used for purging is not added to the infused volume.**
-

4.4 Starting Infusion

To start infusion, follow this procedure:

1. Set infusion parameters, check the following:
 - ◆ Verify parameter settings according to the prescriber's order.
 - ◆ Verify that the displayed syringe brand and size correspond with the currently used syringe.
 2. Connect the infusion set to the patient access device.
 3. Press  to start infusion.
-
-

WARNING

- **Do not connect patient until disposables have been purged and loaded into the pump. Connecting to patient before disposables are loaded and purged can cause serious injury or death.**
- **Check the syringe status before infusion starts or after infusion stops, and confirm the infusion is started or stopped.**

- **Do not put your hand around the syringe flange clamp while the driver head is moving.**
-
-

NOTE

- **Always discharge the previous patient before starting a new infusion for new patient. Failure to do so can lead to data being attributed to the wrong patient.**
 - **Monitor the connection of syringe, extension set, pump and patient, and the drug information on a regular basis. Start infusion according to the instructions in this manual.**
-

4.5 Relay Infusion



To set up a relay infusion, follow this procedure:

1. Connect the pump to the CMS.
2. Swipe the touchscreen from top down, and select **Relay**.
3. Select the relay option: **Customized Relay** or **Circular Relay**.
4. From the desired pumps, select **Yes** in the dialog.
5. Select **Confirm** from the initial pump to complete the setting.
6. Select whether to synchronize the parameter settings:
 - ◆ **No:** Set the parameters of the pumps respectively, the settings of the current pump are not synchronized to other relay pumps.
 - ◆ **Yes:** Only set the parameters of the current pump, the settings of the current pump are synchronized to other relay pumps.
7. Select  from the first pump to start the relay infusion.

4.6 Bolus Infusion

Bolus infusion is a controlled volume of fluid or drug being delivered at an increased rate for diagnostic or therapeutic purposes. The pump should be connected to the patient during bolus infusion.

To perform bolus infusion, follow this procedure:

1. Select  from the main screen.
2. Set the bolus volume in the popup dialog.
3. Select  to start an automatic bolus infusion, or press and hold  to start a manual bolus infusion.

NOTE

- **The delivered bolus volume will be added to the total infusion volume and subtracted from the volume to be infused (VTBI).**
 - **The pump gives a beep every time a 0.5 ml bolus volume is infused.**
-

4.7 Changing the Infusion Parameters

You can modify rate, dose rate, target concentration or drug name without stopping the infusion. This function is called titration.

1. Select the above parameters in the infusion running screen.
2. Reconfigure the parameters in the popup dialogs.

To change other infusion parameters, follow this procedure:

1. Press  to pause the infusion.
2. Select the desired parameter area, and reconfigure parameters as per the prescriber's order.

NOTE

- **In the TCI mode, the drug name cannot be changed after the infusion is started.**
-

4.8 Pausing the Infusion

Press  to temporarily stop a running infusion.

Press  again to restart the infusion after the infusion solution change.

4.9 Setting Keep Vein Open (KVO) Rate

At the end of infusion, the pump continues to infuse at a very low rate. KVO is used to keep the patient's vein open, to prevent back flow or vascular occlusion.

The default KVO rate is 0.5 ml/h. To edit the KVO rate, follow this procedure:

1. Swipe the touchscreen from top down → select **Menu** → select **General Option**.
2. Set the **KVO Rate**. If **KVO Rate** is zero, the pump will not initiate a KVO infusion when the preset volume is complete.

NOTE

- **If the KVO rate is greater than the infusion rate, the pump will continue to infuse at the set infusion rate.**

- **The pump runs for 30 minutes at a KVO rate. At the completion of the KVO infusion, the pump stops infusion, and gives a KVO Finish alarm.**
- **The volume used during KVO infusion will be added to the total infusion volume.**

4.10 Unloading a Syringe

To unload the syringe, follow this procedure:

1. In the main screen, select  to stop the infusion.
2. Clamp the extension set.
3. Disconnect the patient from the extension set.
4. Remove the extension set from the extension set holder.
5. Pull down the syringe clamp, and remove the syringe from the pump.

WARNING

- **Change the extension set as per the manufacturer's instructions or the hospital regulation.**
- **To prevent free flow, make sure that the clamp has fully occluded the extension set before unloading a syringe.**

4.11 Viewing the Infused Volume

The **Volume** dialog allows you to review the infused volume of up to 24 hours. You can also view the infused volume of the configured time interval and time length.

Choose either of the following ways to enter the **Volume** dialog:

- Swipe the touchscreen from top down → select **Volume**.
- Select **Volume** from the **Pause** screen.

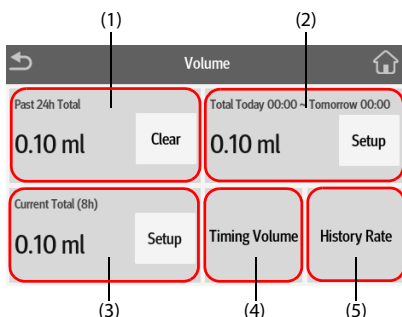

- (1) **Past 24h Total:** view the total infused volume in the past 24 hours. The display range is 0 ml to 99999.99 ml. Select **Clear** to clear the infused volume.
- (2) View the total infused volume in the configured time period. Configure the time period before viewing the total infused volume in the configured time period.
- (3) View the recent total infused volume. Configure the time before viewing the total infused volume within the configured time.
- (4) **Timing Volume:** view the total infused volume of the configured timing interval. Configure the **Timing Interval** before viewing the total infused volume of each interval.
- (5) **History Rate:** view the history rate.

4.12 Entering the Standby Mode

To enter the standby mode, hold the power switch and select **Standby**.

While the pump is in the standby mode, select  to set the standby time. The maximum standby time is 24 hours. When the configured standby time is expired, the pump triggers the **Standby Time Expired** alarm and exits the standby mode automatically.

To manually exit the standby mode, select .

4.13 Turning Off the Pump

To turn off the pump, press and hold the power switch and select **Turn Off**. If the syringe is not removed from the pump, the pump gives prompt message **Remove syringe to turn off**. Select **OK**, and unload the syringe.

CAUTION

- **Press and hold the power switch for no less than 10 seconds to forcibly shut down the pump if it could not be shut down normally. This may cause loss of patient data.**
-

NOTE

- **Turning off the pump does not disconnect the pump from the AC mains. To completely disconnect the power supply, unplug the power cord.**
-

5 Alarms

5.1 Alarm Safety Information

WARNING

- A potential hazard can exist if different alarm presets and default settings are used for the same or similar equipment in the same care area, for example an intensive care unit or cardiac operating room.
 - The equipment in your care area may each have different alarm settings to suit different patients. Always check that the alarm settings are appropriate for your patient before start infusing.
 - When the alarm sound is paused, the equipment gives no alarm tones even if a new alarm occurs. Be careful about whether to pause the alarm sound or not. When the alarm sound is paused, observe the patient frequently.
 - Do not rely exclusively on the audible alarm system during an infusion. Adjustment of alarm volume to a low level may result in a hazard to the patient. Always make sure that the audio alarm volume level is adequate in your care environment. Always keep the patient under close surveillance.
 - Fully evaluate the risk before changing the alarm mode setting. New alarms may be failed to be detected if the operator is not familiar with the new sound.
-
-

5.2 Understanding the Alarms

By severity, the alarms are classified into the high priority alarms and low priority alarms. When an alarm occurs, the equipment indicates it visually and audibly. For more information, see the following table.

Alarm priority	Alarm lamp color	Alarm lamp flashing frequency	Alarm sound interval	Alarm message	Alarm priority indicator	Duty Cycle
High priority alarm	Red	2.0 ± 0.6 Hz	5s (±2s)	White text or symbol inside a red box	!!!	20% to 60%

Alarm priority	Alarm lamp color	Alarm lamp flashing frequency	Alarm sound interval	Alarm message	Alarm priority indicator	Duty Cycle
Low priority alarm	Yellow	Not flashing	20s ($\pm 2s$)	Black text or symbol inside a yellow box	!	100%

NOTE

- The tones of the alarm sound and the reminder sound are different.
- The frequency of the reminder sound and the bolus sound is 600Hz, which is different from the frequency of alarm sound.
- When multiple alarms occur simultaneously, the alarm messages are displayed circularly, and the sound and light of the higher priority alarm are given.



5.3 Alarm Screen

When an alarm occurs, the alarm screen is displayed to help you identify the problem.



5.4 Resetting Alarms



When an alarm occurs, press  to acknowledge and reset the alarm. The alarm reset state has the following features:

- The alarm sound is silenced, and the alarm screen disappears.
- A  appears before the alarm message, indicating that the alarm is acknowledged.
- The alarm reset symbol  is displayed after the alarm message.

For the **Syringe Empty, VTBI Complete, KVO Finish, Standby Time Expired** and **Extension Line Detached** alarms, when they are reset, all the alarm indications (alarm sound, alarm message, and alarm light) disappear.

5.5 Pausing Alarm Sound



To enter the audio pause state, choose one of the following ways:

- Select  in the alarm screen.
- Swipe the touchscreen from top down, and select .

The audio pause state has the following features:

- Except for the **Battery Depleted** alarm, the sound of all alarms are silenced for two minutes.
- The audio pause symbol  is displayed in the system information area.
- If a new alarm is triggered during the audio pause state, the sound of the new alarm will also be silenced.

When the audio pause time expires, the audio paused state is automatically deactivated. You can also cancel the audio paused state by pressing  again.



For the **Low Battery, Reminder, Time Near End** and **Syringe Near Empty** alarms, press  and the pump gives a reminder sound every 5 minutes. The symbol  is displayed after the alarm message.



5.6 Alarm Solutions

WARNING

- **When an alarm occurs, check the pump's status and handle the alarm as soon as possible. If the alarms do not conform with the actual situation, contact your service personnel.**
-
-

Alarm	Priority	Causes	Solutions
Occlusion	High	An occlusion occurred and the preset pressure limit is exceeded.	<ul style="list-style-type: none"> • Check that tubing is not kink or damaged. • Check the pressure limit setting. Increase the limit if necessary.
Syringe Empty	High	No fluid is left in the syringe or the preset ml of Empty Alarm is reached.	<ul style="list-style-type: none"> • Press  to clear the alarm. • End the infusion or replace the syringe.

Alarm	Priority	Causes	Solutions
Syringe Disengaged	High	The syringe is disengaged.	Reload the syringe.
No Syringe	High	The syringe is not loaded properly, or start infusion when the syringe is not loaded.	Reload the syringe.
Plunger Grippers Error	High	The plunger grippers are opened during infusion.	Reload the syringe.
Extension Line Detached	Low	The extension set is disengaged.	Check and reconnect the extension set.
Syringe Near Empty	Low	The preset Time Near End is reached.	<ul style="list-style-type: none"> The alarm is cleared when the infusion is completed. End the infusion or replace the syringe.
Battery Depleted	High	The battery is depleted.	Connect the pump to the external power source.
VTBI Complete	High	The preset VTBI is completed.	<ul style="list-style-type: none"> Press  to reset the alarm. Continue therapy or select new therapy.
KVO Finish	High	The KVO infusion is running for thirty minutes.	<ul style="list-style-type: none"> Press  to reset the alarm. Continue therapy or select new therapy.
Relay Invalid	High	In the relay state, the upstream pumps have completed the infusions yet the downstream pumps are not ready for infusion.	Check that the downstream pumps are properly configured for infusion.
System Error	High	The pump system faults, such as storage error, hardware fault, etc.	Stop using the pump, and contact your service personnel.

Alarm	Priority	Causes	Solutions
KVO Running	Low	The infusion is completed and the pump continues infusion at the KVO rate.	<ul style="list-style-type: none"> The alarm is cleared after the KVO infusion reaches 30 minutes. Press  to pause the KVO infusion. Complete the infusion or prepare for a new therapy.
Battery in Use	Low	The external power source has been disconnected and the pump runs on battery power.	<ul style="list-style-type: none"> Press  to reset the alarm. Connect the pump to the external power source.
Battery Error	Low	Battery fault, such as battery over heat, charging failure, etc.	Contact your service personnel.
CMS/eGW Disconnected	Low	The pump is disconnected from the CMS, the wireless network connection symbol disconnects.	Reconnect the pump with the central station, the wireless network connection symbol restores.
Standby Time Expired	Low	The preset standby time is reached.	Press  to reset the alarm.
System Time Error	Low	The real time clock (RTC) reset or RTC fault.	Reset the system time.
Relay Invalid Soon	Low	In the relay state, the upstream pumps have almost completed the infusions yet the downstream pumps are not ready for infusion.	Check that the downstream pumps are properly configured for infusion.
Time Near End	Low	The remaining infusion time reaches the configured time near end or the remaining volume reaches the set Volume Near End .	Complete the infusion or prepare for a new therapy.
Reminder	Low	No operation is detected after the preset Reminder Time is reached.	Turn off the pump or enter the standby.

Alarm	Priority	Causes	Solutions
Low Battery	Low	Low battery.	Connect the pump to the external power source.
Para. Unconfirmed	Low	No operation is detected for 10 seconds in the parameter edit state.	<ul style="list-style-type: none"> Press  to acknowledge the alarm. Edit and confirm the parameter setting.

NOTE

- **The pump stops infusion when a high priority alarm is triggered.**
- **The pump continues infusion when a low priority alarm is triggered.**
- **The pump stops infusion after the first Battery Depleted alarm occurs, and the shutdown delay is at least three minutes.**

5.7 Occlusion Alarm

Signals collected by the built-in pressure sensor is used for pressure calculation by the internal Central Processing Unit (CPU). The calculated pressure value is compared with the set occlusion alarm limit, the pump gives prompt message **Pressure increasing.Occlusion?** when the pressure continuously increases for some time. The pump stops the infusion and gives an **Occlusion** alarm when the pressure exceeds the set limit.

The occlusion alarm delay time is subject to the syringe brand and size. If this pump is running at 5ml/h using B.Braun Original Perfusor Syringe 20ml and 50ml syringes, and configure the occlusion pressure alarm limit to 450mmHg, the occlusion alarm delay time may reach up to four minutes and 13 minutes, the bolus volume after occlusion may reach up to 0.10ml and 0.15ml. Occlusion pressure should be configured according to patient needs, to facilitate view the occlusion.

The pump restarts the infusion when the pressure that caused the alarm is reduced. When the number of auto restarts has been reached, the infusion will not restart after an occlusion alarm. A bolus reduction is automatically initiated by the pump after the restart is failed or the occlusion alarm is reset.

NOTE

- **If this pump is running at 0.1 ml/h using 50ml syringe, and respectively configure the occlusion pressure alarm limit to the lowest level and highest level, the occlusion alarm delay time may reach up to three hours and 27 hours. Adjust the pressure limit to a lower level, or use a small size syringe for the low rate infusion.**

6 Menu Options

6.1 General Option

Swipe the touchscreen from top down → select **Menu** → select **General Option**.

Menu Item	Range	Function
Near End Alarm	Alarm Method: Off, Time, Volume, Time & Volume	Set the mode of Time Near End and Syringe Near Empty alarms. The switch is turned off: the pump does not give the Time Near End and Syringe Near Empty alarms.
	Time Near End: 1, 2, 3, 4, 5, 6, 7, 8, 9, 10, 15, 20, 25, 30 min	Set for how long the Time Near End alarm is triggered since the infusion is completed.
	Volume Near End: 2/3ml syringe: 0.2 to 1ml 5/6/10/12ml syringe: 0.5~2ml 20ml syringe: 1 to 5ml 30/35ml syringe: 1 to 5ml 50/60ml syringe: 1 to 8ml	Set the volume amount that the Time Near End and Syringe Near Empty alarms are triggered since the infusion is completed.
ml of Empty Alarm	2/3ml syringe: 0 to 0.5ml 5/6/10/12ml syringe: 0~1ml 20ml syringe: 0 to 1.5ml 30/35ml syringe: 0 to 2ml 50/60ml syringe: 0 to 3ml	Set the remaining volume amount that the Syringe Empty alarm is triggered since the syringe is empty. Note: This setting is activated only if you set the Empty Alarm Mode to Remaining Volume .
Reminder Time	Off, 1, 2, 3, 4, 5 min	Set for how long the Reminder alarm is triggered since the pump is last operated.
Lock Time for No Infusion	Off, 1, 2, 3, 4, 5 min	Set for how long the touchscreen automatically locks since the pump is last operated while the pump is not infusing.

Menu Item	Range	Function
Lock Time in Infusion	Off, 15 sec, 30 sec, 1min, 2min, 3min, 4min, 5min	Set for how long the touchscreen automatically locks since the pump is last operated while the pump is infusing.
Dose Rate Unit	Weight, Body Surface Area	Set the dose rate unit for infusion modes.
Common Dose Unit	ng, ug, mg, g, mU, U, kU, EU, mmol, mol, mcal, cal, kcal, and mEq	Check or uncheck the dose unit.
Common Mode	Each infusion mode	Check or uncheck the infusion mode. The checked infusion mode will be displayed in the infusion mode list of the infusion status area.
Large Font	Primary: Dose Rate, Rate	Set the primary parameter can be displayed in the large font screen.
	Param 1: Time, VTBI, Volume, Weight/BSA	Set the parameter can be displayed in the large font screen.
	Param 2: Time, VTBI, Volume, Weight/BSA	Set the parameter can be displayed in the large font screen.

6.2 Department Management

Menu Item	Function
Applied Department	Display all departments in the current drug library. The checked department can be displayed in the title area of the drug selection screen. The drug in the drug selection screen switches to the drug of corresponding department. Different drug libraries can be configured for different departments.
Drug Management	Add drug, modify drug, and delete drug. Note: The build-in drug is not allowed to be deleted.
Config Management	Modify the parameter settings of the applied departments. After the parameters of configuration management are changed, the settings of general option and system options of the corresponding department will be changed synchronously.

6.3 System Options

Swipe the touchscreen from top down → select **Menu** → select **System Options**.

Menu Item	Function
Sound Volume	Set the sound volume. The set range is 1 to 8.
Brightness	Set the screen brightness. The set range is 1 to 8.
Brightness On Battery	Set the screen brightness when the pump runs on battery power. The set range is 1 to 8.
History Record	View the history record.
Export History Record	Export the history record.
Night Mode	Set the night mode switch, start time, end time, system volume, and screen brightness.
Nurse Call	Set the nurse call switch, signal type, trigger type, and alarm level.
Version Information	View the software version, brand library, drug library version, and Wi-Fi version.

6.4 User Maintenance

Swipe the touchscreen from top down → select **Menu** → select **User Maintenance** → input the required password → select .

CAUTION

- **The maintenance settings can only be changed by authorized personnel. Contact your department manager or biomedical engineering department for the passwords used at your facility.**
-

Menu Item	Function
Device Management	Set the facility, department, device name, QR code type, QR code prefix, and asset number. Scan the QR code from the screen to accept prescription.
Patient Information	Select the patient location and whether patient is discharged automatically after the pump is turned off.
Network Setup	Set the WLAN, WLAN IP, Central Station Setup, and device discover.
Brand Management	Add brand, delete brand, and modify brand.

Menu Item	Function
Time and Language	Set the date, time, date format, time format, and language. Note: This setting is effective after the pump has been restarted.
Unit Setup	Set the pressure unit. The options include: mmHg, kPa, bar, and psi. Set the weight unit. The options include: kg and lb. Set the height unit. The options include: cm and inch.
Alarm	Set the alarm sound mode and empty alarm mode.
Bolus Volume Unit	Sets the unit of bolus volume. The options include: ml and Dose.
Bolus Limit	Set the upper limit of the auto bolus volume setting, and the maximum volume of a manual bolus infusion.
Purge Limit	Set the maximum volume of the purge.
Prescription Setup	Set the infusion mode after the prescription is accepted.
Concentration Config	Set the concentration parameter for infusion modes.
Modify Password	Modify the password for accessing the User Maintenance menu.
Import and Export	Import configuration file, drug library or brand library from the USB drive. Export configuration or brand library to the USB drive.

7 Infusion Modes

The pump provide the following infusion modes: Rate Mode, Time Mode, Micro-infusion Mode, Dose Mode, Loading Dose Mode, Sequential Mode, Intermittent Mode, Ramp Mode, Dose Time Mode, TIVA Mode, and TCI Mode.

NOTE

- **The BeneFusion uSP ex does not provide the Loading Dose Mode.**
-

7.1 Rate Mode/Time Mode/Micro-infusion Mode

In rate mode, time mode, and micro-infusion mode, the IV drug therapy continues to infuse at a set rate. Micro-infusion mode is typically use for low rate infusions for neonatal and pediatric patients. The infusion modes offer four parameters: rate, time, VTBI and Conc. When two of rate, time and VTBI are entered, the third is calculated.

NOTE

- **When infusing in the rate mode, time mode, and micro-infusion mode, you must set rate, but time and VTBI settings are optional.**
-

7.2 Dose Mode

Dose mode allows you to specify the drug amount, diluent volume or concentration for a therapy. Dose mode is typically used for body weight drugs. The calculation formulas are as follows:

- $\text{Rate} = \text{Dose Rate} * \text{Weight} / \text{Conc.}$
- $\text{Dose Rate} = \text{Rate} * \text{Conc.} / \text{Weight}$
- $\text{Time} = \text{VTBI} / \text{Rate}$
- $\text{Conc.} = \text{Drug Amt.} / \text{Volume}$

You can change the concentration parameters (**Drug Amt.**, **Volume** or **Conc.**) and weight unit as needed.

NOTE

- **Time can only be obtained by calculation. It is not available for manual input.**

- **Some departments, for example the Neonatology, may use fixed drug amounts, diluent volumes, or concentrations. Using the drug info library to predefine these infusion parameters can simplify the setting process.**
-

7.3 Loading Dose Mode

In the loading dose mode, an infusion is divided into two stages:

- Deliver the loading dose at the loading dose.
- Deliver the remaining volume (**VTBI** minus **Loading Dose**) at the primary rate.

NOTE

- **If you do not configure the loading dose parameters, the pump infuses at the Primary Rate until the set VTBI is finished.**
-

7.4 Sequential Mode

In sequential mode, you can set several parameter groups. Each group defines a set of parameters: rate, time and VTBI. The pump infuses at the set sequence. You can add up to eleven sequences in the sequential mode.

7.5 Intermittent Mode

In the intermittent mode, intermittent infusion and maintenance are performed alternately and circularly.

- Intermittent stage: the pump runs the high rate infusion at the set **Rate** and **Intmt. Vol.**
- Maintenance stage: the pump runs the low rate infusion at the set **Maintain Rate** and **Intmt. Time**. The pump does not infuse at this stage if the **Maintain Rate** is not set.

NOTE

- **Total VTBI and Maintain Rate are optional parameters. If the Maintain Rate is not set, infusion stops at the maintenance stage. If the Total VTBI is not set, the infusion stops when the syringe is empty.**
-

7.6 Ramp Mode

In the ramp mode, the infusion is running at increasing or decreasing rates.

- Ramp up stage: in the set ramp up time, the infusion rate increases until steady rate is reached.
- Steady stage: the pump infuses at a steady rate.

- Ramp down stage: in the set ramp down time, the infusion rate decreases until the set VTBI is completed.

NOTE

- **The Steady Rate can only be obtained by calculation. It is not available for manual input.**
 - **Up Time and Down Time are optional parameters. The pump runs an infusion at the steady rate if they are not set.**
-

7.7 Dose Time Mode

The dose time mode allows the clinician to specify the drug amount, diluent volume or concentration. The dose mode is typically used for body weight independent drugs. The calculation formulas are as follows:

- $\text{Rate} = \text{Dose Rate}/\text{Conc.}$
- $\text{Dose Rate} = \text{Rate}*\text{Conc.}$
- $\text{Time} = \text{VTBI}/\text{Rate}$
- $\text{Conc.} = \text{Drug Amt.}/\text{Volume}$

You can change the concentration parameters (**Drug Amt.**, **Volume** or **Conc.**) as needed.

NOTE

- **In the dose time mode, the supported dose rate units are X/min, X/h, and X/24h, in which X represents ng, ug, mg, g, mU, U, kU, EU, mmol, mol, mcal, cal, kcal, and mEq.**
 - **Time can only be obtained by calculation. It is not available for manual input.**
-

7.8 TIVA Mode

The Total Intravenous Anaesthesia (TIVA) mode is typically used for infusing anaesthetics. In the TIVA mode, the infusion runs according to the set induction and maintenance parameters.

In the TIVA mode, the infusion is divided into two stages:

- Induction: delivers the induction dose in set induction time.
- Maintenance: the infusion runs at the calculated maintenance rate.

Induction rate and maintain rate can only be obtained by calculation. They are not available for manual input. The calculation formulas are as follows:

- $\text{Induction Rate} = \text{Weight}*\text{Induction Dose}/\text{Conc.}*\text{Induction Time}$
- $\text{Maintain Rate} = \text{Weight}*\text{MaintainDoseRate}/\text{Conc.}$

7.9 TCI Mode

In Target Controlled Infusion (TCI) mode, the desired concentration of drug in the human body (Target) is defined rather than an infusion rate. The pump reaches the set target concentration automatically by calculation using the algorithm based on a three-compartment pharmacokinetic model (PK model).

The pump offers two modes for TCI: Plasma Target Controlled Infusion (Cpt) and Effect-site Target Controlled Infusion (Cet).

The TCI mode can be used for infusing Propofol, Remifentanyl, Sufentanyl, and Alfentanil.

The set ranges of drug concentration and target concentration are as follows:

Drug Name	PK Model	Drug Concentration	Cpt	Cet
Propofol	Marsh	10.0 mg/ml (1%) or 20.0 mg/ml (2%)	0.0 to 15.0 ug/ml	0.0 to 15.0 ug/ml
	Schnider			0.0 to 15.0 ug/ml
	Kataria (Pediatric)			/
	Paedfusor (Pediatric)			/
Remifentanyl	Minto	20 to 50ug/ml	0.0 to 20.0 ng/ml	0.0 to 20.0 ng/ml
Sufentanyl	Gepts	0.2 to 5ug/ml	0.00 to 2.00 ng/ml	0.00 to 2.00 ng/ml
Alfentanil	Maitre	100 to 500ug/ml	0.0 to 500 ng/ml	0.0 to 500 ng/ml

CAUTION

- **TCI mode is intended for adult and pediatric patients.**
- **Avoid using the extension set that is too long or too curl, or whose line diameter is too small, as such extension sets are unfavorable for liquid flowing. Unexpected occlusion alarm may be triggered when the pump is running at the initial rate of the TCI mode using such extension sets. It is recommended that extension sets with the inner diameter of at least 1.5 mm should be used.**
- **The estimated Ce and Cp are for reference only.**
- **When the pump is restarted after an accidental power down or crash, the TCI of the same drug is not allowed.**

- **The default TCI parameters are not suitable for all patients and should be adjusted according to patient characteristics.**
 - **As for patients with old age, heart failure, hepatorenal function failure, plasma esterase abnormality, ASA classification III-IV, recombination application of other drugs or other PK-PD process, we recommend using plasma target mode at lower Cpt, and slowly increase Cpt according to actual situation of the patients. Please refer to the prescription data of drugs for the influencing factors of PK-PD process.**
 - **TCI should only be performed by experienced anaesthetists who is fully aware of the available literature for any parameter set used in association with a drug and needs to refer to the prescribed information for rate and dosing limits.**
 - **Pharmacokinetic and pharmacodynamic interactions among anaesthetic drugs are known, but are not taken into account into the calculation of the plasma and effect site concentrations. They have to be taken into account by the user.**
 - **The user should be fully aware of the drug to be infused, and check the patient information and the set target concentration conform with the prescription.**
-

NOTE

- **If the infused drugs are diluted, ensure that the right concentration is entered.**
 - **Ensure that the parameter settings conform with the prescription. The patient information and drug name cannot be changed after the TCI is initiated.**
 - **When the TCI is completed, the same drug cannot be infused again to the same patient.**
-

This page intentionally left blank.

8 Drug Library/Drug Info Library

The pump can be configured with a drug library or a drug info library, which predefines drugs, concentrations, occlusion pressure levels and other infusion parameters. Using a drug library or drug info library simplifies the infusion operation, and reduces the risk of operation fault.

The drug library and the drug info library are created, edited, and imported via their respective PC programs. They have the following features:

- Saving at least 5000 drug names.
- At least 30 colors are available for drug marking.
- Supporting at least 30 drug categories.
- Predefining drugs, concentrations, occlusion pressures, KVO rate, bolus volume limit.

The difference of the drug library and the drug info library are as follows:

- Software license is required to activate imported drug library.
- The drug library supports Dose Error Reduction Systems (DERS). The drug library and the drug info library can be imported to this pump after being created via the PC program. If the set value exceeds the limit, the pump gives prompts.
- You can predefine the infusion modes and corresponding parameters in the drug info library. When the drug is selected, the pump automatically load the infusion mode and corresponding parameters.

CAUTION

- **The drug library and the drug info library should be created by professionals. Checked that the drug and parameter settings are suitable for the care area before use.**
 - **The facility is responsible for performing initial checks to ensure that the proper drug library / drug info library is loaded.**
-

NOTE

- **The predefined parameters can be changed during a therapy. This does not affect the embedded library.**
-

This page intentionally left blank.

9 Networked Communication

The equipment can be connected to the BeneFusion nCS Infusion Supervision System and BeneVision Central Monitoring System (hereafter both referred to as “CMS”), and the eGateway.

9.1 Network Safety Information

CAUTION

- **Wireless network designing, deploying, debugging, and maintenance should be executed by the service personnel or authorized technicians.**
 - **Always set the wireless network according to local wireless regulations.**
 - **Data communication for all network functions must be performed within a closed network or within a virtually isolated network provided by a hospital. The hospital is responsible for ensuring the security of the virtually isolated network.**
 - **Keep network authentication information, for example password, safe, protecting the network from being accessed by unauthorized users.**
 - **Do not connect non-medical devices to the network.**
 - **If wireless network signal is poor, there may be a risk of CMS data loss.**
 - **RF interference may result in wireless network disconnection.**
 - **Disconnecting from the network may result in CMS data loss and function failure. Check the patient in case of network disconnection and solve the network problem as soon as possible.**
 - **Ensure that the IP address setting is correct. Changing the network settings may result in network disconnection. Contact your service personnel if you have any problems on setting the IP address.**
-

9.2 Connecting the Equipment to the CMS

The equipment can be connected to the CMS through the wireless network. When connected to the CMS, the system provides the following function:

- The equipment can transmit infusion information, alarm information, and equipment information (such as battery and network) to the CMS.
- Patient information can be synchronized between the equipment and the CMS.

- Patient can be admitted or discharged by the CMS, and patient information can be transmitted to this equipment.

9.3 Connecting the Equipment to the eGateway

You can connect the equipment to the eGateway to implement interaction between the equipment and the Hospital Information System (HIS) via the HL7 protocol. When connected to the eGateway, the system provides the following functions:

- The equipment can transmit infusion information and drug information to the eGateway.
- Patient information can be synchronized between the equipment and the eGateway.

10 Maintenance

Regular maintenance is essential to ensure that the equipment functions properly. This chapter contains information on periodic testing and maintenance.

10.1 Maintenance Safety Information

WARNING

- **To avoid electric shock, stop using the equipment if you find the housing of the equipment has signs of broken. Contact the service personnel for help in that case.**
 - **Failure on the part of the responsible individual hospital or institution using this equipment to implement a recommended maintenance schedule may cause undue equipment failure and possible health hazards.**
 - **No modification of this equipment is allowed.**
 - **This equipment contains no user serviceable parts.**
 - **The safety checks or maintenance involving any disassembly of the equipment should be performed by professional service personnel. Otherwise, undue equipment failure and possible health hazards could result.**
 - **The service personnel must be properly qualified and thoroughly familiar with the operation of the equipment.**
-
-

CAUTION

- **The equipment and accessories shall not be served or maintained while in use with a patient.**
 - **If you discover a problem with the equipment, such as the product label falls off or illegible, contact your service personnel.**
-

NOTE

- **If needed, contact the manufacture for circuit diagrams, component part lists, descriptions, calibration instructions, or other information concerning the repair of the equipment.**
-

10.2 Maintenance and Testing Schedule

Follow the maintenance and testing schedule or local regulations to perform testing and maintenance. Make sure to clean and disinfect the equipment before taking any tests and maintenance. The following table lists the maintenance and testing schedule:

Test/Maintenance Item		Recommended Frequency
Performance Tests		
Tests required by IEC 60601-2-24:2012		<ul style="list-style-type: none"> • Once every three years. • When you suspect that the occlusion alarm is abnormal. • When you suspect that the rate is abnormal. • The syringe is not properly recognized. • The Syringe Empty alarm is not properly presented.
Safety Tests		
Electrical safety tests		<ul style="list-style-type: none"> • Once every three years, or if required. • When the power board is repaired or replaced. • When the main board is replaced. • When the equipment drops to the ground.
Other Tests		
Visual inspection		Every day, before first use.
Power-on test		Each time the equipment is powered on.
Battery check	Functionality test	<ul style="list-style-type: none"> • When the battery is first installed. • When the battery is replaced.
	Performance test	Every four months or if the battery runtime reduces significantly.
Pressure calibration, syringe calibration, and sensor calibration.		If the performance test fails. For more information, see the service manual.

Except the regular check and battery check, all other test and maintenance tasks should be performed by the qualified service personnel only. If your equipment needs a safety test and performance test, contact the service personnel.

10.3 Maintaining the Battery

To optimize performance, a fully or nearly fully discharged battery should be charged as soon as possible. The battery is recharged automatically when the equipment is connected to AC mains power.

The service life of a battery depends on how frequent it is used. When properly used, the lithium-ion battery has a service life of three years. If improperly used, its service life can be shorten. We recommend replacing the battery every three years.

The performance of the battery deteriorates over operating time or storage time. You should condition the battery every four months.

WARNING

- **Use only specified battery. Use of a different battery may present a risk of fire or explosion.**
- **The battery must only be installed and replaced by service personnel trained and authorized by Mindray Scientific.**
- **Do not crush, drop or puncture the battery. Mechanical abuse can lead to internal damage and internal short circuits. If a battery has been dropped or banged against a hard surface, whether damage is externally visible or not, remove the battery from use and dispose of it properly.**
- **If the battery shows signs of damage or signs of leakage, replace it immediately. Use caution in removing the battery. Avoid contacting the leakage.**
- **Extremely high ambient temperature may cause battery overheat protection, resulting in equipment shutdown.**
- **The lithium-ion battery has a service life. Replace your battery when it reaches the end of its service life. Failure to replace the battery may cause serious damage to your equipment from battery overheating.**
- **Do not open the battery, heat the battery above 60 °C, incinerate battery, or short battery terminals. They may ignite, explode, leak or heat up, causing personal injury.**

NOTE

- **Remove the battery if it will not be used for an extended period of time.**
- **The battery should be charged only in this equipment.**
- **Storing the battery at high temperature for an extended period of time will significantly shorten their life expectancy.**
- **Storing the battery in a cool place can slow the aging process. Ideally the battery should be stored at 15 °C.**

- **If the battery is not conditioned for a prolonged time, its charge indication may not be accurate and you may wrongly evaluate the remaining battery runtime.**
 - **Do not use the pump for infusion during battery conditioning.**
 - **Do not interrupt battery conditioning.**
-

10.4 Checking the History Record

The **History Record** menu shows the history of pump activities, including the infusions, alarms, calibrations, maintenance configurations, and other operations.

NOTE

- **A total loss of power has no impact on the history records stored.**
 - **Alarms are saved as events and will remain if the equipment is powered down. The time of equipment power down is also recorded as an event.**
 - **The pump stores up to 5000 events. When the capacity is reached, earlier events will be overwritten by later ones.**
-

10.5 Disposing of the Equipment

The service life of this equipment is ten years. Dispose of the equipment when its service life is reached. Follow local regulations regarding the disposal of such product.

WARNING

- **For disposal of parts, batteries, packaging materials, and accessories, where not otherwise specified, follow local regulations regarding disposal of hospital waste.**
-
-

11 Care and Cleaning

In this chapter we only describe cleaning and disinfection of the pump and pole clamp. For the cleaning and disinfection of other reusable accessories, refer to their instructions for use.

11.1 Care and Cleaning Safety Information

WARNING

- **Use only the approved cleaners, disinfectants and methods listed in this chapter to clean and disinfect your equipment and accessories. Warranty does not cover damage caused by unapproved substances or methods.**
 - **Do not mix disinfecting solutions, as hazardous gases may result.**
 - **We make no claims regarding the efficacy of the listed chemicals or methods as a means for controlling infection. For the method to control infection, consult your hospital's infection control officer or epidemiologist.**
 - **The responsible hospital or institution shall carry out all cleaning and disinfection procedures specified in this chapter.**
-

CAUTION

- **Turn off the equipment and remove the power cord from the equipment before cleaning and disinfecting.**
 - **Never immerse any part of the equipment or accessories in liquids or allow liquid to enter the interior of the equipment or accessories.**
 - **Any contact of cleaners or disinfectants with connectors or metal parts may cause corrosion.**
 - **Do not pour or spray any liquid directly on the equipment or accessories or permit fluid to seep into connections or openings.**
 - **If you spill liquid on the equipment or accessories, disconnect the power supply, dry the equipment, and contact your service personnel.**
 - **Never use abrasive materials (such as steel wool or silver polish), or erosive cleaners (such as acetone or acetone-based cleaners).**
 - **Dilute and use the cleaners or disinfectants according to the manufacturer's instructions.**
-

- **Check the equipment after cleaning and disinfecting. If there is any sign of damage, remove it from use.**

11.2 Cleaning the Equipment

Clean the equipment on a regular basis. Before cleaning, consult your hospital's regulations.

To clean the equipment, follow this procedure:

1. Dampen a soft lint-free cloth with water or ethanol (70%).
2. Wring excess liquid from the cloth.
3. Wipe the display screen of the equipment.
4. Wipe the external surface of the equipment with the damp cloth, avoiding the connectors and metal parts.
5. Dry the surface with a clean cloth. Allow the equipment air dry in a ventilated and cool place.

11.3 Disinfecting the Equipment

Disinfect the equipment as required in your hospital's servicing schedule. Cleaning the equipment before disinfecting is recommended. Always dilute and use disinfectants according to the manufacturer's instructions. The following table lists approved disinfectants:

Product Name	Product Type	Manufacturer
Alpet® D2 Surface Sanitizing Wipes	Wipes	BEST SANITIZERS INC™.
CIDEX® OPA	Liquid	Gilag GmbH International Advanced Sterilization products
Clorox Dispatch® Hospital Cleaner Disinfectant Towels with Bleach	Wipes	Clorox professional products company
Clorox Healthcare® Bleach Germicidal Wipes	Wipes	Clorox professional products company
Clorox Healthcare® Hydrogen Peroxide Cleaner Disinfectant Wipes	Wipes	Clorox professional products company
Diversey Oxivir® TB Wipes	Wipes	Diversey Inc
Metrex CaviCide1™	Liquid, spray	METERX® RESEARCH

Product Name	Product Type	Manufacturer
Metrex CaviWipes™	Wipes	METERX® RESEARCH
PDI Sani-Cloth® AF3 Germicidal Disposable Wipe	Wipes	PDI Inc.
PDI Sani-Cloth® Bleach Germicidal Disposable Wipe	Wipes	PDI Inc.
PDI Sani-Cloth® HB Germicidal Disposable Wipe	Wipes	PDI Inc.
PDI Sani-Cloth® Plus Germicidal Disposable Cloth	Wipes	PDI Inc.
PDI Super Sani-Cloth® Germicidal Disposable Wipe	Wipes	PDI Inc.
VIRAGUARD® Hospital Surface Disinfectant Towelette	Wipes	VERIDIEN corporation
Virex® II 256 (1:256)	Liquid	Diversey Inc
Virex® TB	Liquid, spray	Diversey Inc
JIAN ZHI SU Disinfectant Tablets	Tablet	Beijing ChangJiangMai Medical Science Technology Co. Ltd
JIAN ZHI SU Surface Disinfectant Spray	Liquid, spray	Beijing ChangJiangMai Medical Science Technology Co. Ltd
JIAN ZHI SU Disinfectant, Double-chain Quaternary Ammonium	Liquid	Beijing ChangJiangMai Medical Science Technology Co. Ltd
DIAN'ERKANG Surface Wipes	Wipes	Shanghai Likang Disinfectant Hi-Tech Co., Ltd
DIAN'ERKANG Surface Disinfectant	Liquid	Shanghai Likang Disinfectant Hi-Tech Co., Ltd
DIAN'ERKANG Disinfectant Spray	Liquid, spray	Shanghai Likang Disinfectant Hi-Tech Co., Ltd
Clinell® Universal Wipes	Wipes	GAMA Healthcare Ltd
Clinell® Sporicidal Wipes	Wipes	GAMA Healthcare Ltd

Product Name	Product Type	Manufacturer
Tristel Duo™	Liquid, foam	Tristel solutions Limited
Tristel Jet	Liquid, spray	Tristel solutions Limited
Tristel Fuse For Surfaces, 196ppm	Liquid	Tristel solutions Limited
Surfanios Premium, 0.25%	Liquid	ANIOS LABORATORIES
Surfa 'safe	Liquid, spray	ANIOS LABORATORIES
Wip' Anios premium	Wipes	ANIOS LABORATORIES
Aniosurf ND premium, 0.25%	Liquid	ANIOS LABORATORIES
Mikrobac® Tissues	Wipes	BODE Chemie GmbH
Cleanisept® Wipes	Wipes	Dr. Schumacher GmbH
mikrozid® PAA Wipes	Wipes	Schülke & Mayr GmbH
mikrozid® Sensitive Wipes	Wipes	Schülke & Mayr GmbH
Ecolab Incidin® OxyWipe S	Wipes	Ecolab Deutschland GmbH
Glutaraldehyde, 2%	Liquid	/
Ethanol, 70%	Liquid	/
Isopropanol, 70%	Liquid	/
Sodium hypochlorite bleach, 0.5%	Liquid	/
Hydrogen peroxide, 3%	Liquid	/
Rely+On™ Virkon® High Level surface Disinfectant, 1%	Powder	Antec International Ltd
1-Propanol, 50%	Liquid	/
Descosept® forte	Liquid	Dr. Schumacher GmbH
Descosept® AF	Liquid	Dr. Schumacher GmbH

Product Name	Product Type	Manufacturer
Dismozon® plus, 0.4%	Powder	BODE Chemie GmbH
mikrozid® AF Wipes	Wipes	Schülke & Mayr GmbH
Terralin® Liquid	Liquid	Schülke & Mayr GmbH
Perform® Classic Concentrate OXY, 0.5%	Powder	Schülke & Mayr GmbH

11.4 Cleaning the Pole Clamp

Clean the pole clamp on a regular basis. To clean the pole clamp, follow this procedure:

1. Clean the pole clamp with a soft cloth moistened with water or ethanol (70%).
2. Wipe off the cleaner residue with a dry cloth.
3. Allow the pole clamp to air dry.

11.5 Disinfecting the Pole Clamp

We recommend that the pole clamp should be disinfected only when necessary as determined by your hospital's policy.

Cleaning the accessories before disinfecting is recommended.

Product Name	Product Type	Manufacturer
Isopropanol, 70%	Liquid	/
Hydrogen peroxide, 3%	Liquid	/
Perform® Classic Concentrate OXY, 0.5%	Powder	Schülke & Mayr GmbH
Dismozon® plus, 0.4%	Powder	BODE Chemie GmbH
Descosept® AF	Liquid	Dr. Schumacher GmbH
Descosept® forte	Liquid	Dr. Schumacher GmbH
mikrozid® AF Wipes	Wipes	Schülke & Mayr GmbH
Rely+On™ Virkon® High Level surface Disinfectant, 1%	Powder	Antec International Ltd

Product Name	Product Type	Manufacturer
Terralin® Liquid	Liquid	Schülke & Mayr GmbH

CAUTION

- **To avoid long term damage, the accessories should be disinfected only when necessary as determined by your hospital's policy.**
-

11.6 Sterilization

Sterilization is not recommended for this equipment, related products, accessories, or supplies unless otherwise indicated in the Instructions for Use that accompany the products, accessories or supplies.

12 Accessories

The accessories listed in this chapter comply with the requirements of IEC 60601-1-2 when in use with the equipment. For details about the accessories, refer to the instructions for use provided with the accessory.

WARNING

- **Use accessories specified in this chapter. Using other accessories may cause damage to the equipment or not meet the claimed specifications.**
-
-

CAUTION

- **The accessories may not meet the performance specifications if stored or used outside the specified temperature and humidity ranges. If accessory performance is degraded due to aging or environmental conditions, contact your service personnel.**
 - **Check the accessories and their packages for any sign of damage. Do not use them if any damage is detected.**
 - **Use the accessories before the expiry date if their expiry date is indicated.**
-
-

PN	Description
0020-20-12522	Power cord, 10A, 250V, 2.5m, International
009-001791-00	Power cord, 250V, 16A, 3m, South Africa
009-002636-00	Power cord, 10A, 1.5m, Australia standard
009-007190-00	Power cord, 3m, India
DA8K-10-14452	Power cord, USA
DA8K-10-14453	Power cord, UK
DA8K-10-14454	Power cord, Europe
009-009838-00	Nurse call cable
009-014769-00	DC power cord
115-089928-00	Pole clamp

This page intentionally left blank.

A Product Specifications

A.1 Specifications

Classifications	<p>Connect to AC power source, type of protection against electrical shock: CLASS I EQUIPMENT, equipment energized from an internal electrical power source</p> <p>Connect to DC power source, type of protection against electrical shock: CLASS II EQUIPMENT, equipment energized from an internal electrical power source</p> <p>Degree of protection against electrical shock: Defibrillation-proof type CF applied part (direct cardiac application)</p> <p>Mode of operation: Continuous</p> <p>Degree of protection against harmful ingress of water: IP44</p> <p>Degree of mobility: Portable</p>
Operating conditions	<p>Temperature: 5°C to 40°C</p> <p>Relative humidity (noncondensing): 15% to 95%</p> <p>Barometric: 57.0 kPa to 107.4 kPa</p>
Storage conditions	<p>Temperature: -20°C to 60°C</p> <p>Relative humidity (noncondensing): 10% to 95%</p> <p>Barometric: 16.0 kPa to 107.4 kPa</p> <p>Corrosive-free and ventilated</p>
Shock	<p>Complies with requirements for medical devices of 6.3.4, EN1789 (10.1.3 a, IEC60601-1-12):</p> <p>Peak acceleration: 300m/s² (30g)</p> <p>Duration: 11ms</p> <p>Pulse shape: half-sine</p> <p>Number of shocks: 3 shocks per direction per axis (18 shocks in total)</p>
Vibration	<p>Complies with requirements for medical devices of 6.3.4.2, EN1789 (10.1.3 b, IEC60601-1-12):</p> <p>10 Hz to 100 Hz: 5.0 (m/s²)²/Hz</p> <p>100 Hz to 200 Hz: -7 dB/Octave</p> <p>200 Hz to 2000 Hz: 1.0 (m/s²)²/Hz</p> <p>Duration: 30 minutes per direction per vertical axis (3 axes in total)</p>
Free fall	<p>Complies with requirements for medical devices of 6.3.4, EN1789 (10.1.3 c, IEC60601-1-12):</p> <p>Height of fall: 0.75 m</p> <p>Number of falls: 1 on each of the six surfaces</p>

Power Supply	AC Power Supply: 100 VAC to 240 VAC, 50/60 Hz, 0.30A to 0.13A DC Power Supply: 10 VDC to 16 VDC, 2.0A to 1.3A
Battery run time	At least 6.5 hours for normal battery, at least 12.5 hours for smart battery, and at least 21 hours for dual smart batteries (operating at a rate of 5ml/h, under standard operating conditions*) *Operating with a fully charged new battery at 20°C ± 2°C, default screen brightness and volume, Wi-Fi disabled, without accessories.
Battery charge time	≤ 5 hours for normal battery, ≤ 6 hours for smart battery, and ≤ 12 hours for dual smart batteries (the pump is off, and charged by the AC power supply).
Shutdown delay	Operating at a rate of 5ml/h, at least 30 minutes after first low battery alarm
Main unit weight	≤ 1.7 kg (with normal battery, without pole clamp) Pole clamp ≤ 0.15 kg
Main unit (W × D × H)	252mm x 118mm x 134mm (without pole clamp, the error is ±3mm)
Display	3.5 inches Color TFT LCD, resolution ≥ 320x480 pixels
Speaker	Gives alarm tones (sound pressure 50 to 75 dB). Supports multi-level tone modulation. Alarm tones comply with IEC 60601-1-8

NOTE

- **The equipment is not suitable for use in the presence of a flammable anesthetic mixture with air or with oxygen or nitrous oxide.**
- **When stored under temperature conditions beyond the defined operating conditions, the equipment needs to be placed under room temperature at least one hour before use.**
- **The pump may not meet the performance specifications if stored or used outside the specified temperature and humidity ranges. If the performance of the equipment is degraded due to aging or environmental conditions, contact your service personnel.**

A.2 Wireless Network

Standards	IEEE 802.11a/b/g/n
-----------	--------------------

Modulation mode	BPSK, QPSK, 16-QAM, 64-QAM
Operating frequency	2412MHz to 2472MHz 5180MHz to 5320MHz 5500MHz to 5700MHz 5745MHz to 5825MHz
Data rate	IEEE 802.11a: 6 to 54 Mbps IEEE 802.11b: 1 to 11 Mbps IEEE 802.11g: 6 to 54 Mbps IEEE 802.11n: MCS0 to MCS7
Transfer power	< 20 dBm (CE requirement: detection mode – RMS) < 30 dBm (FCC requirement: detection mode – PEAK)
Operating mode	Transmitting data through the wireless access point (AP)
Data security	Standard: OPEN and WPA/WPA2-PSK Encryption: TKIP and AES
System capacity	Number of the pumps supported by a single AP: ≤ 16
Data transmission delay between the pump and the CMS	Total data transmission delay time between the pump and the CMS is $\leq 8s$
Interruption number and time between the pump and the CMS	Total interruption duration $\leq 0.01*$ total communication time (Test within 24 hours, with 16 pumps, in which three pumps are roaming for 30 times)
Delay time of network disconnection alarm	$\leq 14 s$

A.3 Infusion Specifications

Compatible syringe sizes	2ml/3ml, 5ml/6ml, 10ml/12ml, 20ml, 30ml/35ml, 50ml/60ml
Accuracy	Mechanical accuracy: $\leq \pm 0.5\%$ Infusion accuracy* ($0.01\text{ml/h} \leq \text{rate} < 0.1\text{ml/h}$): $\leq \pm 5\%$ Infusion accuracy* ($0.1\text{ml/h} \leq \text{rate} \leq 2300\text{ml/h}$): $\leq \pm 1.8\%$ or $\pm 0.005\text{ml/h}$, whichever is greater Bolus accuracy: $\leq \pm 2\%$ or 0.05ml , whichever is greater (under standard operating conditions, test in accordance with IEC60601-2-24:2012) *Infusion accuracy use Double-Dove and B.Braun Original Perfusor Syringe, under standard operating conditions, test in accordance with IEC60601-2-24:2012)

Remaining infusion time error	±10%
Set range of the infusion rate/ purge rate/bolus rate	0.01 to 150ml/h (2/3ml syringe) 0.01 to 300ml/h (5/6ml syringe) 0.1 to 800ml/h (10/12ml syringe) 0.1 to 1200ml/h (20ml syringe) 0.1 to 1500ml/h (30/35ml syringe) 0.1 to 2300ml/h (50ml/60ml syringe and 60ml syringe) Resolution: 0.01ml/h (0.01 to 99.99ml/h) 0.1ml/h (100.0 to 999.9ml/h) 1ml/h(1000 to 2300ml/h) Range of the infusion rate for micro-infusion mode: 0.01 to 100ml/h
Occlusion pressure	50mmHg to 1125mmHg Resolution: 1mmHg 1000mmHg to 1125mmHg: not applicable for 50ml/ 60ml syringe The maximum occlusion pressure is 1350mmHg.
Occlusion pressure tolerance	50mmHg to 149mmHg: ≤ ±75mmHg (operating at a rate ≤ 100 ml/h) 150mmHg to 1125mmHg: ≤ ±20% or ≤ ±125mmHg, whichever is greater (operating at a rate ≥ 0.1ml/h)
Maximum volume (under single fault conditions)	≤ 0.2ml
KVO rate	0.01 to 5.0ml/h Minimum resolution: 0.01ml/h
Time set range	00:00:01 to 99:59:59 (h:min:sec)
VTBI set range	0.01 to 9999.99 ml Minimum resolution: 0.01ml Micro-infusion mode: 0.01 to 1000ml
Weight set range	0.1 to 499.0 kg/0.2 to 1100.1 lb
Drug Amt. set range	0.001 to 99999
Drug Amt. unit set range	ng, µg, mg, g, mU, U, kU, EU, mmol, mol, mcal, cal, kcal, mEq
Volume set range in Dose Time Mode/Dose Mode/TIVA Mode	0.1 to 9999.99ml
Conc. set range	0.001 to 9999.99

Conc. unit set range	ng/ml, µg/ml, mg/ml, g/ml, mU/ml, U/ml, kU/ml, EU/ml, mmol/ml, mol/ml, mcal/ml, cal/ml, kcal/ml, mEq/ml
Dose Rate set range	0.001 to 99999
Patient management	Discharging/admitting a patient, Editing/exporting/importing patient information
Prescription	Accepting and performing the prescription

WARNING

- **The infusion accuracy and pressure detection is affected by viscosity of liquids and disposables used (for example diameter, plunger, material, and needle).**
-
-

NOTE

- **The infusion accuracy tests and occlusion pressure tests are performed in accordance with IEC60601-2-24:2012 (test temperature: 20°C ± 2°C).**
-

A.4 Recommended Syringes

Product Name	Size	Manufacturer
Sterile Hypodermic Syringes for Single Use	5ml, 10ml, 20 ml, 30 ml, 50ml	Double-Dove
B. Braun Original Perfusor Syringe	20ml, 50ml	B. Braun Melsungen AG
B. Braun Omnifix Luer Lok Solo	2ml, 3ml	B. Braun Melsungen AG

NOTE

- **The recommended extension set is B.Braun Original Perfusor Line (using IV-Standard-PE, and with Luer lock).**
 - **The pump will not affect the quality of disposables from other suppliers. Changes in quality may affect the technical data of the pump. Mindray Scientific is not responsible for such changes.**
-

A.5 Occlusion Alarm Delay and Bolus Volume

Syringe size (ml)	Rate (ml/h)	Occlusion alarm delay time (hh: mm: ss)	
		High occlusion alarm pressure level	Low occlusion alarm pressure level
20	1	< 00:52:00	< 00:03:55
	5	< 00:09:05	< 00:00:45
50	1	< 02:43:48	< 00:09:28
	5	< 00:32:07	< 00:03:53

Syringe size (ml)	Rate (ml/h)	Bolus volume after occlusion (ml)	
		High occlusion alarm pressure level	Low occlusion alarm pressure level
20	5	< 0.2	< 0.1
50	5	< 0.3	< 0.15

Test conditions:

- Syringe brand: B.Braun Original Perfusor Syringe, B. Braun extension line
- Test temperature: 20°C ±2°C

WARNING

- **Occlusion alarm pressure, alarm delays and bolus volume may vary depending on test conditions, temperature and tube length. Using syringe of a larger size and infusing at a lower rate may cause longer occlusion alarm delay.**
-

A.6 Infusion Accuracy Graphs

A.6.1 Infusion Accuracy at 1 ml/h

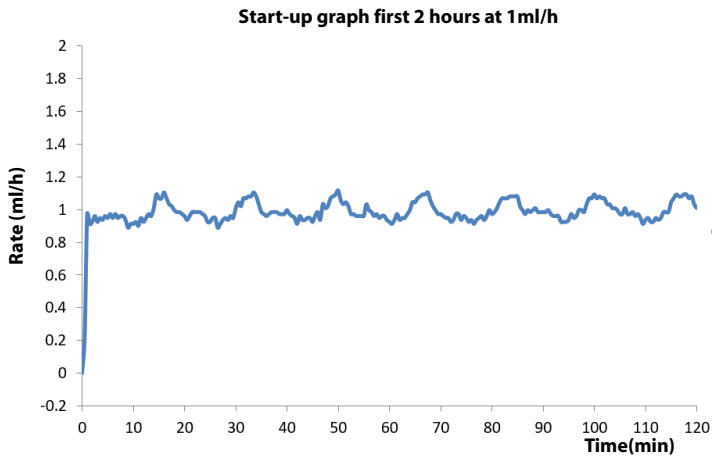
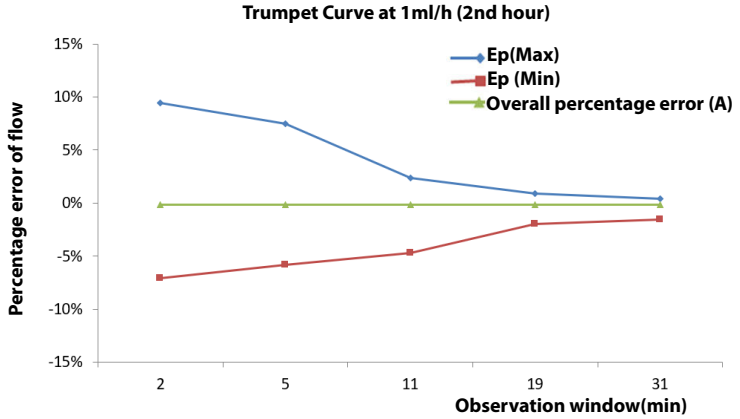

A.6.2 Infusion Accuracy at 5ml/h

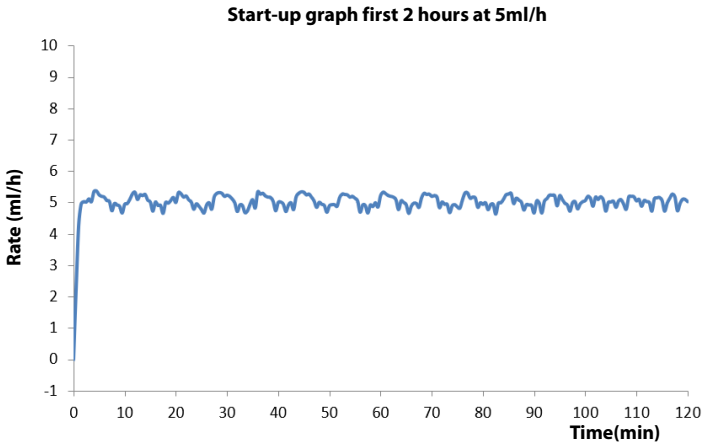
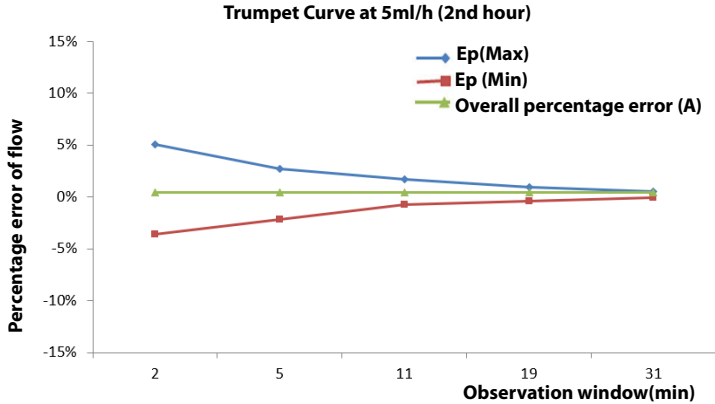

Test conditions:

- Syringe brand: B.Braun Original Perfusor Syringe, B.Braun extension set
- Syringe size: 50ml
- Test interval: $\Delta t = 0.5$ minute

WARNING

- Infusion accuracy may be influenced by the pump's environment (such as pressure, temperature, humidity, and any infusion consumables used).
-
-

A.7 Operating Environment

Operating system	FreeRTOS
Classification	OS Core
Version Information	9.0.0

This page intentionally left blank.

B EMC and Radio Regulatory Compliance

B.1 EMC

The device meets the requirements of IEC 60601-1-2: 2020.

WARNING

- **Use of accessories, transducers and cables other than those specified or provided by the manufacturer of this device could result in increased electromagnetic emissions or decreased electromagnetic immunity of this device and result in improper operation.**
 - **Use of this device adjacent to or stacked with other device should be avoided because it could result in improper operation. If such use is necessary, this device and the other device should be observed to verify that they are operating normally.**
 - **Portable RF communications equipment (including peripherals such as antenna cables and external antennas) should be used no closer than 30 cm (12 inches) to any part of this device, including cables specified by the manufacturer. Otherwise, degradation of the performance of this device could result.**
 - **The non-ME EQUIPMENT (e.g. ITE) that is a part of an ME SYSTEM may be disrupted by the electromagnetic interference of nearby equipment. It may be necessary to take mitigation measures, such as re-orienting or relocating the non-ME EQUIPMENT or shielding the location.**
 - **This device is intended for use in professional healthcare facility environment only. If it is used in special environment, such as magnetic resonance imaging environment, the device may be disrupted by the operation of nearby equipment.**
-
-

Guidance and Declaration - Electromagnetic Emissions

The device is intended for use in the electromagnetic environment specified below. The customer or the user of the device should assure that it is used in such an environment.

Emission test	Compliance	Electromagnetic environment - guidance
Conducted and radiated RF EMISSIONS CISPR 11	Group 1	The device uses RF energy only for its internal function. Therefore, its RF emissions are very low and are not likely to cause any interference in nearby electronic device.
Conducted and radiated RF EMISSIONS CISPR 11	Class B	The device is suitable for use in all establishments, including domestic establishments and those directly connected to the public low-voltage power supply network that supplies buildings used for domestic purposes.
Harmonic distortion IEC 61000-3-2	Class A	
Voltage fluctuations and flicker IEC 61000-3-3	Complies	

NOTE

- **The device needs special precautions regarding EMC and needs to be installed and put into service according to the EMC information provided below.**
 - **Use of portable or mobile communications devices will degrade the performance of the device.**
 - **Other devices may affect this device even though they meet the requirements of CISPR.**
 - **If the essential performance is lost or degraded, it may be necessary to take mitigation measures, such as re-orienting or relocating the ME EQUIPMENT or ME SYSTEM or shielding the location or stopping using the pump system and contact the service personnel.**
-

If the device is operated within the electromagnetic environment listed in Table **Guidance and Declaration — Electromagnetic Immunity**, the system will remain safe and provide the following essential performance:

- Operating mode
- Accuracy
- Function
- Protection against UNINTENDED BOLUS volumes
- Occlusion
- ALARM CONDITIONS regarded
- Data stored

Guidance and Declaration - Electromagnetic Immunity			
The device is intended for use in the electromagnetic environment specified below. The customer or the user of the device should assure that it is used in such an environment.			
Immunity test	IEC 60601 test level	Compliance level	Electromagnetic environment - guidance
Electrostatic discharge (ESD) IEC 61000-4-2	±8 kV contact ±2 kV, ±4 kV, ±8 kV, ±15 kV air	±8 kV contact ±2 kV, ±4 kV, ±8 kV, ±15 kV air	Floors should be wood, concrete or ceramic tile. If floors are covered with synthetic material, the relative humidity should be at least 30%.
Electrical fast transient/burst IEC 61000-4-4	±2 kV for power supply lines ±1 kV for input/output lines (length greater than 3 m)	±2 kV for power supply lines ±1 kV for input/output lines (length greater than 3 m)	Mains power quality should be that of a typical commercial or hospital environment.
Surge IEC 61000-4-5	±0,5 kV, ±1 kV line(s) to line(s); ±0,5 kV, ±1 kV, ±2 kV line(s) to earth	±0,5 kV, ±1 kV line(s) to line(s); ±0,5 kV, ±1 kV, ±2 kV line(s) to earth	
Voltage dips and Voltage interruptions IEC 61000-4-11	0 % U _T ; 0,5 cycle At 0°, 45°, 90°, 135°, 180°, 225°, 270° and 315° 0 % U _T for 1 cycle and 70 % U _T for 25/30 cycles 0 % U _T for 250/300 cycle	0 % U _T ; 0,5 cycle At 0°, 45°, 90°, 135°, 180°, 225°, 270° and 315° 0 % U _T for 1 cycle and 70 % U _T for 25/30 cycles 0 % U _T for 250/300 cycle	Mains power quality should be that of a typical commercial or hospital environment. If the user of our product requires continued operation during power mains interruptions, it is recommended that our product be powered from an uninterruptible power supply or a battery.
RATED power frequency magnetic fields IEC 61000-4-8	30 A/m 50 Hz / 60 Hz	30 A/m 50 Hz / 60 Hz	Power frequency magnetic fields should be at levels characteristic of a typical location in a typical commercial or hospital environment.
Note: U _T is the A.C. mains voltage prior to application of the test level.			

Guidance and Declaration - Electromagnetic Immunity

The device is intended for use in the specified electromagnetic environment. The customer or the user of the device should assure that it is used in such an environment as described below.

Immunity test	IEC 60601 Test level	Compliance level	Electromagnetic environment - guidance
Conducted disturbances induced by RF fields IEC61000-4-6	3 Vrms 150 kHz to 80 MHz	3 Vrms	Portable and mobile RF communications equipment should be used no closer to any part of the device, including cables, than the recommended separation distance calculated from the equation applicable to the frequency of the transmitter. Recommended separation distance: $d = 1.2\sqrt{P}$ 150kHz to 80 MHz $d = 2\sqrt{P}$ 150kHz to 80 MHz
	6 Vrms in ISM bands between 0,15 MHz and 80 MHz ^a	6 Vrms	
Radiated RF EM fields IEC61000-4-3	10V/m 80 MHz to 2.7 GHz	10V/m	$d = 1.2\sqrt{P}$ 80 MHz to 800 MHz $d = 2.3\sqrt{P}$ 800 MHz to 2.7 GHz where P is the maximum output power rating of the transmitter in watts (W) according to the transmitter manufacturer and d is the recommended separation distance in meters (m). Field strengths from fixed RF transmitters, as determined by an electromagnetic site survey ^b , should be less than the compliance level in each frequency range ^c . Interference may occur in the vicinity of equipment marked with the following symbol: 

Note 1: At 80 MHz and 800 MHz, the higher frequency range applies.

Note 2: These guidelines may not apply in all situations. Electromagnetic propagation is affected by absorption and reflection from structures, objects and people.

^a The ISM (industrial, scientific, and medical) bands between 150 kHz and 80 MHz are 6.765 MHz to 6.795 MHz; 13.553 MHz to 13.567 MHz; 26.957 MHz to 27.283 MHz; and 40.66 MHz to 40.70 MHz. The amateur radio bands between 0,15 MHz and 80 MHz are 1,8 MHz to 2,0 MHz, 3,5 MHz to 4,0 MHz, 5,3 MHz to 5,4 MHz, 7 MHz to 7,3 MHz, 10,1 MHz to 10,15 MHz, 14 MHz to 14,2 MHz, 18,07 MHz to 18,17 MHz, 21,0 MHz to 21,4 MHz, 24,89 MHz to 24,99 MHz, 28,0 MHz to 29,7 MHz and 50,0 MHz to 54,0 MHz.

^b Field strengths from fixed transmitters, such as base stations for radio (cellular/cordless) telephones and land mobile radios, amateur radio, AM and FM radio broadcast and TV broadcast cannot be predicted theoretically with accuracy. To assess the electromagnetic environment due to fixed RF transmitters, an electromagnetic site survey should be considered. If the measured field strength in the location in which the device is used exceeds the applicable RF compliance level above, the device should be observed to verify normal operation. If abnormal performance is observed, additional measures may be necessary, such as re-orienting or relocating the device.

^c Over the frequency ranges 150 kHz to 80 MHz, field strengths should be less than 3V/m.

GUIDANCE AND MINDRAY DECLARATION - ELECTROMAGNETIC IMMUNITY			
The device is intended for use in the electromagnetic environment specified below. The customer or the user of system should assure that it is used in such an environment.			
IMMUNITY TEST	IEC 60601 TEST LEVEL	COMPLIANCE LEVEL	ELECTROMAGNETIC ENVIROMENT - GUIDANCE
Proximity magnetic fields IEC 61000-4-39	8 A/m 30 kHz CW	8 A/m 30 kHz CW	/
	65 A/m 134,4 kHz Pulse modulation 2,1 kHz	65 A/m 134,4 kHz Pulse modulation 2,1 kHz	
	7,5 A/m 13,56 MHz Pulse modulation 50 kHz	7,5 A/m 13,56 MHz Pulse modulation 50 kHz	

TABLE EMC-5- Test specifications and minimum distances

Recommended separation distances between portable and mobile RF communications equipment and the device						
<p>The system is intended for use in an electromagnetic environment in which radiated RF disturbances are controlled. The customer or the user of the device can help prevent electromagnetic interference by maintaining a minimum distance between portable and mobile RF communications equipment (transmitters) and the device as recommended below, according to the maximum output power of the communications equipment. Portable and mobile radio communications equipment (e.g. two-way radio, cellular/ cordless telephones and similar equipment) should be used no closer to any part of this system, including cables, than determined according to the following method:</p>						
Test frequency (MHz)	Band (MHz)	Service	Modulation	Maximum power (W)	Distance (m)	Immunity test level (V/m)
385	380 - 390	TETRA 400	Pulse modulation 18Hz	1.8	0.3	27
450	430 -470	GMRS 460 FRS 460	FM ±5 kHz deviation 1 kHz sine	2	0.3	28
710	704 - 787	LTE Band 13,17	Pulse modulation 217 Hz	0.2	0.3	9
745						
780						
810	800 - 960	GSM 800/900, tetra 800, iDEN 820, CDMA 850, LTE Band 5	Pulse modulation 18 Hz	2	0.3	28
870						
930						

1720	1700 - 1990	GSM 1800, CDMA 1900, GSM 1900, DECT, LTE Band 1, 3, 4, 25, UMTS	Pulse modulation 217 Hz	2	0.3	28
1845						
1970						
2450	2400 - 2570	Bluetooth, WLAN, 802.11 b/g/n, RFID 2450, LTE Band 7	Pulse modulation 217 Hz	2	0.3	28
5240	5100 - 5800	WLAN, 802.11 a/n	Pulse modulation 217 Hz	0.2	0.3	9
5500						
5785						

Recommended Separation Distances between Portable and Mobile RF, Communications Equipment and the device

The device is intended for use in an electromagnetic environment in which radiated RF disturbance are controlled. The customer or the user of the device can help prevent electromagnetic interference by maintaining a minimum distance between portable and mobile RF communications equipment (transmitters) and the device as recommended below, according to the maximum output power of the communication equipment.

Rated Maximum Output power of Transmitter Watts (W)	Separation Distance According to Frequency of Transmitter (m)			
	150 kHz to 80 MHz Out ISM and amateur radio bands $d = 1.2\sqrt{P}$	150 kHz to 80 MHz in ISM and amateur radio bands $d = 2\sqrt{P}$	80 MHz to 800 MHz $d = 1.2\sqrt{P}$	800 MHz to 2.7 GHz $d = 2.3\sqrt{P}$
0.01	0.12	0.2	0.12	0.23
0.1	0.38	0.64	0.38	0.73
1	1.2	2	1.2	2.3

10	3.8	6.4	3.8	7.3
100	12	20	12	23
<p>For transmitters at a maximum output power not listed above, the recommended separation distanced in meters (m) can be determined using the equation applicable to the frequency of the transmitter, where P is the maximum output power rating of the transmitter in watts (W) according to the transmitter manufacturer.</p> <p>Note 1: At 80 MHz and 800 MHz, the higher frequency range applies.</p> <p>Note 2: These guidelines may not apply in all situations. Electromagnetic propagation is affected by absorption and reflection from structures, objects and people.</p>				

Cable information:

PORT No.	Name	Cable Length (m)	Cable Shielded (Y/N)	Remark
1	Power cord	2.5	N	/
2	Nurse call cable	2.8	N	with ferrite core
3	DC power cord	2.8	N	/

B.2 Radio Regulatory Compliance

Refer to **A.2 Wireless Network** for the details of RF parameters.



The radio device used in this product is in compliance with the essential requirements and other relevant provisions of Directive 2014/53/EU.

WARNING

- **Keep a distance of at least 20cm away from the equipment when Wi-Fi function is in use.**
-
-

This page intentionally left blank.

C Abbreviations

Abbreviation	In Full
AC	Alternating Current
Anti-Bolus	Anti-Bolus
BOLUS	Bolus
CCU(CICU)	Cardiac Intensive Care Unit
CE	Conformité Européenne
CISPR	International Special Committee on Radio Interference
CPU	Central Processing Unit
DC	Direct Current
DEFS	Dose Error Reduction Systems
DPS	Dynamic Pressure System
EEC	European Economic Community
EMC	Electromagnetic Compatibility
EMI	Electromagnetic Interference
EtO	Ethylene oxide
ICU	Intensive Care Unit
ID	Identification
IEC	International Electrotechnical Commission

Abbreviation	In Full
IEEE	Institute of Electrical and Electronic Engineers
ISO	International Organization for Standardization
IV	Intravenous
KVO	Keep Vein Open
LED	Light Emitting Diode
Max	Maximum
MDD	Medical Device Directive
Min	Minimum
MRI	Magnetic Resonance Imaging
N/A	Not Applied
OR	Operating Room
SN	Series Number
TCI	Target Controlled Infusion
TIVA	Total Intra Venous Anesthesia
USB	Universal Serial Bus
VTBI	Volume To Be Infused

D Declaration of Conformity

Declaration of Conformity-V1.0							
Declaration of Conformity 							
Manufacturer:	Shenzhen Mindray Scientific Co., Ltd.						
Address	6/F, Bldg 2, 1203 Nanhuan Avenue, Yutang Block, Guangming District, 518106 Shenzhen, P. R. China						
EC-Representative:	Shanghai International Holding Corp. GmbH (Europe)						
Address	Eiffestraße 80, 20537 Hamburg, Germany						
Product:	Syringe pump						
Model:	<table border="1"><tr><td>BeneFusion iSP</td><td>BeneFusion iSP ex</td></tr><tr><td>BeneFusion uSP</td><td>BeneFusion uSP ex</td></tr><tr><td>BeneFusion uDSP</td><td>BeneFusion uDSP ex</td></tr></table>	BeneFusion iSP	BeneFusion iSP ex	BeneFusion uSP	BeneFusion uSP ex	BeneFusion uDSP	BeneFusion uDSP ex
BeneFusion iSP	BeneFusion iSP ex						
BeneFusion uSP	BeneFusion uSP ex						
BeneFusion uDSP	BeneFusion uDSP ex						
<p>We herewith declare that the products above mentioned meet the provisions of the Council Directive 2014/53/EU concerning radio equipment. All supporting documentation is retained under the premises of the manufacturer.</p>							
Standards Applied:							
<input checked="" type="checkbox"/> EN 60601-1:2006/A1:2013	<input checked="" type="checkbox"/> EN 60601-1-2: 2015						
<input checked="" type="checkbox"/> EN IEC 62311:2020	<input checked="" type="checkbox"/> ETSI EN 301 489-1 V2.2.3						
<input checked="" type="checkbox"/> 301 489-17 V3.2.4	<input checked="" type="checkbox"/> ETSI EN 300 328 V2.2.2						
<input checked="" type="checkbox"/> ETSI EN 301 893 V2.1.1	<input checked="" type="checkbox"/> EN IEC 62368-1:2020+A11:2020						
Place, Date of Issue:	Shenzhen,						
Signature: <i>Bai Yanhong</i> 2023.1.16						
Name of Authorized Signatory:	Bai Yanhong						
Position Held in Company:	Manager, Technical Regulation						

This page intentionally left blank.

