



GREETMED



NINGBO  
**GREETMED**  
MEDICAL INSTRUMENTS

**CE** Approved





### GT087-100

#### Spandex Elastic Bandage

Material: 85% cotton With 15% spandex  
 Crepe or Plain  
 Color: natural, Flesh or Bleach  
 Weight: 75g/m<sup>2</sup>, 80g/m<sup>2</sup>, 85g/m<sup>2</sup>, 90g/m<sup>2</sup> Etc.  
 Width: 2", 3", 4", 5", 6" etc.  
 Length: 4m, 4.5m, 5m, 6m Etc.  
 Sterile or Non-sterile  
 Packing: 1roll/poly Bag, 12roll/bag



### GT088-100

#### PBT Elastic Bandage

Material: 65% cotton With 35% polyester  
 Color: Bleach  
 Weight: 28g/m<sup>2</sup>, 29g/m<sup>2</sup>, 30g/m<sup>2</sup> Etc.  
 Width: 2", 3", 4", 5", 6", etc.  
 Length: 4m, 4.5m, 5m, 6m Etc.  
 Sterile or Non-sterile  
 Packing: 1roll/poly Bag, 12roll/bag



### GT089-100

#### Cotton Elastic Bandage

Material: 100% cotton  
 Color: Bleach  
 Weight: 75g/m<sup>2</sup>, 80g/m<sup>2</sup>, 85g/m<sup>2</sup>, 90g/m<sup>2</sup> Etc.  
 Width: 2", 3", 4", 5", 6", etc.  
 Length: 4m, 4.5m, 5m, 6m Etc.  
 Sterile or Non-sterile  
 Packing: 1roll/poly Bag, 12roll/bag



### GT090-100

#### High Elastic Bandage

Material: 62% cotton With 38% polyester  
 Color: Bleach, Natural  
 Weight: 80g/m<sup>2</sup>, 100g/m<sup>2</sup> Etc.  
 Width: 2", 3", 4", 5", 6", etc.  
 Length: 4m, 4.5m, 5m, 6m Etc.  
 Sterile or Non-sterile  
 Packing: 1roll/poly Bag, 12roll/bag

### GT102-170 Net bandage

Material: Acrylic with Elastic  
 Color: White  
 Weight: 120g/m<sup>2</sup>  
 Size: : 0.8cmx25m, 1.7cmx25m, 2cmx25m,  
 2.2cmx25m, 2.6cmx25m, 3.8cmx25m,  
 4.4cmx25m, 5.5cmx25m, 6.8cmx25m, 8cmx25m

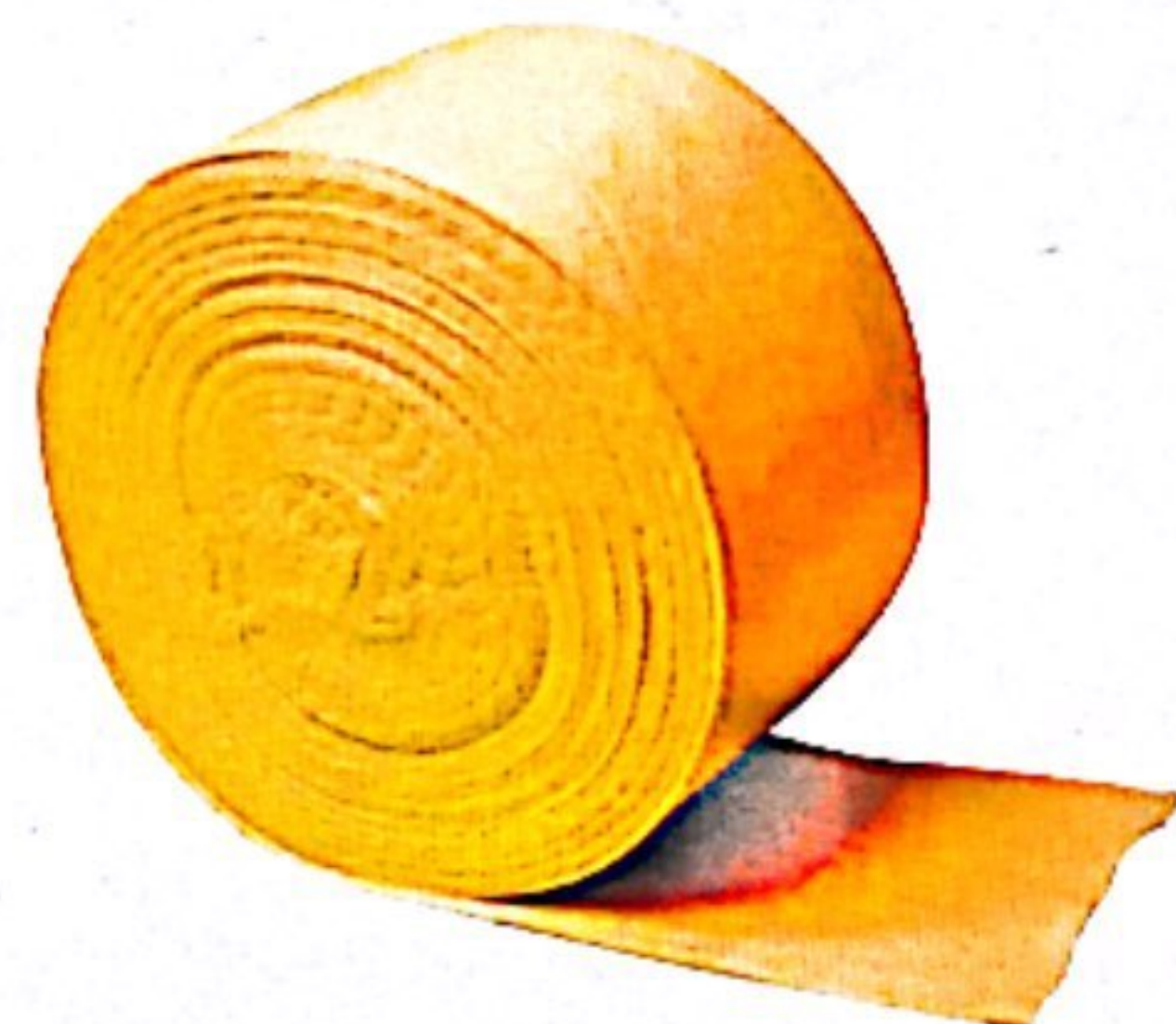

### GT172-300 Stockinet Bandages

Material: 100% Cotton  
 Color: Natural white, or other color per customer's demand  
 Introduction: Made from 100% natural cotton, which is used for the wound and sport. It can be made into roll.  
 Size: 5.0cm x20 m, 6.0cm x20 m, 7.5cm x20 m, 8.0cm x20 m, 10cm x20 m, 15cm x20 m,



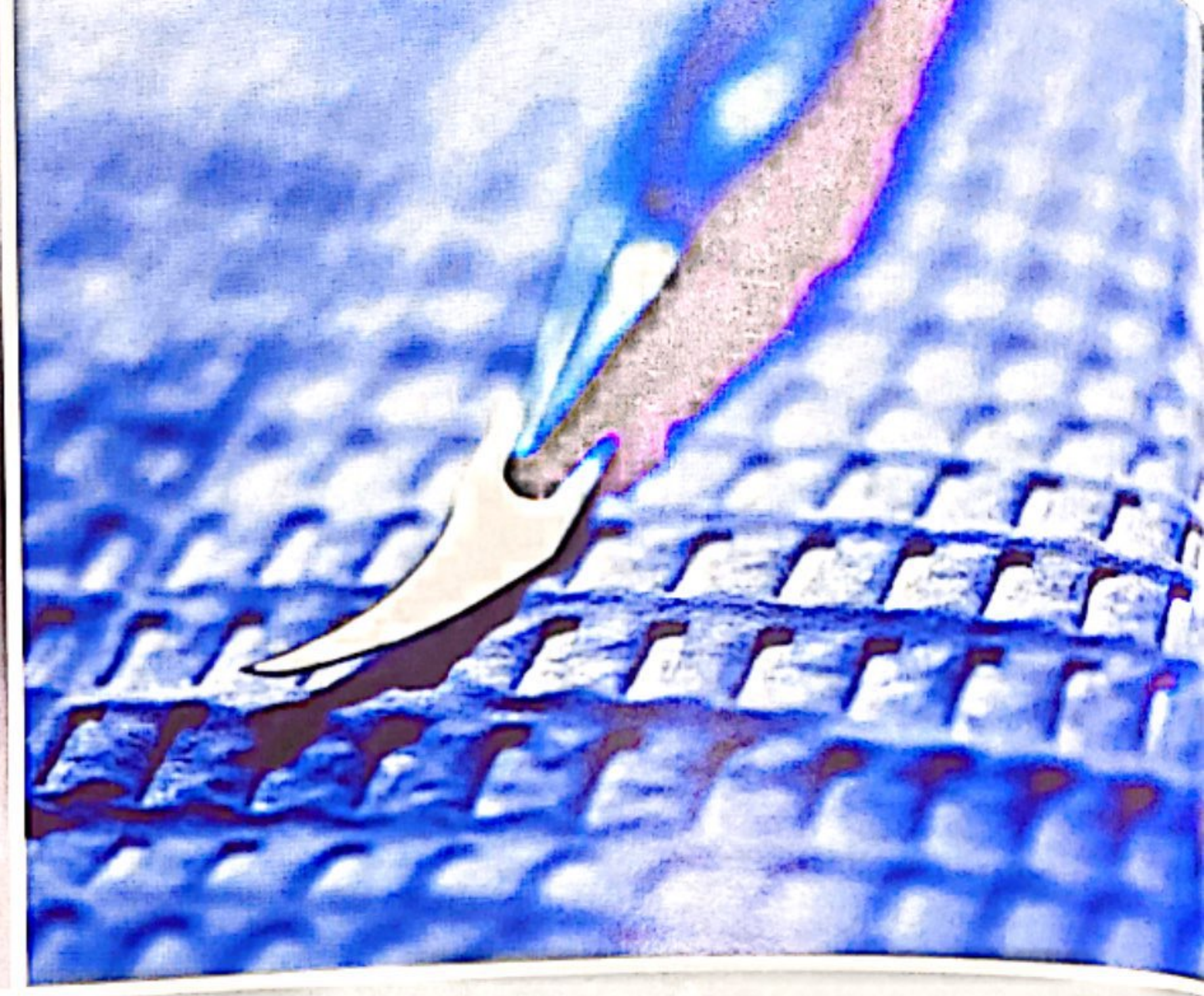

**Hypodermic & Surgical Instruments**

**NINGBO GREETMED MEDICAL INSTRUMENTS CO., LTD.**  
 WEB: <http://www.greetmed.com> E-MAIL: [info@greetmed.com](mailto:info@greetmed.com)

**GT040-100 Disposable Surgical Blade**

Surgical Blades are critically made in accordance with ISO9001/ISO7740 standard. They supply very high quality to high level doctors worldwide. Our Surgical Blades have the most popular sizes to satisfy different surgery demands

Material : carbon steel or stainless steel  
 Size: 10#-36#  
 Packing: 1pc/sealed, aluminium foil bag, 100pcs/box, 5000pcs/case.  
 32x36x10.5cm, 9/8kgs



**GT040-200 Disposable Stitich Cutter Blade**

Special Blades include the following sizes: stitch cutter blade 65 # and 110 # , These blades can meet your different surgical medical use requirements.

Raw material: carbon steel or stainless steel  
 Size: 65mm, 110mm  
 Packing: 1pc/sealed, aluminium foil bag, 100pcs/box, 5000pcs/case. 65mm: 36x32x10.5cm 9/9.5kgs  
 110mm: 38.5x31.5x16cm 16/15kgs.

**GT040-300 Disposable Skin Graft Blade**

Material: carbon steel or stainless steel  
 Size: 160mm  
 Packing: 1pc/sealed, aluminium foil bag, 100pcs/box, 1000pcs/case.  
 43.5x23x18.5cm 9/8.5kgs



**GT041-600 Stainless Steel Handles**

**GT041-100 Disposable Surgical Scalpe**

We supply many different handles for different operation requirements. Protective tab does best safety job to operators.

Disposable scalpels (Inserted model)  
 Packing: 10pcs/box, 500pcs/ctn, 47x37x21cm, 6/5.5kgs

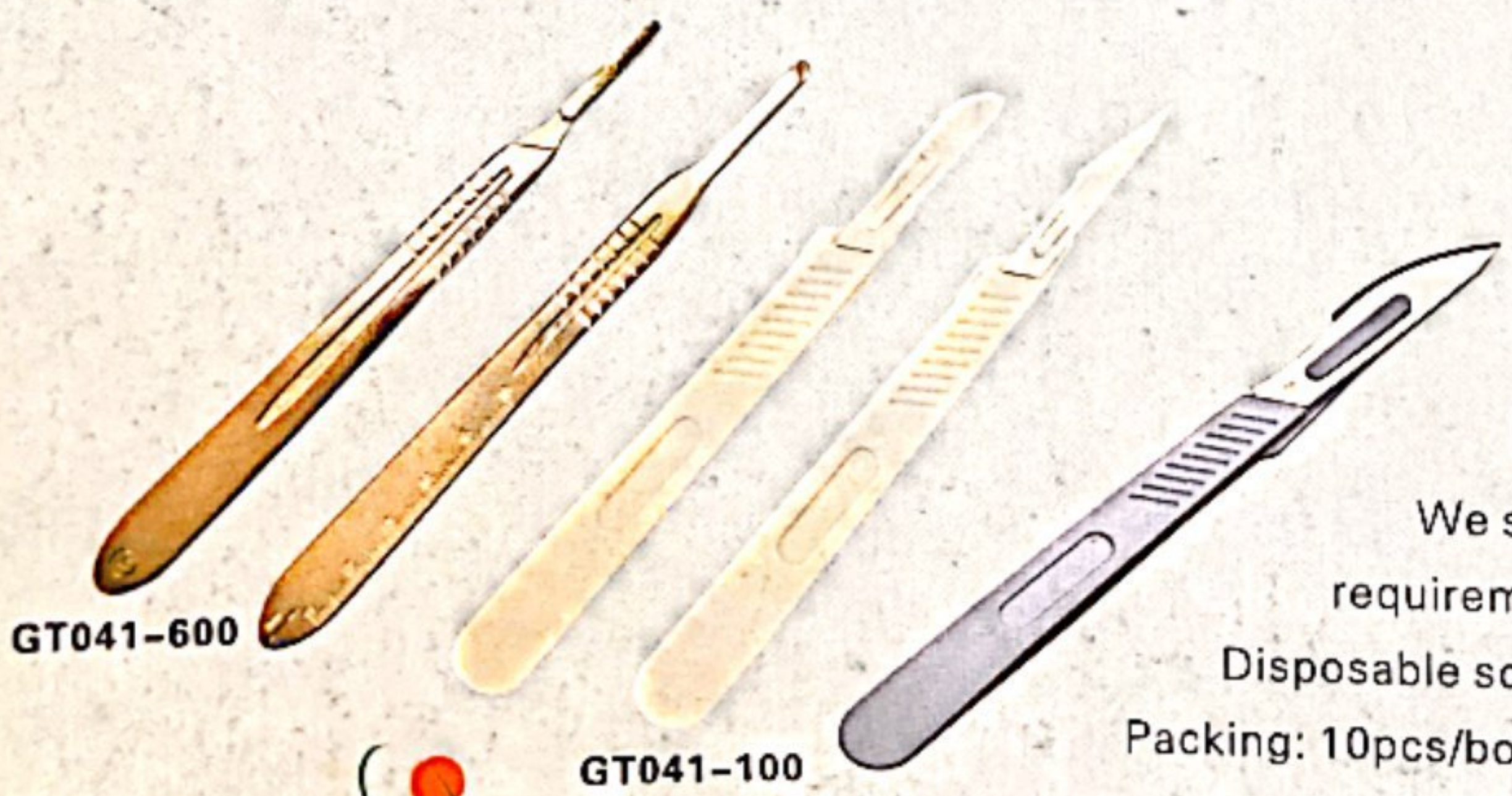



### Double Lumen Endobronchial tube

Endobronchial tube is used for the purpose of establishing and maintaining a patient airway and ensure the adequate exchange of oxygen and carbon dioxide.

#### Features

1. Made from PVC in medical grade. DEHP is available.
2. Equipped with switch connector and two low-friction suction catheters.
3. Available with two types, left-side and right-side.
4. The cuffs, two lumens and pilot balloons are imprinted with Tracheal (clear) or Bronchial (blue) for easy identification.
5. Smooth inner lumens can make the bronchoscopes easier to go through.
6. Pre-loaded stylet can help tube maintain the shape for easier intubation.

Size: Fr28, Fr32, Fr35, Fr37, Fr39, Fr41

Packing: Blister Bag, 1pc/box

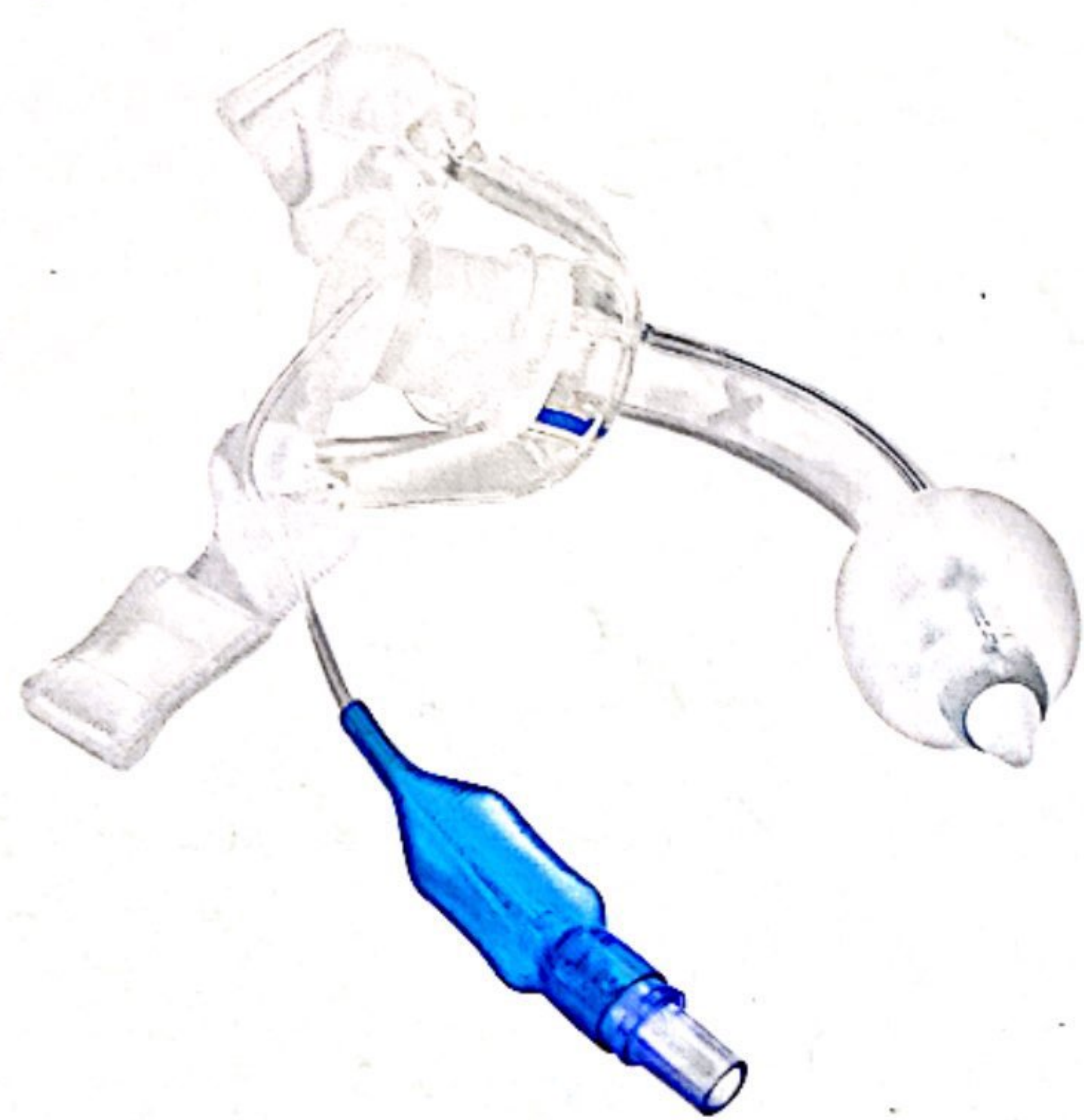
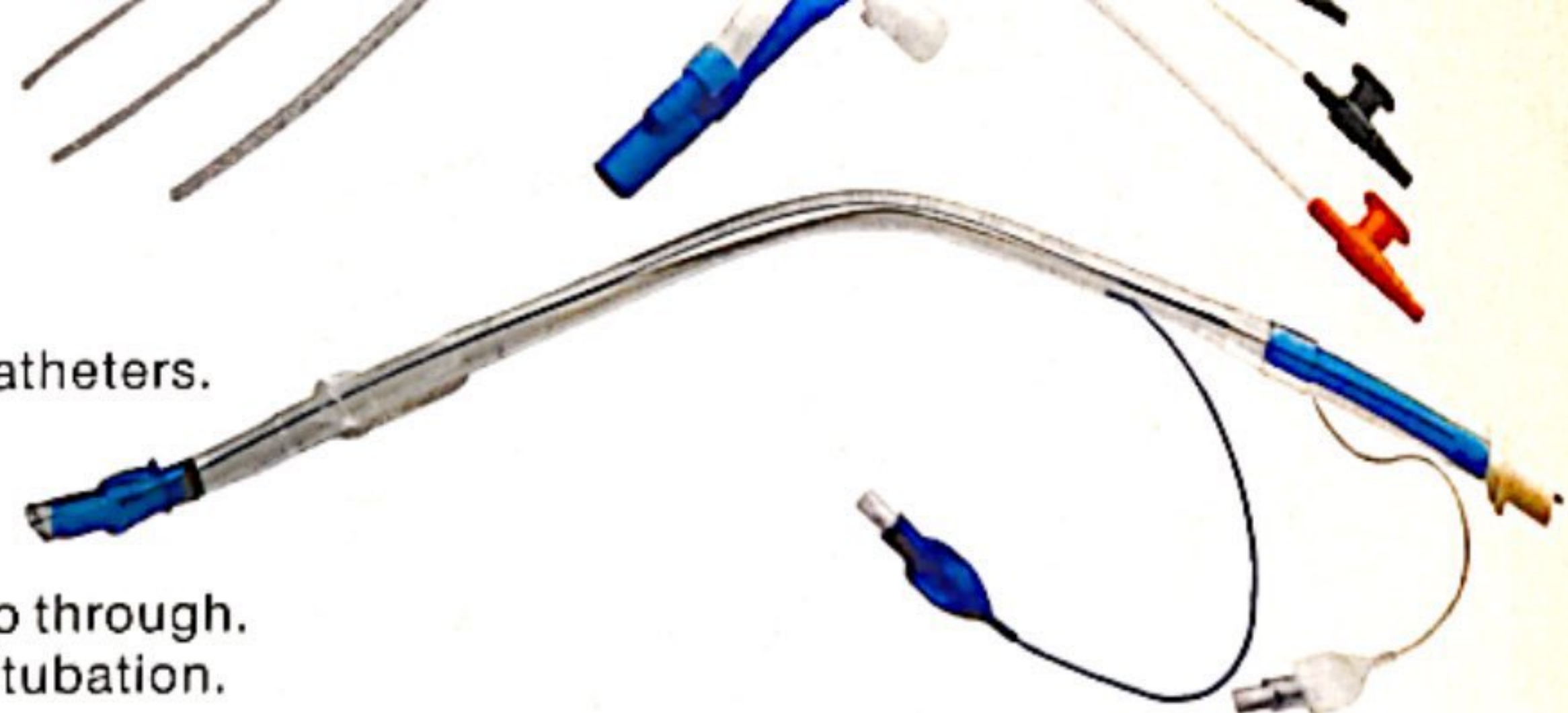

### GT015-100 Tracheostomy Tube With cuff

SIZE: 3.0-10.0MM  
Packing: Hard Blister Pack

### GT015-200 Tracheostomy Tube Without cuff

SIZE: 3.0-10.0MM  
Packing: Hard Blister Pack

### GT014-800 Endotracheal Tube Introducer (Bougie)

Made from semirigid non-toxic Polyethylene  
Used for assistance intubation

10pc/box  
Size: Solid Introducer

Size	Length
6	53.5cm
10	70cm
15	70cm

Size: Hollow Introducer

Size	Length
10	90cm
15	90cm

Packing: Blister Bag

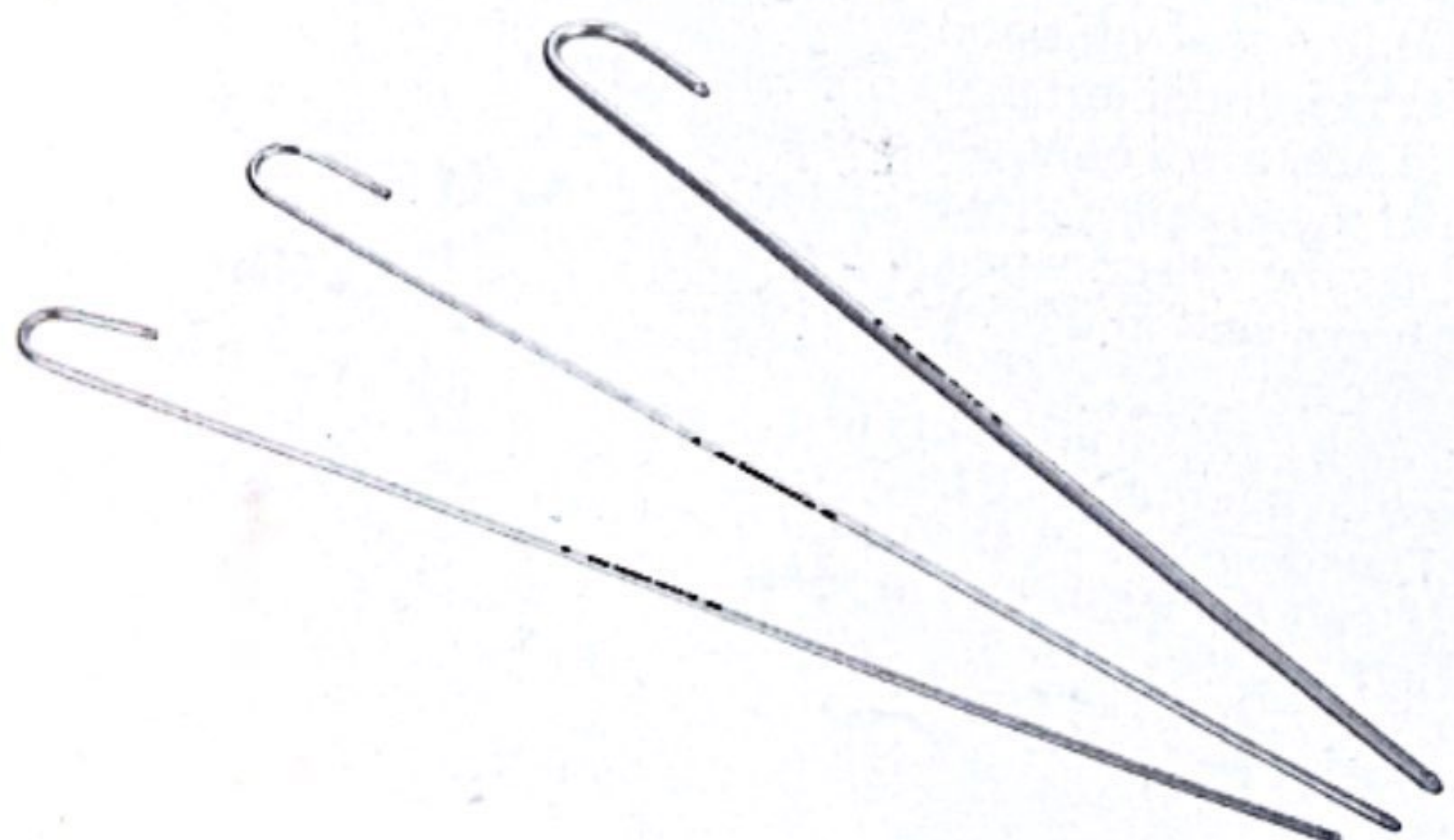
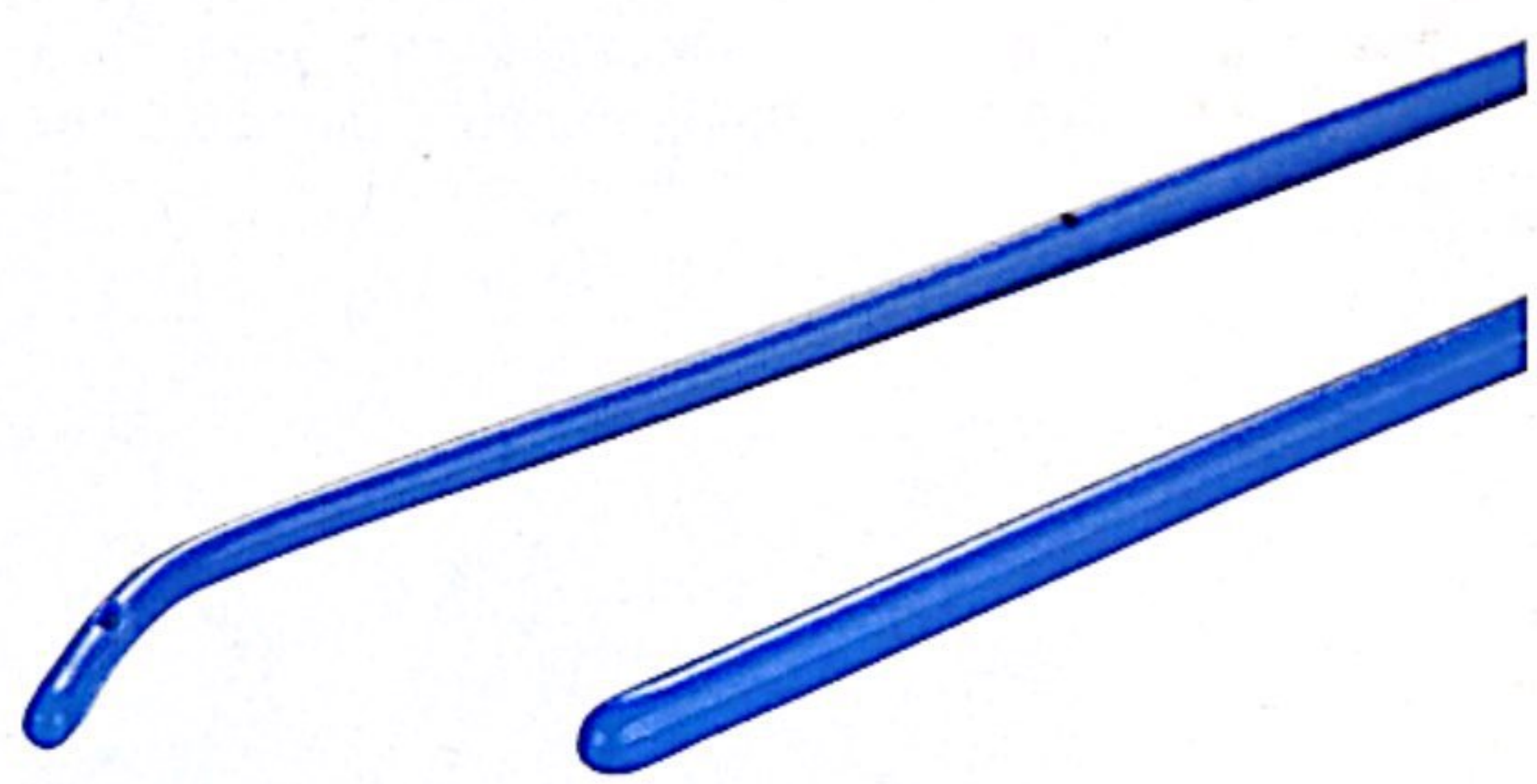

### GT014-900 Intubating Stylet

Made of malleable aluminum covered with plastic sheath.  
Soft rounded tip for minimizing patient trauma during intubation.  
Flexible use for assistance of intubation.

Size	Length
6	30.2cm
10	38.2cm
14	38.2cm

Packing: Blister Bag





**GT010-160**

**Oxygen Mask with Reservoir bag**

Made of medical grade PVC  
 Reservoir bay with/without check value  
 One safety vent open.  
 Mask with elastic strap,  
 Adjustable nose clip  
 Non-rebreathing Mask provides a high concentration of oxygen with 2m tubing,  
 Size available: S, M, L, XL  
 Packed in individual PE Bag  
 100pcs/ctn, Dimension: 47X39X25cm

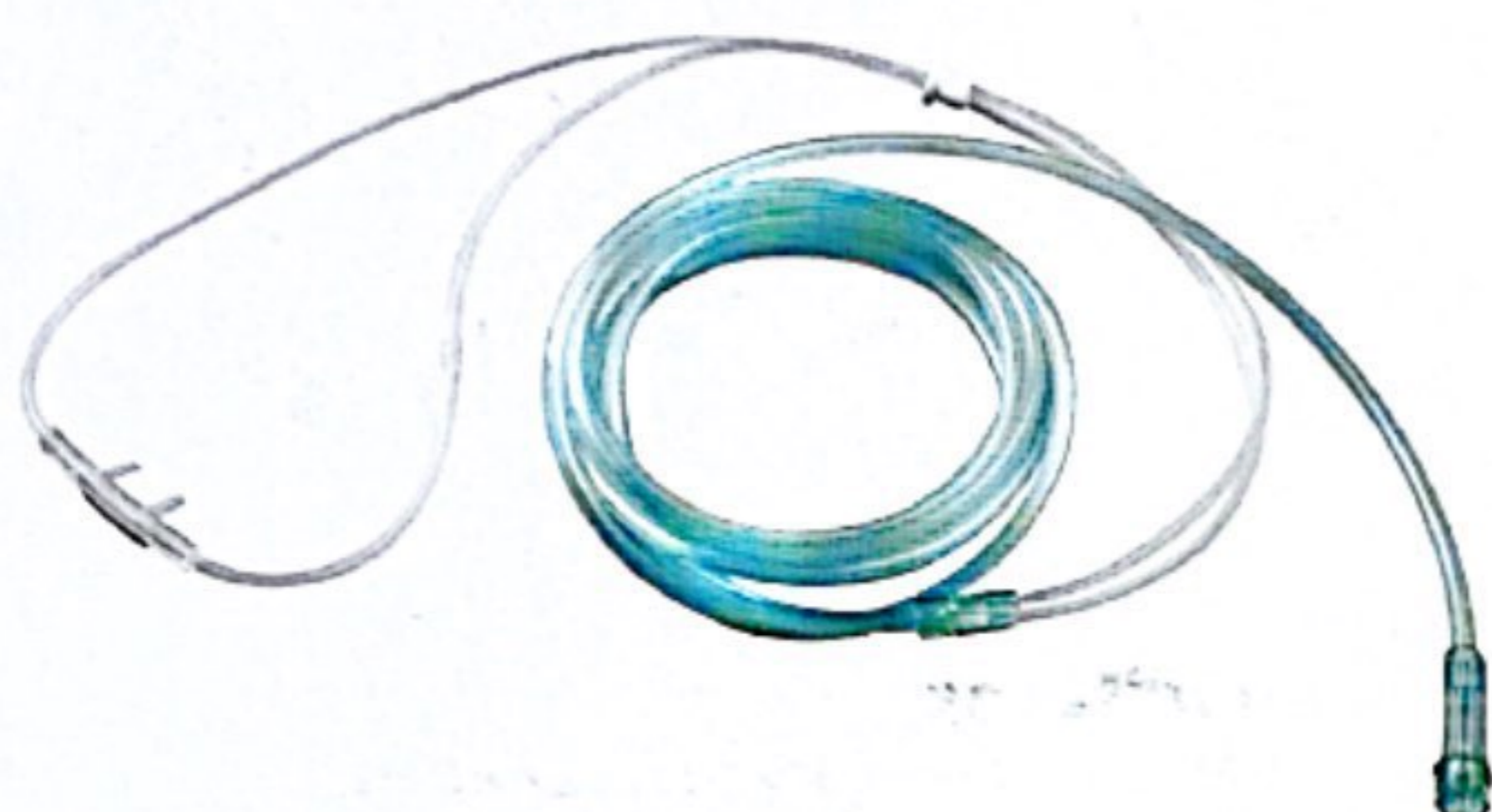

**GT013-100 Nasal Oxygen Cannula**

Made of medical grade PVC,  
 Straight Tip, Flared Tip and Curved Tip is available.  
 With 2M tubing  
 Size available: S, M, L, XL  
 Packed in individual PE Bag  
 100pcs/ctn, Dimension: 45X38X20cm

**GT013-200 Soft tip**

With 2m oxygen tubing



**GT027-100**

**Connecting Tube with Yankauer Handle**

Made from non-toxic PVC, clear and soft  
 Large lumen resists clogging and the transparency allows clear visualization of liquids  
 Crown tip, vented.  
 With connecting tube  
 Size: 1/4"X1.8m, 1/4"X3.6m, 3/16"X1.8m, 3/16"X3.6m  
 Packed in individual Blister Bag or Poly Bag  
 20pcs/ctn, Dimension: 38X30X25cm



**GT032-100**

**Anaesthesia breathing system**

**Specification:**  
 adult/pediatrics; common/extension tube  
 Construction: with L connector, three-way connector, breath air chamber, solenoid  
 Function: connect the equipment, transfer the air to body  
 Store claim: store in dark, dry and clean conditions, do not give heavy press  
 Form of packing: 30set/carton  
 Size of packing:  
 Export carton: 660x480x375mm  
 .GW:5.8kgs

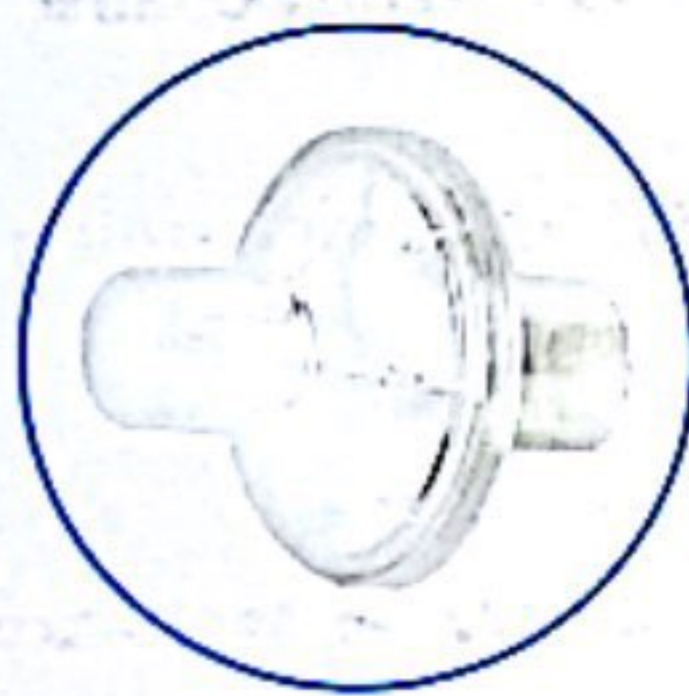

**GT032-200**

Bacterial/Viral filter  
 Parts: Shell membrane  
 Material: styrene butadiene copolymer, hydrophobic polypropylene  
 250pcs/60x50x50cm  
 8kgs/7.5kgs

**Teeth Cushion**



GT011-100

GT011-200

**Teeth Cushion**

purpose: A fixture to protect the lips and mouth of patient, and to observe the throat.

The fixture can be attached on therapeutic equipment.

**GT011-100** Type III (Gastroscope Fixture),  
 packing: 1pc/blister pack, 10pcs/bag, 500pcs/ctn, 50x35x35cm

**GT011-200** Type I (Airway)  
 packing: 1pc/blister pack, 10pcs/bag, 500pcs/ctn, 50x35x35cm  
 Raw material: polyethylene  
 Sterilization: EO

NINGBO GREETMED MEDICAL INSTRUMENTS CO., LTD.



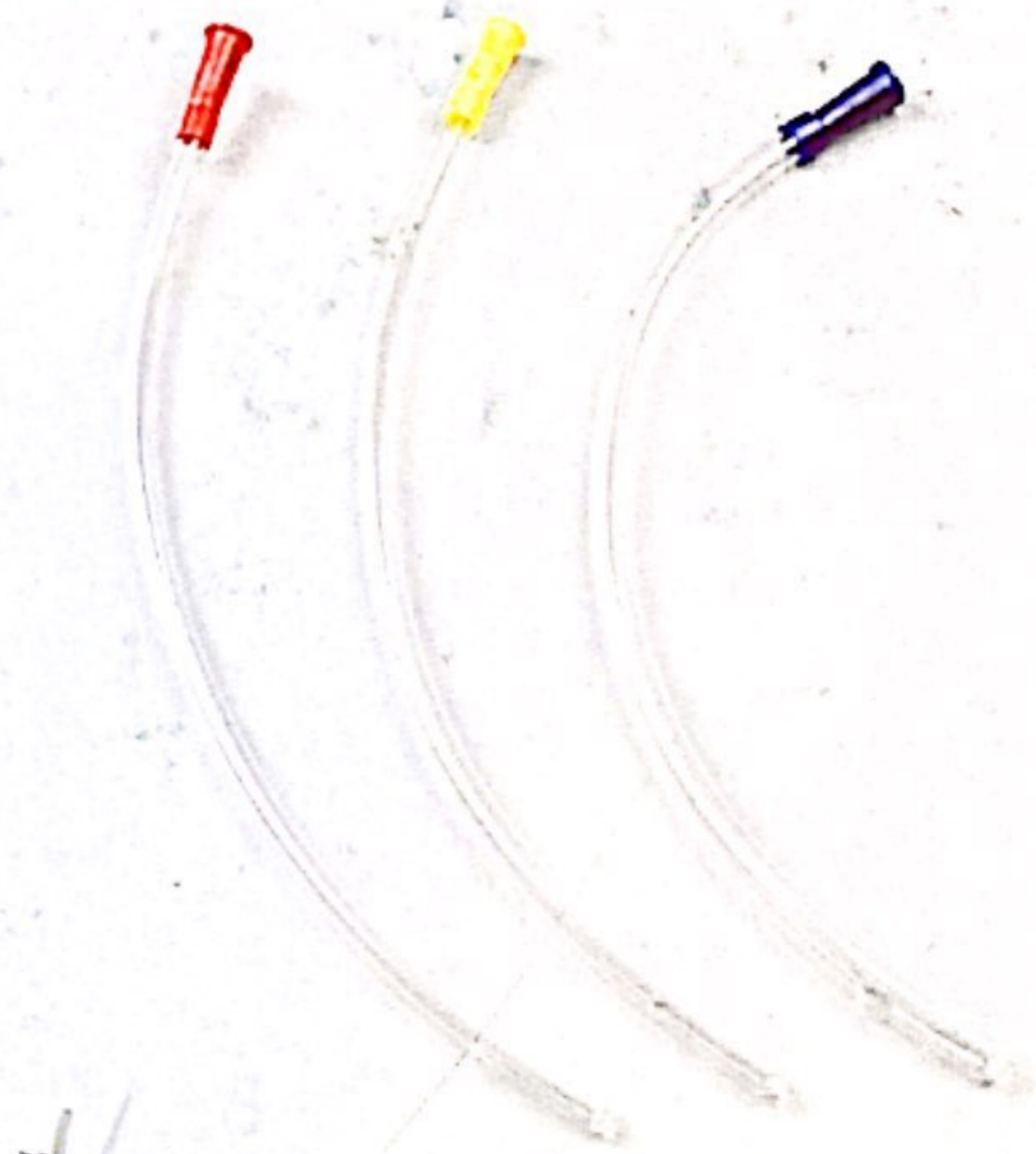

**GT020-100 Rectal tube**

Made from non-toxic, non-irritant soft PVC  
 Color coded for size identification  
 With X-ray or without is available  
 Standard tube length: 40cm  
 Size: Fr24-Fr28  
 Packed in individual PE Bag 400pcs/ctn  
 Dimension: 50X29X37cm

W

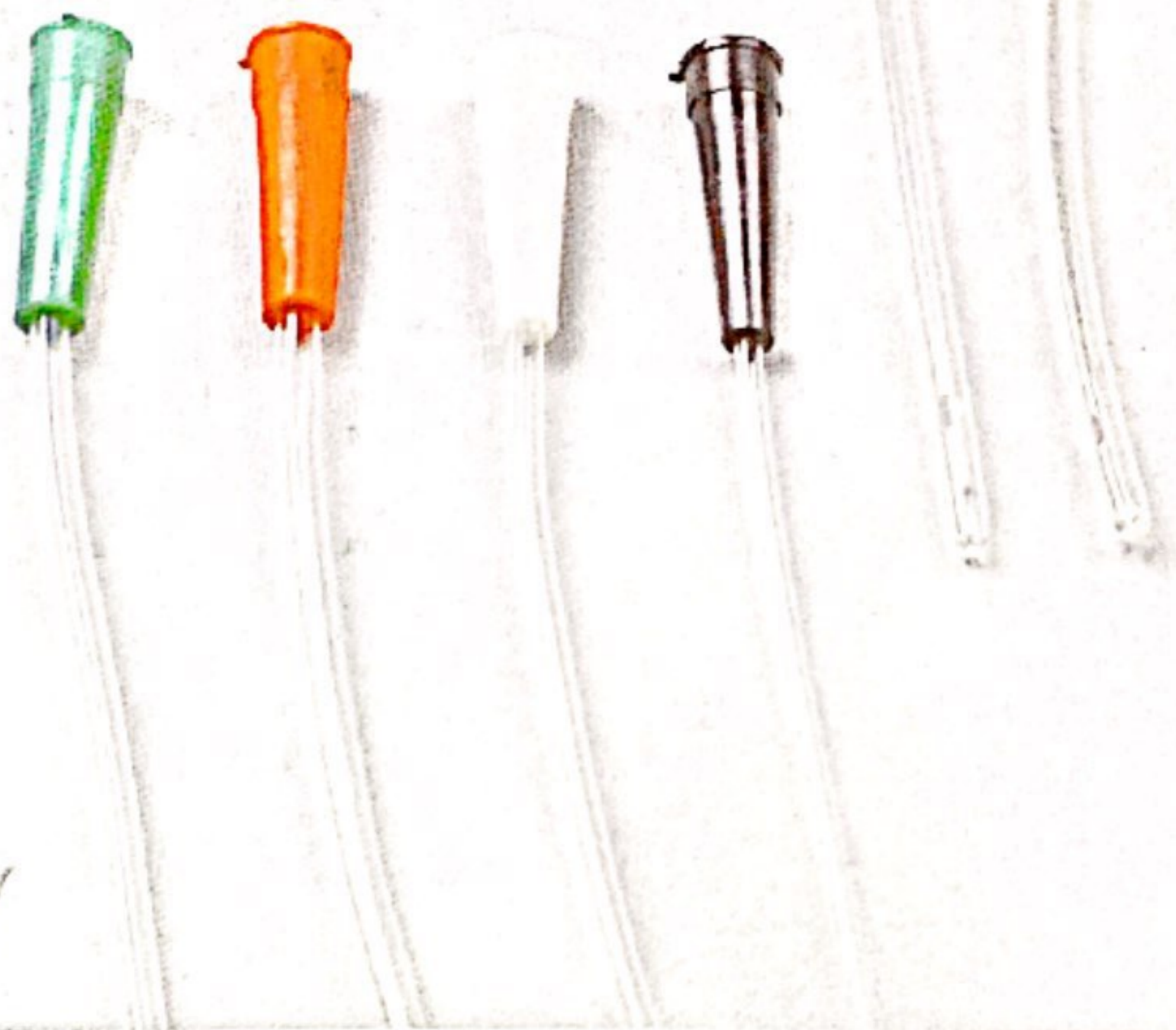

**GT021-100 Nelaton Catheter (PVC)**

Made from non-toxic, non-irritant soft PVC  
 Color coded for size identification  
 With X-ray or without is available  
 Standard tube length: 40cm  
 Size: Fr6-Fr24  
 Packed in individual PE Bag 4000pcs/ctn  
 Dimension: 47X37X42cm



**GT024-100 Penrose Drainage Tube**

Made from natural latex  
 Size: 1/4", 5/16", 3/8", 1/2", 5/8", 3/4", 7/8", 1"  
 Length: 450mm  
 Packed in individual Blister Bag  
 50pcs/box, 500pcs/ctn, Dimension: 50X25X29cm



**GT025-100 T-Drainage Tube**

Made from natural latex, Silicone coated  
 Used for the drainage of the operation of Cholecyst  
 The connector part is larger in diameter than other parts  
 Size: Fr10-Fr26  
 Packed in individual Blister Bag  
 200pcs/ctn, Dimension: 49.5X37X34cm

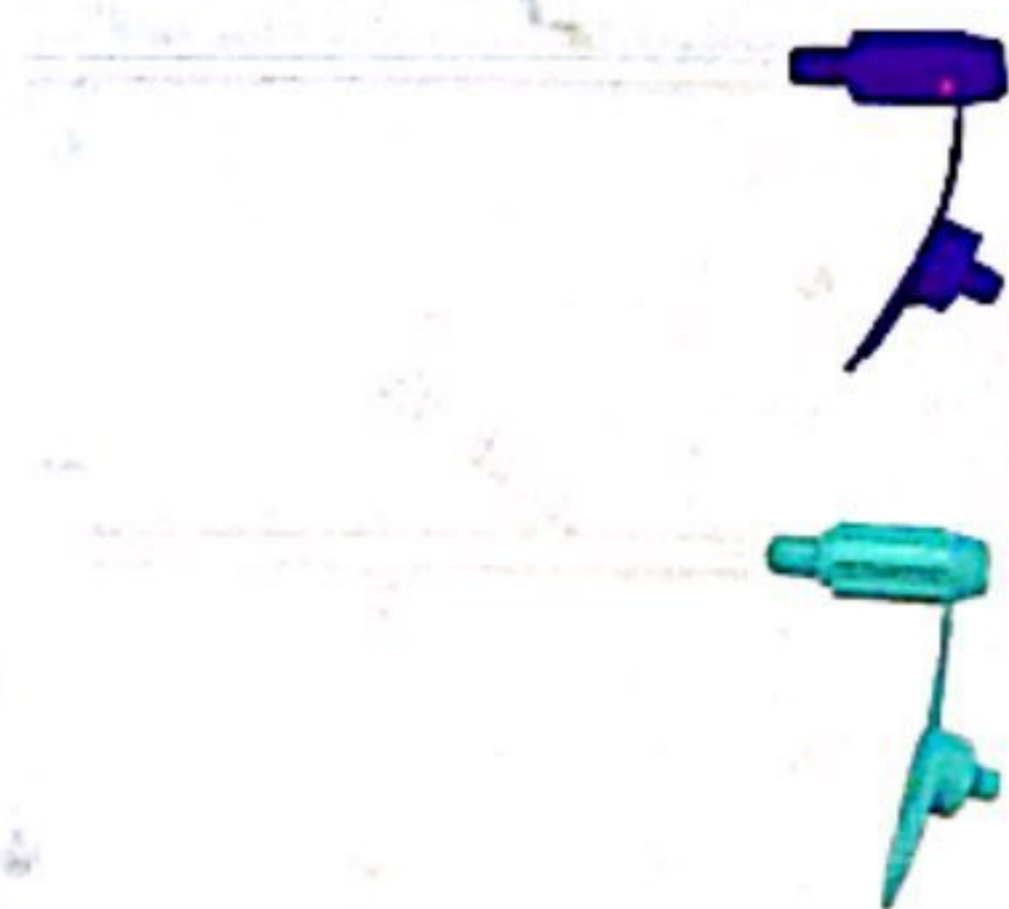

**GT025-200 Umbilical catheter**

Made from soft PVC.  
 Designed for intermittent continuance access  
 to the umbilical artery or vein of newly born or  
 premature infant.  
 Individually straight packed in paper pouch  
 packing to ensure aseptic handling.

?



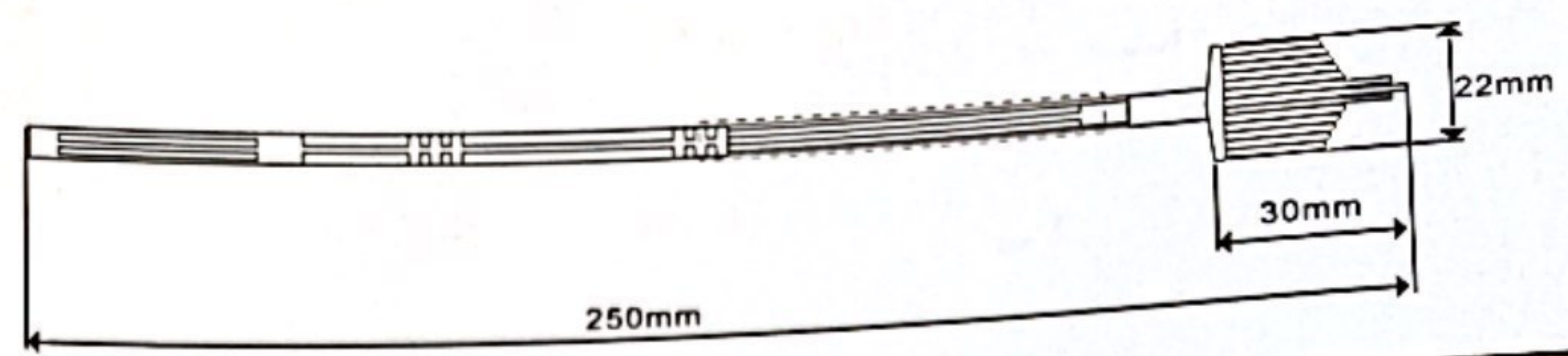
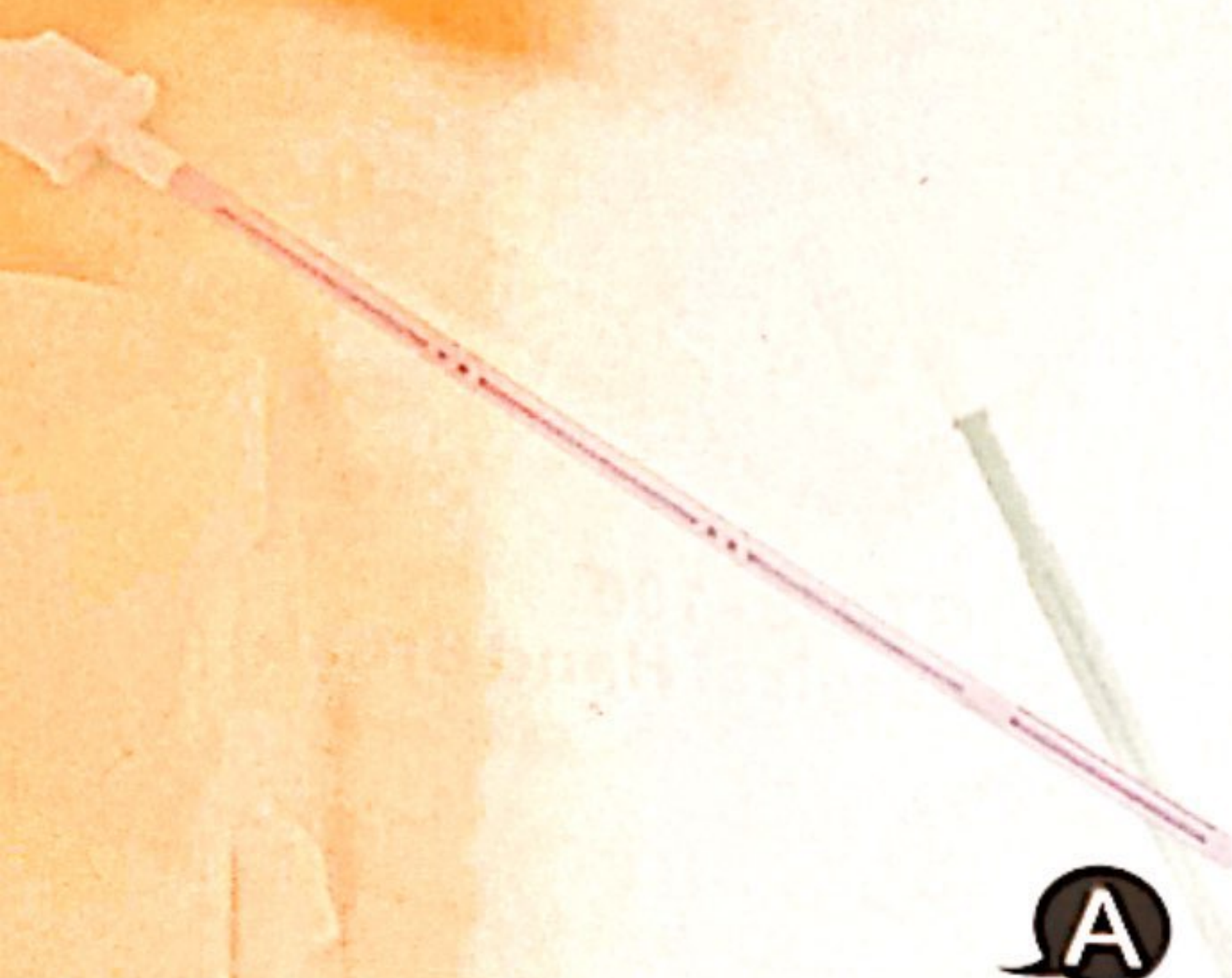

**A**

Number	Model	Description	Packaging	Quantity
GT159-0801	A-1	Push tube, pink brush, individually packaged, EO sterile.	20x100PCS/ carton	>20
GT159-0802	A-2	No Push tube, pink brush, individually packaged, EO sterile.	20x100PCS/ carton	>20

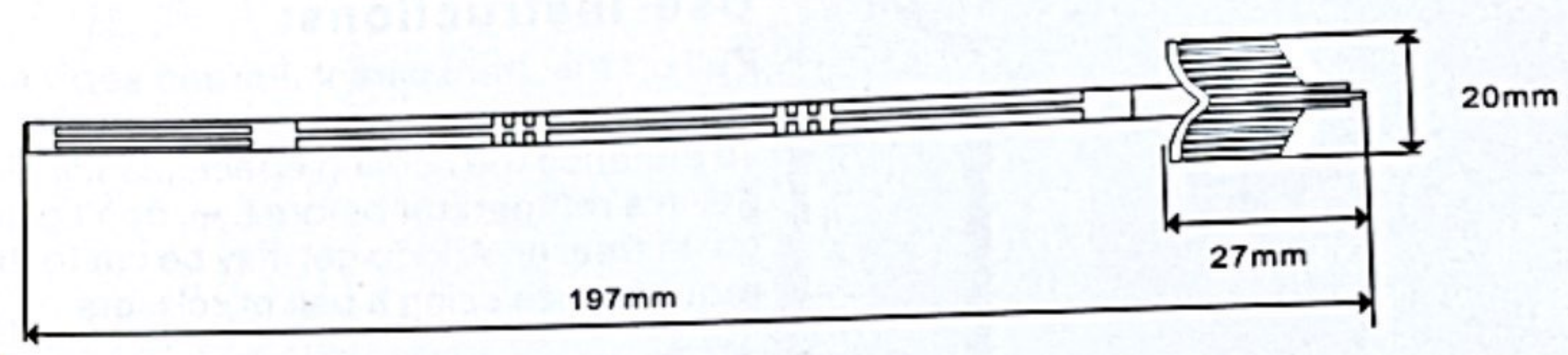
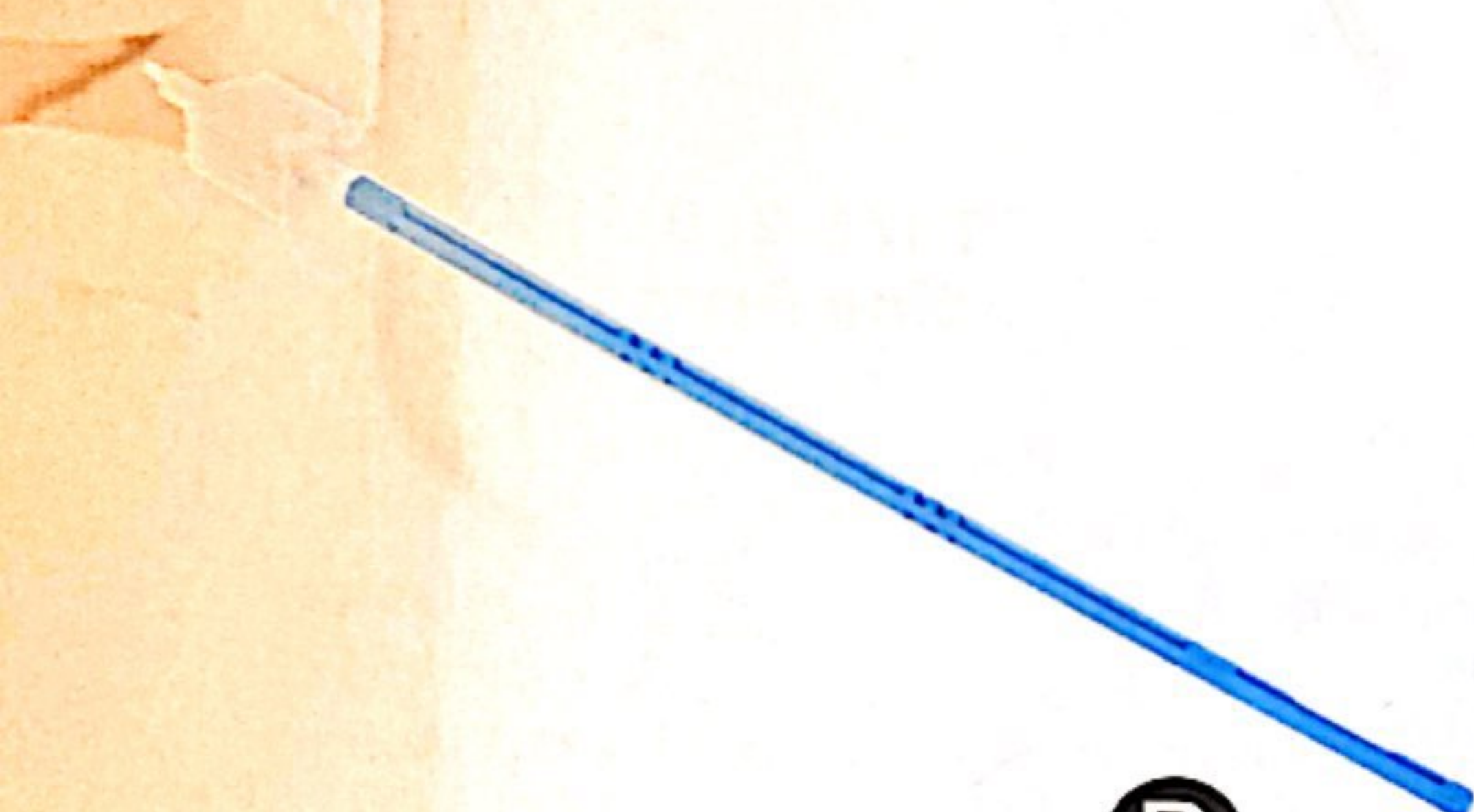

**B**

Number	Model	Description	Packaging	Quantity
GT159-0803	B-1	Push tube, blue brush, individually packaged, EO sterile.	20x100PCS/ carton	>
GT159-0804	B-2	NO Push tube, blue brush, individually packaged, EO sterile.	20x100PCS/ carton	>

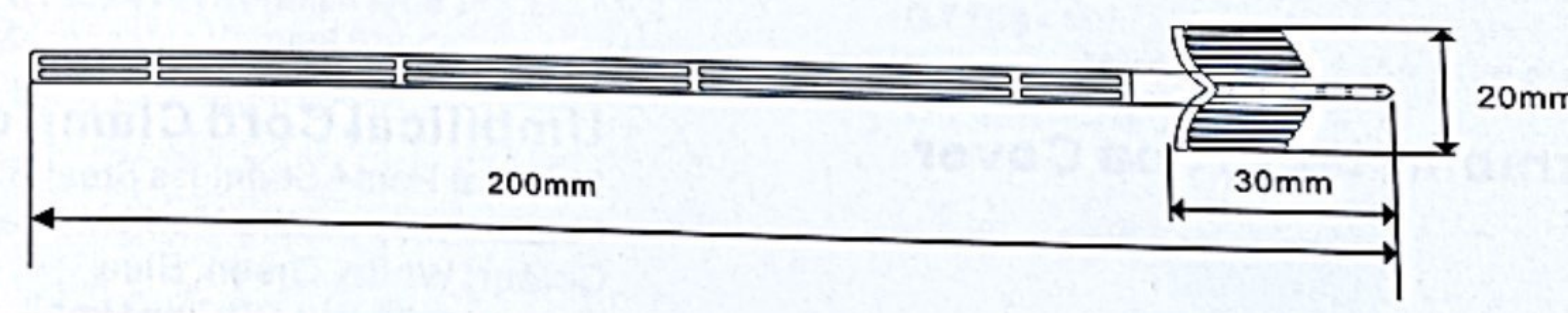
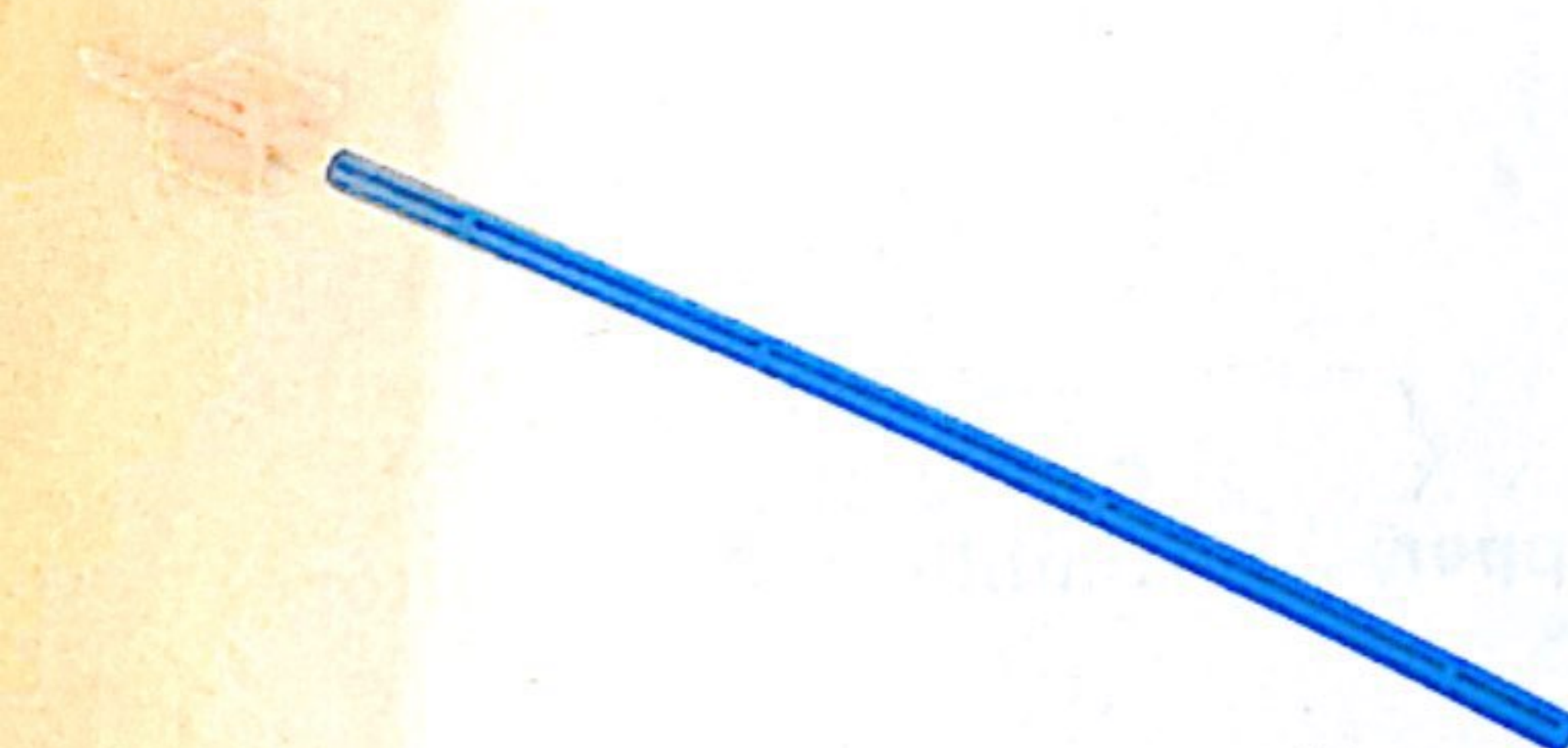

**C-1**

Number	Model	Description	Packaging
GT159-0805	C-1	Blue brush bar, individually packaged, EO sterile.	20x100PCS/ carton

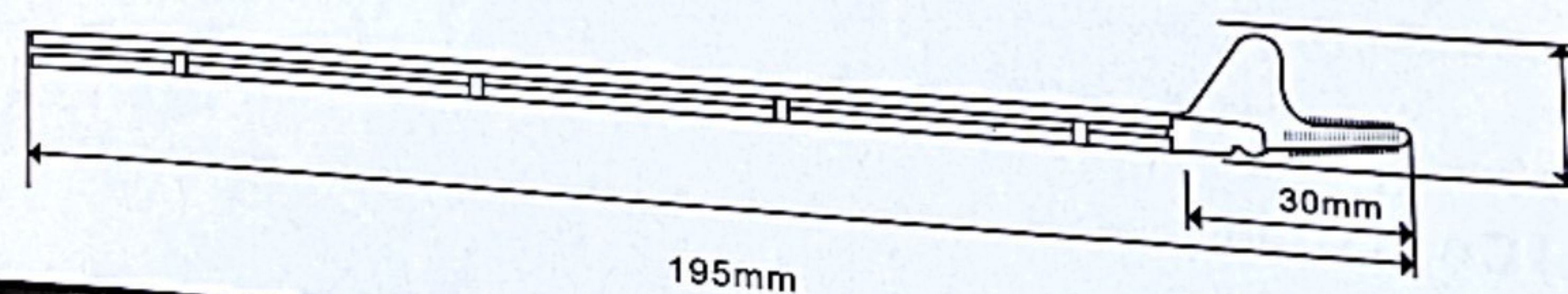

**C-2**

Number	Model



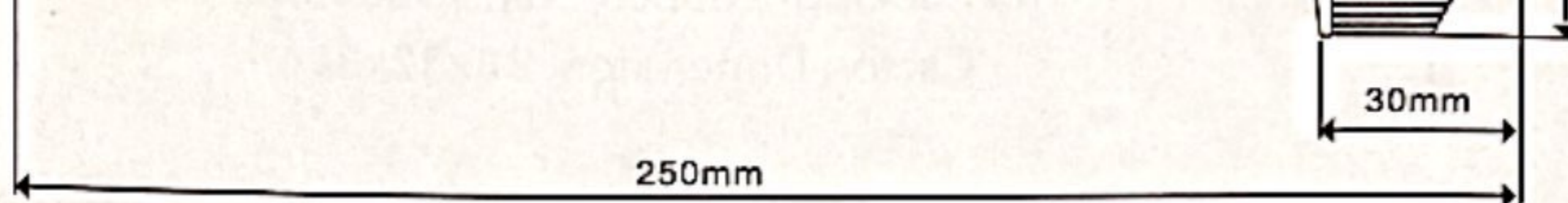

Number	Model	Description	Packaging
GT159-0801	A-1	Push tube, pink brush, individually packaged, EO sterile.	20x100PCS/ carton
GT159-0802	A-2	No Push tube, pink brush, individually packaged, EO sterile.	20x100PCS/ carton

**A**

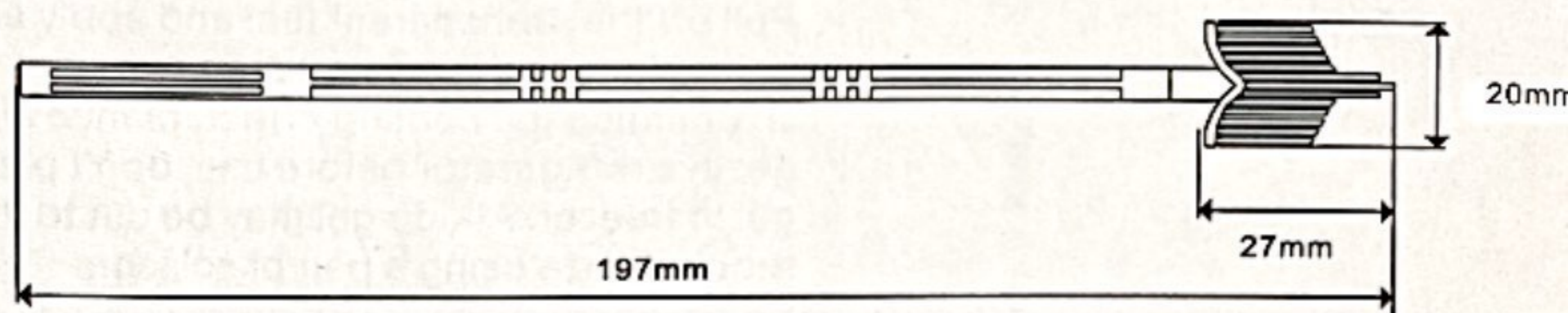

Number	Model	Description	Packaging
GT159-0803	B-1	Push tube, blue brush, individually packaged, EO sterile.	20x100PCS/ carton
GT159-0804	B-2	NO Push tube, blue brush, individually packaged, EO sterile.	20x100PCS/ carton

**B**

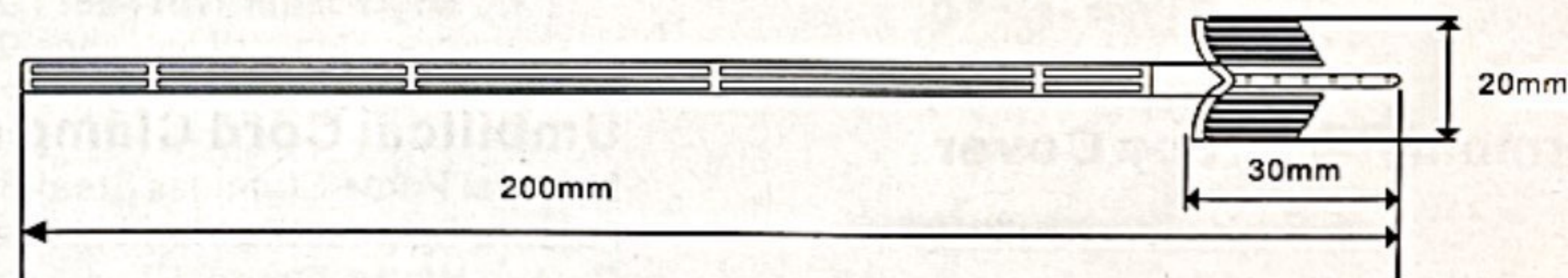

Number	Model	Description	Packaging
GT159-0805	C-1	Blue brush bar, individually packaged, EO sterile.	20x100PCS/ carton

**C-1**

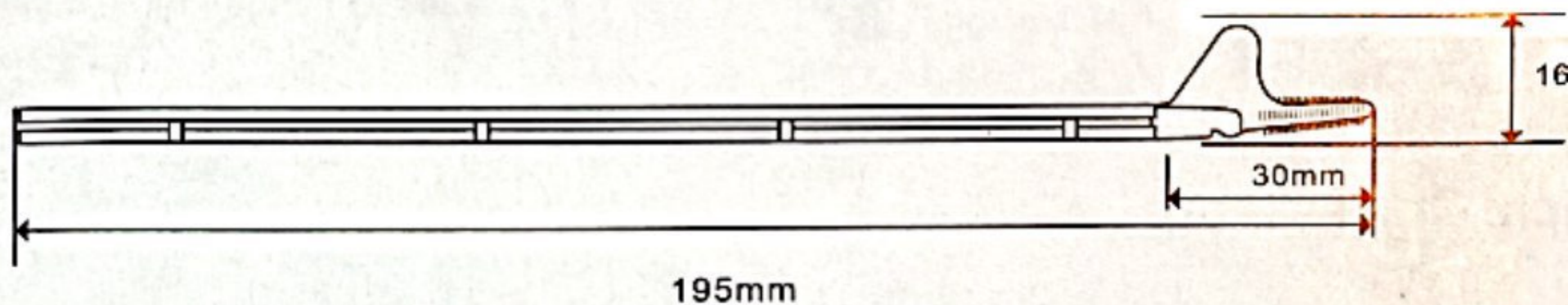

Number	Model	Description	Packaging
GT159-0807	C-2	Blue brush bar, individually packaged, EO sterile.	20x100PCS/ carton

**C-2**



# Disposable Cervical Brush

GT159-0800

Disposable Sampling Swab:

Used for Gynaecology, Andrology, and ENT, Etc.

Extracting epidermal cell by the brush at top.



Number	Model	Description	Packaging	Quantity
GT159-0824	I	Two joints, white, FlockKing, individually packaged, EO sterile.	20x100PCS/ carton	>2000PCS
GT159-0825	J	White, small head, FlockKing, individually packaged, EO sterile.	20x100PCS/ carton	>2000PCS
GT159-0826	K-1	White big head, Flocking individually packaged, EO sterile.	20x100PCS/ carton	>2000PCS
GT159-0827	M	White, brush bar with handle, Flocking, individually packaged, EO sterile.	20x100PCS/ carton	>2000PCS

# Disposable Endometrial Suction Cannula

Number	Model	Description	Packaging	Quantity
GT159-0832	Z-2	Four holes head ,individually packaged,EO sterile.	20x100PCS/ carton	>2000PCS
GT159-0833	Z-3	Three holes head ,individually packaged,EO sterile.	20x100PCS/ carton	>2000PCS





### GT105-100 Cold Eye Mask

Item: Cold Eye Mask

Weight: 65G

Size: 64 x 7.5 cm

Material: outer bag: PVC

infilling: Glycerol+ Carboxymethyl Cellulose Sodium + Preservative + distilled water

Packing: 120pcs/ctn, 52X23.5X22 cm,

G.W.:8.8kg, N.W.:7.8kg



### GT103-100 Hot Water Bag

Item: Hot Water Bag

Material: Calcium carbonate + 25% rubber

Description:

500CC	1pc/1 PE bag	100pcs/ctn	38X30X35cm
750CC	1pc/1 PE bag	50pcs/ctn	38X30X26cm
1000CC	1pc/1 PE bag	50pcs/ctn	38X30X28cm
1750CC	1pc/1 PE bag	50pcs/ctn	38X30X30cm
2000CC	1pc/1 PE bag	50pcs/ctn	38X30X35cm
2500CC	1pc/1 PE bag	50pcs/ctn	38X30X38cm
3000CC	1pc/1 PE bag	50pcs/ctn	38X30X42cm

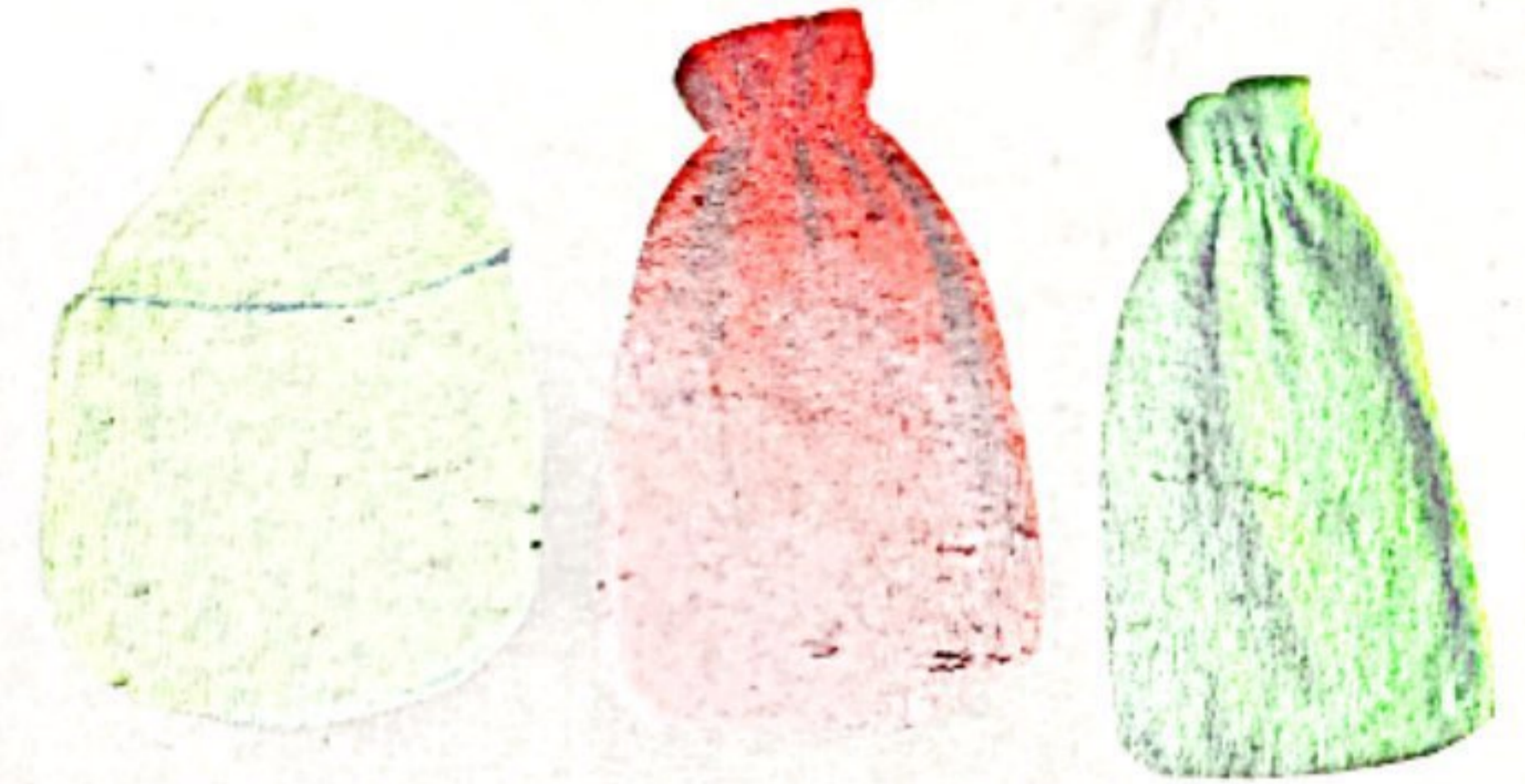

### GT103-200

#### Cover for hot water bag

Cover for hot water bag made of fabric

All kinds of fabric are available such as furry etc

Size: suitable for 500ml, 1000ml, 2000ml, 2500ml

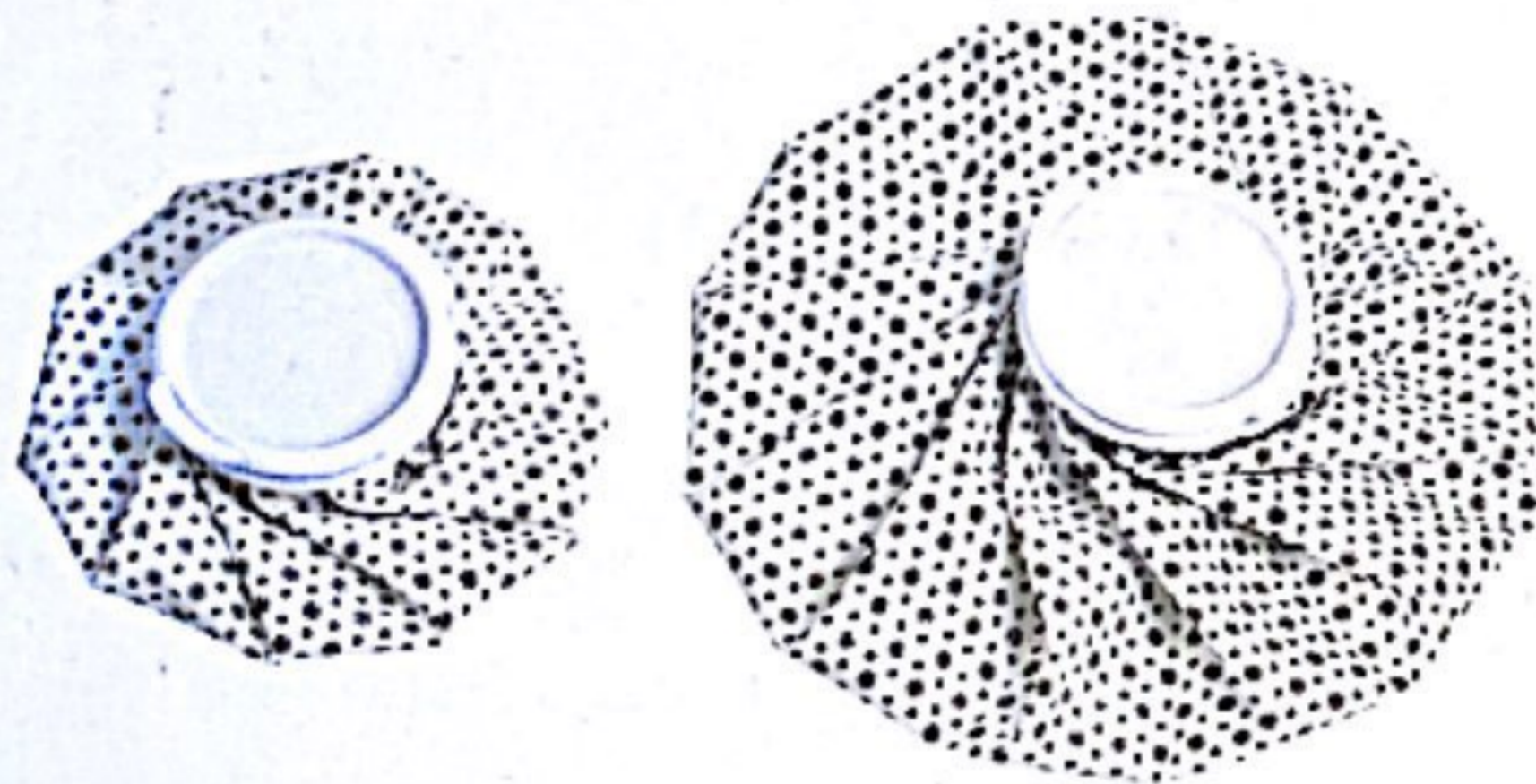

### GT104-100 Ice Bag

Material: PVC gel scrawled fabric

Description:

6"	1pc/ 1 PE bag	100pcs/ctn	38X38X35cm
9"	1pc/ 1 PE bag	100pcs/ctn	38X38X38cm
11"	1pc/ 1 PE bag	100pcs/ctn	40X38X43cm

### GT115-001 Ice Bag

Weight: 160g

Size: 19.5 x 12 cm

Material: outer bag: PE + PA infilling: carbamide + distilled water

Packing: 80pcs/ctn, 46X30.5X23 cm, G.W.13.8kg, N.W.12.8kg

Item: Disposable Ice Bag

Weight: 280g

Size: 24 x 12 cm

Material: outer bag: PE + PA infilling: Carbamide + distilled water

Packing: 50pcs/ctn, 46X30.5X23 cm, G.W.15kg, N.W.14kg



#### Usage:

Find the liquid bag in the ice bag and make it broken and 3 seconds later it will be frozen. Then shake the bag up and down to make the content fully mixed, and the temperature will be depressed below zero by the ice bag in 2 minutes.

#### Purpose:

To control and alleviate the sore and pain caused by strain, bruise, pull and burn, also can rapidly remove the pain and discomfort induced by fever, headache, toothache, mosquito bite.

Freeze and keep fresh vegetable, fruit, beer, beverage and food and so on when no cold source available.

#### Precaution:

The ice bag can only be used for external medication. If eye or skin should contact the content, it must be washed by clean water thoroughly. If one eats the content by mistake, he must drink enough water, try his best to vomit it and turn to doctor when necessary.

In order to avoid a too low temperature, it should be better to wrap the ice bag with a towel or cotton cloth to begin with. Those who have something wrong with their circulation system should refer to doctor in advance.

#### Characteristic:





### GT096-100

#### Zinc oxide plaster

Material: 10% Zinc oxide with 90% hot melt adhesive  
 Color: White, Flesh.  
 Weight of adhesive: 80-85g/m<sup>2</sup>  
 Width: 1.25cm, 2.5cm, 5cm, 7.5cm, 10cm etc.  
 Length: 5m, 10m etc.  
 Packing: Plastic can, Tinplate or simple packing.

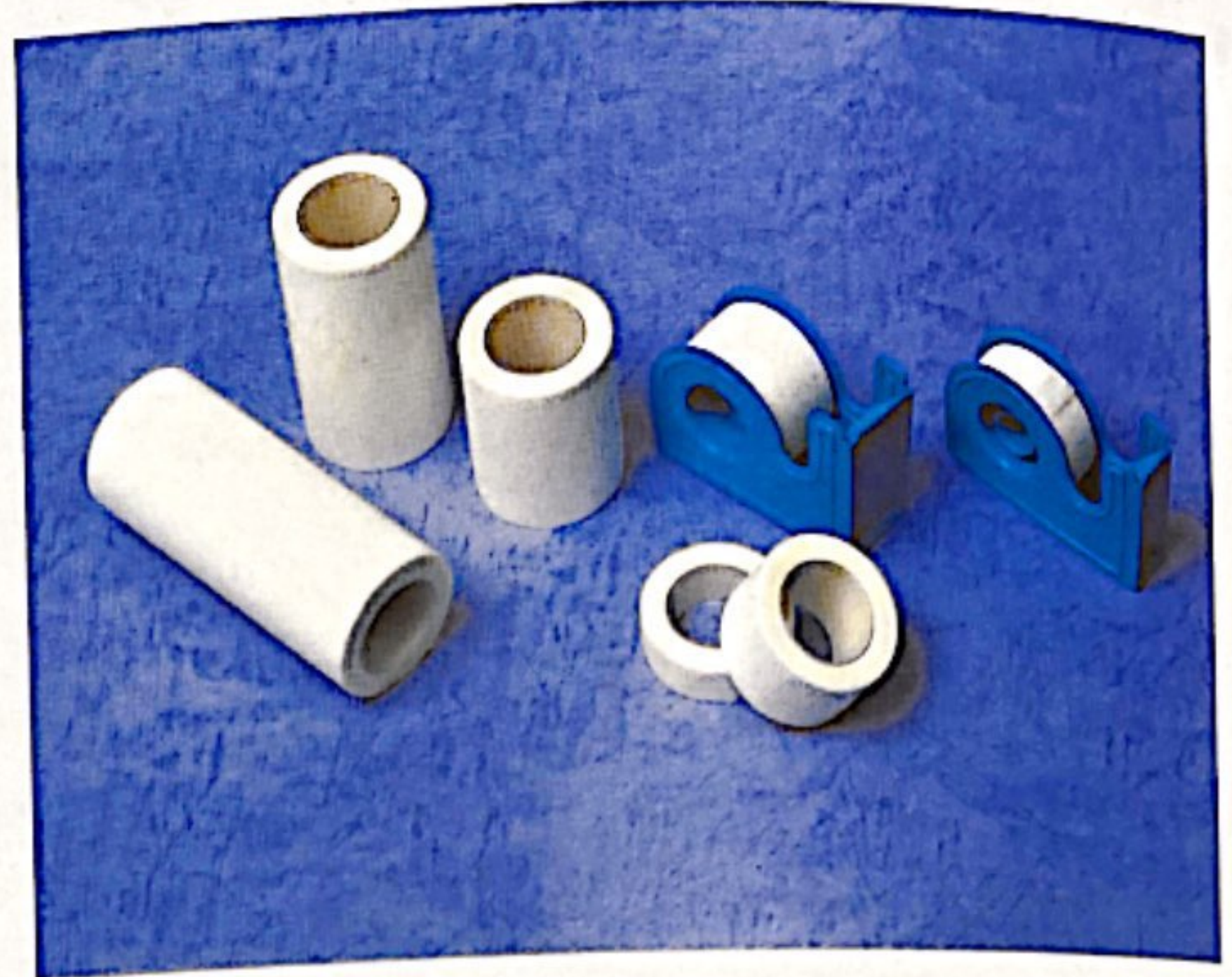

### GT097-100

#### Non-woven surgical tape

Material: Non-woven with adhesive  
 Color: White, Flesh.  
 Weight of adhesive: 30-32g/m<sup>2</sup>  
 Width: 1.25cm, 2.5cm, 5cm, 7.5cm, 10cm etc.  
 Length: 5m, 5y, 10y etc.  
 Packing: Plastic can, Plastic cutter or simple packing.

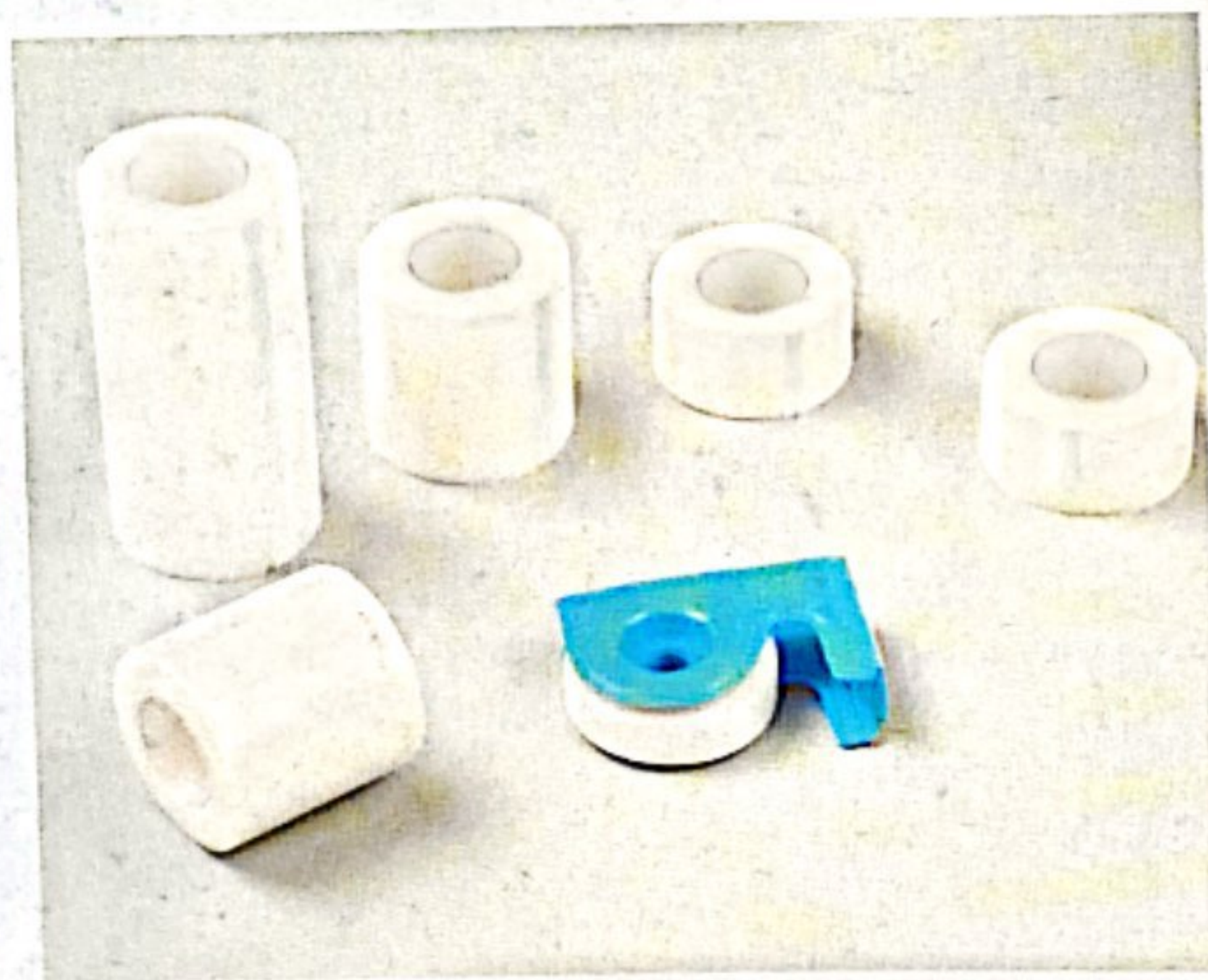

### GT098-100

#### PE surgical tape

Material: Polyethylene with adhesive  
 Color: Transparent  
 Weight of adhesive: 30-34g/m<sup>2</sup>  
 Width: 1.25cm, 2.5cm, 5cm, 7.5cm, 10cm etc.  
 Length: 5m, 5y, 10y etc.  
 Packing: Plastic can, Plastic cutter or simple packing.

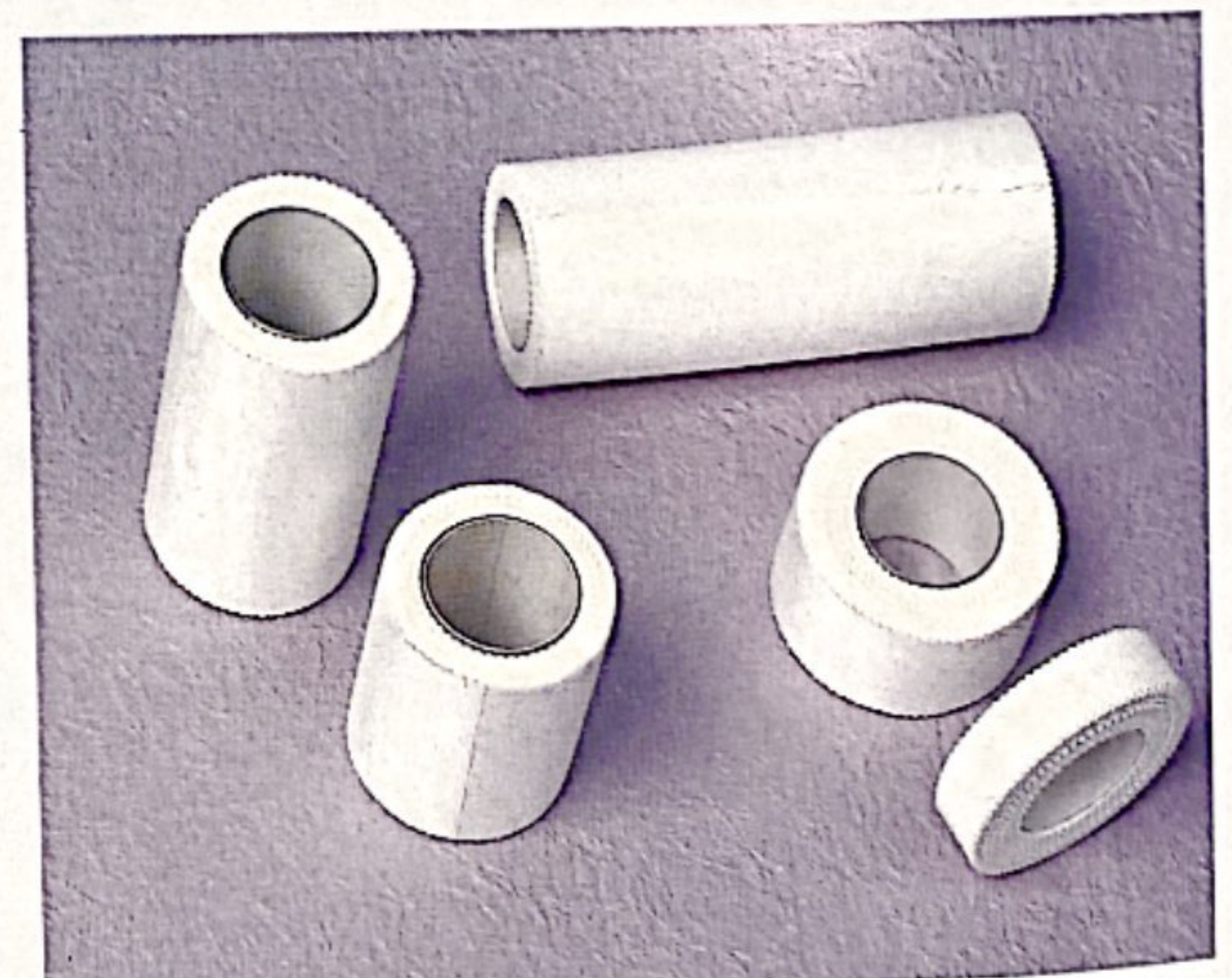

### GT099-100

#### Silk surgical tape

Material: Silk with adhesive,  
 Drilled or non-drilled is available  
 Line shape or zig shape is available  
 Color: White  
 Weight of adhesive: drilled 50-54g/m<sup>2</sup>,  
 Non-drilled: 32-34g/m<sup>2</sup>  
 Width: 1.25cm, 2.5cm, 5cm, 7.5cm, 10cm etc.  
 Length: 5m, 5y, 10y etc.  
 Packing: Plastic can, simple packing.



**GT102-153 Abdominal pad**

Material: Non-Woven fabrics + FULLF +SAP + Water Proof

Description: Color: white

10X10cm	1pc/pouch	50pouches/box	12boxes/ctn	42X36X42cm
10X20cm	1pc/pouch	20pouches/box	36boxes/ctn	51X46X48cm
20X10cm	1pc/pouch	20pouches/box	18boxes/ctn	51X40X48cm
20X30cm	1pc/pouch	20pouches/box	12boxes/ctn	52X18X47cm
20X40cm	1pc/pouch	20pouches/box	12boxes/ctn	52X35X52cm

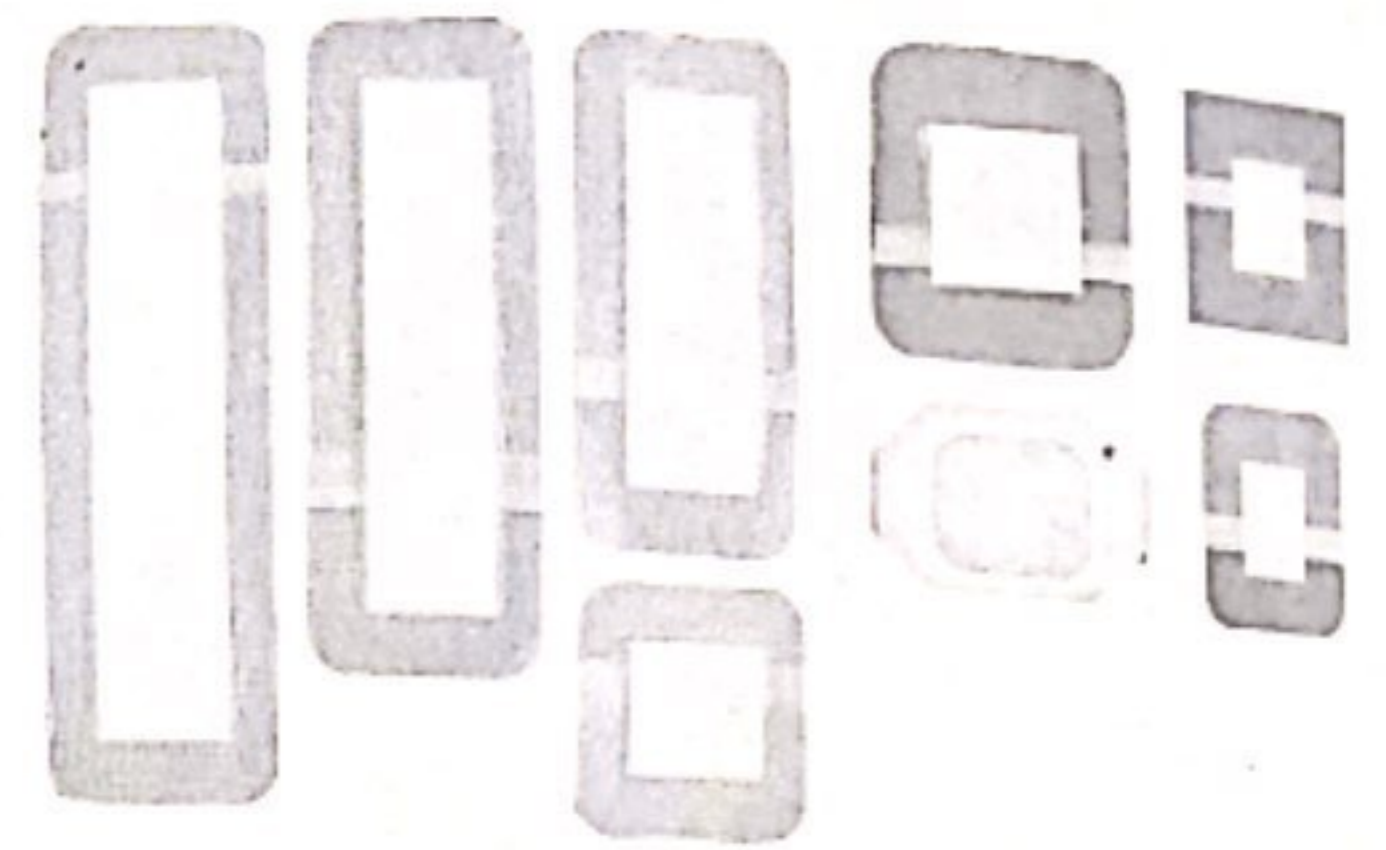

**GT102-150 PU adhesive tape**

Material: Polyurethane film

Available in line shape or zig shape

Color: transparent

Size: 5x1000cm, 10x1000cm, 15x1000cm, 20x1000cm etc.

Packing: 100rolls/carton, 50rolls/carton



**GT102-160 Fiberglass casting tape**

Material: Fiberglass

Size: 5cmx360cm, 7.5cmx360cm, 10cmx360cm, 12.5cmx360cm, 15cmx360cm etc.

Packing: 1pc/ Aluminum Foil Bag 50pcs/box 100box/carton



**GT102-110**

**Self-adhesive wound dressing**

Material: PU, Non-woven, etc.

Color: White, Flesh, etc.

Weight of adhesive: 70-75g/m2

Shape: Round corner, Square corner,

With mat or without is available.

Size: 5cmx7cm, 6cmx8cm, 10cmx10cm, 10cmx12cm, 10cmx15cm, 10cmx20cm, 10cmx25cm, 10cmx30cm, 10cmx35cm etc.

Packing: 50pcs/box

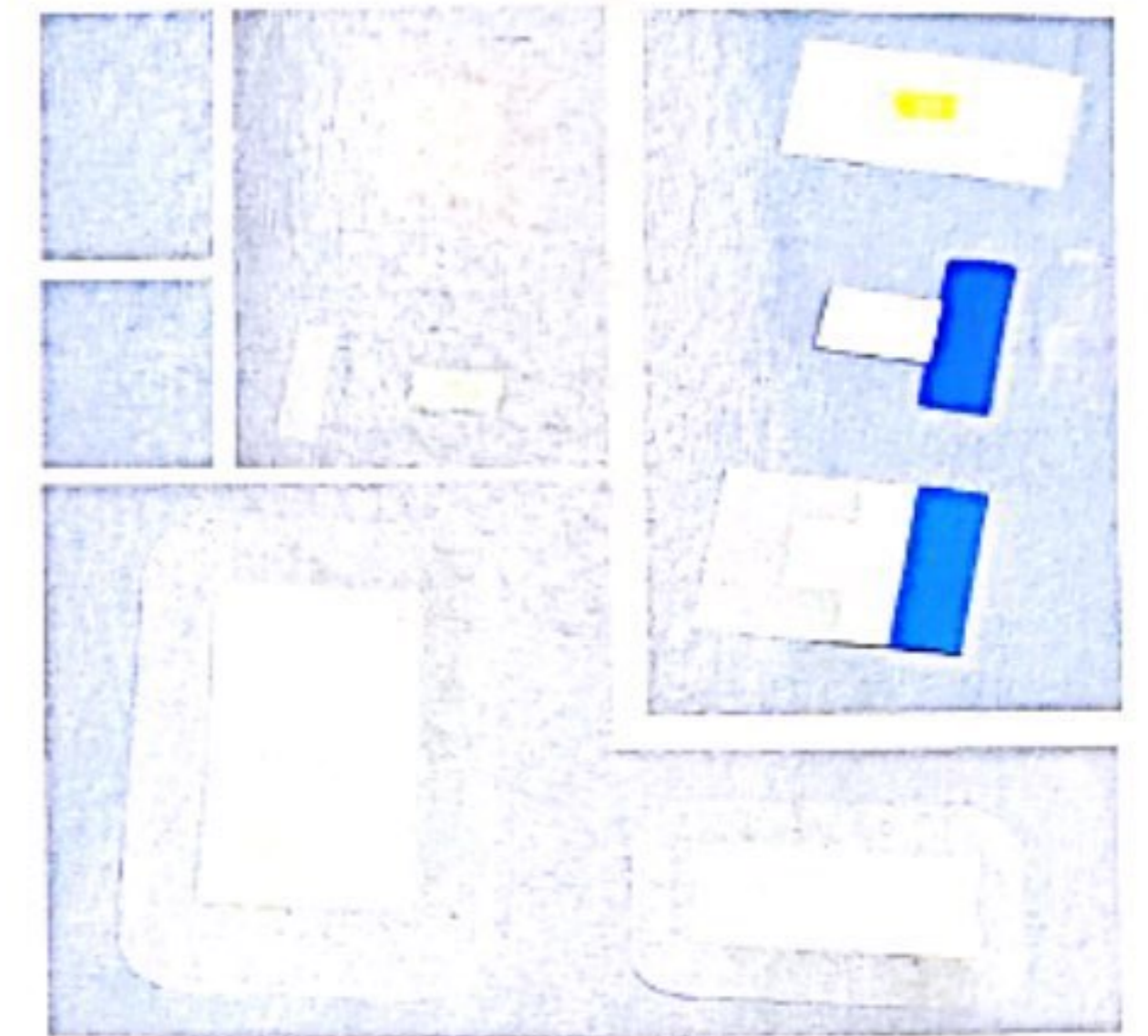

**GT102-120**

**Infusion plaster**

Material: Non-woven

Color: White, Flesh.

Weight of adhesive: 30-32g/m2

Shape: Rectangle

Size: 70x25mm, 70x35mm etc.

Packing: 100pcs/box 100box/carton

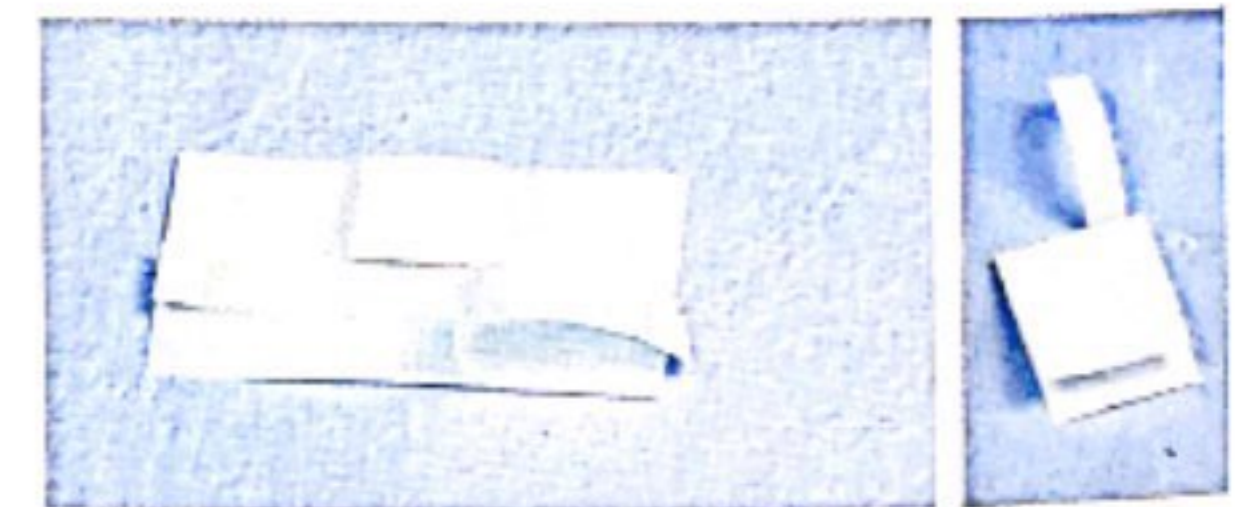

**GT102-130**

**Self-adhesive eye pad**

Material: Non-woven

Color: White, Flesh.

Weight of adhesive: 30-32g/m2

Shape: Oval

Size: 80x50mm, 85x55mm, 95x65mm etc.

Packing: 50pcs/box 100box/carton

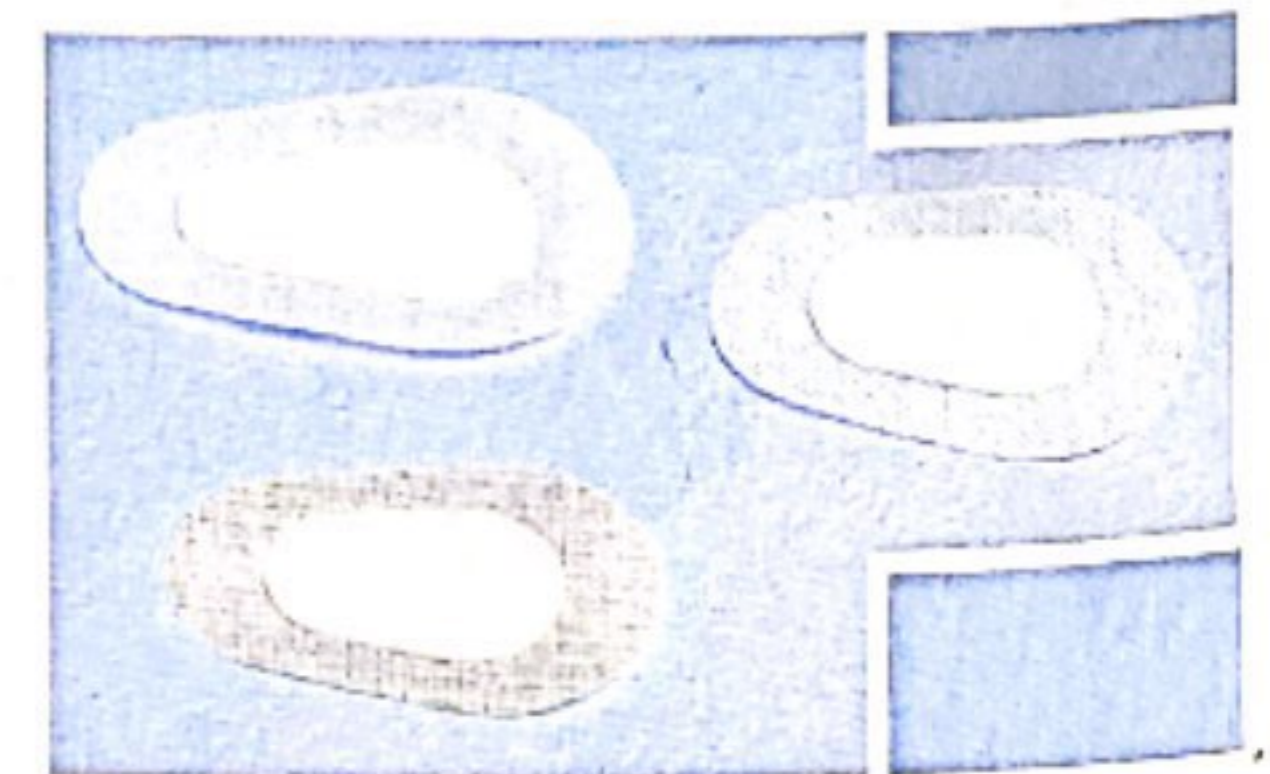

**GT102-140**

**Non-adherent pad**

Material: 70% Viscose with 30% Polyester

Color: White

Shape: Round, Square, Rectangle

Size: 5x5cm, 10x10cm, 15x15cm, 20x20cm etc.

Packing: 100pcs/box 100box/carton

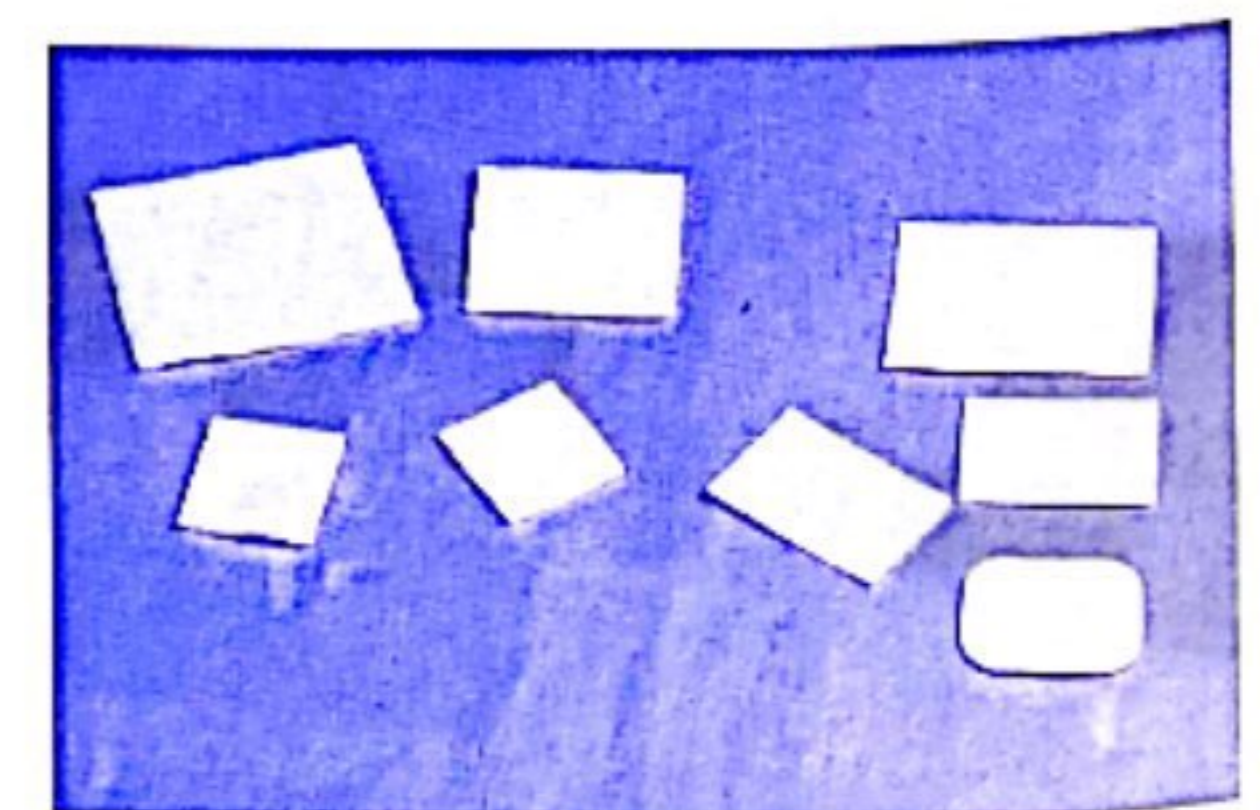



**GT029-700**  
**Disposable Silicone Laryngeal Mask**

Made of 100% medical grade silicone  
 No posion and harmless  
 Non-epiglottis-bar design provides easy and clear access through the lumen  
 5 angular lines appear when the cuff is in flat status,which can avoid the cuff to deform during insertion  
 Deep bowl of the cuff provides excellent sealing and prevent the obstruction caused by epiglottis ptosis  
 Special treatment of the cuffs surface reduce leak and shift effectively  
 Suitbale for adult,children and infant use  
 Sterilization:EO  
 Size 1#,1.5#,2#,2.5#,3#,4#,5#  
 Packing:Blister bag

**GT029-720**  
**Disposable PVC Laryngeal Mask**

Made of non-toxic medical grade PVC  
 No posion and harmless  
 Non-epiglottis-bar design provides easy and clear access through the lumen  
 Special treatment of the cuff's surface reduce leak and shift effectively  
 Sterilization:EO  
 Size: 1#,1.5#,2#,2.5#,3#,4#,5#  
 Packing:Blister bag

Size	Indicative Patient/Weight	Maximal Volume of Balloon	Remark
1#	<6	4	Newborn
1.5#	6-10	4	Infant
2#	10-20	5	Child
2.5#	20-30	12	Child
3#	30-50	20	Adult
4#	50-70	30	Adult
5#	70-100	40	Adult

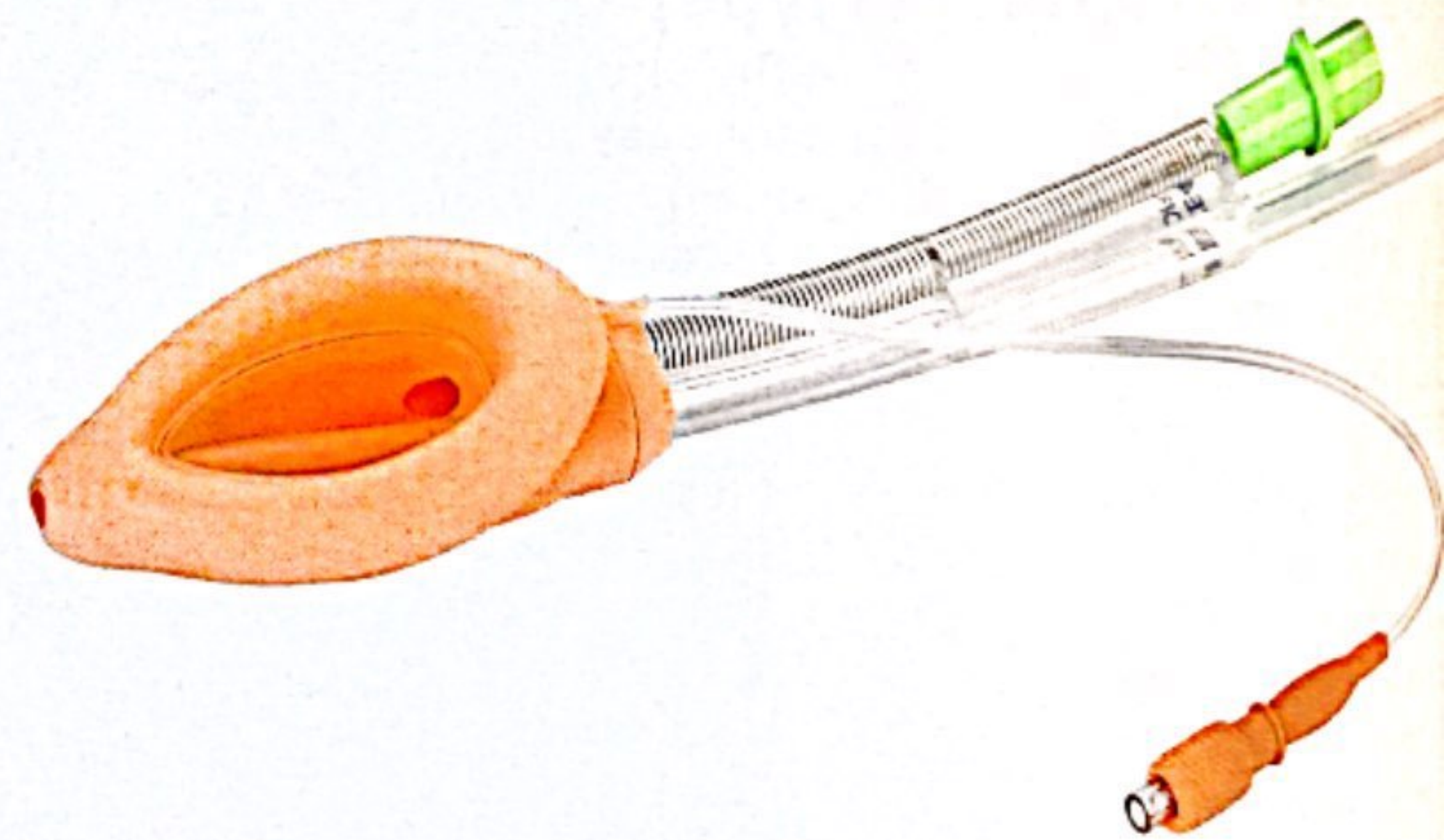
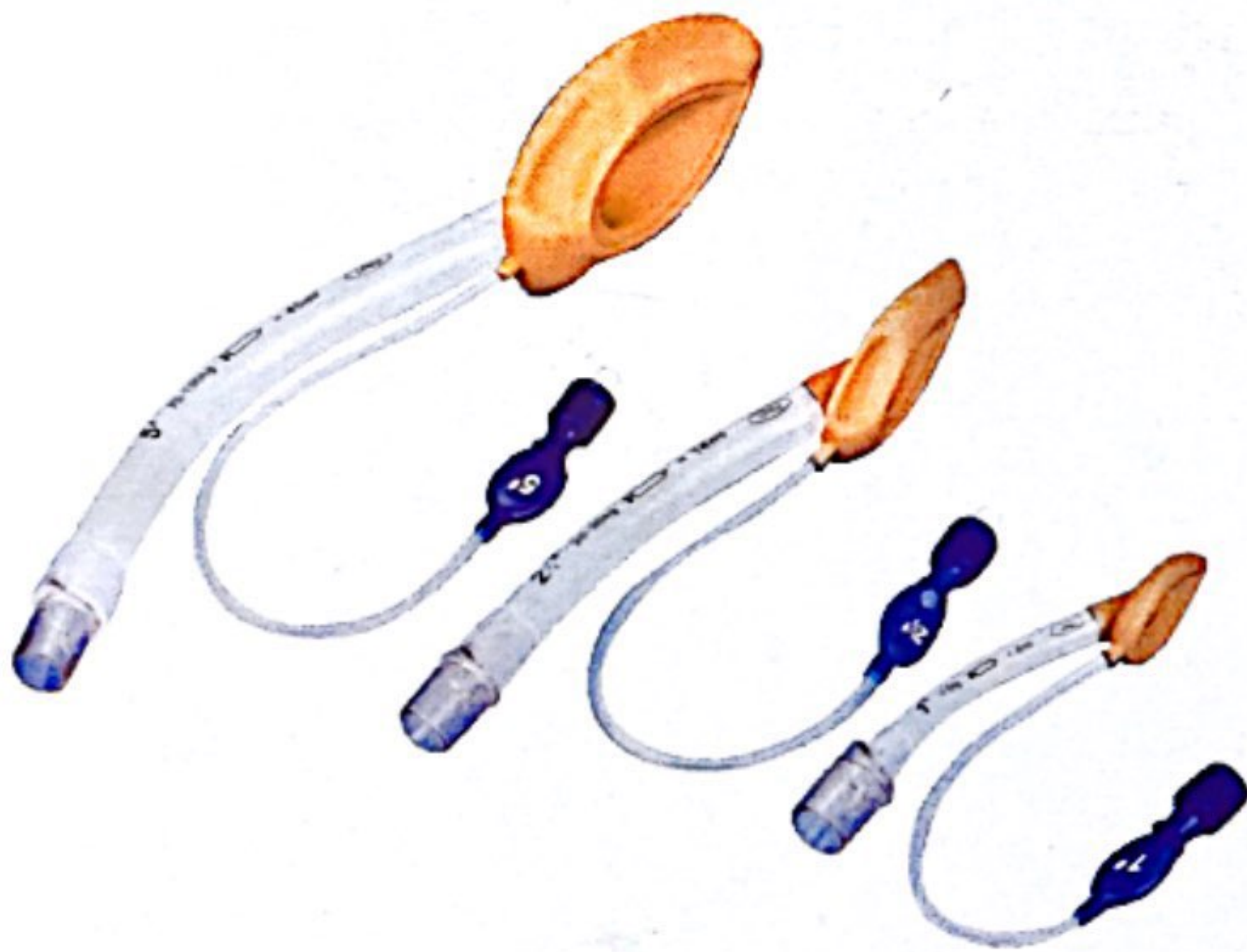

**GT029-710**  
**Reusable Silicone Laryngeal Mask**

Made of 100% medical grade silicone  
 No posion and harmless  
 Non-epiglottis-bar design provides easy and clear access through the lumen Can be used for 40 times and sterilized by 121 °C steam  
 5 angular lines appear when the cuff is in flat status,which can avoid the cuff to deform during insertion  
 Deep bowl of the cuff provides excellent sealing and prevent the obstruction caused by epiglottis ptosis  
 Special treatment of the cuffs surface reduce leak and shift effectively  
 Suitbale for adult,children and infant use  
 Sterilization:EO  
 Size: 1#,1.5#,2#,2.5#,3#,4#,5#  
 Packing:Blister bag

**GT027-730**  
**Reinforced Silicone Laryngeal Mask**

Made of 100% medical grade silicone  
 No posion and harmless  
 Spiral reinforcement minimizes crushing or kinking  
 Smooth transparent and kink-resistant tube  
 Suitbale for adult,children and infant use  
 Sterilization:EO  
 Size: 1#,1.5#,2#,2.5#,3#,4#,5#  
 Packing:Blister bag



# Connection Tube with r Handle

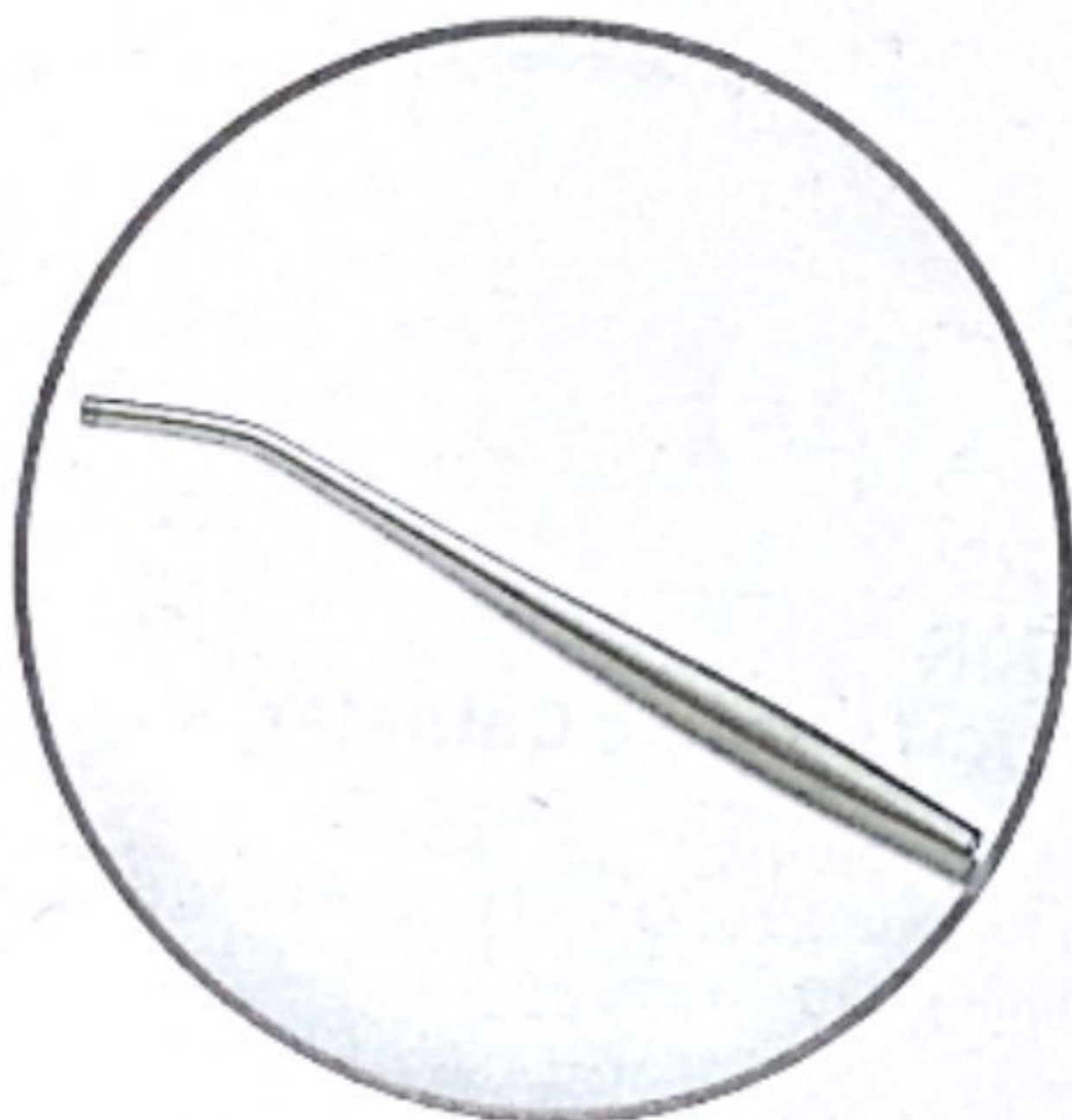
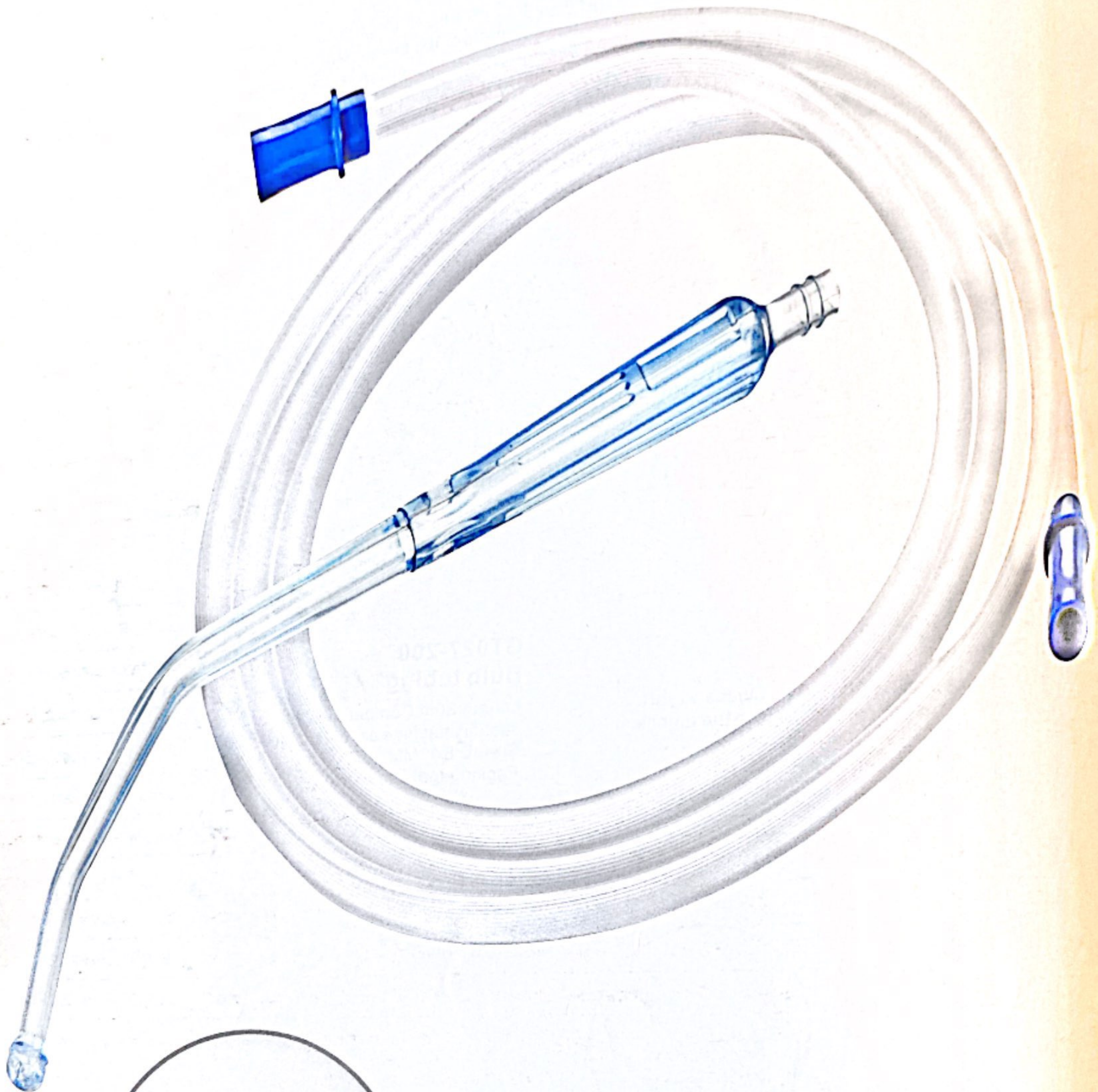

## GT027-100

Made from Medical grade PVC, clear and soft.  
Crown tip or Plain tip; With or without Vented; Three types  
connectors: Short type, Long type, and Trumpet type; Two types  
handle shape: Normal Yankauer handle, and Rugby shape handle.  
size: Diameter: 1/4", 3/16", 9/32" etc  
Length: 1.8M, 2M, 2.5M, 3.0M, 3.6M etc.  
packing: Individual Blister Bag



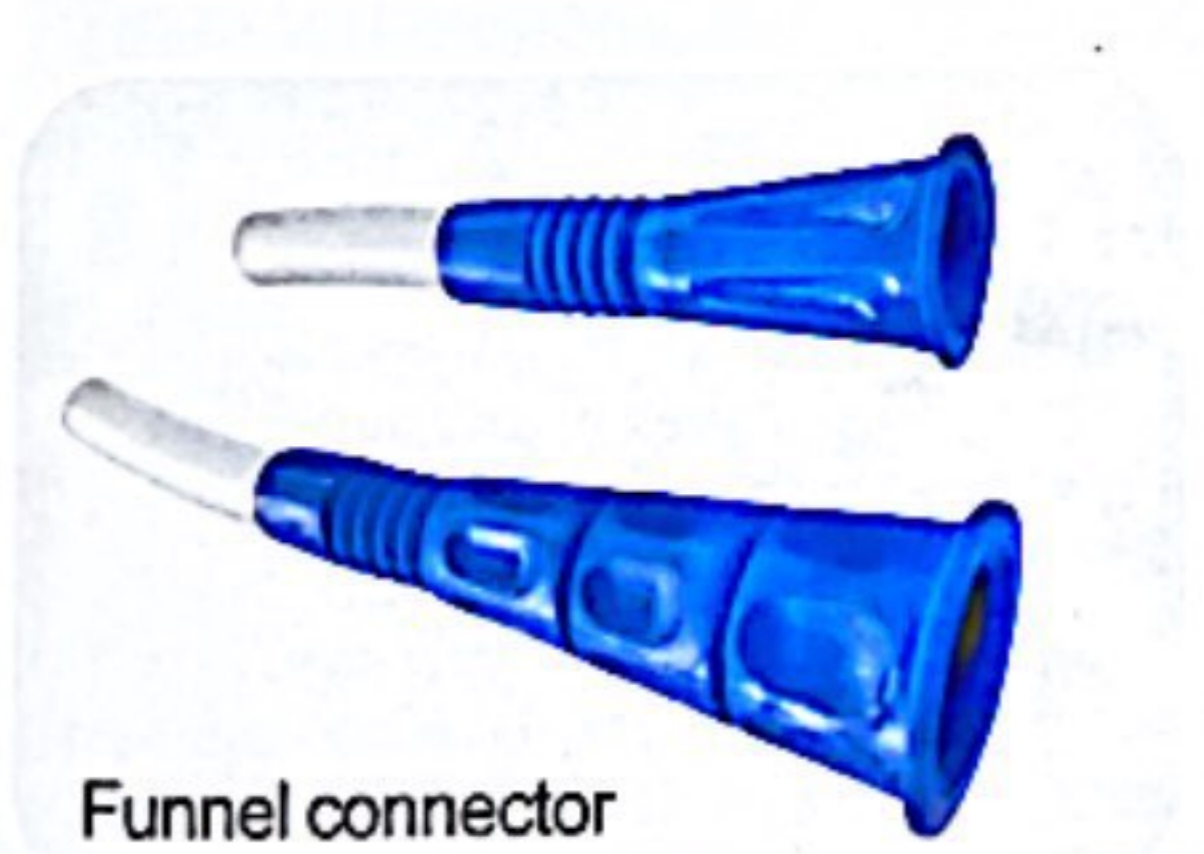
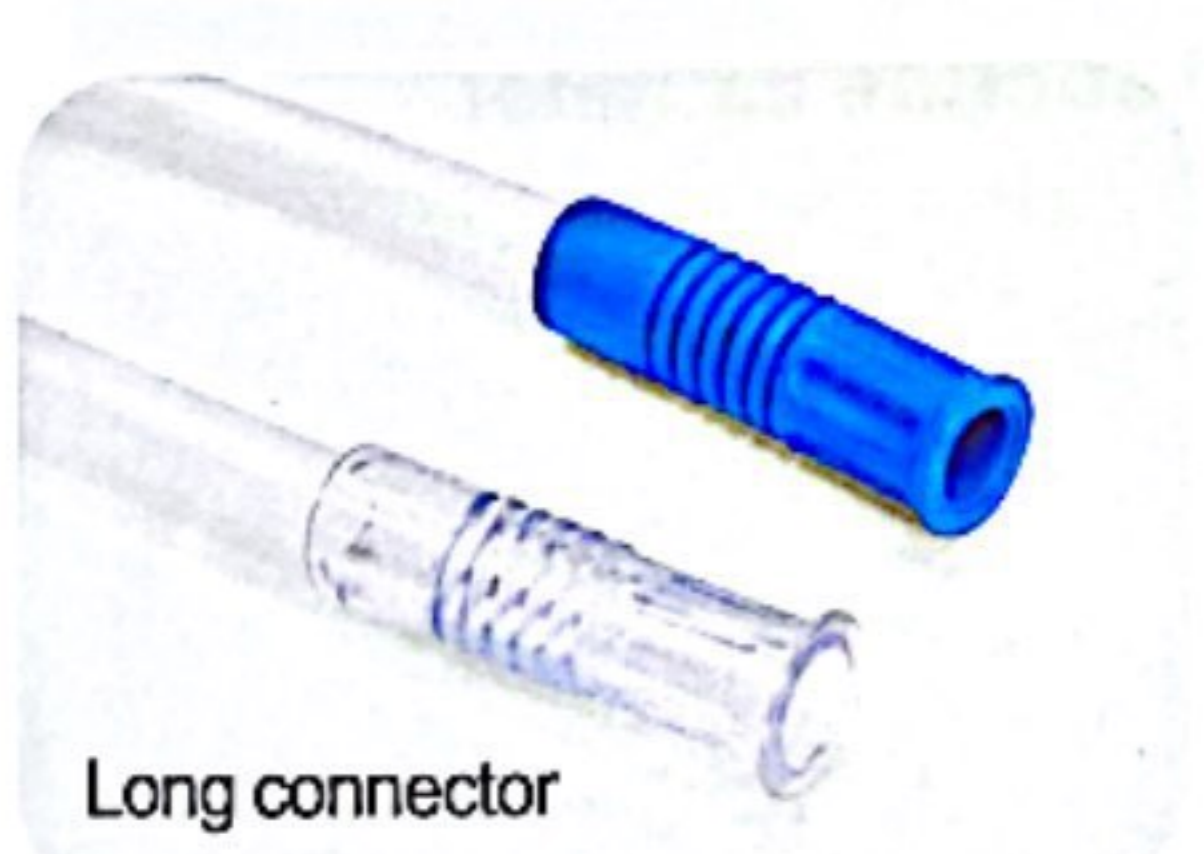
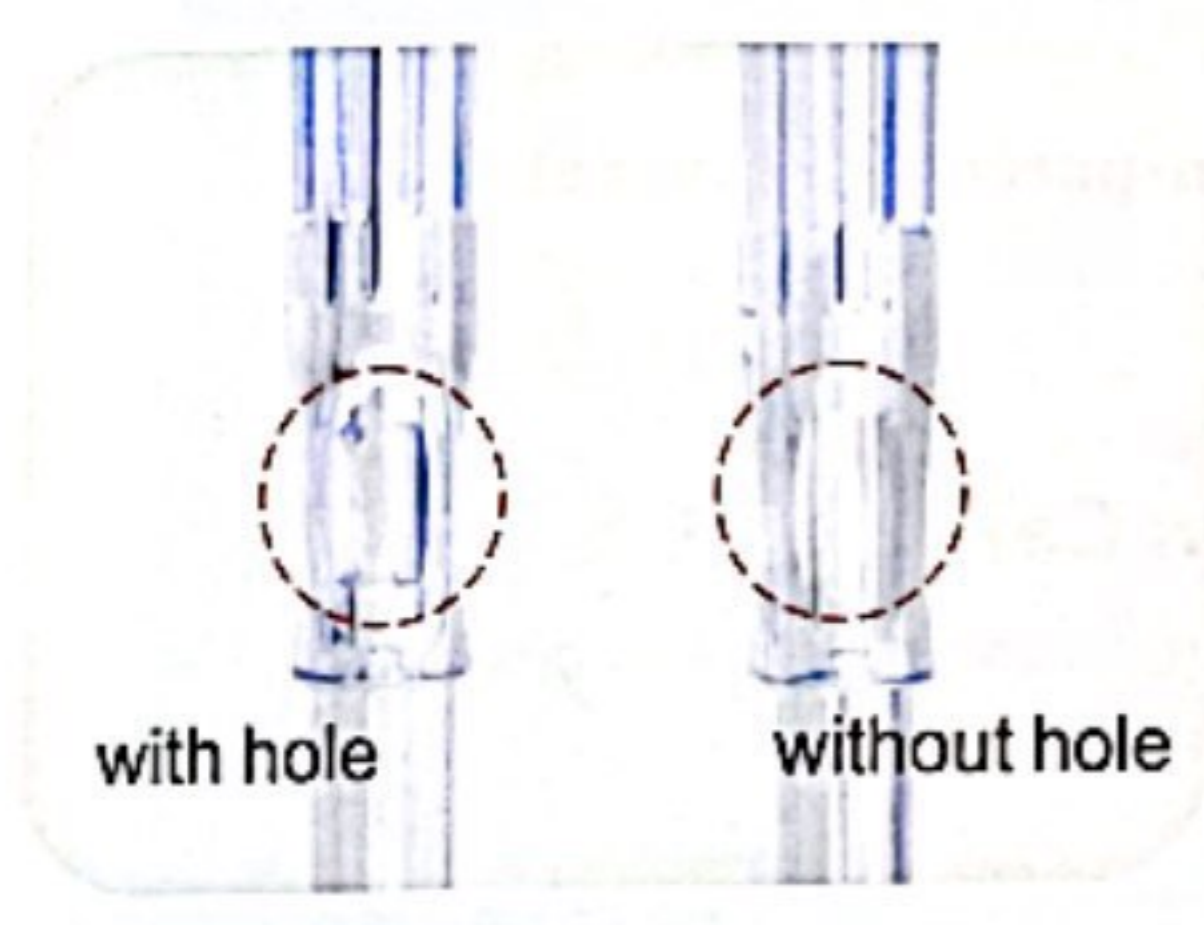
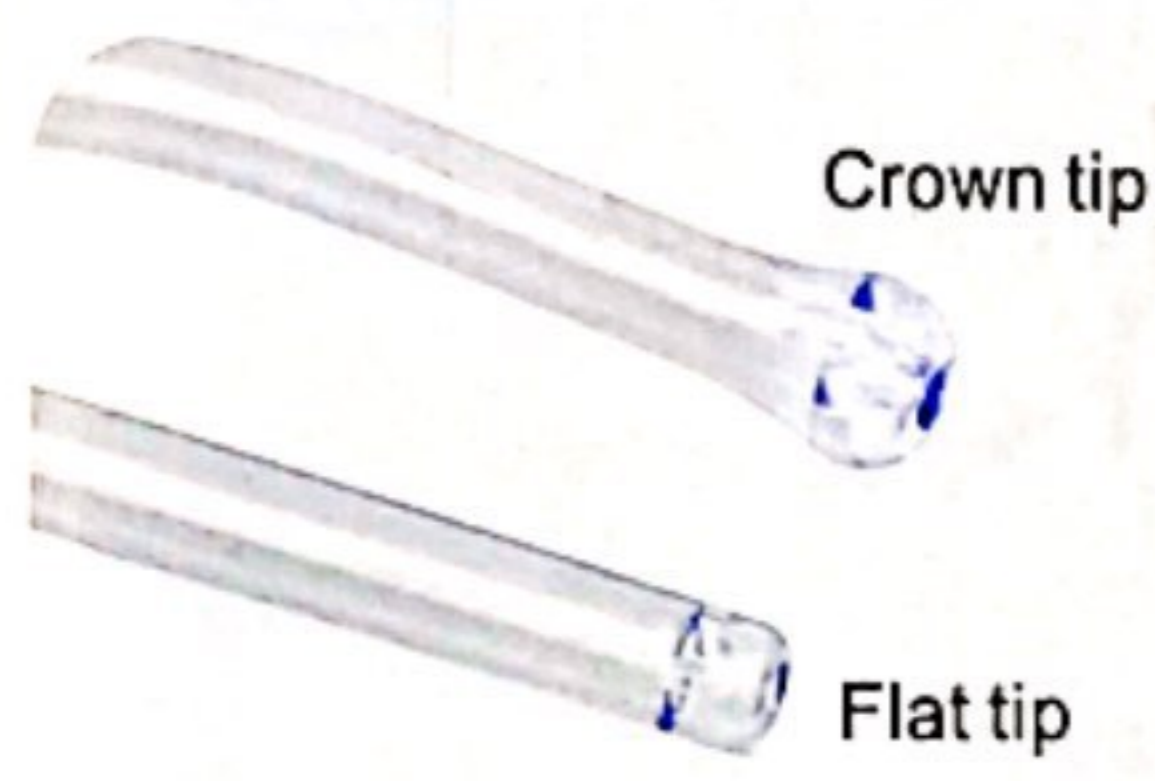

Code	Suction Tube	Yankauer Handle	Hole	Connector	Length
GT027-100-1	1/4Inch	Crown tip	with hole	Long connector	Length can be customized
GT027-100-2	1/4Inch	Crown tip	with hole	Short connector	Length can be customized
GT027-100-3	1/4Inch	Crown tip	with hole	Funnel connector	Length can be customized
GT027-100-4	1/4Inch	Crown tip	without hole	Long connector	Length can be customized
GT027-100-5	1/4Inch	Crown tip	without hole	Short connector	Length can be customized
GT027-100-6	1/4Inch	Crown tip	without hole	Funnel connector	Length can be customized
GT027-100-7	1/4Inch	Flat tip	with hole	Long connector	Length can be customized
GT027-100-8	1/4Inch	Flat tip	with hole	Short connector	Length can be customized
GT027-100-9	1/4Inch	Flat tip	with hole	Funnel connector	Length can be customized
GT027-100-10	1/4Inch	Flat tip	without hole	Long connector	Length can be customized
GT027-100-11	1/4Inch	Flat tip	without hole	Short connector	Length can be customized
GT027-100-12	1/4Inch	Flat tip	without hole	Funnel connector	Length can be customized
GT027-100-13	3/16Inch	Crown tip	with hole	Long connector	Length can be customized
GT027-100-14	3/16Inch	Crown tip	with hole	Short connector	Length can be customized
GT027-100-15	3/16Inch	Crown tip	with hole	Funnel connector	Length can be customized
GT027-100-16	3/16Inch	Crown tip	without hole	Long connector	Length can be customized
GT027-100-17	3/16Inch	Crown tip	without hole	Short connector	Length can be customized
GT027-100-18	3/16Inch	Crown tip	without hole	Funnel connector	Length can be customized
GT027-100-19	3/16Inch	Flat tip	with hole	Long connector	Length can be customized
GT027-100-20	3/16Inch	Flat tip	with hole	Short connector	Length can be customized
GT027-100-21	3/16Inch	Flat tip	with hole	Funnel connector	Length can be customized
GT027-100-22	3/16Inch	Flat tip	without hole	Long connector	Length can be customized
GT027-100-23	3/16Inch	Flat tip	without hole	Short connector	Length can be customized
GT027-100-24	3/16Inch	Flat tip	without hole	Funnel connector	Length can be customized



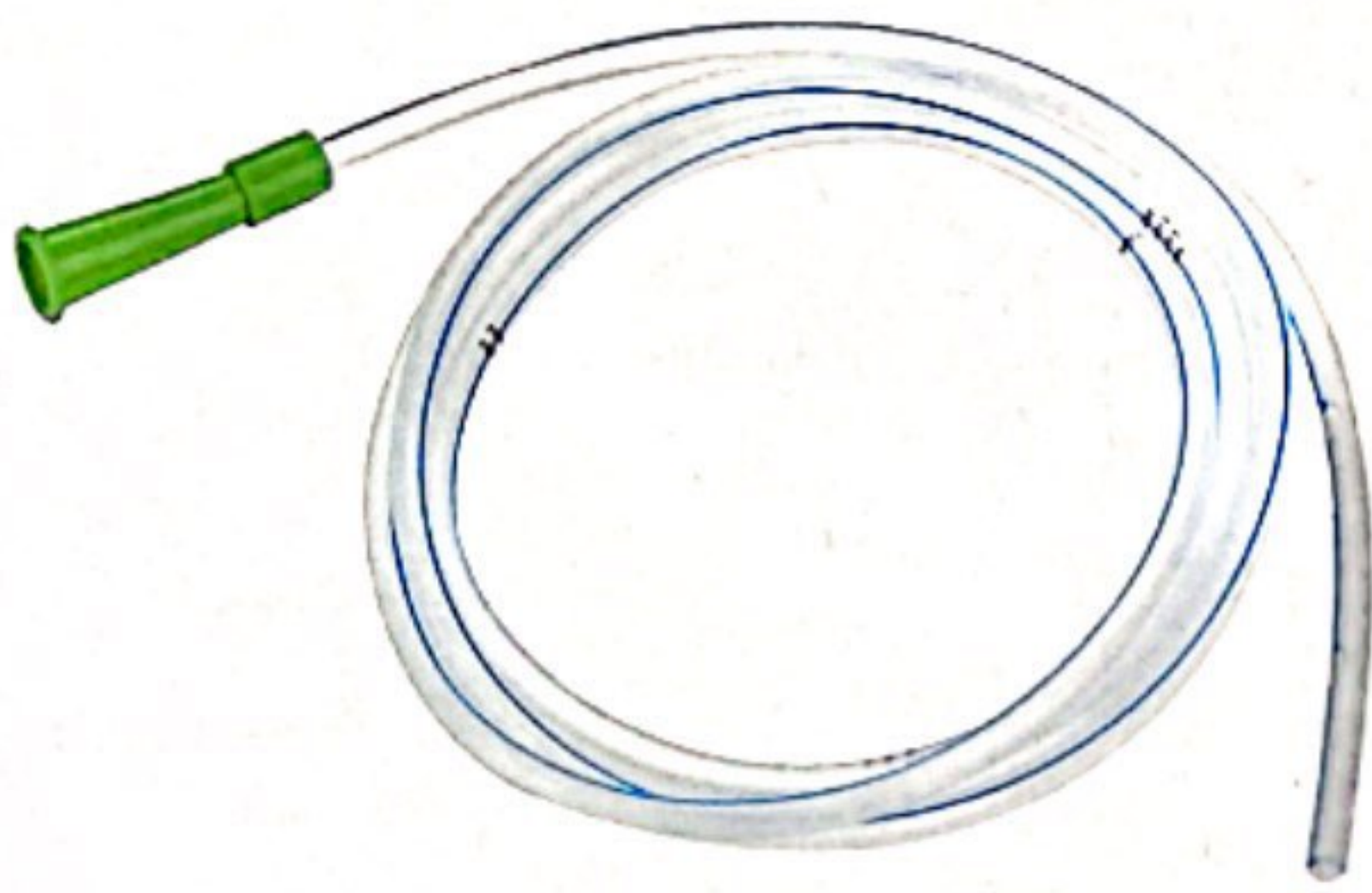

**GT019-100 PVC Stomach Tube**

Made from non-toxic, non-irritant soft PVC.  
 DEHP-FREE is available.  
 Printed with graduation.  
 Color coded for size identification  
 With X-ray or without is available  
 Size: Standard Tube Length : 120cm  
 Sterilization:EO  
 Size: Fr6-Fr26  
 packing:Blister Bag / PE Bag

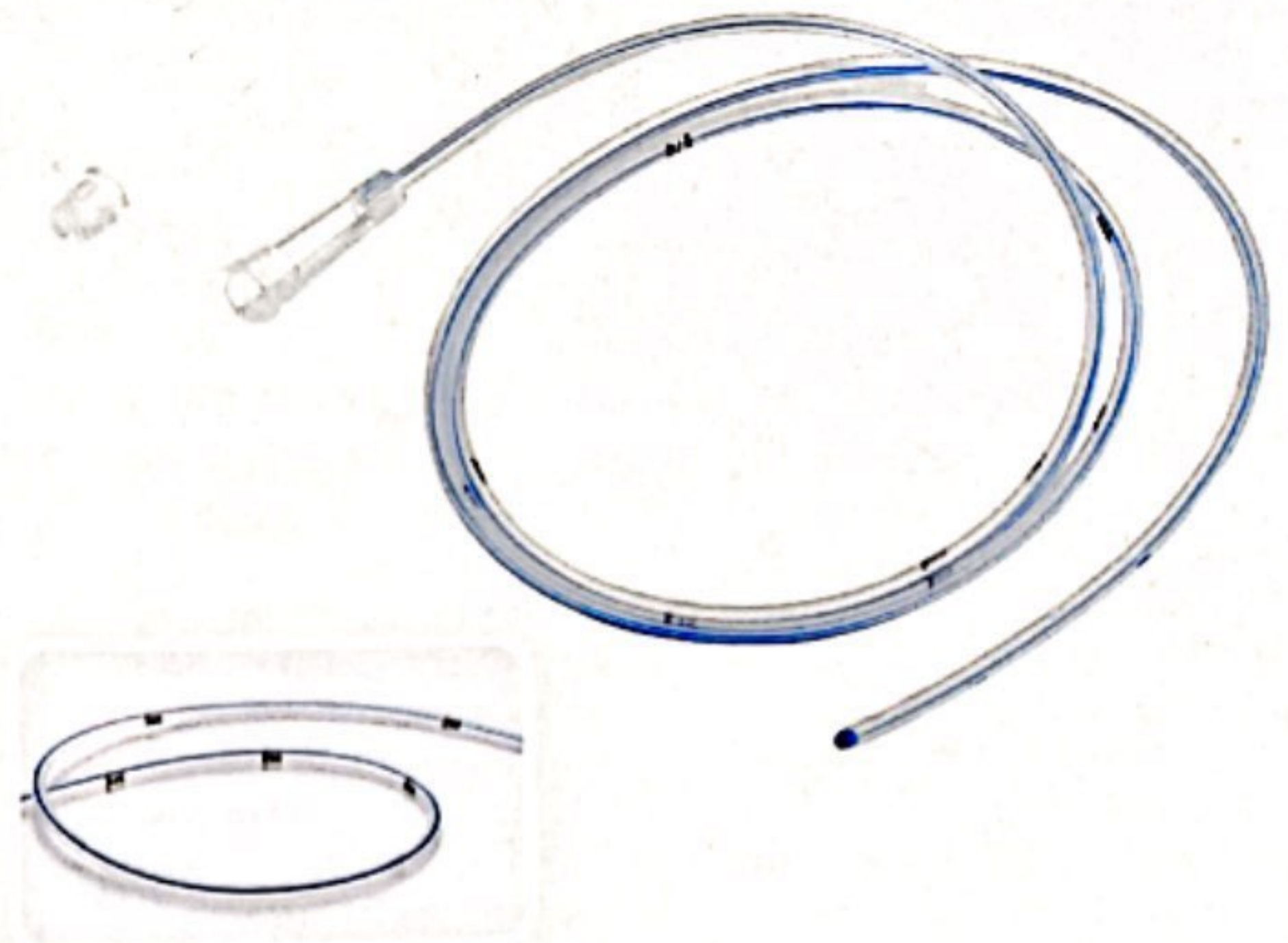

**GT019-100B 100% Silicone Stomach Tube**

Made of non-toxic,non-irritant 100% silicone  
 Color:Transparent or translucent(Surface fog form)  
 Provision of four eye-holes for efficient aspiration  
 With X-ray line  
 Tube length:120cm  
 Sterilization:EO  
 Size: FR8-FR20  
 Packing:Blister Bag

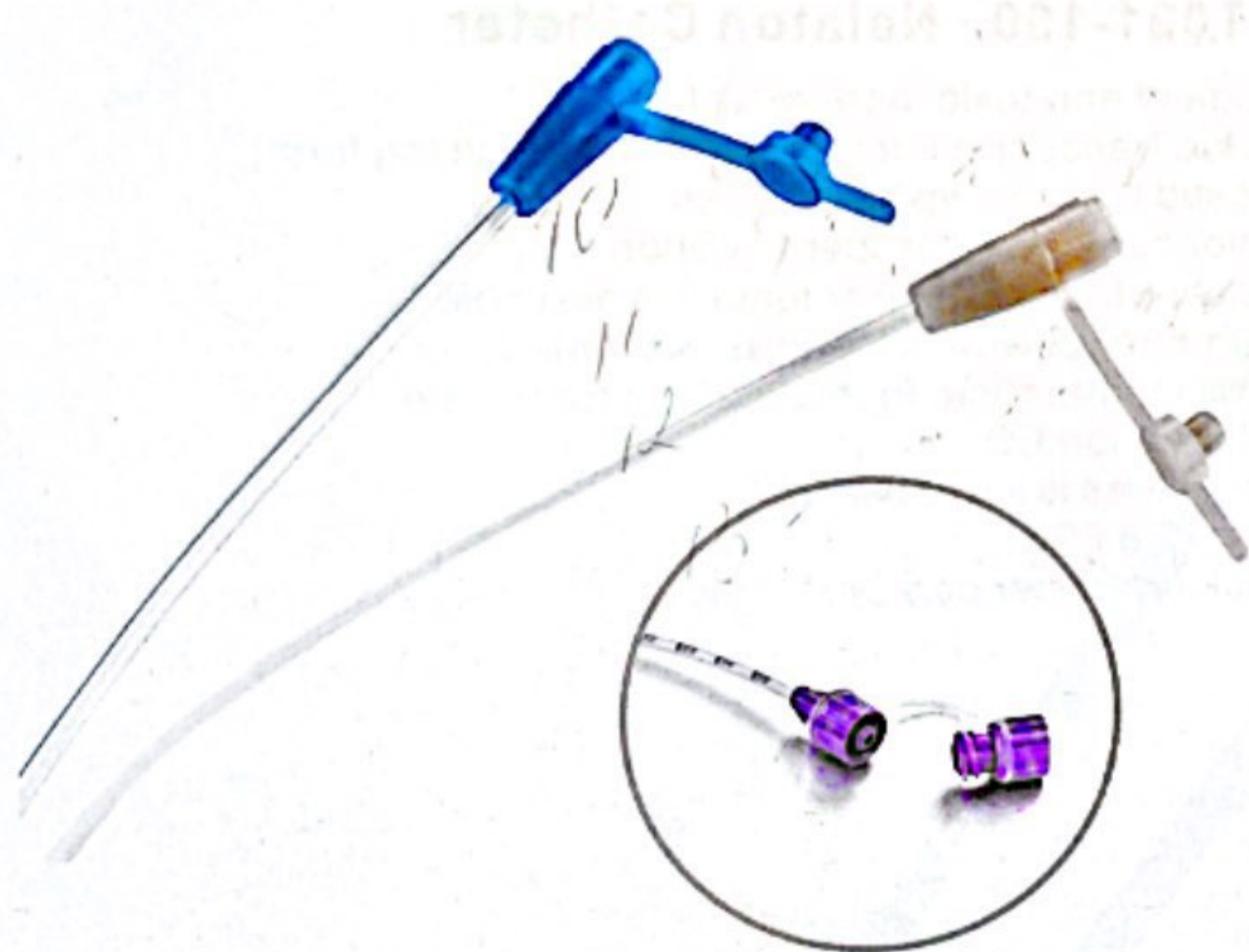

**Luer Lock Connector**

**GT018-100 Feeding Tube**

Made from non-toxic, non-irritant soft PVC.  
 DEHP-FREE is available.  
 Color coded for size identification  
 With X-ray or without is available  
 Size: Fr4-Fr8 Tube Length: 40cm  
 Size: Fr10-Fr22 Tube Length: 120cm  
 packing:Blister Bag / PE Bag

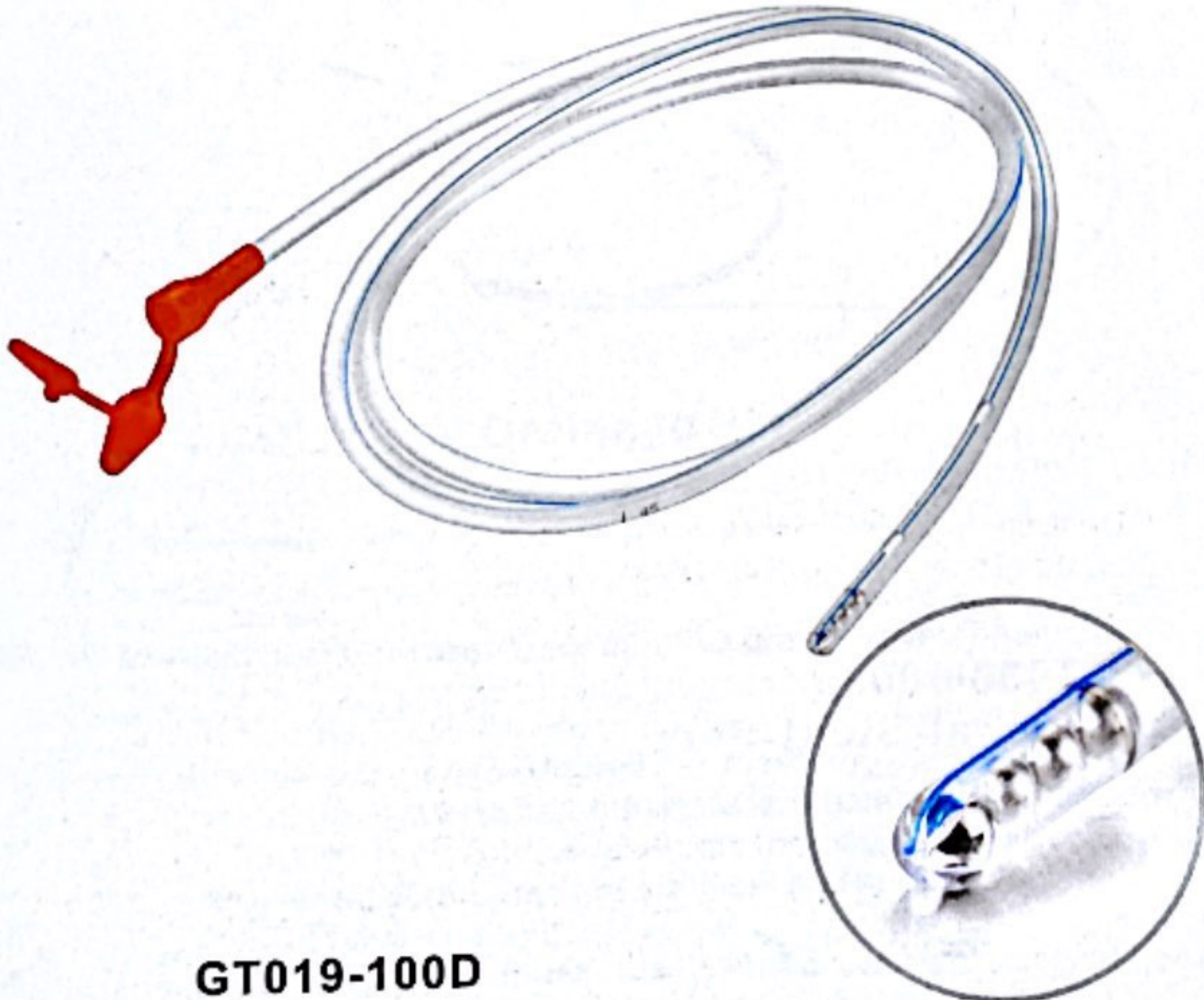

**GT019-100D Ryle's Tube**

Made of non-toxic, non-irritant PVC(Medical grade), or DEHP free or 100% silicone.  
 Color: Transparent or translucent(surface fog form).  
 With X-ray detectable thread.  
 With metal ball.  
 Connector(color coded)-Size(Fr/Ch):  
 F6, F8, F10, F12, F14, F16, F18, F20,F22.  
 Package: Single in PE or blister package.  
 Sterilized by EO GAS.

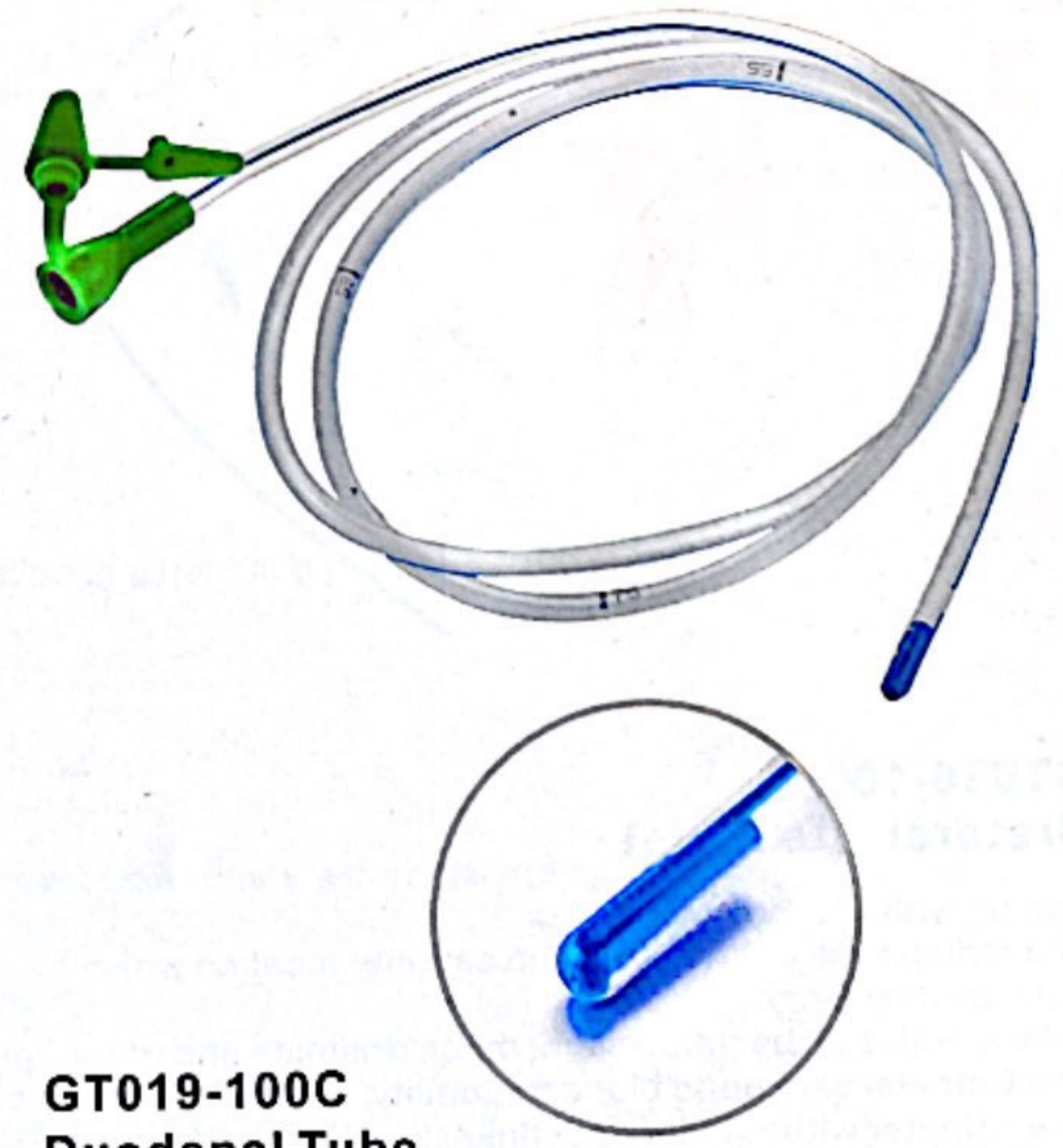

**GT019-100C Duodenal Tube**

Made of non-toxic, non-irritant PVC(Medical grade), or DEHP free or 100% silicone.  
 Color: Transparent or translucent(surface fog form).  
 With X-ray detectable thread.  
 Closed distal end with four lateral eyes.  
 Connector(color coded)-Size(Fr/Ch):  
 F6, F8, F10, F12, F14, F16, F18, F20, F22.  
 Package: Single in PE or blister package.  
 Sterilized by EO GAS.



**Exchange**  
 Function:moistening,warming and filtering the gas that come out from the breathing machine.  
 Made by medical plastic PP.  
 High effective filtering rate : 99.99%  
 Size:Adult, Child  
 Packing:Individual Blister Bag

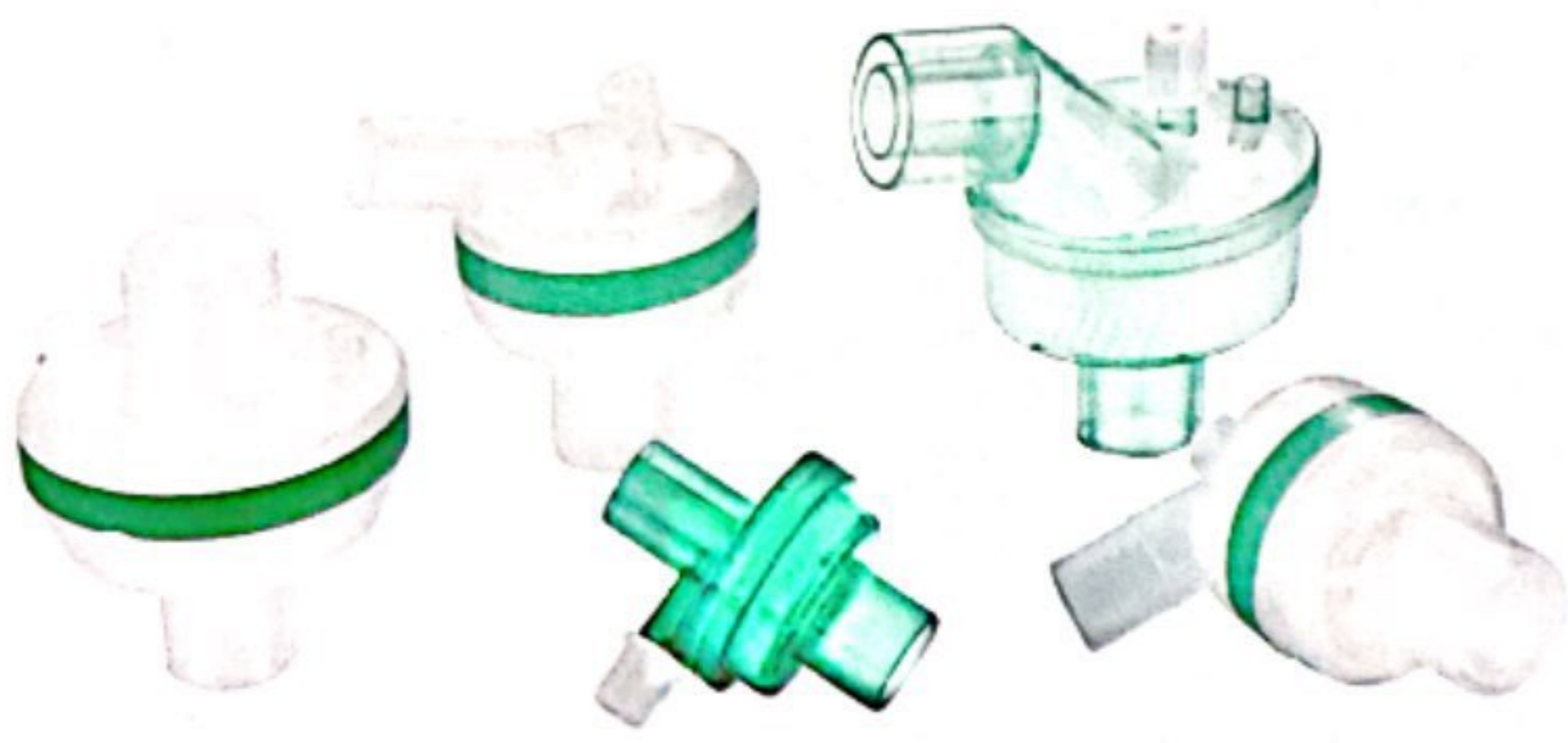
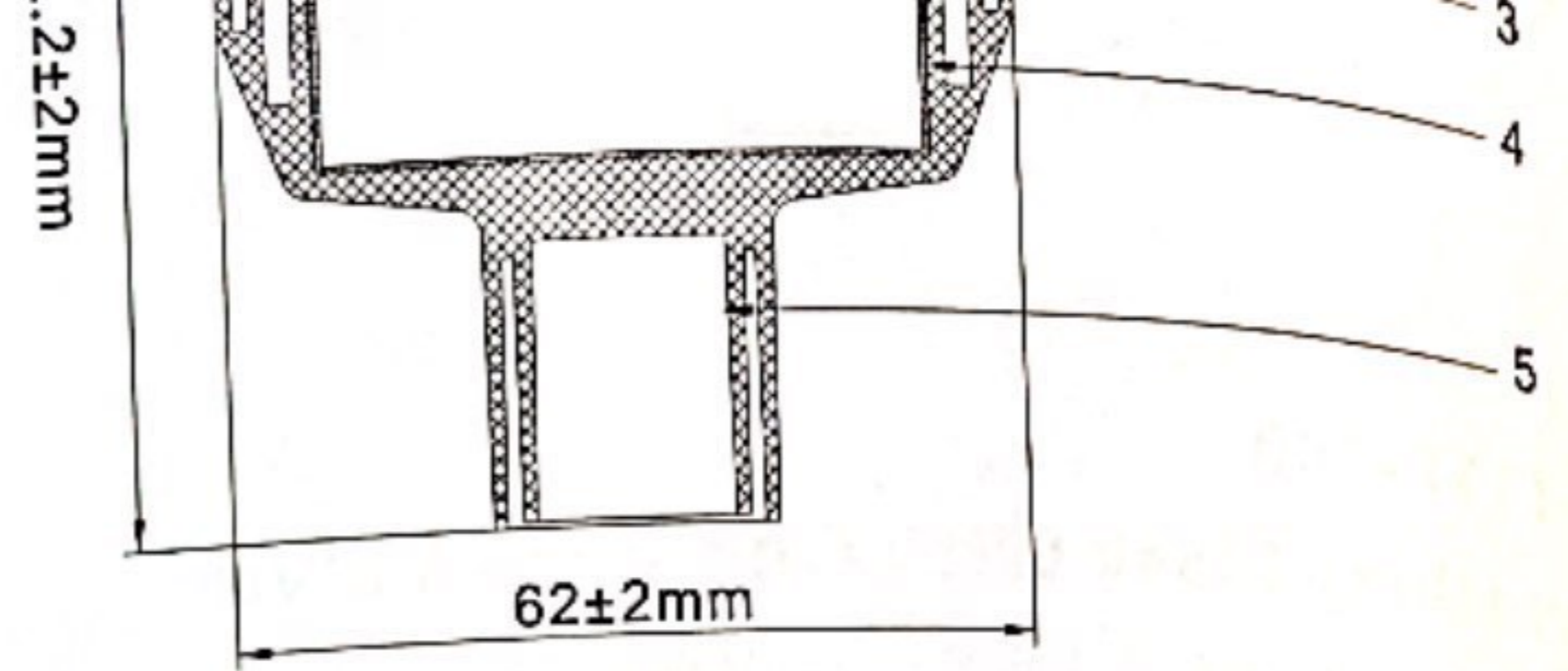

NO.	Components	Material	Quantity
1	Upper Cover	PVC	1
2	Screw Cap	PP	1
3	Filteringmembrane	polyurethane	1
4	Humidifying paper	/	1
5	Lower Cover	PP	1

**GT032-400A Disposable Tracheostomy Heat Moisture Exchanger**

Tidal Volume:200-1500ml;Moisture Output(mg H<sub>2</sub>O / L air):24/25mg@Vt 500ml;Resistance(cm H<sub>2</sub>O) :<2.3@60L/min  
 size:Adult  
 Packing:Individual Blister Bag

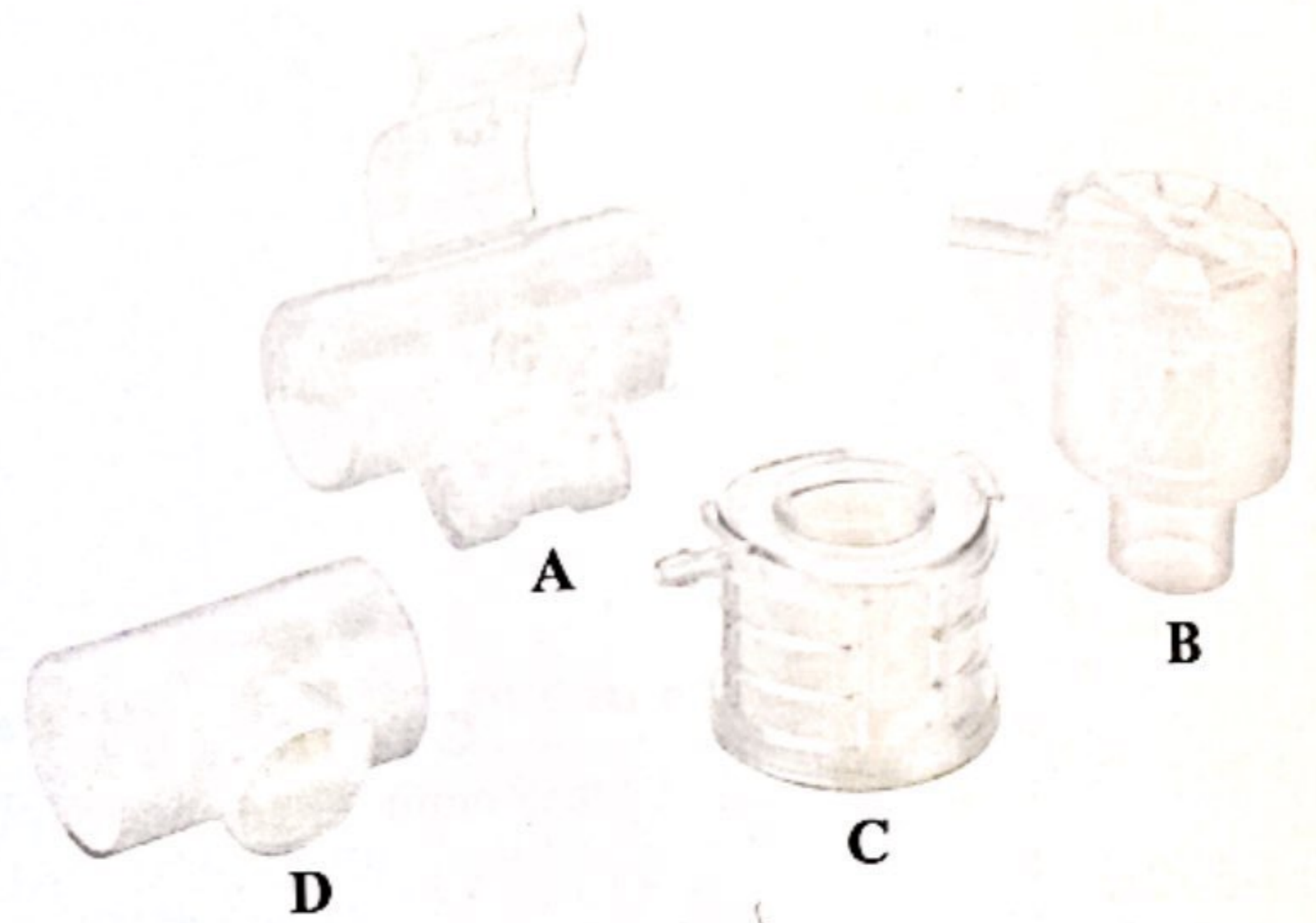

Model	GT032-400A	GT032-400B	GT032-400C	GT032-400D
Recommended tidal volum(ml)	>75	>75	>75	>75
Moisture loss* (mg H <sub>2</sub> O/lair)	9.0(@Vt 500ml)	9.2(@Vt 500ml)	9.0(@Vt 500ml)	9.0(@Vt 500ml)
Resistance(pa)	15 at 30l/min	50 at 30l/min	20 at 30l/min	20 at 30l/min

**GT032-200 Disposable Bacterial/Viral Filter**

Function:Mainly used for filtering the bacterial,viral and wetting the gases in breathing machine and anesthesia circuits, also can be used with Lung function examination equipment to protect the instruments by filtering the bacterial.  
 Made of medical high polymer material.  
 Filter medium is primarily a superfine polypropylene fiber with static electricity,and polypropylene is Hydrophobic materials that restrains the growing of fungus,bacterial and viral.  
 Packing:Individual Blister Bag

NO.	Components	Material	Quantity
1	Upper Cover	PVC	1
2	Screw Cap	PP	1
3	Filteringmembrane	polyurethane	1
4	Lower Cover	PP	1

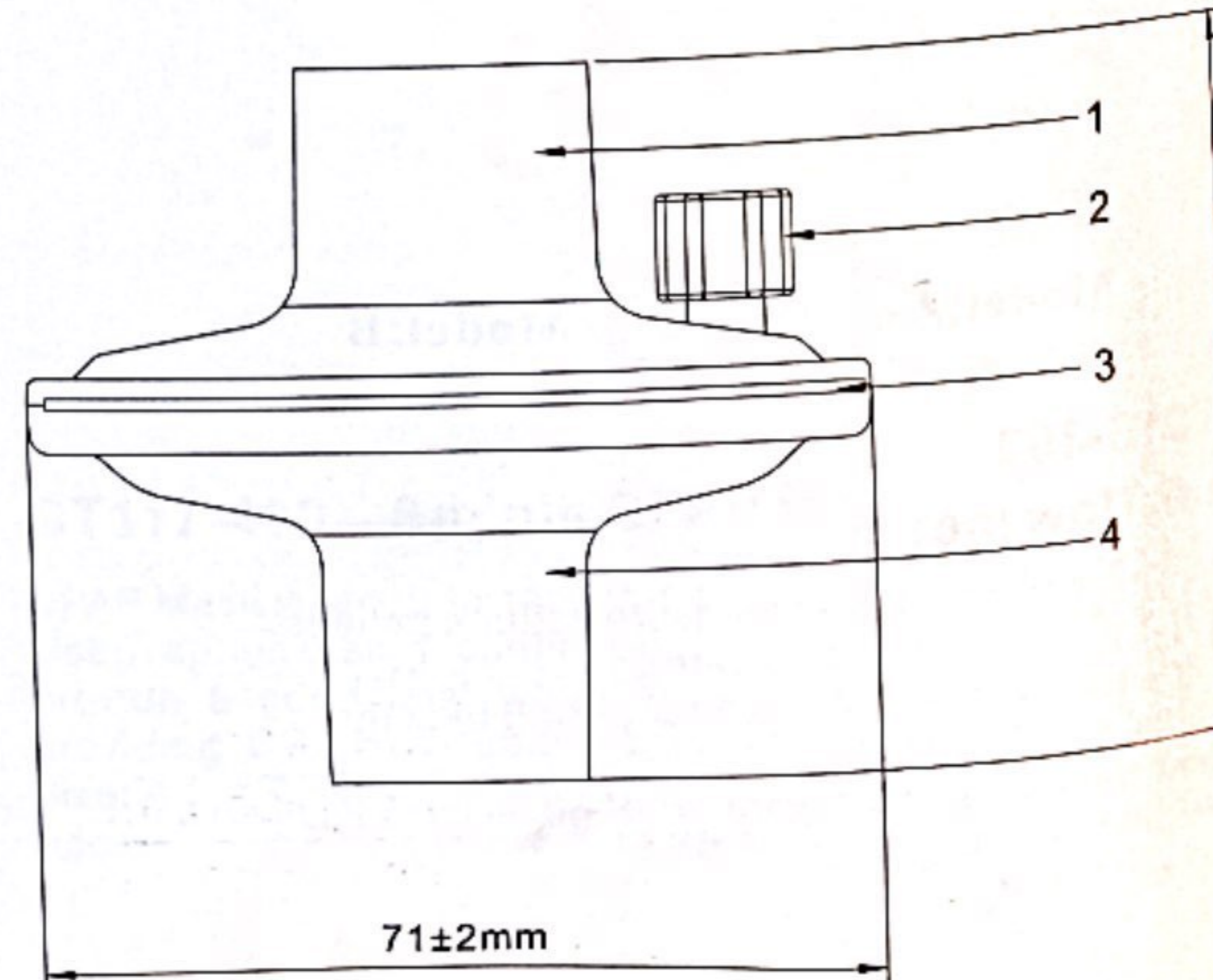
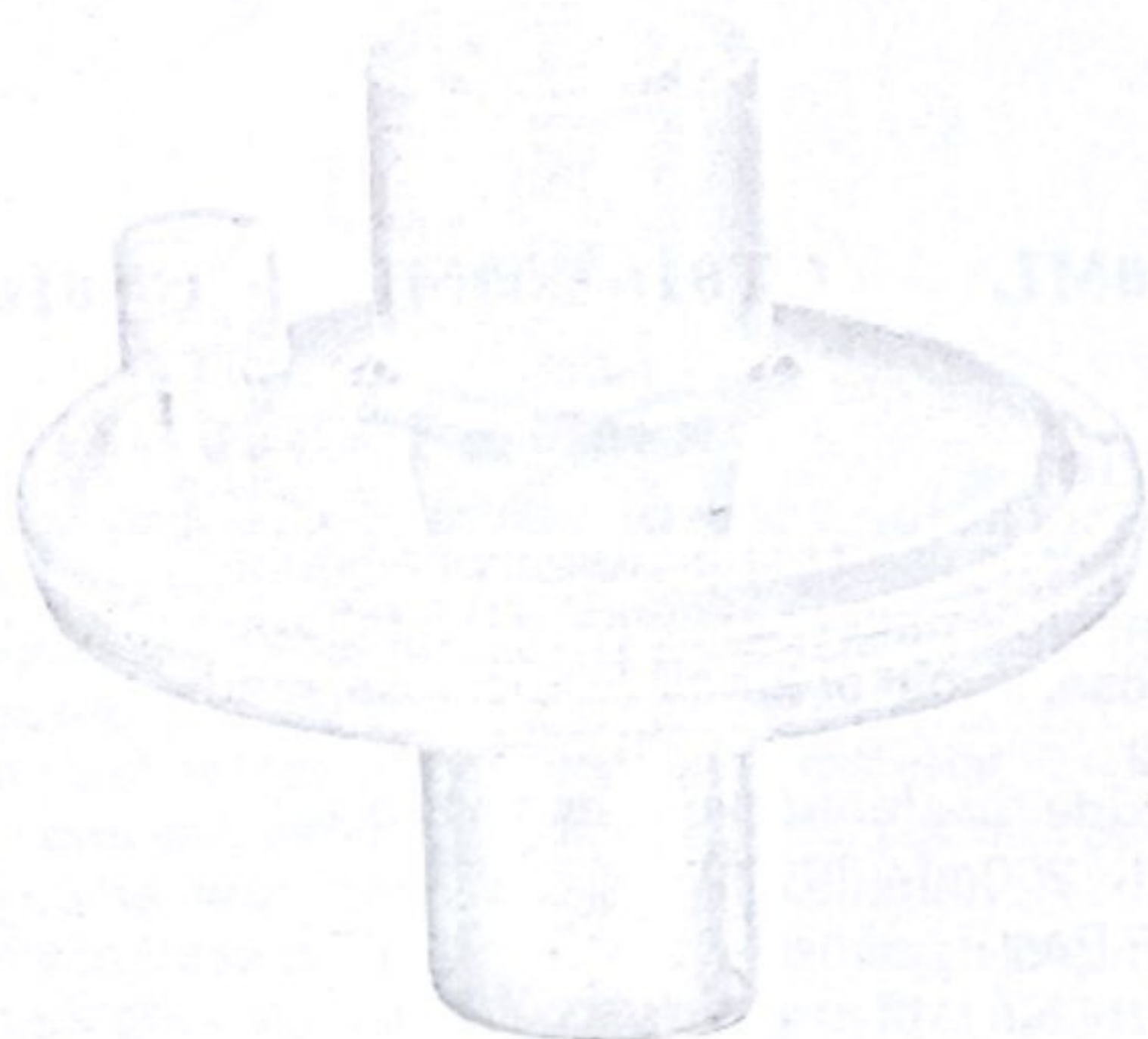



I.V Cannula with Injection port and without wing

Option Available :

- PTFE / FEP / PU Flex Catheter
- Hydrophobic filter
- Clear or Radio Opaque Catheter

Advantage of using PU Flex Catheter :

- Kink free
- The Catheter softens once inserted in the body
- The properties of this Catheter are similar to PU (Polyurethane)

**FEATURES:**

- Japanese Needle with 3-facet Needle point to reduce penetration force
- Kink resistant and specially tapered Catheter for easy vein puncture with minimum trauma
- Transparent flash back chamber for easy visualization of blood to confirm venipuncture
- With Luer Lock plug
- Colour coding for each gauge as per International standards



GT038-700A

Size	Colour	Catheter (mm)		Catheter Length (mm)	Water Flow Rate (ml / min)
		I.D	O.D		
14 G	Orange	1.7	2.1	45	270
16 G	Grey	1.3	1.7	45	180
17 G	White	1.1	1.5	45	125
18 G	Green	0.9	1.3	32 / 45	80
20 G	Pink	0.8	1.1	32	54
22 G	Blue	0.6	0.9	25	33
24 G	Yellow	0.5	0.7	19	20

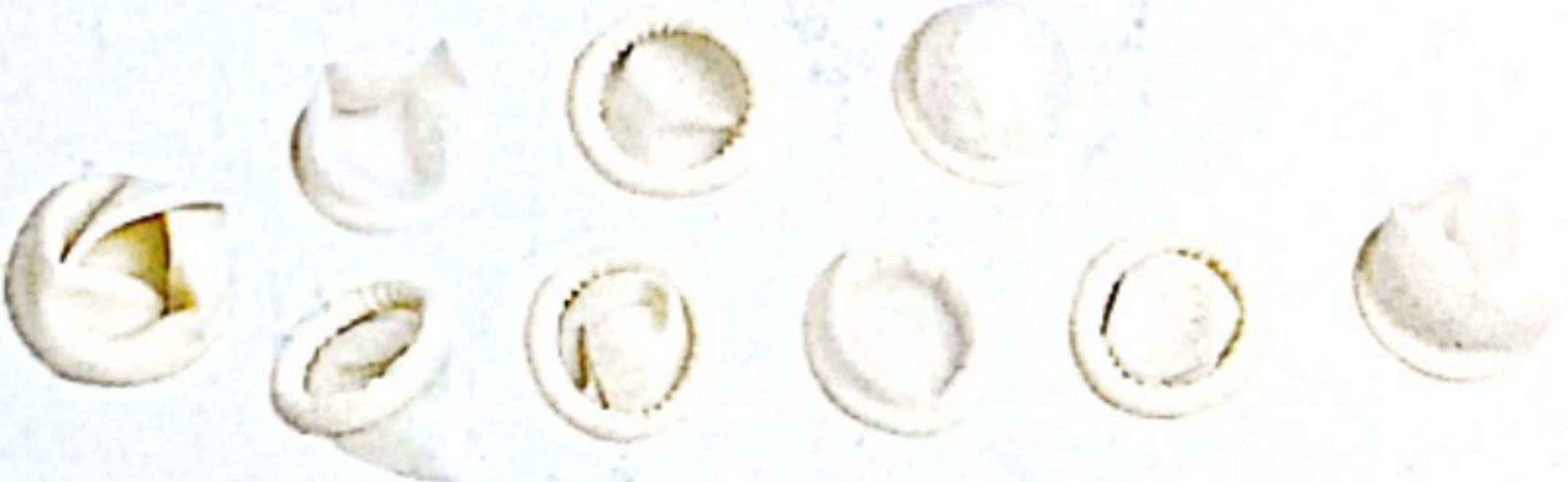

**GT053-100 Latex Powder-free Finger Cots And Powdered**

Latex Powder-free Anti-static Finger Cots.  
 Designed With A Proprietary Anti-static Agent That Yields Average Surface Resistance Of 108-11Ω Ohms Per Square Surface Unit.  
 It Virtually Eliminate Electro Static Discharge.  
 These Finger Cots Are Clean Processed And To Protect Particulates, Chemicals And Solvents With Skin.  
 Type: Smooth Surface With Rolled, Unrolled Or Cut Is Available.  
 Specification Size ±3mm

	L	M	S
Length(mm)	65	65	65
Width(mm)	29	27	25
Thickness(mm)	0.13	0.13	0.13

Packing: 100Pcs/bag, 30000Pcs/ ctn, 45 X 45 X 30cm



**GT054-200 Tourniquet**

Length: 45cmx Width:2.5cm, Stretch Length: 80-90cm  
 With ABS Button,  
 Material Of Belt, Terylene+elastic Latex  
 Color: Blue, Red, Green, Black,white,yellow, Purple,pink etc.  
 Packing: 1pc/PP bag, 50Pcs / box, 600Pcs / ctn, 57 X 38 X 37cm



**GT055-100 Latex Tube**  
 I. D. : 3mm-10mm  
 O. D. : 5mm-15mm



**GT054-100 Stanch Colligation Band**

- 1. Stanch Colligation Band ( natural Latex )**
  - Size :width 3/4 Inch Length : 18 Inch X Thickness:0.45cm
  - Size :width 3/4 Inch Length : 29 Inch X Thickness:0.45cm
  - Size :width 1 Inch Length : 18 Inch X Thickness:0.45cm
- 2. Stanch Colligation Band , Latex-free(isoprene)**
  - Size :width 3/4 Inch Length : 18 Inch X Thickness:0.55cm
  - Size :width 3/4 Inch Length : 29 Inch X Thickness:0.55cm
  - Size :width 1 Inch Length : 18 Inch X Thickness:0.55cm





### GT010-110 Simple Oxygen Mask

Made of clear, medical grade PVC  
 With adjustable nose clip  
 With Anti-crush tube  
 With elastic strap  
 With 2.1m oxygen tube  
 Latex free is available  
 DEHP Free is available  
 Size:XS,S,ML,XL  
 Packing:PE bag

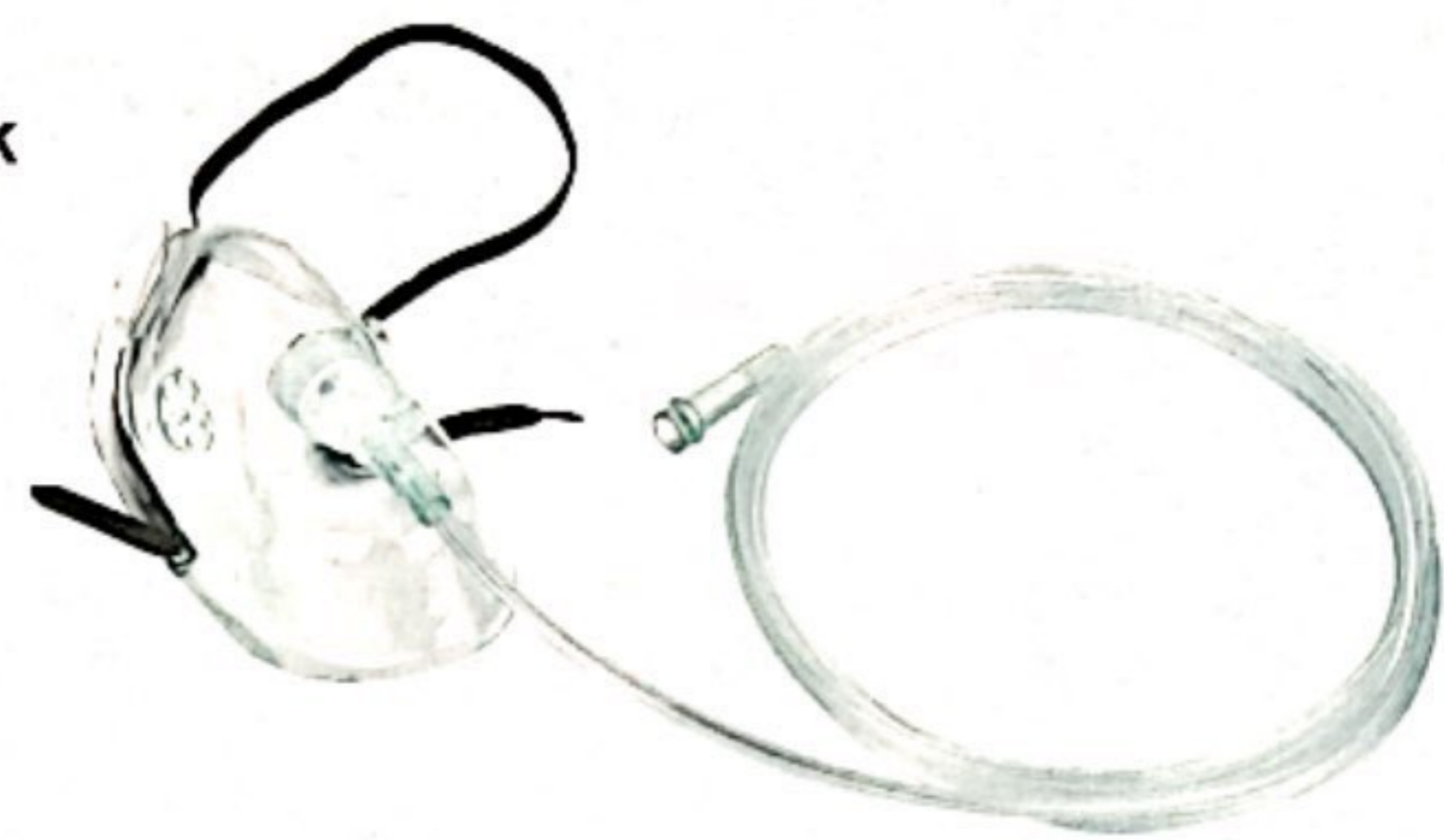

### GT010-150 Venturi mask

Made of clear, medical grade PVC  
 With adjustable nose clip  
 With Anti-crush tube  
 With elastic strap  
 With 2.1m oxygen tube  
 7 density can be adjusted by two diluters  
 Green:24%,26%,28%,30%;white:35%,40%,50%  
 Latex free is available  
 DEHP Free is available  
 Size:S,M,L,XL  
 Packing:PE bag

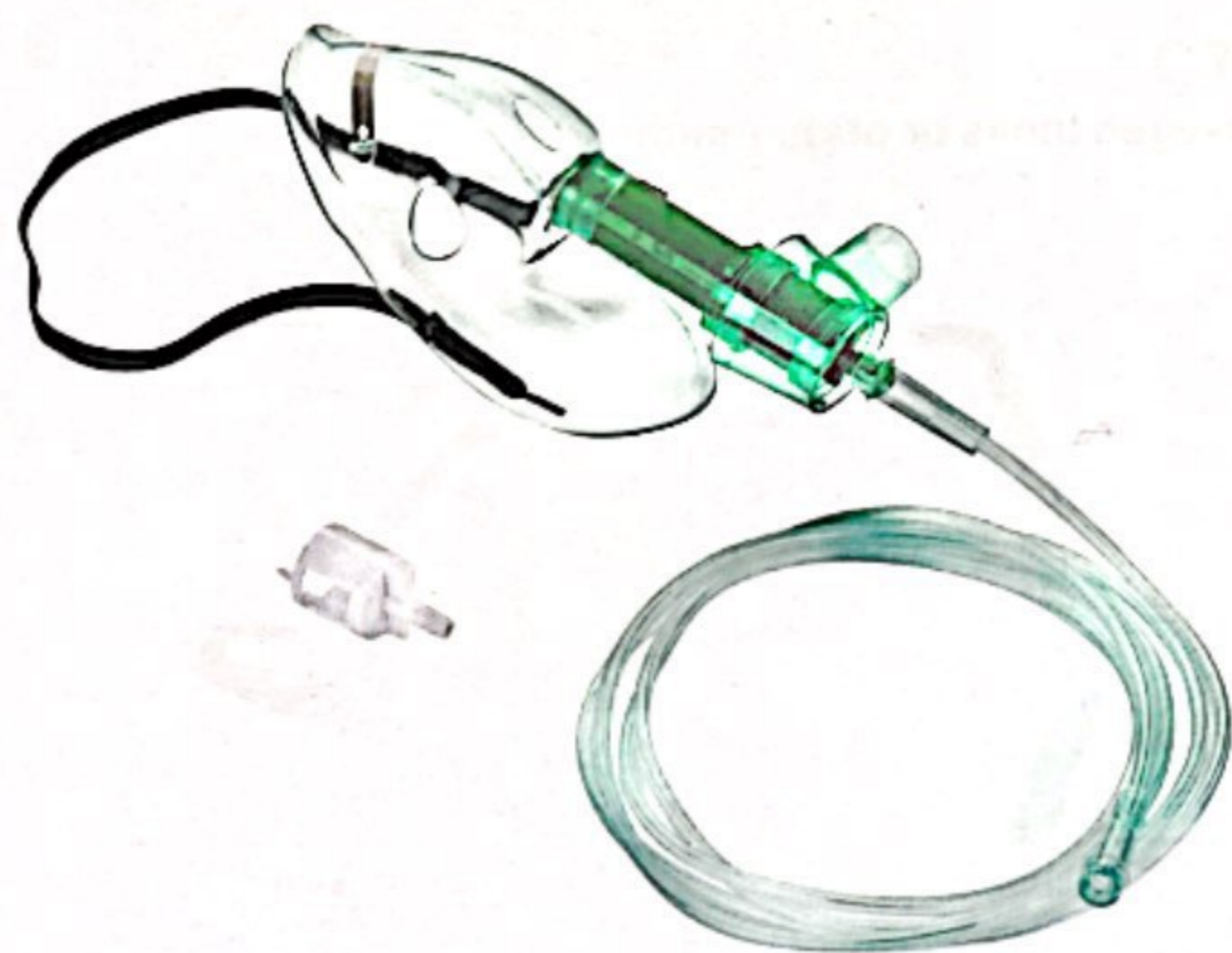

### GT010-170 Adjustable Venturi Mask

Made of clear, medical grade PVC  
 Adjustable nose clip  
 6 diluters choice, each diluter for one oxygen density  
 Oxygen concentration is blue 24%,  
 Adaptor for high humidity  
 Anti-crush tube  
 With 2.1m oxygen tube  
 Latex free is available  
 DEHP Free is available  
 Size :S,M,L,XL  
 Packing:PE Bag

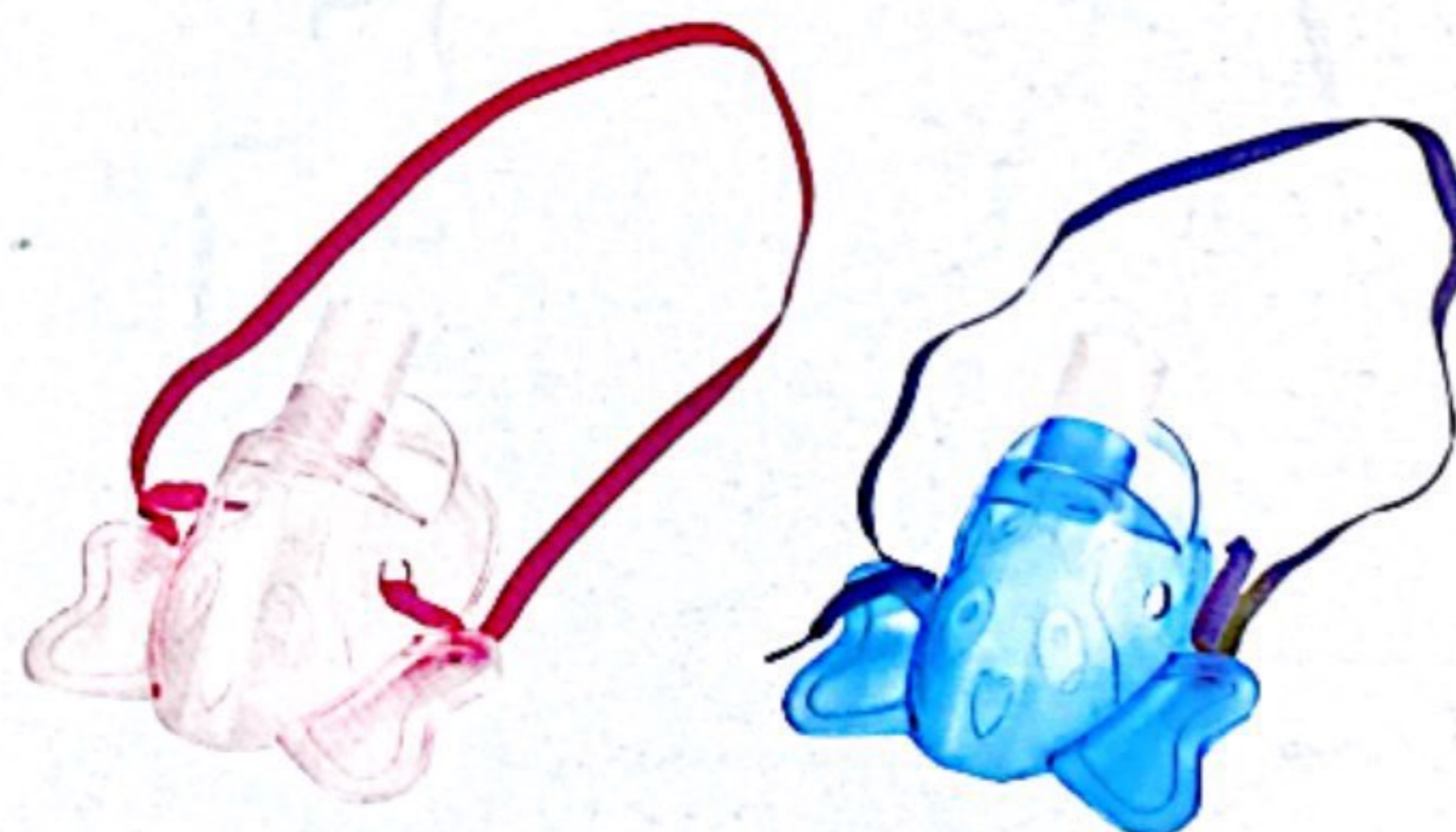
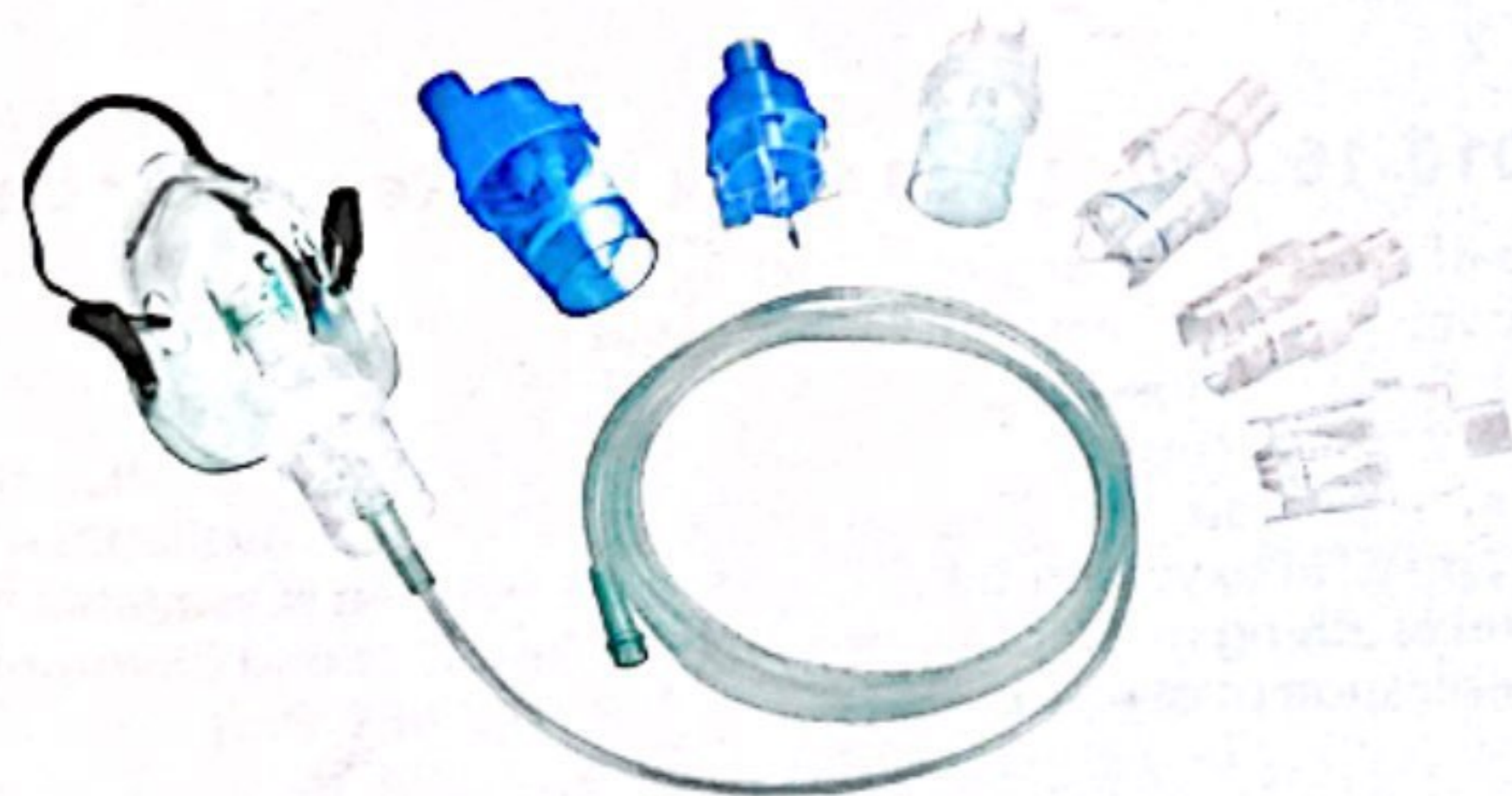

### GT012-100 Nebulizer Mask

Made of clear, medical grade PVC  
 With adjustable nose clip  
 With 2.1m oxygen tube  
 Standard connector  
 Nebulizer jar volume:6cc,15cc  
 Latex free is available  
 DEHP Free is available  
 Size:XS/S/M/L/XL  
 Packing:PE Bag

### GT012-101 Elephant Nebulizer Mask

Made of clear, medical grade PVC



packing:Hard blister bag

### GT014-100B Belt for ET Tube

Material:plush+sponge+velcro

Size:Adult, Child.

Color:Blue

1pc/bag

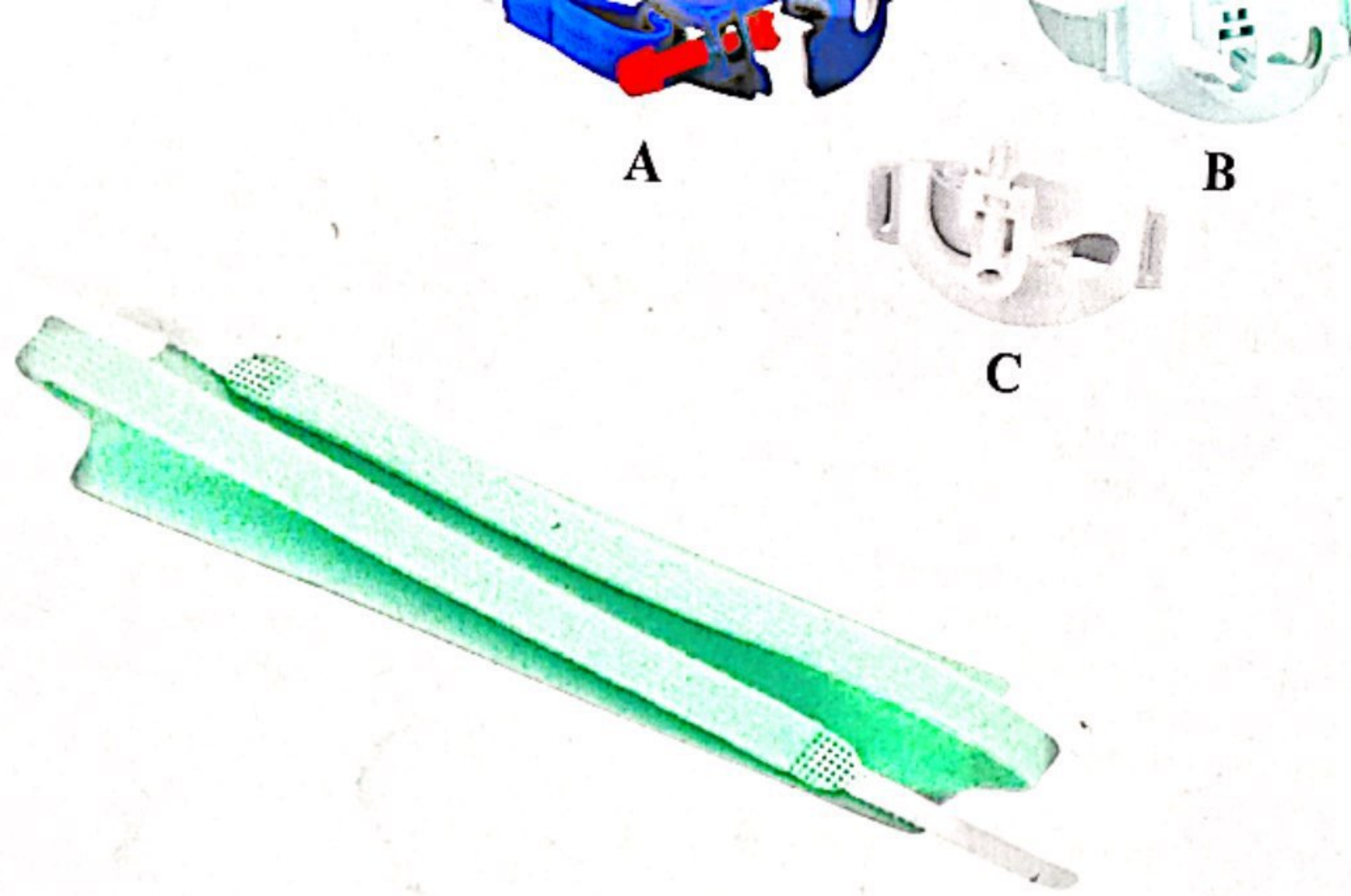

### GT016-200 Nasopharyngeal Airway

Made from soft PVC

Nasopharyngeal airway is designed for easy insertion and maximum patient comfort.

It facilitates suctioning in intensive care ,general anaesthesia and also provide an alternative airway during emergency procedures.

Sterilization:EO

Size:I.D3.0MM-I.D9.0MM

Packing:Blister Bag

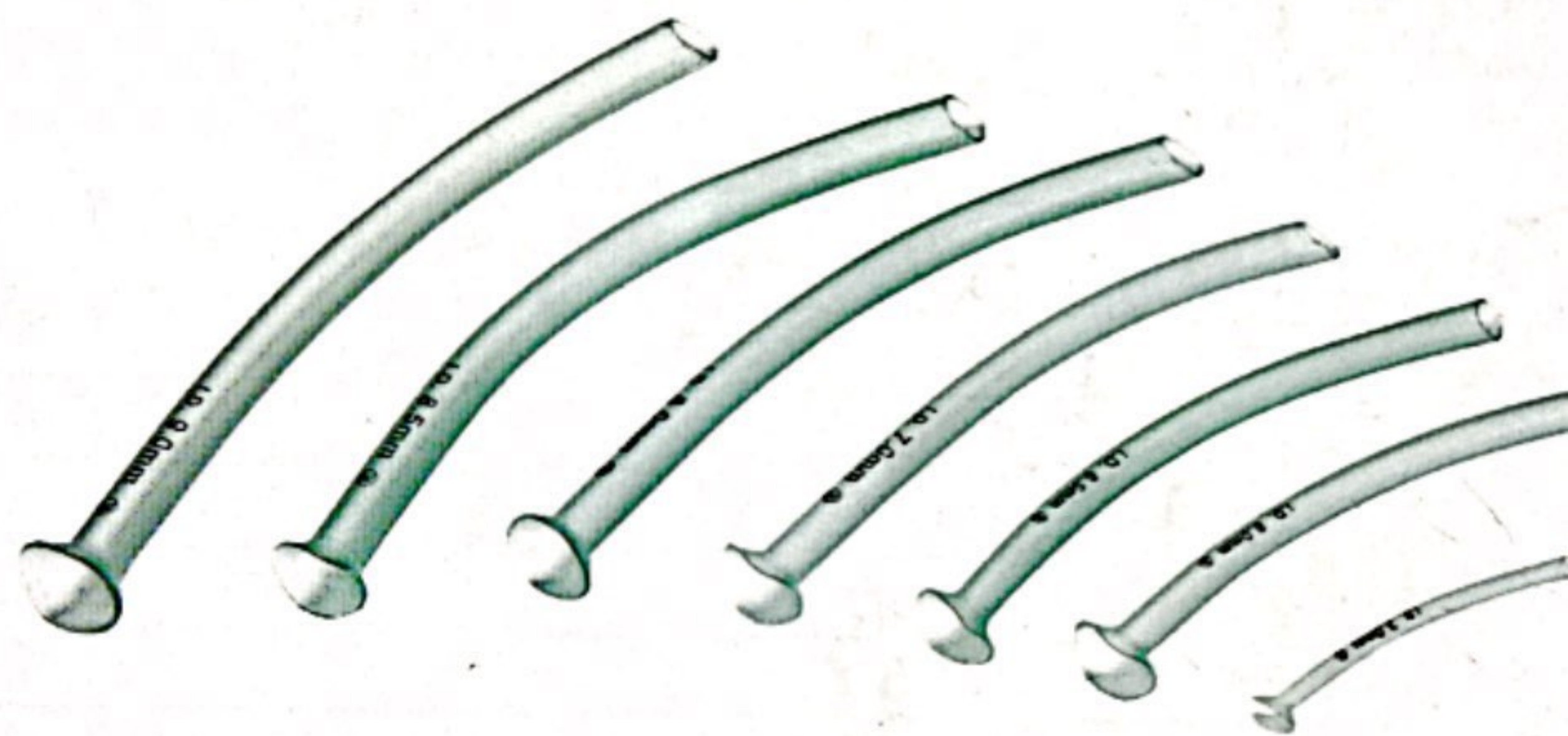

### GT016-100 Guedel Airways(Guedel type)

Made from semrigid non-toxic polyethylene

Color-coded bite block is designed for easy identification and to prevent biting down

Guedel style enclosed center channel

Sterilization:EO

size:000#,40mm,pink

00#,50mm,blue

0#,60mm,black

1#,70mm,white

2#,80mm,green

3#,90mm,yellow

4#,100mm,red

5#,110mm light blue

6#,120mm,orange

packing:Blister bag Or PE Bag



### GT016-100B Guedel Airways(Berman Type)

Made from semrigid non-toxic polyethylene

Atraumatic one piece design for optimum patient comfort and safety

Rigid bite block to ensure airway patency

clear secretions and also provides space for oral care

Sterilization:EO

Size:40mm,50mm,60mm,70mm,80mm,90mm,100mm,110mm

Packing:Blister bag Or PE Bag





**Urine Container**

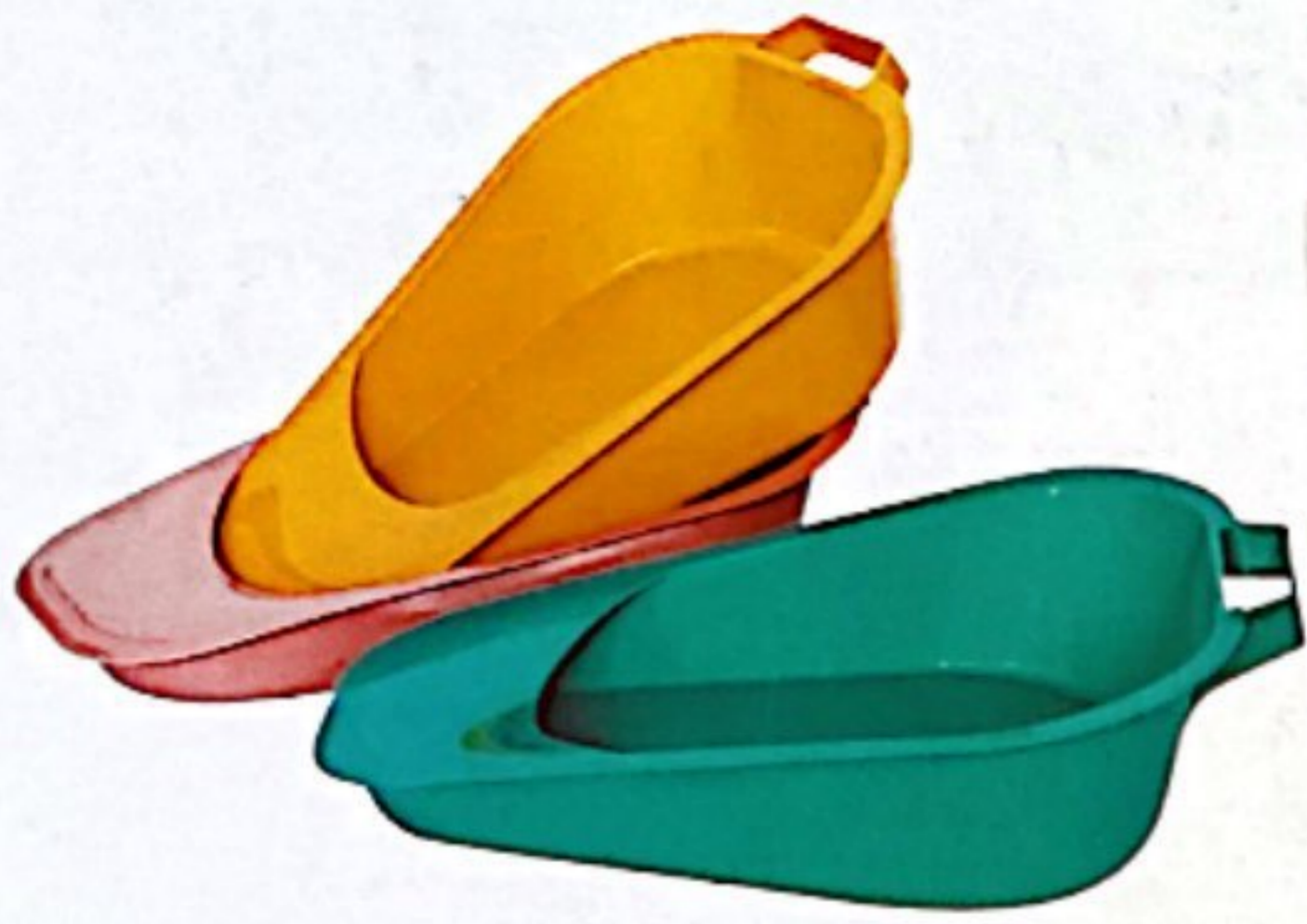

**GT138-106**  
PP material  
size:32 x 23.8 x 8.5cm  
110g

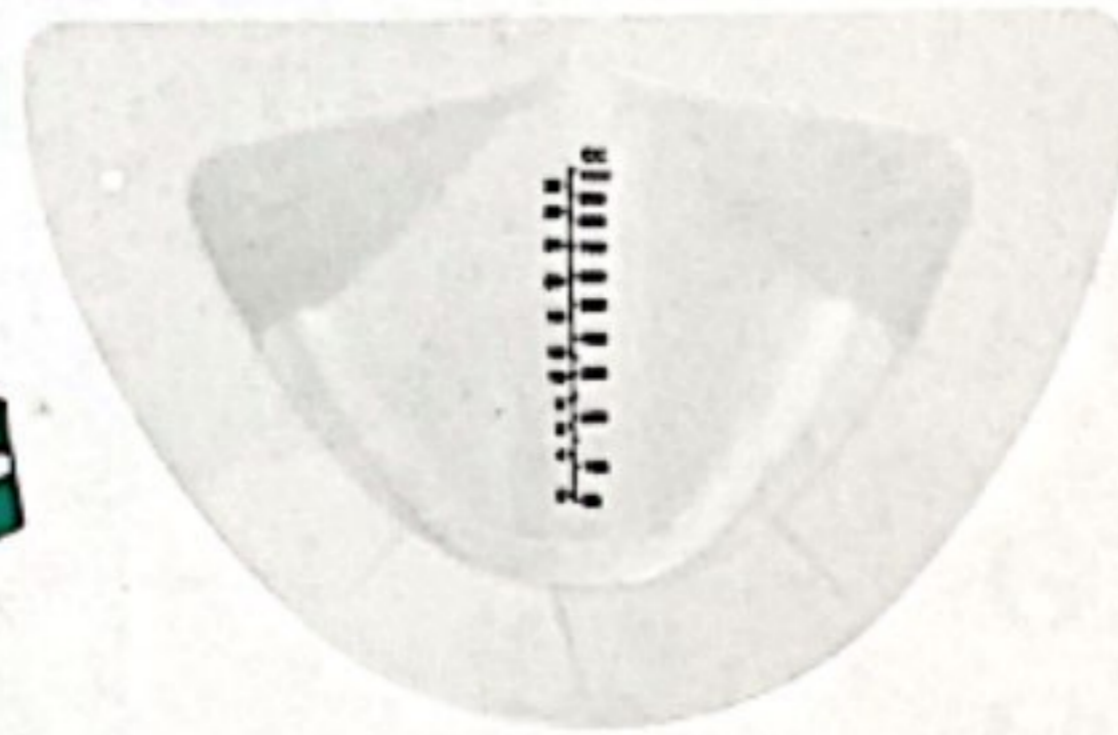

**GT138-107**  
PE material, 1000cc,  
size:32 x 21 x 10.5cm  
60g



**GT138-108**  
PP material,  
size:36.5 x 28 x 10.6cm  
180g



**GT138-109**  
PE material,  
size: 34 x 26.5 x 9cm  
300g



**GT138-110**  
PP material,  
size: 34oz, 230g



**GT138-111**  
PP material,  
size: Up-dia :12.2cm,  
Bottom-dia:9.3cm ,  
H:16.3,63g



**GT138-112**  
PE material,  
size: Up-dia:11.5cm,  
Bottom-dia:8, H :13.6cm,  
capacity:800ml,13g

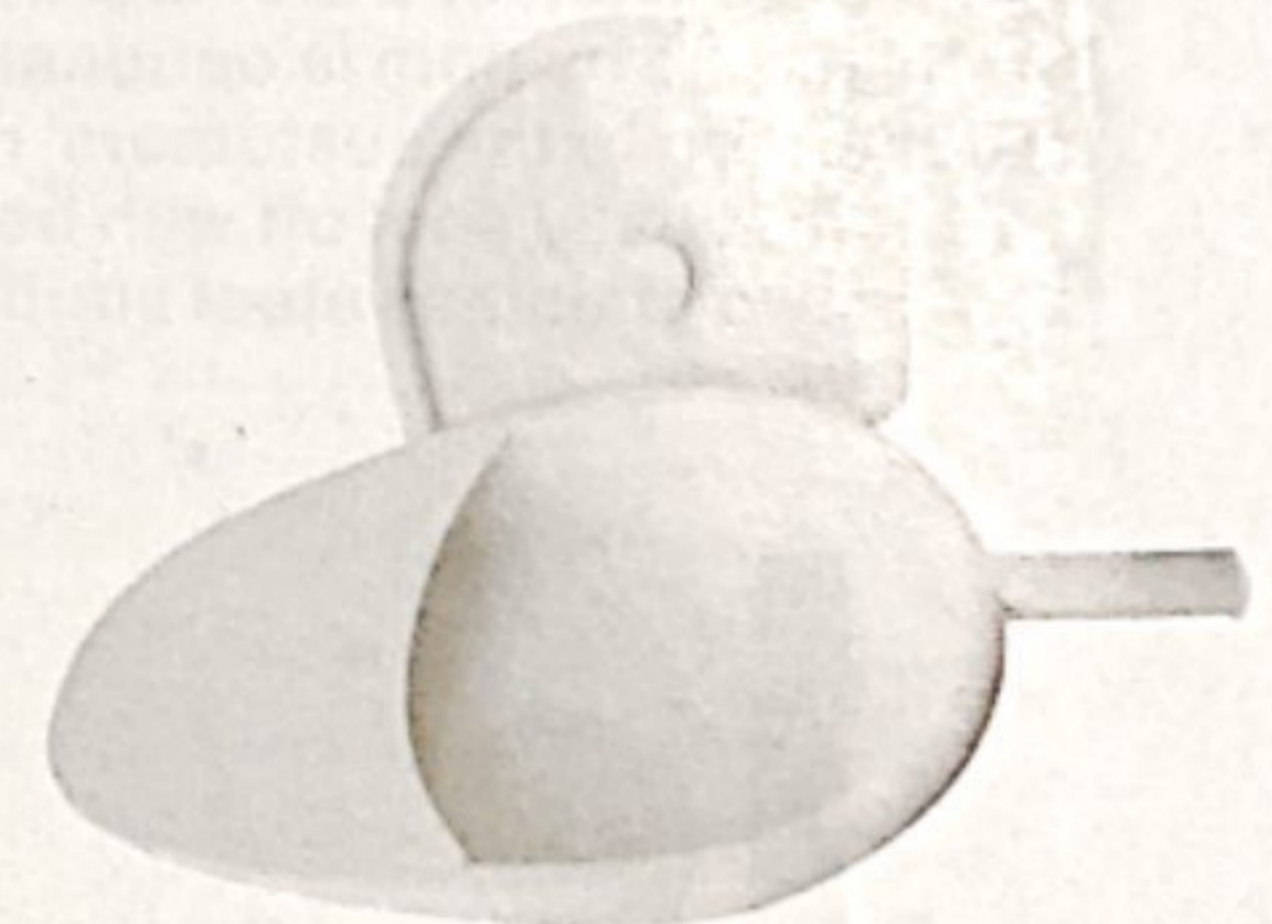

**GT138-113**  
PP material,  
size: 51 x 28 x 9cm  
500g



**GT138-114**  
News paper  
size: 25.5 x 11.5 x 11cm

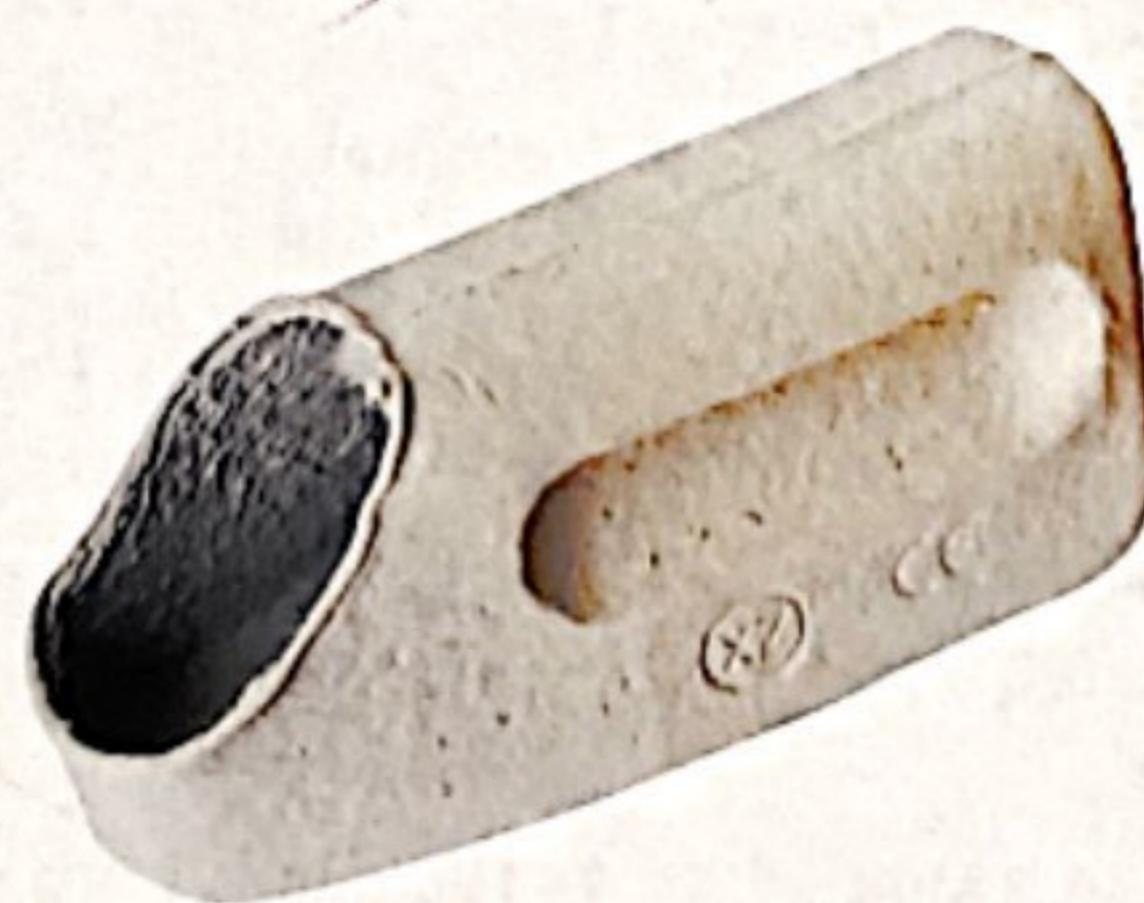

**GT138-115**  
News paper  
size: 25 x 11 x 10.8cm

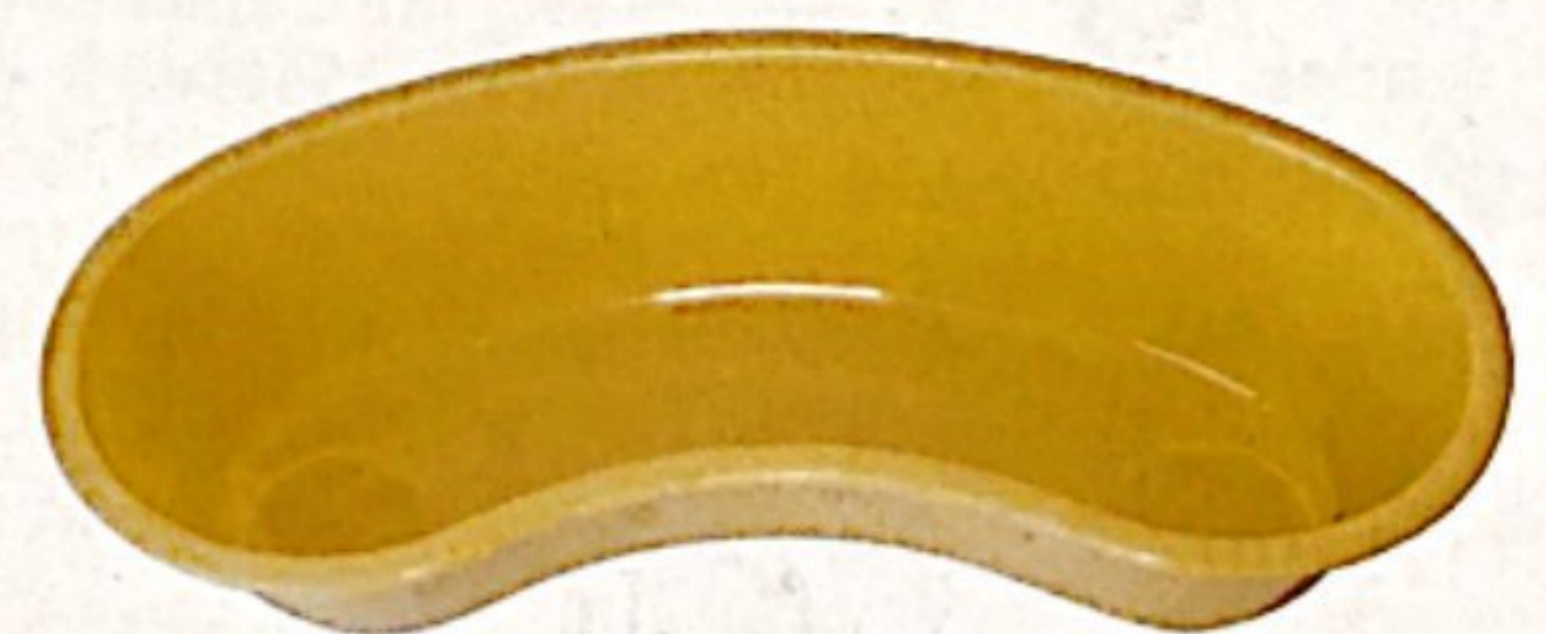

**GT138-116**  
PP material,  
size: 25 x 10 x 4.9cm  
25g





GT138-117



GT138-118



GT138-119



GT138-120



GT138-121



GT138-122

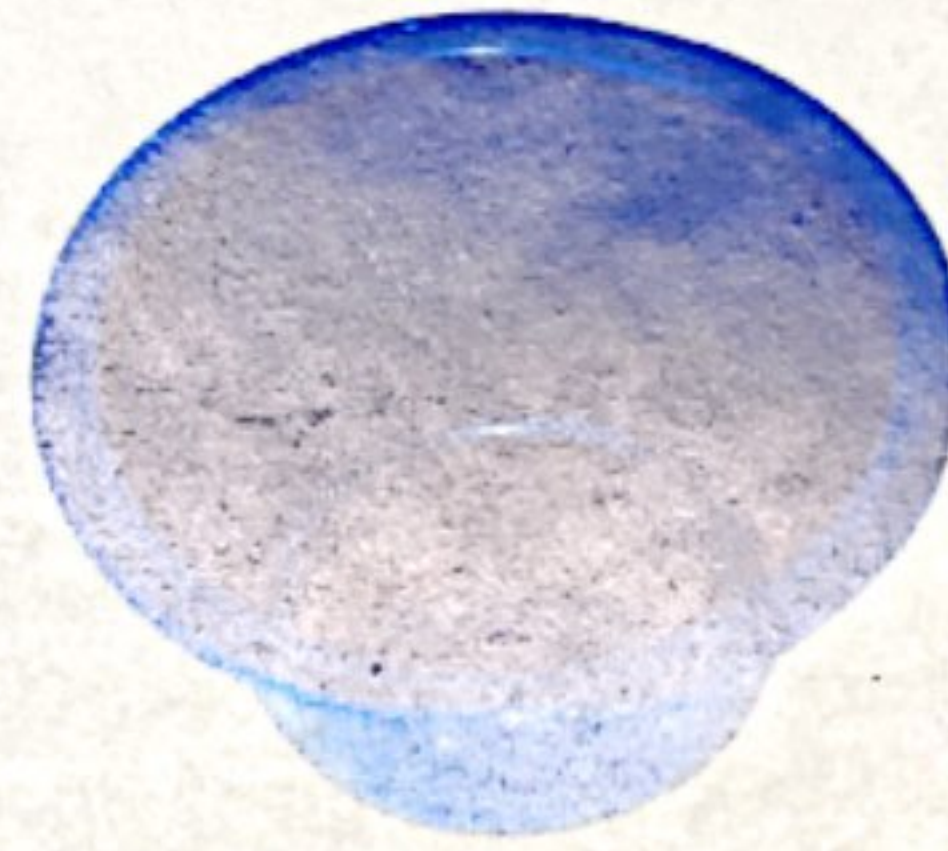

GT138-123

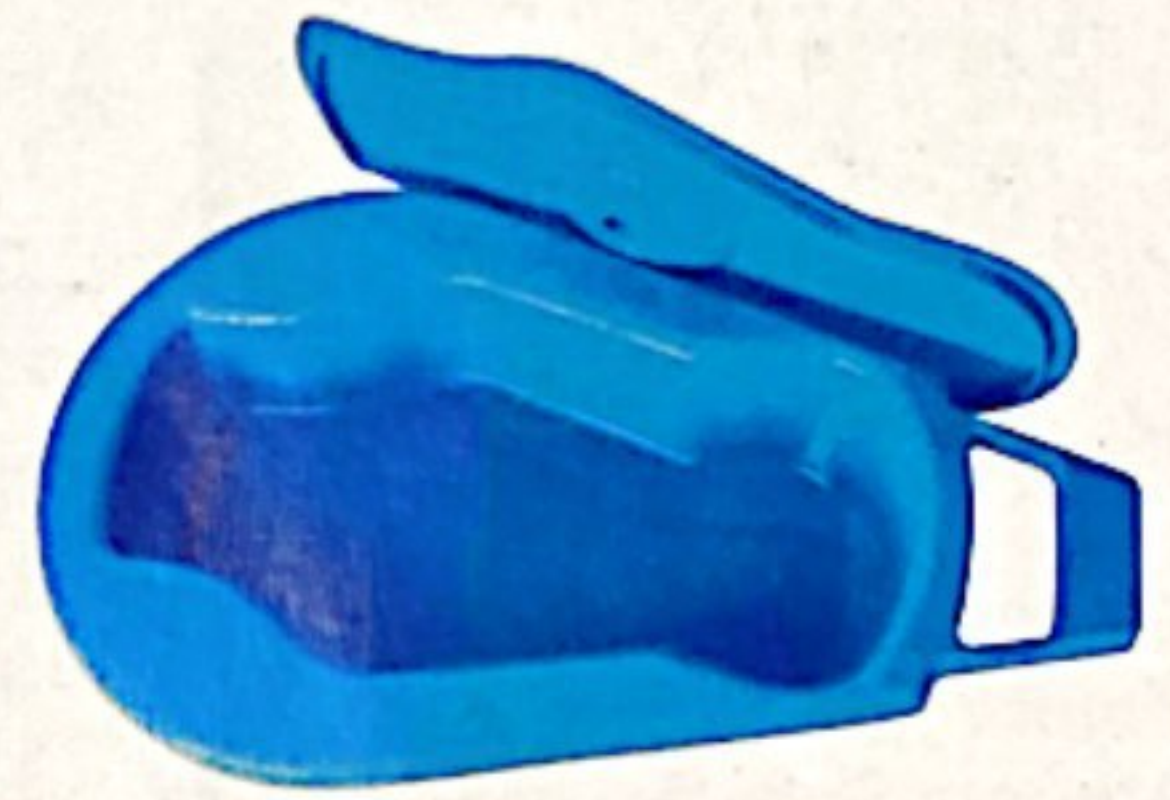

GT138-124

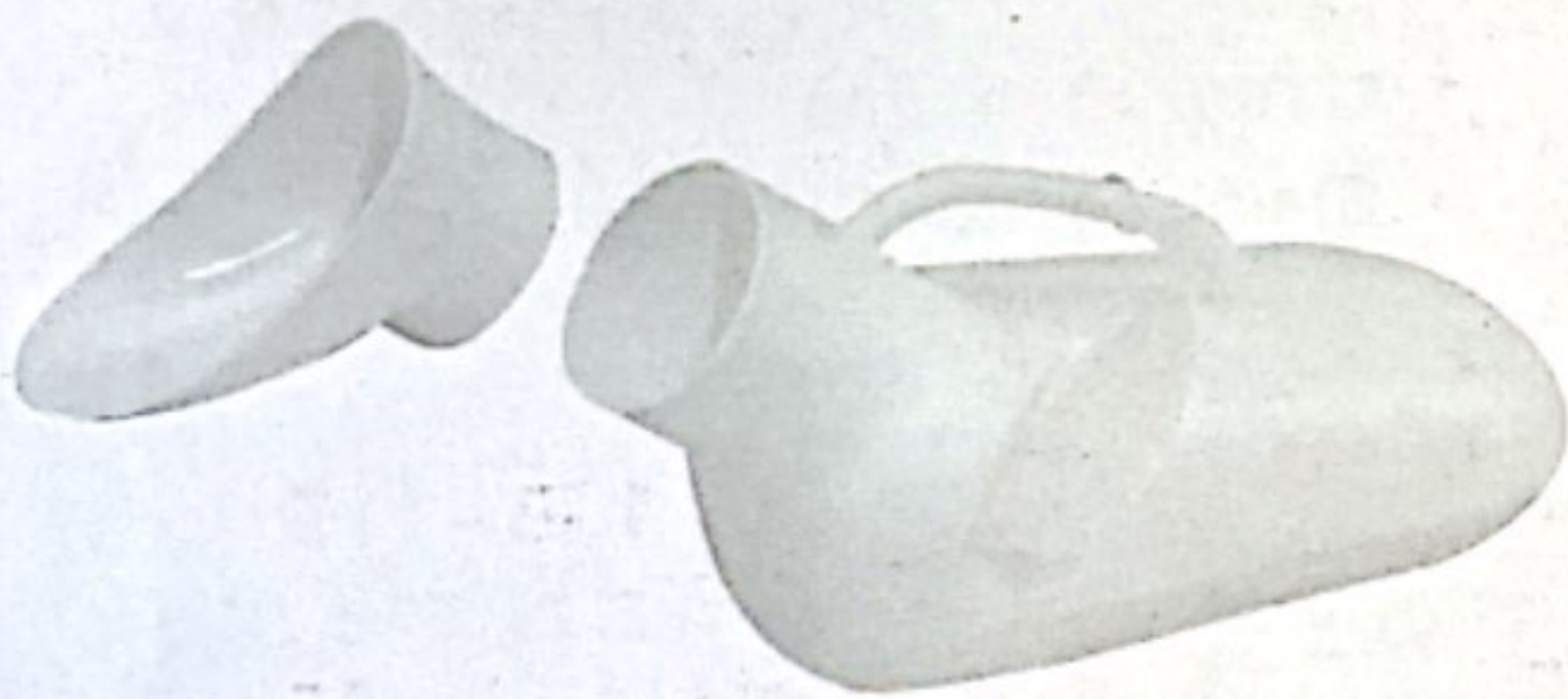

GT138-101



GT138-102



GT138-103



GT138-104



GT138-105



GT139-100

Best service to all old and new clients!  
- 11 patients in the world  
Scanned with CamScanner



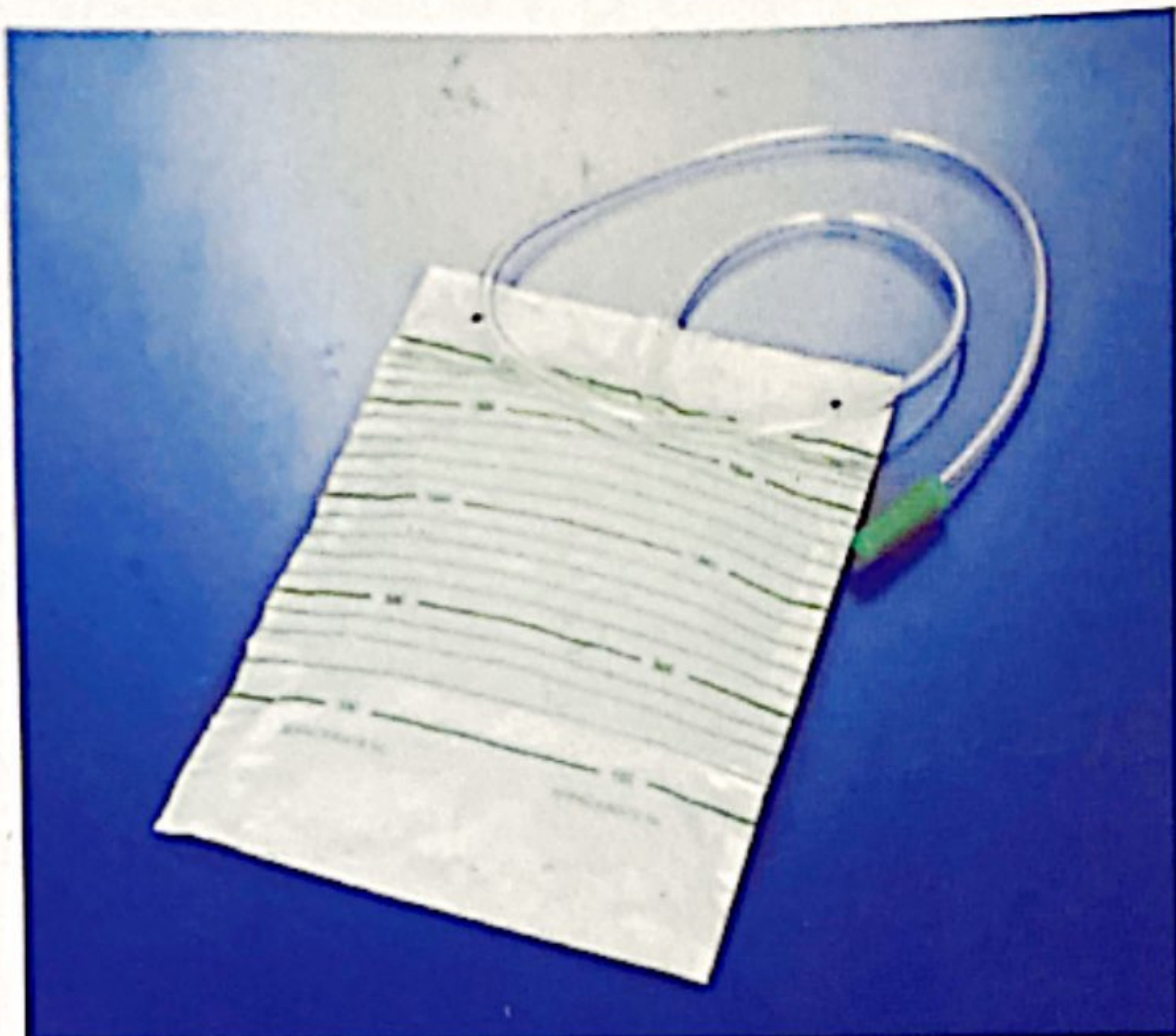

**GT028-100**

**Economic Urinary Drainage Bag**

Capacity: 2000ml

Without bottom outlet; with 90cm inlet tube,  
with non-return valve,

Sterilization: EO

Packing: 1pc/PE bag, 250pcs/carton

Measurement of carton: 52x32x36cm

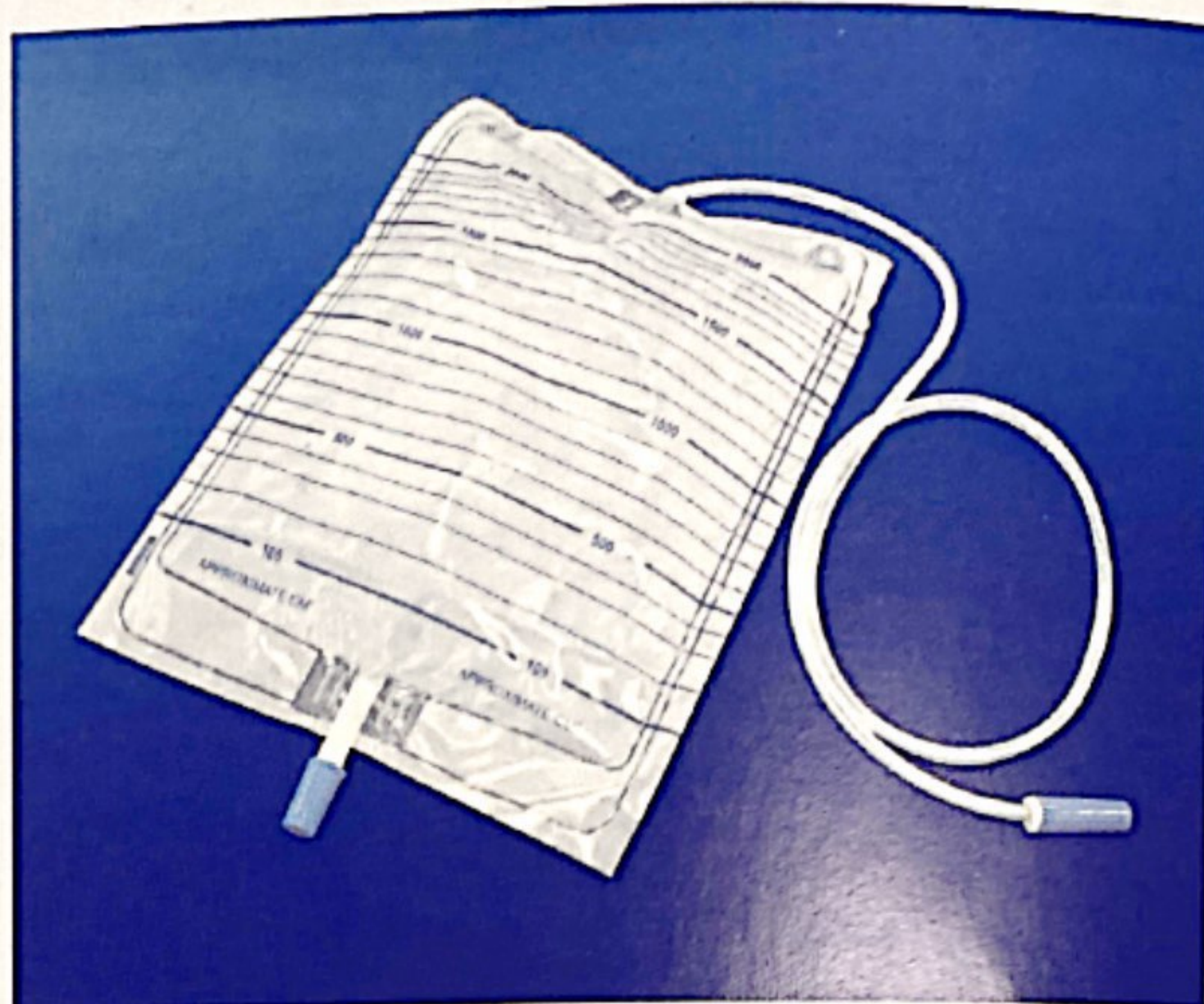

**GT028-200**

**Economic Urinary Drainage Bag**

Capacity: 2000ml

with bottom outlet; with 90cm inlet tube;

with non-return valve

with pull-push valve

Sterilization: EO

Form of packing: 1pc/PE bag, 250pcs/carton

Measurement of carton: 54x400x270mm

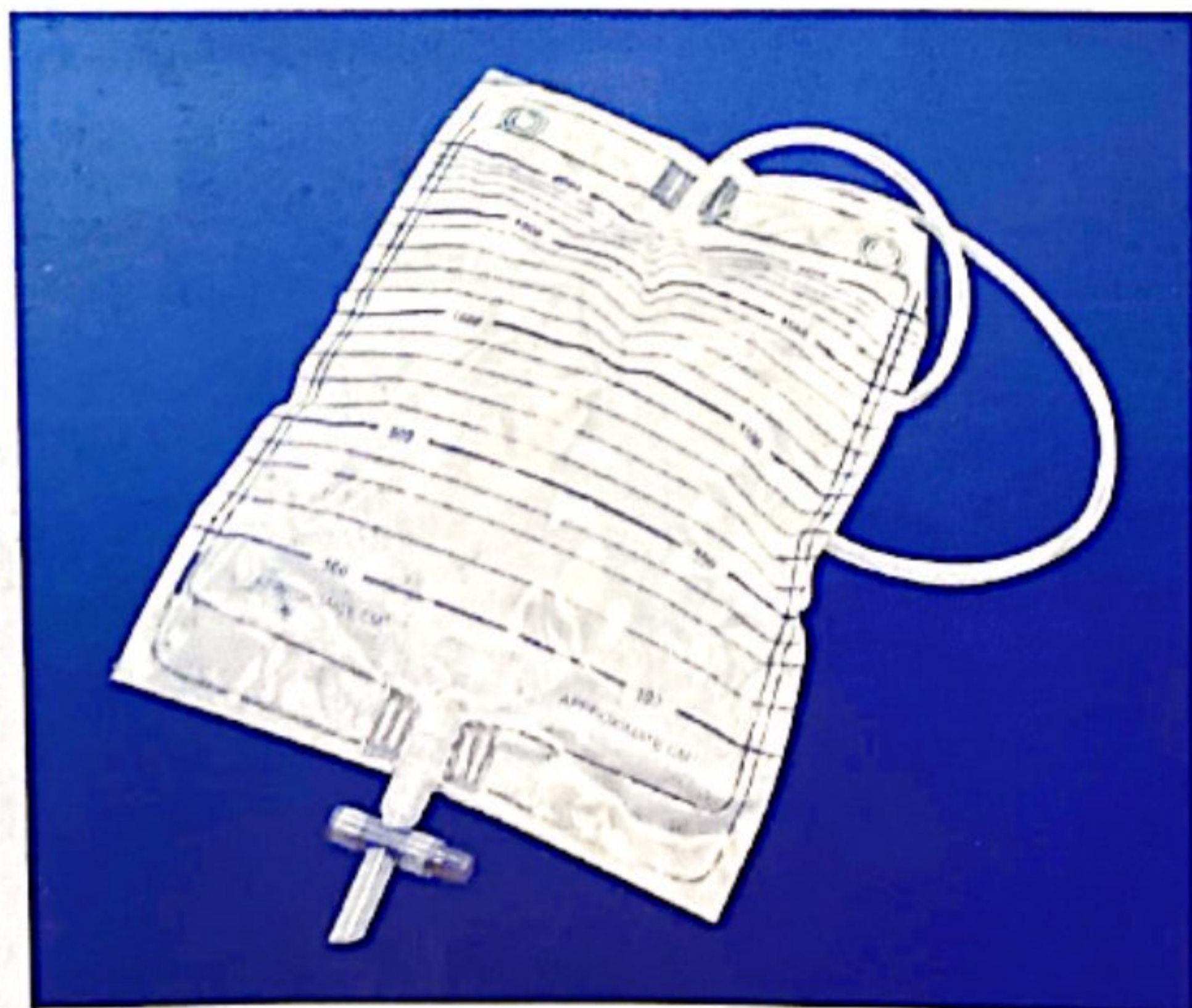

**GT028-210**

**Economic Urinary Drainage Bag**

Capacity: 2000ml

With bottom outlet; with 90cm inlet tube;  
with non-return valve, with T valve

Sterilization: EO

Packing: 1pc/PE bag, 250pcs/carton

Measurement of carton: 52x37x32cm



**GT028-300**

**Luxury Urinary Drainage Bag**

Capacity: 2000ml

Type: square bottom, latex free, with pull push valve,

with white sample port, with anti-reflux valve, with plastic tie

Inlet tube: O.D 10mm; 100cm length

Sterilization: EO

Packing: 1pc/PE or blister pack, 100pcs/carton,

Measurement of carton: 54x36x32cm





### GT010-160

#### Oxygen Mask with Reservoir bag

Made of medical grade PVC  
 Reservoir bay with/without check value  
 One safety vent open.  
 Mask with elastic strap,  
 Adjustable nose clip  
 Non-rebreathing Mask provides a high concentration of oxygen with 2m tubing,  
 Size available: S, M, L, XL  
 Packed in individual PE Bag  
 100pcs/ctn, Dimension: 47X39X25cm

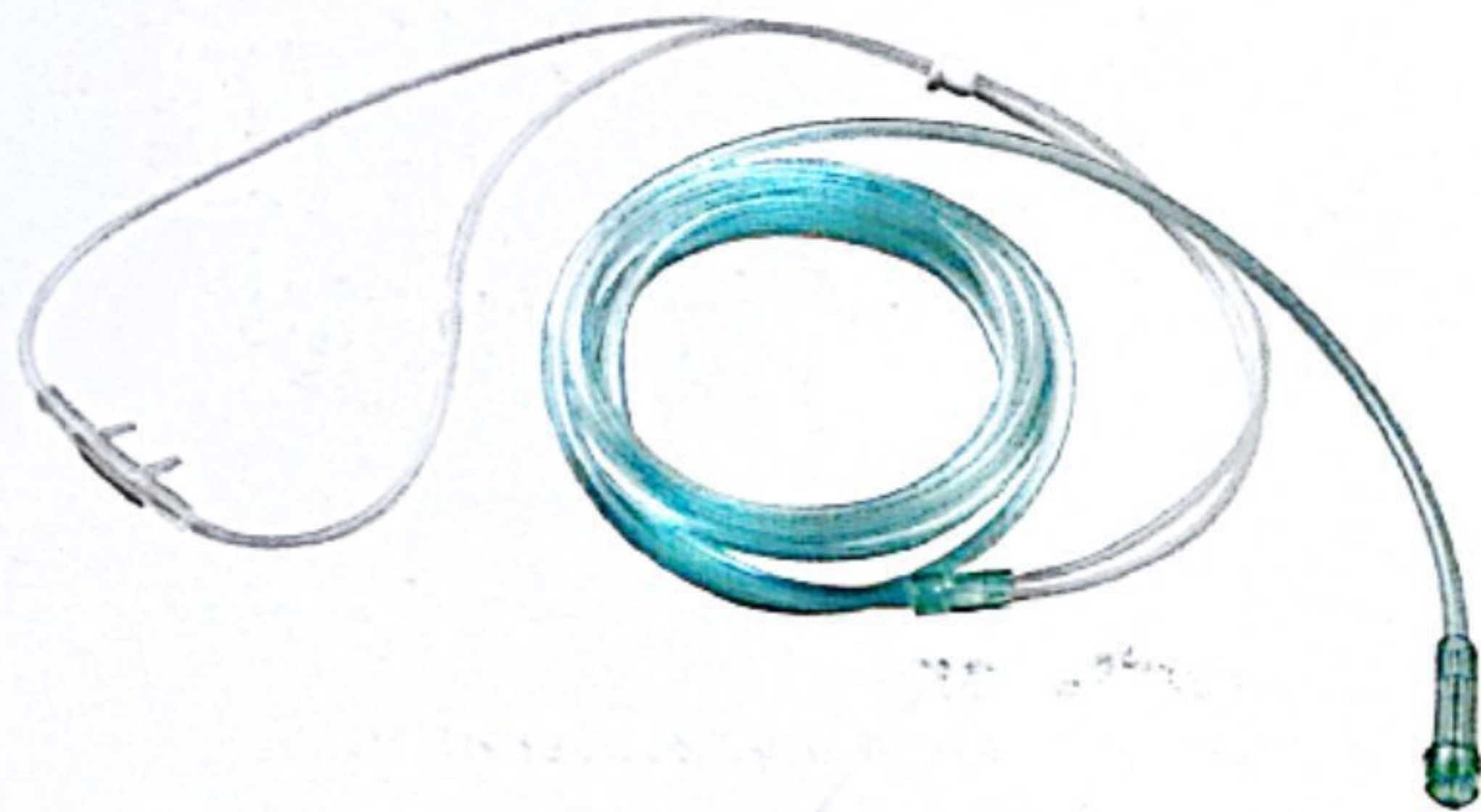

### GT013-100 Nasal Oxygen Cannula

Made of medical grade PVC,  
 Straight Tip, Flared Tip and Curved Tip is available.  
 With 2M tubing  
 Size available: S, M, L, XL  
 Packed in individual PE Bag  
 100pcs/ctn, Dimension: 45X38X20cm

### GT013-200 Soft tip

With 2m oxygen tubing

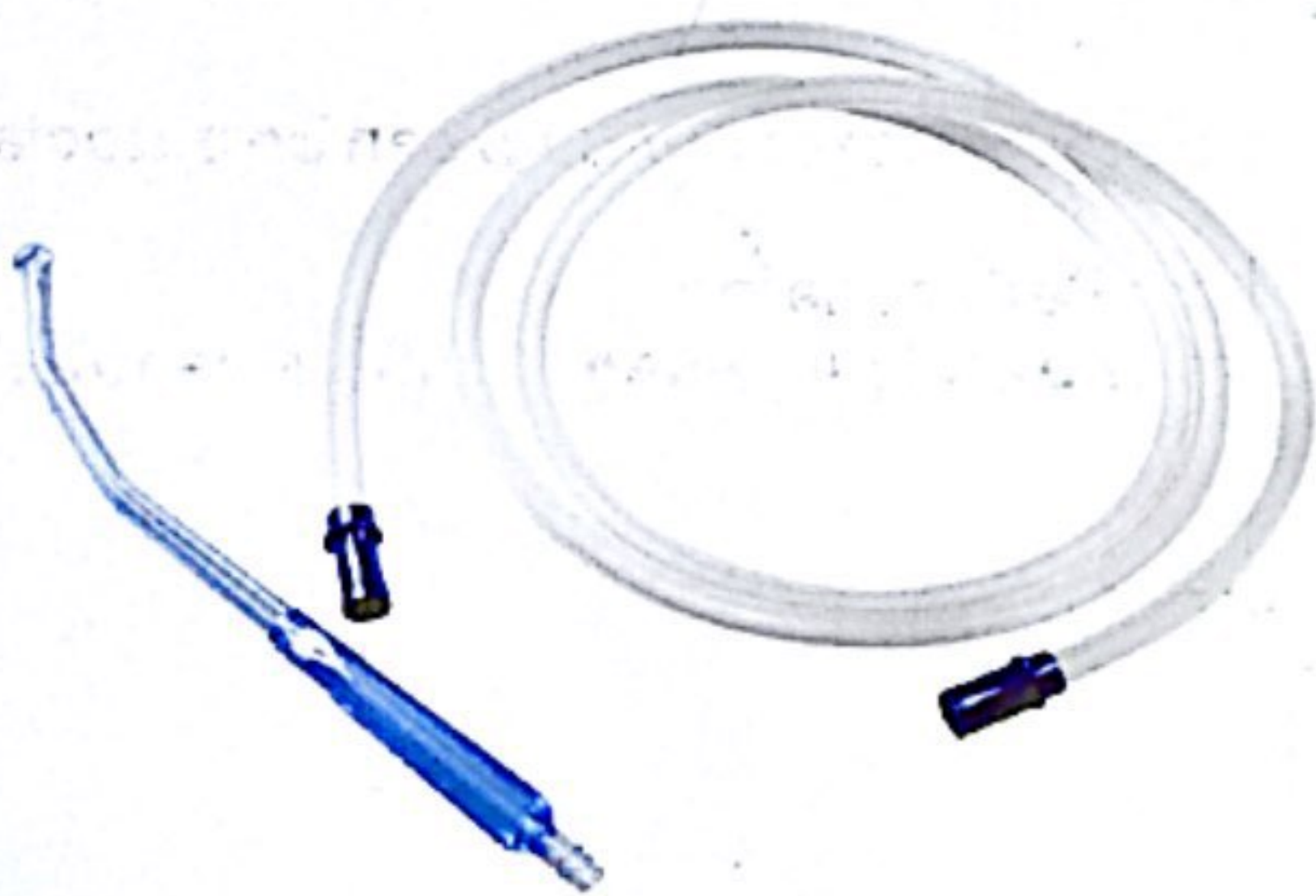

### GT027-100

#### Connecting Tube with Yankauer Handle

Made from non-toxic PVC, clear and soft  
 Large lumen resists clogging and the transparency allows clear visualization of liquids  
 Crown tip, vented.  
 With connecting tube  
 Size: 1/4"X1.8m, 1/4"X3.6m, 3/16"X1.8m, 3/16"X3.6m  
 Packed in individual Blister Bag or Poly Bag  
 20pcs/ctn, Dimension: 38X30X25cm



### GT032-100

#### Anaesthesia breathing system

##### Specification:

adult/pediatrics; common/extension tube  
 Construction: with L connector, three-way connector, breath air chamber, solenoid  
 Function: connect the equipment, transfer the air to body  
 Store claim: store in dark, dry and clean conditions, do not give heavy press  
 Form of packing: 30set/carton  
 Size of packing:  
 Export carton: 660x480x375mm  
 GW:5.8kgs



### GT032-200

Bacterial/Viral filter  
 Parts:Shell membrane  
 Material:styrene butadiene copolymer, hydrophobic polypropylene  
 250pcs/60x50x50cm  
 8kgs/7.5kgs

### Teeth Cushion



# Foley Catheter

Made from natural latex

Silicone coated

Available with the option of plastic valve or rubber valve

Colour-coded for visualisation of size



## GT022-200 2-way Latex Foley Catheter

Made from natural latex

Silicone coated

Plastic valve or Rubber valve is available

Color-coated for visualization of size

Fr6-Fr10 (Pediatric)

Length:270mm Balloon Capacity:3cc/5cc

Fr12-Fr22 (Standard)

Length:400mm Balloon Capacity:5cc/10cc/30cc

Fr24-Fr26 (Standard)

Length:400mm Balloon Capacity:10cc/30cc

Packed in individual Blister bag

10pcs/box, 500pcs/ctn, Dimension:52X43X47.5 cm

Medical Tubes

NINGBO GREETMED MEDICAL INSTRUMENTS CO.,LTD.  
WEB: <http://www.greetmed.com> E-MAIL: [info@greetmed.com](mailto:info@greetmed.com)



## GT022-300

### 3-Way Latex Foley Catheter

Made from natural latex

Silicone coated

Plastic valve or Rubber valve is available

Color-coated for visualization of size

Fr16-Fr26 (Standard)

Length:400mm Balloon Capacity:30cc

Packed in individual Blister bag

10pcs/box, 500pcs/ctn,

Dimension:52X43X47.5 cm

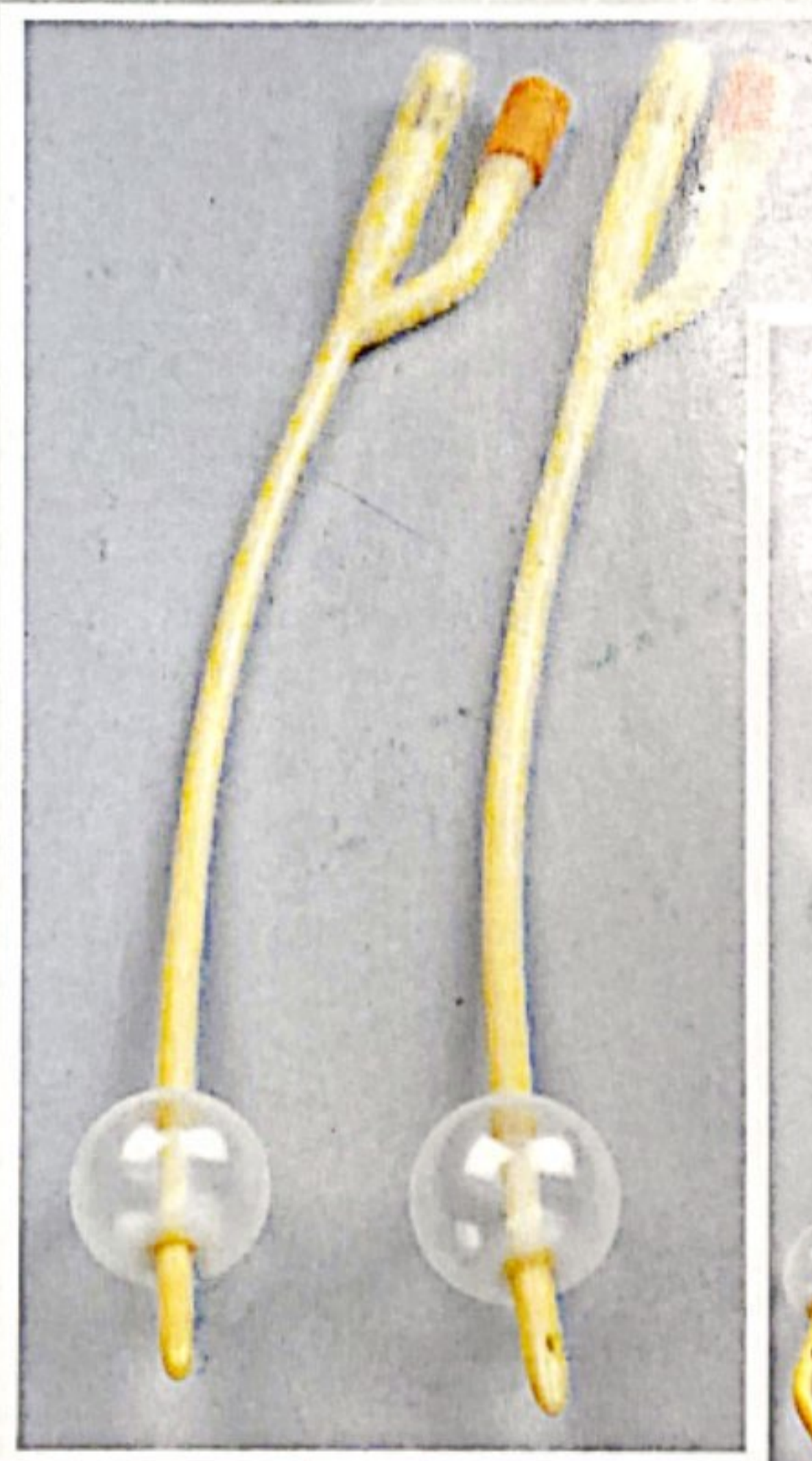

## GT022-400

### 2-Way Female Foley Catheter

Made from natural latex

Silicone coated

Plastic valve or Rubber valve is available

Color-coated for visualization of size

Fr12-Fr22

Length:240mm ,Balloon Capacity:5cc/10cc/30cc

Fr24-Fr26

Length:240mm, Balloon Capacity:10cc/30cc

Packed in individual Blister bag

10pcs/box, 500pcs/ctn,

Dimension:52X43X47.5cm



## GT022-500

### 2-Way Tiemann Foley Catheter

Made from natural latex

Silicone coated

Plastic valve or Rubber valve is available

Color-coated for visualization of size

Fr12-Fr22

Length:400mm Balloon Capacity:5cc/10cc/30cc

Fr24

Length:400mm Balloon Capacity:10cc/30cc

Packed in individual Blister bag

10pcs/box, 500pcs/ctn,

Dimension:52X43X47.5cm



10



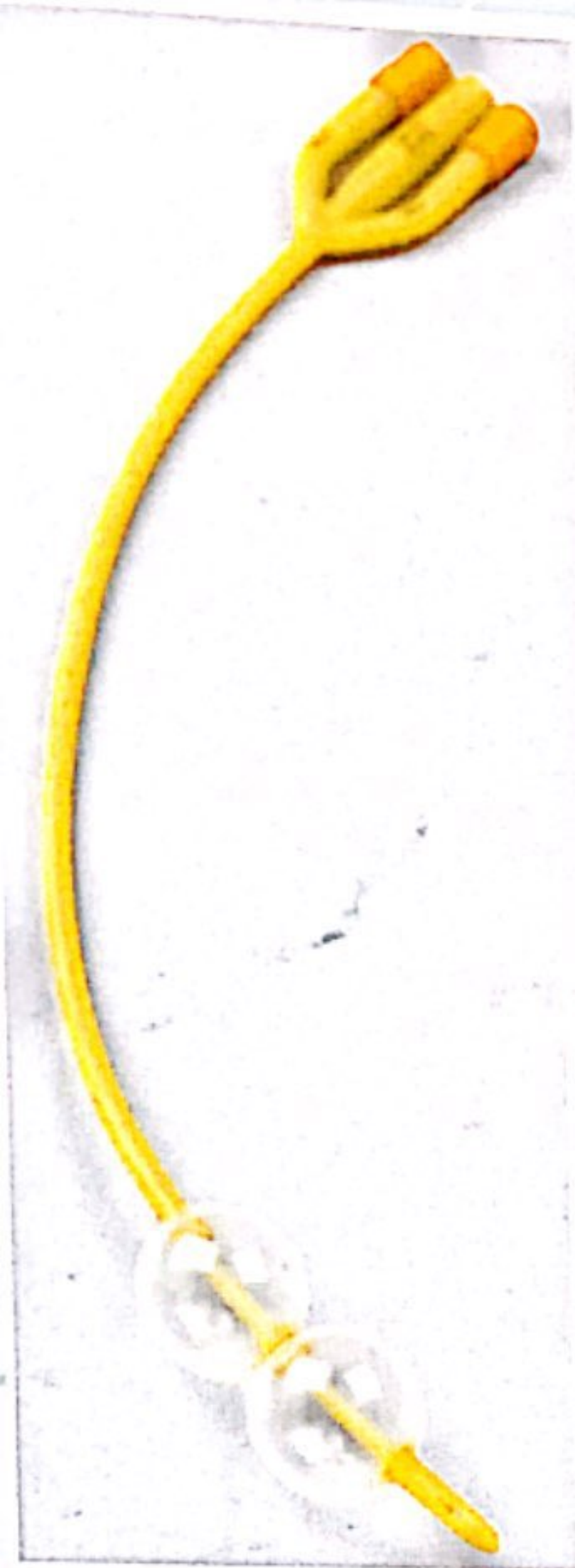

### GT022-600

### 3-Way Double Balloons

### Foley Catheter

Made from natural latex

Silicone coated

Color-coated for visualization of size

Fr16-Fr24

Length:400mm Balloon Capacity:30cc(front) / 50cc(rear)

Packed in individual Blister bag

10pcs/box, 500pcs/ctn, Dimension:52X43X47.5cm

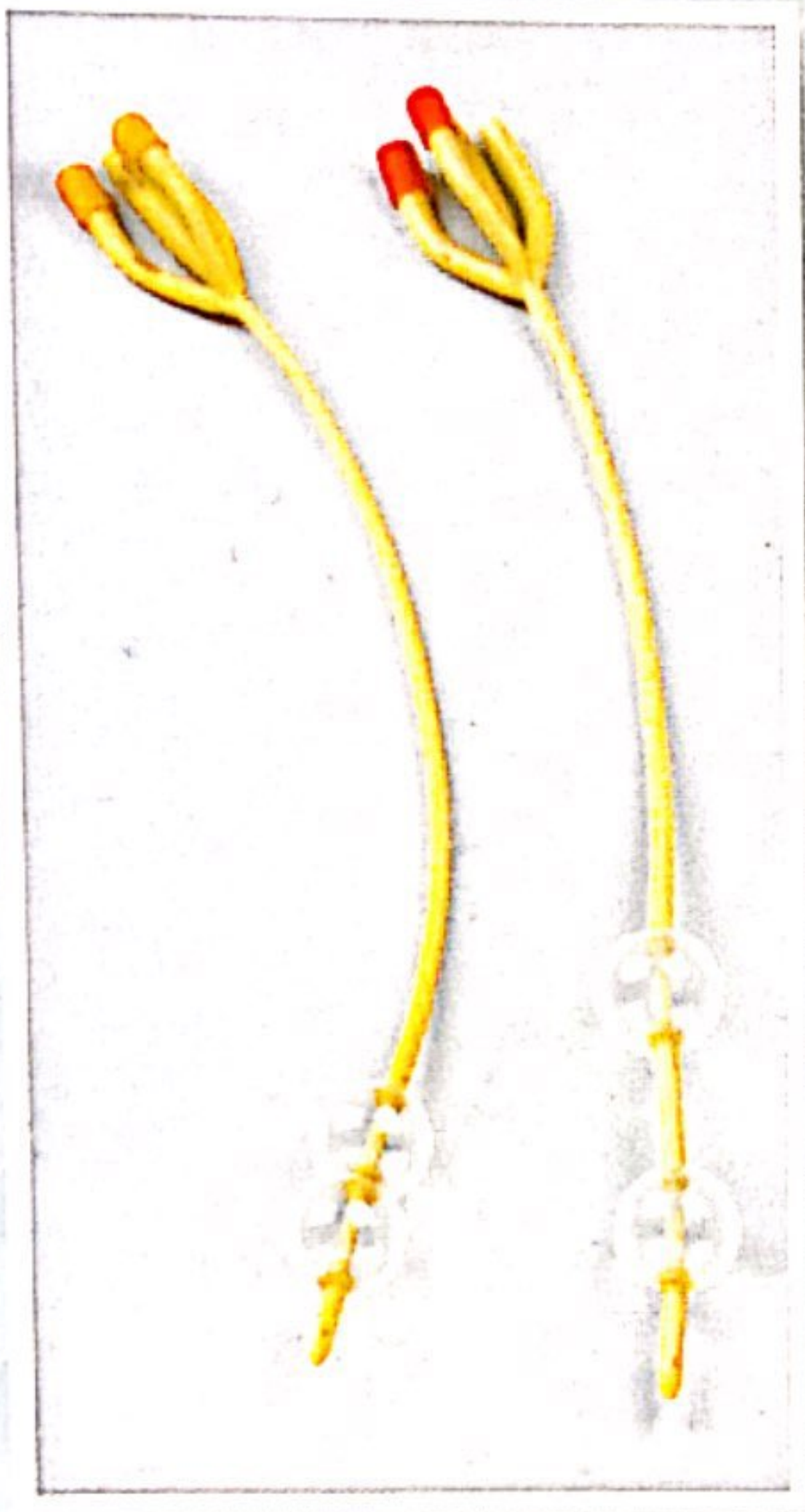

### GT022-700

### 4-Way Double Balloons Foley Catheter

Made from natural latex

Silicone coated

Color-coated for visualization of size

#### Type A:

Fr16-Fr24

Length:400mm Balloon Capacity: 30cc(front) / 50cc(rear)

#### Type B:

Fr16-Fr24

Length:400mm Balloon Capacity: 50cc(front) / 30cc(rear)

Packed in individual Blister bag

10pcs/box, 500pcs/ctn, Dimension:52X43X47.5cm

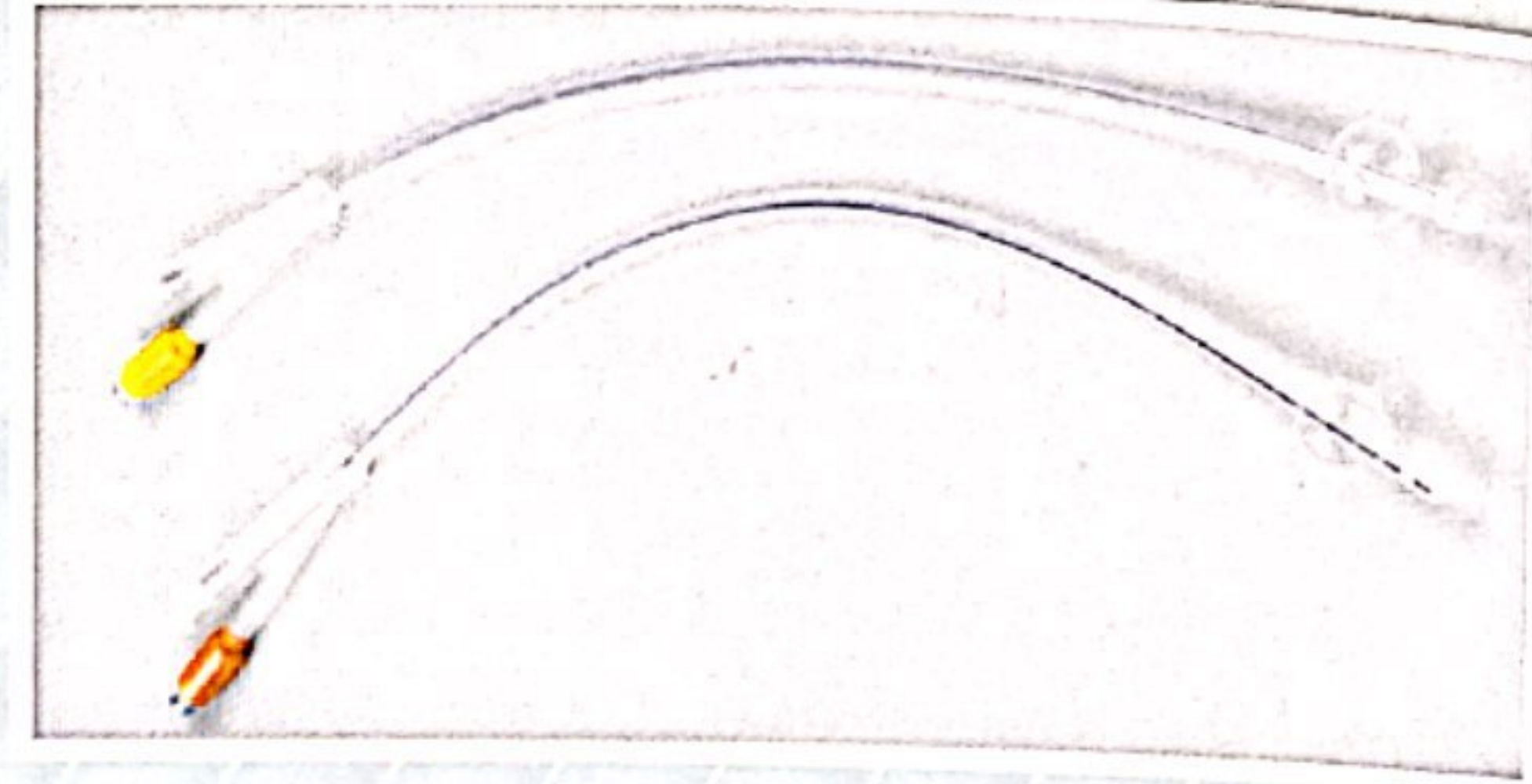

### GT022-900

### 2-Way All Silicone Foley Cath

Made from high quality 100% silicone, medical grade

With X-ray or without is available

Fr8-Fr10 (Pediatric)

Length:310mm Balloon Capacity:3cc/5cc

Fr12-Fr14 (Standard)

Length:400mm Balloon Capacity:5cc/10cc

Fr16-Fr24 (Standard)

Length:400mm Balloon Capacity:5cc/10cc

Packed in individual Blister bag

10pcs/box, 500pcs/ctn, Dimension:52X43X47.5cm

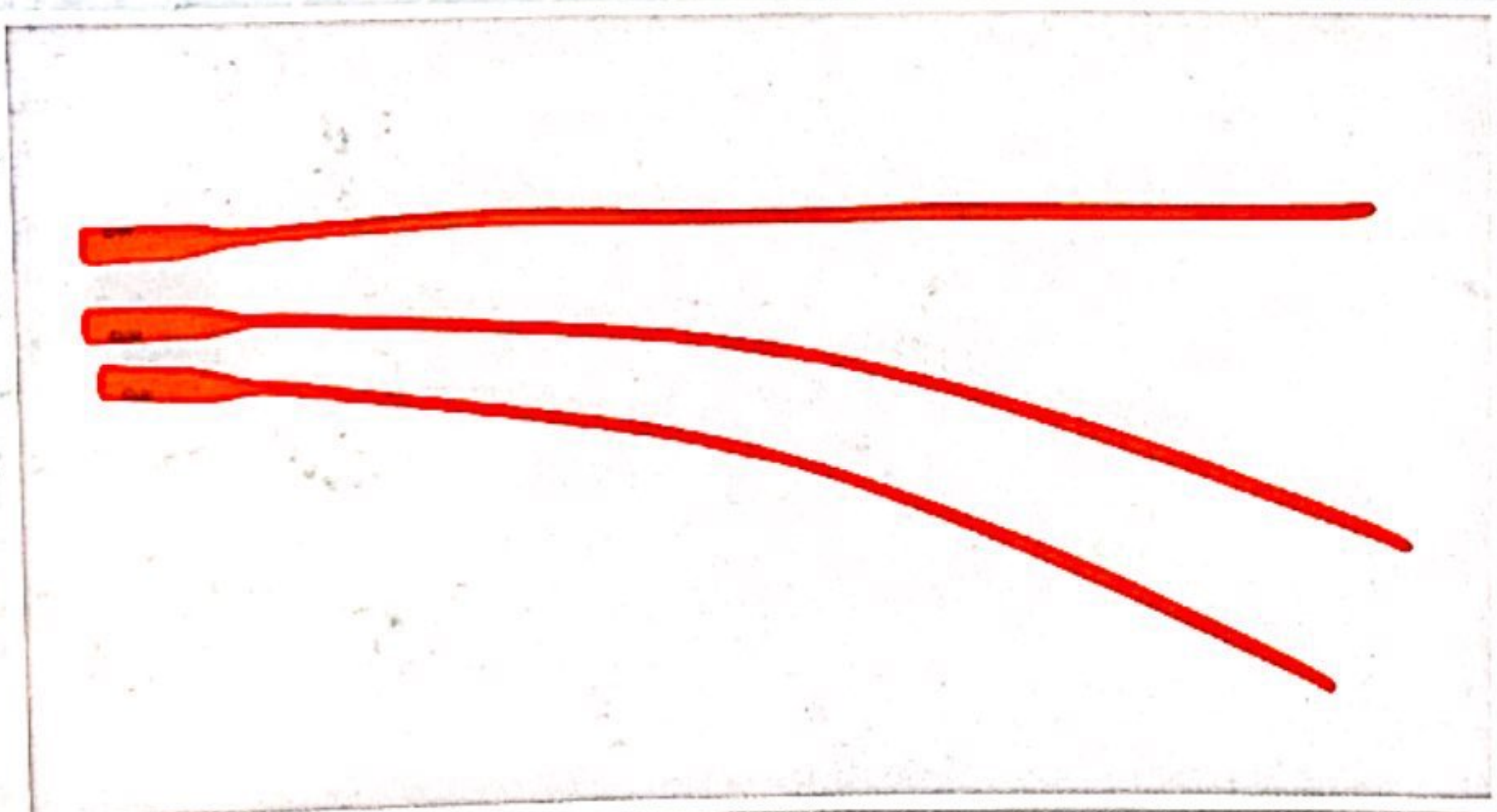

### GT022-100

### Urethral Catheter (Red Latex)

Made from natural latex

Silicone coated

Fr6-Fr24

Length:400mm

Packed in individual Blister bag

10pcs/box, 500pcs/ctn,

Dimension:52X43X47.5cm