



Medtronic

CD HORIZON[®] LEGACY[™]

Spinal System — Deformity

Surgical Technique

As described by:

Pierre Lascombes, MD
Professor at the Nancy University
School of Medicine

Orthopaedic Pediatric Surgery
Chief, Pediatric Surgery Service
Children's Hospital, CHU of
Nancy, France

Screw technique described by:

Lawrence G. Lenke, MD
The Jerome J. Gilden Professor of
Orthopaedic Surgery
Co-chief Adult/Pediatric Spine
Washington University
School of Medicine

Chief, Spinal Service
Shriners Hospital for Children
St. Louis, Missouri

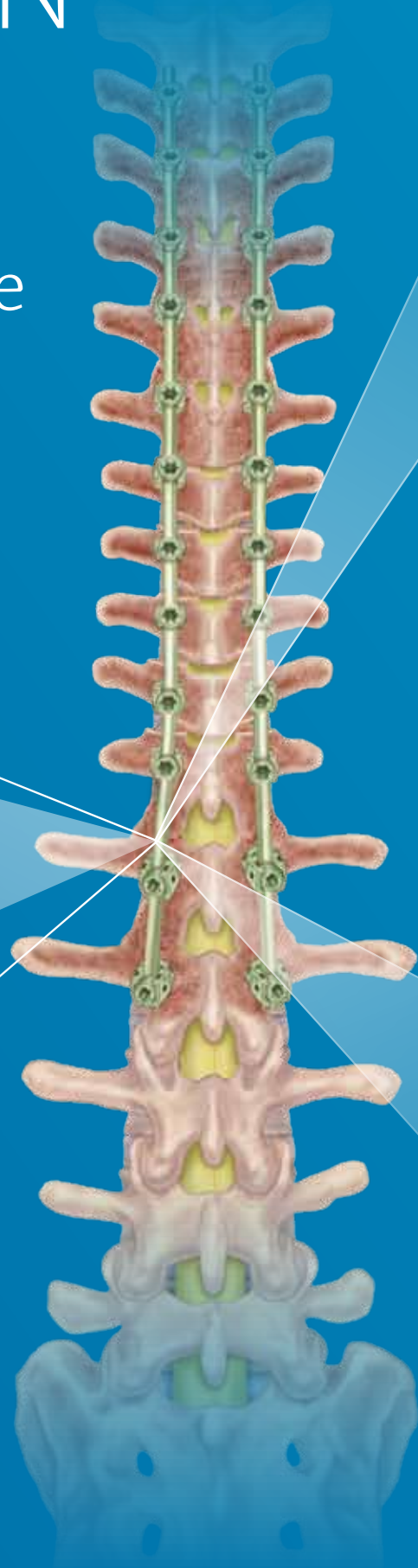





Medtronic

CD HORIZON[®] LEGACY[™]

Spinal System — Deformity

Surgical Technique

Implants	2
Instrument Set	4
Hook Surgical Technique	
Surgical Strategy	10
Hook Site Preparation/Options/Insertion	11
Hook Site Preparation/Options/Placement	12
Decortication	15
Rod Contouring	16
Rod Insertion	17
Rod Reduction	18
Deformity Correction	22
Compression/Distraction	24
Stabilization/Holding Rod Placement	25
Final Tightening	26
Transverse Link Placement/Closure	27
Pedicle Screw Surgical Technique	
Thoracic Facetectomy/Starting Points	28
Thoracic Pedicle Screw Starting Points (Perforated for Tear Out)	29
Pedicle Preparation	30
Screw Placement	33
Rod Contouring/Placement	34
Rod Reduction	35
Deformity Correction	37
Final Tightening/Decortication/CD HORIZON [®] X10 CROSSLINK [®] Plate Placement	39
Case Presentation	40
Removal Instructions	41
Product Ordering Information	42
Important Product Information	48

Implants

G4 Technology is the fourth-generation closure technology for CD HORIZON® instrumentation. The set screw has been designed to thread easier and hold stronger. The reverse-angle thread locking mechanism reverses the force vectors a set screw normally exerts on the side walls of implants during final tightening.

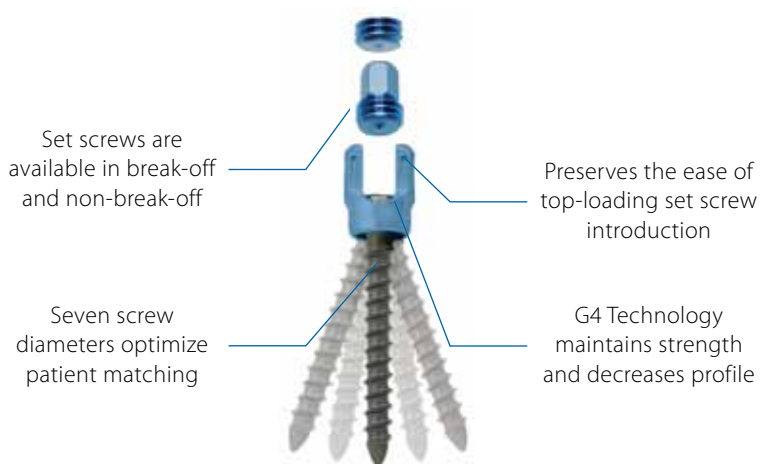

CD HORIZON® LEGACY™ System Fixed Angle Screw

Color-coding Reference

NOTE: Color-coding available for titanium implants only.



Axial Connector

- 84509HT (5.5mm Titanium)
- 96509HT (6.35mm Titanium)
- 84509H (5.5mm Stainless Steel)
- 96509H (6.35mm Stainless Steel)



Domino Connector









- 84505HT (5.5mm Titanium)
- 96505HT (6.35mm Titanium)
- 84505H (5.5mm Stainless Steel)
- 96505H (6.35mm Stainless Steel)



Rod

- 869-021 (5.5mm Titanium)
- 969-022 (6.35mm Titanium)

Hook Implants

Hook Type	Vertebral Posterior Element Placement	Blade Direction	Region of Spine	Design Features
 Pedicle Hook	Articular Process	↑	T1 – T10	<ul style="list-style-type: none"> » Bifid blade grasps thoracic pedicle for stability. » Lipped design can improve hook stability.
 Wide Blade Hook	Lamina	↕	T1 – L5	<ul style="list-style-type: none"> » Wider blade width distributes forces evenly over a wider aspect of bone. » Lipped design for hook stability on the lamina.
	Transverse Process	↕	T1 – L5	
 Narrow Blade Hook	Lamina	↕	T1 – L5	<ul style="list-style-type: none"> » Narrower blade width minimizes metal volume in the spinal canal. » Lipped design for stability on the lamina.
	Transverse Process	↕	T1 – L5	
 Thoracic Supralaminar Hook	Lamina	↓	T1 – T10	<ul style="list-style-type: none"> » Hook throat ramp prevents blade from pistoning into the spinal canal.
	Transverse Process			
 Thoracic Angled Hook	Lamina	↓	T1 – T3	<ul style="list-style-type: none"> » Better aligns hook saddles for a pediculo-laminar claw in the upper thoracic spine.
	Transverse Process			
 Lumbar Infralaminar Hook	Lamina	↑	T10 – L2	<ul style="list-style-type: none"> » Blade geometry designed to better fit the lumbar lamina.
	Transverse Process			
 Extended Body Hook	Lamina	↕	T1 – L5	<ul style="list-style-type: none"> » Can correct anatomic misalignment between two laminae in the dorso-ventral plane.
	Transverse Process	↕	T1 – L5	
 Offset Hook	Lamina	↕	T1 – L5	<ul style="list-style-type: none"> » Can be used to medialize or lateralize the rod in supralaminar or infralaminar position. » Can back up a pedicle screw at the same level.
	Transverse Process	↕	T1 – L5	

Instrument Set

Hook Preparation



Wide Blade Laminar Elevator
7480220



Pedicle Elevator
7480225



Narrow Blade Laminar Elevator
7480221



Transverse Process Elevator
7480222

Hook Placement

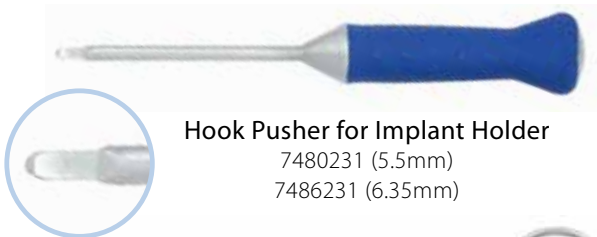

Hook Pusher for Implant Holder
7480231 (5.5mm)
7486231 (6.35mm)

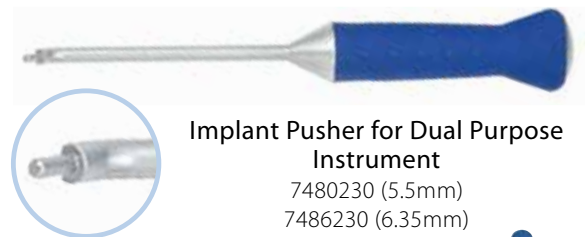

Implant Pusher for Dual Purpose Instrument
7480230 (5.5mm)
7486230 (6.35mm)



Lateral Implant Holder
7480211 (5.5mm)
7486211 (6.35mm)

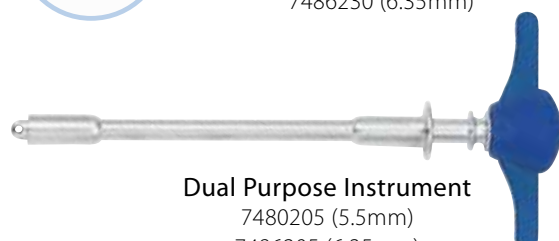

Dual Purpose Instrument
7480205 (5.5mm)
7486205 (6.35mm)



Straight Implant Holder
7480216 (5.5mm)
7486216 (6.35mm)

Instrument Set *continued*

Screw Preparation



Thoracic Ball Handle Probe
7480112



Lumbar Ball Handle Probe
7480110



In-Line Round Awl
7480104



Quick Connect Ratcheting Handle
9339082



Tap

- | | |
|------------------|-----------------|
| 8683750 (3.75mm) | 836-015 (5.5mm) |
| 8684000 (4.0mm) | 836-016 (6.5mm) |
| 8684500 (4.5mm) | 836-018 (7.5mm) |
| 8685000 (5.0mm) | |



Dual Ended Feeler Probe
7480100



Sounding/Feeler Probe
8572102

Screw Placement



Fixed Angle Screwdriver
7480280 (5.5mm)
7486280 (6.35mm)



Multi-Axial Screwdriver
7480113 (5.5mm Standard)
7486113 (6.35mm Standard)
7480109 (5.5mm Short)
7486109 (6.35mm Short)

Instrument Set *continued*

Rod Contouring



Rod Template
808-575



French Bender
7480162

Rod Insertion



Rod Pusher
7480235 (5.5mm)
7486325 (6.35mm)



C-Shaped Rod Pusher
7480236 (5.5mm)
7486236 (6.35mm)



Rod Inserter
7480126 (5.5mm)
7486126 (6.35mm)

Instrument Set *continued*

Rod Reduction



Beale Rod Reducer

7480134 (5.5mm)
7486134 (6.35mm)



Lateral Rod Reducer

7480277/7480278 (5.5mm)
7486277/7486278 (6.35mm)



Forceps Rocker

7480142 (5.5mm)
7486142 (6.35mm)



Lateral Translator

7480240/7480245 (5.5mm)

Correction



Coronal Benders

7480265 (5.5mm Left)
7480270 (5.5mm Right)
7486265 (6.35mm Left)
7486270 (6.35mm Right)



In Situ Benders

7480255 (5.5mm Left)
7480260 (5.5mm Right)
7486255 (6.35mm Left)
7486260 (6.35mm Right)



Rod Gripper

7480175 (5.5mm)
7486175 (6.35mm)

Instrument Set *continued*

Compression and Distraction



Parallel Compressor, Small
7480165



Parallel Compressor, Large
7480166



Distractor
7480171

Final Tightening/Set Screws

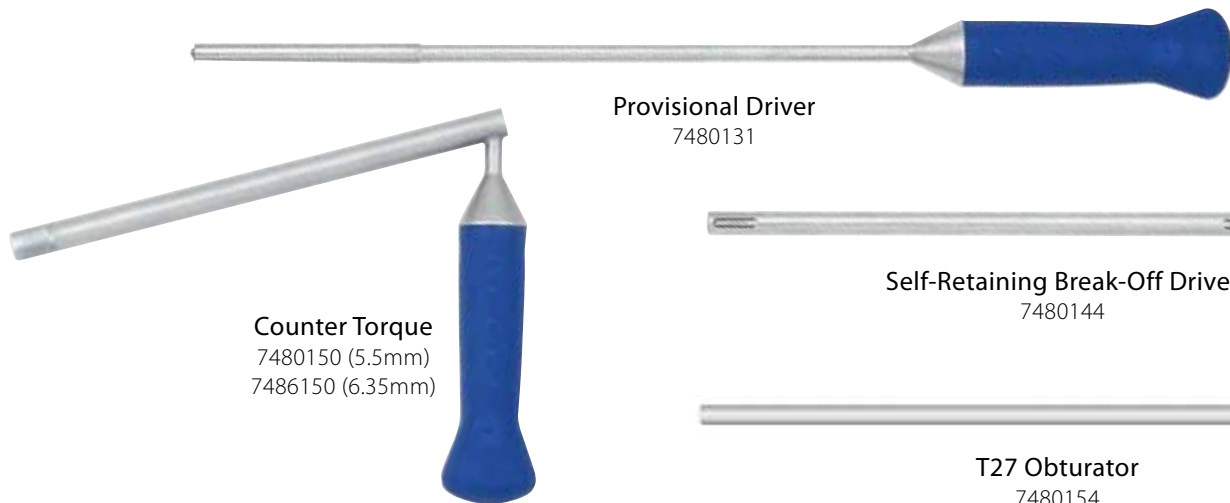

Counter Torque
7480150 (5.5mm)
7486150 (6.35mm)

Provisional Driver
7480131



Self-Retaining Break-Off Driver
7480144



T27 Obturator
7480154



Dual Ended Plug Starter
7480122

Additional Instruments



3.0mm Hex Driver
8110530



TORX 20 Shaft
815-517

TORX 25 Shaft
815-518

Instrument Set *continued*

CD HORIZON® X10 CROSSLINK® Plate Implants and Instruments



CD HORIZON® X10 CROSSLINK®
MULTI-SPAN® Plate



CD HORIZON® X10 CROSSLINK®
Fixed Plate



Measuring Card
8110501



Implant Positioners
808-545 (optional)



Measuring Caliper
8110502

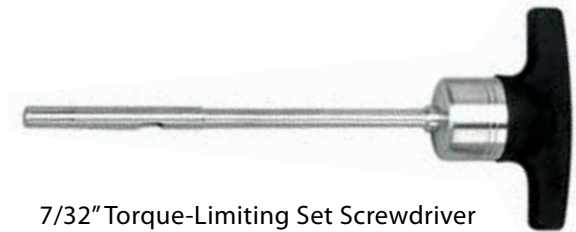

7/32" Torque-Limiting Set Screwdriver
8110535



Counter Torque
8110540



45° In-line Plate Holder
8110511

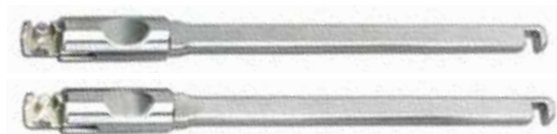

Plate Benders
8110525



Forceps Plate Holder
8110510 (optional)



3.0mm Hex Head Shaft, Removal Driver
8110530

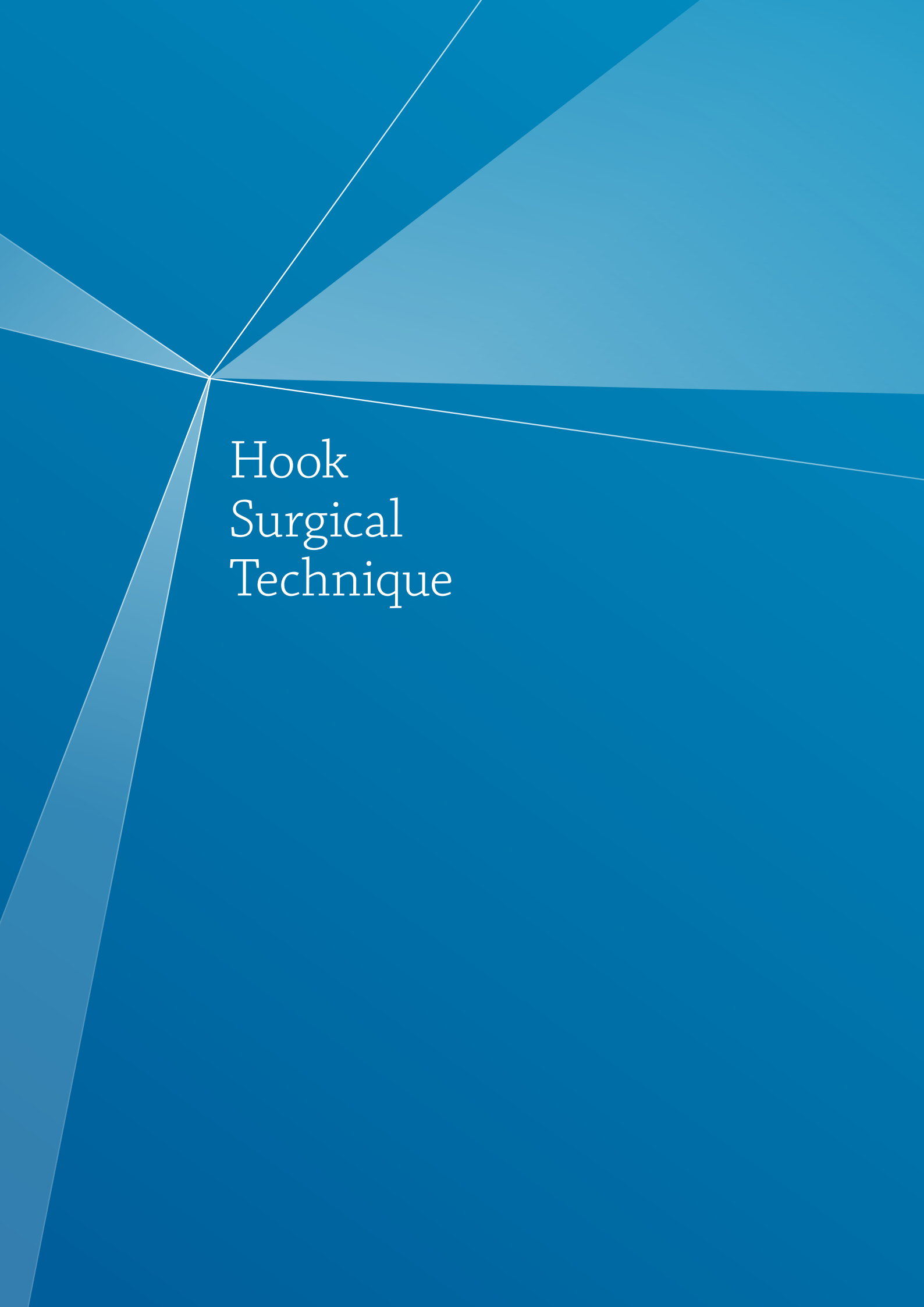

Hook
Surgical
Technique

Surgical Strategy

STEP 1

Preoperatively, any spinal surgery should be studied and a scheme of the construct defined.

Shown below are examples of some typical hook constructs for a T4-L1 scoliosis and a T2-S1 scoliosis. These schemes, which are strictly for illustrative purposes, are examples of how to treat these types of scoliosis. **Figure 1** shows a standard right thoracic curve (Lenke Type 1AN/King Type III) instrumented with hooks from T4 to L1. This case can also be treated using a hybrid construct consisting of hooks and pedicle screws (**Figure 2**). **Figure 3** shows a construct treating neuromuscular scoliosis from T2 to S1.

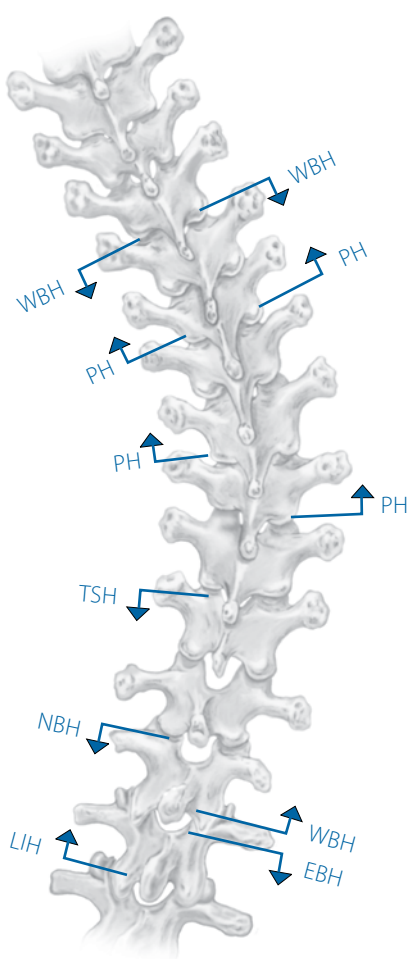

Figure 1

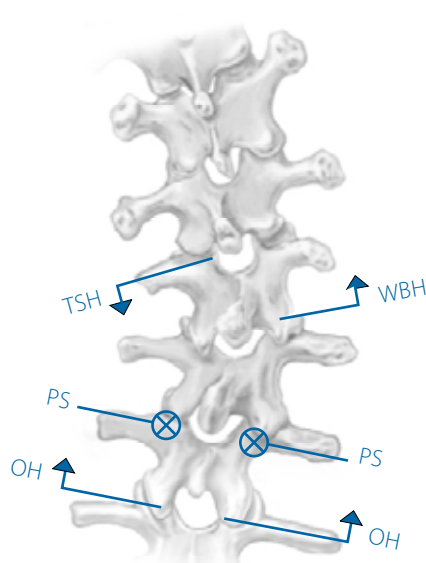

Figure 2

Hook Construct Legend	
EBH	= Extended Body Hook
LIH	= Lumbar Infralaminar Hook
NBH	= Narrow Blade Hook
OH	= Offset Hook
PH	= Pedicle Hook
PS ⊗	= Pedicle Screw
TAH	= Thoracic Angled Hook
TSH	= Thoracic Supralaminar Hook
WBH	= Wide Blade Hook
↗	= Up-Going Hook
↘	= Down-Going Hook

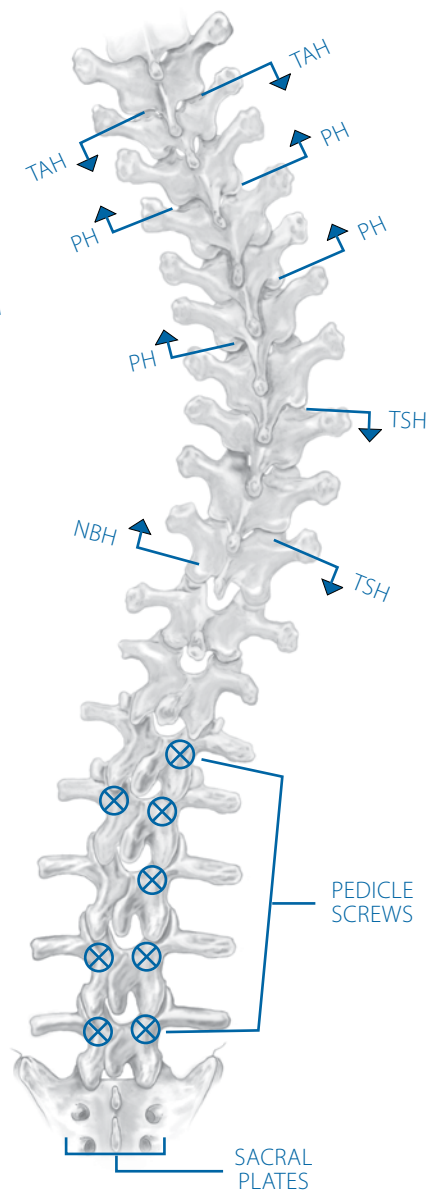

Figure 3

Hook Site Preparation/Options/Insertion

STEP 2

The CD HORIZON® LEGACY™ Spinal System offers a number of top-loading hooks of different anatomic shapes and sizes (see hook implants chart, page 3). Any CD HORIZON® LEGACY™ Spinal System hook may be treated as a closed hook by placing the set screw into the hook prior to insertion of the rod. The surgeon must choose the appropriate hook based on the individual patient's anatomy, deformity degree and type, method of correction chosen, and amount of compression/distraction that will be needed to provide proper and stable purchase of the implants.

Several different instruments can be used for hook insertion, including the Dual Purpose Instrument combined with the Hook Pusher (**Figure 4**) or the Straight or Lateral Hook Holder combined with the captive Hook Pusher (**Figure 5**).



Hook Site Preparation/Options/Placement

STEP 3

Pedicle Hook

The Pedicle Hook may be used from T1 to T10. The hook blade is always cephalad (up-going) and is in the infralaminar position. The facet capsule is divided, and a portion of the inferior facet process may be removed to facilitate insertion of the hook (**Figure 6**). Once the pedicle has been clearly identified with the help of the Pedicle Elevator (**Figure 7**), the hook may be inserted.

If needed, a mallet can be used to impact the Pedicle Hook. It is important that the Pedicle Hook is placed into the joint cavity and is not splitting the inferior articular process (**Figures 8a and 8b**).

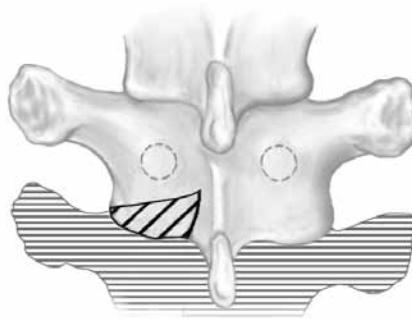

Figure 6

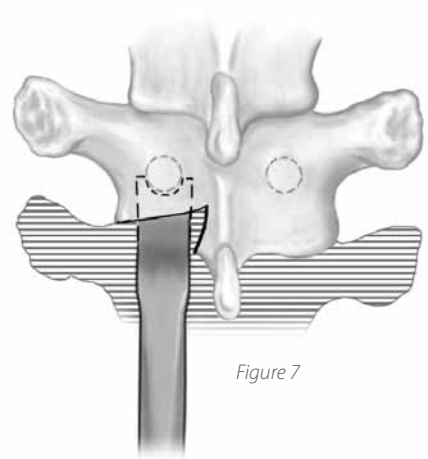

Figure 7



CORRECT

Figure 8a



INCORRECT

Figure 8b

Hook Site Preparation/Options/Placement *continued*

STEP 3

Transverse Process Hook

This is generally a wide blade hook and is typically used in a pedicle-transverse claw construct as a caudal (down-going) hook (**Figure 9**). The Transverse Process Elevator or the Laminar Elevator may be used to separate the ligamentous attachment between the undersurface of the transverse process and the posterior arch of the rib medial to the rib-transverse joint. An Implant Holder is used to insert this hook.

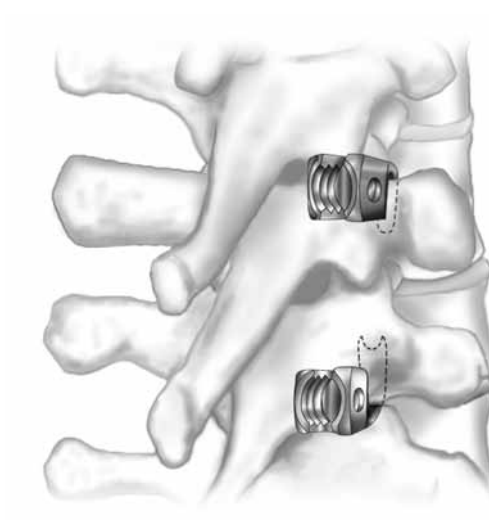

Figure 9

Hook Site Preparation/Options/Placement *continued*

STEP 3

Laminar Hooks:

Thoracic Supralaminar Hook

The direction of this hook is always caudal (down-going). A partial or total division of the spinous process directly above the vertebra to be instrumented (thoracic vertebra) may be performed. A division and/or partial removal of the ligamentum flavum and a small laminotomy are carried out on the superior lamina. The amount of bone removed from the lamina may vary depending on the size of the hook blade and throat angle chosen. The upper edge of the lamina below may be resected to ease the placement of this hook. The Laminar Elevator may be used to check the space between lamina and peridural structures (**Figure 10**). Two sizes of Laminar Elevators are available depending on the size of the lamina and thus the size of the hook blade: Narrow or Wide Blade. An Implant Holder is typically used to insert the hook (Dual Purpose Instrument or Straight/Lateral Implant Holders) when placed on the superior lamina (**Figure 11**).



Figure 10



Figure 11



Figure 12a

Lumbar Infralaminar Hook

This hook is always inserted in the cephalad (towards the head) direction and is generally used at T10 or below. With this hook type, the ligamentum flavum is partially removed or separated from the inferior surface of the lamina using the Laminar Elevator, keeping the bone intact, if possible (**Figures 12a and 12b**). An Implant Holder is used to insert the hook.

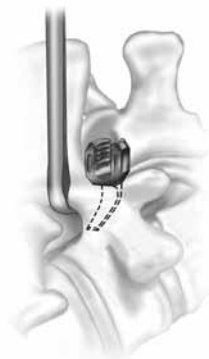

Figure 12b

Decortication

STEP 4

Once inserted, laminar hooks are not very stable prior to rod insertion. Therefore, it is recommended to remove them and keep them on the staging module (Figure 13).

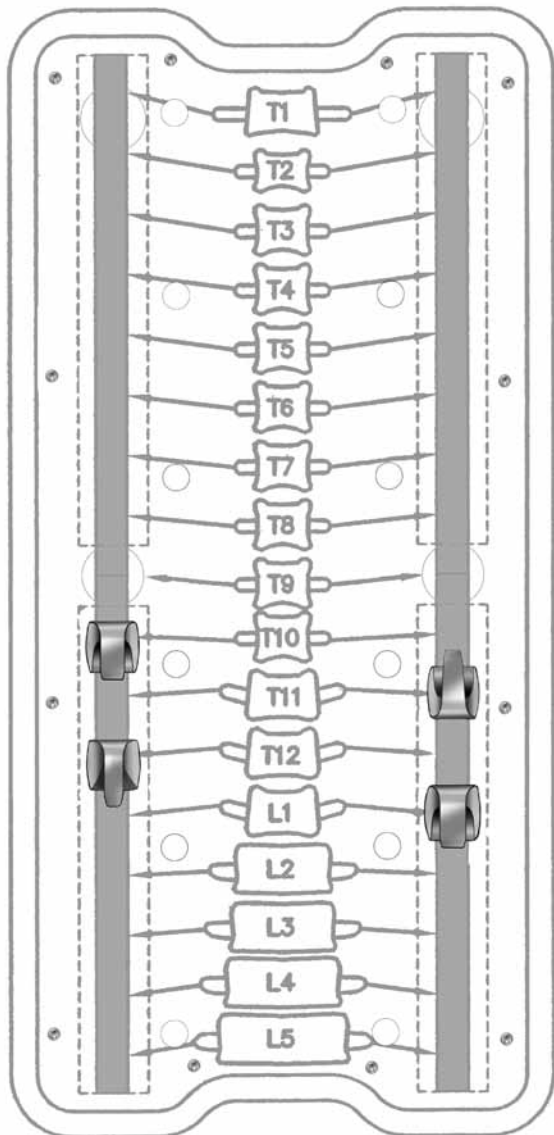

Figure 13

At this point in the surgery, bilateral partial facetectomies are carried out (Figure 14). The intervening cartilage is denuded to allow exposure of the subchondral bone assisting in bone fusion. Decortication of the laminae, spinous processes, and transverse processes, along with bone graft placement, will be done at the end of the surgery to avoid intraoperative bleeding. Laminar hooks are placed back into their position.

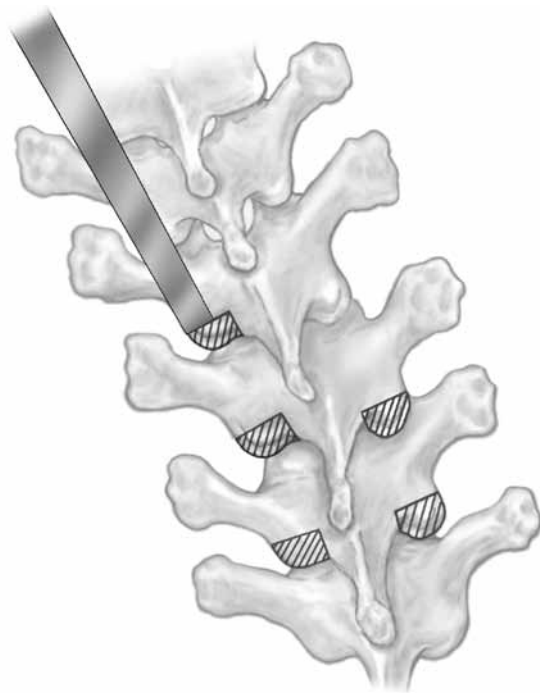

Figure 14

Rod Contouring

STEP 5

Once the hooks on the correction side of the deformity (concave in the thoracic area, convex in the lumbar area of the spine) are tested for fit and placement, a rod template may be used to determine the length and the curve. The correction rod is cut to the appropriate length (2cm to 3cm longer than the overall hook-to-hook length). To achieve the correct sagittal plane contour, the rod is bent in small incremental steps using a French Bender (**Figure 15**). It is important to maintain a same plane orientation of the rod to prevent a spiral-type bend down the rod.

In the case of a reducible scoliosis, the rod is bent according to the final postoperative planned correction to obtain a nice postoperative thoracic kyphosis and lumbar lordosis.

In a case of stiff scoliosis, the rod is placed along the spine to check for proper correction, hook fit, and contouring. This type of scoliosis correction will be mainly obtained with in situ bending.

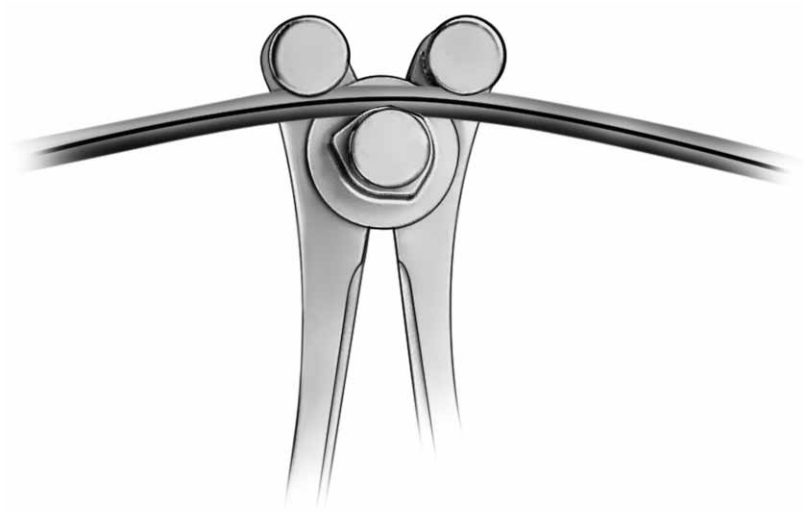

Figure 15

Rod Insertion

STEP 6

The contoured rod is placed into the top-loading implants beginning from either the upper or lower part of the construct: there is no particular rule for rod insertion. One can start with the implants in which the rod seems to best position and facilitate the continuation of the insertion (**Figures 16a and 16b**). A rod holder may be used to assist in placing the rod. Using the Dual Ended Plug Starter, set screws are placed into the first implants where the rod seats perfectly. The Rod Pusher may be used to push the rod down in order to place a set screw and/or, due to its C-shape, to push the hook into its correct position (**Figure 17**).

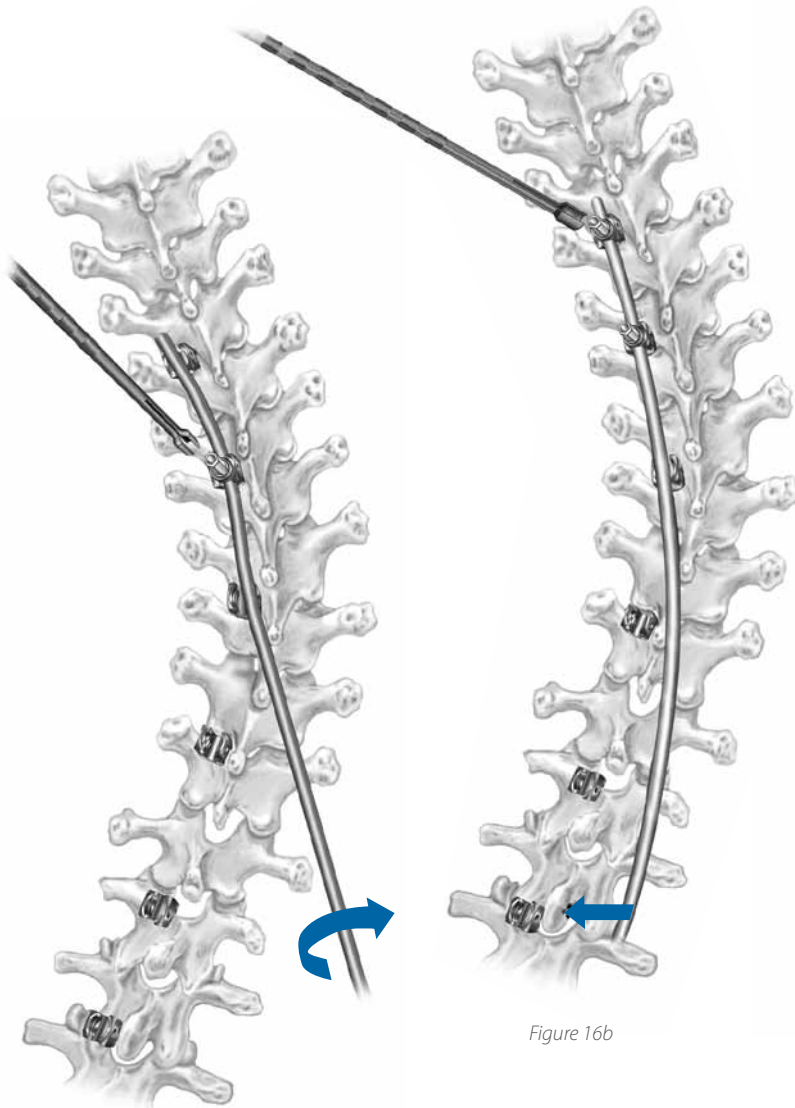

Figure 16a

Figure 16b

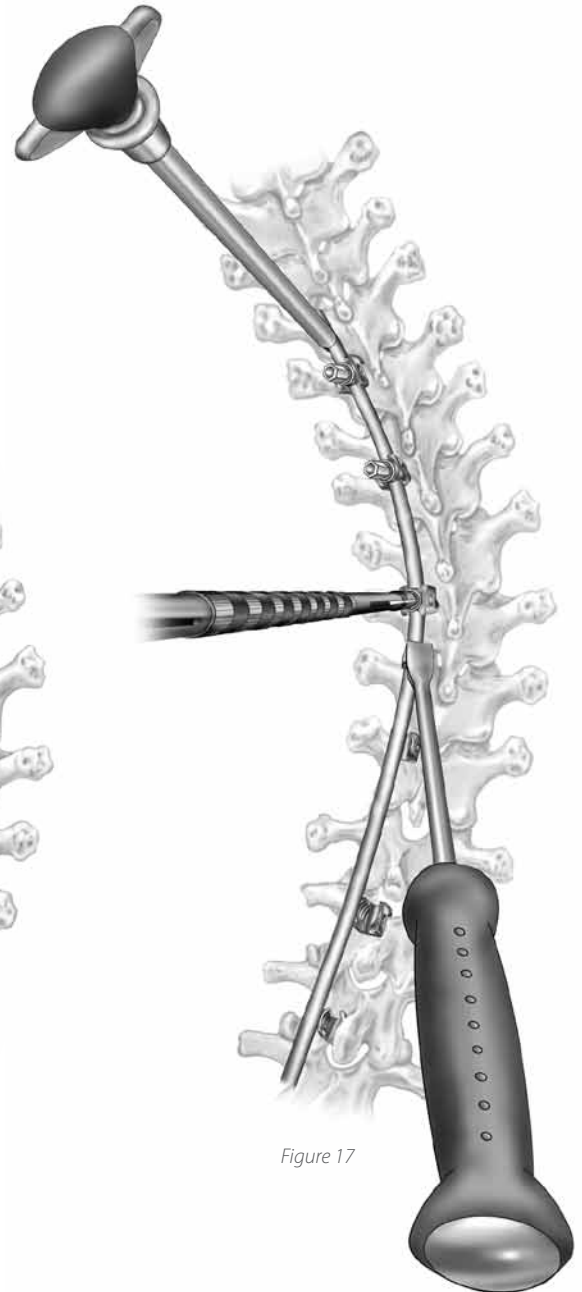

Figure 17

Rod Reduction

STEP 7

There are several methods and instruments that may be used to facilitate rod reduction and to fully seat the rod into the saddle of the implants. Depending on the method and instruments used to reduce the rod, the set screws will be inserted with either the Plug Starter or the Provisional Driver.

Forceps Rocker Method

Use of the Forceps Rocker is an effective method for reducing (or seating) the rod into the implant when only a slight height difference exists between the rod and the implant saddle. To use the Forceps Rocker, grasp the sides of the implant with the rocker cam above the rod and the Forceps tips facing the same direction as the hook blade (**Figure 18**). This angle will avoid dislodgment of the hook. Lever the Forceps Rocker backwards over the rod to seat the rod into the saddle of the implant. The levering action allows the rod to be fully seated in the saddle of the implant. The Dual Ended Plug Starter is then used to place the set screw (**Figure 19**).

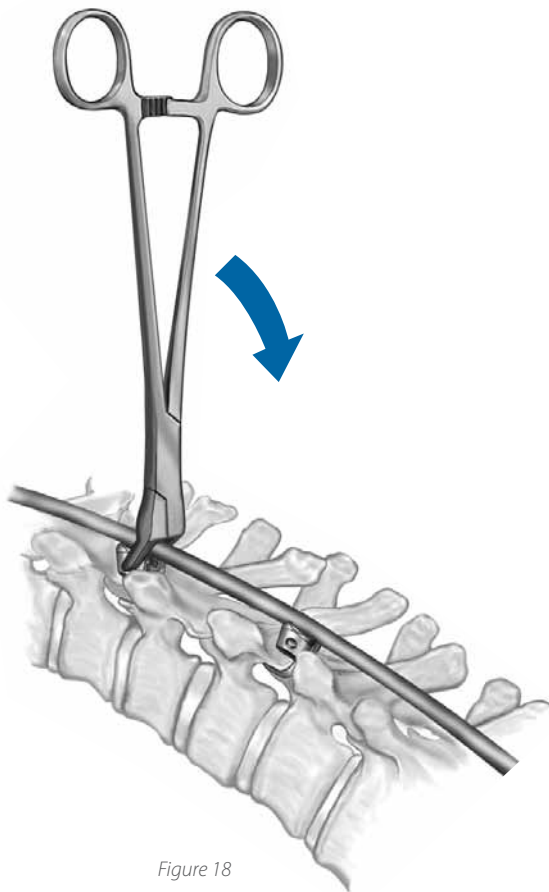

Figure 18

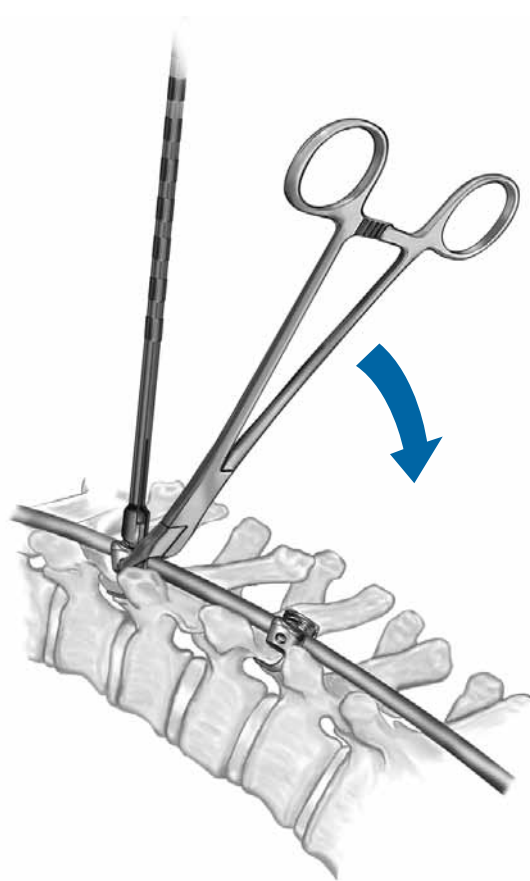

Figure 19

Rod Reduction *continued*

STEP 7

Beale Rod Reducer

In situations where the rod rests at the top of the implant, the Beale Rod Reducer may be used to seat the rod. The reducer is placed over the implant with the ratchet portion parallel to the rod. The reducer is then slowly closed by squeezing the handles together, allowing the attached sleeve to slide down and seat the rod into the saddle of the implant (**Figure 20**). A set screw is then placed through the set screw tube of the reducer using the Provisional Driver (**Figure 21**).

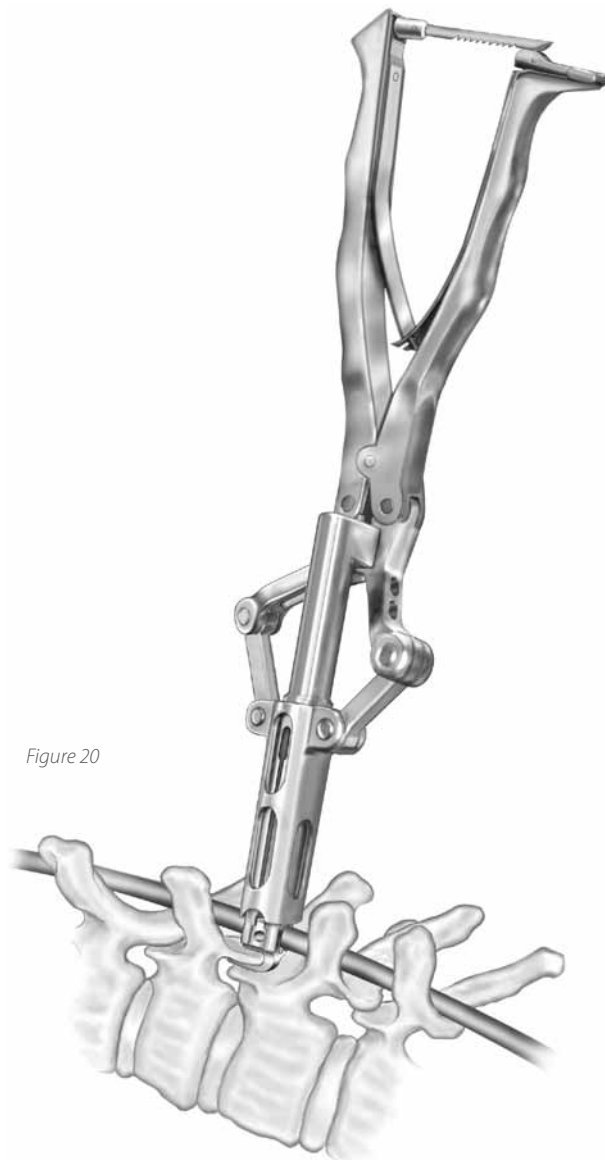

Figure 20

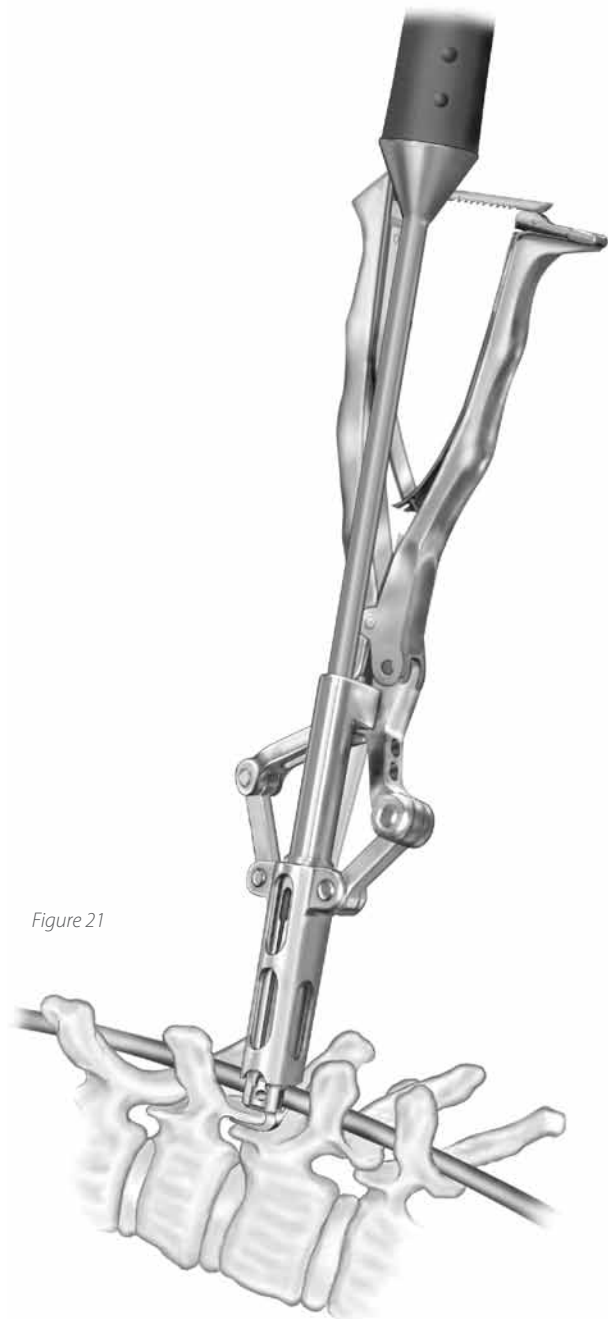

Figure 21

Rod Reduction *continued*

STEP 7

Lateral Translator

If the rod lies medial or lateral to the implant, the Translator provides translational capabilities. Attach the tines of the Translator Implant Holder to the side of the implant (**Figure 22**). To assemble the Translator Rod Pusher with the Translator Implant Holder, insert the coupling sleeve axles of the Translator in the Implant Holder guide by pulling up on the spring-loaded tube (**Figure 23**).

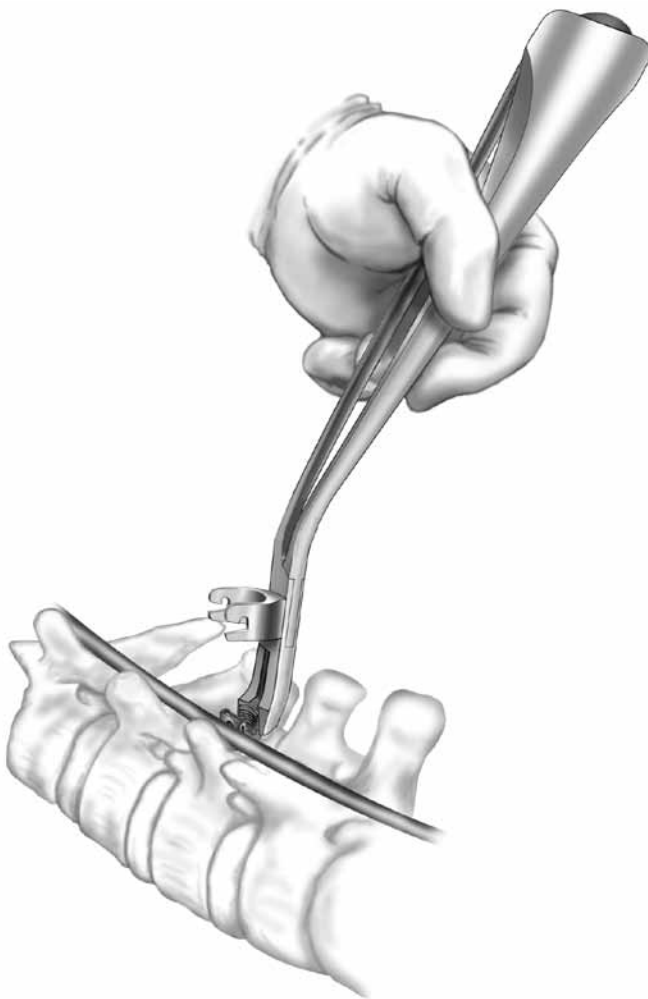

Figure 22

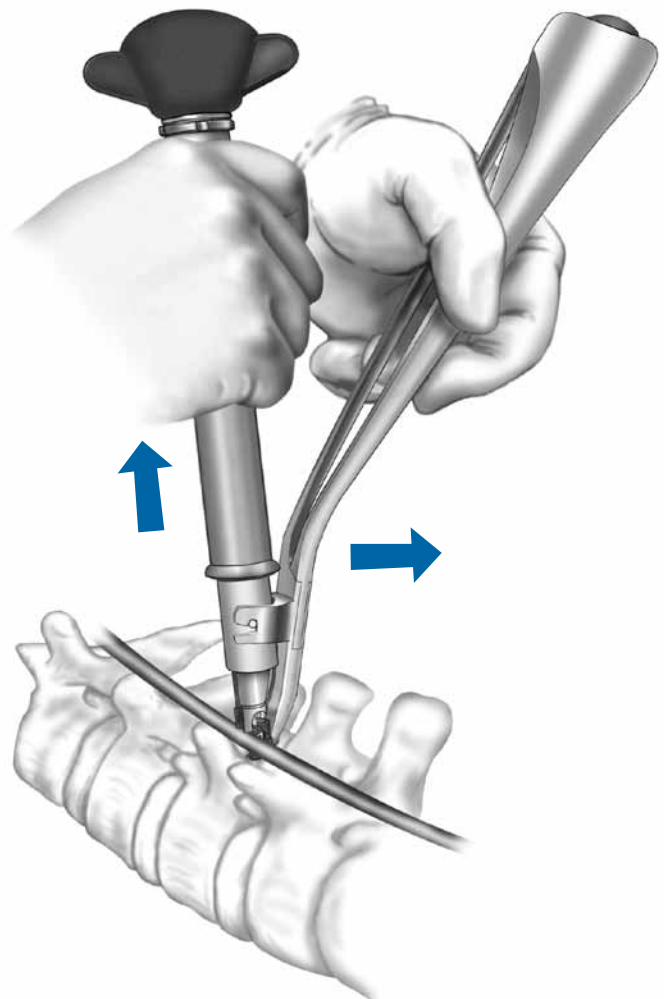

Figure 23

Rod Reduction *continued*

STEP 7

The spring-loaded design of the Translator Rod Pusher allows translation of the rod until it is over the head of the implant (Figure 24).

With the rod over the implant, turn the T-handle at the top of the Translator Rod Pusher clockwise until the rod is fully seated into the saddle of the implant (Figure 25). Using the Provisional Driver, slide a set screw down the center of the Translator Rod Pusher and tighten.

When the rod lies far lateral to the implant, in situ bending of the rod can be carried out to bring the rod closer to the implant and allow use of the Translator.

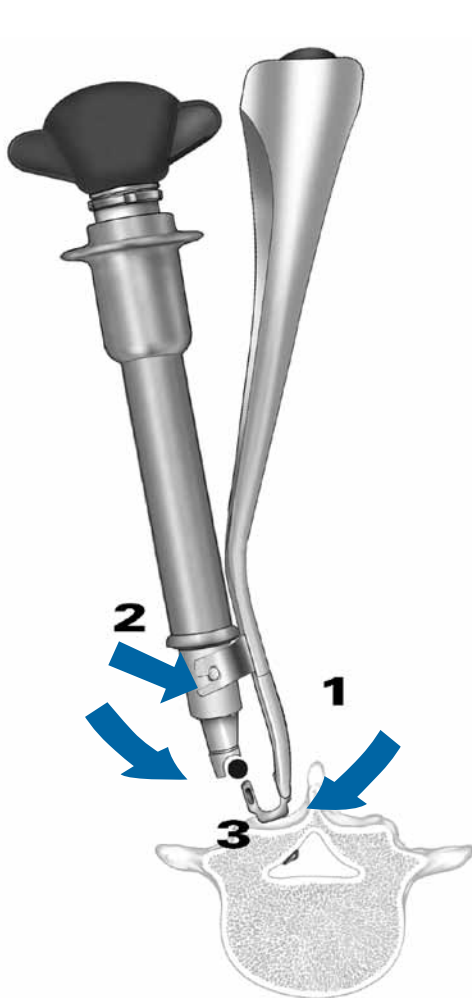

Figure 24

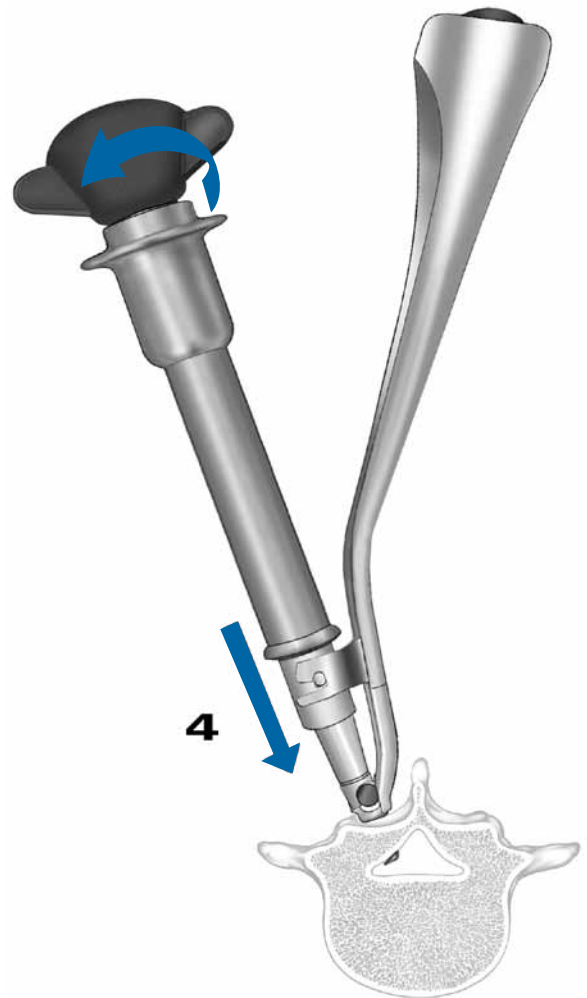

Figure 25

Deformity Correction

STEP 8

At this point of the surgery part of the correction has been achieved, mainly due to translation maneuvers used when inserting the rod. Further correction can be accomplished with rod rotation and/or in situ bending, depending on the type and stiffness of the curve, and completed with compression/distraction maneuvers.

Rod Rotation

Once the contoured rod and all of the set screws have been placed, the rod is ready to be rotated into its final position. The rotation must be done slowly in order to prevent rapid neurologic changes and/or injury to the spinal cord. The rotation is done using two Rod Grippers (**Figure 26**). It is important to monitor the interval hooks, which tend to back out during rod rotation. Several methods are proposed: use of the C-Shaped Rod Pusher, the placement of C-rings on the rod prior to rotation, placement of the Rod Gripper on the rod just below the hook to buttress it, or the use of a hook stabilizer instrument, which is available upon special ordering request.

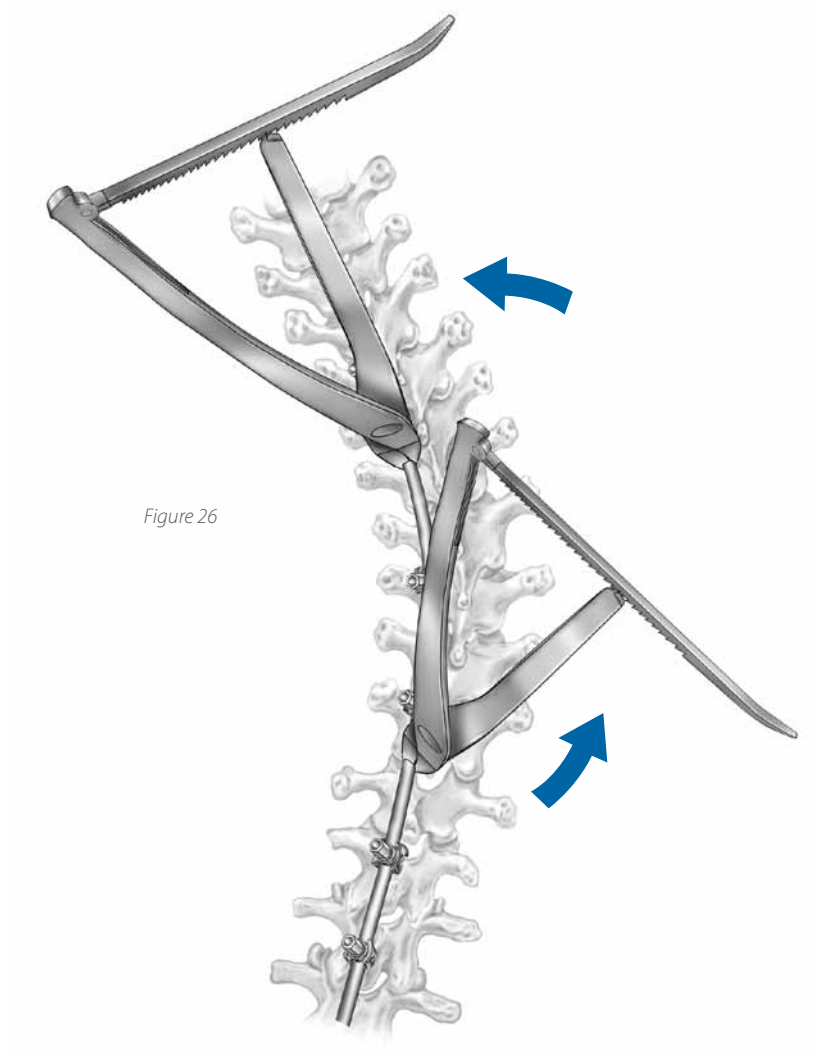

Deformity Correction *continued*

STEP 8

Once the rotation of the rod is complete and the position of the hooks is verified, the interval hooks' set screws are provisionally tightened to prevent rod derotation. The hooks should be checked following all rotation maneuvers and the necessary adjustments made to ensure that proper placement is maintained. At this point, the rod should be fully seated into the saddle of all of the implants.

In Situ Bending

In Situ Benders may be used for correction and final adjustment of the rod in the sagittal and/or coronal plane. The rod is bent in small incremental steps using the two bender tips positioned near each other on the rod (**Figure 27**).

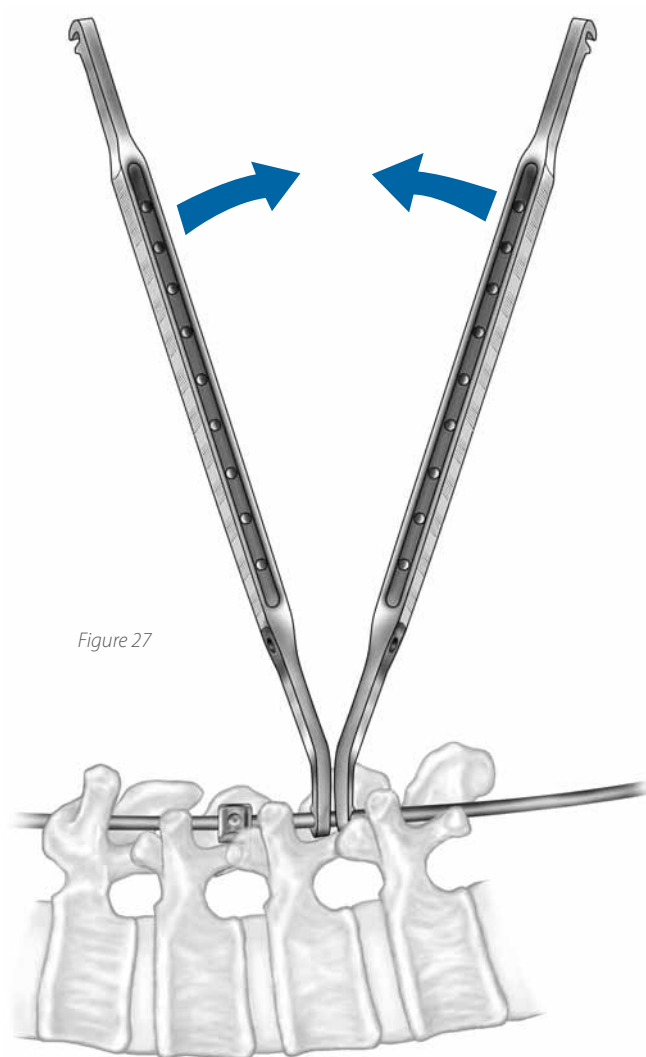

Compression/Distraction

STEP 9

Once the rod is secured in the implants, distraction and/or compression are performed to place the hooks in their final position. The Parallel Compressor, Distractor, Provisional Driver, and Rod Gripper are used to carry out these maneuvers. It is recommended to use the Rod Gripper as a stop for distraction maneuvers rather than the implant (**Figure 28**), with the exception of the inverted claw. Compression maneuvers are most often carried out directly on two hooks (**Figure 29**). Care should be taken to ensure that the foot of either instrument is placed against the implant body and not against the set screw. It is preferred that compression be released just prior to the set screw being broken off or final tightened. This technique will help ensure that the implant head and rod are normalized to one another, and thus, allows for the rod to be fully seated in the implant head during the final tightening step. After these maneuvers are complete, the set screw is tightened with the Provisional Driver.

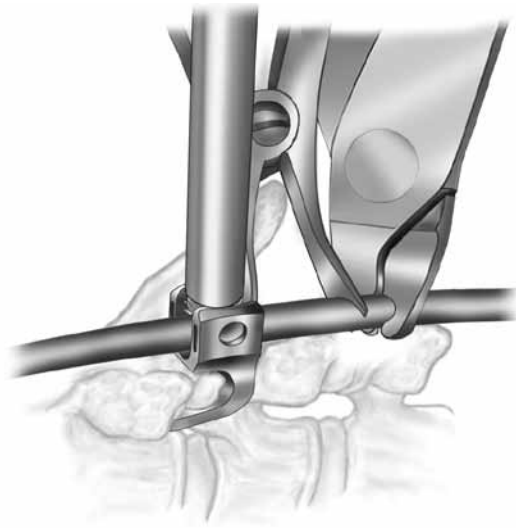

Figure 28

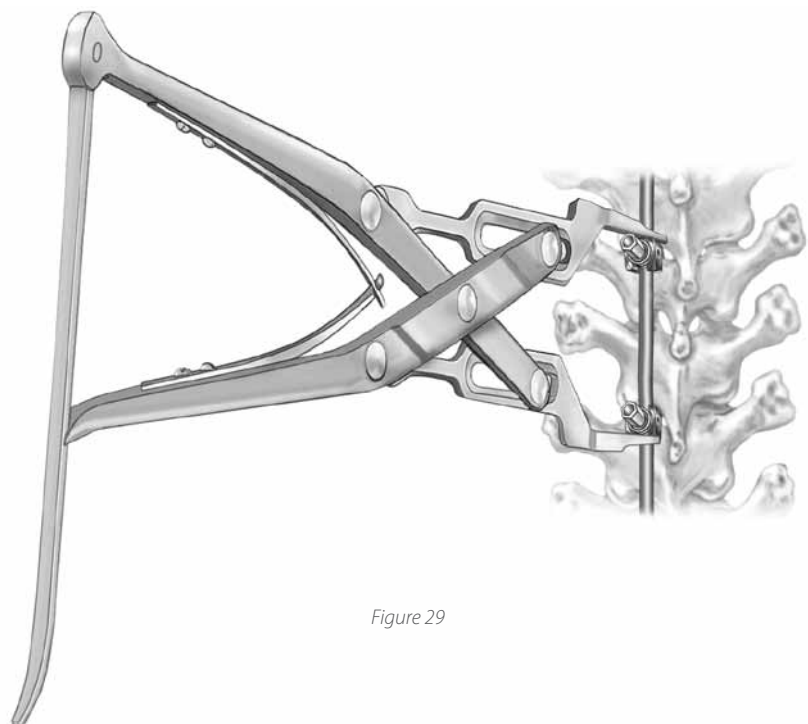

Figure 29

! Important

It is highly recommended that the set screw not be broken off or final tightened under compression.

Stabilization/Holding Rod Placement

STEP 10

With the completion of the deformity correction and the seating of the correction rod, the opposite side of the construct is prepared. Measure the length for the stabilizing rod, then cut. Using the French Bender (shown on page 16), contour the rod according to the curvature of the spine and the residual position of alignment from the correction rod. Place the contoured rod into the hooks and provisionally secure the rod with set screws (**Figure 30**). Once the rod is secured to the implants, distraction and/or compression are performed to place the hooks in their final position. Refer to Step 9 to ensure the appropriate steps are followed. It is highly recommended that the set screw not be broken off or final tightened under compression.

✓ Note

The spine may be decorticated to carry out the bone fusion and morselized cancellous bone placed along the decorticated spine, extending out over the transverse processes.

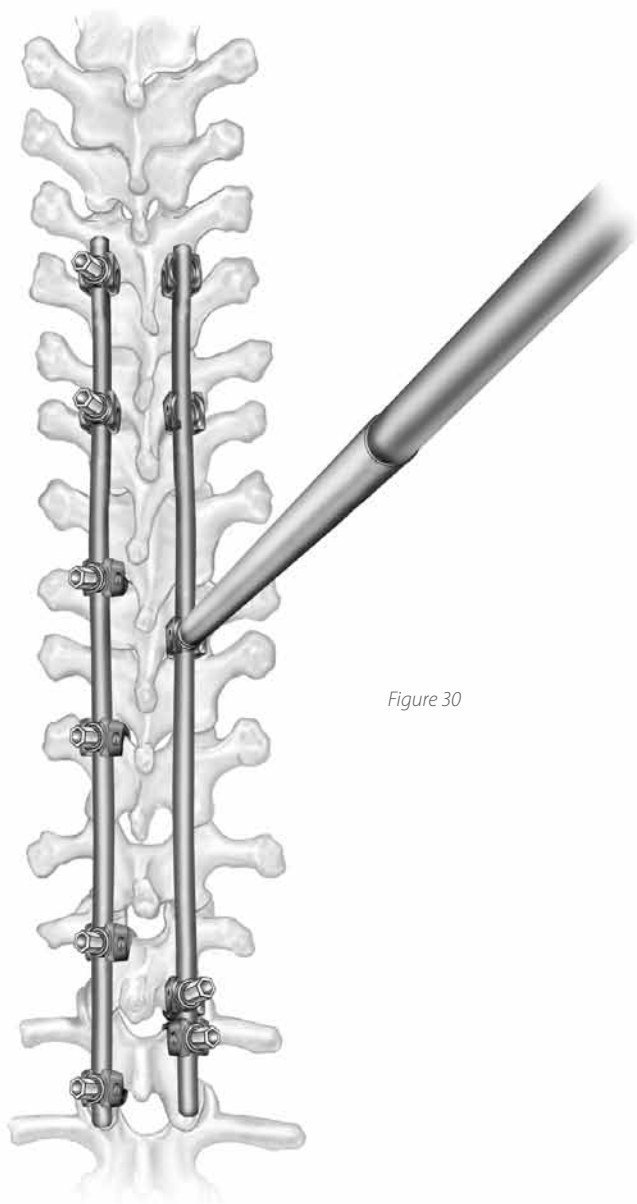

Figure 30

Final Tightening

STEP 11

When all implants are securely in place and the rod fully seated, final tightening and/or break-off of the set screw heads is performed.

Set Screw Break-Off

The Counter Torque instrument is placed over the implant and the rod (**Figure 31**). The Break-Off Driver is then placed through the cannulated Counter Torque. The Self-Retaining Break-Off Driver provides adequate leverage for breaking the

set screw heads. The handle of the Counter Torque device should be held firmly to prevent torquing of the construct while the set screw is secured and sheared off (**Figure 32**). The broken-off part of the set screw is captured in the cannulated portion of the Self-Retaining Break-Off Driver. Following final tightening, the sheared-off portions of the set screws accumulated in the driver are removed using the T27 Obturator shaft (**Figure 33**).

Non-Break-Off Set Screws

The CD HORIZON® LEGACY™ Spinal System offers the possibility of using Non-Break-Off Set Screws. The final tightening maneuver is equivalent to that performed on the Break-Off Set Screws using the Counter Torque to avoid torquing of the construct. A torque wrench screwdriver is used to tighten the Non-Break-Off Set Screws and to ensure a consistent torque.

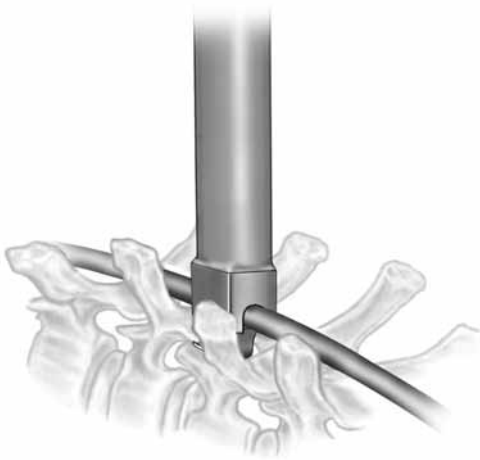

Figure 31

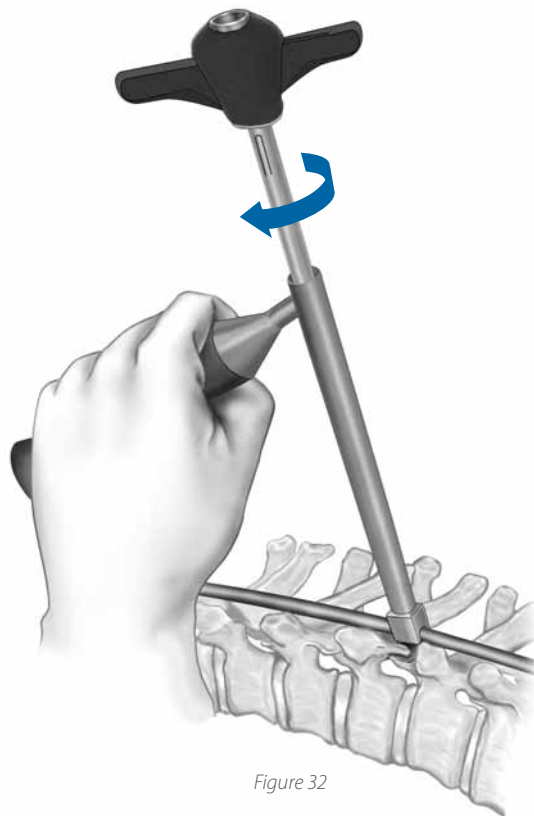

Figure 32



Figure 33

Transverse Link Placement/Closure

STEP 12

Once final tightening of the set screws is completed, it is mandatory that transverse links be placed to provide rotational stability to the construct. A framed construct resists rotational forces. Ideally, the transverse links should be placed close to the construct extremities. Three transverse link systems are available: the DLT System (EU), the Low Profile CD HORIZON® CROSSLINK® Plate, and the CD HORIZON® X10 CROSSLINK® Plate.

The DLT System is available for compression and distraction, due to its free hook. It is placed on the rod with the help of the DLT Holder, and the hooks are then pushed either by the Compressor or the Spreader, depending on the chosen model.

The CD HORIZON® X10 CROSSLINK® Plate is low profile and ideal for use in the thoracic region (**Figure 34**). When using the CD HORIZON® X10 CROSSLINK® Plate, please refer to the surgical technique.

Following transverse link placement, wound closure is performed in the customary manner.

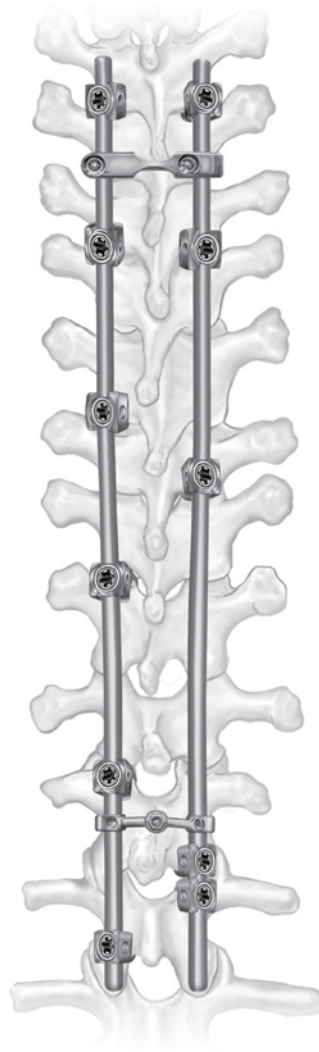

Figure 34



Pedicle Screw Surgical Technique

Thoracic Facetectomy/Starting Points

STEP 1

Clean the facet joints and perform a partial inferior articular process osteotomy to enhance visualization and fusion. Remove 3mm to 5mm of the inferior facet and denude the articular cartilage on the superior facet, except for the lowest vertebra to be instrumented. This will allow for the intraoperative localization of the thoracic pedicle screw starting points (**Figure 35**).

Anatomic starting points vary by the posterior elements that can be observed intraoperatively. These include the transverse process, the lateral portion of the pars interarticularis, and the base of the superior articular process.

After a thorough exposure, use as much anatomic information as possible by starting with a neutral, non-rotated vertebra. The lateral and posterior views shown on the following page in **Figure 36** can be used as a guide for starting points and screw trajectory.

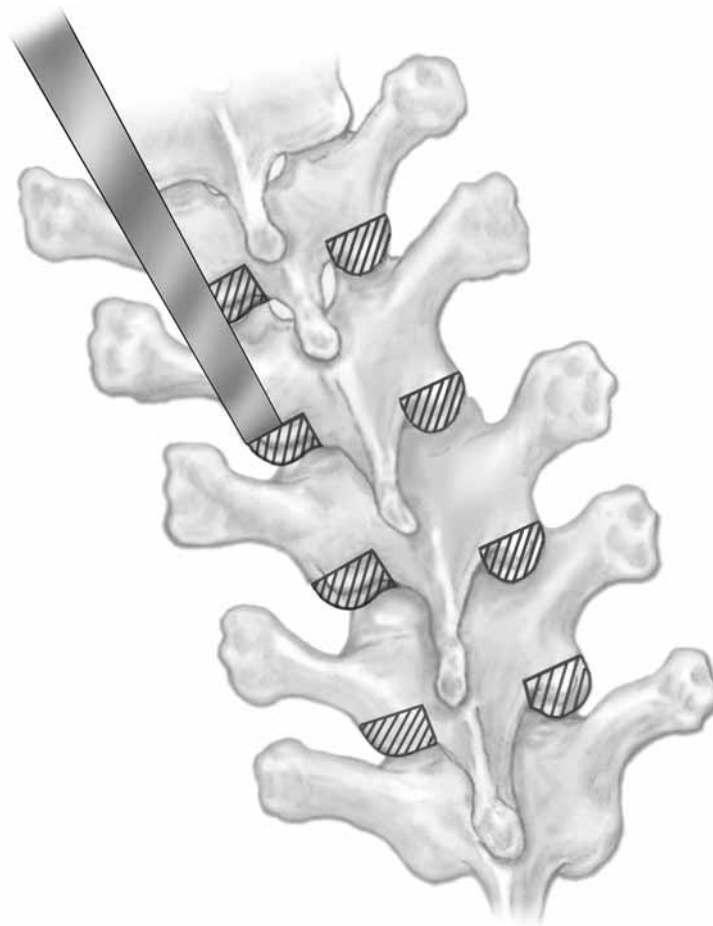

Figure 35

Thoracic Pedicle Screw Starting Points

STEP 2

Use Fixed Angle or Multi-Axial Screws for the straightforward approach (Blue Pins). Use Multi-Axial Screws only for the anatomic approach (Green Pins).

Tear Here

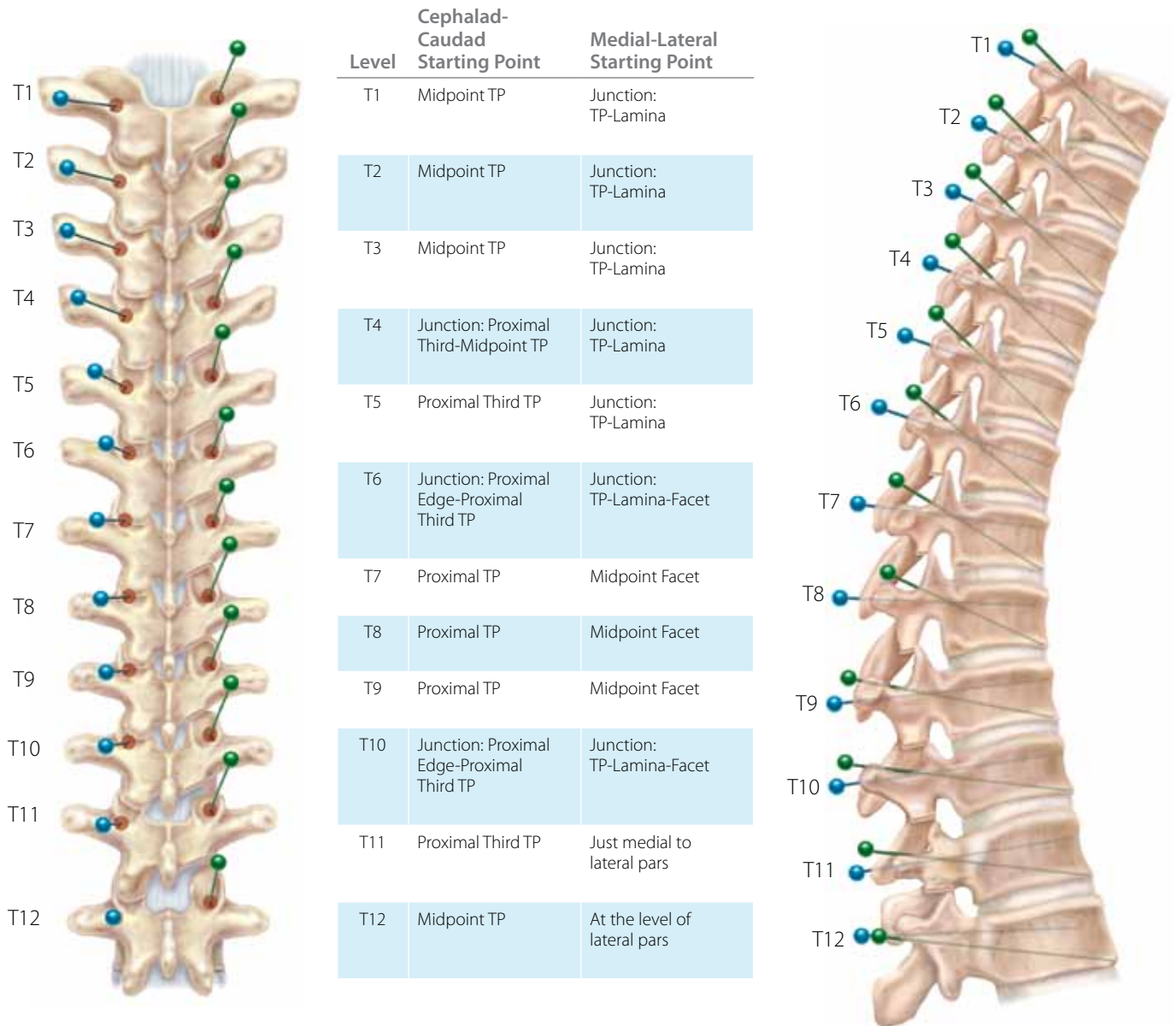

Figure 36

Pedicle Preparation

STEP 3

Create a 3mm-deep posterior cortical breach with a high-speed burr. A pedicle blush may be visualized suggesting entrance into the cancellous bone at the base of the pedicle. Occasionally, when preparing small pedicles located at the apex of the curve, the blush will not be evident due to the limited intrapedicular cancellous bone. In this case, use the Thoracic Ball Handle Probe to search in the burred cortical breach for the soft, funnel-shaped cancellous bone, which indicates the entrance to the pedicle. The tip should be pointed laterally to avoid perforation of the medial cortex (**Figure 37**).

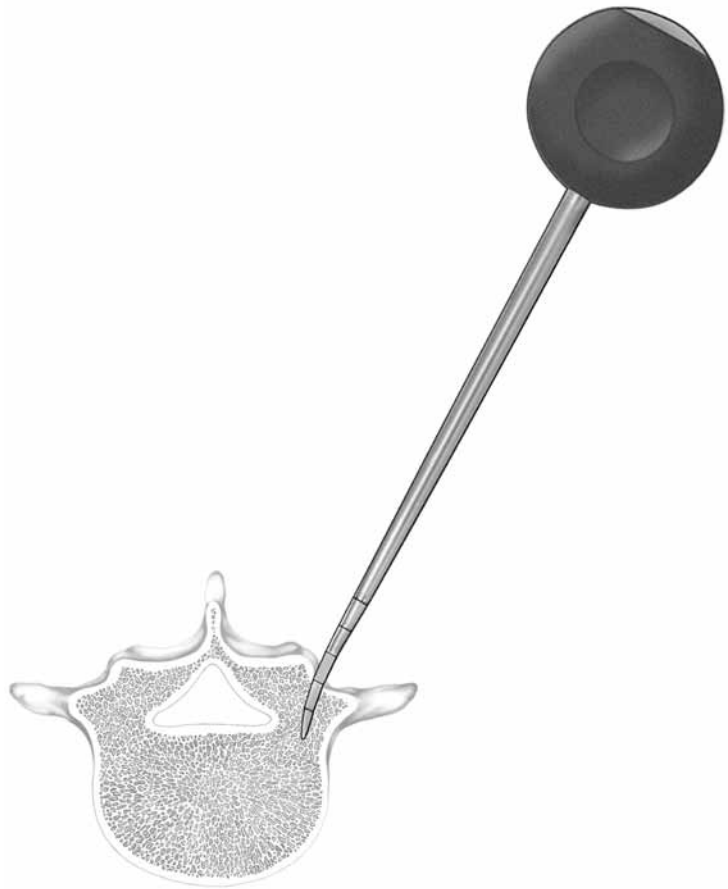

Figure 37

Pedicle Preparation *continued*

STEP 3

Grip the side of the handle to avoid applying too much ventral pressure. Insert the tip approximately 20mm to 25mm (**Figure 38**), and then remove the probe to reorient it so that the tip points medially. Carefully place the probe into the base of the prior hole and use the instrument markings to advance the probe to the desired depth (**Figure 39**). Rotate the probe 180° to ensure adequate room for the screw.

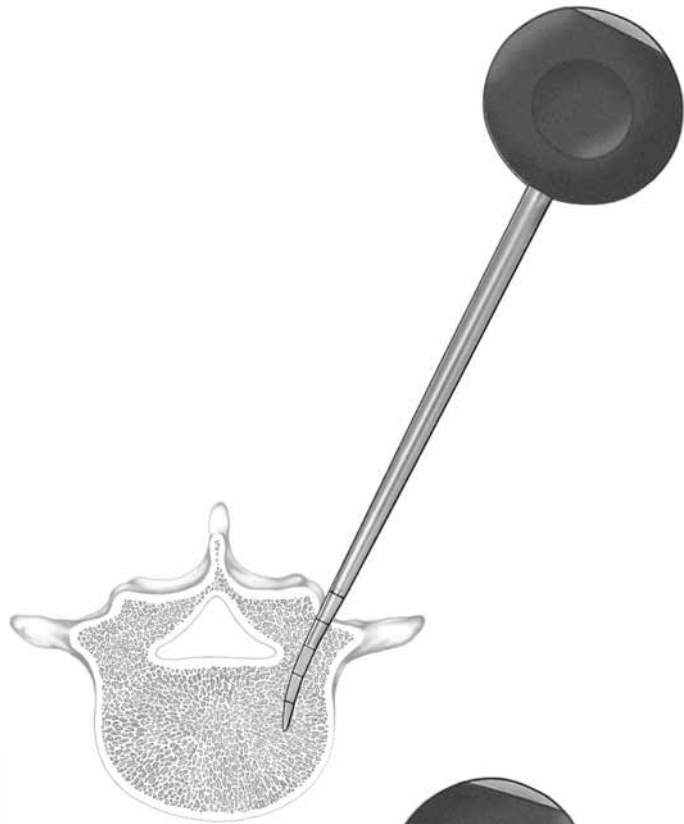

Figure 38



Figure 39

Pedicle Preparation *continued*

STEP 3

Check to ensure that only blood is coming out of the pedicle and that the bleeding is not excessive. Using a flexible ball-tipped probe, advance a Sounding/Feeler Probe to the base (floor) of the hole to confirm five distinct bony borders: a floor and four walls (medial, lateral, superior, and inferior) (**Figure 40**). Give special care to the first 10 to 15mm of the tract. Cortically breached pedicles may be salvageable. When necessary, place bone wax in the pedicle hole to limit bleeding, then reposition the probe with a more appropriate trajectory.

Next, undertap the pedicle by 0.5mm to 1.0mm of the final screw diameter (**Figure 41**). Palpate the tapped pedicle tract with a flexible Sounding/Feeler Probe. Clamp a hemostat to the exposed Sounding/Feeler Probe and measure the length of the hole (**Figure 42**). Select the appropriate screw diameter and length by both preoperative measurement and intraoperative observation.

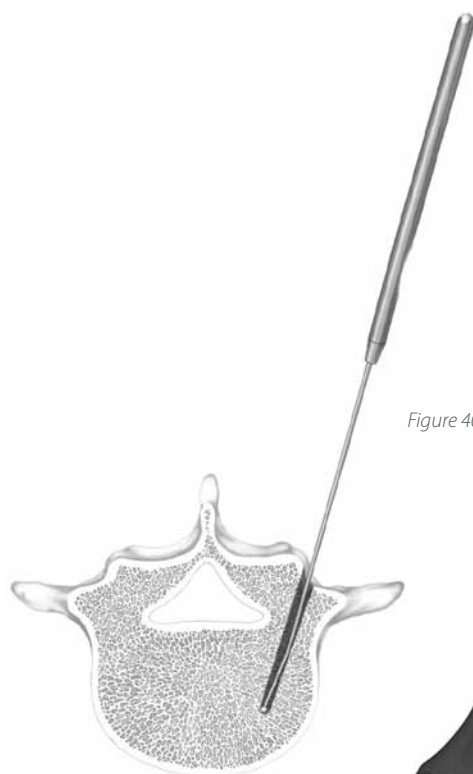

Figure 40



Figure 41

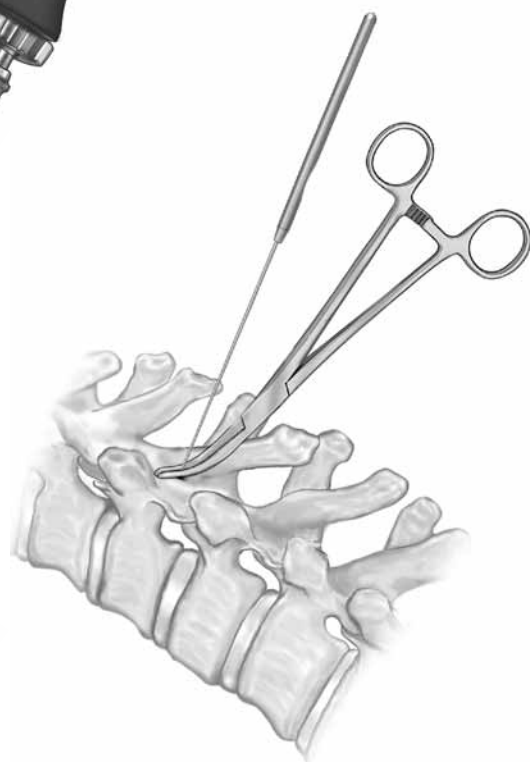

Figure 42

Screw Placement

STEP 4

Thread a screw onto either the Fixed Angle or Multi-Axial Screwdriver and slowly advance the screw down the pedicle to ensure proper tracking while allowing for viscoelastic expansion (**Figures 43a and 43b**). Screws should be placed at every segment on the correction side and every third or fourth level on the supportive side. Insert at least two screws at the proximal and distal end of the supportive side. For some pathologies, such as kyphosis, more screws are placed for greater construct rigidity. Screws should be checked radiographically at this time to ensure intraosseous screw placement.



Figure 43a

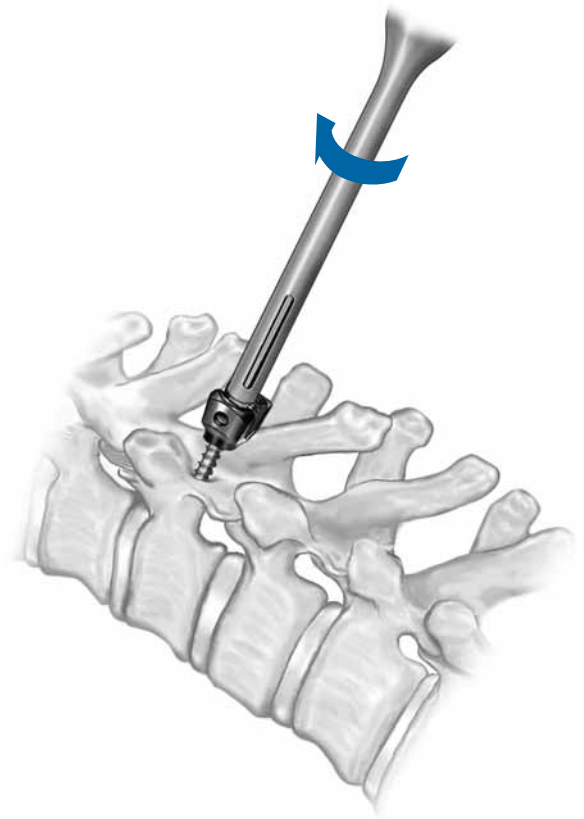

Figure 43b

Rod Contouring/Placement

STEP 5

Once correct screw placement has been verified radiographically, measure and contour rods in the sagittal and coronal planes. The rods have an orientation line that serves as a reference point during contouring. Clamping the rod with Rod Grippers at both ends helps prevent the rod from rotating during contouring (**Figure 44**).

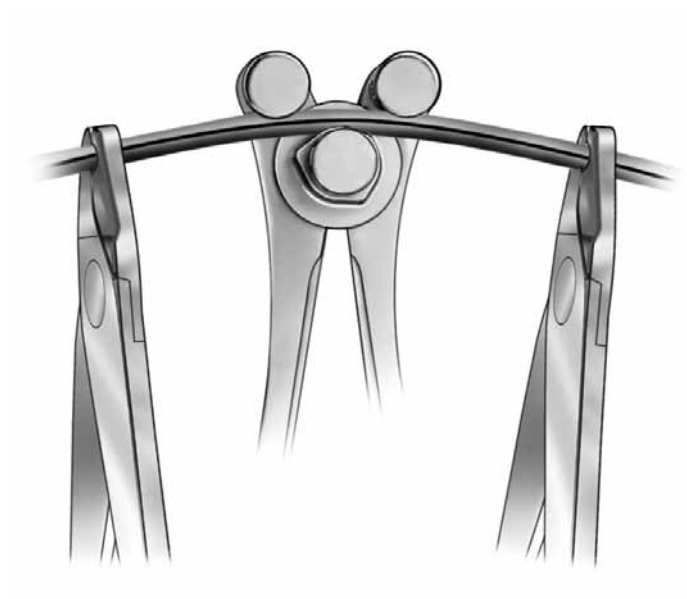

Figure 44

Rod Reduction

STEP 6

For non-hyperkyphotic deformities, place the rod on the concavity first. The contoured rod is placed into the previously placed screws. There are several methods and instruments that can facilitate fully seating the rod into the saddle of the implant. NOTE: Care should be taken with any of the following reduction methods. Improper instrument use may loosen implants or damage the residual facets and other bony anatomy.

Rocker Method

Use of the Forceps Rocker is an effective method for reducing (or seating) the rod into the implant when only a slight height difference exists between the rod and the implant saddle. To use the Forceps Rocker, grasp the sides of the implant with the rocker cam above the rod (**Figure 45**) and then lever backwards over the rod. The levering action allows the rod to be fully seated into the saddle of the implant. The Dual Ended Plug Starter is then used to introduce the set screw (**Figure 46**).

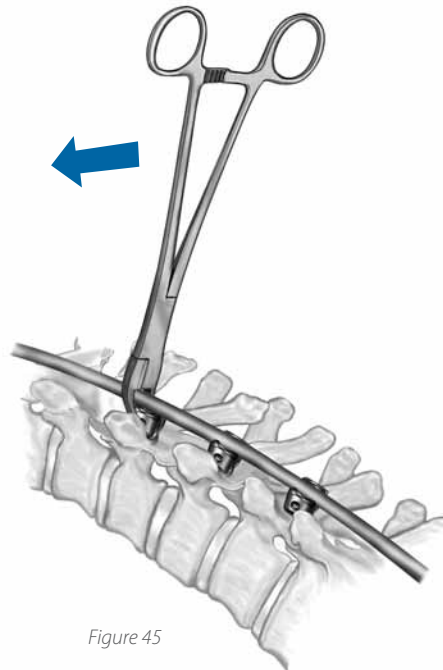

Figure 45

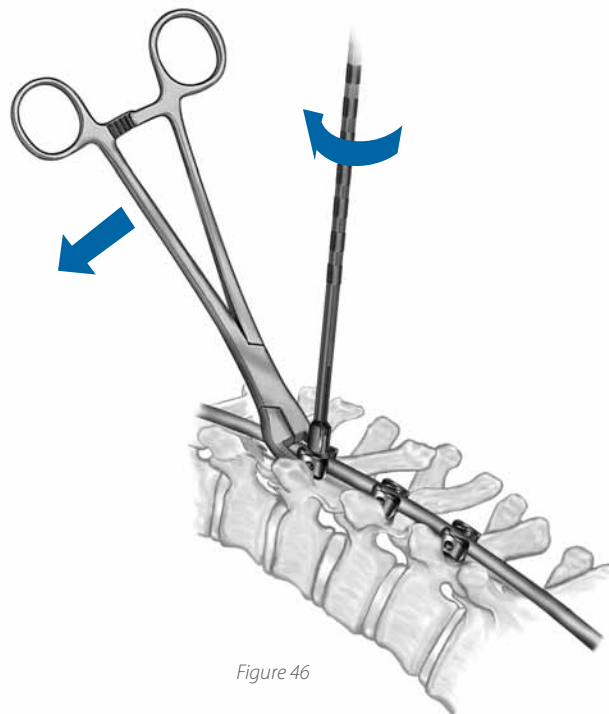

Figure 46

Rod Reduction *continued*

STEP 6

Beale Rod Reducer

In situations where the rod rests at the top of the implant, the Beale Rod Reducer may be used to seat the rod. The reducer is placed over the implant with the ratchet portion parallel to the rod (**Figure 47**). The reducer is then slowly closed, allowing the attached sleeve to slide down and seat the rod into the implant saddle. A set screw is then placed through the plug tube with the Dual Ended Plug Starter and provisionally tightened with the Provisional Driver (**Figure 48**).

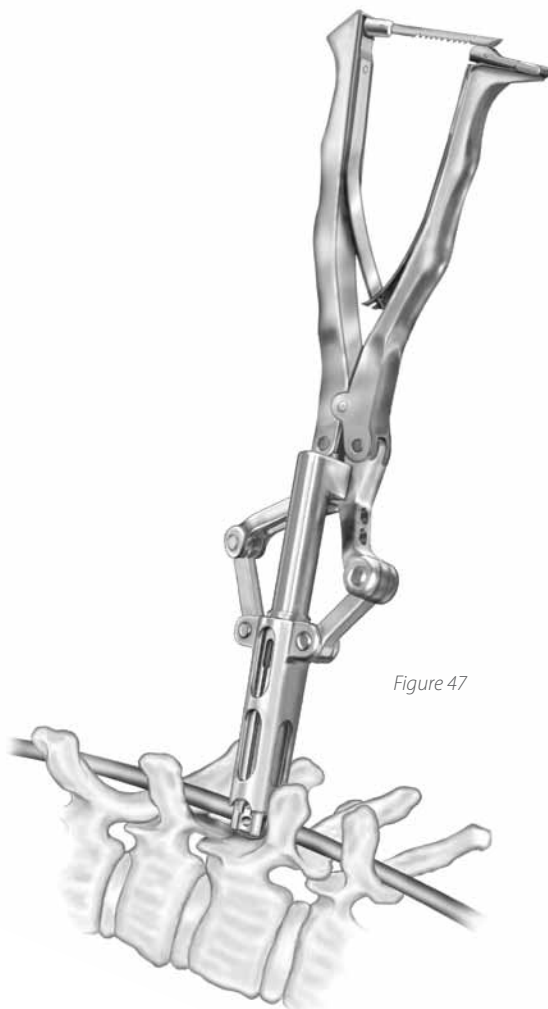

Figure 47

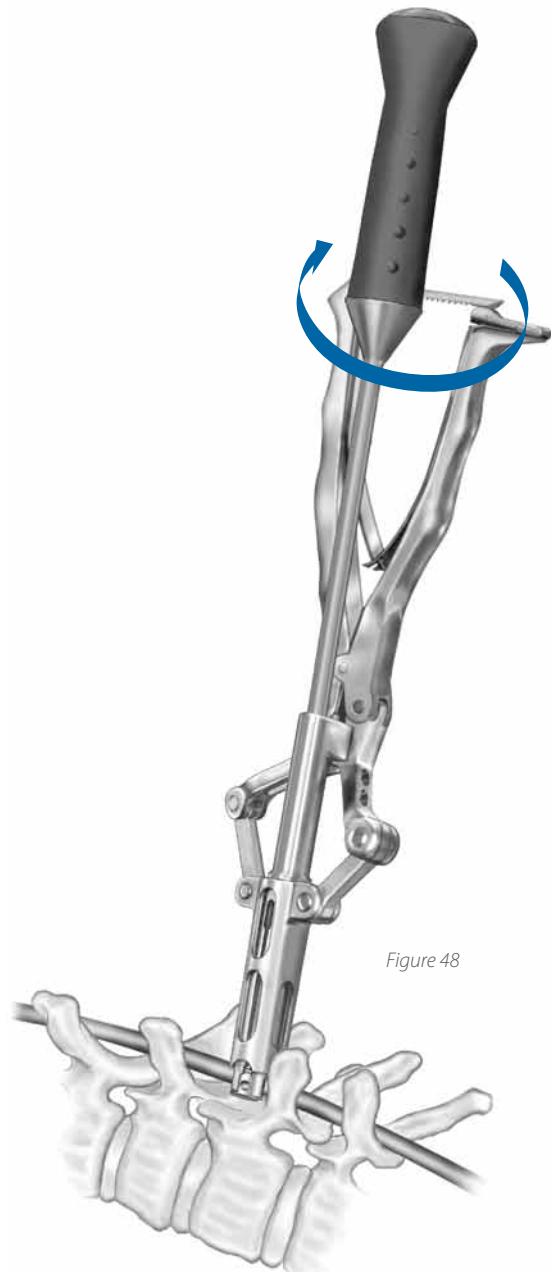

Figure 48

Deformity Correction

STEP 7

The set screws are kept loose (or only locked at one end), then the concave rod is slowly straightened with the left and right Coronal Benders. Each straightening of the concave rod is performed over a pedicle screw. Several passes may be required in order for viscoelastic relaxation with subsequent curve correction to occur (**Figure 49**). Tighten the apical set screws and perform the appropriate compression or distraction (**Figure 50**). Watch the screw/bone interface with all correction maneuvers.

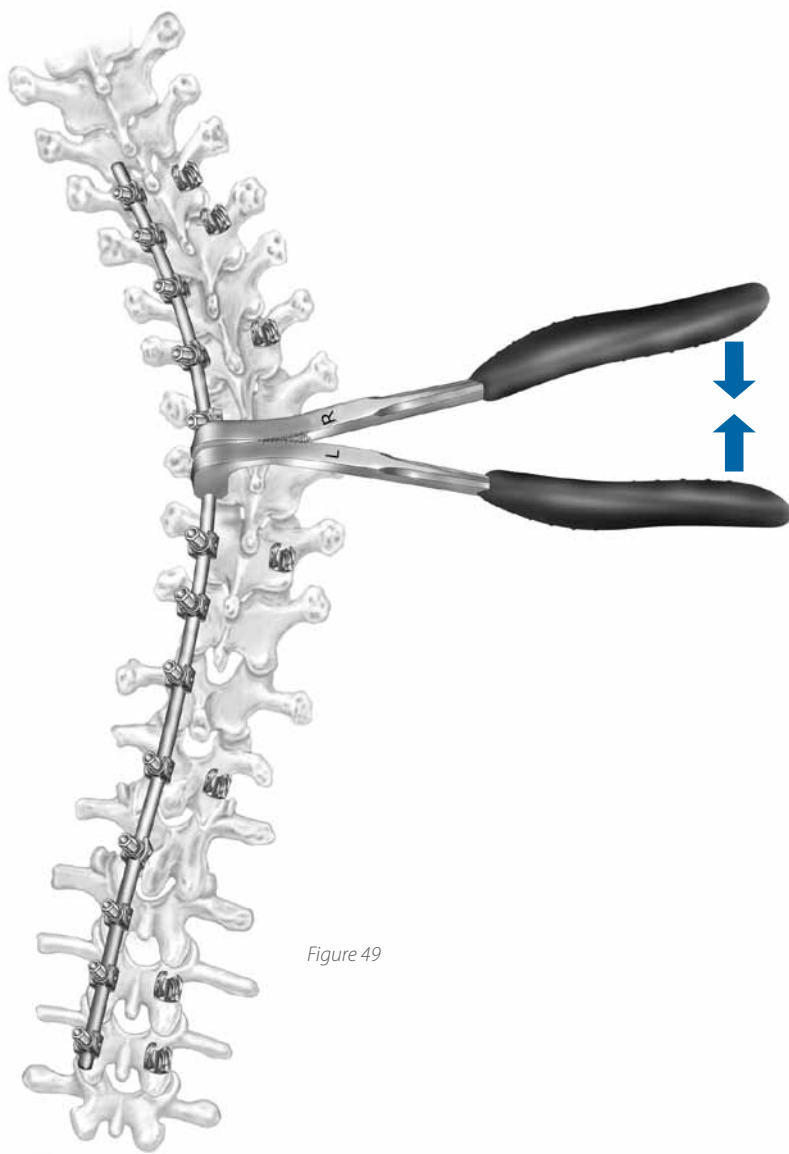

Figure 49

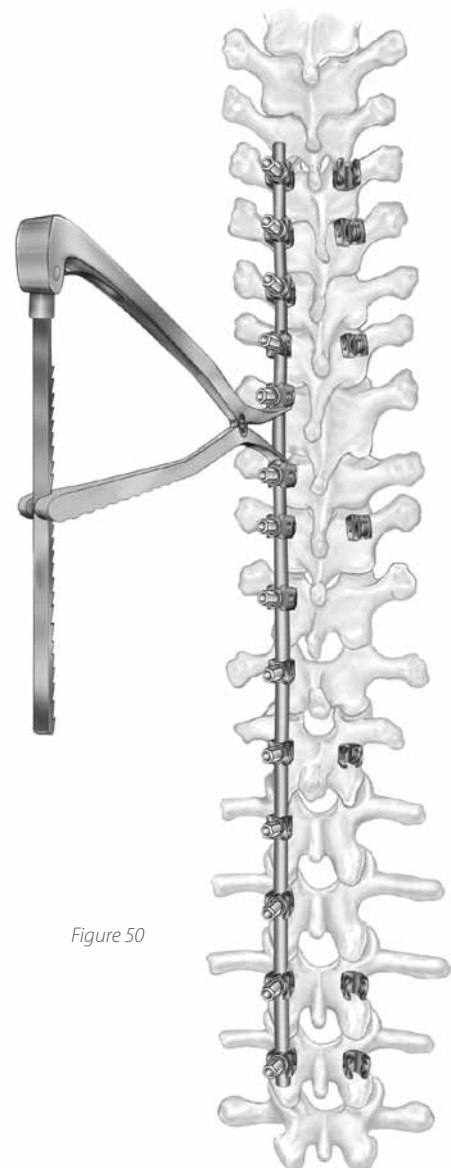

Figure 50

Deformity Correction *continued*

STEP 7

Placing the Stabilizing Rod

Following placement of the second rod and set screws (Figure 51), convex compressive forces are placed on the segments using the Parallel Compressor to horizontalize the lowest instrumented vertebra and mildly compress the convexity of the deformity (Figure 52). It is preferred that compression be released just prior to the set screw being broken off or final tightened. This technique will help

ensure that the implant head and rod are normalized to one another and thus allow for the rod to be fully seated in the implant head during the final tightening step. NMEP and/or SSEP monitoring are performed to detect slow progressions of neurologic deficits.

Fixation is verified with A/P and lateral x-rays to confirm spinal correction and alignment.

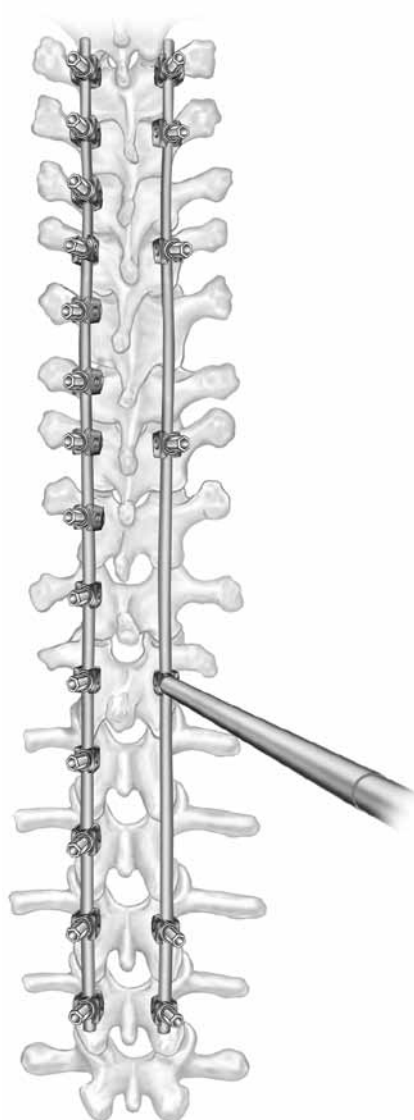

Figure 51

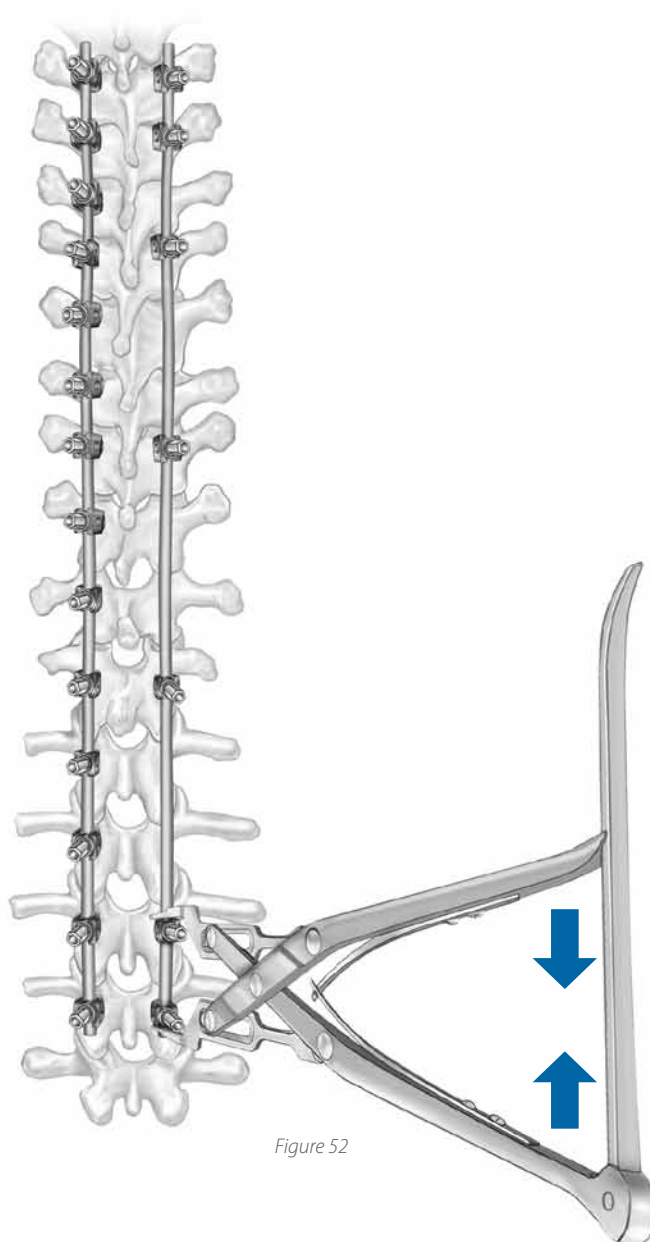

Figure 52

Final Tightening/Decortication/CD HORIZON® X10 CROSSLINK® Plate Placement

STEP 8

Using the Counter Torque and the Self-Retaining Break-Off Driver, the set screws are sheared off, which locks the rods into place (**Figure 53**).

The posterior elements are decorticated with a burr and the bone graft is placed. The CD HORIZON® X10 CROSSLINK® Plates should be placed at the proximal and distal ends of the construct (**Figure 54**). Refer to the CD HORIZON® X10 CROSSLINK® Plate Surgical Technique for placement steps.

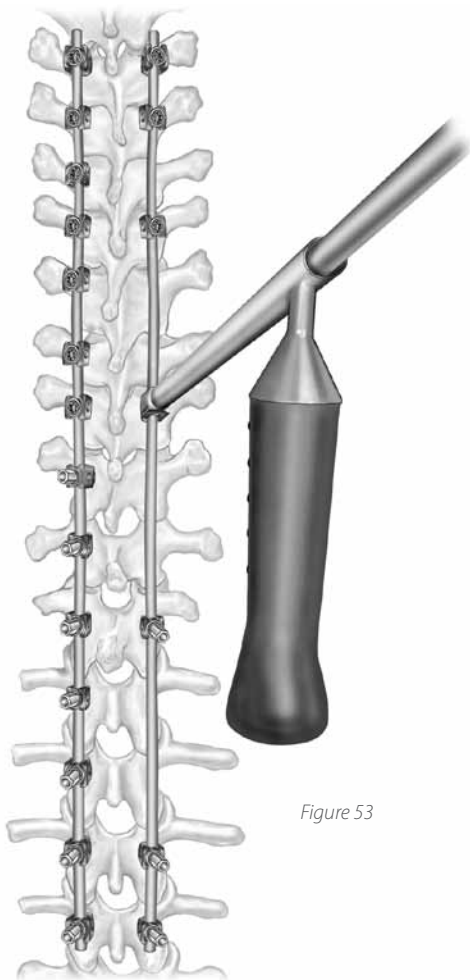
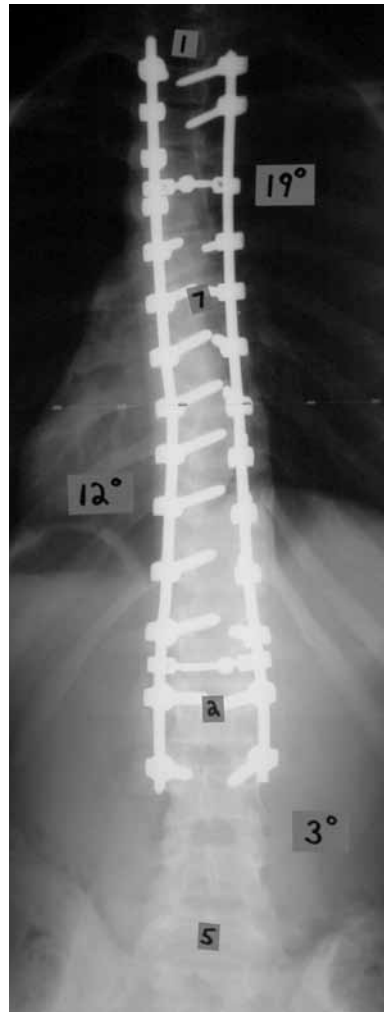
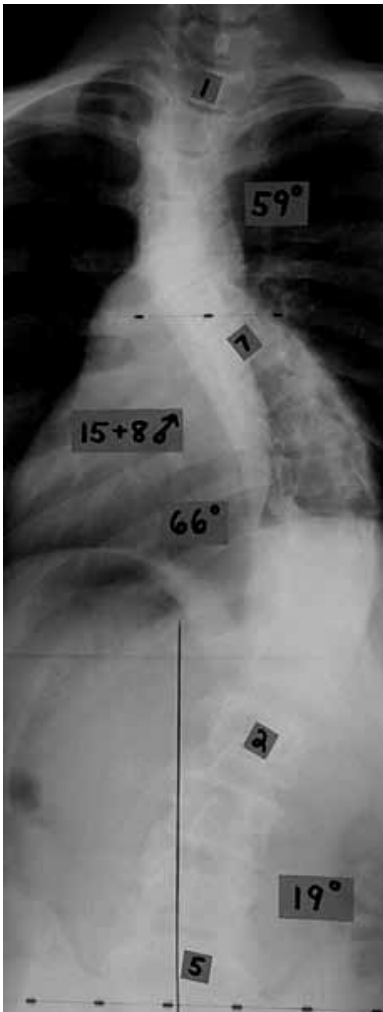

Figure 53



Figure 54

Case Presentation



Case Description: Lenke 2AN, AIS

System Used: CD HORIZON® LEGACY™ Spinal System with
CD HORIZON® X10 Crosslink® Plates

Correction Maneuvers Used:

- » Segmental cantilever
- » Proximal thoracic compression
- » In situ translation
- » Direct apical derotation (mid-thoracic)
- » Selective compression and distraction to level, centralize, and neutralize the lowest instrumented vertebra

Removal Instructions

CD HORIZON® LEGACY™ Multi-Axial Pedicle Screws can be removed using a 3.5mm Hex Head Driver.

For removal of the set screw once it is broken off, a TORX 27 shaft must be used. The TORX 27 shaft is inserted into the cannulated Break-Off Driver; once the TORX 27 tip is correctly inserted into the set screw, the driver is used for set screw removal.

The TORX 27 print on CD HORIZON® LEGACY™ Spinal System implants is larger than on the standard CD HORIZON® Spinal System implants, allowing easier removal.

The CD HORIZON® LEGACY® X10 CROSSLINK® Plate can be removed with a 3.0mm Hex Head Driver for the set screw and a 7/32" Hex Socket for the central nut.

Product Ordering Information

5.5mm HOOKS

CATALOG NUMBER		DESCRIPTION
Titanium	Stainless Steel	
7541102	7561102	Pedicle Hook, Small
7541103	7561103	Pedicle Hook, Medium
7541104	7561104	Pedicle Hook, Large
7541112	7561112	Wide Blade Hook, Small
7541113	7561113	Wide Blade Hook, Medium
7541114	7561114	Wide Blade Hook, Large
7541122	7561122	Narrow Blade Hook, Small
7541123	7561123	Narrow Blade Hook, Medium
7541124	7561124	Narrow Blade Hook, Large
7541133	7561133	Ramped Thoracic, Wide Blade, Medium
7541142	7561142	Ramped Thoracic, Narrow Blade, Small
7541143	7561143	Ramped Thoracic, Narrow Blade, Medium
7541153	7561153	Lumbar Supralaminar, Medium
7541162	7561162	Lumbar Angled Blade, Small
7541163	7561163	Lumbar Angled Blade, Medium
7541172	7561172	Extended Body Hook, Small
7541173	7561173	Extended Body Hook, Medium
7541174	7561174	Extended Body Hook, Large
7541188	7561188	Thoracic Angled Blade, Right
7541189	7561189	Thoracic Angled Blade, Left
7541198	7561198	Offset Hook, Right
7541199	7561199	Offset Hook, Left

RODS

869-021	868-011	5.5mm x 500mm Hex End Lined Rod
---------	---------	---------------------------------

SET SCREWS

7540020	7560020	5.5mm Break-Off Set Screw
7540120	7560120	5.5mm Non-Break-Off Set Screw

Product Ordering Information *continued*

6.35mm HOOKS

CATALOG NUMBER		DESCRIPTION
Titanium	Stainless Steel	
7641202	7661202	Lipped Pedicle Hook, Small
7641203	7661203	Lipped Pedicle Hook, Medium
7641204	7661204	Lipped Pedicle Hook, Large
7641212	7661212	Lipped Wide Blade Hook, Small
7641213	7661213	Lipped Wide Blade Hook, Medium
7641214	7661214	Lipped Wide Blade Hook, Large
7641222	7661222	Lipped Narrow Blade Hook, Small
7641223	7661223	Lipped Narrow Blade Hook, Medium
7641224	7661224	Lipped Narrow Blade Hook, Large
7641133	7661133	Ramped Thoracic, Wide Blade Hook, Medium
7641143	7661143	Ramped Thoracic, Narrow Blade Hook, Small
7641142	7661142	Ramped Thoracic, Narrow Blade Hook, Medium
7641162	7661162	Lumbar Angled Blade Hook, Small
7641163	7661163	Lumbar Angled Blade Hook, Medium
7641173	7661173	Extended Body Hook, Medium
7641174	7661174	Extended Body Hook, Large
7641188	7661188	Thoracic Angled Blade Hook, Right
7641189	7661189	Thoracic Angled Blade Hook, Left
7641198	7661198	Offset Hook, Right
7641199	7661199	Offset Hook, Left

RODS

969-022	968-021	6.35mm x 500mm Hex End Lined Rod
---------	---------	----------------------------------

SET SCREWS

7640020	7660020	6.35mm Break-Off Set Screw
7640120	7660120	6.35mm Non-Break Off Set Screw

Product Ordering Information *continued*

5.5mm FIXED ANGLE SCREWS

CATALOG NUMBER		DESCRIPTION	CATALOG NUMBER		DESCRIPTION
Titanium	Stainless Steel		Titanium	Stainless Steel	
7543420	7563420	4.5mm × 20mm	7542625	7562625	6.0mm × 25mm
7543425	7563425	4.5mm × 25mm	7542630	7562630	6.0mm × 30mm
7543430	7563430	4.5mm × 30mm	7542635	7562635	6.0mm × 35mm
7543435	7563435	4.5mm × 35mm	7542640	7562640	6.0mm × 40mm
7543440	7563440	4.5mm × 40mm	7542645	7562645	6.0mm × 45mm
7543445	7563445	4.5mm × 45mm	7542650	7562650	6.0mm × 50mm
7543450	7563450	4.5mm × 50mm	7542655	7562655	6.0mm × 55mm
7543455	7563455	4.5mm × 55mm	7543625	7563625	6.5mm × 25mm
7542525	7562525	5.0mm × 25mm	7543630	7563630	6.5mm × 30mm
7542530	7562530	5.0mm × 30mm	7543635	7563635	6.5mm × 35mm
7542535	7562535	5.0mm × 35mm	7543640	7563640	6.5mm × 40mm
7542540	7562540	5.0mm × 40mm	7543645	7563645	6.5mm × 45mm
7542545	7562545	5.0mm × 45mm	7543650	7563650	6.5mm × 50mm
7542550	7562550	5.0mm × 50mm	7543655	7563655	6.5mm × 55mm
7543525	7563525	5.5mm × 25mm	7543660	7563660	6.5mm × 60mm
7543530	7563530	5.5mm × 30mm	7543730	7563730	7.5mm × 30mm
7543535	7563535	5.5mm × 35mm	7543735	7563735	7.5mm × 35mm
7543540	7563540	5.5mm × 40mm	7543740	7563740	7.5mm × 40mm
7543545	7563545	5.5mm × 45mm	7543745	7563745	7.5mm × 45mm
7543550	7563550	5.5mm × 50mm	7543750	7563750	7.5mm × 50mm
7543555	7563555	5.5mm × 55mm	7543755	7563755	7.5mm × 55mm
			7543760	7563760	7.5mm × 60mm
			7543765	7563765	7.5mm × 65mm

Product Ordering Information *continued*

6.35mm FIXED ANGLE SCREWS

CATALOG NUMBER		DESCRIPTION	CATALOG NUMBER		DESCRIPTION
Titanium	Stainless Steel		Titanium	Stainless Steel	
7643420	7663420	4.5mm × 20mm	7642625	7662625	6.0mm × 25mm
7643425	7663425	4.5mm × 25mm	7642630	7662630	6.0mm × 30mm
7643430	7663430	4.5mm × 30mm	7642635	7662635	6.0mm × 35mm
7643435	7663435	4.5mm × 35mm	7642640	7662640	6.0mm × 40mm
7643440	7663440	4.5mm × 40mm	7642645	7662645	6.0mm × 45mm
7643445	7663445	4.5mm × 45mm	7642650	7662650	6.0mm × 50mm
7643450	7663450	4.5mm × 50mm	7642655	7662655	6.0mm × 55mm
7643455	7663455	4.5mm × 55mm	7643625	7663525	6.5mm × 25mm
7642525	7662525	5.0mm × 25mm	7643630	7663530	6.5mm × 30mm
7642530	7662530	5.0mm × 30mm	7643635	7663635	6.5mm × 35mm
7642535	7662535	5.0mm × 35mm	7643640	7663640	6.5mm × 40mm
7642540	7662540	5.0mm × 40mm	7643645	7663645	6.5mm × 45mm
7642545	7662545	5.0mm × 45mm	7643650	7663650	6.5mm × 50mm
7642550	7662550	5.0mm × 50mm	7643655	7663655	6.5mm × 55mm
7643525	7663525	5.5mm × 25mm	7643660	7663660	6.5mm × 60mm
7643530	7663530	5.5mm × 30mm	7643725	7663725	7.5mm × 25mm
7643535	7663535	5.5mm × 35mm	7643730	7663730	7.5mm × 30mm
7643540	7663540	5.5mm × 40mm	7643735	7663735	7.5mm × 35mm
7643545	7663545	5.5mm × 45mm	7643740	7663740	7.5mm × 40mm
7643550	7663550	5.5mm × 50mm	7643745	7663745	7.5mm × 45mm
7643555	7663555	5.5mm × 55mm	7643750	7663750	7.5mm × 50mm
			7643755	7663755	7.5mm × 55mm
			7643760	7663760	7.5mm × 60mm
			7643765	7663765	7.5mm × 65mm

Product Ordering Information *continued*

5.5mm MULTI AXIAL SCREWS

CATALOG NUMBER		DESCRIPTION	CATALOG NUMBER		DESCRIPTION
Titanium	Stainless Steel		Titanium	Stainless Steel	
75444020	75644020	4.0mm × 20mm	75446050	75646050	6.0mm × 50mm
75444025	75644025	4.0mm × 25mm	75446055	75646055	6.0mm × 55mm
75444030	75644030	4.0mm × 30mm	75446060	75646060	6.0mm × 60mm
75444035	75644035	4.0mm × 35mm	75446065	75646065	6.0mm × 65mm
75444040	75644040	4.0mm × 40mm	75446520	75646520	6.5mm × 20mm
75444045	75644045	4.0mm × 45mm	75446525	75646525	6.5mm × 25mm
75444050	75644050	4.0mm × 50mm	75446530	75646530	6.5mm × 30mm
75444520	75644520	4.5mm × 20mm	75446535	75646535	6.5mm × 35mm
75444525	75644525	4.5mm × 25mm	75446540	75646540	6.5mm × 40mm
75444530	75644530	4.5mm × 30mm	75446545	75646545	6.5mm × 45mm
75444535	75644535	4.5mm × 35mm	75446550	75646550	6.5mm × 50mm
75444540	75644540	4.5mm × 40mm	75446555	75646555	6.5mm × 55mm
75444545	75644545	4.5mm × 45mm	75446560	75646560	6.5mm × 60mm
75444550	75644550	4.5mm × 50mm	75446565	75646565	6.5mm × 65mm
75445020	75645020	5.0mm × 20mm	75447525	75647525	7.5mm × 25mm
75445025	75645025	5.0mm × 25mm	75447530	75647530	7.5mm × 30mm
75445030	75645030	5.0mm × 30mm	75447535	75647535	7.5mm × 35mm
75445035	75645035	5.0mm × 35mm	75447540	75647540	7.5mm × 40mm
75445040	75645040	5.0mm × 40mm	75447545	75647545	7.5mm × 45mm
75445045	75645045	5.0mm × 45mm	75447550	75647550	7.5mm × 50mm
75445050	75645050	5.0mm × 50mm	75447555	75647555	7.5mm × 55mm
75445525	75645525	5.5mm × 25mm	75447560	75647560	7.5mm × 60mm
75445530	75645530	5.5mm × 30mm	75447565	75647565	7.5mm × 65mm
75445535	75645535	5.5mm × 35mm	75447570	75647570	7.5mm × 70mm
75445540	75645540	5.5mm × 40mm	75448525	75648525	8.5mm × 25mm
75445545	75645545	5.5mm × 45mm	75448530	75648530	8.5mm × 30mm
75445550	75645550	5.5mm × 50mm	75448535	75648535	8.5mm × 35mm
75445555	75645555	5.5mm × 55mm	75448540	75648540	8.5mm × 40mm
75446025	75646025	6.0mm × 25mm	75448545	75648545	8.5mm × 45mm
75446030	75646030	6.0mm × 30mm	75448550	75648550	8.5mm × 50mm
75446035	75646035	6.0mm × 35mm	75448555	75648555	8.5mm × 55mm
75446040	75646040	6.0mm × 40mm	75448560	75648560	8.5mm × 60mm
75446045	75646045	6.0mm × 45mm	75448565	75648565	8.5mm × 65mm

Product Ordering Information *continued*

6.35mm MULTI AXIAL SCREWS

CATALOG NUMBER		DESCRIPTION	CATALOG NUMBER		DESCRIPTION
Titanium	Stainless Steel		Titanium	Stainless Steel	
76444020	76644020	4.0mm×20mm	76446045	76646045	6.0mm×45mm
76444025	76644025	4.0mm×25mm	76446050	76646050	6.0mm×50mm
76444030	76644030	4.0mm×30mm	76446055	76646055	6.0mm×55mm
76444035	76644035	4.0mm×35mm	76446525	76646525	6.5mm×25mm
76444040	76644040	4.0mm×40mm	76446530	76646530	6.5mm×30mm
76444045	76644045	4.0mm×45mm	76446535	76646535	6.5mm×35mm
76444050	76644050	4.0mm×50mm	76446540	76646540	6.5mm×40mm
76444520	76644520	4.5mm×20mm	76446545	76646545	6.5mm×45mm
76444525	76644525	4.5mm×25mm	76446550	76646550	6.5mm×50mm
76444530	76644530	4.5mm×30mm	76446555	76646555	6.5mm×55mm
76444535	76644535	4.5mm×35mm	76446560	76646560	6.5mm×60mm
76444540	76644540	4.5mm×40mm	76446565	76646565	6.5mm×65mm
76444545	76644545	4.5mm×45mm	76447525	76647525	7.5mm×25mm
76444550	76644550	4.5mm×50mm	76447530	76647530	7.5mm×30mm
76445020	76645020	5.0mm×20mm	76447535	76647535	7.5mm×35mm
76445025	76645025	5.0mm×25mm	76447540	76647540	7.5mm×40mm
76445030	76645030	5.0mm×30mm	76447545	76647545	7.5mm×45mm
76445035	76645035	5.0mm×35mm	76447550	76647550	7.5mm×50mm
76445040	76645040	5.0mm×40mm	76447555	76647555	7.5mm×55mm
76445045	76645045	5.0mm×45mm	76447560	76647560	7.5mm×60mm
76445050	76645050	5.0mm×50mm	76447565	76647565	7.5mm×65mm
76445525	76645525	5.5mm×25mm	76447570	76647570	7.5mm×70mm
76445530	76645530	5.5mm×30mm	76448525	76648525	8.5mm×25mm
76445535	76645535	5.5mm×35mm	76448530	76648530	8.5mm×30mm
76445540	76645540	5.5mm×40mm	76448535	76648535	8.5mm×35mm
76445545	76645545	5.5mm×45mm	76448540	76648540	8.5mm×40mm
76445550	76645550	5.5mm×50mm	76448545	76648545	8.5mm×45mm
76445555	76645555	5.5mm×55mm	76448550	76648550	8.5mm×50mm
76446025	76646025	6.0mm×25mm	76448555	76648555	8.5mm×55mm
76446030	76646030	6.0mm×30mm	76448560	76648560	8.5mm×60mm
76446035	76646035	6.0mm×35mm	76448565	76648565	8.5mm×65mm
76446040	76646040	6.0mm×40mm			

Important Product Information

PURPOSE

The CD HORIZON® Spinal System is intended to help provide immobilization and stabilization of spinal segments as an adjunct to fusion of the thoracic, lumbar, and/or sacral spine.

DESCRIPTION

The CD HORIZON® Spinal System consists of a variety of shapes and sizes of rods, hooks, screws, CROSSLINK® Plates, staples and connecting components, as well as implant components from other Medtronic spinal systems, which can be rigidly locked into a variety of configurations, with each construct being tailor-made for the individual case.

Certain implant components from other Medtronic spinal systems can be used with the CD HORIZON® Spinal System. These components include TSRH® rods, hooks, screws, plates, CROSSLINK® plates, connectors, staples and washer, GDLH® rods, hooks, connectors and CROSSLINK® bar and connectors; LIBERTY® rods and screws; DYNALOK® PLUS and DYNALOK CLASSIC® bolts along with rod/bolt connectors; and Medtronic Multi-Axial rods and screws. Please note that certain components are specifically designed to connect to ϕ 3.5mm, ϕ 4.5mm, ϕ 5.5mm rods or ϕ 6.35mm rods, while other components can connect to both ϕ 5.5mm rods and ϕ 6.35mm rods. Care should be taken so that the correct components are used in the spinal construct.

CD HORIZON® hooks are intended for posterior use only. CD HORIZON® staples and CD HORIZON® ECLIPSE® rods and associated screws are intended for anterior use only. However, for patients of smaller stature, CD HORIZON® 4.5mm rods and associated components may be used posteriorly.

The CD HORIZON® Spinal System implant components are fabricated from medical grade stainless steel, medical grade titanium, titanium alloy, medical grade cobalt-chromium-molybdenum alloy, or medical grade PEEK OPTIMA-LT1. Certain CD HORIZON® Spinal System components may be coated with hydroxyapatite. No warranties, express or implied, are made. Implied warranties of merchantability and fitness for a particular purpose or use are specifically excluded. See the MDT Catalog for further information about warranties and limitations of liability.

Never use stainless steel and titanium implant components in the same construct.

Medical grade titanium, titanium alloy and/or medical grade cobalt-chromium-molybdenum alloy may be used together. Never use titanium, titanium alloy and/or medical grade cobalt-chromium-molybdenum alloy with stainless steel in the same construct.

The CD HORIZON® Spinal System also includes anterior staples made of Shape Memory Alloy (Nitinol – NiTi). Shape Memory Alloy is compatible with titanium, titanium alloy and cobalt-chromium-molybdenum alloy. Do not use with stainless steel.

PEEK OPTIMA-LT1 implants may be used with stainless steel, titanium or cobalt-chromium-molybdenum alloy implants. CD HORIZON® PEEK Rods are not to be used with CROSSLINK® Plates.

To achieve best results, do not use any of the CD HORIZON® Spinal System implant components with components from any other system or manufacturer unless specifically allowed to do so in this or another Medtronic document. As with all orthopaedic and neurosurgical implants, none of the CD HORIZON® Spinal System components should ever be reused under any circumstances.

INDICATIONS

The CD HORIZON® Spinal System with or without SEXTANT® instrumentation is intended for posterior, non-cervical fixation as an adjunct to fusion for the following indications: degenerative disc disease (defined as back pain of discogenic origin with degeneration of the disc confirmed by history and radiographic studies); spondylolisthesis; trauma (i.e., fracture or dislocation); spinal stenosis; curvatures (i.e., scoliosis, kyphosis and/or lordosis); tumor; pseudarthrosis; and/or failed previous fusion.

Except for hooks, when used as an anterolateral thoracic/lumbar system, the CD HORIZON® Spinal System may also be used for the same indications as an adjunct to fusion.

With the exception of degenerative disc disease, the CD HORIZON® LEGACY™ 3.5mm rods and the CD HORIZON® Spinal System PEEK rods and associated components may be used for the aforementioned indications in skeletally mature patients as an adjunct to fusion.

The CD HORIZON SPIRE™ Plate is a posterior, non-pedicle supplemental fixation device intended for use in the non-cervical spine (T1-S1) as an adjunct to fusion. It is intended for plate fixation/attachment to spinous processes for the purpose of achieving supplemental fusion in the following conditions: degenerative disc disease (as previously defined); spondylolisthesis; trauma; and/or tumor.

In order to achieve additional levels of fixation as an adjunct to fusion, the CD HORIZON® Spinal System rods may be connected to the VERTEX® Reconstruction System with the VERTEX® rod connector. Refer to the VERTEX® Reconstruction System Package Insert for a list of the VERTEX® indications of use.

CONTRAINDICATIONS

Contraindications include, but are not limited to:

1. Active infectious process or significant risk of infection (immuno-compromise).
2. Signs of local inflammation.
3. Fever or leukocytosis.
4. Morbid obesity.
5. Pregnancy.
6. Mental illness.
7. Grossly distorted anatomy caused by congenital abnormalities.
8. Any other medical or surgical condition which would preclude the potential benefit of spinal implant surgery, such as the presence of congenital abnormalities, elevation of sedimentation rate unexplained by other diseases, elevation of white blood count (WBC), or a marked left shift in the WBC differential count.
9. Suspected or documented metal allergy or intolerance.
10. Any case not needing a bone graft and fusion.
11. Any case where the implant components selected for use would be too large or too small to achieve a successful result.
12. Any patient having inadequate tissue coverage over the operative site or inadequate bone stock or quality.
13. Any patient in which implant utilization would interfere with anatomical structures or expected physiological performance.
14. Any patient unwilling to follow postoperative instructions.
15. Any case not described in the indications.

NOTA BENE: Although not absolute contraindications, conditions to be considered as potential factors for not using this device include:

1. Severe bone resorption.
2. Osteomalacia.
3. Severe osteoporosis.

POTENTIAL ADVERSE EVENTS

All of the possible adverse events associated with spinal fusion surgery without instrumentation are possible. With instrumentation, a list—ing of potential adverse events includes, but is not limited to:

1. Early or late loosening of any or all of the components.
2. Disassembly, bending, and/or breakage of any or all of the components.
3. Foreign body (allergic) reaction to implants, debris, corrosion products (from crevice, fretting, and/or general corrosion), including metallosis, staining, tumor formation, and/or autoimmune disease.
4. Pressure on the skin from component parts in patients with inadequate tissue coverage over the implant possibly causing skin penetration, irritation, fibrosis, neurosis, and/or pain. Bursitis. Tissue or nerve damage caused by improper positioning and placement of implants or instruments.
5. Post-operative change in spinal curvature, loss of correction, height, and/or reduction.
6. Infection.
7. Dural tears, pseudomeningocele, fistula, persistent CSF leakage, meningitis.
8. Loss of neurological function (e.g., sensory and/or motor), including paralysis (complete or incomplete), dysesthesias, hyperesthesia, anesthesia, paresthesia, appearance of radiculopathy, and/or the development or continuation of pain, numbness, neuroma, spasms, sensory loss, tingling sensation, and/or visual deficits.
9. Cauda equina syndrome, neuropathy, neurological deficits (transient or permanent), paraplegia, paraparesis, reflex deficits, irritation, arachnoiditis, and/or muscle loss.
10. Urinary retention or loss of bladder control or other types of urological system compromise.
11. Scar formation possibly causing neurological compromise or compression around nerves and/or pain.
12. Fracture, microfracture, resorption, damage, or penetration of any spinal bone (including the sacrum, pedicles, and/or vertebral body) and/or bone graft or bone graft harvest site at, above, and/or below the level of surgery. Retropulsed graft.
13. Herniated nucleus pulposus, disc disruption or degeneration at, above, or below the level of surgery.
14. Non-union (or pseudarthrosis). Delayed union. Mal-union.
15. Loss of or increase in spinal mobility or function.
16. Inability to perform the activities of daily living.
17. Bone loss or decrease in bone density, possibly caused by stresses shield—ing.
18. Graft donor site complications including pain, fracture, or wound healing problems.
19. Ileus, gastritis, bowel obstruction or loss of bowel control or other types of gastrointestinal system compromise.
20. Hemorrhage, hematoma, occlusion, seroma, edema, hypertension, embolism, stroke, excessive bleeding, phlebitis, wound necrosis, wound dehiscence, damage to blood vessels, or other types of cardiovascular system compromise.
21. Reproductive system compromise, including sterility, loss of con—sortium, and sexual dysfunction.
22. Development of respiratory problems, e.g. pulmonary embolism, atelectasis, bronchitis, pneumonia, etc.
23. Change in mental status.
24. Death.

Note: Additional surgery may be necessary to correct some of these potential adverse events.

WARNING

The safety and effectiveness of pedicle screw spinal systems have been established only for spinal conditions with significant mechanical instability or deformity requiring fusion with instrumentation. These conditions are significant mechanical instability or deformity of the thoracic, lumbar, and sacral spine secondary to degenerative spondylolisthesis with objective evidence of neurologic impairment, fracture, dislocation, scoliosis, kyphosis, spinal tumor, and failed previous fusion (pseudarthrosis). The safety and effectiveness of this device for any other conditions are unknown. The implants are not prostheses.

In the absence of fusion, the instrumentation and/or one or more of its components can be expected to pull out, bend or fracture as a result of exposure to every day mechanical stresses.

PRECAUTION

The implantation of pedicle screw spinal systems should be performed only by experienced spinal surgeons with specific training in the use of this pedicle screw spinal system because this is a technically demanding procedure presenting a risk of serious injury to the patient.

A successful result is not always achieved in every surgical case. This fact is especially true in spinal surgery where many extenuating circumstances may compromise the results. This device system is not intended to be the sole means of spinal support. Use of this product without a bone graft or in cases that develop into a non-union will not be successful. No spinal implant can withstand body loads without the support of bone. In this event, bending, loosening, disassembly and/or breakage of the device(s) will eventually occur.

Preoperative and operating procedures, including knowledge of surgical techniques, good reduction, and proper selection and placement of the implants are important considerations in the successful utilization of the system by the surgeon. Further, the proper selection and compliance of the patient will greatly affect the results. Patients who smoke have been shown to have an increased incidence of non-unions. These patients should be advised of this fact and warned of this consequence. Obese, malnourished, and/or alcohol abuse patients are also poor candidates for spine fusion. Patients with poor muscle and bone quality and/or nerve paralysis are also poor candidates for spine fusion.

PHYSICIAN NOTE: Although the physician is the learned intermediary between the company and the patient, the important medical information given in this document should be conveyed to the patient.

USA FOR US AUDIENCES ONLY

CAUTION: FEDERAL LAW (USA) RESTRICTS THESE DEVICES TO SALE BY OR ON THE ORDER OF A PHYSICIAN.

Important Product Information *continued*

Other preoperative, intraoperative, and postoperative warnings and precautions are as follows:

IMPLANT SELECTION

The selection of the proper size, shape and design of the implant for each patient is crucial to the success of the procedure. Metallic surgical implants are subject to repeated stresses in use, and their strength is limited by the need to adapt the design to the size and shape of human bones. Unless great care is taken in patient selection, proper placement of the implant, and postoperative management to minimize stresses on the implant, such stresses may cause metal fatigue and consequent breakage, bending or loosening of the device before the healing process is complete, which may result in further injury or the need to remove the device prematurely.

DEVICE FIXATION

In cases where a percutaneous posterior approach is used refer to the CD HORIZON® SEXTANT® surgical technique.

MEDTRONIC CD HORIZON® Spinal System instrumentation contains 3.5mm, 4.5 mm, 5.5mm and/or 6.35mm rods and implants, which are intended to be used with device specific instruments.

For self breaking plugs, always hold the assembly with the Counter Torque device. Tighten and break-off the head of the plug to leave the assembly at optimum fixation security. After the upper part of the self breaking plug has been sheared off, further re-tightening is not necessary and not recommended. The head part should not remain in the patient. AFTER THE UPPER PART OF THE SELF BREAKING PLUG HAS BEEN SHEARED OFF, RE-ADJUSTMENT IS NOT POSSIBLE UNLESS THE PLUG IS REMOVED AND REPLACED WITH A NEW ONE.

When using DTT Transverse Links, the M6 plug should be tightened to between 8 and 9 Nm (70 to 80 inch-lbs).

CD HORIZON® PEEK Rods are not to be used with CROSSLINK® Plates.

PREOPERATIVE

1. Only patients that meet the criteria described in the indications should be selected.
2. Patient conditions and/or pre dispositions such as those addressed in the aforementioned contraindications should be avoided.
3. Care should be used in the handling and storage of the implant components. The implants should not be scratched or otherwise damaged. Implants and instruments should be protected during storage, especially from corrosive environments.
4. An adequate inventory of implants should be available at the time of surgery, normally a quantity in excess of what is expected to be used.
5. Since mechanical parts are involved, the surgeon should be familiar with the various components before using the equipment and should personally assemble the devices to verify that all parts and necessary instruments are present before the surgery begins. The CD HORIZON® Spinal System components (described in the DESCRIPTION section) are not to be combined with the components from another manufacturer.
6. All components and instruments should be cleaned and sterilized before use. Additional sterile components should be available in case of an unexpected need.

INTRAOPERATIVE

1. Extreme caution should be used around the spinal cord and nerve roots. Damage to the nerves will cause loss of neurological functions.
2. Breakage, slippage, or misuse of instruments or implant components may cause injury to the patient or operative personnel.
3. The rods should not be repeatedly or excessively bent. The rods should not be reverse bent in the same location. Use great care to insure that the implant surfaces are not scratched or notched, since such actions may reduce the functional strength of the construct. If the rods are cut to length, they should be cut in such a way as to create a flat, non-sharp surface perpendicular to the midline of the rod. Cut the rods outside the operative field. Whenever possible, use pre-cut rods of the length needed.
4. Utilize an imaging system to facilitate surgery.
5. To insert a screw properly, a guide wire should first be used, followed by a sharp tap. Caution: Be careful that the guide-wire, if used, is not inserted too deep, becomes bent, and/or breaks. Ensure that the guide-wire does not advance during tapping or screw insertion. Remove the guide-wire and make sure it is intact. Failure to do so may cause the guide wire or part of it to advance through the bone and into a location that may cause damage to underlying structures.
6. Caution: Do not overtap or use a screw/bolt that is either too long or too large. Overtapping, using an incorrectly sized screw/bolt, or accidentally advancing the guidewire during tap or screw/bolt insertion, may cause nerve damage, hemorrhage, or the other possible adverse events listed elsewhere in this package insert. If screws/bolts are being inserted into spinal pedicles, use as large a screw/bolt diameter as will fit into each pedicle.
7. Bone graft must be placed in the area to be fused and graft material must extend from the upper to the lower vertebrae being fused.
8. To assure maximum stability, two or more CROSSLINK® plates or DTT Transverse Links on two bilaterally placed, continuous rods, should be used whenever possible.
9. Before closing the soft tissues, provisionally tighten (finger tighten) all of the nuts or screws, especially screws or nuts that have a break-off feature. Once this is completed go back and firmly tighten all of the screws and nuts. Recheck the tightness of all nuts or screws after finishing to make sure that none loosened during the tightening of the other nuts or screws. Failure to do so may cause loosening of the other components.

POSTOPERATIVE

The physician's postoperative directions and warnings to the patient, and the corresponding patient compliance, are extremely important.

1. Detailed instructions on the use and limitations of the device should be given to the patient. If partial weight-bearing is recommended or required prior to firm bony union, the patient must be warned that bending, loosening and/or breakage of the device(s) are complications which may occur as a result of excessive or early weight-bearing or muscular activity. The risk of bending, loosening, or breakage of a temporary internal fixation device during postoperative rehabilitation may be increased if the patient is active, or if the patient is debilitated or demented. The patient should be warned to avoid falls or sudden jolts in spinal position.
2. To allow the maximum chances for a successful surgical result, the patient or devices should not be exposed to mechanical vibrations or shock that may loosen the device construct. The patient should be warned of this possibility and instructed to limit and restrict physical activities, especially lifting and twisting motions and any type of sport participation. The patient should be advised not to smoke tobacco or utilize nicotine products, or to consume alcohol or non-steroidals or anti-inflammatory medications such as aspirin during the bone graft healing process.

3. The patient should be advised of their inability to bend or rotate at the point of spinal fusion and taught to compensate for this permanent physical restriction in body motion.
4. Failure to immobilize a delayed or non-union of bone will result in excessive and repeated stresses on the implant. By the mechanism of fatigue, these stresses can cause the eventual bending, loosening, or breakage of the device(s). It is important that immobilization of the spinal surgical site be maintained until firm bony union is established and confirmed by roentgenographic examination. If a state of non-union persists or if the components loosen, bend, and/or break, the device(s) should be revised and/or removed immediately before serious injury occurs. The patient must be adequately warned of these hazards and closely supervised to insure cooperation until bony union is confirmed.
5. As a precaution, before patients with implants receive any subsequent surgery (such as dental procedures), prophylactic antibiotics may be considered, especially for high-risk patients.
6. The CD HORIZON® Spinal System implants are temporary internal fixation devices. Internal fixation devices are designed to stabilize the operative site during the normal healing process. After the spine is fused, these devices serve no functional purpose and may be removed. While the final decision on implant removal is, of course, up to the surgeon and patient, in most patients, removal is indicated because the implants are not intended to transfer or support forces developed during normal activities. If the device is not removed following completion of its intended use, one or more of the following complications may occur: (1) Corrosion, with localized tissue reaction or pain; (2) Migration of implant position, possibly resulting in injury; (3) Risk of additional injury from postoperative trauma; (4) Bending, loosening and breakage, which could make removal impractical or difficult; (5) Pain, discomfort, or abnormal sensations due to the presence of the device; (6) Possible increased risk of infection; (7) Bone loss due to stress shielding; and (8) Potential unknown and/or unexpected long term effects such as carcinogenesis. Implant removal should be followed by adequate postoperative management to avoid fracture, re-fracture, or other complications.
7. Any retrieved devices should be treated in such a manner that reuse in another surgical procedure is not possible. As with all orthopedic implants, the CD HORIZON® Spinal System components should never be reused under any circumstances.

PACKAGING

Packages for each of the components should be intact upon receipt. If a loaner or consignment system is used, all sets should be carefully checked for completeness and all components including instruments should be carefully checked to ensure that there is no damage prior to use. Damaged packages or products should not be used, and should be returned to Medtronic.

CLEANING AND DECONTAMINATION

Unless just removed from an unopened Medtronic package, all instruments and implants must be disassembled (if applicable) and cleaned using neutral cleaners before sterilization and introduction into a sterile surgical field or (if applicable) return of the product to Medtronic. Cleaning and disinfecting of instruments can be performed with aldehyde-free solvents at higher temperatures. Cleaning and decontamination must include the use of neutral cleaners followed by a deionized water rinse.

Note: certain cleaning solutions such as those containing formalin, glutaraldehyde, bleach and/or other alkaline cleaners may damage some devices, particularly instruments; these solutions should not be used. Also, many instruments require disassembly before cleaning.

All products should be treated with care. Improper use or handling may lead to damage and/or possible improper functioning of the device.

STERILIZATION

Unless marked sterile and clearly labeled as such in an unopened sterile package provided by the company, all implants and instruments used in surgery must be sterilized by the hospital prior to use. Remove all packaging materials prior to sterilization. Only sterile products should be placed in the operative field. Unless specified elsewhere, these products are recommended to be steam sterilized by the hospital using one of the sets of process parameters below:

METHOD	CYCLE	TEMPERATURE	EXPOSURE TIME
Steam	Pre-Vacuum	270° F (132° C)	4 Minutes
Steam	Gravity	250° F (121° C)	60 Minutes
Steam*	Pre-Vacuum*	273° F (134° C)*	20 Minutes*
Steam*	Gravity*	273° F (134° C)*	20 Minutes*

NOTE: Because of the many variables involved in sterilization, each medical facility should calibrate and verify the sterilization process (e.g., temperatures, times) used for their equipment. *For outside the United States, some non-U.S. Health Care Authorities recommend sterilization according to these parameters so as to minimize the potential risk of transmission of Creutzfeldt-Jakob disease, especially of surgical instruments that could come into contact with the central nervous system.

PRODUCT COMPLAINTS

Any Health Care Professional (e.g., customer or user of this system of products), who has any complaints or who has experienced any dissatisfaction in the product quality, identity, durability, reliability, safety, effectiveness and/or performance, should notify the distributor, Medtronic. Further, if any of the implanted spinal system component(s) ever "malfunctions," (i.e., does not meet any of its performance specifications or otherwise does not perform as intended), or is suspected of doing so, the distributor should be notified immediately. If any Medtronic product ever "malfunctions" and may have caused or contributed to the death or serious injury of a patient, the distributor should be notified immediately by telephone, FAX or written correspondence. When filing a complaint, please provide the component(s) name and number, lot number(s), your name and address, the nature of the complaint and notification of whether a written report from the distributor is requested.

FURTHER INFORMATION

Recommended directions for use of this system (surgical operative techniques) are available at no charge upon request. If further information is needed or required please contact MEDTRONIC.

©2009 Medtronic Sofamor Danek USA, Inc. All rights reserved.

ECIREP



Medtronic B.V.
Earl Bakkenstraat 10
6422 PJ Heerlen
The Netherlands
Tel: + 31 45 566 80 00

Medtronic Sofamor Danek USA, Inc.
1800 Pyramid Place
Memphis, TN 38132
Telephone: 800 933 2635 (In U.S.A.)
901 396 3133 (Outside U.S.A.)
FAX: 901 396 0356

Notes

www.sofamordanek.com

Medtronic

Spinal and Biologics Business
Worldwide Headquarters

2600 Sofamor Danek Drive
Memphis, TN 38132

1800 Pyramid Place
Memphis, TN 38132

(901) 396-3133
(800) 876-3133
Customer Service: (800) 933-2635

For more information visit
www.myspinetools.com

**MEDTRONIC INTERNATIONAL
TRADING SÀRL**

Route du Molliau 31
1131 Tolochenaz

Tel. +41 (0)21 802 70 00
Fax +41 (0)21 802 79 00

The surgical technique shown is for illustrative purposes only. The technique(s) actually employed in each case will always depend upon the medical judgment of the surgeon exercised before and during surgery as to the best mode of treatment for each patient.

Please see the package insert for the complete list of indications, warnings, precautions, and other important medical information.

