

# YOUR ONE-STOP SOLUTION

## OUR STORY

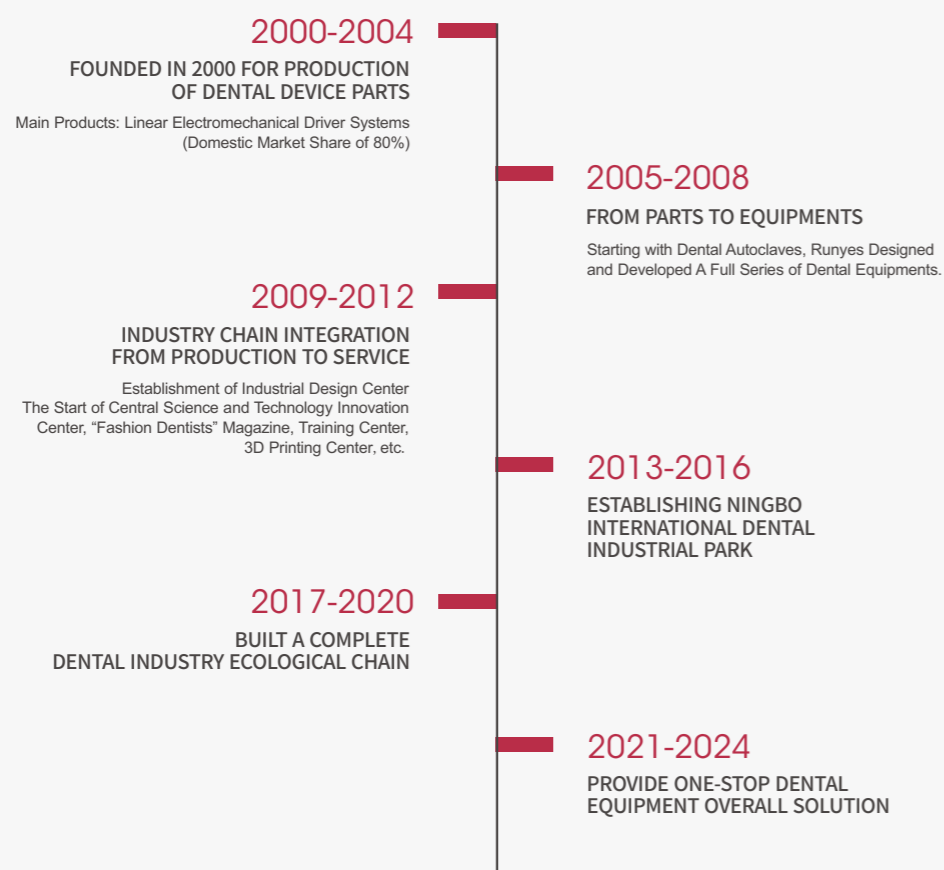

**Runyes Medical Instrument Co.,Ltd.**

Add:No. 456, Tonghui Road, Jiangbei Investment & Pioneering Park C, Ningbo,China  
Tel:+86-574-27709922 Fax:+86-574-27709923 Http://en.runyes.com  
E-mail:runyes@runyes.com

Revision: 202208



Facebook



Instagram

*Perfect your Clinic!*



# CONTENTS

- CARE-33
- CARE-33 WITH MOBILE DOCTOR STATION
- CARE-33B FOR KIDS
- CARE-22
- CARE-11
- DENTAL OIL-FREE AIR COMPRESSOR
- SUCTION UNIT



## CARE-33

### INTEGRAL DENTAL UNIT CHAIR

Become Gorgeous Since Meeting It

This is an ideal dental chair for many dentists, with enviable complete functions and stylish appearance.



## CARE-33U

### INTEGRAL DENTAL UNIT CHAIR

Up mounted Dental Unit

#### Customized Configuration

The new CARE 33 keeps improving the manufacturing process. While retaining the powerful functions of the original CARE 33, it also adopts DCI technology to upgrade the core components in a comprehensive way, bringing a more comfortable experience to doctors and patients.

The LED lights imported from American DCI can be controlled by induction or manually. There are white and yellow light sources to choose from. The seat cushion system imported from the United States DCI ensures patients a better experience.

The handpiece shown in the picture is an optional accessory



LED Light imported from American DCI

The damping type hanging rack is clean and hygienic, greatly avoiding accidental equipment falling

Intuitive and visual temperature display  
Temperature available to be adjusted

Emergency button  
Safer operation

The three-axis positioning adjustment lamp, can be flexibly positioned, always aiming at the patient's mouth, and providing a high-quality operation light source.

The multi-angle adjustable headrest can be adjusted quickly and easily with just one hand

The unique luxury balance arm design highlights the product character and pursues the perfect combination of stability and smoothness

The hanger can be rotated 90 degrees to adjust the position according to the doctor's habits

## CARE-33D

### INTEGRAL DENTAL UNIT CHAIR

Down mounted Dental Unit

#### A More Fluent Workflow

The customizable function of the foot pedal is greatly helpful to the assistant's operation, better to match the work flow, and bid farewell to the busy era.

The handpieces shown in the picture are optional.

#### Artificial-Leather Options

▪ Standard American sewing leather (I01-I13; N01-N02)



## CARE-33

### INTEGRAL DENTAL UNIT CHAIR DENTAL CHAIR WITH MOBILE UNIT

#### Simply But Extraordinarily Designed For You

Extending the ideal treatment effect from the smooth treatment process, Runyes split series dental chair cooperates with the mobile treatment cart to provide more flexible space, thereby providing doctors, patients and assistants with a more comfortable treatment environment and improving treatment efficiency .



CARE-33D Mobile Cart



# CARE-33

FOR MORE POSSIBILITIES

## Free Choices & Match

More components can be freely selected according to your usage habits. Enjoy the convenience brought by the exclusive formulation every moment.

Options:

1. Care-33 : Dental unit only;
2. Care-33D M1 : Dental unit with mobile cart and and DCI light;
3. Care-33D M2 : Dental unit with mobile cart and surgical light.

## Artificial-Leather Options

■ Standard American sewing leather (I01-I13; N01-N02)

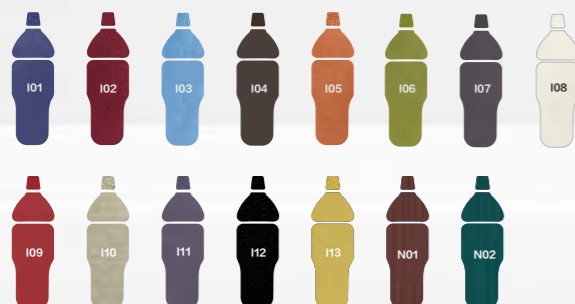

Care-33D M1

### DL-8 LED Dental lamp

The LED dental light can be controlled by induction or manually. It has a blue light cut-off function. There are white and yellow light sources to choose from, which can prevent the light-curing resin from curing in advance.



The multi-angle adjustable headrest can be easily and quickly adjusted with only one hand.



Both strong and weak suction have a time-delay function to avoid pipeline blockage.

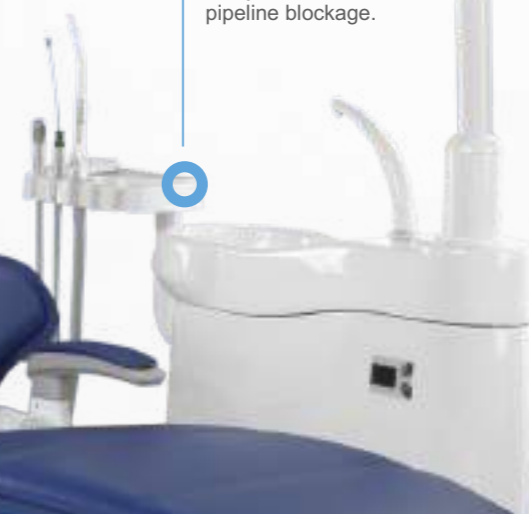

## CARE-33D M2

### SIMPLE BUT EFFECTIVE OPERATIONS



Equipped with quick plug-in interface for external water and air pipelines, and the water level bar can control the external water flow.

Hang rack, with humanized design, can be rotated 30 degrees left and right, 45 degrees up and down, so as to be adjusted according to the needs of the dentists.

External power supply, convenient for implant machines and other equipment to directly connect power supply without additional wiring.



KY-P138 Surgical Light



Multi-function Operation Panel



Detachable Water Storage Bottle



External Power Supply



## CARE-33C D

### INTEGRAL DENTAL UNIT CHAIR

Down mounted Dental Unit with smaller side box

Smaller side box looks more simple,  
spittoon can be rotated by 90 degree,  
more flexible and easier for patients.



## CARE-33B

### INTEGRAL DENTAL UNIT CHAIR

KID Dental Unit

This Is A Dental Chair Specially Designed  
For Children's Oral Treatment



## CARE-33B

### INTEGRAL DENTAL UNIT CHAIR KID Dental Unit

#### Fun, Comfortable, Safe & Practical

The machine is developed, designed and manufactured from the perspective of children, in line with children's ergonomics, and is suitable for dental treatment of children under 12.

Adopting the original imported side box of American DCI, the door cover can be opened on both sides to fully present the internal water, air and electric lines, which is convenient for maintenance. The internal water and air pipelines are isolated from the electric circuit system, ensuring the safety during use. New noble sofa cushion technology makes it more comfortable.

The dental handpiece shown in the picture is for option.



The spittoon is made of stain-resistant vitrified porcelain, which can be removed for cleaning, disinfection and be rotated 90 degrees. It has the functions of quantitative water addition and spittoon flushing, which can be programmed on the control panel.

#### Artificial-Leather Options

- Standard with American stitched leather (I13)
- The color of this picture is I13

### Care-33BD Down mounted Kid Dental Unit

By turning off the main switch of water, gas and electricity to prevent accidents at night and eliminate potential safety hazards.

The dental handpiece tube flushing and disinfection system can be chosen to flush each dental handpiece tube separately or at the same time, which can quickly clean the inner wall of the dental handpiece catheter and more effectively protect the health of dentists, assistants and patients.



The angle of each hang rack can be adjusted independently to meet the operation habits of different dentists to achieve the optimal efficiency.

### Care-33BU Up mounted Kid Dental Unit

## CARE-22

### INTEGRAL DENTAL UNIT CHAIR

#### As Cozy As A Coach

Big data derived from patient experience has helped us improve the comfort of dental unit.

The new recliner design is suitable for patients with different shape.

The upgrade of the lifting system provides more height options, so that children over 6 years old can easily get on and off the dental unit by themselves



# CARE-22U

## INTEGRAL DENTAL UNIT CHAIR Up mounted Dental Unit

### Safe, Reliable, Comfortable

Care22 humanized safety design  
Strict production technology, with the embodiment of complete functions, provides both doctors and patients with relax and comfort.

#### SL6-LED light

LED light, Control by sensor provide more convenient operation

The multi-angle adjustable headrest can be adjusted quickly and easily with just one hand

The unique luxury balance arm design highlights the product character and pursues the perfect combination of stability and smoothness

### Artificial-Leather Options

- Standard American smooth leather (I01-I13; N01-N02)
- Optional American sewing leather (I01-I13; N01-N02)

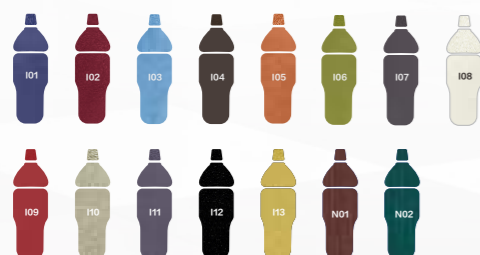

## CARE-22D

### INTEGRAL DENTAL UNIT CHAIR

Down mounted Dental Unit



The unique luxury balance arm design highlights the product character and pursues the perfect combination of stability and smoothness

With linkage mechanism and chair lifting safety protection system



The hanger can be rotated 90 degrees to adjust the position according to the doctor's needs

## CARE-11

### INTEGRAL DENTAL UNIT CHAIR



More Accurate Motions With Easier Operation



Ergonomic design



Triple-Axis-Movable LED  
Operating Light



Self-Cleaning Cuspidor



Water purification system

The multi-angle adjustable headrest can be adjusted quickly and easily with just one hand

The damping type hanging rack is clean and hygienic, greatly avoiding accidental equipment falling

With linkage mechanism and chair lifting safety protection system

## CARE-11U

### INTEGRAL DENTAL UNIT CHAIR

#### Up mounted Dental Unit

#### Well-rounded Choice Of Fashion

CARE11 is an excellent integrated dental unit among all with the same type. It inherits the development concept of Runyes and incorporates fashion elements. It becomes the most reliable and ideal working partner for dentists in diagnosis and treatment.

The dental handpiece shown is for option.



# CARE-11D

## INTEGRAL DENTAL UNIT CHAIR

Down mounted Dental Unit

### Artificial-Leather Options

- Standard domestic sofa leather(S01-S08)
- Optional American smooth seamless soft leather(I01-I13;N01-N02)
- Optional American Sewing Leather(I01-I13;N01-N02)



### SL6-LED light

LED light, Control by sensor  
provide more convenient operation

Both strong and weak suction have  
a delay function to avoid pipeline  
blockage

The hanger can be rotated 90  
degrees to adjust the position  
according to the doctor's habits





### Dental Unit Optional Accessory

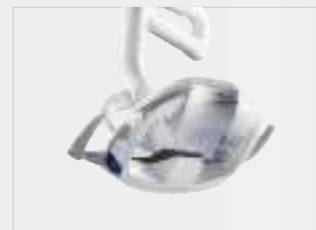

DL-8  
LED Dental Lamp DL-8



KY-P138  
Surgical light



Monitor Arm



J108 Nurse stool  
(optional for the same color)



J111 Dentist stool



Neck Rest & Waist Rest  
(optional for the same color)

### Installation Instruction Diagram

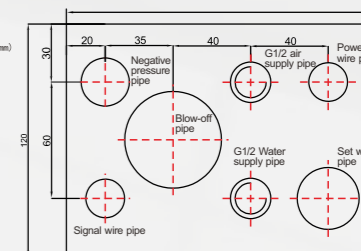
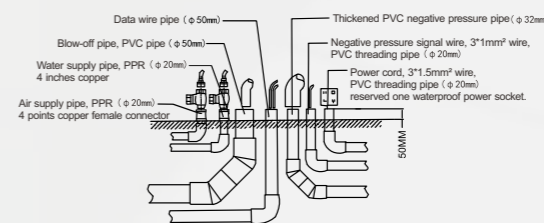
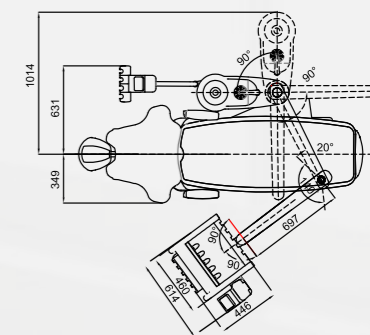
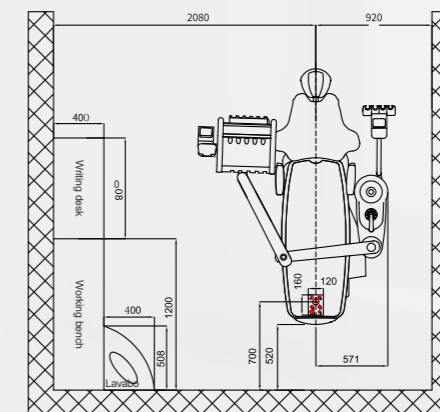

# DENTAL OIL-FREE AIR COMPRESSOR

Oil-free Technology | Powerful & Quiet



## Introduction

Clean and dry air is very important in actual clinical treatment environment and is the basis for ensuring the health of patients. Therefore, the choice of dental compressor is very important for hospitals or Labs.

The right choice of dental compressor can satisfy all air compressor needs for current or the future. Runyes Oil-Free Air Compressor can guarantee every need of users. It is the best choice for customers, no matter from the view of performance and investment, or product integrity and quality.

### ■ Low Noise

Runyes dental electric oil-free air compressor with excellent design reduces the operating noise to 70 decibels. High efficiency design and perfect cooling system make it more attractive.

### ■ Oil-free Compression

Provide oil-free compressed air, which is more suitable for dental treatment requirements.

### ■ Safer to Use With Dual Overload Protection

Each machine is equipped with a safety valve and built-in overheat protector to strengthen the protection of the motor.

### ■ Cylindrical Vent

The overall pump, with large holes, has good and quick heat dissipation.

### ■ Triple Filtration Device

Ensure safe, stable, continuous and efficient operation.



Model	Voltage Frequency	Rating Power	Gas tank volume	0.4Mpa Displacement	Max pressure	Rotating Speed	Noise	Packing Size	GW	Pump Quantity	Matchable dental chairs
Giant-30	AC220V 50Hz	0.6	25	50	0.8	1400	60	42X42X65	22	1	One for one
Giant-35	AC220V 50Hz	1.2	50	100	0.8	1400	60	74X44X73	42	2	One for two
Giant-40	AC220V 50Hz	1.54	60	140	0.8	1400	60	78X48X76	46	3	One for three
Giant-45	AC220V 50Hz	2.2	70	210	0.8	1400	65	86X54X78	66	4	One for five
Giant-50	AC220V 50Hz	3.1	135	280	0.8	1400	65	110X58X80	100	5	One for eight
Giant-55	AC220V 50Hz	4.7	210	420	0.8	1400	67	165X65X85	160	6	One for twelve

# SUCTION UNIT

Safer | More Efficient



## Solve Pollution From The Root

If the bacteria can be seen in the clinic, no one will ignore the pathogenic bacteria that exceed the standard around the dental chair. During dental surgery, a large amount of bacterial aerosol will be generated around the dental chair, and the way of air circulation cannot improve such situation.

The only way is to solve the pollution from the original source. Adopting the suction machine with a negative pressure semi-dry, two-stage separation or any other advanced technology, with the air flow of 300 liters per minute, can instantly suck away the aerosols in the patient's mouth, thereby eliminating bacterial contamination from the root.

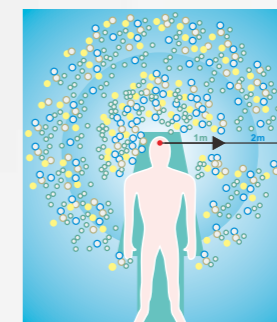

Without negative pressure system

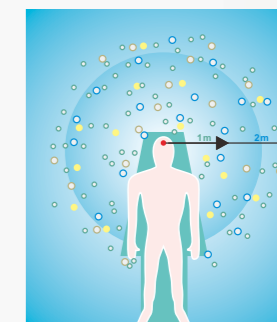

With negative pressure system

## Enroll Suction Unit



ENROLL-01



ENROLL-05



ENROLL-08

ENROLL-01	The aspiration power of ENROLL-01 is 300 litres / min. It is designed as a suction unit for one dental chair.						
ENROLL-05	It can be connected up to 5 treatment sites and can be used for 3 dentalchairs at most.						
ENROLL-08	It can be connected up to 8 treatment sites and can be used for 6 dental chairs at most.						

Specification model	It can supply up to	It can be used by up to	Suction force	Maximum vacuum	Host voltage	Rated current	Vacuum regulation
ENROLL-01	1treatment site	1dental unit	300L/min	-37KPa	AC230V	3.7~4.4A	-20KPa
ENROLL-05	5treatment site	3dental unit	900L/min	-37KPa	AC230V	3.5~4A	-20KPa
ENROLL-08	8treatment site	6dental unit	1500L/min	-37KPa	AC230V	4.5~5A	-20KPa

Specification model	Noise	Frequency	Motor power	Motor speed	Inverter power	Intake tube size	Net weight	Size
ENROLL-01	50DB	50~60Hz	550W	3440 rpm	—	32mm	32Kg	330×540×620mm
ENROLL-05	59DB	0~70Hz	630W	3980 rpm	750 w	32mm	33Kg	410×510×610mm
ENROLL-08	61DB	0~65Hz	1300W	3740 rpm	2200 w	32mm	37Kg	410×510×630mm