



LEBOO

Healthcare Products Limited

Surgical Gowns, Surgical Drapes & Packs,
One Stop Solutions



Exceeding Your Expectations



About us

Leboo was founded by a professional team, with over 10 years' experience in the medical field in China. We have 2 factories and our company is aiming to provide high quality service to the healthcare, medical and industry area by producing disposable nonwoven and PE products, such as gowns, caps, masks, bed sheets, gloves, aprons, sleeve covers, shoe covers, as well as other products. To reach this objective, we built our 100,000 grade clean room in year 2014, giving the best guarantee of the product quality.

Commitment to quality

As a manufacturer of disposable products, Leboo is dedicated to providing the superior quality products, in this pursuit, Leboo have attained ISO 13485, CE 0197 and FDA, the most stringent international standards for producing quality products, as a result, Leboo's customer are able to benefit from lower costs and reduced products defects.

Good reputation

With many years exporting experience to Europe, U.S.A., South America, South Africa, Middle east and Asia, Leboo has established a solid reputation with stable prices, reliable supply and excellent services. We are confident in our ability to build even better reputation all over the world.

Our advantage

- Rich experience on OEM service
- High focus on customer needs
- Strict quality control
- Prompt delivery and competitive price
- Professional and well- trained staff



Contents

Surgical Gown —————	6-8	Shoe Cover and Sleeve Cover ———	34-37
Surgical Gown		CPE Shoe Cover	
Doctor Set		Nonwoven Shoe Cover	
Surgical Drape and Pack —————	9-19	Non-skid PP Shoe Cover	
Basic Pack		PP+CPE Shoe Cover	
Universal Pack		Microporous Shoe Cover	
Laparotomy Pack		Nonwoven Boot Cover	
C-Section Pack		Nonwoven Sock Cover	
Delivery Pack		PE Sleeve Cover	
Orthopedic Pack		Nonwoven Sleeve Cover	
Eye Pack		Bed Sheet —————	38-40
Dental Pack		Bed Sheet	
Arthroscopy Pack		Bed Cover	
Extremity Pack		Pillow Case	
Angiography Pack		PE Mattress Cover	
Surgical Drape		Paper Sheet with PE Coated	
Gown —————	20-23	Under Pad	
Isolation Gown		Beauty Care Products —————	41-47
Patient Gown		Briefs	
CPE Thumb Hook Gown		G-String For Women	
Short Pant		G-String For Men	
Dental Bib		Kimono	
Nonwoven Apron		Skirt	
PE Apron		Pressotherapy Trousers	
Cap —————	24-26	PE Shower Cap	
Surgeon Cap		Hair Band	
Bouffant Cap		Spunlace Napkin	
Mob Cap		Slipper	
Surgical Hood		Disposable Strips	
Face Mask —————	27-30	Spunlace Towel	
Nonwoven Face Mask		Towel	
Printed Face Mask		Mask	
Face Mask with Shield		Other Nonwoven Products ———	48-51
Paper Face Mask		Washing Glove	
Glove —————	31-33	Chair Hood	
Vinyl Glove		Dead Body Bag	
PE Glove		Shopping Bag	
TPE Glove		Other Supply Products	
Creamy Vinyl Glove		Leboo Certificates —————	52
Nitrile Glove			
Latex Glove			

Surgical Gown

Surgical Gown
Doctor Set



Surgical Gown

Colors Available: ● blue ● dark blue ● green



Feature: Sterilized by EO, individual paper pouch packing Velcro at neck with 4 waist belts, cotton cuffs, Any other specifications are available on request.

Code	N306-U1
Description	Sterile surgical gown, standard, with hand towel
Size	S-XXL
Material	SMS / SMMS / SMMMS
Packing	1×30

Code	N306-U3
Description	Sterile surgical gown, reinforced at chest and half sleeve, with hand towel
Size	S-XXL
Material	SMS / SMMS / SMMMS
Packing	1×30

Code	N306-U4
Description	Sterile surgical gown, reinforced at full chest and full sleeve, with hand towel
Size	S-XXL
Material	SMS / SMMS / SMMMS
Packing	1×30

sales@leboo.com.cn

Surgical Gown

Colors Available: ● blue ● dark blue ● green



Code	N309
Description	Spunlace Surgical gown, standard, with hand towel
Size	S-XXL
Material	Pulp Spunlace
Packing	1×30

Doctor Set

Colors Available: ● blue ● dark blue ● green



Code	N3171	N333	N334
Description	Doctor set, Regular style	SMS T-shirt	SMS pant, with string or elastic at waist
Size	S-XXL	S-XXL	S-XXL
Material	SMS	SMS	SMS
Packing	1×50	10×5	10×5



Code	N3170
Description	Doctor set, Simple style
Size	S-XXL
Material	SMS
Packing	1×50



Surgical Drape and Pack

- Basic Pack
- Universal Pack
- Laparotomy Pack
- C-Section Pack
- Delivery Pack
- Orthopedic Pack
- Eye Pack
- Dental Pack
- Arthroscopy Pack
- Extremity Pack
- Angiography Pack
- Surgical Drape

Fabric:



Fabric Picture



Our fabric conforms to EN13795



Basic Pack 001 N7600-001

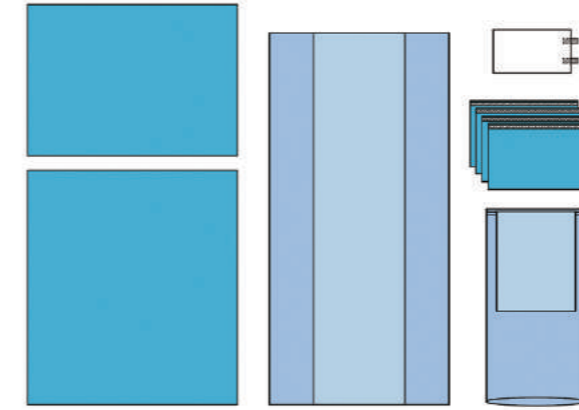

Basic Pack 002 N7600-002

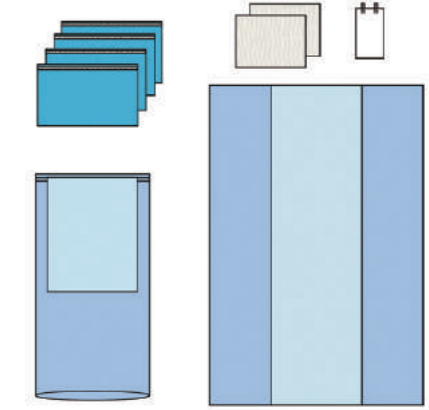

Specification	Size (cm)	Qty
Table Cover	150x200 (75x200)	1
Mayo Stand Cover	58x137 (48x60)	1
Utility Drape with Adhesive	38x66	4
Drape Sheet	105x150	1
Drape Sheet	150x160	1
Suture Bag	16x28	1

1pc/pouch, 16pouches/ctn All the pack can be customized

Specification	Size (cm)	Qty
Table Cover	140x210 (60x210)	1
Mayo Stand Cover	58x137 (48x60)	1
Utility Drape	38x66	4
Suture Bag	16x28	1
Hand Towel	30x40	2

1pc/pouch, 32pouches/ctn All the pack can be customized

Universal Pack 001 N7601-001

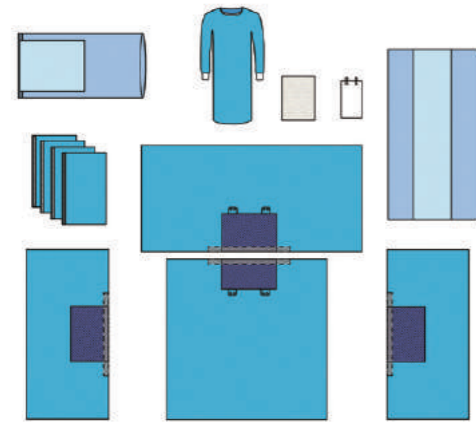

Universal Pack 002 N7601-002

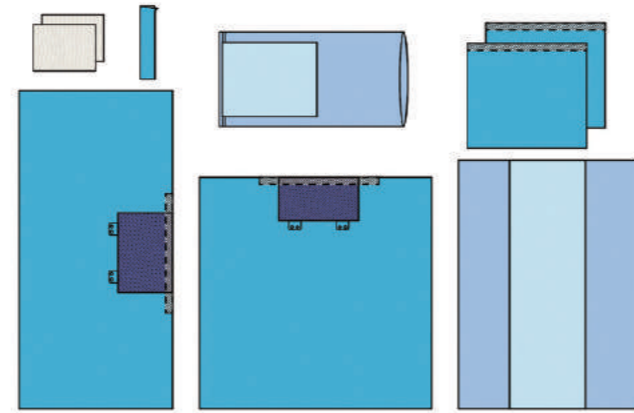

Laparotomy Pack 001 N7602-001

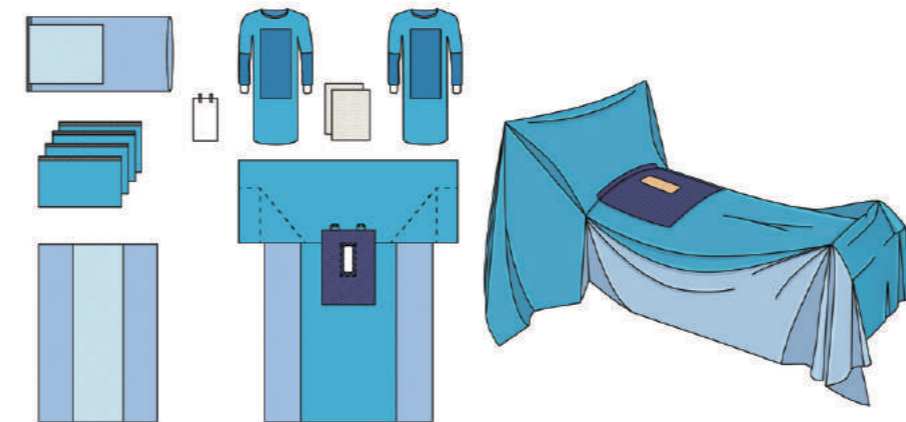

Laparotomy Pack 002 N7602-002

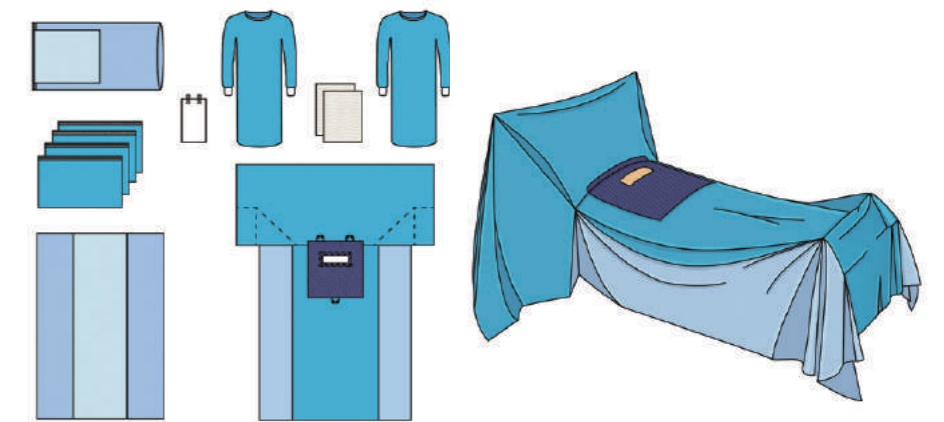

Universal Pack 001 N7601-001

Specification	Size (cm)	Qty
Table Cover	140x210 (60x210)	1
Mayo Stand Cover	58x137 (48x60)	1
Standard SMS Gown L	125x145	1
Utility Drape with Adhesive	38x66	4
Side Drape Reinforced ,with Adhesive	196x94 (64x43)	2
Head Drape Reinforced ,with Adhesive	249x135 (64x38)	1
Foot Drape Reinforced ,with Adhesive	188x180 (64x38)	1
Suture Bag	16x28	1
Hand Towel	30x40	1

1pc/pouch, 6pouches/ctn All the pack can be customized

Specification	Size (cm)	Qty
Table Cover	150x200 (75x200)	1
Mayo Stand Cover	76x145 (48x60)	1
Top Drape Reinforced ,with Adhesive	180x240 (38x64)	1
Side Drape	100x90	2
Bottom Drape Reinforced ,with Adhesive	180x180 (38x64)	1
Tape Strip (op-tape)	10x50	1
Hand Towel	30x40	2

1pc/pouch, 12pouches/ctn All the pack can be customized

Specification	Size (cm)	Qty
Table Cover	140x210 (60x210)	1
Mayo Stand Cover	58x137 (48x60)	1
SMS Reinforced Gown, L	125x145	2
Utility Drape with Adhesive	38x66	4
Laparotomy Drape	254(196)x 305	1
Suture Bag	16x28	1
Hand Towel	30x40	2

1pc/pouch, 8pouches/ctn All the pack can be customized

Laparotomy Pack 002 N7602-002

Specification	Size (cm)	Qty
Table Cover	140x210 (60x210)	1
Mayo Stand Cover	58x137 (48x60)	1
Standard SMS Gown L	125x145	2
Utility Drape with Adhesive	38x66	4
Laparotomy Drape	267(196) x353	1
Suture Bag	16x28	1
Hand Towel	30x40	2

1pc/pouch, 6pouches/ctn All the pack can be customized

C-Section Pack 001 N7603-001

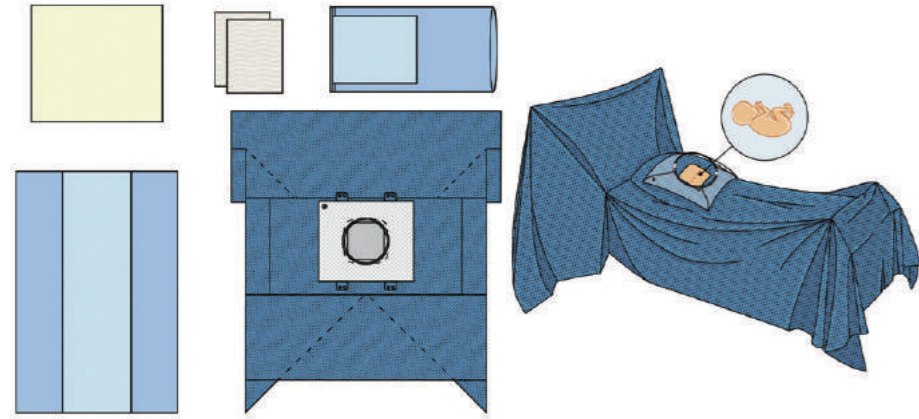

Specification	Size (cm)	Qty
Table Cover	140x210 (60x210)	1
Mayo Stand Cover	76x145 (48x60)	1
C-Section Drape , with Liquid Pouch	252x281	1
Baby Drape	90x80	1
Hand Towel	30x40	2

1pc/pouch, 7pouches/ctn All the pack can be customized

Delivery Pack 001 N7604-001

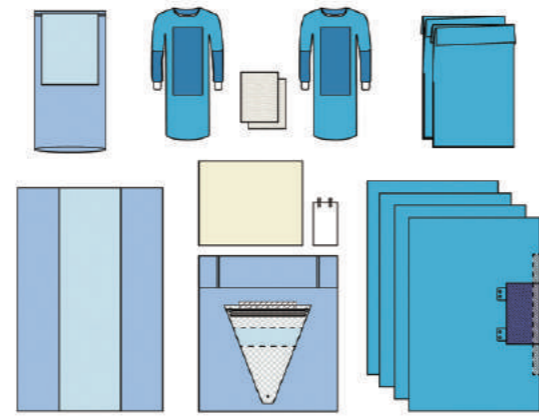

Specification	Size (cm)	Qty
Table Cover	140x190 (60x190)	1
Mayo Stand Cover	58x137 (48x60)	1
SMS Reinforced Gown, L	125x145	2
Adhesive Drape with Reinforcement	100x150 (23x40)	4
Under Buttock Drape with Liquid Pouch	102x112	1
Leggings	80x120	2
Suture Bag	16x28	1
Baby Drape	90x75	1
Hand Towel	30x40	2

1pc/pouch, 8pouches/ctn All the pack can be customized

Orthopedic Pack 001 N7605-001

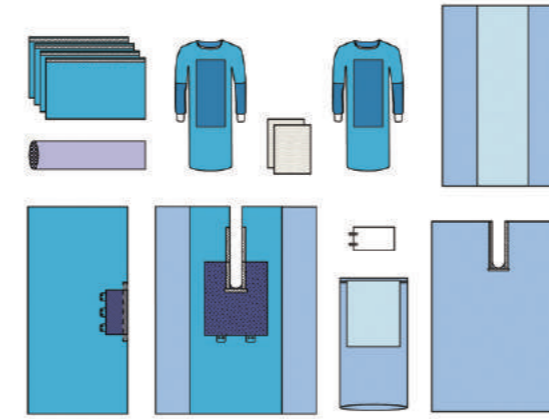

Specification	Size (cm)	Qty
Table Cover	140x210 (60x210)	1
Mayo Stand Cover	58x137 (48x60)	1
SMS Reinforced Gown, L	125x145	2
Utility Drape with Adhesive	38x66	4
PE Split Drape	152x213	1
Split Drape	196x250	1
Top Drape	135x251	1
Suture Bag	16x28	1
Stockinette	23x122	1
Hand Towel	30x40	2

1pc/pouch, 8pouches/ctn All the pack can be customized

Orthopedic Pack 002 N7605-002

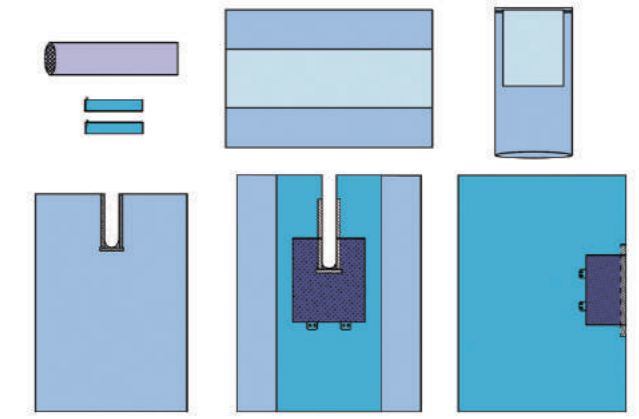

Specification	Size (cm)	Qty
Table Cover	140x210 (60x210)	1
Mayo Stand Cover	58x137 (48x60)	1
PE Split Drape	150x180	1
Split Drape Split	200x300	1
Top Drape	240x180	1
Stockinette	23x122	1
Tape Strip	10x50	2

1pc/pouch, 10 pouches/ctn All the pack can be customized

Eye Pack 001 N7606-001

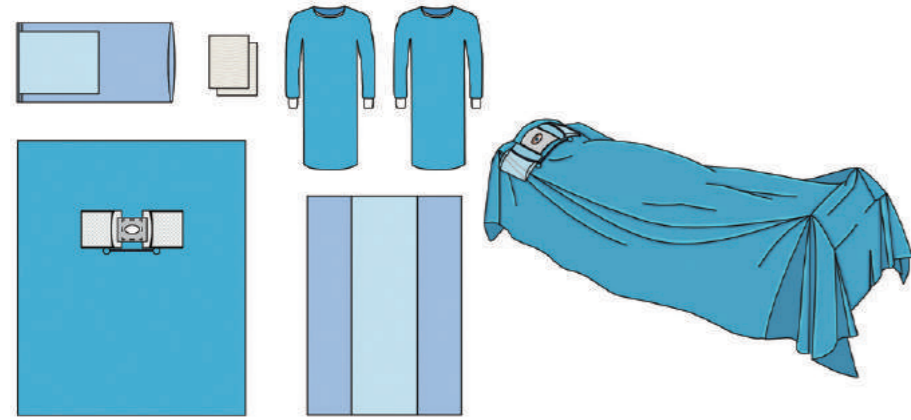

Specification	Size (cm)	Qty
Table Cover	140x210 (60x210)	1
Mayo Stand Cover	58x137 (48x60)	1
Standard SMS Gown L	125x145	2
Eye Drape , with Liquid Pouch, Incise Tape	150x180	1
Hand Towel	30x40	2

1pc/pouch, 16pouches/ctn All the pack can be customized

Dental Pack 001 N7607-001

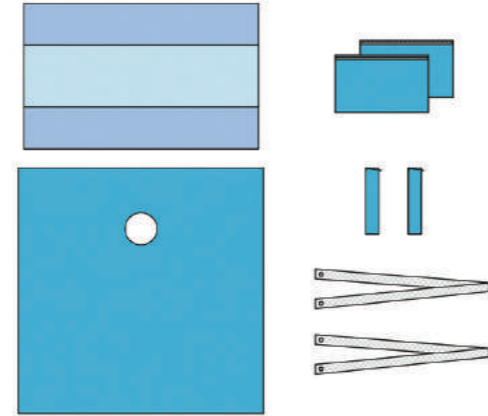

Specification	Size (cm)	Qty
Table Cover	140x210 (60x210)	1
Utility Drape	38x66	2
Tape Strip (op-tape)	10x50	2
Dental Drape	150x150	1
Tube cover	8x120	2

1pc/pouch, 32pouches/ctn All the pack can be customized

Arthroscopy Pack 001 N7608-001

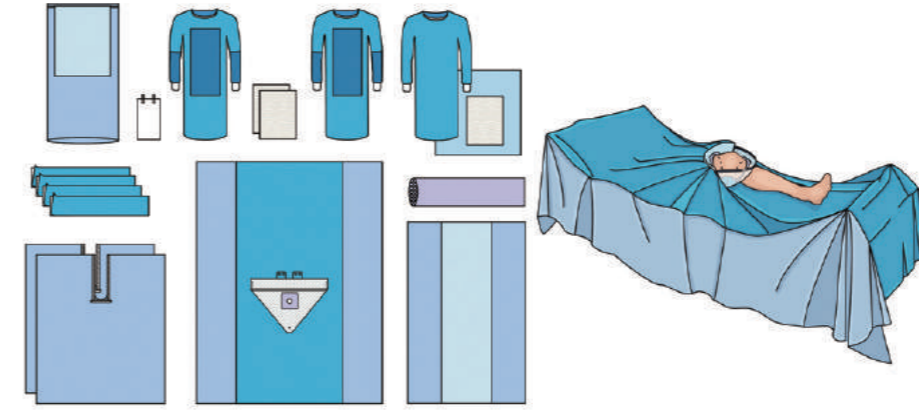

Specification	Size (cm)	Qty
Table Cover	140x210 (60x210)	1
Mayo Stand Cover	58x137 (48x60)	1
Standard SMS Gown L with Towel in Wrap	125x145	1
SMS Reinforced Gown, L	125x145	2
PE Split Drape	152x178	2
Arthroscopy Drape, with Liquid Pouch	230x300	1
Suture Bag	16x28	1
Tape Strip (op-tape)	10x50	4
Stockinette	23x122	1
Hand Towel	30x40	2

1pc/pouch, 6pouches/ctn All the pack can be customized

Extremity Pack 001 N7609-001

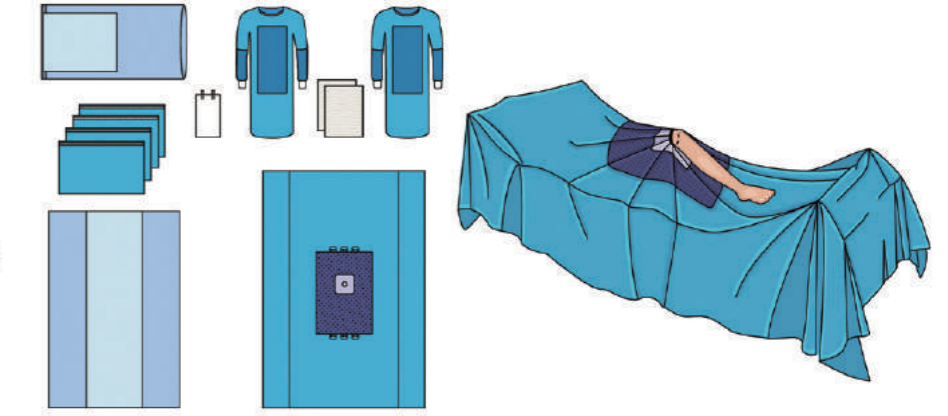

Specification	Size (cm)	Qty
Table Cover	140x210 (60x210)	1
Mayo Stand Cover	58x137 (48x60)	1
SMS Reinforced Gown, L	125x145	2
Utility Drape with Adhesive	38x66	4
Extremity Drape	220x318	1
Suture Bag	16x28	1
Hand Towel	30x40	2

1pc/pouch, 9pouches/ctn All the pack can be customized

Angiography Pack 001 N7610-001

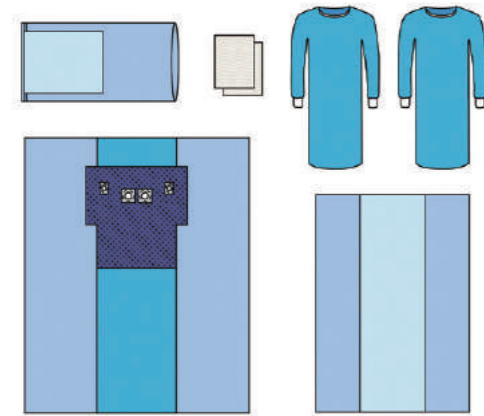

Specification	Size (cm)	Qty
Table Cover	140x210 (60x210)	1
Mayo Stand Cover	58x137 (48x60)	1
Standard SMS Gown L	125x145	2
Angiography Drape	310x380	1
Hand Towel	30x40	2

1pc/pouch, 9pouches/ctn All the pack can be customized

Angiography Pack 002 N7610-002

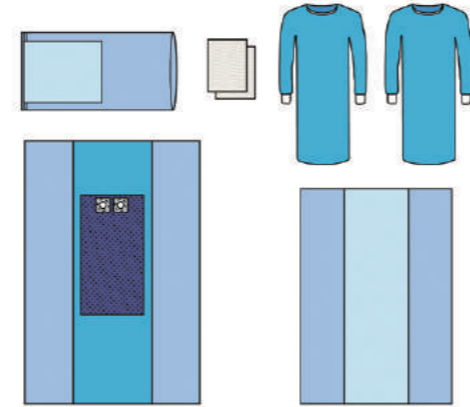

Specification	Size (cm)	Qty
Table Cover	140x210 (60x210)	1
Mayo Stand Cover	58x137 (48x60)	1
Standard SMS Gown L	125x145	2
Angiography Drape	220x330	1
Hand Towel	30x40	2

1pc/pouch, 9 pouches/ctn All the pack can be customized

Surgical Drape

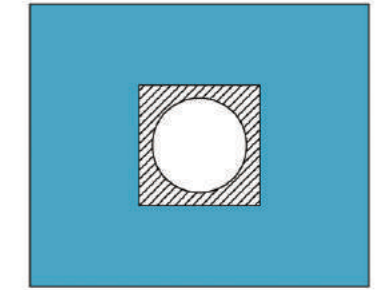
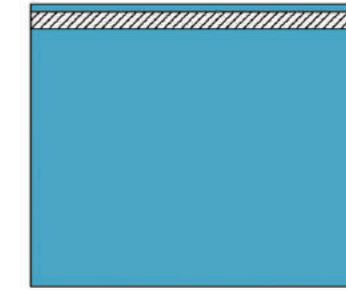
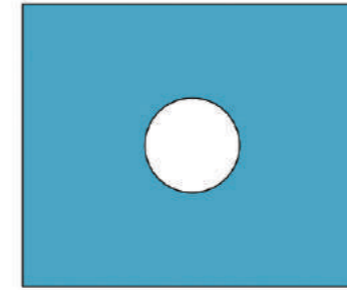

Standard Drape SMS / PP+PE film / Viscose+PE film 1pc/pouch, sterilized by EO

Ref.	Size(cm)	Pieces per ctn
N7210-1	40x60	200
N7210-2	50x75	200
N7210-3	75x75	200
N7210-4	75x90	100
N7210-5	100x150	100
N7210-6	110x190	100
N7210-7	150x200	50

Drape with Adhesive Side SMS / PP+PE film 1pc/pouch, sterilized by EO

Ref.	Size(cm)	Pieces per ctn
N7310-1	40x60	200
N7310-2	50x75	200
N7310-3	75x75	200
N7310-4	75x90	100
N7310-5	100x150	100
N7310-6	110x190	50
N7310-7	150x200	50

Drape with Adhesive Aperture SMS / PP+PE film 1pc/pouch, sterilized by EO

Ref.	Size(cm)	Aperture ϕ (cm)	Pieces per ctn
N7311-1	40x60	6	200
N7311-2	50x75	6	200
N7311-3	75x75	6	200
N7311-4	75x90	6x8	100
N7311-5	100x150	5x7	100
N7311-6	150x200	6x15	50
N7311-7	200x240	12	30

Gown

- Isolation Gown
- Patient Gown
- CPE Thumb Hook Gown
- Short Pant
- Dental Bib
- Nonwoven Apron
- PE Apron



Isolation Gown

Colors Available: white blue dark blue yellow green dark green

Any gram, size, material or style are available



With Knitted Cuff

Code	N302
Description	Isolation gown, with knitted cuff
Size	S-XL
Material	PP
Packing	10×10



With Elastic Cuff

Code	N301
Description	Isolation gown, with elastic cuff
Size	S-XL
Material	PP
Packing	10×10



Other Style

Code	N303	N304	N305
Description	Isolation gown, full coated	Isolation gown, half coated (PE coated at front and sleeve), back PP, velcro at neck	Isolation gown, 4 waist belts, velcro at neck
Size	S-XL	S-XL	S-XL
Material	PP+PE	PP+PE	PP
Packing	10×10	10×10	10×10

Patient Gown

Colors Available: ● blue ● dark blue ● green ● dark green



Code	N318	N319	N320
Description	Patient gown, short sleeve	Patient gown, without sleeve	Patient gown, for child, short sleeve
Material	PP	PP	PP
Packing	10×10	10×10	10×10

Any gram, size, material or style are available

CPE Thumb Hook Gown

Colors Available: ● blue



Code	C305
Description	CPE thumb hook gown
Material	CPE
Packing	1×500

Short Pant

Colors Available: ○ white ● blue ● green ● dark blue ● dark green ● black



Feature: Used for colonoscopy or endoscopy examination or other applications

Code	N350	N351
Description	Short pant with slit	Short pant with velcro and flap
Size	L, XL	L, XL
Material	PP	PP
Packing	10×10	10×10

Dental Bib

Colors Available: ○ white ● blue ● green ● yellow ● red ● pink ● purple



Code	Description	Material	Packing
N503	Paper dental bib without tie, 1ply, all colors	1ply Paper +PE	125×4
N504	Paper dental bib without tie, 2ply, all colors	2ply Paper +PE	125×4
N505	Paper dental bib with paper ties, with pocket	1ply Paper +PE	100×10
N508	Paper dental bib with paper ties, without pocket	1ply Paper +PE	100×10

Nonwoven Apron

Colors Available: ○ white ● blue ● green ● yellow



Code	Description	Material	Packing
N501	Nonwoven apron	PP	10×20
N502	PE coated nonwoven apron	PP+PE	10×20

PE Apron

Colors Available: ○ white ● blue ● green ○ clear ● yellow ● red ● pink



Any Size and Thickness are Available

Code	Description	Material	Packing
C501	LDPE apron, flat packed	LDPE	100×10
C502	LDPE apron, flat packed in box	LDPE	100×10boxes
C503	HDPE apron, flat packed	HDPE	100×10

Cap

Surgeon Cap
Bouffant Cap
Mob Cap
Surgical Hood



Surgeon Cap

Colors Available: ○ white ● blue ● green ● dark blue ● spunlace ● dark green



Feature: Universal sizes to fit all.

Code	Description	Material	Packing
N109	Surgeon cap, 1ply, with fixed ties	PP	100×10
N110	Surgeon cap, 2ply, with fixed ties	PP	100×10
N112	Surgeon cap, 1ply, with elastic	PP	100×10
N113	Surgeon cap, 1ply, with elastic lattice or wave design	Spunlace	100×10

Code	Description	Material	Packing
N128	SMS surgeon cap, with PP top, 1 ply, with fixed ties	SMS	100×10

Code	Description	Material	Packing
N129	Ultrasonic seam surgeon cap, 1 ply, with elastic	PP	100×10
N130	Ultrasonic seam surgeon cap, 1 ply, with tie	PP	100×10

Bouffant Cap

Colors Available: ○ white ● blue ● green ● yellow
● red ● spunlace



Mob Cap

Colors Available: ○ white ● blue ● green ● yellow
● red ● pink ● lake blue



Surgical Hood

Colors Available: ○ white ● blue ● green ● spunlace



Face Mask

Nonwoven Face Mask
 Printed Face Mask
 Face Mask with Shield
 Paper Face Mask

Code	Description	Size	Material	Packing
N101	Bouffant cap	18"	PP	100×10
N102	Bouffant cap	21"	PP	100×10
N103	Bouffant cap	24"	PP	100×10
N145	Bouffant cap	21"	Spunlace	100×10

Code	Description	Size	Material	Packing
N104	Mob cap, single elastic	18"	PP	100×10
N105	Mob cap, single elastic	21"	PP	100×10
N106	Mob cap, single elastic	24"	PP	100×10
N107	Mob cap, double elastic	21"	PP	100×10
N108	Detectable mob cap, double elastic	21"	PP	100×10

Code	N114	N115
Description	Surgical hood (astronaut hood)	Surgical hood (astronaut hood) lattice or wave design
Material	PP	Spunlace
Packing	100×10	100×10

Nonwoven Face Mask

Colors Available: white blue green printed



Printed Face Mask

Colors Available: white blue green printed



Code	Description	Material	Packing
N201	Face mask, 2-layers, with earloops	PP+PP	50×20
N203	Face mask, 3-layers, with earloops	PP+filter paper+PP	50×20
N212	Surgical face mask, 3-layers, with earloops, BFE>99%,risk II	PP+filter paper+PP	50×20
N217	Face mask, with earloops, 3-layers, with embossed LOGO	PP+filter paper+PP	50×20

Code	Description	Material	Packing
N202	Face mask, 2-layers, with ties	PP+PP	50×20
N204	Face mask, 3-layers, with ties	PP+filter paper+PP	50×20
N209	Surgical face mask, 3-layers, with ties, BFE>99%,risk II	PP+filter paper+PP	50×20
N218	Face mask, with ties, 3-layers, with embossed LOGO	PP+filter paper+PP	50×20

Code	Description	Material	Packing
N211	Children face mask, with earloops, single color printing	PP+filter paper+PP	50×20
N214	Children face mask, with earloops	PP+filter paper+PP	50×20
N215	Babies face mask, with earloops	PP+filter paper+PP	50×20

Code	Description	Material	Packing
N219	Printed face mask, with earloops, one color printing	PP+filter paper+PP	50×20
N220	Printed face mask, with ties, one color printing	PP+filter paper+PP	50×20
N221	Printed face mask, with earloops, two colors printing	PP+filter paper+PP	50×20
N222	Printed face mask, with ties, two colors printing	PP+filter paper+PP	50×20

Face Mask With Shield

Colors Available: white blue green



Paper Face Mask

Colors Available: white



Code	Description	Material	Packing
N223	Face mask, with earloops, with shield	PP+filter paper+PP	50×10
N225	Face mask, 3ply, with earloops, with shield, with anti-foggy bar	PP+filter paper+PP	50×10

Code	Description	Material	Packing
N205	Paper face mask, 1- layer	Paper	100×100
N206	Paper face mask, 2-layers	Paper	100×100



Glove

- Vinyl Glove
- PE Glove
- TPE Glove
- Creamy Vinyl Glove
- Nitrile Glove
- Latex Glove

Vinyl Glove

Colors Available: clear blue



PE Glove

Colors Available: clear blue



TPE Glove

Colors Available: clear blue



Creamy Vinyl Glove

Colors Available: white yellow



Nitrile Glove

Colors Available: white blue



Latex Glove

Colors Available: white



Feature:
size: S, M, L, XL Grade: AQL 1.5, AQL 2.5, AQL 4.0

Code	Description	Color	Material	Packing
G101	Vinyl gloves, powdered	Clear	Vinyl	100×10
G102	Vinyl gloves, powder free	Clear	Vinyl	100×10
G105	Vinyl gloves, powdered	Blue	Vinyl	100×10
G106	Vinyl gloves, powder free	Blue	Vinyl	100×10

size: M, L, Embossed/Smooth Surface

Code	Description	Color	Material	Packing
C201	LDPE glove	Clear	LDPE	100×100
C202	LDPE glove	Blue	LDPE	100×100
C203	HDPE glove	Clear	HDPE	100×100
C204	2-fingers LDPE glove	Clear	LDPE	100×100
C207	PE glove, individual packing (2pcs/bag)	Clear	LDPE/HDPE	2×50×100

Code	Description	Color	Material	Packing
C213	TPE glove	Clear / Blue	TPE	100×10

Feature: also called synthetic vinyl glove or Stretch vinyl glove

Code	Description	Color	Material	Packing
G109	Creamy vinyl glove, powdered	White	Vinyl	100×10
G110	Creamy vinyl glove, powder free	White	Vinyl	100×10
G111	Creamy vinyl glove, powdered	Yellow	Vinyl	100×10
G112	Creamy vinyl glove, powder free	Yellow	Vinyl	100×10

Code	Description	Color	Material	Packing
G202	Nitrile glove, powder free	Blue	Nitrile	100×10
G206	Nitrile glove, powder free	White	Nitrile	100×10

Code	Description	Color	Material	Packing
R101	Latex examination glove powdered	White	Latex	100×10
R102	Latex examination glove powder free	White	Latex	100×10
R103	Latex surgical glove powdered, Sterile	White	Latex	1×50×10

Shoe Cover and Sleeve Cover

- CPE Shoe Cover
- Nonwoven Shoe Cover
- Non-skid PP Shoe Cover
- PP+CPE Shoe Cover
- Microporous Shoe Cover
- Nonwoven Boot Cover
- Nonwoven Sock Cover
- PE Sleeve Cover
- Nonwoven Sleeve Cover



CPE Shoe Cover

Colors Available: white blue green



Any size, any thickness are available

Code	Description	Material	Packing
C401	CPE shoe cover, hand made	CPE	100×20
C405	CPE shoe cover, machine made	CPE	100×20
C408	CPE shoe cover, individual packing 2pcs per bag	CPE	2×50×20
C416	CPE shoe cover, individual packing 2pcs per capsule	CPE	2×50×20
C406	PE shoe cover, hand made	PE	100×40
C407	PE shoe cover, machine made	PE	100×40

Nonwoven Shoe Cover

Colors Available: white blue green



Code	Description	Material	Packing
N401	Nonwoven shoe cover	PP	100×10

Non-skid PP Shoe Cover

Colors Available: white blue green



Code	Description	Material	Packing
N402	Non-skid PP shoe cover	PP	100×10

PP+CPE Shoe Cover

Colors Available: white blue brown



Code	Description	Material	Packing
N404	PP+CPE shoe cover, white+blue	PE+CPE	100×10

Microporous Shoe Cover

Colors Available: white



Code	Description	Material	Packing
N419	Microporous shoe cover	PE laminated nonwoven	100×10

Nonwoven Boot Cover

Colors Available: blue green white



Code	Description	Material	Packing
N409	Nonwoven boot cover, with elastic at opening	PP	50×10
N410	Nonwoven boot cover, with ties	PP	50×10

Nonwoven Sock Cover

Colors Available: white blue green



Code	Description	Material	Packing
N405	Nonwoven sock cover, individual packing	PP	2×50×40
N408	Nonwoven sock cover, bulk packing	PP	100×40

PE Sleeve Cover

Colors Available: white blue green yellow red



Code	Description	Material	Packing
C601	Sleeve cover, hand made	PE	100×20
C602	Sleeve cover, machine made	PE	100×20

Nonwoven Sleeve Cover

Colors Available: white blue green



Code	Description	Material	Packing
N601	Nonwoven sleeve cover	PP	100×10
N602	PE coated nonwoven sleeve cover	PP+PE	100×10

Bed Sheet

Bed Sheet
 Bed Cover
 Pillow Case
 PE Mattress Cover
 Paper Sheet with PE Coated
 Under Pad



Bed Sheet

Colors Available: white blue green



Code	Description	Material	Packing
N701	Nonwoven bed sheet, any size	PP	10×10
N706	Nonwoven bed sheet on roll, with perforation	PP	200pcs per roll
N703	PE coated PP bed sheet	PP+PE	10×10

Bed Cover

Colors Available: white blue green



Code	Description	Material	Packing
N704	Bed sheet, with elastic at 2 ends	PP	10×10
N705	Bed sheet, with elastic at 4 corners	PP	10×10

Pillow Case

Colors Available: white blue green



Code	Description	Material	Packing
N707	Pillow case	PP	10×20
N708	Pillow case with slip	PP	10×20

PE Mattress Cover

Colors Available: ● blue



Code	Description	Size	Material	Packing
C704	CPE mattress cover	210×90×20cm	CPE	10×20
C713	PE tray cover	85×125×25cm	LDPE	10×20
C714	PE tray cover	105×125×25cm	LDPE	10×20
C701	PE sheet	Any size	LDPE	10×20

Paper Sheet with PE Coated

Colors Available: ● blue ○ white

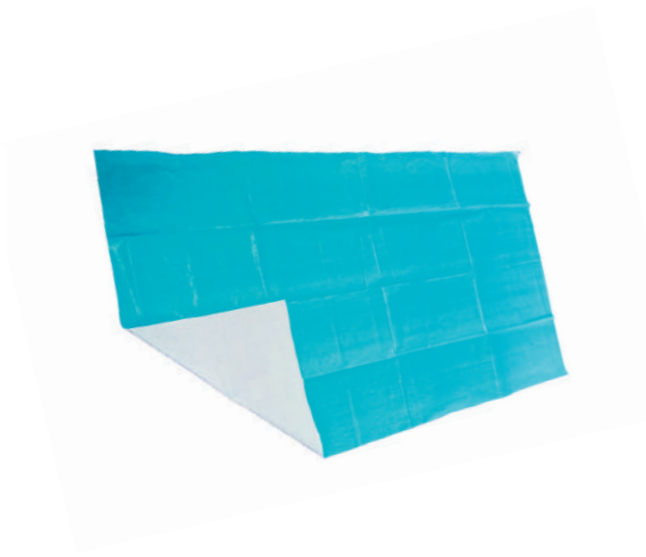

Code	Description	Material	Packing
N716	Paper sheet, with PE coated	Paper+PE	50×4
N717	Sterile paper sheet, with PE coated Individual packing	Paper+PE	1×200
N718	Paper roll, with PE coated with perforation	Paper+PE	100m/roll
N719	Paper sheet, with PE coated with thread	Paper+PE	25×4

Under Pad

Colors Available: ● blue ○ white



Code	Description	Material	Packing
N711	Underpad fluff 60×60cm	Fluff	10×10
N712	Underpad fluff 60×90cm	Fluff	10×10
N713	Underpad fluff with SAP 60×60cm	Fluff	10×10
N714	Underpad fluff with SAP 60×90cm	Fluff	10×10
N715	Underpad fluff 90×180cm	Fluff	10×10



Beauty Care Products

- Briefs
- G-String For Women
- G-String For Men
- Kimono
- Skirt
- Pressotherapy Trousers
- PE Shower Cap
- Hair Band
- Spunlace Napkin
- Slipper
- Disposable Strips
- Spunlace Towel
- Towel
- Mask

Briefs

Colors Available: white dark blue black printed



G-String For Women

Colors Available: white



G-String For Men

Colors Available: dark blue black



Kimono

Colors Available: white blue green dark blue dark green black



Skirt

Colors Available: white blue green dark blue dark green



Pressotherapy Trousers

Colors Available: white



Code	Description	Material	Packing
N802	Briefs for both men & women	PP	1×50×10
N811	Briefs for men	PP	1×50×10
N812	Briefs for women	PP	1×50×10
N807	Briefs for both men & women, super soft	Super soft PP	1×50×10
N808	Briefs, super soft, with one color printing	Super soft PP	1×50×10

Code	Description	Material	Packing
N803	G-string for women	PP	1×50×10
N805	Bikini pants for women	PP	1×50×10

Code	Description	Material	Packing
N804	G-string for men	PP	1×50×10
N806	Bikini pants for men	PP	1×50×10

Code	Description	Size	Material	Packing
N322	Kimono, with separate ties in shoulder pocket	L,XL	PP	10×10
N323	Kimono, with fixed ties	L,XL	PP	10×10
N332	Kimono, customized	L,XL	PP	10×10

Code	Description	Size	Material	Packing
N324	Skirt, with elastic and velcro	S-XXL	PP/SMS	10×10

Code	Description	Material	Packing
N813	Pressotherapy trousers	PP	10×10
N814	Pressotherapy trousers with elastic waist	PP	10×10
N815	PE coated PP pressotherapy trousers	PP+PE	10×10

PE Shower Cap

Colors Available: clear



Code	Description	Size	Material	Packing
C101	Shower cap	18"	LDPE	100×10
C102	Shower cap	21"	LDPE	100×10

Hair Band

Colors Available: white



Code	Description	Material	Packing
N810	Nonwoven hair band	PP	1×100×10

Spunlace Napkin

Colors Available: white



Code	Description	Material	Packing
WR107	Spunlace napkin, 10×10cm folded as 1/4	Mesh spunlace	200×5
WR108	Spunlace napkin, 20×20cm folded as 1/4	Mesh spunlace	200×5

Slipper

Colors Available: white



Feature: Open toe or close toe Regular size: L, XL

Code	Description	Material	Packing
N411	Nonwoven slipper with PP bottom	PP	2×500



Feature: Open toe or close toe Regular size: L, XL

Code	Description	Material	Packing
N421	Slipper with 2mm EVA sole	PP+EVA	2×50×10
N422	Slipper with 3mm EVA sole	PP+EVA	2×50×10
N413	Slipper with 5mm EVA sole	PP+EVA	2×50×10



Feature: Open toe or close toe Regular size: L, XL

Code	Description	Material	Packing
N417	Slipper, cotton	Cotton+ EVA	2×50×10

Slipper

Colors Available: white blue green yellow Pink Purple



Feature: Open toe or close toe Regular size: L, XL

Code	Description	Material	Packing
N415	EVA slipper, any color, individual packing	EVA	2×50×100

Disposable Strips

Colors Available: white



Code	Description	Material	Packing
WR109	Disposable strip, 7×20cm	Spunlace	100×50
WR110	Disposable strips in roll, 80cm per roll	Spunlace	1×12

Spunlace Towel

Colors Available: spunlace white



Code	Description	Material	Packing
WR101	Spunlace wipe roll, every 31cm perforation	Spunlace	70×6
WR102	Mesh spunlace wipe roll, every 31cm perforation	Mesh spunlace	70×6
WR103	Thermbond wipe roll, every 25cm perforation	Thermbond	150×6
WR104	Spunlace towels, 35×70cm Design: wave/ square/ net	Mesh spunlace	50×10
WR105	Spunlace towels, 45×90cm Design: wave/ square/ net	Mesh spunlace	50×10
WR106	Spunlace towels in roll, every 70cm perforation design: wave/ square/ net	Mesh spunlace	70×10

Towel

Colors Available: white



Code	Description	Size	Packing
MR-CO-TO-001	Face Towel Single folded	30×30	100 pcs/bag

Mask

Colors Available: white



Code	Description	Size	Packing
MR-SP-MA-001	DIY facial masque sheet Individual packing	19×23	500pcs/bag
MR-SP-MA-002	Facial Mask Flat packed	21×25	100 pcs/bag



Other Nonwoven Products

- Washing Glove
- Chair Hood
- Dead Body Bag
- Shopping Bag
- Other Supply products

Washing Glove

Colors Available: white



Code	Description	Material	Packing
N904	Washing glove	Needle punched cotton	50×20
N905	Washing glove	Spunlace	50×20
N906	Washing glove	Airlaid paper	50×20

Dead Body Bag

Colors Available: white blue green dark blue dark green



Code	Description	Material	Packing
N901	Nonwoven body bag without handles, central zip	PP+PE	1×25
N902	Nonwoven body bag with handles, central zip or side zip	PP+PE	1×25
C901	CPE body bag, without handle, with zip	CPE	1×25
C902	PVC body bag, with handles	PVC	1×25

Chair Hood

Colors Available: white



Code	Description	Material	Packing
N903	Nonwoven chair hood, with velcro, with printing	PP	50×500

Shopping Bag

Colors Available: white blue green yellow red



Code	Description	Material	Packing
N907	Nonwoven shopping bag, with handles	PP	10×10
N908	Nonwoven shopping bag, with strings at opening	PP	10×10

Other Supply Products



Wood Tongue Depressor

Code	Description	Size	Material	Packing
S101	Wood tongue depressor, first grade, unsteril	150×20×1.5mm	Wood	100×50
S102	Wood tongue depressor, second grade, unsteril	150×20×1.5mm	Wood	100×50
S103	Wood tongue depressor, first grade, sterilded	150×20×1.5mm	Wood	1×50×40



Identity Band

Code	Description	Size	Material	Packing
S113	Infant identity band	162×18mm	PP	100×50
S114	Adult identity band	242×25mm	PP	100×50

Other Supply Products



Gauze Sponge

Code	Description	Material	Packing
S117	Gauze sponge	cotton	100×20
S118	Gauze sponge with X-ray detectable thread	cotton	100×20



Cotton Ball

Code	Description	Material	Packing
S119	Cotton ball	cotton	10×50×10



Urine Bag

Code	Description	Size	Material	Packing
S111	Urine bag for adult	2000ml	PVC	1×400
S112	Urine bag for children	100ml	PVC	1×5000



Urine Cup

Code	Description	Size	Material	Packing
S106	Urine cup, red lip,unsterile	120ml	PP	100
S107	Faeces cup, with a spoon, yellow lip, unsterile	60ml	PP	200
S108	Sterile urine cup, red lip	120ml	PP	1×100
S109	Sterile faeces cup, with a spoon, yellow lip	60ml	PP	1×200



Medical Cotton Tipped Applicators

Code	Description	Material	Packing
S110	Medical cotton tipped applicators	cotton	50×80



Disposable Razor

Code	Description	Material	Packing
S120	Disposable Razor, single edge blade	PS	100×10
S121	Disposable Razor, double edge blade	PS	100×10

Leboo Certificates

Leboos Pursuit: Exceeding Your Expectations

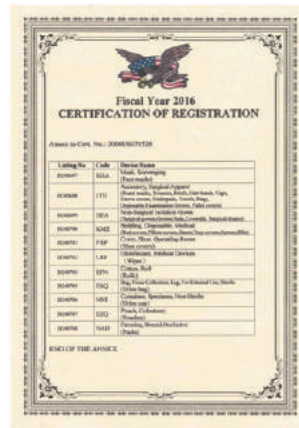



Exceeding Your Expectations

Leboo Healthcare Products Limited

H.O.: A-1506, Lar Valley International, No.168 Guang'anmen
Wai St., Xicheng District, Beijing 100055, China.

Factory: Linwan Industrial Park, Xiantao City, 433018, Hubei Province, China

Factory: Penchang Xuwan Industrial Park, Xiantao City, 433018, Hubei Province China

T: +86 10 63252699 F: +86 10 63252899

Email: sales@leboo.com.cn