

Aria™

SURGICAL TECHNIQUE



Table of Contents

Introduction	3
Aria Stem Features	4
Surgical Technique	5
<i>Preoperative Planning</i>	5
<i>Femoral Neck Resection</i>	6
<i>Femoral Preparation</i>	7
<i>Broaching</i>	8
<i>Calcar Reaming</i>	8
<i>Trial Reduction</i>	9
<i>Femoral Component Insertion</i>	10
<i>Femoral Head Impaction</i>	11
Aria Implant Sizing Guide	12
Aria Instrument Tray	13
Aria Instruments	14-17
Aria Implants	18-20
Appendix: Broaching Techniques and Tips	21

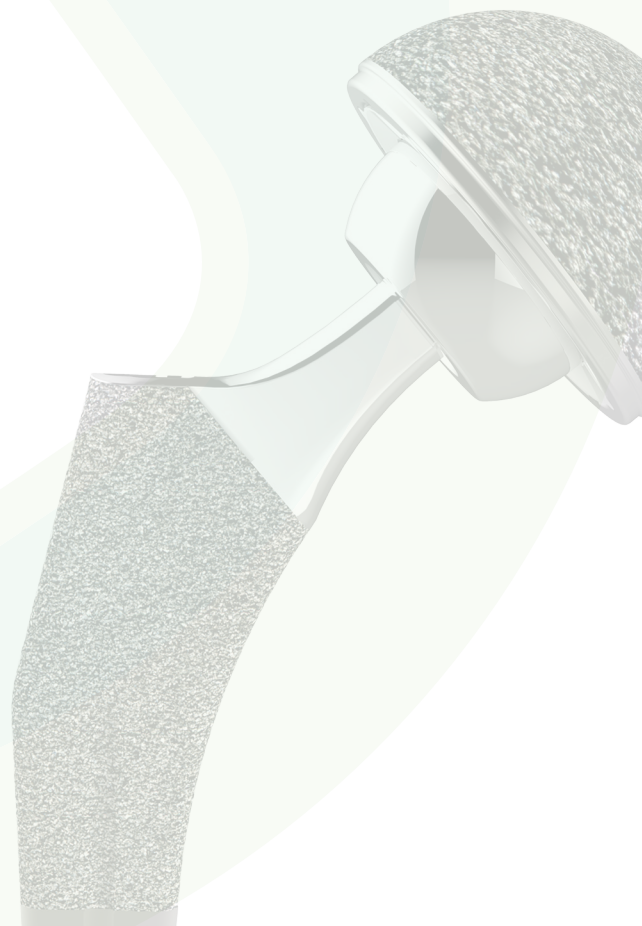

Introduction

The Signature Orthopaedics Aria stem is a Ti6Al4V dual-tapered stem with a lateral shoulder and proximally plasma-spray coated to promote bone ongrowth. The Signature Orthopaedics Aria Instrument system is an instrument set for implantation of the Signature Orthopaedics Aria cementless hip stem. The Aria instrument set features a modular broach handle that quick-connects to several instrument attachments to reduce the overall number of instruments and reduce the size and weight of the instrument tray.

Indications

Signature Orthopaedics' hip replacement range are intended to replace a hip joint where bone stock is sufficient to support the implant. When a surgeon has selected prosthetic replacement as the preferred treatment, the devices are indicated for:

- Non-inflammatory degenerative joint disease including osteoarthritis or avascular necrosis
- Inflammatory joint disease including rheumatoid arthritis (excluding TSI stem)
- Correction of functional deformity including congenital hip dysplasia (Excluding TSI stem)
- Traumatic injury involving the hip joint including traumatic arthritis or femoral head fracture
- Traumatic injury involving neck fracture (excluding TSI stem)

Signature Orthopaedics hip replacement components may be intended for cemented or cementless use. Please verify whether the particular component is intended for cemented or cementless use by checking the package label.

Signature Orthopaedic TSI stem is particularly indicated for individuals with demonstrably healthy bone stock, such as younger, more active individuals. It is an uncemented stem and thus must only be used when the treating physician is satisfied with the quality of the recipient's bone.

Signature Orthopaedics' constrained liner components are indicated particularly for patients at high risk of hip dislocation due to a history of prior dislocation, bone loss, joint or soft tissue laxity, neuromuscular disease or intraoperative instability.

Contraindications

In general, prosthetic components require adequate bone support for correct fit and function. The use of prosthetic components is therefore contraindicated where any pathological condition may reduce the quantity and or strength of the bone which is supporting the prosthesis. Some contraindications are relative to the extent and severity of conditions and the benefits of prosthetic arthroplasty should be considered based on the patient's overall evaluation and the possibility of alternative treatment.

Examples of such conditions include; osteoporosis, osteomalacia, osteogenesis imperfecta, or hypophosphatemia. Other contraindications include:

- Conditions limiting blood supply to the bone or joint.
- Systemic or local infection.
- Previous high dose radiotherapy.
- Psychological or neurological conditions which would restrict the patient's ability or compliance in restricting physical activity.
- Allergies to implanted materials, particularly metals (e.g. cobalt, chromium) as well as polyethylene and bone cement.
- Skeletal immaturity.
- Conditions or activity which may place excessive load on the components such as; obesity, muscle, tendon & ligament deficiencies, multiple joint disabilities, and Charcot joints.
- Signature Orthopaedics' constrained liners are contraindicated particularly for active patients.
- The use of Signature Orthopaedics' constrained liners are contraindicated with skirted femoral heads.
- Signature Orthopaedics' TSI stem is contraindicated for treatment of inflammatory joint disease including rheumatoid arthritis, where bone stock may not be sufficient to support the device.
- Signature Orthopaedics' TSI stem is contraindicated for use with the Logical constrained liner due to restricted range of motion.
- Signature Orthopaedics' TSI stem is contraindicated for treatment of femoral head or neck fracture.
- Signature Orthopaedics' TSI stem is contraindicated for treatment of functional deformity including congenital hip dysplasia.

*USA only

Aria Stem Features

Cementless Hip Stem

- Material and coating (Ti6Al4V with titanium plasma spray coating).
- Threaded proximal feature aids in positioning and removal.

1. Standard and High offset versions

2. 12/14 Taper

3. Low-profile lateral shoulder

Enables insertion in reduced insertion techniques, including anterior approach.

4. Tapered geometry

Wedge-shaped stem initial fixation and proximal bone loading.

5. Titanium Plasma Spray Coating

- Tensile Strength > 22MPa
- Shear Strength > 22MPa
- Coating Thickness 70-130 microns.

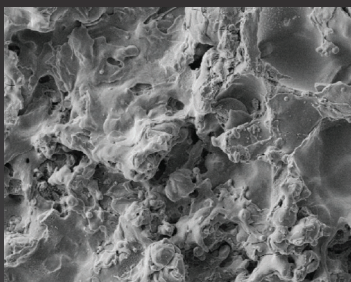

Aria coating x100

6. Reduced distal option*

- An option for cases where there are concerns over the distal loading of the femur.
- Provides surgical options to cater for a range of patients.



*USA only

1

Preoperative Planning

Aria X-Ray templates can be used over anterior/posterior and lateral radiographs to help determine the correct size to restore the patient's anatomy. Templates are 115% magnification.

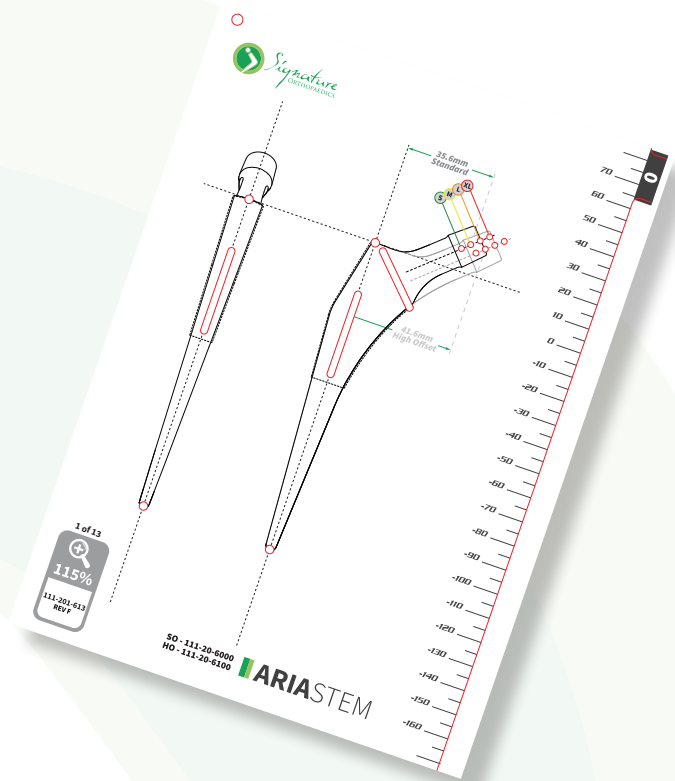

2

Preoperative Planning

The Aria stem can be used with any surgical approach that the surgeon selects.

- a. Posterior approach
- b. Posterolateral/anterolateral approach
- c. Anterior approach

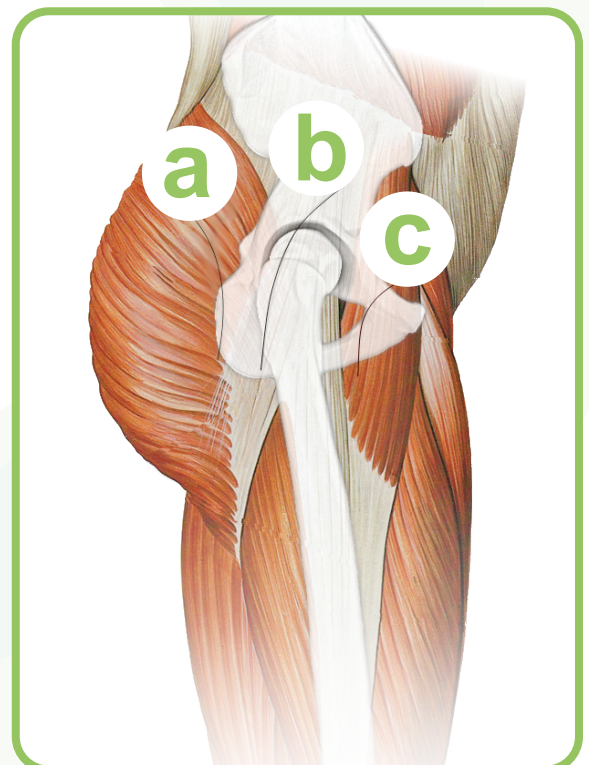

Note:

Prior to the following steps, complete all steps detailed in 111-12-0003 for the Logical acetabular cup implantation.

3

Femoral Neck Resection

The osteotomy guide should be used in conjunction with preoperative planning, to determine the level of the femoral neck resection. This can be performed in multiple steps, depending on surgeon preference.

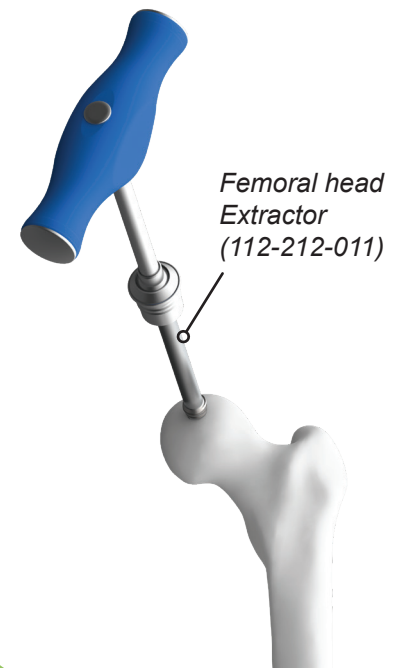
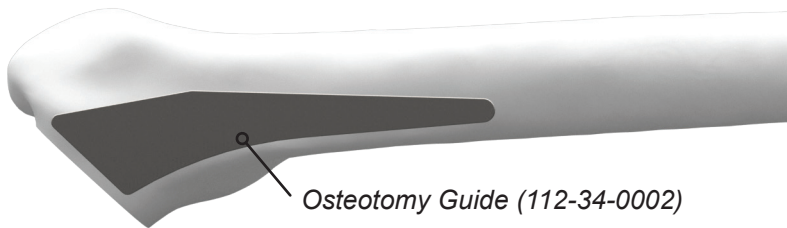
**Optional technique:**

The femoral head extractor may be used with the T-handle or under power to aid in the removal of the resected head, especially during an anterior approach technique.

4

Femoral Preparation

Enter the femoral canal as laterally as possible with the Box Osteotome to initiate access to the medullary canal. The Canal Reamer may be used as needed to open the natural axis of the femoral canal for broach preparation.

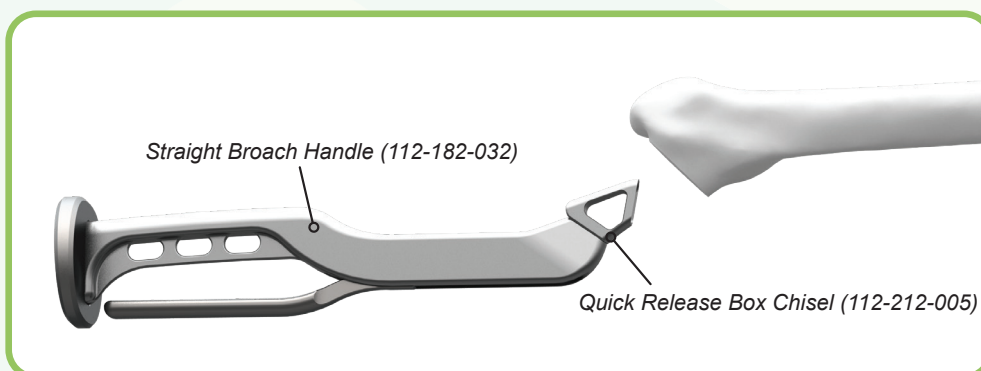
**Optional technique:**

While the Aria system is intended to be a broach-only system, the Aria instrument tray contains instruments for optional use to assist in proper axial alignment along the femoral canal and to induce lateral bias where needed:

- a. Starter broach induces lateral bias by rasping beneath the greater trochanter
- b. Canal reamer creates a guide hole for the distal end of the trochanteric reamer
- c. Trochanteric reamer removes trochanteric bone tissue laterally to assist neutral alignment with the femoral axis during broaching

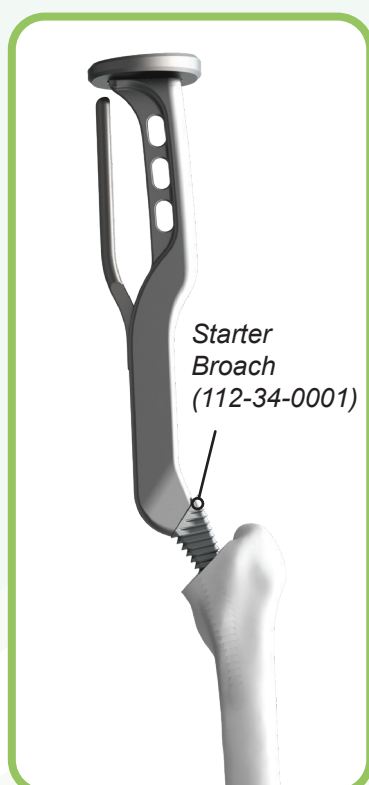

7.

5

Broaching

The broach should run parallel to the posterior cortex following the natural anatomy of the femur. Begin with the smallest broach and increase the size of the broach sequentially until longitudinal and rotational stability is achieved: broaching should then be stopped. Careful preoperative planning is key to help selection of the final broach size. The version will be determined by the natural version of the femur.

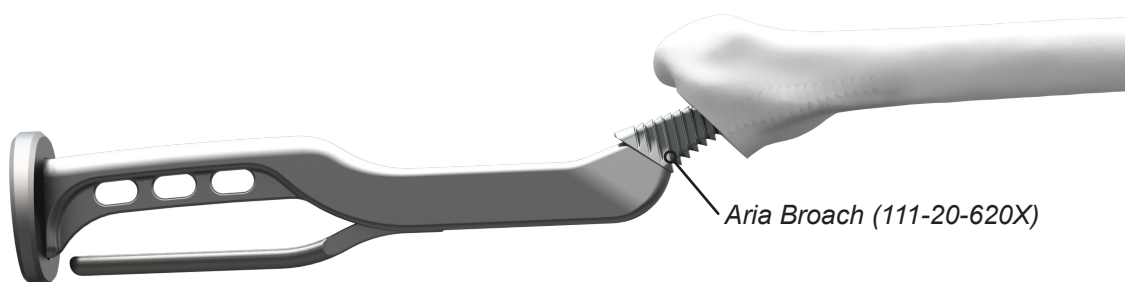
**Note:**

Refer to **Appendix: Broaching Techniques and Tips** for detail on the theory of compaction broaching, why this technique is used for Aria stems, and how to form a bed of compacted bone.

6

Calcar Reaming

With the broach in situ, use the Calcar Reamer to achieve a flat resection surface. Slide the reamer over the broach quick connect fitting to maintain the resection angle. Carefully advance the reamer towards the broach face and into the resected edge of the femur until it bottoms out against the broach face.

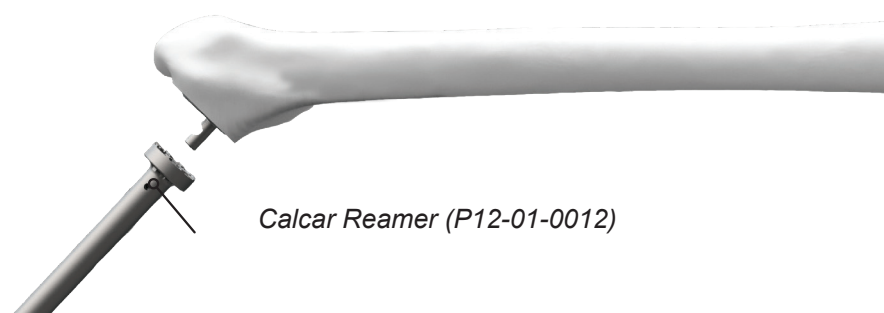

7

Trial Reduction

With the final broach still in situ, attach the appropriate trial neck and trial head. Reduce the hip and assess what adjustments, if any, are required to provide stability through a full range of motion. Remove the trial head, trial neck and final broach. DO NOT irrigate or dry the femoral canal. This will help to preserve the compacted cancellous bone quality and may encourage biological fixation of the stem.

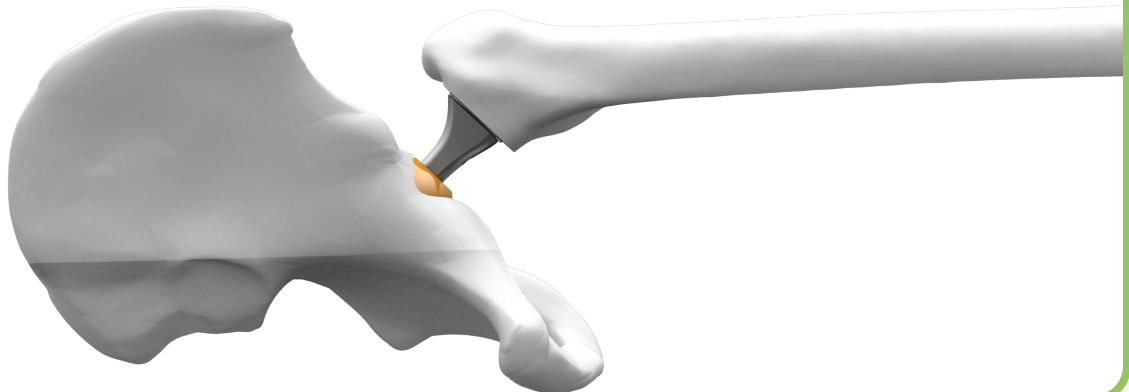
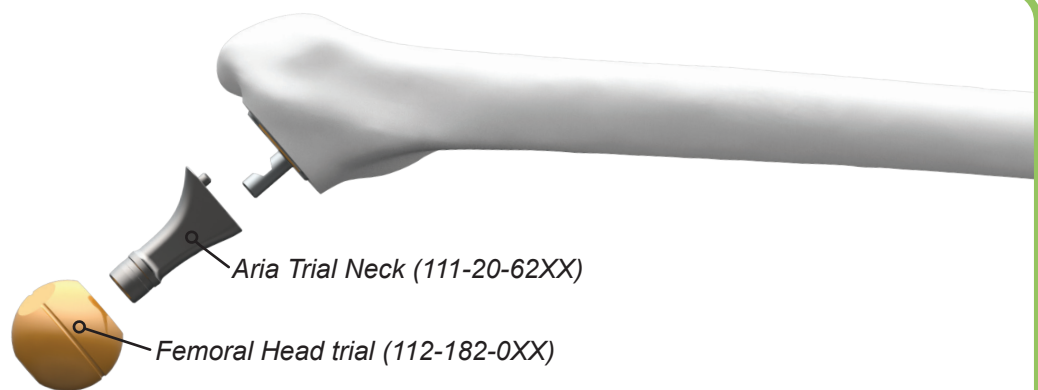
**Instrument identification:**

Trial heads are colour coded based on offset. Refer to Aria Implants Sizing Guide in this surgical technique for more details.

8

Femoral Component Insertion

When implanting the definitive stem (same size as final broach) in the femoral canal, ensure that it is directed in by hand. This will help avoid changing the version as a precautionary measure. There should be no more than 15-20mm between the resection line and the top of the porous coating on the stem. If the stem does not readily go down this far, the surgeon should broach again. Once the stem is placed, lightly tap the stem impactor to fully seat. **DO NOT** over-impact as this may lead to splitting of the femur.

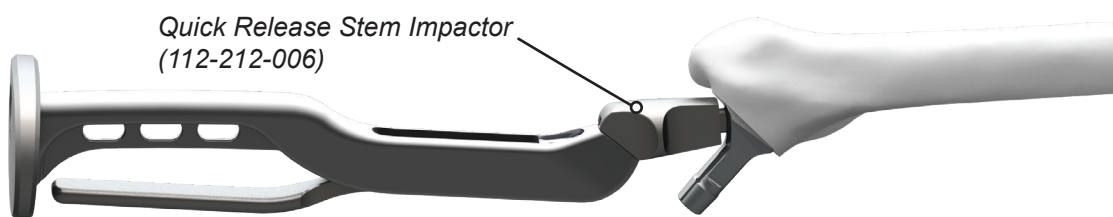
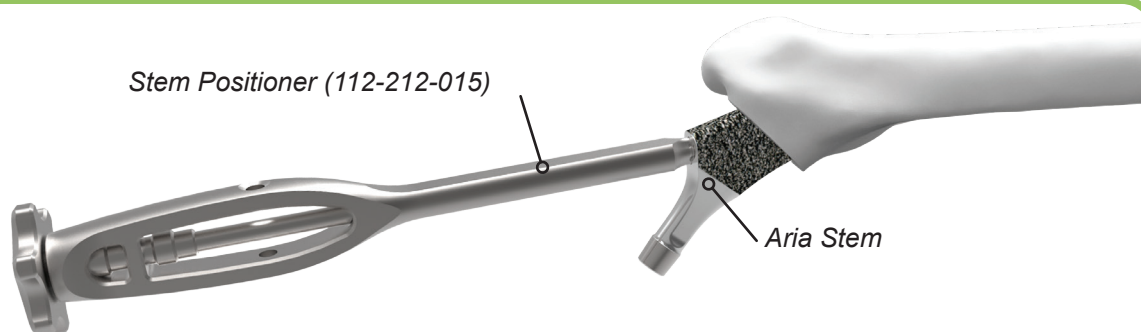

Instrument operation:

To connect the Aria stem to the stem positioner, first slide the inner shaft of the positioner through the outer shaft, spinning the strikeplate so the inner shaft threads in and falls through. Turn the threaded tip of the inner shaft into the female threads on the Aria stem until a snug hold is achieved to prevent damage to the threads.



9

Femoral Head Impaction

A final trial reduction is carried out to confirm joint stability and range of motion. Clean and dry the stem taper to remove any particulate matter or debris. Place the femoral head onto the taper and lightly tap it using the head impactor. Ensure that bearing surfaces are clean and finally reduce the hip.

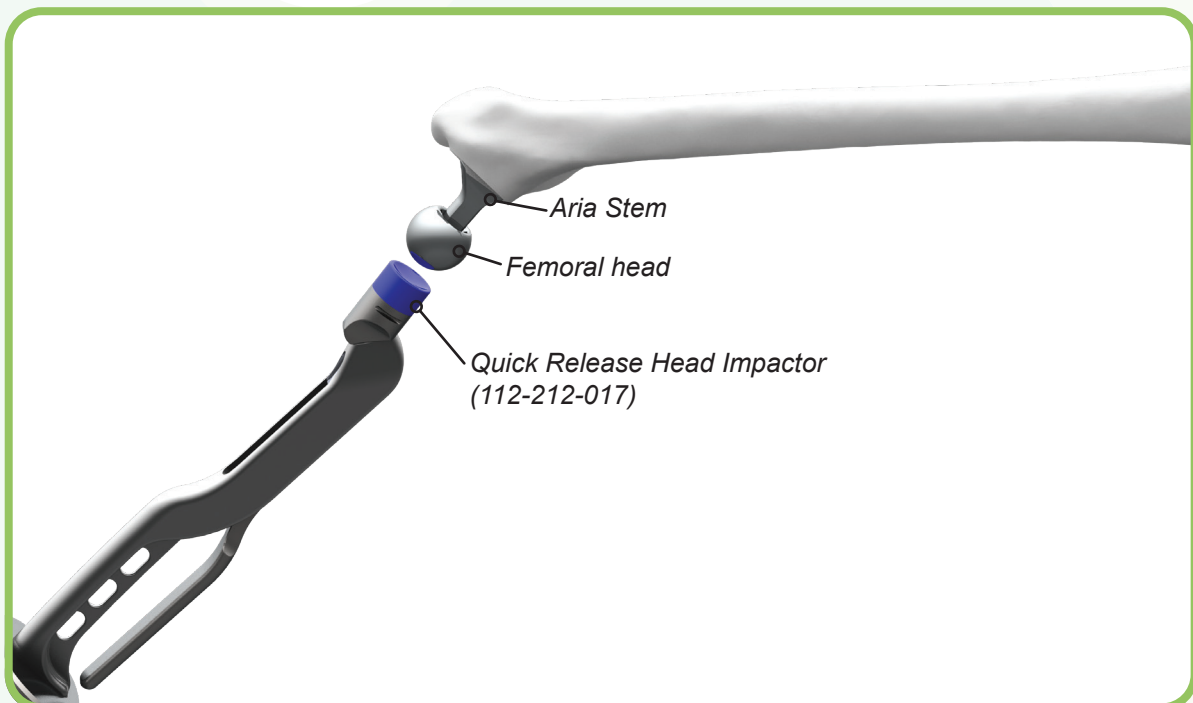

Aria Implant sizing guide*

Hip Stems and Femoral Heads

TAILLE	OFFSET	LT	L	W	O	α°	G	H	C	B	A
0	Standard Offset	128	54	35.7	35.6	132	4.9	4.4	120	11.5	11.4
	High Offset	128	54	40.1	41.6	132	4.9	4.4	120	11.5	11.4
1	Standard Offset	130	61	38.5	38.7	132	5.6	4.6	122	11.8	12.7
	High Offset	130	61	43.0	44.7	132	5.6	4.6	122	11.8	12.7
2	Standard Offset	133	63	39.4	40.1	132	6.9	4.9	124	12.2	13.4
	High Offset	133	63	43.8	46.1	132	6.9	4.9	124	12.2	13.4
3	Standard Offset	136	64	39.3	40.7	132	8.2	5.0	126	12.2	13.4
	High Offset	136	64	43.8	46.7	132	8.2	5.0	126	12.2	13.4
	Standard Offset Reduced Distal	136	64	43.8	46.7	132	6.2	5.0	126	12.2	13.4
	High Offset Reduced Distal	136	64	43.8	46.7	132	6.2	5.0	126	12.2	13.4
4	Standard Offset	138	65	40.4	42.1	132	8.9	5.0	128	12.5	14.1
	High Offset	138	65	44.9	48.1	132	8.9	5.0	128	12.5	14.1
5	Standard Offset	140	66	40.4	42.7	132	9.7	5.0	130	12.6	14.1
	High Offset	140	66	44.9	48.7	132	9.7	5.0	130	12.6	14.1
6	Standard Offset	143	67	40.4	43.3	132	10.9	5.1	132	12.8	14.1
	High Offset	143	67	44.9	49.3	132	10.9	5.1	132	12.8	14.1
7	Standard Offset	145	68	40.4	43.9	132	11.7	5.2	134	12.9	14.1
	High Offset	145	68	45.0	49.9	132	11.7	5.2	134	12.9	14.1
8	Standard Offset	148	70	43.4	46.8	132	13	5.2	136	13.2	16.1
	High Offset	148	70	47.9	52.8	132	13	5.2	136	13.2	16.1
9	Standard Offset	151	71	43.4	47.4	132	14.0	5.3	138	13.4	16.1
	High Offset	151	71	47.9	53.4	132	14.0	5.3	138	13.4	16.1
10	Standard Offset	153	72	43.4	48.0	132	13.4	5.3	140	15	16.1
	High Offset	153	72	47.9	54.0	132	13.4	5.3	140	15	16.1
11	Standard Offset	158	74	43.4	49.3	132	17.2	6.0	142	14.3	16.1
	High Offset	158	74	47.9	55.3	132	17.2	6.0	142	14.3	16.1
12	Standard Offset	163	76	43.6	50.5	132	19.7	6.3	144	14.6	16.1
	High Offset	163	76	48.0	56.5	132	19.7	6.3	144	14.6	16.1

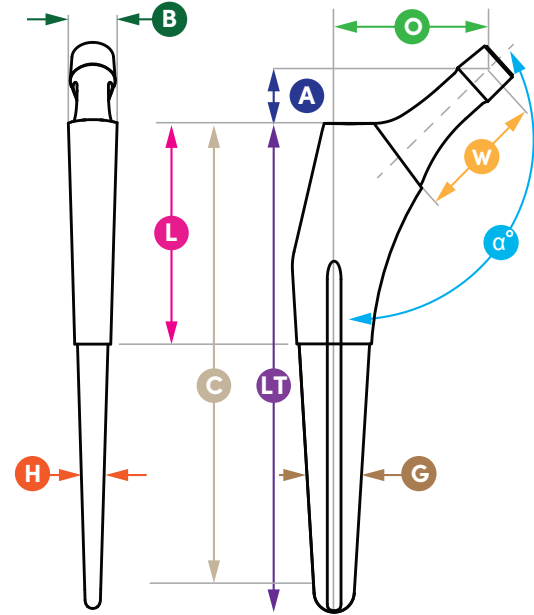

ARIA RDS (Reduced Distal) Only available in USA*

		Ø28	Ø32	Ø36	Ø40
S	CoCr	111-152-011	111-152-021	111-152-031	111-152-041
	Ceramic	-3.5 111-152-611	-4.0 111-152-621	-4.0 111-152-631	-4.0 111-152-641
	Stainless Steel	111-152-111	111-152-121	111-152-131	
M	CoCr	111-152-012	111-152-022	111-152-032	111-152-042
	Ceramic	+0.0 111-152-612	+0.0 111-152-622	+0.0 111-152-632	+0.0 111-152-642
	Stainless Steel	111-152-112	111-152-122	111-152-132	
L	CoCr	111-152-013	111-152-023	111-152-033	111-152-043
	Ceramic	+3.5 111-152-613	+4.0 111-152-623	+4.0 111-152-633	+4.0 111-152-643
	Stainless Steel	111-152-113	111-152-123	111-152-133	
XL	CoCr		111-152-024	111-152-034	111-152-044
	Ceramic		+7.0 111-152-624	+8.0 111-152-634	+8.0 111-152-644
	Stainless Steel		111-152-124	111-152-134	

*Reduced distal is USA only

Aria Instrument Tray

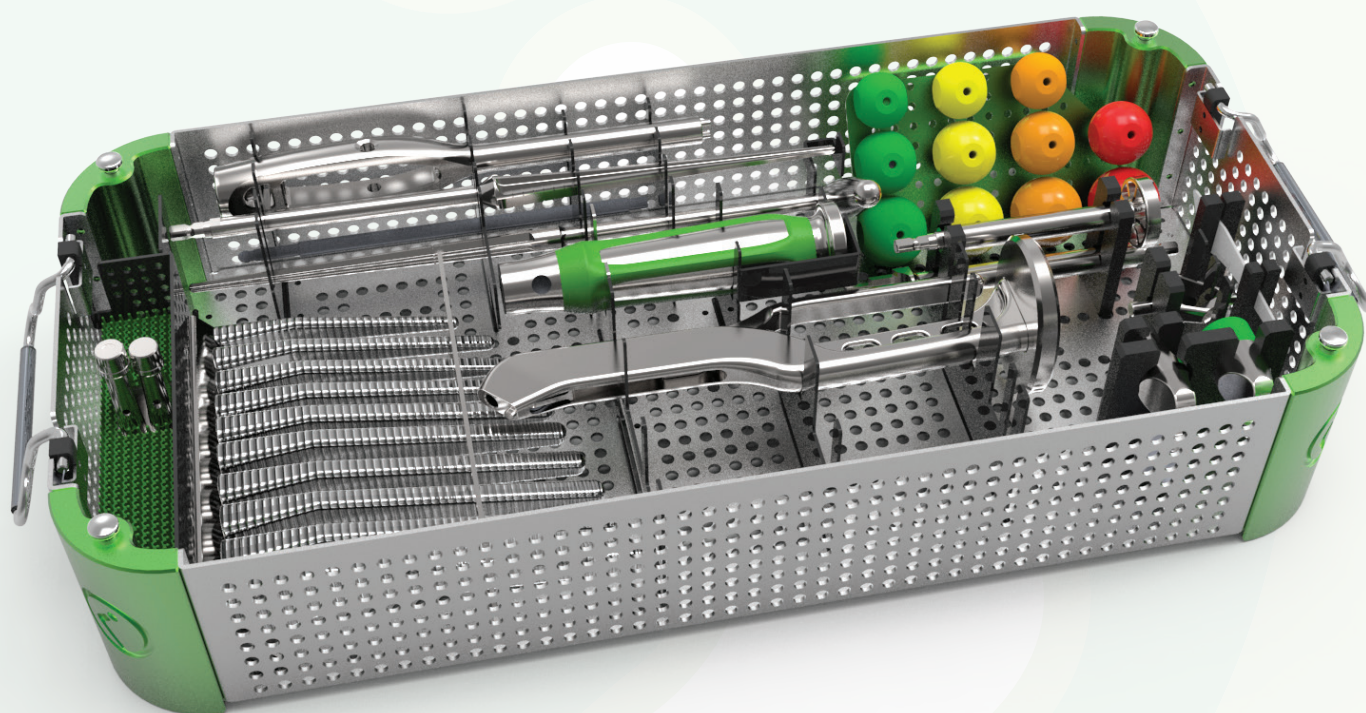

Straight Broach Handle

112-182-032



Short Broach Handle

112-25-0146

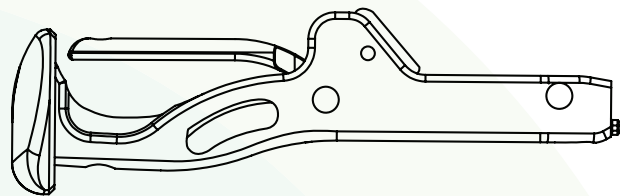

Calcar Reamer

P12-01-0012

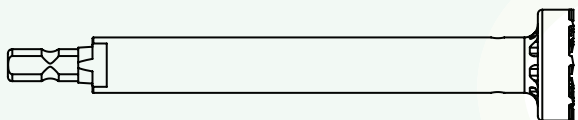

Curved Broach Handle

112-182-001

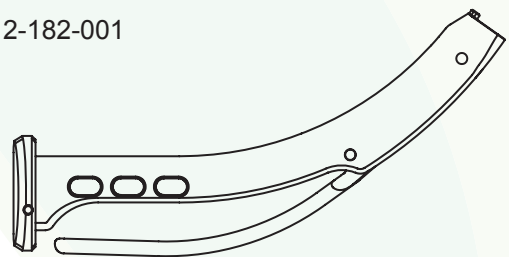

Quick Release Box Chisel

112-212-005

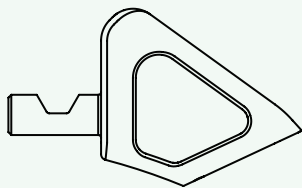

Osteotomy Guide

112-34-0002

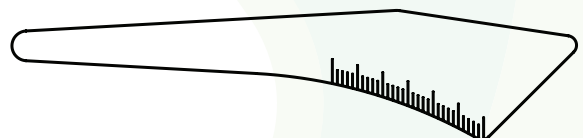

Quick Release Stem Impactor

112-212-006

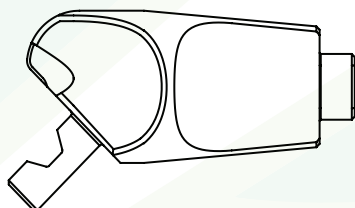

Quick Release Head Impactor

112-212-017

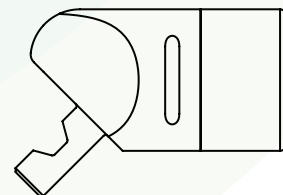

Aria Instruments

Stem Positioner

112-182-027 Outer
112-182-028 Inner

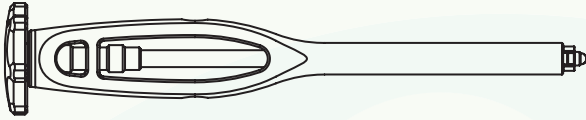

Modular Stem Impactor

112-25-0080 Curved
112-25-0092 Offset
112-25-0093 Bullet Tip



Trochanteric Canal Reamer

112-212-022



IM Drill

112-182-087



Starter Broach

112-34-0001

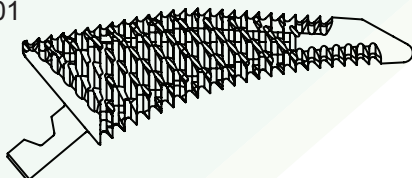

Stem Positioner UniBody

112-212-026

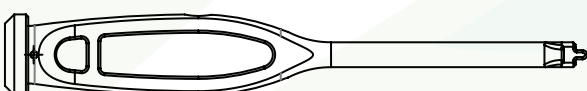

Canal Reamer

112-212-023



Stepped Entry Reamer

112-162-001

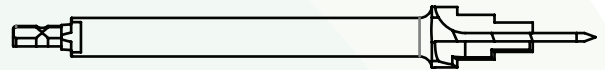

Femoral Head Extractor

112-182-117

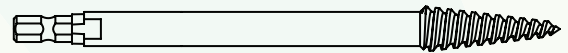

Small Tapered Pin Reamer

112-182-013

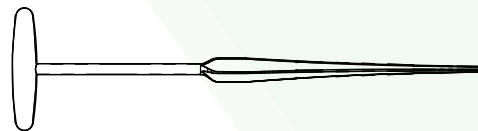

Large Tapered Pin Reamer

112-182-144

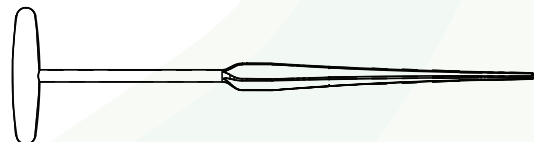

XL Tapered Pin Reamer

112-182-148

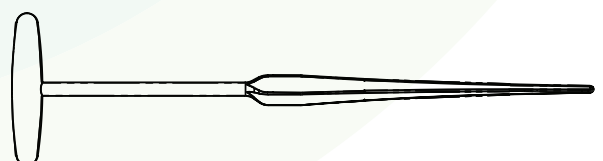

Aria Instruments

Aria Broaches

111-20-6200
111-20-6201
111-20-6202
111-20-6203
111-20-6204
111-20-6205
111-20-6206
111-20-6207
111-20-6208
111-20-6209
111-20-6210
111-20-6211
111-20-6212

Size 0
Size 1
Size 2
Size 3
Size 4
Size 5
Size 6
Size 7
Size 8
Size 9
Size 10
Size 11
Size 12

Distal Reduced Aria Broaches*

111-20-6903
111-20-6904
111-20-6905
111-20-6906
111-20-6907
111-20-6908
111-20-6909
111-20-6910
111-20-6911
111-20-6912

Size 3
Size 4
Size 5
Size 6
Size 7
Size 8
Size 9
Size 10
Size 11
Size 12

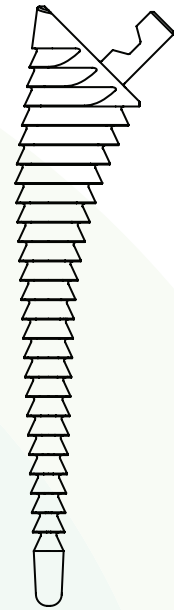

Aria Trial Necks

111-20-6250
111-20-6260
111-20-6251
111-20-6261
111-20-6252
111-20-6262
111-20-6253
111-20-6263
111-20-6254
111-20-6264

Size 0 Standard Offset
Size 0 High Offset
Size 1 Standard Offset
Size 1 High Offset
Size 2-3 Standard Offset
Size 2-3 High Offset
Size 4-7 Standard Offset
Size 4-7 High Offset
Size 8-12 Standard Offset
Size 8-12 High Offset

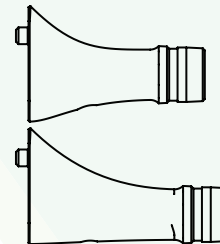

Trial Femoral Heads

112-182-040
112-182-041
112-182-042
112-182-017
112-182-018
112-182-019
112-182-020
112-182-021
112-182-022
112-182-023
112-182-024
112-182-043
112-182-044
112-182-045
112-182-046

Ø28mm -3.5mm Green
Ø28mm 0.0mm Yellow
Ø28mm +3.5mm Orange
Ø32mm -4.0mm Green
Ø32mm 0.0mm Yellow
Ø32mm +4.0mm Orange
Ø32mm +8.0mm Red
Ø36mm -4.0mm Green
Ø36mm 0.0mm Yellow
Ø36mm +4.0mm Orange
Ø36mm +8.0mm Red
Ø40mm -4.0mm Green
Ø40mm 0.0mm Yellow
Ø40mm +4.0mm Orange
Ø40mm +8.0mm Red

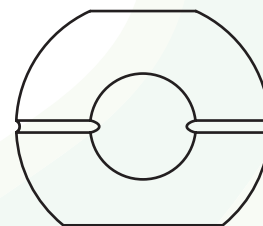

*USA only

Aria Preoperative Templates

111-201-613

Size 0-12 Template

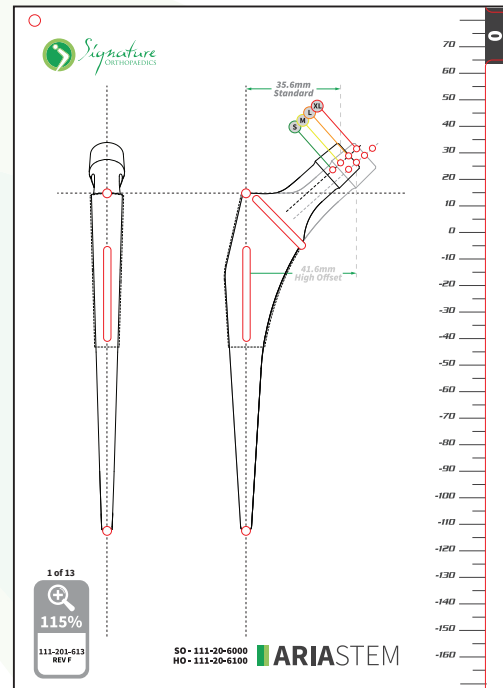

Aria RDS Preoperative Templates

111-201-513

Size 0-12 Template

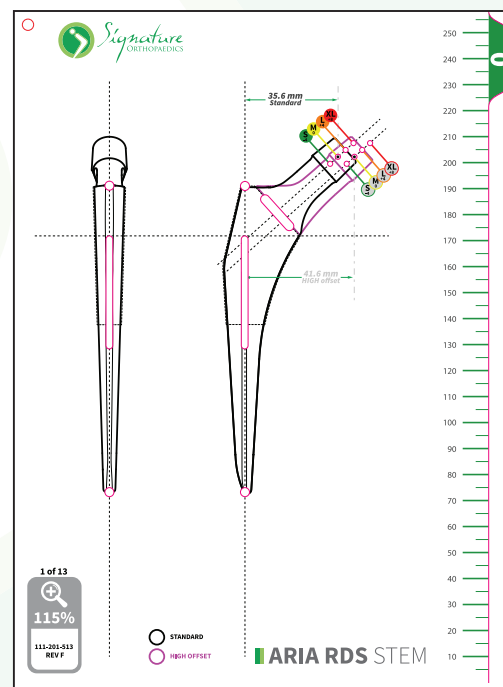

Aria Implants

Aria Standard Offset Stem

111-20-6000	Size 0
111-20-6001	Size 1
111-20-6002	Size 2
111-20-6003	Size 3
111-20-6004	Size 4
111-20-6005	Size 5
111-20-6006	Size 6
111-20-6007	Size 7
111-20-6008	Size 8
111-20-6009	Size 9
111-20-6010	Size 10
111-20-6011	Size 11
111-20-6012	Size 12

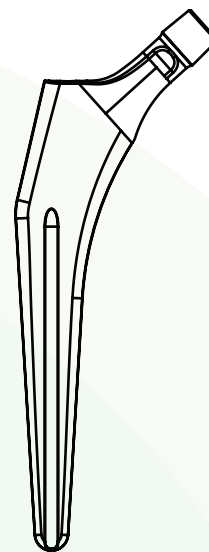

Aria High Offset Stem

111-20-6100	Size 0
111-20-6101	Size 1
111-20-6102	Size 2
111-20-6103	Size 3
111-20-6104	Size 4
111-20-6105	Size 5
111-20-6106	Size 6
111-20-6107	Size 7
111-20-6108	Size 8
111-20-6109	Size 9
111-20-6110	Size 10
111-20-6111	Size 11
111-20-6112	Size 12

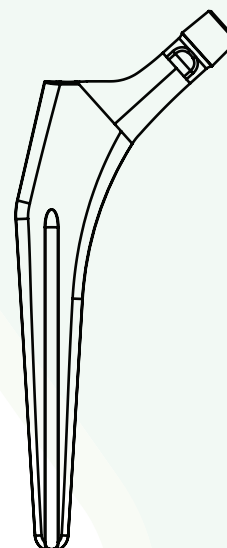

Aria Stem, Standard Offset – Reduced Distal*

111-20-6303	Size 3
111-20-6304	Size 4
111-20-6305	Size 5
111-20-6306	Size 6
111-20-6307	Size 7
111-20-6308	Size 8
111-20-6309	Size 9
111-20-6310	Size 10
111-20-6311	Size 11
111-20-6312	Size 12

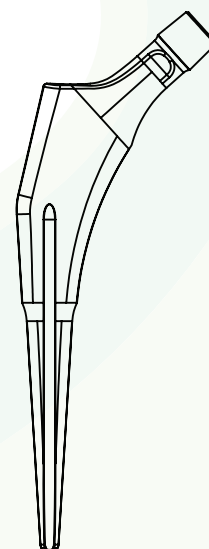

*USA only

Aria Implants

Aria Stem, High Offset – Reduced Distal*

111-20-6403	Size 3
111-20-6404	Size 4
111-20-6405	Size 5
111-20-6406	Size 6
111-20-6407	Size 7
111-20-6408	Size 8
111-20-6409	Size 9
111-20-6410	Size 10
111-20-6411	Size 11
111-20-6412	Size 12

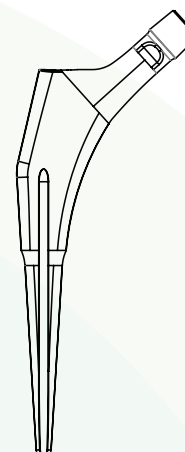

Signature Ceramic Femoral Head

111-152-611	Size 28mm S
111-152-612	Size 28mm M
111-152-613	Size 28mm L
111-152-621	Size 32mm S
111-152-622	Size 32mm M
111-152-623	Size 32mm L
111-152-624	Size 32mm XL
111-152-631	Size 36mm S
111-152-632	Size 36mm M
111-152-633	Size 36mm L
111-152-634	Size 36mm XL
111-152-641	Size 40mm S
111-152-642	Size 40mm M
111-152-643	Size 40mm L
111-152-644	Size 40mm XL
111-152-651	Size 44mm S
111-152-652	Size 44mm M
111-152-653	Size 44mm L
111-152-654	Size 44mm XL

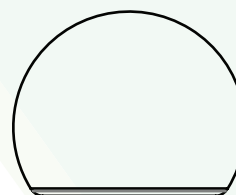

Fusion Ceramic Femoral Head*

111-22-0511	Size 28mm
111-22-0512	Size 32mm
111-22-0513	Size 36mm

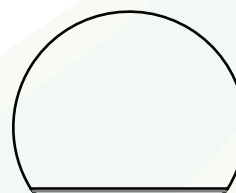

*USA only

Aria Implants

Signature SS Femoral Head

111-152-111	Size 28mm S
111-152-112	Size 28mm M
111-152-113	Size 28mm L
111-152-121	Size 32mm S
111-152-122	Size 32mm M
111-152-123	Size 32mm L
111-152-124	Size 32mm XL
111-152-131	Size 36mm S
111-152-132	Size 36mm M
111-152-133	Size 36mm L
111-152-134	Size 36mm XL

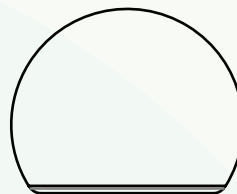

Signature CoCr Femoral Head

111-152-011	Size 28mm S
111-152-012	Size 28mm M
111-152-013	Size 28mm L
111-152-021	Size 32mm S
111-152-022	Size 32mm M
111-152-023	Size 32mm L
111-152-024	Size 32mm XL
111-152-031	Size 36mm S
111-152-032	Size 36mm M
111-152-033	Size 36mm L
111-152-034	Size 36mm XL
111-152-041	Size 40mm S
111-152-042	Size 40mm M
111-152-043	Size 40mm L
111-152-044	Size 40mm XL

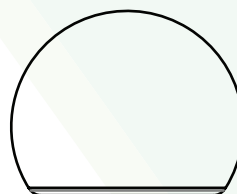

Ti6Al4V Fusion Taper Sleeve*

111-37-0001	Fusion Taper Sleeve -4mm
111-37-0006	Fusion Taper Sleeve -2mm
111-37-0002	Fusion Taper Sleeve 0mm
111-37-0007	Fusion Taper Sleeve +2mm
111-37-0003	Fusion Taper Sleeve +4mm
111-37-0008	Fusion Taper Sleeve +6mm
111-37-0004	Fusion Taper Sleeve +8mm

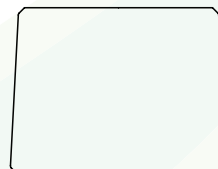

*USA only

Appendix: Broaching Techniques and Tips

It is advised to stop broaching when stability is achieved with a slightly countersunk broach than to attempt to force an oversized broach into the canal. The coating limit line on the implant stem will sit below the resection line but the stem should achieve stability. Consider a longer neck or higher head offset.

Managing Different Femoral Canal Geometries

The Dorr femur type system classifies femurs based on a ratio that relates to the geometry of the femoral canal:

$$R = D_2/D_1$$

see figures at the bottom left

An R-value less than ~0.5 implies a very fluted canal that will more likely bind distally if the canal is not over-reamed. Preoperative templating is especially important for this reason. Refer to the Aria Implant Sizing guide in this technique to help decide what size reamer to use. The three types are as follows.

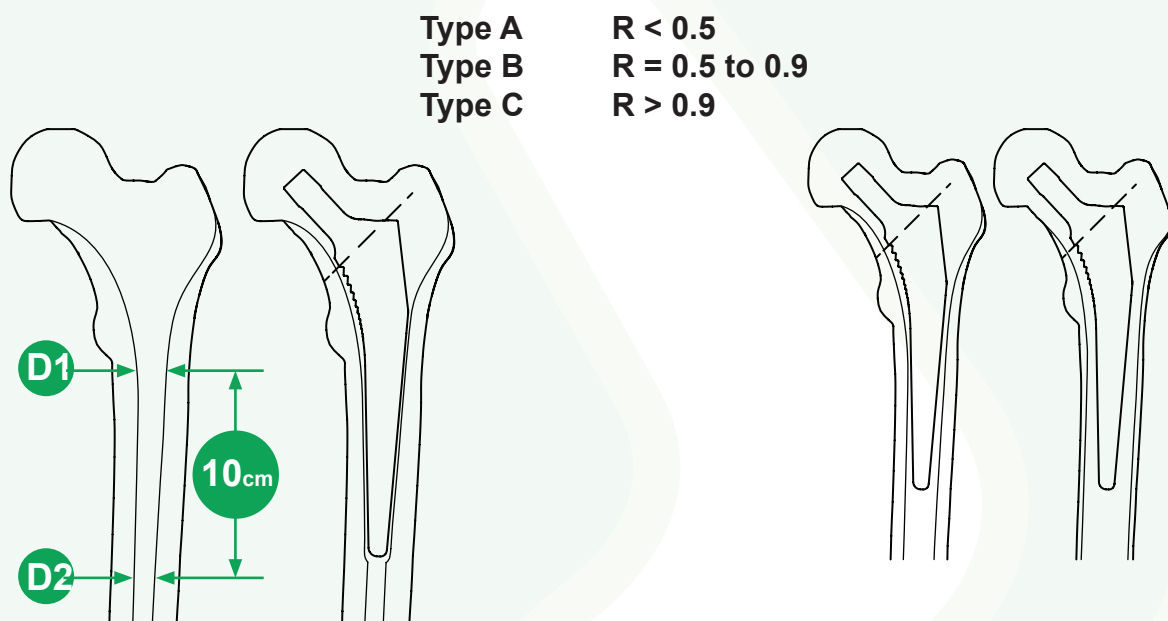

Type A

Reaming the femoral canal to the distal tip of the definitive stem ensures compaction of the metaphyseal cancellous bone and reduced binding against the cortical wall, which can lead to stress shielding and an ill-seated stem

Types B & C

The Aria broaches preserve the natural anatomy of the femoral canal. Rotational and axial stability and a change in pitch indicate an appropriate amount of compaction broaching.

**AUSTRALIA**

7 Sirius Rd Lane Cove West
NSW 2066, Australia
Tel +61 2 9428 5181
Fax: +61 2 8456 6065
www.signatureortho.com.au

USA

3150 Stage Post Drive,
Suite 104,
Bartlett TN 38133
Tel: +1 844 762 9221
Fax: +1 855 630 9555
info@signatureortho.us

IRELAND

Unit A, IDA Business and Technol-
ogy Park, Garrycastle, Athlone, N37
DY26, Ireland
Tel: +353 (0) 906400539
info@signatureortho.com.eu

FRANCE

Espace Entreprises – L'Arobase,
2 Rue Georges Charpak F-81100
CASTRES
Tel: +33(0)5 6373 5183
Fax: +33(0)5 6373 5184
info@signatureortho.eu

