

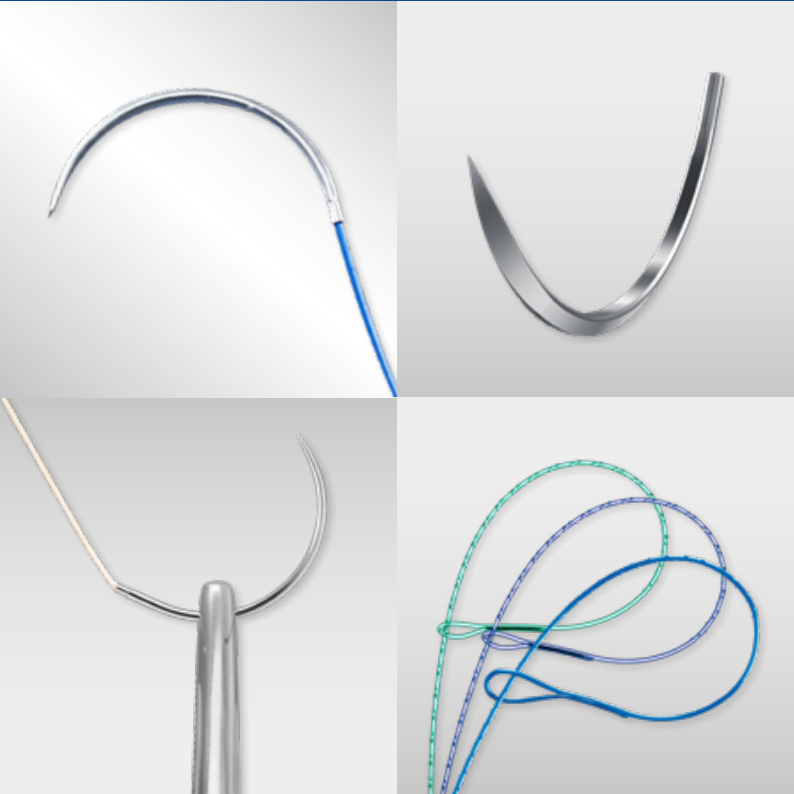

OPERATING ROOM **ESSENTIALS**

THE COMPLETE
SOLUTION
YOU CAN TRUST



Wound Closure **Catalogue**

December 2020

Medtronic
Further, Together

HOW TO READ A SUTURE LABEL

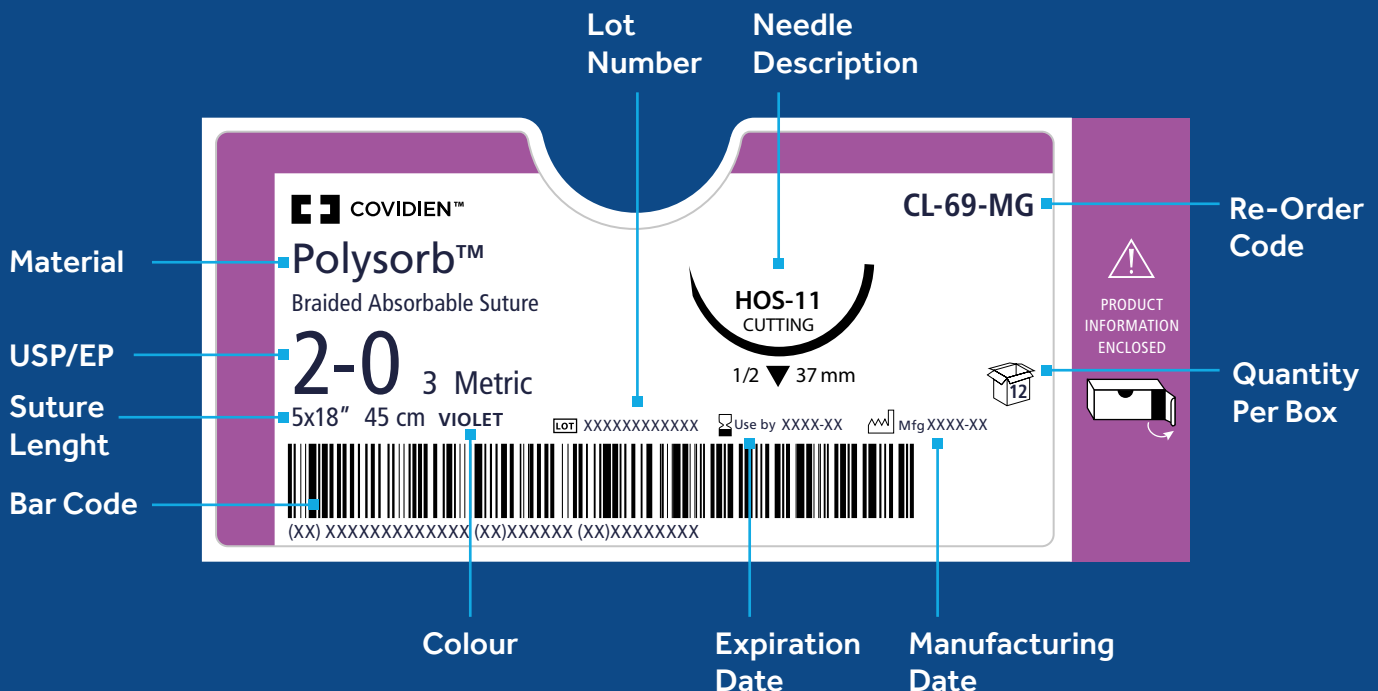
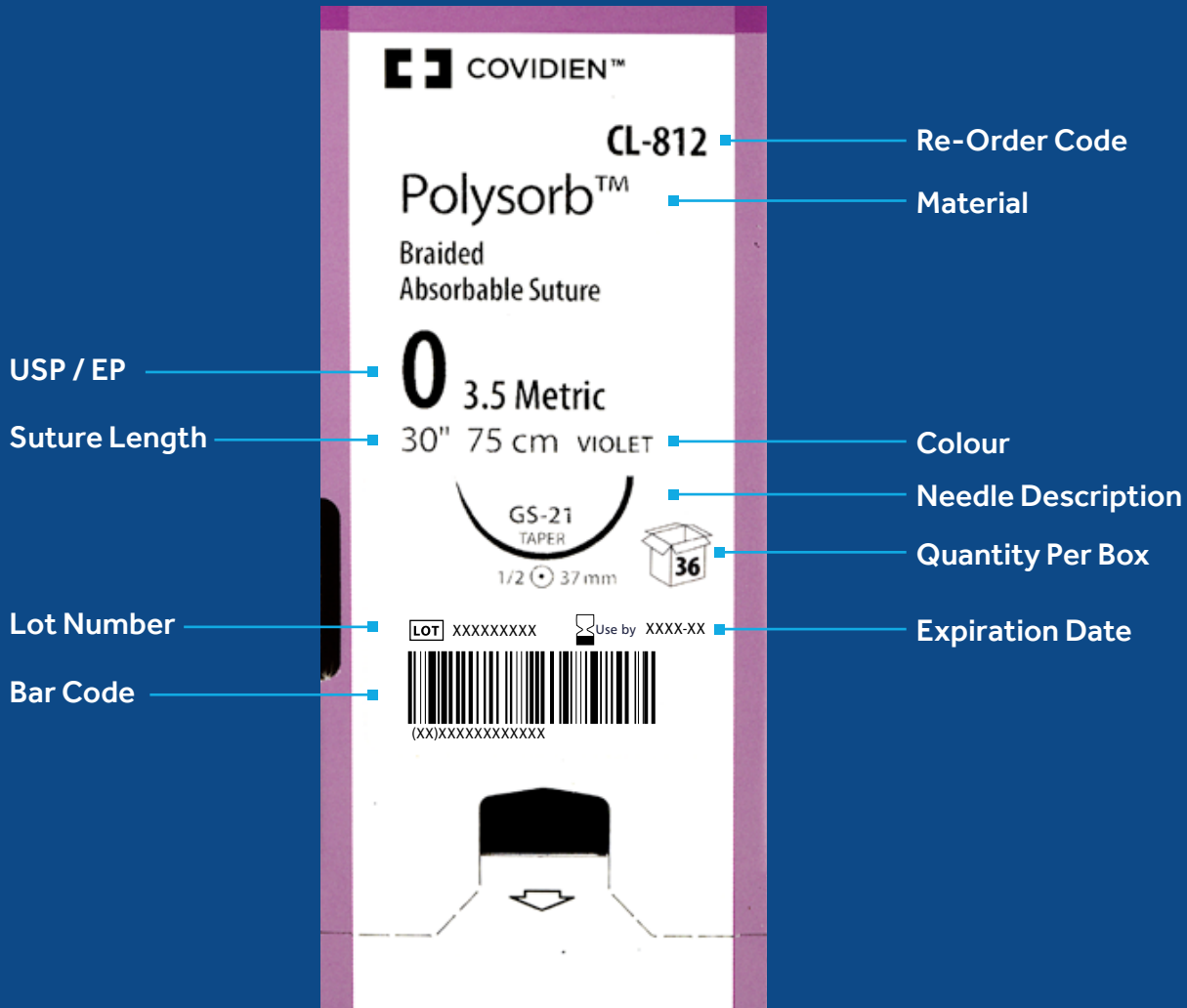

WHY MEDTRONIC?

Medtronic have an extensive heritage in partnerships with Public Hospitals and Private Groups. Delivering value-based healthcare, clinical expertise and innovation through products and services that are focused on patient care and clinical outcomes.

OR ESSENTIALS

We pride ourselves on being a brand you can trust. With our proven track record of **quality products and services**, you can feel reassured that Medtronic's OR Essentials will help you to continue providing **the very best patient care** from the first mark to the last stitch. Let's embrace the future together.



Laparoscopic Access



Surgical Instruments



Wound Closure

INTRODUCTION

A Comprehensive Portfolio of Wound Closure Materials and Accessories

We're all part of the same community. A community entrusted with enhancing and saving the lives of patients. At Medtronic, we actively partner with you to provide your patients with the most optimal care. Every day. Whatever role you play, we're here for you — leveraging over 100 years of expertise and insight to innovate wound closure solutions. We are committed to remaining by your side for the next 100 years, evolving with your changing needs so you can keep delivering the highest levels of patient care. Our comprehensive portfolio of effective wound closure solutions is for the full spectrum of general and specialty procedures.

Absorbable Sutures

Absorbable sutures from Medtronic provide strength retention and absorption profiles to meet your surgical specialty and tissue healing requirements.

Non-Absorbable Sutures

Non-absorbable sutures from Medtronic can be used in a range of procedures, including cardiovascular, ophthalmic and neurological surgery.





















Barbed Wound Closure

The V-Loc™ wound closure device is a revolutionary technology that eliminates the need to tie knots, so you can close incisions up to 50% faster without compromising strength and security.

Wound Closure Accessories

Wound closure accessories from Medtronic include bone wax, bolsters, suture racks, polyester and umbilical tape.

CONTENTS

	Velosorb™ Fast	6
	Polysorb™	18
	Caprosyn™	50
	Biosyn™	60
	Maxon™ / Maxon™ CV	76
	Surgipro™ / Surgipro™ II	94
	Ti-Cron™ / Surgidac™	114
	Pledgets	136
	Vascufil™	140
	Flexon™	144
	Steel	148
	Dermalon™ / Monosof™	154
	Novafil™	172
	Surgilon™	182
	Sofsilk™	190
	V-Loc™ 90 Absorbable	208
	V-Loc™ 180 Absorbable	214
	V-Loc™ PBT	220
	Wound closure accessories	224
	Endoscopic sutures	224
	Needles chart	226
	Ordering information	230

VELOSO RB™ FAST

Braided Fast Absorbable Suture

There when you need it. Gone when you don't.





Please refer to the individual package IFUs for complete instructions, indications, contraindications, warnings and precautions.

Description	Velosorb™ Fast absorbable braided sutures are composed of an absorbable synthetic polyester comprised of glycolide and lactide (derived from glycolic and lactic acids). Velosorb™ Fast absorbable sutures are prepared by coating the suture with a mixture of a glycolide and lactide copolymer and calcium stearate.
Indications	Velosorb™ Fast absorbable sutures are indicated for use in soft tissue approximation of the skin, mucosa and conjunctiva, where only 7-10 days of wound support is required, but not for use in ligation, cardiovascular or neurological tissue.
Actions	Velosorb™ Fast absorbable sutures elicit a minimal acute inflammatory reaction in tissue, which is followed by a gradual encapsulation of the suture by fibrous connective tissue. Progressive loss of tensile strength and eventual absorption of Velosorb™ Fast absorbable sutures occurs by means of hydrolysis, where the glycolide/lactide copolymer is broken down to glycolic and lactic acids which are subsequently absorbed and metabolized by the body.
Tensile Strength	Studies indicate tensile strength averages for Velosorb™ Fast absorbable sutures are no less than 45% of its original tensile strength 5 days post implantation. All of the original tensile strength is essentially gone by 14 days.
Sterilization	Gamma irradiation.
Absorbtion	Absorption begins as a loss of tensile strength without appreciable loss of mass. Absorption of Velosorb™ Fast absorbable sutures is essentially complete between the 40 th and 50 th day.
Packaging	Velosorb™ Fast absorbable sutures are available in USP sizes 1 (4 Metric) through 6–0 (0.7 Metric). They are available undyed (natural). The sutures are supplied sterile, in pre-cut lengths affixed to various needle types. Please refer to the individual package IFUs for complete instructions, indications, contraindications, warnings and precautions.





Velosorb™ Fast absorbable suture

Fast braided absorbable suture for use in soft tissue approximation of the skin and mucosa, when only 7–10 days of wound support is required.





PRE-CUT							
Needles Specifications	Size		Length cm	Color	Units Per box	Comments	Reorder code
	USP	EP					
	4-0	1.5	6 × 45	Undyed	36		CV-8977
	4-0	1.5	3 × 45	Undyed	36		CV-8643
	3-0	2	6 × 45	Undyed	36		CV-8978
	3-0	2	3 × 45	Undyed	36		CV-8644
	2-0	3	6 × 45	Undyed	36		CV-8979
	2-0	3	5 × 75	Undyed	36		CV-8653
	0	3.5	6 × 45	Undyed	36		CV-8980

REVERSE CUTTING							
Needles Specifications	Size		Length cm	Color	Units Per box	Comments	Reorder code
	USP	EP					
C-1 3/8 Circle 12 mm 	5-0	1	75	Undyed	36		SV-2289
	4-0	1.5	45	Undyed	36		SV-1290
	4-0	1.5	75	Undyed	36		SV-2290
C-12 3/8 Circle 16 mm 	5-0	1	75	Undyed	36		SV-2296
	4-0	1.5	75	Undyed	36		SV-2294
	3-0	2	75	Undyed	36		SV-2295







REVERSE CUTTING

Needles Specifications	Size USP	EP	Length cm	Color	Units Per box	Comments	Reorder code
C-13 3/8 Circle 19 mm 	5-0	1	45	Undyed	36		SV-2910
	4-0	1.5	45	Undyed	36		SV-2920
	4-0	1.5	75	Undyed	36		SV-2297
	3-0	2	45	Undyed	36		SV-2930
	3-0	2	75	Undyed	36		SV-2298
	2-0	3	75	Undyed	36		SV-2299
C-14 3/8 Circle 24 mm 	4-0	1.5	75	Undyed	36		SV-2251
	3-0	2	45	Undyed	36		SV-4431
	3-0	2	75	Undyed	36		SV-2252
	2-0	3	75	Undyed	36		SV-2253
C-15 3/8 Circle 26 mm 	3-0	2	75	Undyed	12		SV-9940G
	2-0	3	75	Undyed	12		SV-9941G
C-16 3/8 Circle 30 mm 	3-0	2	90	Undyed	36		SV-2285
	2-0	3	90	Undyed	36		SV-2286
	0	3.5	90	Undyed	36		SV-2287
C-17 3/8 Circle 39 mm 	2-0	3	75	Undyed	12		SV-9961G

REVERSE CUTTING

Needles Specifications	Size		Length cm	Color	Units Per box	Comments	Reorder code
	USP	EP					
C-22 1/2 Circle 18 mm 	4-0	1.5	45	Undyed	36		SV-4550
C-23 1/2 Circle 24 mm 	4-0	1.5	45	Undyed	36		SV-9926
	3-0	2	45	Undyed	36		SV-9927
	2-0	3	45	Undyed	36		SV-9928
GS-10 1/2 Circle 26 mm 	2-0	3	75	Undyed	12		CV-9936G
GS-11 1/2 Circle 37 mm 	3-0	2	135	Undyed	12		CV-931G
	2-0	3	90	Undyed	36		CV-4721
	2-0	3	135	Undyed	12		CV-932G
	0	3.5	90	Undyed	36		CV-4731
GS-12 1/2 Circle 40 mm 	0	3.5	90	Undyed	36		CV-485
	1	4	90	Undyed	36		CV-486



PREMIUM REVERSE CUTTING

Needles Specifications	Size		Length cm	Color	Units Per box	Comments	Reorder code
	USP	EP					
P-10 3/8 Circle 11 mm 	6-0	0.7	45	Undyed	36		SV-9913
	6-0	0.7	45	Violet	36		SV-32
	6-0	0.7	75	Undyed	36		SV-4893
	5-0	1	45	Undyed	36		SV-9915
P-13 3/8 Circle 13 mm 	5-0	1	45	Undyed	36		SV-493
	4-0	1.5	45	Undyed	36		SV-494
	4-0	1.5	75	Undyed	36	Surgalloy™	SVP-494
P-11 3/8 Circle 16 mm 	5-0	1	75	Undyed	36	Surgalloy™	SVP-2296
	4-0	1.5	75	Undyed	36	Surgalloy™	SVP-2294
	3-0	2	75	Undyed	36	Surgalloy™	SVP-2295
P-12 3/8 Circle 19 mm 	4-0	1.5	45	Undyed	12		SV-496G
	4-0	1.5	45	Undyed	36		SV-496
	4-0	1.5	75	Undyed	36		SV-426
	4-0	1.5	90	Undyed	36		SV-412
	3-0	2	45	Undyed	12		SV-497G
	3-0	2	75	Undyed	36		SV-425
	2-0	3	75	Undyed	36		SV-424
P-14 3/8 Circle 24 mm 	4-0	1.5	75	Undyed	36		SVP-2251
	3-0	2	45	Undyed	36		SV-6830
	3-0	2	75	Undyed	36		SV-935
	2-0	3	45	Undyed	36		SV-6840
	2-0	3	75	Undyed	36		SV-439
P-17 3/8 Circle 30 mm 	3-0	2	90	Undyed	36		SVP-2285
P-18 3/8 Circle 38 mm 	3-0	2	75	Undyed	12		SV-9937G
	2-0	3	75	Undyed	12		SV-9938G





PREMIUM REVERSE CUTTING

Needles Specifications	Size		Length cm	Color	Units Per box	Comments	Reorder code
	USP	EP					
P-24 1/2 Circle 16 mm 	5-0	1	45	Undyed	12		SV-9910G
	4-0	1.5	45	Undyed	12		SV-9911G







CONVENTIONAL CUTTING

Needles Specifications	Size		Length cm	Color	Units Per box	Comments	Reorder code
	USP	EP					
PC-10 3/8 Circle 13 mm 	5-0	1	45	Undyed	12		SV-834G
	4-0	1.5	45	Undyed	12		SV-835G
PC-11 3/8 Circle 16 mm 	6-0	0.7	75	Undyed	12		SV-489G
	5-0	1	45	Undyed	12		SV-844G
	4-0	1.5	45	Undyed	12		SV-845G
	4-0	1.5	75	Undyed	12		SV-488G
	3-0	2	75	Undyed	12		SV-487G
SC-11 Straight 11 mm 	4-0	1.5	45	Undyed	12		SV-9909G



CONVENTIONAL CUTTING

Needles Specifications	Size		Length cm	Color	Units Per box	Comments	Reorder code
	USP	EP					
SC-1 Straight 51 mm  	4-0	1.5	75	Undyed	36		SV-2238
	3-0	2	75	Undyed	36		SV-2239
	2-0	3	75	Undyed	36		SV-2240
SC-2 Straight 60 mm  	3-0	2	75	Undyed	36		SV-9943
	2-0	3	75	Undyed	12		SV-9944G

TAPER POINT

Needles Specifications	Size		Length cm	Color	Units Per box	Comments	Reorder code
	USP	EP					
CV-1 3/8 Circle 9 mm  	8-0	0.4	30	Violet	12		CV-9916G
CV-23 1/2 Circle 17 mm  	5-0	1	75	Undyed	36		CV-1213
	4-0	1.5	75	Undyed	36		CV-1214
	3-0	2	75	Undyed	36		CV-1215
CV-25 1/2 Circle 22 mm  	4-0	1.5	75	Undyed	36	Optivis™	CV-3100
	3-0	2	75	Undyed	36	Optivis™	CV-3110
	2-0	3	75	Undyed	36		CV-3120

TAPER POINT

Needles Specifications	Size		Length cm	Color	Units Per box	Comments	Reorder code
	USP	EP					
V-20 1/2 Circle 26 mm 	4-0	1.5	75	Undyed	36		CV-415
	3-0	2	75	Undyed	12		CV-416G
	2-0	3	75	Undyed	12		CV-417G
	0	3.5	75	Undyed	36		CV-418
GS-22 1/2 Circle 27 mm 	2-0	3	75	Undyed	36		CV-55
	0	3.5	75	Undyed	36		CV-56
	1	4	75	Undyed	36		CV-57
V-30 1/2 Circle 30 mm 	0	3.5	75	Undyed	36		CV-318
	1	4	75	Undyed	36		CV-319
GS-20 1/2 Circle 34 mm 	2-0	3	75	Undyed	12		CV-9975G
GS-21 1/2 Circle 37 mm 	3-0	2	75	Undyed	36		CV-322
	3-0	2	90	Undyed	36		CV-944
	2-0	3	75	Undyed	36		CV-323
	2-0	3	90	Undyed	36		CV-945
	0	3.5	75	Undyed	36		CV-1324
	0	3.5	90	Undyed	36		CV-946
	1	4	90	Undyed	36		CV-947

TAPER POINT

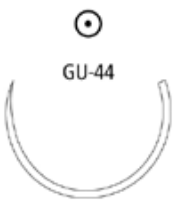
Needles Specifications	Size		Length cm	Color	Units Per box	Comments	Reorder code
	USP	EP					
GS-24 1/2 Circle 40 mm 	2-0	3	90	Undyed	36		CV-9592
	0	3.5	90	Undyed	36		CV-9591
	1	4	90	Undyed	36		CV-9590
GS-25 1/2 Circle 48 mm 	2-0	3	90	Undyed	36		CV-606
	0	3.5	90	Undyed	36		CV-604
	1	4	90	Undyed	36		CV-605
GU-45 5/8 Circle 37 mm 	2-0	3	75	Undyed	36		UV-412
	1	4	90	Undyed	36		UV-401
GU-44 5/8 Circle 40 mm 	0	3.5	90	Undyed	36		UV-1381
	1	4	90	Undyed	36		UV-1382
ST-4 Straight 19 mm 	4-0	1.5	75	Undyed	36		CV-1673

TAPERCUTTING

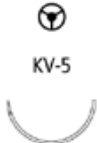
Needles Specifications	Size USP	EP	Length cm	Color	Units Per box	Comments	Reorder code
KV-11 3/8 Circle 13 mm 	5-0	1	75	Undyed	36		CV-2293
KV-15 3/8 Circle 17 mm 	4-0	1.5	45	Undyed	12		CV-2275G
	4-0	1.5	75	Undyed	36		CV-2279
	3-0	2	75	Undyed	36		CV-2280
KV-5 1/2 Circle 17 mm 	3-0	2	75	Undyed	12		CV-1674G
KV-7 1/2 Circle 26 mm 	3-0	2	75	Undyed	12		CV-2003G
	2-0	3	90	Undyed	36		CV-1002
KV-34 1/2 Circle 37 mm 	3-0	2	90	Undyed	36		CV-916
	2-0	3	90	Undyed	36		CV-917
	2-0	3	120	Undyed	36		CV-927
	0	3.5	90	Undyed	36		CV-919
	1	4	90	Undyed	36		CV-918
KV34-C14 1/2 Circle 40 mm Double-arm	2-0	3.5/3	2×90	Undyed	24	2 strands KV-34	CV-0146
	0	3.5/3	1×70	Undyed	24	1 strand C-14	Episiotomy set

TAPERCUTTING

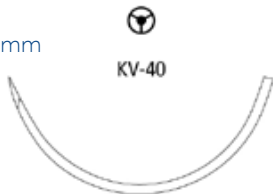
Needles Specifications	Size		Length cm	Color	Units Per box	Comments	Reorder code
	USP	EP					
KV-37 1/2 Circle 40 mm 	2-0	3	90	Undyed	36		CV-2218
	0	3.5	90	Undyed	36		CV-2217
	1	4	90	Undyed	36		CV-2216
KV37-C-14 1/2 Circle 40.0 mm Double-arm	2-0	3.5/3	1 x 70	Undyed	24	1 strand C-14	CV-0046
	0	3.5/3	2 x 90	Undyed	24	2 strands KV-37	Episiotomy set
KV-40 1/2 Circle 48 mm 	2-0	3	90	Undyed	36		CV-7192
	0	3.5	90	Undyed	36		CV-7191
	1	4	90	Undyed	36		CV-7190

BLUNT POINT

Needles Specifications	Size		Length cm	Color	Units Per box	Comments	Reorder code
	USP	EP					
BGS-24 1/2 Circle 40 mm 	0	3.5	90	Undyed	36		CV-9953

SPATULA

Needles Specifications	Size		Length cm	Color	Units Per box	Comments	Reorder code
	USP	EP					
SE-140-8 3/8 Circle 6.3 mm Curvature 140° 	8-0	0.4	30	Violet	12		CV-501G
	7-0	0.5	30	Violet	12		CV-500G

POLYSORB™

Braided Absorbable Suture

Stronger¹ during the critical wound healing period



1. van Ramshorst GH et al. World J Surg 2010;54:20–7

Please refer to the individual package IFUs for complete instructions, indications, contraindications, warnings and precautions.

Description	Polysorb™ braided sutures are composed of Lactomer™ glycolide/lactide copolymer which is a synthetic polyester composed of glycolide and lactide (derived from glycolic and lactic acids). Polysorb™ sutures are prepared by coating the suture with a mixture of a caprolactone/glycolide copolymer and calcium stearoyl lactylate.
Indications	Polysorb™ sutures are indicated for use in soft tissue approximation or ligation and ophthalmic surgery, but not in cardiovascular or neural tissue.
Actions	Polysorb™ sutures elicit a minimal acute inflammatory reaction in tissue, which is followed by a gradual encapsulation of the suture by fibrous connective tissue. Progressive loss of tensile strength and eventual absorption of Polysorb™ sutures occurs by means of hydrolysis, where the Lactomer™ glycolide/lactide copolymer is broken down to glycolic and lactic acids which are subsequently absorbed and metabolized by the body.
Tensile Strength	Studies indicate tensile strength averages for Polysorb™ sutures are approximately 140% of USP and E.P. minimum knot strength initially, are approximately 80% after two weeks and in excess of 30% at three weeks post implant.
Sterilization	Ethylene oxide.
Absorbtion	Absorption begins as a loss of tensile strength without appreciable loss of mass. Absorption of Polysorb™ sutures is essentially complete between the 56 th and 70 th day.
Packaging	Polysorb™ sutures are available in USP sizes 2 (5 Metric) through 8-0 (0.4 Metric). They are available undyed (natural) or violet colored. The sutures are supplied sterile, in pre-cut lengths and ligating reels, non-neededled or affixed to various needle types using both permanent and removable needle attachment techniques. Please refer to the individual package IFUs for complete instructions, indications, contraindications, warnings and precautions.

Polysorb™

Polysorb™ suture is a brand you have trusted for over 20 years with a history of improvements and performance.

PRE-CUT							
Needles Specifications	Size		Length cm	Color	Units Per box	Comments	Reorder code
	USP	EP					
	4-0	1.5	3×45	Violet	36	Pre-cut	L-71
	4-0	1.5	6×45	Violet	24	Pre-cut	L-20
	4-0	1.5	12×45	Violet	24	Pre-cut	L-11
	4-0	1.5	12×45	Undyed	24	Pre-cut	L-1-
	3-0	2	3×45	Violet	36	Pre-cut	L-72
	3-0	2	6×45	Violet	24	Pre-cut	L-22
	3-0	2	12×45	Undyed	24	Pre-cut	L-2-
	3-0	2	12×45	Violet	24	Pre-cut	L-12
	3-0	2	12×60	Violet	24	Pre-cut	L-32
	3-0	2	3×75	Violet	24	Pre-cut	L-402
	3-0	2	6×75	Violet	24	Pre-cut	L-38
	2-0	3	3×45	Violet	36	Pre-cut	L-73
	2-0	3	12×45	Undyed	24	Pre-cut	L-3
	2-0	3	6×45	Violet	24	Pre-cut	L-23
	2-0	3	12×45	Violet	24	Pre-cut	L-13-
	2-0	3	12×60	Violet	24	Pre-cut	L-33
	2-0	3	12×75	Undyed	24	Pre-cut	L-43
	2-0	3	3×75	Violet	24	Pre-cut	L-403
	2-0	3	6×75	Violet	24	Pre-cut	L-39
	0	3.5	3×45	Violet	36	Pre-cut	L-74
	0	3.5	6×45	Undyed	24	Pre-cut	L-4
	0	3.5	12×45	Violet	24	Pre-cut	L-27
	0	3.5	12×45	Undyed	24	Pre-cut	L-24
	0	3.5	6×45	Violet	24	Pre-cut	L-14
	0	3.5	12×60	Violet	24	Pre-cut	L-34
	0	3.5	3×75	Violet	24	Pre-cut	L-404
	0	3.5	6×75	Violet	24	Pre-cut	L-40
	1	4	3×45	Violet	36	Pre-cut	L-75
	1	4	6×45	Undyed	24	Pre-cut	L-5
	1	4	12×45	Violet	24	Pre-cut	L-35
	1	4	12×45	Undyed	24	Pre-cut	L-25
	1	4	6×45	Violet	24	Pre-cut	L-15
	1	4	12×60	Violet	24	Pre-cut	L-36

PRE-CUT

Needles Specifications	Size		Length cm	Color	Units Per box	Comments	Reorder code
	USP	EP					
	1	4	6×75	Violet	24	Pre-cut	L-41
	1	4	3×75	Violet	24	Pre-cut	L-405
	2	5	3×45	Violet	36	Pre-cut	L-76
	2	5	12×45	Violet	24	Pre-cut	L-28
	2	5	12×45	Undyed	24	Pre-cut	L-26
	2	5	6×75	Violet	24	Pre-cut	L-42
	2	5	3×75	Violet	24	Pre-cut	L-406



STANDARD LENGTH

Needles Specifications	Size		Length cm	Color	Units Per box	Comments	Reorder code
	USP	EP					
	4-0	1.5	150	Violet	36	Standard length	L-111
	3-0	2	150	Undyed	36	Standard length	L-102
	3-0	2	150	Violet	36	Standard length	L-112
	2-0	3	150	Undyed	36	Standard length	L-103
	2-0	3	150	Violet	36	Standard length	L-113
	0	3.5	150	Violet	36	Standard length	L-114
	0	3.5	150	Undyed	36	Standard length	L-104
	2	5	150	Violet	36	Standard length	L-116
	1	4	150	Violet	36	Standard length	L-115





REEL

Needles Specifications	Size		Length cm	Color	Units Per box	Comments	Reorder code
	USP	EP					
	4-0	1.5	150	Violet	24	Reel	LL-111
	4-0	1.5	150	Undyed	24	Reel	LL-101
	4-0	1.5	250	Violet	24	Reel	LL-221
	3-0	2	150	Violet	24	Reel	LL-112
	3-0	2	150	Undyed	24	Reel	LL-102
	3-0	2	250	Undyed	24	Reel	LL-322
	3-0	2	250	Violet	24	Reel	LL-222
	2-0	3	150	Violet	24	Reel	LL-113
	2-0	3	150	Undyed	24	Reel	LL-103
	2-0	3	250	Undyed	24	Reel	LL-323
	2-0	3	250	Violet	24	Reel	LL-223
	2-0	3	366	Violet	24	Reel	LL-233
	0	3.5	150	Violet	24	Reel	LL-114
	0	3.5	150	Undyed	24	Reel	LL-104
	0	3.5	250	Violet	24	Reel	LL-224
	1	4	150	Violet	24	Reel	LL-115
	1	4	250	Violet	24	Reel	LL-225
	2	5	150	Violet	24	Reel	LL-116
	2	5	250	Violet	24	Reel	LL-226





REVERSE CUTTING

Needles Specifications	Size USP	EP	Length cm	Color	Units Per box	Comments	Reorder code	
HE-6 3/8 Circle 7.4 mm Double-arm Curvature 110°		6-0	0.7	45	Violet	12	Surgalloy™	L-1551-K
C-1 3/8 Circle 12 mm		6-0	0.7	45	Undyed	36		SL-171
		5-0	1	45	Undyed	36		SL-172
HE-3 3/8 Circle 13 mm Double-arm Curvature 155°		5-0	1	30	Undyed	12	Surgalloy™	L-4323K

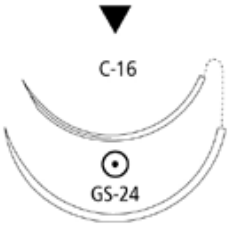

REVERSE CUTTING

Needles Specifications	Size USP	EP	Length cm	Color	Units Per box	Comments	Reorder code
C-12 3/8 Circle 16 mm 	5-0	1	75	Violet	36		SL-630
	4-0	1.5	75	Violet	36		SL-607
	4-0	1.5	75	Undyed	36		SL-605
	3-0	2	75	Violet	36		SL-608
C-13 3/8 Circle 19 mm 	5-0	1	45	Undyed	36		SL-639
	5-0	1	75	Violet	36		SL-634
	5-0	1	75	Undyed	36		SL-690
	4-0	1.5	45	Undyed	12		SL-638
	4-0	1.5	75	Undyed	12		SL-691G
	4-0	1.5	75	Undyed	36		SL-691
	4-0	1.5	75	Violet	12		SL-635G
	4-0	1.5	75	Violet	36		SL-635
	3-0	2	45	Undyed	36		SL-637
	3-0	2	75	Undyed	36		SL-822
	3-0	2	75	Undyed	12		SL-822G
	3-0	2	75	Violet	36		SL-636
	C-14 3/8 Circle 24 mm 	4-0	1.5	75	Violet	36	
4-0		1.5	75	Undyed	36		SL-692
3-0		2	75	Undyed	36		SL-693
3-0		2	75	Violet	36		SL-694
2-0		3	75	Undyed	36		SL-823
2-0		3	75	Violet	36		CL-823
C-15 3/8 Circle 26 mm 	3-0	2	5 × 45	Undyed	12	D-Tach™	SL-73-MG
	2-0	3	75	Undyed	36		SL-586
	0	3.5	75	Undyed	36		SL-587



REVERSE CUTTING

Needles Specifications	Size		Length cm	Color	Units Per box	Comments	Reorder code
	USP	EP					
C-16 3/8 Circle 30 mm 	3-0	2	75	Undyed	36		SL-696
	2-0	3	75	Violet	36		SL-714
	2-0	3	75	Undyed	36		SL-611
	0	3.5	75	Violet	36		SL-713
	0	3.5	75	Undyed	36		SL-610
	0	3.5	90	Violet	36		SL-712
C-16 - GS-24 3/8 Circle 30 mm Double-arm (Not to scale) 	3-0	2	150	Undyed	36		CL-976
	2-0	3	150	Undyed	36		CL-977
C-17 3/8 Circle 39 mm 	2-0	3	75	Undyed	36		SL-674
	2	5	90	Undyed	36		SL-675
C-23 1/2 Circle 24 mm 	3-0	2	45	Undyed	36		CL-85
	3-0	2	5 × 45	Undyed	12	D-Tach™	SL-85-MG
	3-0	2	5 × 45	Violet	12	D-Tach™	SL-83-MG
	3-0	2	75	Violet	36		SL-632
	3-0	2	75	Undyed	36		SL-613
	2-0	3	75	Violet	36		SL-631
	2-0	3	75	Undyed	36		SL-612
GS-10 1/2 Circle 26 mm 	3-0	2	5 × 45	Undyed	12	D-Tach™	CL-53MG
	3-0	2	75	Undyed	36		CL-868
	2-0	3	5 × 45	Undyed	12	D-Tach™	CL-52-MG
	2-0	3	75	Undyed	36		CL-869
	2-0	3	75	Violet	36		CL-769
	0	3.5	75	Undyed	36		CL-870
	1	4	75	Undyed	36		CL-867

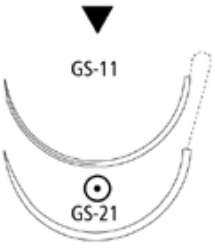

REVERSE CUTTING

Needles Specifications	Size		Length cm	Color	Units Per box	Comments	Reorder code
	USP	EP					
HOS-10 1/2 Circle 26 mm 	2-0	3	3 × 45	Violet	12	D-Tach™	CL-356-MG
	2-0	3	3 × 45	Undyed	12	D-Tach™	CL-354-MG
	0	3.5	5 × 45	Undyed	12	D-Tach™	CL-55-MG
	0	3.5	3 × 45	Undyed	12	D-Tach™	CL-355-MG
	1	4	3 × 45	Violet	12	D-Tach™	CL-358-MG
	1	4	75	Undyed	36		CL-581
	1	4	75	Violet	36		CL-547
	2	5	75	Violet	36		CL-552
C-25 1/2 Circle 30 mm 	2-0	3	75	Violet	36		SL-622
	0	3.5	90	Undyed	36		SL-721
	1	4	90	Violet	36		SL-722
GS-11 1/2 Circle 37 mm 	3-0	2	75	Violet	36		CL-815
	3-0	2	75	Undyed	36		CL-542
	2-0	3	75	Violet	36		CL-816
	2-0	3	75	Undyed	36		CL-543
	2-0	3	90	Violet	36		CL-916
	0	3.5	75	Violet	36		CL-817
	0	3.5	75	Undyed	36		CL-544
	0	3.5	90	Violet	36		CL-917
	0	3.5	90	Undyed	36		CL-534
	1	4	75	Violet	36		CL-818
	1	4	75	Undyed	36		CL-545
	1	4	90	Violet	36		CL-918
	1	4	90	Undyed	36		CL-535
	2	5	90	Violet	36		CL-919
	2	5	90	Undyed	36		CL-533
	GS-11 - GS-21 1/2 Circle 37 mm Double-arm (Not to scale) 	3-0	2	150	Violet	36	
2-0		3	150	Violet	36		CL-992

REVERSE CUTTING

Needles Specifications	Size		Length cm	Color	Units Per box	Comments	Reorder code
	USP	EP					
HOS-11 1/2 Circle 37 mm 	2-0	3	3 × 45	Undyed	12	D-Tach™	CL-374-MG
	2-0	3	3 × 45	Violet	12	D-Tach™	CL-369-MG
	2-0	3	75	Violet	36		CL-526
	2-0	3	75	Undyed	36		CL-536
	0	3.5	3 × 45	Undyed	12	D-Tach™	CL-375-MG
	0	3.5	3 × 45	Violet	12	D-Tach™	CL-370-MG
	0	3.5	75	Undyed	36		CL-537
	1	4	75	Undyed	36		CL-538
	1	4	75	Violet	36		CL-528
GS-12 1/2 Circle 40 mm 	2-0	3	75	Violet	36		CL-833
	2-0	3	75	Undyed	36		CL-595
	0	3.5	75	Violet	36		CL-804
	0	3.5	75	Undyed	36		CL-596
	0	3.5	90	Violet	36		CL-933
	1	4	75	Violet	36		CL-805
	1	4	75	Undyed	36		CL-597
	1	4	90	Violet	36		CL-936
	2	5	90	Violet	36		CL-937
HOS-12 1/2 Circle 40 mm 	2-0	3	3 × 45	Violet	12	D-Tach™	CL-382-MG
	0	3.5	3 × 45	Violet	12	D-Tach™	CL-380-MG
	0	3.5	3 × 45	Undyed	12	D-Tach™	CL-376-MG
	1	4	3 × 45	Violet	12	D-Tach™	CL-381-MG
	1	4	3 × 45	Undyed	12	D-Tach™	CL-377-MG
	1	4	5 × 75	Violet	12	D-Tach™	CL-97-MG
	2	5	3 × 45	Violet	12	D-Tach™	CL-383-MG

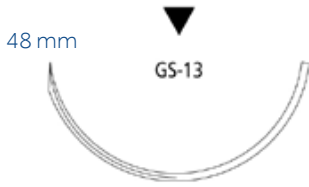

REVERSE CUTTING

Needles Specifications	Size		Length cm	Color	Units Per box	Comments	Reorder code
	USP	EP					
GS-13 1/2 Circle 48 mm 	0	3.5	75	Violet	36		CL-568
	0	3.5	75	Undyed	36		CL-554
	0	3.5	90	Violet	36		CL-927
	1	4	75	Violet	36		CL-569
	1	4	75	Undyed	36		CL-555
	1	4	90	Violet	36		CL-928
	2	5	75	Violet	36		CL-570
	2	5	90	Undyed	36		CL-939
	2	5	90	Violet	36		CL-929
	HOS-14 1/2 Circle 55 mm 	2	5	75	Violet	36	





PREMIUM REVERSE CUTTING

Needles Specifications	Size		Length cm	Color	Units Per box	Comments	Reorder code
	USP	EP					
P-10 3/8 Circle 11 mm 	7-0	0.5	45	Undyed	12		SL-1624G
	6-0	0.7	45	Undyed	36	Surgalloy™	SL-1625
	6-0	0.7	45	Undyed	12	Surgalloy™	SL1625G
	5-0	1	45	Undyed	36	Surgalloy™	SL-1689
	5-0	1	45	Undyed	12	Surgalloy™	SL-1689G

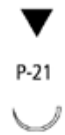

PREMIUM REVERSE CUTTING

Needles Specifications	Size USP	EP	Length cm	Color	Units Per box	Comments	Reorder code
P-13 3/8 Circle 13 mm 	6-0	0.7	45	Undyed	36	Surgalloy™	SL-5688
	6-0	0.7	45	Undyed	12	Surgalloy™	SL-5688-G
	5-0	1	45	Undyed	12	Surgalloy™	SL-5687G
	5-0	1	45	Undyed	36	Surgalloy™	SL-5687
	4-0	1.5	45	Undyed	12	Surgalloy™	SL-5691G
	4-0	1.5	45	Undyed	36	Surgalloy™	SL-5690
P-11 3/8 Circle 16 mm 	5-0	1	45	Undyed	36	Surgalloy™	SL-5626
	4-0	1.5	45	Undyed	36	Surgalloy™	SL-5686
	4-0	1.5	45	Undyed	12	Surgalloy™	SL-5686G
	4-0	1.5	75	Undyed	36	Surgalloy™	SL-5620
	3-0	2	75	Undyed	36	Surgalloy™	SL-5621
P-12 3/8 Circle 19 mm 	5-0	1	45	Undyed	12	Surgalloy™	SL-5636-G
	5-0	1	45	Undyed	36	Surgalloy™	SL-5636
	4-0	1.5	45	Violet	36	Surgalloy™	SL-5629
	4-0	1.5	45	Undyed	12	Surgalloy™	SL-5627-G
	4-0	1.5	45	Undyed	36	Surgalloy™	SL-5627
	4-0	1.5	75	Undyed	36	Surgalloy™	SL-5637
	3-0	2	45	Undyed	12	Surgalloy™	SL-5628G
	3-0	2	45	Undyed	36	Surgalloy™	SL-5628
	3-0	2	75	Undyed	36	Surgalloy™	SL-5638



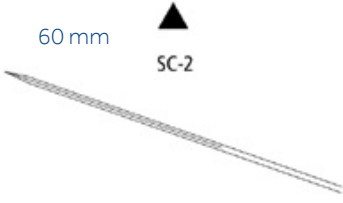

PREMIUM REVERSE CUTTING

Needles Specifications	Size		Length cm	Color	Units Per box	Comments	Reorder code
	USP	EP					
P-14 3/8 Circle 24 mm 	4-0	1.5	45	Undyed	12	Surgalloy™	SL-5641G
	4-0	1.5	45	Undyed	36	Surgalloy™	SL-5641
	4-0	1.5	75	Undyed	36	Surgalloy™	SL-5678
	3-0	2	45	Undyed	12	Surgalloy™	SL-5640G
	3-0	2	45	Undyed	36	Surgalloy™	SL-5640
	3-0	2	75	Undyed	12	Surgalloy™	SL-5679G
	3-0	2	75	Undyed	36	Surgalloy™	SL-5679
	2-0	3	75	Undyed	36		SL-5680
P-17 3/8 Circle 30 mm 	2-0	3	75	Undyed	36		SL-1596
P-21 1/2 Circle 9 mm 	6-0	0.7	45	Undyed	12		SL-1510G
	5-0	1	45	Undyed	12		SL-1644G
	4-0	1.5	45	Undyed	12		SL-1645G
P-22 1/2 Circle 13 mm 	6-0	0.7	45	Undyed	36	Surgalloy™	SL-1613
	5-0	1	45	Undyed	36	Surgalloy™	SL-1614
	5-0	1	45	Undyed	12	Surgalloy™	SL-1614G
	4-0	1.5	45	Undyed	36	Surgalloy™	SL-1615
P-24 1/2 Circle 16 mm 	5-0	1	45	Undyed	12	Surgalloy™	SL-5632G
	5-0	1	45	Undyed	36	Surgalloy™	SL-5632
	4-0	1.5	45	Undyed	12	Surgalloy™	SL-5633G
	4-0	1.5	45	Undyed	36	Surgalloy™	SL-5633



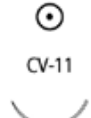

CONVENTIONAL CUTTING

Needles Specifications	Size		Length cm	Color	Units Per box	Comments	Reorder code
	USP	EP					
PC-13 3/8 Circle 11 mm 	6-0	0.7	45	Undyed	36		SL-1660
	5-0	1	45	Undyed	36		SL-1659
	4-0	1.5	45	Undyed	36		SL-1658
PC-11 3/8 Circle 16 mm 	6-0	0.7	45	Undyed	12	Surgalloy™	SL-1655G
	5-0	1	45	Undyed	36		SL-1656
	4-0	1.5	45	Undyed	36		SL-1657
PC-12 3/8 Circle 19 mm 	4-0	1.5	45	Undyed	36		SL-1653
	3-0	2	45	Undyed	36		SL-1654
SC-2 Straight 60 mm 	4-0	1.5	75	Violet	36		SL-654
	4-0	1.5	75	Undyed	36		SL-644
	3-0	2	75	Violet	36		SL-653
	3-0	2	75	Undyed	36		SL-643
	2-0	3	75	Violet	36		SL-652
	2-0	3	75	Undyed	36		SL-642



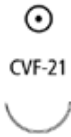
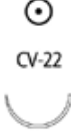

TAPER POINT

Needles Specifications	Size USP	EP	Length cm	Color	Units Per box	Comments	Reorder code
MV-135-5 3/8 Circle 6 mm 	8-0	0.4	13	Violet	12	Surgalloy™	L-2800
CV-11 3/8 Circle 13 mm 	6-0	0.7	75	Violet	36		GL-889-2
	5-0	1	75	Violet	36		GL-890
CV-15 3/8 Circle 17 mm 	4-0	1.5	75	Violet	36		GL-881
	3-0	2	75	Violet	36		GL-882
CV-13 3/8 Circle 22 mm 	4-0	1.5	75	Violet	36		CL-304
	3-0	2	75	Violet	36		GL-303
	2-0	3	75	Violet	36		GL-302
CV-18 3/8 Circle 26 mm 	2-0	3	75	Violet	36		CL-457
CV-17 3/8 Circle 32 mm 	3-0	2	75	Violet	36		GL-522
	2-0	3	75	Violet	36		GL-523
	0	3.5	75	Violet	36		GL-524



TAPER POINT

Needles Specifications	Size USP	EP	Length cm	Color	Units Per box	Comments	Reorder code
CVF-21 1/2 Circle 12 mm 	6-0	0.7	45	Violet	36	Surgalloy™	UL-102
	6-0	0.7	45	Undyed	36	Surgalloy™	UL-101
	5-0	1	45	Undyed	36	Surgalloy™	SL-432
	4-0	1.5	45	Undyed	36		SL-431
CV-22 1/2 Circle 13 mm 	5-0	1	5 × 45	Violet	12	D-Tach™	GL-45-MG
	5-0	1	75	Undyed	36		GL-885
	4-0	1.5	5 × 45	Violet	12	D-Tach™	GL-44-MG
	4-0	1.5	75	Undyed	36		GL-884
	4-0	1.5	75	Violet	36		CL-782
CV-23 1/2 Circle 17 mm 	6-0	0.7	75	Violet	36		UL-201-2
	5-0	1	75	Violet	36		UL-202
	5-0	1	75	Undyed	36		UL-213
	4-0	1.5	5 × 45	Violet	12	D-Tach™	GL-46-MG
	4-0	1.5	75	Violet	36	Surgalloy™	UL-303
	4-0	1.5	75	Undyed	36		UL-212
	3-0	2	5 × 45	Undyed	12	D-Tach™	UL-47-MG
	3-0	2	5 × 45	Violet	12	D-Tach™	GL-47-MG
	3-0	2	75	Violet	36		UL-204
	3-0	2	75	Undyed	36		UL-215
	2-0	3	75	Undyed	36		UL-216
	2-0	3	75	Violet	36		UL-205
CVF-23 1/2 Circle 17 mm 	4-0	1.5	75	Undyed	36	Surgalloy™	UL-214
	4-0	1.5	75	Violet	36	Surgalloy™	UL-203
CVF-23 1/2 Circle 17 mm Double-arm 	4-0	1.5	90	Violet	36	Surgalloy™	CL-219

TAPER POINT

Needles Specifications	Size USP	EP	Length cm	Color	Units Per box	Comments	Reorder code
CV-24 1/2 Circle 20 mm 	4-0	1.5	75	Violet	36		CL-460
	3-0	2	75	Violet	36		CL-461
	2-0	3	75	Violet	36		CL-462
CV-25 1/2 Circle 22 mm 	4-0	1.5	5 × 45	Violet	12	D-Tach™	GL-34-MG
	4-0	1.5	75	Violet	36		GL-181
	4-0	1.5	75	Undyed	36		GL-191
	3-0	2	5 × 45	Violet	12	D-Tach™	GL-33-MG
	3-0	2	75	Violet	36		GL-182
	3-0	2	75	Undyed	36		GL-192
	3-0	2	5 × 75	Violet	12	D-Tach™	GL-182-M
	3-0	2	120	Violet	24	Surgalloy™ Endoscopy	EL-440
	2-0	3	5 × 45	Violet	12	D-Tach™	GL-32-MG
	2-0	3	75	Violet	36		GL-183
CV-25 1/2 Circle 22 mm Double-arm 	3-0	2	90	Violet	36		GL-282
GS-23 1/2 Circle 22 mm 	3-0	2	75	Violet	36		CL-892
	2-0	3	5 × 45	Undyed	12	D-Tach™	CL-42-MG
	2-0	3	75	Violet	36		CL-893
	0	3.5	75	Violet	36		CL-894

TAPER POINT

Needles Specifications	Size		Length cm	Color	Units Per box	Comments	Reorder code	
	USP	EP						
V-20 1/2 Circle 26 mm 	5-0	1	75	Violet	36		GL-120	
	4-0	1.5	5 × 45	Violet	12	D-Tach™	GL-64-MG	
	4-0	1.5	75	Undyed	36	Surgalloy™	GLS-321	
	4-0	1.5	75	Violet	36	Surgalloy™	GLS-121	
	4-0	1.5	5 × 75	Violet	12	D-Tach™	GL-68-M	
	4-0	1.5	75	Undyed	36		GL-321	
	4-0	1.5	75	Violet	36		GL-121	
	3-0	2	5 × 45	Undyed	12	D-Tach™	GL-69-MG	
	3-0	2	5 × 45	Violet	12	D-Tach™	GL-63-MG	
	3-0	2	75	Undyed	36	Surgalloy™	GLS-322	
	3-0	2	75	Violet	36	Surgalloy™	GLS-122	
	3-0	2	5 × 75	Violet	12	D-Tach™	GL-67-M	
	3-0	2	75	Undyed	36		GL-322	
	3-0	2	75	Violet	36		GL-122	
	3-0	2	90	Violet	36		GL-226	
	2-0	3	5 × 45	Violet	12	D-Tach™	GL-62-MG	
	2-0	3	5 × 45	Undyed	12	D-Tach™	GL-61-MG	
	2-0	3	75	Undyed	36	Surgalloy™	GLS-323	
	2-0	3	75	Violet	36	Surgalloy™	GLS-123	
	2-0	3	5 × 75	Violet	12	D-Tach™	GL-66-M	
	2-0	3	75	Undyed	36		GL-323	
	2-0	3	75	Violet	36		GL-123	
	2-0	3	90	Violet	36		GL-125	
	0	3.5	75	Undyed	36		GL-324	
	0	3.5	75	Violet	36		GL-124	
	V-20 1/2 Circle 26 mm Double-arm 	3-0	2	90	Violet	36		GL-332
		2-0	3	90	Violet	36		GL-333

TAPER POINT

Needles Specifications	Size		Length cm	Color	Units Per box	Comments	Reorder code
	USP	EP					
GS-22 1/2 Circle 27 mm 	3-0	2	75	Violet	36		CL-882
	3-0	2	75	Undyed	36		CL-829
	2-0	3	5 × 45	Violet	12	D-Tach™	CL-16-MG
	2-0	3	75	Undyed	36		CL-830
	2-0	3	75	Violet	36		CL-883
	0	3.5	5 × 45	Violet	12	D-Tach™	CL-17-MG
	0	3.5	75	Violet	36	Surgalloy™	CLS-884
	0	3.5	5 × 75	Violet	12	D-Tach™	CL-886-M
	0	3.5	75	Violet	36		CL-884
	0	3.5	75	Undyed	36		CL-831
	0	3.5	90	Violet	36		CL-330
	1	4	75	Violet	36		CL-885
	1	4	5 × 75	Violet	12	D-Tach™	CL-885-M
	1	4	75	Undyed	36		CL-832
	1	4	90	Violet	36		CL-331
	2	5	75	Violet	36		CL-232
	V-30 1/2 Circle 30 mm 	3-0	2	75	Violet	36	
2-0		3	75	Violet	36		GL-223
2-0		3	75	Undyed	36		GL-228
2-0		3	5 × 75	Violet	12	D-Tach™	GL-223-M
0		3.5	75	Violet	36		GL-224
1		4	75	Violet	36		GL-225

TAPER POINT

Needles Specifications	Size		Length cm	Color	Units Per box	Comments	Reorder code
	USP	EP					
GS-21 1/2 Circle 37 mm 	4-0	1.5	75	Violet	36		CL-809
	3-0	2	5 × 45	Violet	12	D-Tach™	CL-8-MG
	3-0	2	75	Undyed	36		CL-842
	3-0	2	75	Violet	36		CL-810
	3-0	2	90	Violet	36		CL-922
	3-0	2	90	Undyed	36		CL-952
	2-0	3	5 × 45	Violet	12	D-Tach™	CL-9-MG
	2-0	3	5 × 45	Undyed	12	D-Tach™	CL-13-MG
	2-0	3	75	Undyed	36		CL-843
	2-0	3	75	Violet	36		CL-811
	2-0	3	5 × 75	Violet	12	D-Tach™	CL-4M
	2-0	3	90	Violet	36		CL-923
	2-0	3	90	Undyed	36		CL-953
	0	3.5	5 × 45	Undyed	12	D-Tach™	CL-14-MG
	0	3.5	5 × 45	Violet	12	D-Tach™	CL-10-MG
	0	3.5	75	Undyed	36		CL-844
	0	3.5	75	Violet	36		CL-812
	0	3.5	5 × 75	Violet	12	D-Tach™	CL-5-M
	0	3.5	5 × 75	Undyed	12	D-Tach™	CL-2M
	0	3.5	75	Violet	24		CL-812
	0	3.5	90	Undyed	36		CL-954
	0	3.5	90	Violet	36		CL-924
	1	4	5 × 45	Undyed	12	D-Tach™	CL-15-MG
	1	4	5 × 45	Violet	12	D-Tach™	CL-11-MG
	1	4	75	Undyed	36		CL-845
	1	4	75	Violet	36		CL-813
	1	4	5 × 75	Violet	12	D-Tach™	CL-6-M
	1	4	90	Violet	36		CL-925
	1	4	90	Undyed	36		CL-955
	2	5	75	Violet	36		CL-814
	2	5	90	Violet	36		CL-926



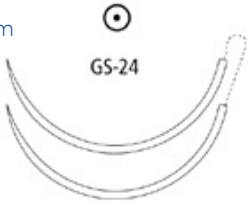



TAPER POINT

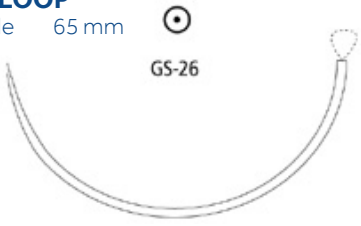

Needles Specifications	Size		Length cm	Color	Units Per box	Comments	Reorder code
	USP	EP					
V-26 1/2 Circle 37 mm 	3-0	2	75	Violet	36		GL-126
	2-0	3	75	Violet	36		GL-127
	0	3.5	75	Violet	36		GL-128
	1	4	75	Violet	36		GL-129
GS-24 1/2 Circle 40 mm 	3-0	2	75	Violet	36		CL-800
	3-0	2	90	Undyed	36		CL-962
	3-0	2	90	Violet	36		CL-912
	2-0	3	5 × 45	Violet	12	D-Tach™	CL-22-MG
	2-0	3	75	Undyed	36		CL-853
	2-0	3	75	Violet	36		CL-801
	2-0	3	90	Violet	36		CL-913
	2-0	3	90	Undyed	36		CL-963
	0	3.5	5 × 45	Violet	12	D-Tach™	CL-20-MG
	0	3.5	75	Violet	36		CL-802
	0	3.5	90	Violet	36		CL-914
	0	3.5	90	Undyed	36		CL-964
	1	4	5 × 45	Violet	12	D-Tach™	CL-21-MG
	1	4	75	Violet	36		CL-803
	1	4	75	Undyed	36		CL-855
	1	4	90	Violet	36		CL-915
	1	4	90	Undyed	36		CL-965
	2	5	5 × 45	Violet	6	D-Tach™	CL-623-M
	2	5	5 × 60	Violet	12	D-Tach™	CL-622-M
	2	5	75	Violet	36		CL-779
2	5	90	Violet	36		CL-911	
GS-24 1/2 Circle 40 mm Double-arm 	3-0	2	150	Violet	36		CL-990

TAPER POINT

Needles Specifications	Size		Length cm	Color	Units Per box	Comments	Reorder code
	USP	EP					
GS-25 1/2 Circle 48 mm 	3-0	2	75	Violet	36		CL-862
	3-0	2	90	Undyed	36		CL-972
	2-0	3	5 × 45	Undyed	12	D-Tach™	CL-36-MG
	2-0	3	75	Violet	36		CL-863
	2-0	3	90	Undyed	36		CL-973
	2-0	3	90	Violet	36		CL-903
	0	3.5	5 × 45	Undyed	12	D-Tach™	CL-35-MG
	0	3.5	5 × 45	Violet	12	D-Tach™	CL-30-MG
	0	3.5	75	Violet	36		CL-864
	0	3.5	90	Undyed	36		CL-974
	0	3.5	90	Violet	36		CL-904
	1	4	5 × 45	Violet	12	D-Tach™	CL-31-MG
	1	4	75	Violet	36		CL-865
	1	4	75	Violet	12	D-Tach™	CL-64-M
	1	4	90	Undyed	36		CL-975
	1	4	90	Violet	36		CL-905
	2	5	5 × 45	Violet	6	D-Tach™	CL-633-M
	2	5	5 × 60	Violet	12	D-Tach™	CL-644-M
	2	5	75	Violet	36		CL-866
	2	5	5 × 75	Violet	6	D-Tach™	CL-665-M
2	5	90	Violet	36		CL-906	
GS-26 1/2 Circle 65 mm 	2-0	3	75	Undyed	24		CL-63
	1	4	5 × 75	Violet	12		CL-60-M
	1	4	90	Violet	36		CL-968
	1	4	150	Violet	24		CL-824
	2	5	5 × 75	Violet	6		CL-659-M
	2	5	100	Undyed	36		CL-969
	2	5	150	Undyed	24		CL-880
	2	5	150	Violet	24		CL-825



TAPER POINT

Needles Specifications	Size		Length cm	Color	Units Per box	Comments	Reorder code
	USP	EP					
GS-26 LOOP 1/2 Circle 65 mm 	1	4	120	Violet	24	Loop	CL-824L
	2	5	240	Violet	24	Loop	CL-835-L
GS-27 1/2 Circle 76 mm 	2-0	3	75	Undyed	24		CL-53
	1	4	75	Violet	24	455	SL-603
GU-46 5/8 Circle 27 mm 	3-0	2	75	Violet	36		UL-879
	2-0	3	75	Violet	36		UL-878
	0	3.5	75	Violet	36		UL-877
	1	4	75	Violet	36		UL-876
GU-46 5/8 Circle 27 mm Double-arm 	0	3.5	90	Violet	36		UL-240
GU-45 5/8 Circle 37 mm 	2-0	3	75	Violet	36		UL-245
	0	3.5	75	Violet	36		UL-246
GU-44 5/8 Circle 40 mm 	0	3.5	75	Violet	36		UL-146



TAPER POINT									
Needles Specifications			Size		Length cm	Color	Units Per box	Comments	Reorder code
			USP	EP					
SK SKI	23 mm		3-0	2	18	Violet	36	Endoscopy	EL415
			3-0	2	120	Violet	24	Endoscopy	EL450
TJ-32 1/2 Circle	32 mm		1	4	75	Violet	12		CL-673G
			1	4	75	Violet	36		CL-673

HEAVY TAPER POINT									
Needles Specifications			Size		Length cm	Color	Units Per box	Comments	Reorder code
			USP	EP					
HGS-22 1/2 Circle	27 mm		2-0	3	5 × 45	Violet	12	D-Tach™	CL-86-MG
			0	3.5	5 × 45	Undyed	12	D-Tach™	CL-87-MG
			1	4	75	Violet	36		CL-871
HGS-20 1/2 Circle	34 mm		2-0	3	5 × 75	Violet	12	D-Tach™	CL-996-MG
			0	3.5	5 × 75	Violet	12	D-Tach™	CL-997-MG
			1	4	5 × 75	Violet	12	D-Tach™	CL-998-MG
HGS-21 1/2 Circle	37 mm		2-0	3	5 × 45	Violet	12	D-Tach™	CL-202-M
			2-0	3	75	Violet	36		CL-930
			2-0	3	90	Violet	36		CL-970
			0	3.5	5 × 45	Violet	12	D-Tach™	CL-200-M
			0	3.5	75	Violet	36		CL-931
			0	3.5	5 × 75	Violet	12	D-Tach™	CL-71-M
			0	3.5	90	Violet	36		CL-971
			1	4	5 × 45	Violet	12	D-Tach™	CL-201-M
			1	4	75	Violet	36		CL-932
			1	4	90	Violet	36		CL-239
			2	5	75	Violet	36		CL-934



HEAVY TAPER POINT

Needles Specifications	Size		Length cm	Color	Units Per box	Comments	Reorder code
	USP	EP					
HGS-21 LOOP 1/2 Circle 37 mm 	0	3.5	150	Violet	24	Loop	CL-871-L
HGU-46 5/8 Circle 27 mm 	0	3.5	45	Violet	36		CL-576
	0	3.5	75	Violet	36		CL-677
	1	4	75	Violet	36		UL-676



TAPERCUTTING

Needles Specifications	Size		Length cm	Color	Units Per box	Comments	Reorder code
	USP	EP					
KV-7 1/2 Circle 26 mm 	3-0	2	75	Violet	36	Surgalloy™	CL-510
	2-0	3	75	Violet	36	Surgalloy™	CL-511
KV-34 1/2 Circle 37 mm 	3-0	2	90	Violet	36		CL-942
	2-0	3	75	Violet	36		CL-837
	2-0	3	90	Violet	36		CL-943
	2-0	3	90	Undyed	36		CL-946
	0	3.5	75	Violet	36		CL-838
	0	3.5	90	Undyed	36		CL-515
	0	3.5	90	Violet	36		CL-944
	1	4	75	Violet	36		CL-839
	1	4	90	Undyed	36		CL-516
	1	4	90	Violet	36		CL-945
2	5	90	Violet	36		CL-517	



TAPERCUTTING

Needles Specifications	Size		Length cm	Color	Units Per box	Comments	Reorder code
	USP	EP					
KV-37 1/2 Circle 40 mm 	2-0	3	75	Violet	36		CL-603
	0	3.5	75	Violet	36		CL-602
KV-40 1/2 Circle 48 mm 	0	3.5	90	Violet	36		CL-739
	1	4	75	Violet	36		CL-840
	1	4	90	Violet	36		CL-940
	2	5	75	Violet	36		CL-841
	2	5	90	Violet	36		CL-941
KV-40 LOOP 1/2 Circle 48 mm 	1	4	150	Violet	24	Loop	CL-740-L
	2	5	150	Violet	24	Loop	CL-741-L

BLUNT POINT

Needles Specifications	Size		Length cm	Color	Units Per box	Comments	Reorder code
	USP	EP					
BTV-20 1/2 Circle 26 mm 	3-0	2	5 × 45	Undyed	12	D-Tach™, ProtectPoint™	GLT-69-MG
BGS-21 1/2 Circle 37 mm 	2-0	3	90	Violet	36	ProtectPoint™	CL-956
	2-0	3	90	Undyed	36	ProtectPoint™	CL-259
	0	3.5	5 × 45	Violet	12	D-Tach™, ProtectPoint™	CL-250-M
	0	3.5	5 × 45	Undyed	12	D-Tach™, ProtectPoint™	CL-240-M
	0	3.5	90	Violet	36	ProtectPoint™	CL-957
	1	4	90	Violet	36	ProtectPoint™	CL-958



BLUNT POINT

Needles Specifications	Size		Length cm	Color	Units Per box	Comments	Reorder code
	USP	EP					
BTP-1 1/2 Circle 37 mm 	3-0	2	90	Undyed	36	ProtectPoint™	CLT-952
	2-0	3	5 × 45	Violet	12	D-Tach™, ProtectPoint™	CLT-9-MG
	2-0	3	5 × 45	Undyed	12	D-Tach™, ProtectPoint™	CLT-13-MG
	2-0	3	75	Undyed	36	ProtectPoint™	CLT-259
	2-0	3	90	Undyed	36	ProtectPoint™	CLT-953
	0	3.5	5 × 45	Violet	12	D-Tach™, ProtectPoint™	CLT-250-MG
	0	3.5	75	Violet	36		CLT-957
	0	3.5	90	Undyed	36	ProtectPoint™	CLT-954
	1	4	5 × 45	Undyed	12	D-Tach™, ProtectPoint™	CLT-15-MG
	1	4	5 × 45	Violet	12	D-Tach™, ProtectPoint™	CLT-11-MG
	1	4	75	Violet	36	ProtectPoint™	CLT-958
	1	4	90	Undyed	36	ProtectPoint™	CLT-955
	BGS-24 1/2 Circle 40 mm 	0	3.5	90	Violet	36	ProtectPoint™
1		4	90	Violet	36	ProtectPoint™	CL-951
BTP-X 1/2 Circle 48 mm 	0	3.5	5 × 45	Violet	12	D-Tach™, ProtectPoint™	CLT-850-MG
	0	3.5	5 × 45	Undyed	12	D-Tach™, ProtectPoint™	CLT-20-MG
	1	4	5 × 45	Violet	12	D-Tach™, ProtectPoint™	CLT-851-MG
	1	4	5 × 45	Undyed	12	D-Tach™, ProtectPoint™	CLT-21-MG
	1	4	90	Undyed	36	ProtectPoint™	CLT-855
	2	5	5 × 45	Violet	6	D-Tach™, ProtectPoint™	CLT-623-M



BLUNT POINT

Needles Specifications	Size		Length cm	Color	Units Per box	Comments	Reorder code
	USP	EP					
BGS-25 1/2 Circle 48 mm 	0	3.5	90	Violet	36	ProtectPoint™	CL-948
	1	4	90	Violet	36	ProtectPoint™	CL-949
BGS-29 1/2 Circle 63 mm 	2	5	2 × 90	Violet	12	ProtectPoint™	2-CL-852
BP-27 1/2 Circle 64 mm 	1	4	90	Violet	36	ProtectPoint™	CL-271
	2	5	90	Violet	36	ProtectPoint™	CL-270
BGST-29 1/2 Circle 65 mm 	2	5	5 × 75	Violet	6	D-Tach™, ProtectPoint™	CLT-633-M

DIAMOND POINT



Needles Specifications	Size		Length cm	Color	Units Per box	Comments	Reorder code
	USP	EP					
KV-25 1/2 Circle 22 mm 	1	4	75	Undyed	36		CL-513
KV-30 1/2 Circle 27 mm 	0	3.5	90	Undyed	36		CL-730

MULTIPURPOSE



Needles Specifications	Size		Length cm	Color	Units Per box	Comments	Reorder code
	USP	EP					
3.16 3/8 Circle 16 mm 	4-0	1.5	45	Undyed	36		CL-005
4.21 (H)* 1/2 Circle 20 mm 	2-0	3	75	Violet	36		CL-015
4.31 (H)* 1/2 Circle 30 mm 	0	3.5	75	Violet	36		CL-030

***(H) = Heavy**

MULTIPURPOSE

Needles Specifications	Size		Length cm	Color	Units Per box	Comments	Reorder code
	USP	EP					
4.41 1/2 Circle 40 mm 	2-0	3	75	Violet	36		CL-045
	0	3.5	75	Violet	36		UL-046
	1		75	Violet	36		CL-047
4.5 1/2 Circle 50 mm (Not to scale) 	2	5	90	Violet	36		CL-055
4.51 (H) 1/2 Circle 50 mm 	2-0	3	75	Violet	36		CL-060

SPATULA

Needles Specifications	Size		Length cm	Color	Units Per box	Comments	Reorder code
	USP	EP					
SE-100-8 1/4 Circle 6.3 mm Double-arm Curvature 100° 	6-0	0.7	45	Violet	12	Surgalloy™	L-1750K
SS-29 1/4 Circle 7.4 mm Double-arm Curvature 110° 	6-0	0.7	30	Violet	12	Surgalloy™	L-1756K
	6-0	0.7	45	Violet	12	Surgalloy™	L-1755K

SPATULA

Needles Specifications	Size USP	EP	Length cm	Color	Units Per box	Comments	Reorder code	
SS-14 1/4 Circle 8.6 mm Double-arm Curvature 115°		6-0	0.7	45	Violet	12	Surgalloy™	L-1791K
		6-0	0.7	45	Undyed	12	Surgalloy™	L-1670-K
		5-0	1	45	Violet	12	Surgalloy™	L-1792K
		5-0	1	45	Undyed	12	Surgalloy™	L-1669-K
SS-24 1/4 Circle 8.6 mm Double-arm Curvature 95°		6-0	0.7	20	Violet	12		L-1740-K
		6-0	0.7	30	Violet	12	Surgalloy™	L-1742K
		6-0	0.7	30	Undyed	12	Surgalloy™	L-1745K
		6-0	0.7	45	Undyed	24	Surgalloy™	L-2752K
		5-0	1	20	Violet	12	Surgalloy™	L-1739-K
		5-0	1	30	Violet	12	Surgalloy™	L-1785K
		5-0	1	45	Undyed	24	Surgalloy™	L-2753K
SE-140-8 3/8 Circle 6.3 mm Curvature 140°		8-0	0.4	30	Violet	12	Surgalloy™	L-2750K
		7-0	0.5	30	Violet	12	Surgalloy™	L-2751K
SE-140-8 3/8 Circle 6.3 mm Double-arm Curvature 140°		8-0	0.4	20	Violet	12	Surgalloy™	L-2747K
		8-0	0.4	30	Violet	12	Surgalloy™	L-2748K
		8-0	0.4	45	Violet	12	Surgalloy™	L-5118K
		7-0	0.5	30	Violet	12	Surgalloy™	L-1796K
		7-0	0.5	45	Violet	12	Surgalloy™	L-1897K
SS-28 1/2 Circle 7.4 mm Double-arm Curvature 145°		6-0	0.7	45	Violet	12	Surgalloy™	L-1562-K

SPATULA

Needles Specifications	Size USP	EP	Length cm	Color	Units Per box	Comments	Reorder code
SE-160-8 1/2 Circle 5.5 mm Double-arm Curvature 160°							
							
	SE-160-8 						
	8-0	0.4	20	Violet	12	Surgalloy™	L-2574K
	8-0	0.4	30	Violet	12	Surgalloy™	L-2749K
	7-0	0.5	45	Violet	12	Surgalloy™	L-1787K
SS-2 1/2 Circle 8.6 mm Double-arm Curvature 200°							
							
	SS-2 						
	5-0	1	30	Undyed	12	Surgalloy™	L-0223K

CAPROSYN™

Monofilament Absorbable Suture

There when you need it. Gone when you don't.

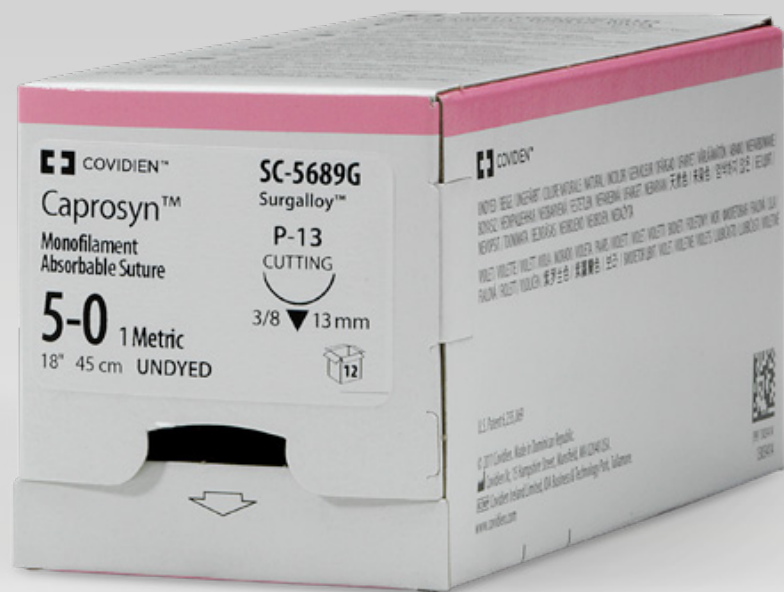





Please refer to the individual package IFUs for complete instructions, indications, contraindications, warnings and precautions.

Description	Caprosyn™ monofilament synthetic absorbable sutures are prepared from Polyglytone™ 6211 synthetic polyester which is composed of glycolide, caprolactone, trimethylene carbonate, and lactide.
Indications	Caprosyn™ synthetic absorbable sutures are indicated for use in general soft tissue approximation and/or ligation, but not for use in cardiovascular or neurological surgery, microsurgery, or ophthalmic surgery.
Actions	Caprosyn™ synthetic absorbable sutures elicit a minimal acute inflammatory reaction in tissues, which is followed by gradual encapsulation of the suture by fibrous connective tissue. Progressive loss of tensile strength and eventual absorption of Caprosyn™ synthetic absorbable sutures occurs by means of hydrolysis.
Tensile Strength	Implantation studies in animals indicate that Caprosyn™ suture retains a minimum of 50 to 60% USP and EP knot strength at 5 days post implantation, and a minimum of 20 – 30% of USP and EP knot strength at 10 days post implantation. All of the original tensile strength is essentially lost by 21 days post implantation.
Sterilization	Ethylene oxide.
Absorbtion	Absorption begins as a loss of tensile strength followed by a loss of mass. Absorption of Caprosyn™ synthetic absorbable suture is essentially complete by 56 days.
Packaging	Caprosyn™ synthetic absorbable sutures are available undyed (natural) or dyed with D&C Violet No. 2 in USP sizes 1 (4 metric) through 6–0 (0.7 Metric). The sutures are supplied sterile, in pre-cut lengths or ligating reels, non-needled or affixed to various needle types. The sutures are available in box quantities of one, two and three dozen.

Caprosyn™

Caprosyn™ suture is a brand you have trusted for over 10 years with a proven history of performance.



REEL							
Needles Specifications	Size		Length cm	Color	Units Per box	Comments	Reorder code
	USP	EP					
	3-0	2	150	Undyed	24		C-212
	0	3.5	150	Undyed	36		C-214

REVERSE CUTTING							
Needles Specifications	Size		Length cm	Color	Units Per box	Comments	Reorder code
	USP	EP					
C-13 3/8 Circle 19 mm 	5-0	1	45	Undyed	36		SC-3634
	4-0	1.5	45	Undyed	12		SC-690G
	4-0	1.5	75	Undyed	36		SC-691
	3-0	2	45	Undyed	12		SC-694G
	3-0	2	75	Undyed	36		SC-692
	2-0	3	75	Undyed	36		SC-693
C-14 3/8 Circle 24 mm 	3-0	2	75	Undyed	12	Surgalloy™	SC-693G
C-15 3/8 Circle 26 mm 	3-0	2	75	Undyed	36		SC-587
	2-0	3	75	Undyed	36		SC-586
C-16 3/8 Circle 30 mm 	0	3.5	75	Undyed	36	Surgalloy™	SC-585

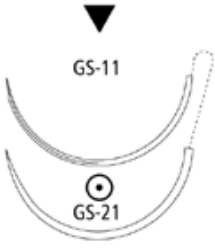



REVERSE CUTTING

Needles Specifications	Size		Length cm	Color	Units Per box	Comments	Reorder code
	USP	EP					
GS-11 1/2 Circle 37 mm 	2-0	3	75	Undyed	36		CC-543
GS-11 1/2 Circle 37 mm GS-21 Taper Point 1/2 Circle 37 mm Double-arm 	2-0	3	150	Undyed	36		CC-983

PREMIUM REVERSE CUTTING

Needles Specifications	Size		Length cm	Color	Units Per box	Comments	Reorder code
	USP	EP					
P-10 3/8 Circle 11 mm 	6-0	0.7	45	Undyed	12	Surgalloy™	SC-3625G
	5-0	1	45	Undyed	12	Surgalloy™	SC-3626G
P-13 3/8 Circle 13 mm 	6-0	0.7	45	Undyed	12	Surgalloy™	SC-5688G
	6-0	0.7	45	Violet	12	Surgalloy™	SC-5588G
	5-0	1	45	Undyed	12	Surgalloy™	SC-5689G
	5-0	1	45	Violet	12	Surgalloy™	SC-5587G
	4-0	1.5	45	Undyed	12	Surgalloy™	SC-5690G
	4-0	1.5	45	Violet	12	Surgalloy™	SC-5590G



PREMIUM REVERSE CUTTING

Needles Specifications	Size USP	EP	Length cm	Color	Units Per box	Comments	Reorder code
P-11 3/8 Circle 16 mm 	6-0	0.7	45	Undyed	12	Surgalloy™	SC-5635G
	5-0	1	45	Undyed	12	Surgalloy™	SC-5626G
	5-0	1	45	Undyed	36	Surgalloy™	SC-5626
	4-0	1.5	45	Undyed	12	Surgalloy™	SC-5686G
P-12 3/8 Circle 19 mm 	5-0	1	45	Undyed	12	Surgalloy™	SC-5616G
	4-0	1.5	45	Undyed	12	Surgalloy™	SC-5617G
	4-0	1.5	45	Violet	12	Surgalloy™	SC-5627G
	4-0	1.5	75	Undyed	12	Surgalloy™	SC-5637-G
	3-0	2	45	Undyed	12	Surgalloy™	SC-5618G
	3-0	2	75	Undyed	12	Surgalloy™	SC-5638-G
P-14 3/8 Circle 24 mm 	4-0	1.5	45	Undyed	36	Surgalloy™	SC-5679
	4-0	1.5	75	Undyed	36	Surgalloy™	SC-5779
	3-0	2	45	Undyed	36	Surgalloy™	SC-5640
	3-0	2	75	Undyed	12	Surgalloy™	SC-5780G
P-24 1/2 Circle 16 mm 	4-0	1.5	45	Undyed	12	Surgalloy™	SC-5643G

CONVENTIONAL CUTTING

Needles Specifications	Size		Length cm	Color	Units Per box	Comments	Reorder code
	USP	EP					
SC-1 Straight 51 mm ▲  SC-1	3-0	2	75	Undyed	36	Surgalloy™	SC-543
	2-0	3	75	Undyed	36	Surgalloy™	SC-542
SC-2 Straight 60 mm ▲  SC-2	4-0	1.5	75	Undyed	36	Surgalloy™	SC-644
	3-0	2	75	Undyed	36		SC-643

DERMAX PREMIUM X CUTTINGT

Needles Specifications	Size		Length cm	Color	Units Per box	Comments	Reorder code
	USP	EP					
DX-13 3/8 Circle 13 mm ◆  DX-13	5-0	1	45	Undyed	12	DermaX	XC-834
DX-16 3/8 Circle 16 mm ◆  DX-16	5-0	1	45	Undyed	12	DermaX	XC-844
	4-0	1.5	45	Undyed	12	DermaX	XC-845

DERMAX PREMIUM X CUTTING

Needles Specifications	Size		Length cm	Color	Units Per box	Comments	Reorder code
	USP	EP					
DX-19 3/8 Circle 19 mm 	4-0	1.5	45	Undyed	12	DermaX	XC-823





TAPER POINT

Needles Specifications	Size		Length cm	Color	Units Per box	Comments	Reorder code
	USP	EP					
CV-23 1/2 Circle 17 mm 	5-0	1	75	Undyed	36	Surgalloy™	UC-202
	4-0	1.5	75	Undyed	36	Surgalloy™	UC-203
	4-0	1.5	75	Violet	36	Surgalloy™	UC-214
	3-0	2	75	Violet	36		UC-213
	3-0	2	75	Undyed	36	Surgalloy™	UC-204
CV-25 1/2 Circle 22 mm 	4-0	1.5	75	Undyed	36	Surgalloy™	UC-403
	3-0	2	5 × 45	Undyed	12	D-Tach™	GC-33-M
	3-0	2	75	Undyed	36	Surgalloy™	UC-404
GS-23 1/2 Circle 22 mm 	2-0	3	75	Undyed	36		UC-863

TAPER POINT

Needles Specifications	Size		Length cm	Color	Units Per box	Comments	Reorder code
	USP	EP					
V-20 1/2 Circle 26 mm 	4-0	1.5	75	Violet	36	Surgalloy™	GC-321
	4-0	1.5	75	Undyed	36	Surgalloy™	GC-121
	3-0	2	75	Undyed	36	Surgalloy™	GC-122
	3-0	2	75	Violet	36	Surgalloy™	GC-322
	2-0	3	75	Undyed	36	Surgalloy™	GC-123
	2-0	3	75	Violet	36	Surgalloy™	GC-323
	0	3.5	75	Undyed	36	Surgalloy™	GC-124
GS-22 1/2 Circle 27 mm 	2-0	3	75	Undyed	36		CC-883
	2-0	3	75	Violet	36		CC-830
	0	3.5	75	Undyed	36		CC-884
	0	3.5	75	Violet	36		CC-831
	1	4	75	Undyed	36		CC-885
GS-21 1/2 Circle 37 mm 	3-0	2	75	Undyed	36		CC-810
	3-0	2	90	Undyed	36		CC-922
	2-0	3	75	Violet	36		CC-843
	2-0	3	75	Undyed	36		CC-811
	2-0	3	90	Undyed	36		CC-923
	0	3.5	75	Violet	36		CC-844
	0	3.5	75	Undyed	36		CC-812
	0	3.5	90	Undyed	36		CC-924
	1	4	75	Violet	36		CC-845
	1	4	75	Undyed	36		CC-813
	1	4	90	Undyed	36		CC-925

TAPER POINT

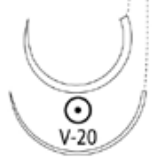
Needles Specifications	Size		Length cm	Color	Units Per box	Comments	Reorder code
	USP	EP					
GS-24 1/2 Circle 40 mm 	2-0	3	75	Undyed	36		CC-801
	2-0	3	90	Undyed	36		CC-915
	0	3.5	75	Undyed	36		CC-802
	0	3.5	90	Undyed	36		CC-913
	1	4	75	Undyed	36		CC-803
	1	4	90	Undyed	36		CC-914
GS-25 1/2 Circle 48 mm 	2-0	3	75	Undyed	36		CC-872
	0	3.5	90	Undyed	36		CC-904
	1	4	90	Violet	36		CC-975
	1	4	90	Undyed	36		CC-905
GU-46 5/8 Circle 27 mm 	3-0	2	75	Violet	36		UC-879
	2-0	3	75	Undyed	36		UC-978
GU-46 5/8 Circle 27 mm  V-20 1/2 Circle 26 mm Double-arm 	2-0	3	75	Violet	36	Surgalloy™	CC-658

TAPERCUTTING

Needles Specifications	Size		Length cm	Color	Units Per box	Comments	Reorder code
	USP	EP					
KV-34 1/2 Circle 37 mm 	2-0	3	90	Undyed	12		CC-1945G
	1	4	90	Undyed	36	Surgalloy™	CC-196

BIOSYN™

Monofilament Absorbable Sutures

Strength, suppleness and integrity.

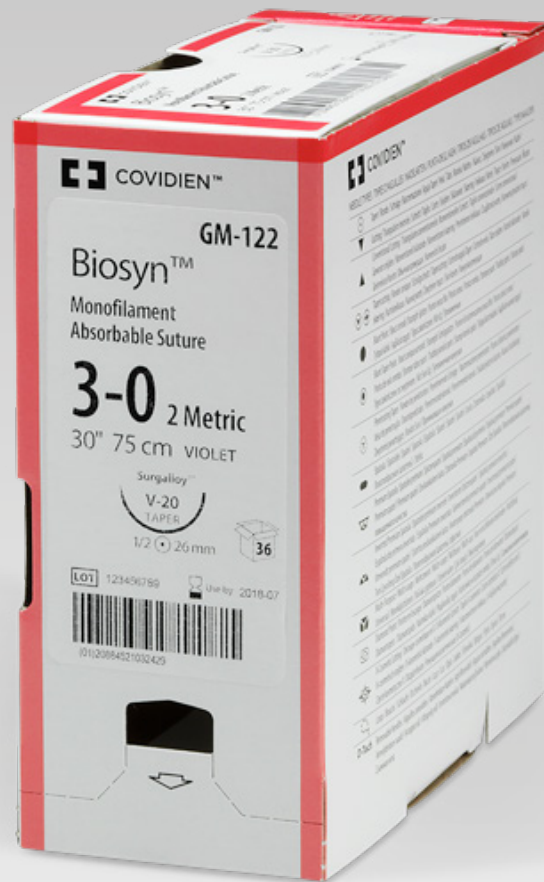

Please refer to the individual package IFUs for complete instructions, indications, contraindications, warnings and precautions.

Description	Biosyn™ monofilament synthetic absorbable sutures are prepared from a synthetic polyester composed of glycolide, dioxanone, and trimethylene carbonate. Biosyn™ synthetic absorbable sutures are colored violet to increase visibility and are also available undyed.
Indications	Biosyn™ synthetic absorbable sutures are indicated for use in general soft tissue approximation and/or ligation including use in ophthalmic surgery, but not for use in cardiovascular or neurological surgery.
Actions	Biosyn™ synthetic absorbable sutures elicit a minimal acute inflammatory reaction in tissues, which is followed by gradual encapsulation of the suture by fibrous connective tissue. Progressive loss of tensile strength and eventual absorption of Biosyn™ synthetic absorbable sutures occurs by means of hydrolysis where the suture is broken down to glycolic acid, dioxanoic acid, propane diol and carbon dioxide which are subsequently absorbed and metabolized by the body.
Tensile Strength	Studies in animals indicate tensile strength averages for Biosyn™ synthetic absorbable sutures are approximately 75% of U.S.P and E.P. minimum knot strength at two weeks and approximately 40% at three weeks post-implant.
Sterilization	Ethylene oxide.
Absorbtion	Absorption begins as a loss of tensile strength without appreciable loss of mass. Absorption of Biosyn™ synthetic absorbable sutures is essentially complete between 90 and 110 days.
Packaging	Biosyn™ synthetic absorbable sutures are available undyed (natural) or dyed violet in U.S.P. and E.P. sizes 1 (4 Metric) through 6–0 (0.7 Metric). The sutures are supplied sterile, in pre-cut lengths or affixed to various needle types using both permanent and removal needle attachment techniques. Please refer to the individual package IFUs for complete instructions, indications, contraindications, warnings and precautions.







Biosyn™ suture is a brand you have trusted for over 15 years with a proven history of performance.

PRE-CUT							
Needles Specifications	Size		Length cm	Color	Units Per box	Comments	Reorder code
	USP	EP					
	4-0	1.5	6 × 45	Violet	24	Pre-cut	M-31-
	3-0	2	3 × 45	Violet	36	Pre-cut	M-72
	3-0	2	6 × 45	Violet	24	Pre-cut	M-32-
	2-0	3	6 × 45	Violet	24	Pre-cut	M-33-
	2-0	3	6 × 45	Undyed	24	Pre-cut	M-23-
	0	3.5	3 × 45	Violet	36	Pre-cut	M-74
	1	4	3 × 45	Violet	36	Pre-cut	M-75

STANDARD LENGHT							
Needles Specifications	Size		Length cm	Color	Units Per box	Comments	Reorder code
	USP	EP					
	0	3.5	150	Violet	36	Standard length	M-114

REVERSE CUTTING							
Needles Specifications	Size		Length cm	Color	Units Per box	Comments	Reorder code
	USP	EP					
C-13 3/8 Circle 19 mm 	5-0	1	75	Undyed	36		SM-690
	4-0	1.5	75	Violet	36		SM-791
	4-0	1.5	75	Undyed	12		SM-691G
	4-0	1.5	75	Undyed	36		SM-691
	3-0	2	75	Undyed	36		SM-822
	3-0	2	75	Violet	36		SM-922

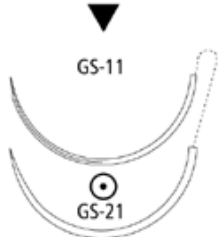

REVERSE CUTTING

Needles Specifications			Size		Length cm	Color	Units Per box	Comments	Reorder code
			USP	EP					
C-14 3/8 Circle 24 mm 	3-0	2	75	Undyed	36		SM-693		
	2-0	3	75	Violet	36		SM-923		
	2-0	3	75	Undyed	36		SM-823		
C-23 1/2 Circle 24 mm 	4-0	1.5	75	Violet	36		SM-633		
	3-0	2	5 × 45	Violet	12	D-Tach™	SM-83-M		
	3-0	2	75	Violet	36		SM-632		
GS-10 1/2 Circle 26 mm 	2-0	3	75	Violet	36		CM-879		
GS-11 1/2 Circle 37 mm 	2-0	3	75	Violet	36		CM-816		
	2-0	3	75	Undyed	36		CM-543		
	0	3.5	75	Violet	36		CM-817		
	0	3.5	75	Undyed	36		CM-544		
GS-11 - GS-21 1/2 Circle 37 mm *Double-arm 	3-0	2	135	Undyed	36		CM-991		
	2-0	3	150	Undyed	36		CM-932		
HOS-11 1/2 Circle 37 mm 	1	4	75	Violet	36		CM-528		

REVERSE CUTTING

Needles Specifications	Size		Length cm	Color	Units Per box	Comments	Reorder code
	USP	EP					
GS-13 1/2 Circle 48 mm 	1	4	90	Violet	36		CM-222

PREMIUM REVERSE CUTTING

Needles Specifications	Size		Length cm	Color	Units Per box	Comments	Reorder code
	USP	EP					
P-10 3/8 Circle 11 mm 	6-0	0.7	45	Undyed	12	Surgalloy™	SM-3625
	5-0	1	45	Undyed	12	Surgalloy™	SM-3626
P-13 3/8 Circle 13 mm 	6-0	0.7	45	Undyed	12	Surgalloy™	SM-5688
	5-0	1	45	Undyed	12	Surgalloy™	SM-5687
	4-0	1.5	45	Undyed	12	Surgalloy™	SM-5690
P-12 3/8 Circle 19 mm 	5-0	1	45	Undyed	12	Surgalloy™	SM-5624
	4-0	1.5	45	Undyed	12	Surgalloy™	SM-5627
	4-0	1.5	75	Undyed	12	Surgalloy™	SM-5637
	3-0	2	45	Undyed	12	Surgalloy™	SM-5628
	3-0	2	75	Undyed	12	Surgalloy™	SM-5638



PREMIUM REVERSE CUTTING

Needles Specifications	Size		Length cm	Color	Units Per box	Comments	Reorder code
	USP	EP					
P-14 3/8 Circle 24 mm 	4-0	1.5	45	Undyed	24	Surgalloy™	SM-5679
	4-0	1.5	75	Undyed	36	Surgalloy™	SM-5678
	3-0	2	75	Undyed	12	Surgalloy™	SM-5679G

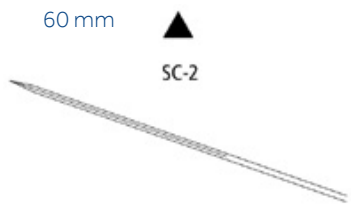

CONVENTIONAL CUTTING

Needles Specifications	Size		Length cm	Color	Units Per box	Comments	Reorder code
	USP	EP					
PC-13 3/8 Circle 11 mm 	5-0	1	45	Undyed	24		CM-401
	4-0	1.5	45	Undyed	24		CM-400
SC-2 Straight 60 mm 	4-0	1.5	75	Undyed	36		SM-644
	3-0	2	75	Undyed	36		SM-643

X CUTTING

Needles Specifications	Size USP	EP	Length cm	Color	Units Per box	Comments	Reorder code
DX-13 3/8 Circle 13 mm 	5-0	1	45	Undyed	12	DermaX	XM-834
	4-0	1.5	45	Undyed	12	DermaX	XM-845
DX-16 3/8 Circle 16 mm 	5-0	1	45	Undyed	12	DermaX	XM-822
	4-0	1.5	45	Undyed	12	DermaX	XM-823
DX-19 3/8 Circle 19 mm 	5-0	1	45	Undyed	12	DermaX	XM-822
	4-0	1.5	45	Undyed	12	DermaX	XM-823

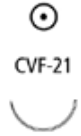



TAPER POINT

Needles Specifications	Size USP	EP	Length cm	Color	Units Per box	Comments	Reorder code
CVF-21 1/2 Circle 12 mm 	5-0	1	45	Undyed	36	Surgalloy™	SM-432
	4-0	1.5	45	Undyed	36	Surgalloy™	SM-431
	4-0	1.5	75	Undyed	36	Surgalloy™	SM-434
CV-11 3/8 Circle 13 mm Double-arm 	5-0	1	75	Violet	36	Surgalloy™	CM-126



TAPER POINT

Needles Specifications		Size USP	EP	Length cm	Color	Units Per box	Comments	Reorder code
CV-22 1/2 Circle 13 mm		6-0	0.7	75	Violet	36	Surgalloy™	UM-986
		6-0	0.7	75	Undyed	36	Surgalloy™	UM-886
		5-0	1	75	Violet	36	Surgalloy™	GM-875
CV-23 1/2 Circle 17 mm		6-0	0.7	75	Violet	36	Surgalloy™	UM-201
		5-0	1	75	Violet	36	Surgalloy™	UM-202
		5-0	1	75	Undyed	36	Surgalloy™	UM-213
		4-0	1.5	75	Undyed	36	Surgalloy™	UM-214
		4-0	1.5	75	Violet	36	Surgalloy™	UM-203
		3-0	2	75	Undyed	36	Surgalloy™	UM-215
		3-0	2	75	Violet	36	Surgalloy™	UM-204
		CV-23 1/2 Circle 17 mm Double-arm		4-0	1.5	75	Violet	36
3-0	2			75	Violet	36	Surgalloy™	CM-208
CV-25 1/2 Circle 22 mm		4-0	1.5	5 × 45	Violet	12	D-Tach™	GM-34-M
		4-0	1.5	75	Violet	36	Surgalloy™	GM-181
		3-0	2	45	Violet	12	D-Tach™	GMJ33M
		3-0	2	75	Violet	36	Surgalloy™	GM-324
		2-0	3	75	Violet	36	Surgalloy™	GM-183
CV-25 1/2 Circle 22 mm Double-arm		4-0	1.5	75	Violet	36	Surgalloy™	GM-281
		4-0	1.5	90	Violet	36	Surgalloy™	GM-291
		3-0	2	90	Violet	36	Surgalloy™	GM-282





TAPER POINT

Needles Specifications	Size USP	EP	Length cm	Color	Units Per box	Comments	Reorder code
V-20 1/2 Circle 26 mm 	4-0	1.5	75	Violet	36	Surgalloy™	GM-121
	4-0	1.5	75	Undyed	36	Surgalloy™	GM-321
	3-0	2	5 × 45	Undyed	12	D-Tach™	GM-69-M
	3-0	2	75	Violet	36	Surgalloy™	GM-122
	3-0	2	5 × 75	Violet	12	D-Tach™	GM-67-M
	3-0	2	75	Undyed	36	Surgalloy™	GM-322
	2-0	3	75	Violet	36		GM-123
	2-0	3	75	Undyed	36		GM-323
	2-0	3	90	Violet	36		GM-125
V-20 1/2 Circle 26 mm Double-arm 	4-0	1.5	75	Violet	36	Surgalloy™	GM-421
	4-0	1.5	90	Violet	36	Surgalloy™	GM-432
	3-0	2	90	Violet	36	Surgalloy™	GM-332
GS-22 1/2 Circle 27 mm 	3-0	2	75	Violet	36		CM-882
	2-0	3	75	Violet	36		CM-883
	2-0	3	75	Undyed	36		CM-830
	0	3.5	75	Violet	36		CM-884
	0	3.5	75	Undyed	36		CM-831
	1	4	75	Violet	36		CM-832
V-30 1/2 Circle 30 mm 	3-0	2	75	Violet	36		GM-222
	2-0	3	75	Violet	36		GM-223
	2-0	3	90	Violet	36		GM-326
	0	3.5	90	Violet	36		GM-327





TAPER POINT

Needles Specifications	Size		Length cm	Color	Units Per box	Comments	Reorder code
	USP	EP					
V-26 1/2 Circle 37 mm 	3-0	2	75	Undyed	36		GM-226
	2-0	3	75	Undyed	36		GM-227
GS-21 1/2 Circle 37 mm 	3-0	2	5 × 45	Violet	12	D-Tach™	CM-738-M
	3-0	2	75	Undyed	36		CM-842
	3-0	2	75	Violet	36		CM-810
	3-0	2	90	Violet	36		CM-922
	2-0	3	5 × 45	Violet	12	D-Tach™	CM-9M
	2-0	3	75	Undyed	36		CM-843
	2-0	3	75	Violet	36		CM-811
	2-0	3	90	Undyed	36		CM-953
	2-0	3	90	Violet	36		CM-923
	0	3.5	5 × 45	Undyed	12		CM-14-M
	0	3.5	5 × 45	Violet	12	D-Tach™	CM-10-M
	0	3.5	75	Undyed	36		CM-844
	0	3.5	75	Violet	36		CM-812
	0	3.5	90	Violet	36		CM-924
	0	3.5	90	Undyed	36		CM-954
	1	4	5 × 45	Violet	12	D-Tach™	CM-11-M
	1	4	75	Undyed	36		CM-845
	1	4	75	Violet	36		CM-813
	1	4	90	Violet	36		CM-925

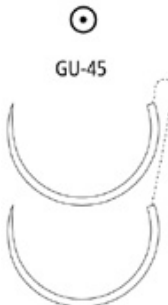

TAPER POINT

Needles Specifications	Size		Length cm	Color	Units Per box	Comments	Reorder code
	USP	EP					
GS-24 1/2 Circle 40 mm 	3-0	2	90	Undyed	36		CM-962
	2-0	3	75	Violet	36		CM-801
	0	3.5	90	Violet	36		CM-914
	0	3.5	90	Undyed	36		CM-964
	1	4	90	Violet	36		CM-966
GS-24 LOOP 1/2 Circle 40 mm 	0	3.5	150	Violet	12	Loop	CM-765-L
	1	4	150	Violet	12	Loop	CM-767-L
GS-25 1/2 Circle 48 mm 	2-0	3	90	Violet	36		CM-903
	0	3.5	90	Undyed	36		CM-974
	0	3.5	90	Violet	36		CM-904
	1	4	5 × 45	Violet	12	D-Tach™	CM-31-M
	1	4	90	Undyed	36		CM-975
	1	4	90	Violet	36		CM-905
GS-25 LOOP 1/2 Circle 48 mm 	0	3.5	150	Violet	12	Loop	CM-790L
	1	4	150	Violet	12	Loop	CM-776L
GS-26 LOOP 1/2 Circle 65 mm 	0	3.5	150	Violet	12	Loop	CM-779L
	1	4	240	Violet	12	Loop	CM-780L



TAPER POINT

Needles Specifications	Size USP	EP	Length cm	Color	Units Per box	Comments	Reorder code
GU-46 5/8 Circle 27 mm 	3-0	2	75	Violet	36		UM-879
	2-0	3	75	Undyed	36		UM-978
	2-0	3	75	Violet	36		UM-878
	0	3.5	75	Violet	36		UM-877
	0	3.5	75	Undyed	36		UM-977
GU-46 - V - 20 5/8 Circle 27 mm 	2-0	3	75	Violet	36	Loop	CM-558
GU-45 5/8 Circle 37 mm 	2-0	3	75	Undyed	36		UM-345
	2-0	3	75	Violet	36		UM-245
GU-45 - GU-45 5/8 Circle 37 mm Double-arm (Not to scale) 	3-0	2	75	Violet	36		UM-243
GU-44 5/8 Circle 40 mm 	0	3.5	75	Violet	36		UM-383

HEAVY TAPER POINT

Needles Specifications	Size		Length cm	Color	Units Per box	Comments	Reorder code
	USP	EP					
HGS-20 1/2 Circle 34 mm 	0	3.5	5 × 45	Violet	12	D-Tach™	CM-90-M
HGS-21 1/2 Circle 37 mm 	0	3.5	75	Violet	36		CM-436

TAPERCUTTING

Needles Specifications	Size		Length cm	Color	Units Per box	Comments	Reorder code
	USP	EP					
KV-34 1/2 Circle 37 mm 	2-0	3	75	Undyed	36		CM-827
KV-40 LOOP 1/2 Circle 48 mm 	1	4	150	Violet	12	Loop	CM-740L

BLUNT POINT

Needles Specifications	Size		Length cm	Color	Units Per box	Comments	Reorder code
	USP	EP					
BTV-20 1/2 Circle 26 mm 	3-0	2	75	Undyed	36		GMT-226
BTP-1 1/2 Circle 37 mm 	2-0	3	75	Violet	36	ProtectPoint™	CMT-811
	0	3.5	5 × 45	Violet	12	D-Tach™, ProtectPoint™	CMT-740-M
	0	3.5	75	Violet	36		CMT-812
	0	3.5	90	Undyed	36	ProtectPoint™	CMT-967
	1	4	5 × 45	Violet	12	D-Tach™, ProtectPoint™	CMT-741-M
BGS-24 1/2 Circle 40 mm 	1	4	90	Violet	36	ProtectPoint™	CM-951
BGS-25 1/2 Circle 48 mm 	1	4	5 × 45	Violet	12	D-Tach™, ProtectPoint™	CM-949-M

BLUNT POINT

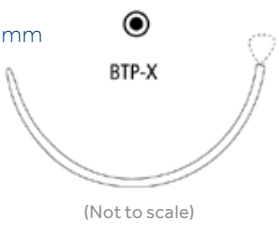
Needles Specifications	Size		Length cm	Color	Units Per box	Comments	Reorder code
	USP	EP					
BTP-X 1/2 Circle 48 mm  (Not to scale)	0	3.5	5 × 45	Violet	12	D-Tach™, ProtectPoint™	CMT-950-M
	0	3.5	90	Undyed	36	ProtectPoint™	CMT-974
	1	4	5 × 45	Violet	12	D-Tach™, ProtectPoint™	CMT-949-M
BTP-X LOOP 1/2 Circle 48 mm  (Not to scale)	0	3.5	150	Violet	12	LOOP, ProtectPoint™	CMT-789-L

MAXON™

Monofilament Absorbable Suture

Highest knot holding capacity versus competition.





Please refer to the individual package IFUs for complete instructions, indications, contraindications, warnings and precautions.





Description	Maxon™ monofilament polyglyconate synthetic absorbable sutures are prepared from a copolymer of glycolic acid and trimethylene carbonate.
Indications	Maxon™ sutures are indicated for use as absorbable sutures in general soft tissue approximation and/or ligation, including use in pediatric cardiovascular tissue, where growth is expected to occur, and in peripheral vascular tissue. Maxon™ sutures are not indicated for use in adult cardiovascular tissue, ophthalmic surgery, microsurgery, and neural tissue.
Actions	Maxon™ synthetic absorbable sutures elicit a minimal acute inflammatory reaction in tissues, which is followed by gradual encapsulation of the suture by fibrous connective tissue. Progressive loss of tensile strength and eventual absorption of Maxon™ synthetic absorbable sutures occurs by means of hydrolysis where the suture is broken down and subsequently absorbed and metabolized by the body.
Tensile Strength	Studies indicate that tensile strength for Maxon™ sutures is approximately 80% of the original suture strength at one week post-implant. Approximately 75% of the original suture strength remains at two weeks, 65% at three weeks, 50% at four weeks and 25% at six weeks post-implant.
Sterilization	Ethylene oxide.
Absorbtion	Absorption of Maxon™ synthetic absorbable sutures is minimal until about the 60th day after implantation and is essentially complete within six months.
Packaging	Maxon™ sutures are available in USP and E.P sizes 1 (4 Metric) through 7-0 (0.5 Metric). Maxon™ sutures are dyed with D&C Green No. 6. Maxon™ sutures are also available in clear (Undyed). The sutures are supplied sterile, affixed to various needle types, using permanent needle attachment techniques. Please refer to the individual package IFUs for complete instructions, indications, contraindications, warnings and precautions.

Maxon™ suture is a brand you have trusted for over 25 years with a history of improvements and performance





PRE-CUT							
Needles Specifications	Size		Length cm	Color	Units Per box	Comments	Reorder code
	USP	EP					
	3-0	2	3 × 45	Green	36	Pre-cut	8886600741
	2-0	3	3 × 45	Green	36	Pre-cut	8886600751
	0	3.5	5 × 45	Green	12	Pre-cut	8886601563

REVERSE CUTTING							
Needles Specifications	Size		Length cm	Color	Units Per box	Comments	Reorder code
	USP	EP					
C-1 3/8 Circle 12 mm 	5-0	1	45	Green	36		8886660521
	4-0	1.5	45	Green	36		8886660531
C-12 3/8 Circle 16 mm 	4-0	1.5	75	Clear	36		8886611831
C-13 3/8 Circle 19 mm 	5-0	1	45	Clear	36		8886660821
	4-0	1.5	45	Clear	36		8886660831
	4-0	1.5	75	Green	36		8886663931
	4-0	1.5	75	Clear	36		8886661231
	3-0	2	45	Clear	36		8886660841
	3-0	2	75	Green	36		8886663941
	3-0	2	75	Clear	36		8886661241





REVERSE CUTTING

Needles Specifications	Size		Length cm	Color	Units Per box	Comments	Reorder code
	USP	EP					
C-14 3/8 Circle 24 mm 	4-0	1.5	75	Clear	36		8886661831
	3-0	2	75	Clear	36		8886661841
	3-0	2	75	Green	36		8886664141
	2-0	3	75	Green	36		8886664151
	2-0	3	75	Clear	36		8886661851
C-16 3/8 Circle 30 mm 	2-0	3	75	Clear	36		8886662651
C-27 1/2 Circle 20 mm 	3-0	2	45	Green	36		8886605941
GS-10 1/2 Circle 26 mm 	3-0	2	75	Clear	36		8886674441
	2-0	3	5 × 45	Green	12	D-Tach™	CMM-435-MG
	2-0	3	75	Green	36		8886674551
	2-0	3	75	Clear	36		8886674451
HOS-10 1/2 Circle 26 mm 	1	4	75	Green	36		88866751-71



REVERSE CUTTING

Needles Specifications	Size		Length cm	Color	Units Per box	Comments	Reorder code
	USP	EP					
GS-11 1/2 Circle 37 mm 	2-0	3	75	Green	36		8886675551
	0	3.5	75	Green	36		8886675561
	1	4	75	Green	36		8886675571
HOS-11 1/2 Circle 37 mm 	1	4	75	Green	36		88866757-71
HOS-12 1/2 Circle 40 mm 	1	4	75	Green	36		8886678771
GS-13 1/2 Circle 48 mm 	1	4	90	Green	36		8886676971

PREMIUM REVERSE CUTTING

Needles Specifications	Size		Length cm	Color	Units Per box	Comments	Reorder code
	USP	EP					
P-10 3/8 Circle 11 mm 	6-0	0.7	45	Green	36	Surgalloy™	8886653311
	6-0	0.7	45	Clear	36	Surgalloy™	8886653211
	5-0	1	45	Clear	36	Surgalloy™	8886653221
P-13 3/8 Circle 13 mm 	6-0	0.7	45	Clear	36	Surgalloy™	SMM-5516
	5-0	1	45	Clear	36	Surgalloy™	SMM-5526
	4-0	1.5	45	Clear	36	Surgalloy™	SMM-5536
P-11 3/8 Circle 16 mm 	5-0	1	45	Clear	36	Surgalloy™	SMM-5221
	4-0	1.5	45	Clear	36	Surgalloy™	SMM-5431
P-12 3/8 Circle 19 mm 	5-0	1	45	Clear	36	Surgalloy™	SMM-5042
	4-0	1.5	45	Clear	36	Surgalloy™	SMM-5043
	4-0	1.5	45	Green	36	Surgalloy™	SMM-5033
	4-0	1.5	75	Clear	36	Surgalloy™	SMM-5323
	3-0	2	45	Clear	36	Surgalloy™	SMM-5044
	3-0	2	75	Clear	36	Surgalloy™	8886663241
P-14 3/8 Circle 24 mm 	3-0	2	45	Clear	36	Surgalloy™	SMM-5241
	2-0	3	45	Clear	36		8886662451

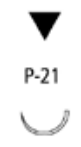

PREMIUM REVERSE CUTTING

Needles Specifications	Size		Length cm	Color	Units Per box	Comments	Reorder code
	USP	EP					
P-21 1/2 Circle 9 mm 	5-0	1	45	Clear	12		88866704-23
P-24 1/2 Circle 16 mm 	4-0	1.5	45	Clear	36	Surgalloy™	SMM-5831

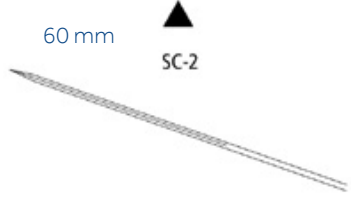
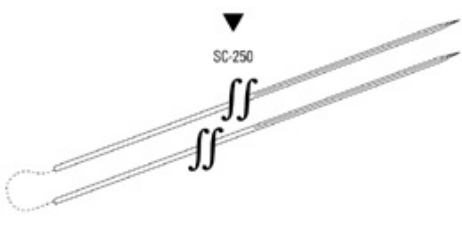



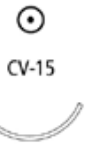

CONVENTIONAL CUTTING

Needles Specifications	Size		Length cm	Color	Units Per box	Comments	Reorder code
	USP	EP					
SC-2 Straight 60 mm 	4-0	1.5	75	Clear	36		8886690831
	3-0	2	75	Clear	36		8886690841
SC-250 Straight 254 mm Double-arm (Not to scale) 	2-0	3	75	Green	12		8886639053

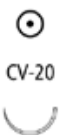

TAPER POINT

Needles Specifications	Size USP	EP	Length cm	Color	Units Per box	Comments	Reorder code	
CV-1 3/8 Circle 9 mm Double-arm		7-0	0.5	45	Green	36	Surgalloy™	8886614501
		7-0	0.5	60	Green	36	Surgalloy™	8886613901
		7-0	0.5	75	Green	36	Surgalloy™	8886612701
		6-0	0.7	60	Green	36	Surgalloy™	8886613911
		6-0	0.7	75	Green	36	Surgalloy™	8886612711
CV 3/8 Circle 11 mm Double-arm		6-0	0.7	45	Green	36	Surgalloy™	8886611511
CV-11 3/8 Circle 13 mm		6-0	0.7	75	Green	36	Surgalloy™	8886614811
		5-0	1	75	Green	36	Surgalloy™	8886614821
CV-11 3/8 Circle 13 mm Double-arm		6-0	0.7	45	Green	36	Surgalloy™	8886612111
		6-0	0.7	60	Green	36	Surgalloy™	8886614711
		6-0	0.7	75	Green	36	Surgalloy™	8886612411
		5-0	1	4×60	Green	12	Surgalloy™	8886616523
		5-0	1	60	Green	36	Surgalloy™	8886614721
		5-0	1	75	Green	36	Surgalloy™	8886612421
		5-0	1	90	Green	36	Surgalloy™	8886612821
CV-15 3/8 Circle 17 mm		4-0	1.5	75	Green	36		8886605731
CV-15 3/8 Circle 17 mm Double-arm		5-0	1	75	Green	36	Surgalloy™	8886646221
		4-0	1.5	75	Green	36	Surgalloy™	8886646231

TAPER POINT

Needles Specifications	Size USP	EP	Length cm	Color	Units Per box	Comments	Reorder code
CV-20 1/2 Circle 10 mm 	6-0	0.7	75	Green	36	Surgalloy™	8886600111
CV-22 1/2 Circle 13 mm 	6-0	0.7	75	Green	36	Surgalloy™	8886621311
	5-0	1	75	Green	36		8886621321
	4-0	1.5	5 × 45	Green	12	D-Tach™	8886620133
	4-0	1.5	75	Green	36	Surgalloy™	8886621331
CV-22 1/2 Circle 13 mm Double-arm 	6-0	0.7	75	Green	36	Surgalloy™	8886613211
	5-0	1	75	Green	36	Surgalloy™	8886612221
CV-23 1/2 Circle 17 mm 	5-0	1	75	Green	36	Surgalloy™	8886620721
	4-0	1.5	75	Green	36	Surgalloy™	8886620731
	3-0	2	75	Green	36	Surgalloy™	8886620741
CV-23 1/2 Circle 17 mm Double-arm 	5-0	1	75	Green	36	Surgalloy™	8886614921
	4-0	1.5	90	Green	36	Surgalloy™	8886613431
CV-24 1/2 Circle 20 mm 	5-0	1	75	Green	36		8886621721
	4-0	1.5	5 × 45	Green	12	D-Tach™	8886621933
	4-0	1.5	75	Green	36		8886621731
	3-0	2	5 × 45	Green	12	D-Tach™	8886621943
	3-0	2	75	Green	36		8886621741
CV-24 1/2 Circle 20 mm Double-arm 	4-0	1.5	90	Green	36		8886622131
	3-0	2	90	Green	36		8886603641







TAPER POINT

Needles Specifications	Size		Length cm	Color	Units Per box	Comments	Reorder code
	USP	EP					
V-20 1/2 Circle 26 mm 	4-0	1.5	5 × 45	Green	12	D-Tach™	8886622933
	4-0	1.5	5 × 75	Green	12	D-Tach™	8886603433
	4-0	1.5	75	Green	36	Surgalloy™	8886623331
	3-0	2	5 × 45	Green	12	D-Tach™	8886622943
	3-0	2	75	Green	36	Surgalloy™	8886623341
	3-0	2	75	Clear	36	Surgalloy™	8886623241
	3-0	2	5 × 75	Green	12	D-Tach™	8886603443
	2-0	3	5 × 45	Green	12	D-Tach™	8886622953
	2-0	3	75	Green	36		8886623351
V-20 1/2 Circle 26 mm Double-arm 	4-0	1.5	75	Green	36	Surgalloy™	8886623131
	4-0	1.5	90	Green	36		8886623531
	4-0	1.5	105	Green	36		8886614331
	3-0	2	90	Green	36		8886623541
GS-22 1/2 Circle 27 mm 	3-0	2	75	Green	36		8886624541
	2-0	3	5 × 45	Green	12	D-Tach™	8886624753
	2-0	3	75	Green	36		8886624551
	0	3.5	75	Green	36		8886624561
	1	4	75	Green	36		8886624571
V-30 1/2 Circle 30 mm 	4-0	1.5	75	Green	36		8886626131
	3-0	2	75	Green	36		8886626141
	2-0	3	75	Green	36		8886626151
	0	3.5	75	Green	36		8886626161

TAPER POINT

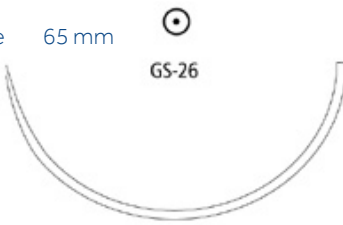
Needles Specifications	Size		Length cm	Color	Units Per box	Comments	Reorder code
	USP	EP					
GS-21 1/2 Circle 37 mm 	3-0	2	75	Green	36		8886626741
	2-0	3	5 × 45	Green	12	D-Tach™	8886627553
	2-0	3	75	Green	36		8886626751
	2-0	3	90	Green	36		8886626951
	2-0	3	150	Green	12		GMM-951
	0	3.5	5 × 45	Green	12	D-Tach™	8886627563
	0	3.5	75	Green	36		8886626761
	0	3.5	90	Green	36		8886626961
	1	4	5 × 45	Green	12	D-Tach™	8886627573
	1	4	75	Green	36		8886626771
	1	4	90	Green	36		8886626971
	V-26 1/2 Circle 37 mm 	3-0	2	75	Green	36	
2-0		3	75	Green	36		8886625751
0		3.5	75	Green	36		8886625761
GS-24 1/2 Circle 40 mm 	2-0	3	90	Green	36		8886628751
	0	3.5	75	Green	36		8886628561
	0	3.5	90	Green	36		8886628761
	1	4	75	Green	36		8886628571
	1	4	90	Green	36		8886628771
GS-24 LOOP 1/2 Circle 40 mm 	0	3.5	150	Green	12	Loop	GMM-563L
	1	4	150	Green	12	Loop	GMM573L

TAPER POINT

Needles Specifications	Size		Length cm	Color	Units Per box	Comments	Reorder code
	USP	EP					
GS-25 1/2 Circle 48 mm 	0	3.5	5 × 45	Green	12	D-Tach™	8886631163
	0	3.5	90	Green	36		8886630761
	1	4	5 × 45	Green	12	D-Tach™	8886631173
	1	4	90	Green	36		8886630771
	1	4	150	Green	24		8886630972
GS-25 LOOP 1/2 Circle 48 mm 	0	3.5	150	Green	12	Loop	GMM-634L
	1	4	150	Green	12	Loop	GMM-632L
GS-26 1/2 Circle 65 mm 	0	3.5	150	Green	24		8886631962
	1	4	100	Green	36		8886632271
	1	4	150	Green	24		8886631972
GS-26 LOOP 1/2 Circle 65 mm 	0	3.5	150	Green	12	Loop	GMM-341L
	0	3.5	240	Green	12	Loop	GMM-343L
	1	4	240	Green	12	Loop	GMM-344L
GU-46 5/8 Circle 27 mm 	2-0	3	75	Green	36		8886640351
GU-46 5/8 Circle 27 mm Double-arm 	2-0	3	75	Green	36		8886640451

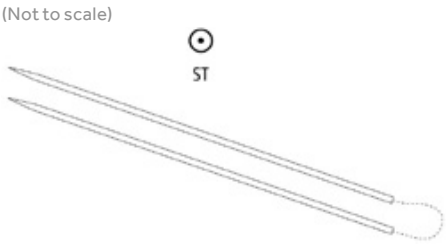

TAPER POINT

Needles Specifications	Size		Length cm	Color	Units Per box	Comments	Reorder code
	USP	EP					
ST Straight 60 mm Double-arm (Not to scale)	3-0	2	75	Green	36		8886623741
	0	3.5	75	Green	36		8886623761





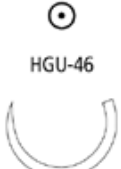

HEAVY TAPER POINT

Needles Specifications	Size		Length cm	Color	Units Per box	Comments	Reorder code
	USP	EP					
HGS-22 1/2 Circle 27 mm	0	3.5	75	Green	36		8886624961
	1	4	90	Green	36		8886633961
HGS-21 1/2 Circle 37 mm	0	3.5	90	Green	36		8886633961
	1	4	90	Green	36		88866339-71
HGU-46 5/8 Circle 27 mm	0	3.5	45	Green	36		8886645561
	0	3.5	75	Green	36		8886645661
	1	4	75	Green	36		8886641971

TAPERCUTTING

Needles Specifications	Size USP	EP	Length cm	Color	Units Per box	Comments	Reorder code
KV-1 3/8 Circle 9 mm 	6-0	0.7	75	Green	36	Surgalloy™	88866768-11
KV-11 3/8 Circle 13 mm 	6-0	0.7	75	Green	36	Surgalloy™	88866297-11
	5-0	1	75	Green	36	Surgalloy™	88866297-21
KV-11 3/8 Circle 13 mm Double-arm 	6-0	0.7	75	Green	36	Surgalloy™	88866288-11
	5-0	1	75	Green	36	Surgalloy™	88866288-21
KV-5 1/2 Circle 17 mm Double-arm 	4-0	1.5	90	Green	36	Surgalloy™	VMM-137
KV-7 1/2 Circle 26 mm 	2-0	3	75	Green	36		88866292-51
KV-34 1/2 Circle 37 mm 	0	3.5	90	Green	36		8886627761



TAPERCUTTING

Needles Specifications	Size		Length cm	Color	Units Per box	Comments	Reorder code
	USP	EP					
KV-37 LOOP 1/2 Circle 40 mm 	1	4	150	Green	12	Loop	GMM-873L
KV-40 1/2 Circle 48 mm 	1	4	90	Green	36		8886629571
KV-40 LOOP 1/2 Circle 48 mm 	0	3.5	150	Green	12	Loop	GMM-806L
	1	4	150	Green	12	Loop	GMM-807L

BLUNT POINT

Needles Specifications	Size		Length cm	Color	Units Per box	Comments	Reorder code
	USP	EP					
BTP-1 1/2 Circle 37 mm 	2-0	3	90	Green	36	ProtectPoint™	GMMT-951
	0	3.5	5 × 45	Green	12	D-Tach™, ProtectPoint™	GMMT-563- MG
	0	3.5	90	Green	36	ProtectPoint™	GMMT-961

BLUNT POINT

Needles Specifications	Size		Length cm	Color	Units Per box	Comments	Reorder code
	USP	EP					
BTP-X 1/2 Circle 48 mm 	0	3.5	5 × 45	Green	12	D-Tach™, ProtectPoint™	GMMT-541-MG
	1	4	5 × 45	Green	12	D-Tach™, ProtectPoint™	GMMT-540-MG
BTP-X LOOP 1/2 Circle 48 mm 	0	3.5	150	Green	12	Loop, ProtectPoint™	GMMT-89L
	1	4	150	Green	12	Loop, ProtectPoint™	GMMT-90L
BGS-25 1/2 Circle 48 mm 	0	3.5	90	Green	12	ProtectPoint™	8886606163
	1	4	90	Green	12	ProtectPoint™	8886606173
BGS-29 1/2 Circle 63 mm 	1	4	150	Green	12	ProtectPoint™	8886606773

MULTIPURPOSE

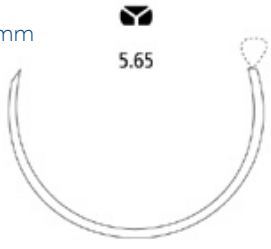
Needles Specifications	Size		Length cm	Color	Units Per box	Comments	Reorder code
	USP	EP					
5.65 LOOP 5/8 Circle 65 mm 	0	3.5	150	Green	12	Loop	GMM-496L
	1	4	180	Green	12	Loop	GMM-497L

SPATULA

Needles Specifications	Size		Length cm	Color	Units Per box	Comments	Reorder code
	USP	EP					
DGE-6 3/8 Circle 8 mm 	7-0	0.5	45	Green	36		8886662801

SURGIPRO™ & SURGIPRO™ II

Monofilament Polypropylene

Meeting the demands in cardiovascular surgery.

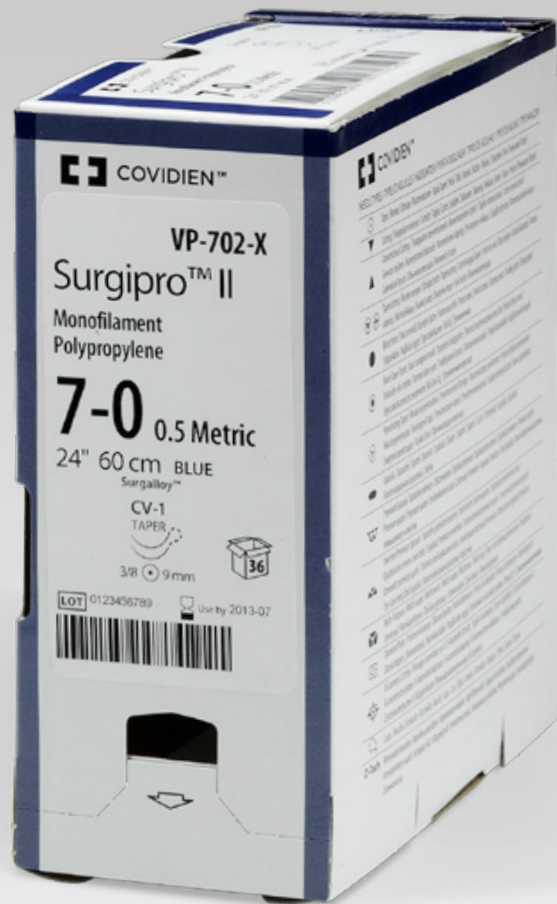

Please refer to the individual package IFUs for complete instructions, indications, contraindications, warnings and precautions.

Description

Surgipro™ and Surgipro™ II monofilament sutures (pigmented) are inert, nonabsorbable, sterile sutures composed of an isotactic crystalline stereoisomer of polypropylene (a synthetic linear polyolefin) and polyethylene.

Indications

Surgipro™ and Surgipro™ II polypropylene sutures are indicated for use in general soft tissue approximation and/or ligation, including use in cardiovascular, ophthalmic, and neural tissue.

Actions

Surgipro™ and Surgipro™ II polypropylene sutures elicit a minimal acute inflammatory reaction in tissues, which is followed by gradual encapsulation of the suture by fibrous connective tissue.

Tensile Strength

Surgipro™ and Surgipro™ II polypropylene sutures are not absorbed, nor is any significant change in strength retention known to occur in vivo.

Sterilization



Ethylene oxide.

Packaging



Surgipro™ II polypropylene sutures are available either undyed (clear) or dyed with Copper Phthalocyanine Blue. Surgipro™ sutures are available in sizes 1 (4 Metric), through 6-0 (0.7 Metric). Surgipro™ II sutures are available in sizes 3-0 (2 Metric) through 8-0 (0.4 Metric). The sutures are supplied sterile; affixed to various types of needles, using both permanent needle attachment techniques. Surgipro™ and Surgipro™ II polypropylene sutures are also available with PTFE (polytetrafluorethylene) Pledgets for use as a pad between the suture area and the tissue surface to increase the load bearing area. Surgipro™ polypropylene sutures are available in presentations containing Bead and Collar components to anchor the ends of the suture for subcuticular closure or for use as tendon sutures.

Surgipro™ / Surgipro™ II





Surgipro™ / Surgipro™ II suture is a brand you have trusted for many years with several product innovations.

REVERSE CUTTING								
Needles Specifications	Size	USP	EP	Length cm	Color	Units Per box	Comments	Reorder code
C-12 3/8 Circle 16 mm 	6-0		0.7	45	Blue	12		SP-660G
	6-0		0.7	45	Blue	36		SP-660
	5-0		1	45	Blue	12		SP-559G
	4-0		1.5	75	Blue	36		SP-631
C-13 3/8 Circle 19 mm 	5-0		1	45	Blue	36		SP-661
	5-0		1	45	Blue	12		SP-661G
	4-0		1.5	45	Blue	36		SP-683
	4-0		1.5	45	Blue	12		SP-683G
	3-0		2	45	Blue	12		SP-665G
	3-0		2	45	Blue	36		SP-665
	3-0		2	75	Blue	36		SP-655
C-14 3/8 Circle 24 mm 	4-0		1.5	45	Blue	36		SP-629
	3-0		2	45	Blue	36		SP-684
	3-0		2	45	Blue	12		SP-684G



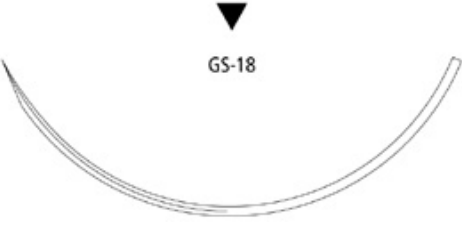

REVERSE CUTTING

Needles Specifications	Size		Length cm	Color	Units Per box	Comments	Reorder code
	USP	EP					
C-15 3/8 Circle 26 mm 	2-0	3	45	Blue	12		SP-868G
	2-0	3	45	Blue	36		SP-868
	2-0	3	75	Blue	36		SP-685
C-16 3/8 Circle 30 mm 	4-0	1.5	75	Blue	36	Nupack	SP-670
	3-0	2	75	Blue	36		SP-675
C-18 3/8 Circle 35 mm 	3-0	2	75	Blue	12	2 beads & 2 collars	SP-624-BC
C-17 3/8 Circle 39 mm 	3-0	2	75	Blue	36		SP-649
	2-0	3	75	Blue	36		SP-689
	0	3.5	75	Blue	36		SP-690



REVERSE CUTTING

Needles Specifications	Size		Length cm	Color	Units Per box	Comments	Reorder code
	USP	EP					
GS-18 3/8 Circle 77 mm 	2	5	75	Blue	24		CP-460
GS-18 3/8 Circle 77 mm Double-arm 	2	5	3 × 60	Blue	12	Long pack	3-CP-360
GS-10 1/2 Circle 26 mm 	2-0	3	75	Blue	36		CP-443
GS-11 1/2 Circle 37 mm 	2-0	3	75	Blue	36		CP-453



PREMIUM REVERSE CUTTING

Needles Specifications	Size USP	EP	Length cm	Color	Units Per box	Comments	Reorder code
P-10 3/8 Circle 11 mm 	7-0	0.5	45	Blue	12	Surgalloy™	SP-1696G
	7-0	0.5	45	Blue	36	Surgalloy™	SP-1696
	6-0	0.7	45	Blue	36	Surgalloy™	SP-1697
	6-0	0.7	45	Clear	36	Surgalloy™	SP-1606
	6-0	0.7	45	Blue	12	Surgalloy™	SP-5697G
	5-0	1	45	Blue	12	Surgalloy™	SP-2698G
P-13 3/8 Circle 13 mm 	6-0	0.7	45	Blue	12	Surgalloy™	SP-5695-G
	6-0	0.7	45	Blue	36	Surgalloy™	SP-5695
	5-0	1	45	Blue	12	Surgalloy™	SP-5698-G
	5-0	1	45	Blue	36	Surgalloy™	SP-5698
	4-0	1.5	45	Blue	12	Surgalloy™	SP-5699G
	4-0	1.5	45	Blue	36	Surgalloy™	SP-5699
P-11 3/8 Circle 16 mm 	6-0	0.7	45	Blue	12	Surgalloy™	SP-5680G
	5-0	1	45	Blue	12	Surgalloy™	SP-5681G
	5-0	1	45	Blue	36	Surgalloy™	SP-5681
	4-0	1.5	45	Blue	12	Surgalloy™	SP-5692G
	3-0	2	45	Blue	12	Surgalloy™	SP-1693G
P-12 3/8 Circle 19 mm 	5-0	1	45	Blue	12	Surgalloy™	SP-5686G
	5-0	1	45	Blue	36	Surgalloy™	SP-5686
	4-0	1.5	45	Blue	12	Surgalloy™	SP-5682G
	4-0	1.5	45	Blue	36	Surgalloy™	SP-5682
	3-0	2	45	Blue	36	Surgalloy™	SP-5687
	3-0	2	45	Blue	12	Surgalloy™	SP-5687G
	3-0	2	75	Blue	36		SP-5587
P-14 3/8 Circle 24 mm 	3-0	2	45	Blue	12	Surgalloy™	SP-5663G
	3-0	2	45	Blue	36		SP-5563

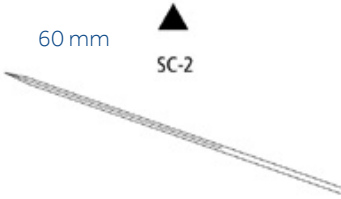
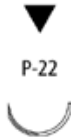
CONVENTIONAL CUTTING

Needles Specifications	Size		Length cm	Color	Units Per box	Comments	Reorder code
	USP	EP					
PC-13 3/8 Circle 11 mm 	6-0	0.7	45	Blue	36		SP-1617
	5-0	1	45	Blue	36		SP-1618
PC-11 3/8 Circle 16 mm 	6-0	0.7	45	Blue	36		SP-1636
	5-0	1	45	Blue	36	Surgalloy™	SP-1635
	4-0	1.5	45	Blue	36		SP-1634
PC-12 3/8 Circle 19 mm 	4-0	1.5	45	Blue	36		SP-1644
	3-0	2	45	Blue	36		SP-1643
SC-2 Straight 60 mm 	4-0	1.5	75	Blue	36		SP-621
	3-0	2	75	Blue	36		SP-622
	3-0	2	75	Blue	24	2 beads and 2 collars	SP-622-BC
	2-0	3	75	Blue	24	2 beads and 2 collars	SP-623-BC
	2-0	3	75	Blue	36		SP-623
P-22 1/2 Circle 13 mm 	4-0	1.5	45	Blue	12	Surgalloy™	SP-8656G

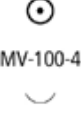

TAPER POINT

Needles Specifications	Size USP	EP	Length cm	Color	Units Per box	Comments	Reorder code
MV-70-3 3/8 Circle 4 mm 	10-0	0.2	13	Blue	12	Surgalloy™	P-2790G
MV-100-4 3/8 Circle 5 mm 	10-0	0.2	13	Blue	12	Surgalloy™	P-2794G
MV-100-4 3/8 Circle 5 mm Double-arm 	10-0	0.2	5	Blue	12	Surgalloy™	P-2795G
MV-135-5 3/8 Circle 6 mm Double-arm 	8-0	0.4	45	Blue	36	Surgalloy™	VP-900-X
	8-0	0.4	5 × 45	Blue	12	Surgalloy™, LONG PACK	VP-901-MX
	8-0	0.4	2 × 45	Blue	12	Surgalloy™, LONG PACK	VP-900-MX
	8-0	0.4	60	Blue	36	Surgalloy™	VP-902-X
	8-0	0.4	5 × 60	Blue	12	Surgalloy™, LONG PACK	VP-903-MX
	8-0	0.4	2 × 60	Blue	12	Surgalloy™, LONG PACK	VP-902-MX
	8-0	0.4	75	Blue	12	Surgalloy™, LONG PACK	VP-973-X
	7-0	0.5	60	Blue	36	Surgalloy™	VP-904-X
	7-0	0.5	2 × 60	Blue	12	Surgalloy™, LONG PACK	VP-904-MX





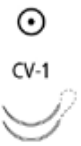

TAPER POINT

Needles Specifications	Size USP	EP	Length cm	Color	Units Per box	Comments	Reorder code
MVF-135-5 3/8 Circle 6 mm 	8-0	0.4	2 × 60	Blue	12	Surgalloy™, LONG PACK	VP-209MX
MV-175-8 3/8 Circle 8 mm Double-arm 	8-0	0.4	45	Blue	36	Surgalloy™	VP-744-X
	8-0	0.4	2 × 45	Blue	12	Surgalloy™, LONG PACK	VP-744-MX
	8-0	0.4	60	Blue	36	Surgalloy™	VP-745-X
	8-0	0.4	2 × 60	Blue	12	Surgalloy™, LONG PACK	VP-743-MX
	8-0	0.4	2 × 75	Blue	12	Surgalloy™, LONG PACK	VP-753-MX
	7-0	0.5	2 × 45	Blue	12	LONG PACK	VP-736-M
	7-0	0.5	45	Blue	36	Surgalloy™	VP-628
	7-0	0.5	5 × 45	Blue	12	Surgalloy™, LONG PACK	VP-734-MX
	7-0	0.5	60	Blue	36	Surgalloy™	VP-735-X
	7-0	0.5	2 × 60	Blue	12	Surgalloy™, LONG PACK	VP-737-MX
	7-0	0.5	5 × 60	Blue	12	Surgalloy™, LONG PACK	VP-735-MX
	7-0	0.5	75	Blue	36	Surgalloy™	VP-747-X
	7-0	0.5	2 × 75	Blue	12	Surgalloy™, LONG PACK	VP-747-MX
	MVF-175-8 3/8 Circle 8 mm Double-arm 	8-0	0.4	2 × 60	Blue	12	Surgalloy™
7-0		0.5	60	Blue	36	Surgalloy™	VPF-735-X





TAPER POINT

Needles Specifications	Size USP	EP	Length cm	Color	Units Per box	Comments	Reorder code	
CV-351 3/8 Circle 8 mm Double-arm		8-0	0.4	60	Blue	36	Cardiopoint™	VP-738-X
		8-0	0.4	2 × 60	Blue	12	Cardiopoint™, LONG PACK	VP-738-MX
		7-0	0.5	60	Blue	36	Cardiopoint™	VP-630-X
		6-0	0.7	60	Blue	36	Cardiopoint™	VP-631-X
CV-1 3/8 Circle 9 mm Double-arm		7-0	0.5	60	Blue	36	Optivis™	VP-72-X
		7-0	0.5	5 × 60	Blue	12	Optivis™, LONG PACK	VP-72-MX
		7-0	0.5	75	Blue	12	Optivis™, LONG PACK	VP-37-MX
		7-0	0.5	45	Blue	36	Surgalloy™, NUPACK™	VP-701-X
		7-0	0.5	5 × 45	Blue	12	Surgalloy™, LONG PACK	VP-701-MX
		7-0	0.5	60	Blue	36	Surgalloy™, NUPACK™	VP-702-X
		7-0	0.5	5 × 60	Blue	12	Surgalloy™, LONG PACK	VP-702-MX
		7-0	0.5	75	Blue	36	Surgalloy™, NUPACK™	VP-713-X
		7-0	0.5	5 × 75	Blue	12	Surgalloy™, LONG PACK	VP-713-MX
		6-0	0.7	45	Blue	36	Surgalloy™, NUPACK™	VP-746-X
		6-0	0.7	2 × 45	Blue	12	Surgalloy™, LONG PACK	VP-746-MX
		6-0	0.7	60	Blue	36	Surgalloy™, NUPACK™	VP-703-X
		6-0	0.7	60	Blue	12	Surgalloy™, LONG PACK	VP-703-MX
		6-0	0.7	75	Blue	12	Surgalloy™, LONG PACK	VP-709-MX
		6-0	0.7	75	Blue	36	Surgalloy™, NUPACK™	VP-709-X
		6-0	0.7	90	Blue	36	Surgalloy™, NUPACK™	VP-365-X
		6-0	0.7	60	Blue	36	Optivis™, NUPACK™	VP-73-X
		6-0	0.7	5 × 60	Blue	12	Optivis™, LONG PACK	VP-73-MX
CVF-1 3/8 Circle 9 mm Double-arm		7-0	0.5	2 × 60	Blue	12	Surgalloy™, LONG PACK	VP-102-MX
		7-0	0.5	60	Blue	36	Surgalloy™, NUPACK™	VPF-702-X
		7-0	0.5	75	Blue	36	Surgalloy™, NUPACK™	VPF-713-X
		6-0	0.7	60	Blue	36	Surgalloy™, NUPACK™	VPF-703-X
		6-0	0.7	75	Blue	36	Surgalloy™, NUPACK™	VPF-709-X
		6-0	0.7	5 × 60	Blue	12	Surgalloy™, LONG PACK	VPF-703-MX





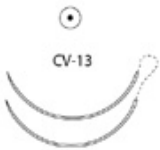

TAPER POINT

Needles Specifications	Size USP	EP	Length cm	Color	Units Per box	Comments	Reorder code
MV-175-9 3/8 Circle 10 mm Double-arm 	8-0	0.4	60	Blue	36	Surgalloy™	VP-763-X
	7-0	0.5	5 × 75	Blue	12	Surgalloy™, LONG PACK	VP-875-MX
	7-0	0.5	75	Blue	36	Surgalloy™	VP-875-X
	7-0	0.5	5 × 60	Blue	12	Surgalloy™, LONG PACK	VP-759-MX
CV 3/8 Circle 11 mm Double-arm 	6-0	0.7	5 × 60	Blue	36	Optivis™, NUPACK™	VP-74-X
	6-0	0.7	75	Blue	36	Surgalloy™, NUPACK	VP-776-X
CVF 3/8 Circle 11 mm Double-arm 	6-0	0.7	75	Blue	36	Surgalloy™, NUPACK	VPF-776-X
CVL Cardio curve 11 mm Double-arm 	7-0	0.5	2 × 60	Blue	12	Optivis™	VP-652-MX
CV-11 3/8 Circle 13 mm 	6-0	0.7	75	Blue	36	Surgalloy™	VP-889-X
	5-0	1	75	Blue	36	Surgalloy™	VP-890-X
CV-11 3/8 Circle 13 mm Double-arm 	7-0	0.5	75	Blue	36	Surgalloy™	VP-812-X
	7-0	0.5	60	Blue	36	Surgalloy™	VP-727-X
	7-0	0.5	45	Blue	36	Surgalloy™	VP-800-X
	6-0	0.7	90	Blue	36	Surgalloy™	VP-363X
	6-0	0.7	5 × 75	Blue	12	Surgalloy™	VP-706-MX
	6-0	0.7	75	Blue	36	Surgalloy™	VP-706-X
	6-0	0.7	5 × 45	Blue	12	Surgalloy™	VP-718-MX
	6-0	0.7	45	Blue	36	Surgalloy™	VP-718-X
	6-0	0.7	5 × 60	Blue	12	Surgalloy™	VP-726-MX
	6-0	0.7	60	Blue	36	Surgalloy™	VP-726-X
	6-0	0.7	5 × 75	Blue	12	Optivis™	VP-76-MX
	6-0	0.7	75	Blue	36	Optivis™	VP-76-X

TAPER POINT

Needles Specifications	Size USP	EP	Length cm	Color	Units Per box	Comments	Reorder code	
CV-11 3/8 Circle 13 mm Double-arm		6-0	0.7	45	Blue	36	Optivis™	VP-78-X
		5-0	1	5 × 75	Blue	12	Surgalloy™	VP-705-MX
		5-0	1	75	Blue	36	Surgalloy™	VP-705-X
		5-0	1	90	Blue	36	Optivis™	VP-70-X
		5-0	1	45	Blue	36	Surgalloy™	VP-719-X
		5-0	1	90	Blue	36	Surgalloy™	VP-720-X
		5-0	1	5 × 60	Blue	12	Surgalloy™	VP-725-MX
		5-0	1	60	Blue	36	Surgalloy™	VP-725-X
		5-0	1	60	Blue	36	Optivis™	VP-75-X
		5-0	1	5 × 45	Blue	12	Surgalloy™ LONG PACK	VP-719-MX
		5-0	1	2 × 75	Blue	12	Surgalloy™ LONG PACK	VP-897-M
		5-0	1	5 × 90	Blue	12	Surgalloy™ LONG PACK	VP-720-MX
		4-0	1.5	75	Blue	36	Surgalloy™	VP-813-X
		CVF-11 3/8 Circle 13 mm Double-arm		6-0	0.7	60	Blue	36
6-0	0.7			5 × 60	Blue	12	Surgalloy™, LONG PACK	VP-126-MX
6-0	0.7			75	Blue	36	Surgalloy™, NUPACK	VPF-706-X
5-0	1			90	Blue	36	Surgalloy™	VPF-720-X
5-0	1			5 × 90	Blue	12	Surgalloy™, LONG PACK	VP-120-MX
CV-301 3/8 Circle 13 mm Double-arm		6-0	0.7	75	Blue	12		VP-86-X
CV-15 3/8 Circle 17 mm		4-0	1.5	75	Blue	36	Surgalloy™	VP-881-X
CV-15 3/8 Circle 17 mm Double-arm		5-0	1	75	Blue	36	Surgalloy™	VP-570X
		5-0	1	90	Blue	36	Surgalloy™, NUPACK	VP-580- X
		4-0	1.5	60	Blue	36	Surgalloy™	VP-584-X
		4-0	1.5	90	Blue	36	3 mm × 7 mm FIRM	VP-582-X
		4-0	1.5	90	Blue	36	Surgalloy™	VP-581-X
		4-0	1.5	120	Blue	36	Surgalloy™	VP-583-X
		3-0	2	90	Blue	36	Surgalloy™	VP-585-X
CV-13 3/8 Circle 22 mm Double-arm		4-0	1.5	75	Blue	36	Surgalloy™	VP-841-X
		4-0	1.5	90	Blue	36	Surgalloy™	VP-851-X
		3-0	2	90	Blue	36	Surgalloy™	VP-532-X
		2-0	3	90	Blue	36		VP-533





TAPER POINT

Needles Specifications	Size	USP	EP	Length cm	Color	Units Per box	Comments	Reorder code
CV-20 1/2 Circle 10 mm Double-arm		7-0	0.5	60	Blue	36	Surgalloy™, NUPACK™	VP-772-X
		6-0	0.7	60	Blue	36	Surgalloy™, NUPACK™	VP-754-X
		5-0	1	60	Blue	36	Surgalloy™, NUPACK™	VP-755-X
CV-337 1/2 Circle 10 mm Double-arm		6-0	0.7	60	Blue	36	Cardiopoint™	VP-854-X
CVF-21 1/2 Circle 12 mm Double-arm		4-0	1.5	60	Blue	36	Surgalloy™	VPF-610-X
CV-22 1/2 Circle 13 mm Double-arm		6-0	0.7	45	Blue	36	Surgalloy™, NUPACK™	VP-714-X
		6-0	0.7	60	Blue	36	Surgalloy™, NUPACK™	VP-711-X
		6-0	0.7	5 × 75	Blue	12	Surgalloy™, LONG PACK	VP-733-MX
		6-0	0.7	75	Blue	36	Surgalloy™, NUPACK	VP-733-X
		5-0	1	45	Blue	36	Surgalloy™, NUPACK™	VP-715-X
		5-0	1	60	Blue	36	Surgalloy™, NUPACK™	VP-205-X
		5-0	1	5 × 75	Blue	12	Surgalloy™, LONG PACK	VP-710-MX
		5-0	1	75	Blue	36	Surgalloy™, NUPACK	VP-710-X
		4-0	1.5	60	Blue	36	Surgalloy™	VP-204-X
CVF-22 1/2 Circle 13 mm Double-arm		6-0	0.7	75	Blue	36	Surgalloy™, NUPACK	VPF-733-X
		5-0	1	75	Blue	36	Surgalloy™, NUPACK	VPF-710-X
		5-0	1	90	Blue	36	Surgalloy™, NUPACK	VPF-711-X
		3-0	2	90	Blue	12		VP-972X
CV-23 1/2 Circle 17 mm		5-0	1	75	Blue	36	Surgalloy™	VP-870-X
		4-0	1.5	75	Blue	36	Surgalloy™	VP-871-X
		3-0	2	75	Blue	36	Surgalloy™	VP-872-X

TAPER POINT

Needles Specifications	Size USP	EP	Length cm	Color	Units Per box	Comments	Reorder code	
CV-23 1/2 Circle 17 mm Double-arm		6-0	0.7	90	Blue	36	Surgalloy™	VP-555X
		5-0	1	90	Blue	36	Optivis™	VP-660-X
		5-0	1	90	Blue	36	Surgalloy™	VP-556X
		5-0	1	90	Blue	36	Surgalloy™	VP-566X
		5-0	1	5 × 90	Blue	12	Surgalloy™	VP-556MX
		4-0	1.5	90	Blue	36	Surgalloy™	VPP-557-X
		4-0	1.5	5 × 90	Blue	12	Surgalloy™	VP-557MX
		4-0	1.5	45	Blue	36	Surgalloy™	VP-757-X
		4-0	1.5	90	Blue	36	Surgalloy™	VP-557X
		3-0	2	90	Blue	36	Surgalloy™	VP-558X
		2-0	3	90	Blue	36	455	VP-559-X
CVF-23 1/2 Circle 17 mm Double-arm		4-0	1.5	90	Blue	36	Surgalloy™	VPF-557-X
CV-24 1/2 Circle 20 mm Double-arm		4-0	1.5	90	Blue	36		VP-331X
CV-25 1/2 Circle 22 mm		4-0	1.5	75	Blue	36	Surgalloy™	VP-771-X
CV-25 1/2 Circle 22 mm Double-arm		4-0	1.5	90	Blue	36	Surgalloy™	VP-761-X
		4-0	1.5	5 × 90	Blue	12	Surgalloy™, LONG PACK	VP-761-MX
		3-0	2	75	Blue	36	Surgalloy™	VP-760-X
		3-0	2	90	Blue	36	Surgalloy™	VP-762-X

TAPER POINT

Needles Specifications	Size		Length cm	Color	Units Per box	Comments	Reorder code
	USP	EP					
V-20 1/2 Circle 26 mm 	4-0	1.5	75	Blue	36	Surgalloy™	VP-831X
	3-0	2	75	Blue	36	Surgalloy™	VP-832X
	2-0	3	75	Blue	36	Surgalloy™	VP-833
	0	3.5	75	Blue	36	Surgalloy™	VP-834
V-20 1/2 Circle 26 mm Double-arm 	5-0	1	75	Blue	36	Surgalloy™, NUPACK	VP-510X
	5-0	1	90	Blue	36	Surgalloy™	VP-520X
	4-0	1.5	75	Blue	36	Surgalloy™	VP-511-X
	4-0	1.5	90	Blue	36	4.8 mm × 9.5 mm SOFT	VP-621-X
	4-0	1.5	90	Blue	36	Surgalloy™	VP-521-X
	4-0	1.5	90	Blue	36	3 mm × 7 mm FIRM	VP-421X
	4-0	1.5	120	Blue	36	Surgalloy™	VP-541X
	3-0	2	90	Blue	36	Surgalloy™	VP-522-X
	3-0	2	90	Blue	36	3 mm × 7 mm FIRM	VP-422X
	3-0	2	120	Blue	36	Surgalloy™	VP-542-X
	2-0	3	90	Blue	36	Surgalloy™	VP-523
	2-0	3	120	Blue	36	Surgalloy™	VP-543
	VF-20 1/2 Circle 26 mm 	3-0	2	45	Blue	36	Surgalloy™
VF-20 1/2 Circle 26 mm Double-arm 	4-0	1.5	90	Blue	36	Surgalloy™	VPF-521-X
	3-0	2	90	Blue	36	Surgalloy™	VPF-522-X
	3-0	2	135	Blue	36	Surgalloy™	VPF-354-X
	2-0	3	120	Blue	36	Surgalloy™	VPF-543
GS-22 1/2 Circle 27 mm 	2-0	3	5 × 45	Blue	12	D-Tach™	CP-16-M
	2-0	3	75	Blue	36		CP-411
	0	3.5	5 × 45	Blue	12	D-Tach™	CP-17-M
	0	3.5	75	Blue	36		CP-412



TAPER POINT

Needles Specifications			Size		Length cm	Color	Units Per box	Comments	Reorder code																	
			USP	EP																						
V-30 1/2 Circle 30 mm 	2-0	3	75	Blue	36			VP-945																		
GS-21 1/2 Circle 37 mm 	3-0 2-0 0 0 1	2 3 3.5 3.5 4	75 75 5 × 45 75 75	Blue Blue Blue Blue Blue	36 36 12 36 36	D-Tach™		CP-422 CP-423 CP-10-M CP-424 CP-425																		
									V-26 1/2 Circle 37 mm Double-arm 	3-0 2-0 2-0	2 3 3	90 90 120	Blue Blue Blue	36 36 36			VP-842-X VP-843 VP-853									
																		GS-24 1/2 Circle 40 mm 	2-0 0 1 1	3 3.5 4 4	75 75 75 100	Blue Blue Blue Blue	36 36 36 36			CP-433 CP-434 CP-435 CP-535
									GS-26 1/2 Circle 65 mm 	0 1 2	3.5 4 5	3 × 60 150 150	Blue Blue Blue	12 24 24			3CP-444 CP-824 CP-825									

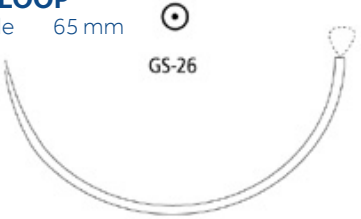
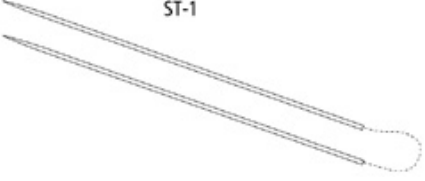



TAPER POINT

Needles Specifications	Size		Length cm	Color	Units Per box	Comments	Reorder code
	USP	EP					
GS-26 LOOP 1/2 Circle 65 mm 	1	4	120	Blue	24	Loop	CP-824-L
	1	4	240	Blue	24	Loop	CP-834-L
ST-1 Straight 51 mm Double-arm 	2-0	3	90	Blue	36		GP-282



HEAVY TAPER POINT

Needles Specifications	Size		Length cm	Color	Units Per box	Comments	Reorder code
	USP	EP					
HGS-23 1/2 Circle 22 mm 	0	3.5	5 × 45	Blue	12	D-Tach™, LONG PACK	CP-92-M
HGS-22 1/2 Circle 27 mm 	0	3.5	75	Blue	36		CP-414
	1	4	90	Blue	36		CP-415

TAPERCUTTING

Needles Specifications	Size USP	EP	Length cm	Color	Units Per box	Comments	Reorder code	
KV-1 3/8 Circle 9 mm Double-arm		7-0	0.5	45	Blue	12	LONG PACK	VP-721-MX
		7-0	0.5	60	Blue	36	Surgalloy™	VP-704-X
		7-0	0.5	5 × 60	Blue	12	Surgalloy™, LONG PACK	VP-704-MX
		6-0	0.7	60	Blue	36	Surgalloy™, NUPACK	VP-712-X
		6-0	0.7	5 × 60	Blue	12	Surgalloy™, LONG PACK	VP-712-MX
KVF-1 3/8 Circle 9 mm Double-arm		7-0	0.5	60	Blue	36	Surgalloy™, NUPACK	VPF-704-X
		6-0	0.7	75	Blue	36	Surgalloy™, NUPACK	VPF-807-X
YV-95 3/8 Circle 9.5 mm Double-arm		7-0	0.5	60	Blue	36	Cardiopoint™	VP-911-X
KV-11 3/8 Circle 13 mm Double-arm		6-0	0.7	60	Blue	36	Surgalloy™, NUPACK	VP-707-X
		6-0	0.7	75	Blue	36	Surgalloy™, NUPACK	VP-728-X
		6-0	0.7	5 × 75	Blue	12	Surgalloy™, LONG PACK	VP-728-MX
		5-0	1	75	Blue	36	Surgalloy™, NUPACK	VP-708-X
		5-0	1	90	Blue	36	Surgalloy™, NUPACK	VP-751-X
KVF-11 3/8 Circle 13 mm Double-arm		6-0	0.7	75	Blue	36	Surgalloy™, NUPACK	VPF-728-X

TAPERCUTTING

Needles Specifications	Size		Length cm	Color	Units Per box	Comments	Reorder code
	USP	EP					
KV-15 3/8 Circle 17 mm 	5-0	1	75	Blue	36	Surgalloy™, NUPACK	VP-941-X
	4-0	1.5	75	Blue	36	Surgalloy™	VP-942-X
KV-15 3/8 Circle 17 mm Double-arm 	5-0	1	75	Blue	36	Surgalloy™, NUPACK	VP-914-X
	5-0	1	90	Blue	36	Surgalloy™	VP-924-X
	4-0	1.5	90	Blue	36	Surgalloy™	VP-925-X
	3-0	2	90	Blue	36	Surgalloy™	VP-926-X
KV-26 3/8 Circle 26 mm Double-arm 	4-0	1.5	90	Blue	36	Surgalloy™	VP-965
	3-0	1.5	90	Blue	36		VP-956
KV-5 1/2 Circle 17 mm Double-arm 	5-0	1	90	Blue	36	Surgalloy™, NUPACK	VP-934-X
	4-0	1.5	90	Blue	36	Surgalloy™	VP-935-X
	4-0	1.5	90	Blue	36	3 mm × 7 mm FIRM	VP-435-X
	3-0	2	90	Blue	36	Surgalloy™	VP-936-X
	2-0	3	90	Blue	36	Surgalloy™	VP-937
KV-7 1/2 Circle 26 mm Double-arm 	4-0	1.5	90	Blue	36	Surgalloy™	VP-975-X
	3-0	2	90	Blue	36	Surgalloy™	VP-976-X
	3-0	2	90	Blue	36	3 mm × 7 mm FIRM	VP-986-X
	2-0	3	90	Blue	36	Surgalloy™	VP-977
	0	3.5	90	Blue	36	Surgalloy™	VP-978
KV-34 1/2 Circle 37 mm 	0	3.5	75	Blue	36		CP-844
	1	4	75	Blue	36		CP-845

BLUNT POINT

Needles Specifications	Size		Length cm	Color	Units Per box	Comments	Reorder code
	USP	EP					
BGS-21 1/2 Circle 37 mm 	0	3.5	75	Blue	36	ProtectPoint™	CP-957
BGS-25 1/2 Circle 48 mm 	1	4	100	Blue	36	ProtectPoint™	CP-836

SPATULA

Needles Specifications	Size		Length cm	Color	Units Per box	Comments	Reorder code
	USP	EP					
SE-140-8 3/8 Circle 6.3 mm Double-arm Curvature 140° 	10-0	0.2	30	Blue	12	Surgalloy™	P-2771K
SE-160-6 1/2 Circle 5.5 mm Double-arm Curvature 160° 	10-0	0.2	30	Blue	12	Surgalloy™	P-2756K

TI-CRON™ / SURGIDAC™

Coated and Uncoated Braided Polyester

A brand you have trusted for over 35 years.



Please refer to the individual package IFUs for complete instructions, indications, contraindications, warnings and precautions.

Description

Ti-Cron™ and Surgidac™ polyester sutures are non absorbable, sterile, surgical sutures composed of Polyethylene Terephthalate. They are prepared from fibers of high molecular weight, long-chain, linear polyesters having recurrent aromatic rings as an integral component. Ti-Cron™ braided sutures are available coated uniformly with silicone to increase surface lubricity, thereby enhancing handling characteristics, ease of passage through tissue, and knot run-down properties. Surgidac™ sutures are uncoated and the braided sutures are available uncoated or coated uniformly with polybutylene adipate to increase surface lubricity, thereby enhancing handling characteristics, ease of passage through tissue, and knot run-down properties.

Indications

Ti-Cron™ and Surgidac™ polyester sutures are indicated for use in general soft tissue approximation and/or ligation.

Actions

Ti-Cron™ and Surgidac™ polyester sutures elicit a minimal acute inflammatory reaction in tissues, followed by gradual encapsulation of the suture by fibrous connective tissue.

Tensile Strength

Ti-Cron™ and Surgidac™ polyester sutures are not absorbed, nor is any significant change in tensile strength retention known to occur in vivo.

Sterilization

Ti-Cron™ and Surgidac™ polyester sutures in sizes 6-0 or smaller or pledgeted sutures are sterilized by ethylene oxide. Sizes 5-0 or greater are sterilized by gamma irradiation.

Packaging

Ti-Cron™ polyester sutures are available undyed (white) or dyed with D&C Blue No. 6 and braided, coated, in sizes 5 (7 Metric), size 2 (5 metric), size 1 (4 metric), 0 size (3.5 metric) through 5-0 (1 Metric). SURGIDAC™ polyester sutures are available undyed (white), braided and uncoated in USP and EP sizes 5-0 (1 metric). The sutures are supplied sterile, in pre-cut lengths, affixed to various needle types using both permanent and removable needle attachment techniques. Ti-Cron™ polyester sutures are also available with PTFE (polytetrafluorethylene) pledgets for use as a pad between the suture area and the tissue surface to increase the load bearing area. Please refer to the individual package IFUs for complete instructions, indications, contraindications, warnings and precautions.





Ti-Cron™ / Surgidac™

Ti-Cron™ / Surgidac™ is a suture brand you have trusted for over 35 years with a proven history for performance





PRE-CUT							
Needles Specifications	Size		Length cm	Color	Units Per box	Comments	Reorder code
	USP	EP					
	5-0	1	12×45	Blue	36	Pre-cut	88863008-21
	4-0	1.5	12×45	Blue	36	Pre-cut	88863008-31
	4-0	1.5	12×75	Blue	24	Pre-cut	88863003-32
	3-0	2	12×45	Blue	36	Pre-cut	88863008-41
	3-0	2	6×45	Blue	36	Pre-cut	88863001-41
	3-0	2	12×75	Blue	24	Pre-cut	88863003-42
	2-0	3	5×45	White	12	Pre-cut	88863011-51
	2-0	3	12×45	Blue	36	Pre-cut	88863008-51
	2-0	3	12×75	Blue	24	Pre-cut	88863003-52
	0	3.5	6×45	Blue	24	Pre-cut	88863001-62
	0	3.5	6×75	Blue	24	Pre-cut	88863002-62
	1	4	6×45	Blue	24	Pre-cut	88863001-72

REEL							
Needles Specifications	Size		Length cm	Color	Units Per box	Comments	Reorder code
	USP	EP					
	3-0	2	250	Blue	24	Reel	88863380-42
	2-0	3	250	Blue	24	Reel	88863380-52
	0	3.5	250	Blue	24	Reel	88863380-62
	1	4	250	Blue	24	Reel	88863380-72
	2	5	250	Blue	24	Reel	88863380-82
	4	6	150	Blue	24	Reel	88863381-09
	5	7	150	Blue	24	Reel	88863381-89

REVERSE CUTTING

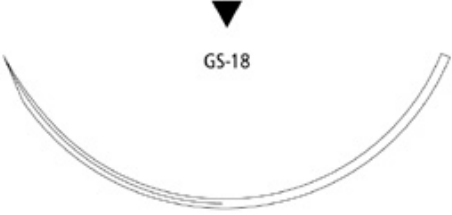
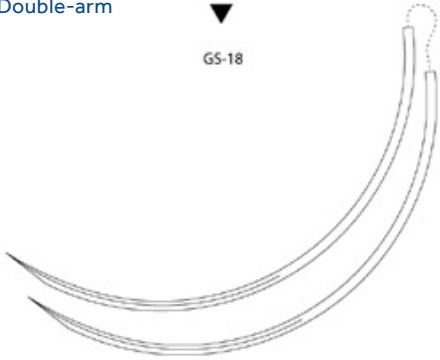
Needles Specifications	Size USP	EP	Length cm	Color	Units Per box	Comments	Reorder code
C-12 3/8 Circle 16 mm 	5-0	1	45	Blue	36		88863045-21
	4-0	1.5	75	Blue	36		88863046-31
C-13 3/8 Circle 19 mm 	4-0	1.5	45	Blue	36		88863047-31
	3-0	2	75	Blue	36		88863047-41
	3-0	2	45	Blue	36		88863055-41
	2-0	3	75	Blue	36		88863048-51
C-14 3/8 Circle 24 mm 	3-0	2	45	Blue	36		88863069-41
	3-0	2	75	Blue	36		88863050-41
	2-0	3	75	Blue	36		88863050-51
	2-0	3	90	Blue	36		88863065-51
	0	3.5	75	Blue	36		88863050-61
	0	3.5	90	Blue	36		88863065-61
C-15 3/8 Circle 26 mm 	2-0	3	75	Blue	36		88863070-51
C-16 3/8 Circle 30 mm 	2-0	3	75	Blue	36		88863023-51
	0	3.5	75	Blue	36		88863023-61
	0	3.5	90	Blue	36		88863012-61
	1	4	75	Blue	36		88863023-71



REVERSE CUTTING

Needles Specifications	Size		Length cm	Color	Units Per box	Comments	Reorder code
	USP	EP					
C-17 3/8 Circle 39 mm 	2-0	3	75	Blue	36		88863054-51
	0	3.5	75	Blue	36		88863054-61
	1	4	75	Blue	36		88863054-71
	2	5	75	Blue	36		88863054-81
GS-18 3/8 Circle 77 mm 	5	7	45	Blue	12		88863056-89
GS-18 3/8 Circle 77 mm Double-arm 	5	7	75	Blue	24		88863128-79
	2	5	75	Blue	24		88863128-82
	2	5	75	Green	24		CD-496
HOS-10 1/2 Circle 26 mm 	2-0	3	75	Blue	36		88863395-51
	0	3.5	75	Blue	36		88863395-61
	1	4	75	Blue	36		88863395-71
	2	5	75	Blue	36		88863395-81
GS-11 1/2 Circle 37 mm 	2-0	3	75	Blue	36		88863309-51
	0	3.5	75	Blue	36		88863309-61
	1	4	75	Blue	36		88863309-71
	4	6	75	Blue	36		88863154-09
HOS-11 1/2 Circle 37 mm 	1	4	75	Blue	36		88863028-71
	2	5	75	Blue	36		88863028-81



REVERSE CUTTING

Needles Specifications	Size		Length cm	Color	Units Per box	Comments	Reorder code
	USP	EP					
GS-12 1/2 Circle 40 mm 	2	5	75	Blue	36		88863155-81
HOS-12 1/2 Circle 40 mm 	1	4	75	Blue	36		88863026-71
	2	5	75	Blue	36		88863026-81
HOS-14 1/2 Circle 55 mm 	5	7	75	Blue	36		88863027-79

PREMIUM REVERSE CUTTING

Needles Specifications	Size		Length cm	Color	Units Per box	Comments	Reorder code
	USP	EP					
P-13 3/8 Circle 13 mm 	5-0	1	45	Blue	12	Surgalloy™	SCD-3058G
	5-0	1	45	White	12	Surgalloy™	SCD-2864G
	4-0	1.5	45	Blue	12	Surgalloy™	SCD-3059G
	4-0	1.5	45	White	12	Surgalloy™	88862862-34
P-12 3/8 Circle 19 mm 	4-0	1.5	45	Blue	12	Surgalloy™	SCD-3049G

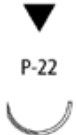

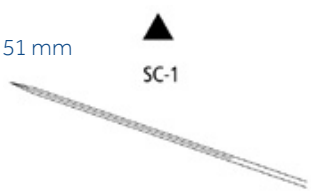
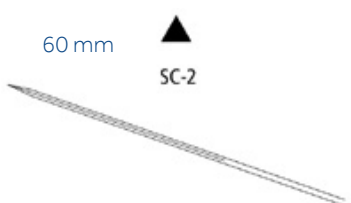
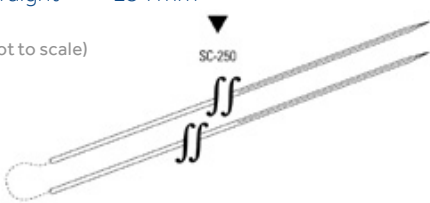

PREMIUM REVERSE CUTTING

Needles Specifications	Size		Length cm	Color	Units Per box	Comments	Reorder code
	USP	EP					
P-21 1/2 Circle 9 mm 	4-0	1.5	45	White	12		88862854-33
P-22 1/2 Circle 13 mm 	3-0	2	45	Blue	12	Surgalloy™	88863109-43
P-24 1/2 Circle 16 mm 	2-0	3	45	Blue	12	Surgalloy™	88863059-53



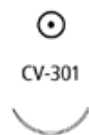

CONVENTIONAL CUTTING

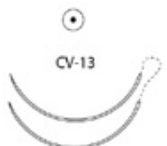
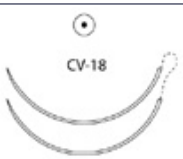
Needles Specifications	Size		Length cm	Color	Units Per box	Comments	Reorder code
	USP	EP					
SCC 1/2 Circle 48 mm 	5	7	5×75	Blue	6		88863127-79
SC-1 Straight 51 mm 	2-0	3	75	Blue	36		88863163-51
	0	3.5	75	Blue	36		88863163-61
	1	4	75	Blue	36		88863163-71
SC-2 Straight 60 mm 	3-0	2	75	Blue	36		88863062-41
	2-0	3	75	Blue	36		88863062-51
	2-0	3	90	Blue	36		88863165-51
	0	3.5	75	Blue	36		88863062-61
SC-250 Straight 254 mm (Not to scale) 	2-0	3	75	Blue	12		88862947-53

TAPER POINT

Needles Specifications	Size USP	EP	Length cm	Color	Units Per box	Comments	Reorder code	
CV-310 3/8 Circle 10 mm Double-arm	7-0	0.5	45	Blue	36	Cardiopoint™	88863288-01	
								
CV-301 3/8 Circle 13 mm	4-0	1.5	75	Blue	36	Cardiopoint™	88863106-31	
								
CV-301 3/8 Circle 13 mm Double-arm	6-0	0.7	75	Blue	36	Cardiopoint™	88863280-11	
		5-0	1	75	Blue	36	3mm x 3mm FIRM, Cardiopoint™	88863314-21
	5-0	1	75	Blue	36	Cardiopoint™	88863280-21	
	5-0	1	75	White	36	Cardiopoint™	88862801-21	
	4-0	1.5	75	Blue	36	3 mm x 3 mm Firm, Cardiopoint™	88863314-31	
	4-0	1.5	75	Blue	36	Cardiopoint™	88863280-31	
	3-0	2	75	Blue	36	Cardiopoint™	88863280-41	
								
CV-15 3/8 Circle 17 mm Double-arm	2-0	3	90	White	6	Surgalloy™	8886263656	
								
CV-327 3/8 Circle 18 mm Double-arm	5-0	1	75	Blue	36	Cardiopoint™	88862775-21	
	4-0	1.5	75	Blue	36	Cardiopoint™	88862775-31	
	3-0	2	75	Blue	36	Cardiopoint™	88862775-41	
								
CV-13 3/8 Circle 22 mm Double-arm	3-0	2	90	Blue	36	Surgalloy™	88862627-41	
								
CV-18 3/8 Circle 26 mm Double-arm	2-0	3	10×90	5 Blue and 5 White	6		88863230-56	
								

TAPER POINT

Needles Specifications	Size USP	EP	Length cm	Color	Units Per box	Comments	Reorder code	
CV-337 1/2 Circle 10 mm Double-arm		5-0	1	75	Blue	36	Cardiopoint™	88863298-21
		5-0	1	90	Blue	36	Pledgets 3 mm × 3 mm FIRM, Cardiopoint™	88863297-21
		5-0	1	90	Blue	36	Cardiopoint™	88863139-21
CV-330 1/2 Circle 13 mm Double-arm		5-0	1	60	Blue	36	Cardiopoint™	88863226-21
		4-0	1.5	60	Blue	36	Cardiopoint™	88863226-31
		4-0	1.5	90	Blue	36	Cardiopoint™	88863249-31
		3-0	2	45	Blue	36	Pledgets 3 mm × 3 mm FIRM, Cardiopoint™	88863295-41
		3-0	2	60	Blue	36	Cardiopoint™	88863226-41
CV-331 1/2 Circle 16 mm		5-0	1	75	Blue	36	Cardiopoint™	88863186-21
		4-0	1.5	75	Blue	36	Cardiopoint™	88863186-31
		3-0	2	75	Blue	36	Cardiopoint™	88863186-41
		2-0	3	75	Blue	36	Cardiopoint™	88863186-51
CV-331 1/2 Circle 16 mm Double-arm		5-0	1	90	Blue	36	Cardiopoint™	88863271-21
		4-0	1.5	75	Blue	36	Cardiopoint™	88863087-31
		4-0	1.5	90	Blue	36	Cardiopoint™	88863271-31
		3-0	2	10×75	Blue	6	Cardiopoint™	88863084-46
		3-0	2	75	Blue	36	Cardiopoint™	88863087-41
		3-0	2	90	Blue	36	Cardiopoint™	88863271-41
		2-0	3	8×75	4 Blue and 4 White	6	3 mm × 3 mm FIRM, Cardiopoint™	88863086-56
		2-0	3	8×75	4 Blue and 4 White	6	Cardiopoint™	88863083-56
		2-0	3	10×75	Blue	6	Cardiopoint™	88863084-56
		2-0	3	8×75	4 Blue and 4 White	6	Pledgets 3 mm × 7 mm FIRM, Cardiopoint™	88863091-56
		2-0	3	75	Blue	36	Cardiopoint™	88863087-51
		2-0	3	90	5 Blue and 5 White	6	Pledgets 3 mm × 3 mm FIRM, Cardiopoint™	88863273-56
		2-0	3	10×90	5 Blue and 5 White	6	Pledgets 3mm × 7 mm FIRM, Cardiopoint™	88863269-56
2-0	3	4×75	blue	6	Oval Pledgets 2 mm × 6 mm FIRM	VCD20331FE		

TAPER POINT

Needles Specifications	Size		Length cm	Color	Units Per box	Comments	Reorder code
	USP	EP					
CV-24 1/2 Circle 20 mm 	3-0	2	5×45	Blue	24	D-Tach™	88863267-42
CV-316 1/2 Circle 20 mm Double-arm 	4-0	1.5	75	Blue	36	Pledgets 3 mm × 7 mm FIRM, Cardiopoint™	88863348-31
	4-0	1.5	90	Blue	36	Cardiopoint™	88863369-31
	3-0	2	75	Blue	36	Cardiopoint™	88863227-41
	3-0	2	90	Blue	36	Cardiopoint™	88863369-41
	2-0	3	10×75	5 Blue and 5 White	6	Cardiopoint™	88863385-56
	2-0	3	75	Blue	36	Cardiopoint™	88863227-51
	2-0	3	75	Blue	36	3 mm × 7 mm FIRM, Cardiopoint™	88863348-51
	2-0	3	10×75	5 Blue and 5 White	6	3 mm × 7 mm FIRM, Cardiopoint™	88863323-56
	2-0	3	75	White	36	3 mm × 7 mm FIRM, Cardiopoint™	88862978-51
	2-0	3	10×75	5 Blue and 5 White	6	Pledgets 3 mm × 3 mm FIRM, Cardiopoint™	88863277-56
	2-0	3	4×75	blue and white	6	Oval Pledgets 3 mm × 6 mm FIRM	VCD20316MFE
	2-0	3	4×75	blue and white	6	Oval Pledgets 3 mm × 6 mm SOFT	VCD20316MSE
	2-0	3	1×75	blue	36	Oval Pledgets 3 mm × 6 mm FIRM	VCD20316FE
	2-0	3	1×75	blue	36	Oval Pledgets 3 mm × 6 mm SOFT	VCD20316SE
	2-0	3	10×75	Blue	6	Cardiopoint™	88863344-56
	2-0	3	90	White	36	Cardiopoint™	88862839-51
	2-0	3	90	Blue	36	Cardiopoint™	88863369-51

TAPER POINT

Needles Specifications	Size		Length cm	Color	Units Per box	Comments	Reorder code
	USP	EP					
GS-23 1/2 Circle 22 mm 	0	3.5	5×45	Blue	24	D-Tach™	88863257-62
CV-25 1/2 Circle 22 mm Double-arm 	2-0	3	90	Blue	36	Surgalloy™	88863370-51





TAPER POINT

Needles Specifications	Size		Length cm	Color	Units Per box	Comments	Reorder code
	USP	EP					
CV-305 1/2 Circle 25 mm 	4-0	1.5	75	Blue	36	Cardioint™	88863185-31
	3-0	2	75	Blue	36	Cardioint™	88863185-41
	2-0	3	10×75	5 Blue and 5 White	6	Cardioint™	88863353-56
	2-0	3	5×75	Blue	24	Cardioint™	88863033-52
	0	3.5	75	Blue	36	Cardioint™	88863185-61
	1	4	75	Blue	36	Cardioint™	88863185-71
	2-0	3	75	Blue	36	Cardioint™	88863185-51
CV-305 1/2 Circle 25 mm Double-arm 	4-0	1.5	90	Blue	36	Cardioint™	88863256-31
	3-0	2	90	Blue	36	Pledgets 3 mm × 7 mm FIRM, Cardioint™	88863336-41
	3-0	2	90	Blue	36	Cardioint™	88863256-41
	3-0	2	105	Blue	36	Cardioint™	88863035-41
	2-0	3	10×75	5 Blue and 5 White	6	3 mm × 7 mm FIRM, Cardioint™	88863324-56
	2-0	3	8×75	4 Blue AND 4 White	6	Pledgets 3 mm × 7 mm SOFT, Cardioint™	VCD-346
	2-0	3	10×75	5 Blue and 5 White	6	Cardioint™	88863356-56
	2-0	3	5×75	Blue	6	Cardioint™	88863040-56
	2-0	3	10×75	5 Blue and 5 White	6	Pledgets 4 mm × 8 mm FIRM, Cardioint™	88863037-56
	4-0	1.5	4×75	blue and white	6	Oval Pledgets 3 mm × 6 mm FIRM	VCD20305MFE
	2-0	3	4×75	blue and white	6	Oval Pledgets 3 mm × 6 mm SOFT	VCD20305MSE
	2-0	3	1×75	blue	36	Oval Pledgets 3 mm × 6 mm FIRM	VCD20305FE
	2-0	3	1×75	blue	36	Oval Pledgets 3 mm × 6 mm SOFT	VCD20305SE
	2-0	3	4×75	blue	6	Oval Pledgets 4.5mm × 6mm FIRM	VCD2030556MFE
	2-0	3	4×75	blue	6	Oval Pledgets 4.5 mm × 6 mm SOFT	VCD2030556MSE
	2-0	3	90	Blue	36	3 mm × 7 mm FIRM, Cardioint™	88863336-51
	2-0	3	90	Blue	36	Cardioint™	88863256-51
	2-0	3	10×90	5 Blue and 5 White	6	Cardioint™	88862981-56
	2-0	3	90	White	36	Cardioint™	88862914-51
	2-0	3	90	White	36	3 mm × 7 mm FIRM, Cardioint™	88862953-51
	2-0	3	8×90	blue	6	Oval Pledgets 3 mm × 6 mm FIRM	VCD2036305FE

TAPER POINT

Needles Specifications	Size		Length cm	Color	Units Per box	Comments	Reorder code
	USP	EP					
CV-305 1/2 Circle 25 mm Double-arm 	2-0	3	8×90	4 Blue and 4 White	6	Pledgets 3 mm × 3 mm FIRM, Cardiopoint™	88863307-56
	2-0	3	6×90	3 Blue and 3 White	6	Pledgets 3 mm × 7 mm FIRM, Cardiopoint™	88863306-56
	2-0	3	10×90	Blue	6	Cardiopoint™	88863220-56
	2-0	3	105	Blue	36	Cardiopoint™	88863035-51
	0	3.5	90	Blue	36	Cardiopoint™	88863256-61
	0	3.5	90	White	36	Cardiopoint™	88862914-61
V-20 1/2 Circle 26 mm 	4-0	1.5	5×45	Blue	24	D-Tach™	88863258-32
	3-0	2	5×45	Blue	24	D-Tach™	88863258-42
	2-0	3	5×45	Blue	24	D-Tach™	88863258-52
	2-0	3	120	Blue	36	Endoscopy	88863129-51
	0	3.5	120	Blue	36	Endoscopy	88863015-61
V-20 1/2 Circle 26 mm Double-arm 	2-0	3	90	Blue	36	Surgalloy™	88863251-51
GS-22 1/2 Circle 27 mm 	2-0	3	75	Blue	36		88863093-51
	0	3.5	5×45	Blue	24	D-Tach™	88863259-62
	0	3.5	75	Blue	36		88863093-61



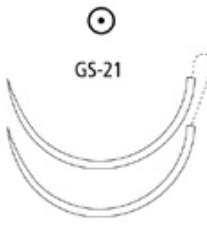

TAPER POINT

Needles Specifications		Size USP	EP	Length cm	Color	Units Per box	Comments	Reorder code
V-30 1/2 Circle 30 mm		3-0	2	75	Blue	36		88863205-41
		2-0	3	75	Blue	36		88863205-51
		0	3.5	75	Blue	36		88863205-61
CV-300 1/2 Circle 35 mm		0	3.5	75	Blue	36	Cardiopoint™	88863082-61
		2-0	3	75	Blue	36	Cardiopoint™	88863082-51
CV-300 1/2 Circle 35 mm Double-arm		2-0	3	75	Blue	36	Cardiopoint™	88863274-51
		2-0	3	90	Blue	36	Cardiopoint™	88863393-51
		0	3.5	75	Blue	36	Cardiopoint™	88863274-61
		0	3.5	90	Blue	36	Cardiopoint™	88863393-61
GS-21 1/2 Circle 37 mm		2-0	3	5×45	Blue	24	D-Tach™	88863260-52
		2-0	3	75	Blue	36		88863090-51
		0	3.5	45	Blue	24	D-Tach™	88863260-62
		0	3.5	75	Blue	36		88863090-61
		1	4	5×45	Blue	24	D-Tach™	88863260-72
		1	4	75	Blue	36		88863090-71
GS-21 1/2 Circle 37 mm Double-arm		2	5	90	Blue	36		88863146-81
		2	5	75	Blue	36		88863090-81

TAPER POINT

Needles Specifications	Size		Length cm	Color	Units Per box	Comments	Reorder code
	USP	EP					
GS-25 1/2 Circle 48 mm 	0	3.5	5×45	Blue	24	D-Tach™	88863261-62
	0	3.5	75	Blue	36		88863097-61
	1	4	5×45	Blue	24	D-Tach™	88863261-72
	1	4	75	Blue	36		88863097-71
	2	5	5×45	Blue	24	D-Tach™	88863261-82
GS-27 1/2 Circle 76 mm Double-arm 	0	3.5	75	Blue	36		88863190-61
GU-46 5/8 Circle 27 mm 	2-0	3	75	Blue	36		88862768-51
SK SKI 23 mm 	2-0	3	120	Blue	36		88863017-51
	0	3.5	120	Blue	36		88863017-61
TJ-32 1/2 Circle 32 mm 	1	4	75	Blue	36		88863103-71



HEAVY TAPER POINT

Needles Specifications	Size USP	EP	Length cm	Color	Units Per box	Comments	Reorder code
HGS-23 1/2 Circle 22 mm 	2-0	3	5×45	Blue	24	D-Tach™	88863374-52
	0	3.5	5×45	Blue	24	D-Tach™	88863374-62
	1	4	75	Blue	36		88863375-71
HGU-46 5/8 Circle 27 mm 	0	3.5	5×45	Blue	24	D-Tach™	88863386-62
HGS-22 1/2 Circle 27 mm 	2-0	3	5×45	Blue	24	D-Tach™	88863379-52
	1	4	5×45	Blue	24	D-Tach™	88863372-72
	2	5	5×45	Blue	24		88863372-82
HGS-21 1/2 Circle 37 mm 	1	4	75	Blue	36		88863113-71
	2	5	75	Blue	36		88863113-81
	5	7	75	Blue	36		88863111-79

HEAVY TAPER POINT

Needles Specifications	Size		Length cm	Color	Units Per box	Comments	Reorder code
	USP	EP					
HGS-24 1/2 Circle 40 mm 	2	5	75	Blue	36		88863376-81

PENETRATING TAPER

Needles Specifications	Size		Length cm	Color	Units Per box	Comments	Reorder code
	USP	EP					
YE-7 3/8 Circle 18 mm 	4-0	1.5	75	Blue	36	Cardioint™	88863107-31
YE-7 3/8 Circle 18 mm Double-arm 	4-0	1.5	75	Blue	36	Cardioint™	88863182-31
	3-0	2	75	Blue	36	Cardioint™	88863182-41
	2-0	3	10×75	5 Blue and 5 White	6	Pledgets 3 mm × 7 mm FIRM, Cardioint™	88863365-56
	2-0	3	75	Blue	36	Pledgets 3 mm × 7 mm FIRM, Cardioint™	88863233-51
	2-0	3	10×75	5 Blue and 5 White	6	Cardioint™	88863211-56
	2-0	3	75	Blue	36	Cardioint™	88863182-51
	2-0	3	5×90	5 Blue and 5 White	6	Cardioint™	88863052-56
	2-0	3	90	5 Blue and 5 White	6	Pledgets 3 mm × 7 mm FIRM, Cardioint™	88862658-56
	2-0	3	90	Blue	36	Cardioint™	88862631-51

PENETRATING TAPER

Needles Specifications	Size		Length cm	Color	Units Per box	Comments	Reorder code
	USP	EP					
Y-31 1/2 Circle 16 mm Double-arm 	4-0	1.5	8×75	4 Blue and 4 White	6	Pledgets 3 mm × 3 mm FIRM, Cardiopoint™	88863218-36
	4-0	1.5	90	Blue	36	Cardiopoint™	88863160-31
	3-0	2	75	White	36	Cardiopoint™	88862880-41
	3-0	2	90	Blue	36	Cardiopoint™	88863160-41
	2-0	3	10×75	5 Blue and 5 White	6	3 mm v 7 mm FIRM, Cardiopointv	88863221-56
	2-0	3	8×75	4 Blue and 4 White	6	3 mm × 7 mm FIRM, Cardiopointv	88863219-56
	2-0	3	8×75	4 Blue and 4 White	6	3 mm × 3 mm FIRM, Cardiopointv	88863218-56
	2-0	3	4×75	blue	6	Oval Pledgets 3mm × 6mm FIRM	VCD2031MFE
	2-0	3	4×75	blue	6	Oval Pledgets 3mm × 6mm SOFT	VCD2031MSE
	2-0	3	75	Blue	36	Cardiopoint™	88863125-51
	2-0	3	75	White	36	Cardiopointv	88862880-51
	2-0	3	10×75	5 Blue and 5 White	6	Cardiopointv	88862877-56
	2-0	3	90	White	36	3 mm × 3 mm FIRM, Cardiopointv	88862811-51
	2-0	3	90	White	36	3 mm × 7 mm FIRM, Cardiopoint™	88862808-51
	2-0	3	90	Blue	36	3 mm × 3 mm FIRM, Cardiopoint™	88863191-51
	2-0	3	10×90	5 Blue and 5 White	6	Pledgets 3 mm × 3 mm FIRM, Cardiopoint™	88863255-56
	2-0	3	90	Blue	36	Pledgets 3 mm × 7 mm FIRM, Cardiopoint™	88863204-51
	2-0	3	90	Blue	36	Cardiopoint™	88863160-51
	2-0	3	10×90	5 Blue and 5 White	6	Cardiopoint™	88862851-56
	Y-16 1/2 Circle 20 mm Double-arm 	2-0	3	6×75	3 Blue and 3 White	6	Pledgets 3 mm × 7 mm FIRM, Cardiopoint™
2-0		3	10×75	5 Blue and 5 White	6	Cardiopoint™	88863241-56
2-0		3	90	Blue	36	Cardiopoint™	88863157-51



PENETRATING TAPER

Needles Specifications	Size		Length cm	Color	Units Per box	Comments	Reorder code
	USP	EP					
Y-5 1/2 Circle 26 mm 	3-0	2	75	Blue	36	Cardiopoint™	88863088-41
	2-0	3	75	Blue	36	Cardiopoint™	88863088-51
Y-5 1/2 Circle 26 mm Double-arm 	4-0	1.5	90	Blue	36	Cardiopoint™	88863167-31
	3-0	2	75	Blue	36	Cardiopoint™	88863088-41
	3-0	2	90	Blue	36	Cardiopoint™	88863167-41
	2-0	3	10×75	5 Blue and 5 White	6	Cardiopoint™	88863222-56
	2-0	3	8×75	4 Blue and 4 White	6	Pledgets 3 mm × 7 mm FIRM, Cardiopoint™	88863213-56
	2-0	3	8×75	4 Blue and 4 White	6	Pledgets 3 mm × 3 mm FIRM, Cardiopoint™	88863203-56
	2-0	3	75	Blue	36	Cardiopoint™	88863202-51
	2-0	3	75	Blue	36	Cardiopoint™	88863088-51
	2-0	3	75	White	36	Cardiopoint™	88862855-51
	2-0	3	10×90	5 Blue and 5 White	6	Pledgets 3 mm × 7 mm FIRM, Cardiopoint™	88863290-56
	2-0	3	90	Blue	36	Pledgets 3 mm × 7 mm FIRM, Cardiopoint™	88863212-51
	2-0	3	90	Blue	36	Cardiopoint™	88863167-51
	2-0	3	90	White	36	Cardiopoint™	88862815-51
	2-0	3	10×90	5 Blue and 5 White	6	Cardiopoint™	88862852-56
	2-0	3	90	White	36	Pledgets 3 mm × 7 mm FIRM, Cardiopoint™	88862840-51
	0	3.5	8×75	4 Blue and 4 White	6	Pledgets 3 mm × 7 mm FIRM, Cardiopoint™	88863213-66
	0	3.5	75	Blue	36	Cardiopoint™	88863202-61
	0	3.5	90	Blue	36	Cardiopoint™	88863167-61





TAPERCUTTING

Needles Specifications	Size		Length cm	Color	Units Per box	Comments	Reorder code	
	USP	EP						
KV-15 3/8 Circle 17 mm Double-arm 	2-0	3	4×75	Blue	6	Surgalloy™	88863131-56	
KV-26 3/8 Circle 26 mm Double-arm 	2-0	3	10×90	5 Blue and 5 White	6	Pledgets 3 mm × 7 mm FIRM	88863275-56	
KV-5 1/2 Circle 17 mm Double-arm 	4-0	1.5	90	Blue	36	Surgalloy™	88863159-31	
		3-0	2	90	Blue	36	Surgalloy™	88863159-41
		2-0	3	8×75	4 Blue and 4 White	6	Pledgets 3 mm × 3 mm FIRM Pledgets	88863236-56
		2-0	3	8×75	4 Blue and 4 White	6	Pledgets 3 mm × 7 mm FIRM	88863235-56
		2-0	3	10×75	5 Blue and 5 White	6	Surgalloy™	88862879-56
		2-0	3	90	Blue	36	Surgalloy™	88863159-51
		2-0	3	90	Blue	36	Pledgets 3 mm × 3 mm FIRM	88863193-51
KV-7 1/2 Circle 26 mm Double-arm 	2-0	3	75	Blue	36	Surgalloy™	88863319-51	
		3	8×75	4 Blue and 4 White	6	Pledgets 3 mm × 7 mm FIRM	88863240-56	
		3	10×75	5 Blue and 5 White	6	Pledgets 3 mm × 7 mm FIRM	88863228-56	
		3	90	Blue	36	Pledgets 3 mm × 7 mm FIRM	88863239-51	
		3	90	Blue	36	Surgalloy™	88863168-51	
KV-34 1/2 Circle 37 mm 	0	3.5	75	Blue	36		88863119-61	

TAPERCUTTING

Needles Specifications	Size		Length cm	Color	Units Per box	Comments	Reorder code
	USP	EP					
KV-37 1/2 Circle 40 mm 	0	3.5	75	Blue	36		88863092-61
	1	4	75	Blue	36		88863092-71
	2	5	5×75	Blue	12		88863147-83
	5	7	5×75	Blue	12		88863147-89
KV-40 1/2 Circle 48 mm 	5	7	4×75	Blue	12		88862818-89

STRAIGHT

Needles Specifications	Image	Size		Length cm	Color	Units Per box	Comments	Reorder code
		USP	EP					
SS-24 1/4 Circle 8.6 mm Double-arm Curvature 95°		5-0	1	45	White	12	Surgalloy™	D-1764K
		4-0	1.5	45	White	12	Surgalloy™	D-1763K
SS-14 1/4 Circle 8.6 mm Double-arm Curvature 115°		6-0	0.7	45	White	12	Surgalloy™	D-1722K
		5-0	1	45	White	12	Surgalloy™	D-1760K
SS-28 3/8 Circle 7.4 mm Double-arm Curvature 145°		6-0	0.7	45	White	12	Surgalloy™	D-1683K
SS-2 1/2 Circle 8.6 mm Double-arm Curvature 200°		5-0	1	45	White	12	Surgalloy™	D-1780K
		4-0	1.5	45	White	12	Surgalloy™	D-1779K

PLEDGETS

Non-Absorbable, undyed fabrics constructed of PTFE

Simple strength. Secure placement.



Compared to rectangular pledgets:



Oval pledgets conform better to the shape of the anatomical structure and result in less foreign mass in the body²



The lack of corners prevents the oval pledget from catching the wrong orientation and the edges are less likely to overlap²



Soft oval pledgets are compliant, yet not fuzzy²

Description	PTFE Pledgets are non-absorbable, undyed fabrics composed of poly (tetrafluoroethylene).
Indications	PTFE Pledgets are indicated for use as non-absorbable suture buttresses when there is a possibility of sutures tearing through tissue. These pledgets are used in various surgical procedures such as vascular closure, septal repair, myocardial closure, valvular suturing and hepatic repair.
Actions	PTFE Pledgets elicit a minimal acute inflammatory reaction in tissues, followed by gradual encapsulation of the fabric by fibrous connective tissue.
Absorption	PTFE Pledgets are not absorbed, nor is any significant change in tensile strength retention known to occur in vivo.
Packaging	PTFE Pledgets are available sterile, prepunched, square , rectangular or oval in shape and in box quantities of 3 dozen.

PLEDGETS

Our broad range of pledgets are offered as free (bulk) and on sutures.

New Oval Pledget Codes available

size usp	length cm	color	Needle	Needle Point	Needle curvature	Needle length	Pledget	comments	reorder code
2-0	8x75	blue and white	CV-331	Taper Point	1/2 circle	16mm	3 × 6 Firm	Oval Pledgets	VCD20331FE
2-0	8x75	blue and white	Y-31	Penetrating Taper	1/2 circle	16mm	3 × 6 Firm	Oval Pledgets	VCD2031MFE
2-0	8x75	blue and white	Y-31	Penetrating Taper	1/2 circle	16mm	3 × 6 Soft	Oval Pledgets	VCD2031MSE
2-0	8x75	blue and white	CV-316	Taper Point	1/2 circle	20mm	3 × 6 Firm	Oval Pledgets	VCD20316MFE
2-0	8x75	blue and white	CV-316	Taper Point	1/2 circle	20mm	3 × 6 Soft	Oval Pledgets	VCD20316MSE
2-0	75	blue	CV-316	Taper Point	1/2 circle	20mm	3 × 6 Firm	Oval Pledgets	VCD20316FE
2-0	75	blue	CV-316	Taper Point	1/2 circle	20mm	3 × 6 Soft	Oval Pledgets	VCD20316SE
2-0	8x75	blue and white	CV-305	Taper Point	1/2 circle	25mm	3 × 6 Firm	Oval Pledgets	VCD20305MFE
2-0	8x75	blue and white	CV-305	Taper Point	1/2 circle	25mm	3 × 6 Soft	Oval Pledgets	VCD20305MSE
2-0	75	blue	CV-305	Taper Point	1/2 circle	25mm	3 × 6 Firm	Oval Pledgets	VCD20305FE
2-0	75	blue	CV-305	Taper Point	1/2 circle	25mm	3 × 6 Soft	Oval Pledgets	VCD20305SE
2-0	8x75	blue	CV-305	Taper Point	1/2 circle	25mm	4.5 × 6 Firm	Oval Pledgets	VCD2030556MFE
2-0	8x75	blue	CV-305	Taper Point	1/2 circle	25mm	4.5 × 6 Soft	Oval Pledgets	VCD2030556MSE
2-0	8x90	blue	CV-305	Taper Point	1/2 circle	25mm	3 × 6 Firm	Oval Pledgets	VCD2036305FE

Free Pledgets

Units per pack	Pledgets in mm and texture	Shape	Order code
10	3 × 6 Firm	Oval	VPG36FE
10	3 × 6 Soft	Oval	VPG36SE
10	4.5 × 6 Firm	Oval	VPG56FE
10	4.5 × 6 Soft	Oval	VPG56SE
10	3 × 3 Firm	Square	88868675-01
10	3 × 7 Firm	Rectangular	88868677-01
10	3 × 7 Soft	Rectangular	88868682-01
5	9.5 × 4.8 Firm	Rectangular	88868678-01
5	9.5 × 4.8 Soft	Rectangular	88868679-01

VASCUFIL™







Coated Monofilament Polybutester

Innovation in Cardiovascular Surgery.

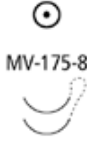

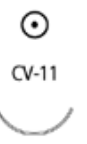

Please refer to the individual package IFUs for complete instructions, indications, contraindications, warnings and precautions.

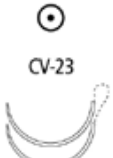

Description	Vascufil™ monofilament polybutester sutures are nonabsorbable, sterile, surgical sutures composed of a copolymer of butylene terephthalate and polytetramethylene ether glycol. The suture is coated with Polytribolate™, an absorbable polymer of e-caprolactone / glycolide / poloxamer 188.
Indications	Vascufil™ polybutester sutures are indicated for use in general soft tissue approximation and/or ligation.
Actions	Vascufil™ sutures elicit a minimal acute inflammatory reaction in tissues, which is followed by gradual encapsulation of the suture by fibrous connective tissue.
Tensile Strength	Vascufil™ sutures are not absorbed, nor is any significant change in strength retention known to occur in vivo. Excretion of the absorbable coating is essentially complete within thirty days.
Sterilization	Gamma irradiation.
Packaging	Vascufil™ monofilament sutures are available dyed with Copper Phthalocyanine Blue in U.S.P. sizes 2–0 (3 Metric) through 7–0 (0.5 Metric). The sutures are supplied sterile, in pre-cut lengths affixed to various needle types, using permanent needle attachment techniques. Please refer to the individual package IFUs for complete instructions, indications, contraindications, warnings and precautions.

TAPER POINT								
Needles Specifications	Size	USP	EP	Length cm	Color	Units Per box	Comments	Reorder code
MV-175-8 3/8 Circle 8 mm Double-arm		5-0	1	75	Blue	36	Surgalloy™	88864741-21V
		7-0	0.5	4×60	Blue	12	Surgalloy™	88864788-05V
		7-0	0.7	2×60	Blue	12	Surgalloy™	88864795-06V
CV-1 3/8 Circle 9 mm Double-arm		7-0	0.5	45	Blue	36	Surgalloy™	88864703-01V
		7-0	0.5	60	Blue	36	Surgalloy™	88864705-01V
		7-0	0.5	4×60	Blue	12	Surgalloy™	88864702-05V
		7-0	0.5	75	Blue	36	Surgalloy™	88864704-01V
		7-0	0.5	4×75	Blue	12	Surgalloy™	88864701-05V
		6-0	0.7	45	Blue	36	Surgalloy™	88864703-11V
		6-0	0.7	60	Blue	36	Surgalloy™	88864705-11V
		6-0	0.7	75	Blue	36	Surgalloy™	88864704-11V
CV 3/8 Circle 11 mm Double-arm		6-0	0.7	75	Blue	36	Surgalloy™	88864756-11V
CV-11 3/8 Circle 13 mm		5-0	1	75	Blue	36	Surgalloy™	88864722-21V
CV-11 3/8 Circle 13 mm Double-arm		6-0	0.7	45	Blue	36	Surgalloy™	88864707-11V
		6-0	0.7	60	Blue	36	Surgalloy™	88864709-11V
		6-0	0.7	75	Blue	36	Surgalloy™	88864710-11V
		5-0	1	60	Blue	36	Surgalloy™	88864709-21V
		5-0	1	75	Blue	36	Surgalloy™	88864710-21V
		5-0	1	90	Blue	36	Surgalloy™	88864711-21V
CV-15 3/8 Circle 17 mm		5-0	1	75	Blue	36	Surgalloy™	88864739-21V
		4-0	1.5	75	Blue	36	Surgalloy™	88864739-31V
CV-15 3/8 Circle 17 mm Double-arm		5-0	1	90	Blue	36	Surgalloy™	88864716-21V
		4-0	1.5	90	Blue	36	Surgalloy™	88864716-31V

TAPER POINT

Needles Specifications	Size USP	EP	Length cm	Color	Units Per box	Comments	Reorder code	
CV-22 1/2 Circle 13 mm Double-arm		6-0	0.7	4×75	Blue	12	Surgalloy™	88864742-15V
		6-0	0.7	75	Blue	36	Surgalloy™	88864741-11V
		7-0	0.5	4×60	Blue	36	Surgalloy™	88864794-01V
CV-23 1/2 Circle 17 mm Double-arm		5-0	1	90	Blue	36	Surgalloy™	88864719-21V
		4-0	1.5	90	Blue	36	Surgalloy™	88864719-31V
V-20 1/2 Circle 26 mm Double-arm		2-0	3	90	Blue	36	Surgalloy™	88864750-51V
		3-0	2	90	Blue	36	Surgalloy™	88864750-41V
		4-0	1.5	90	Blue	36	Surgalloy™	88864750-31V

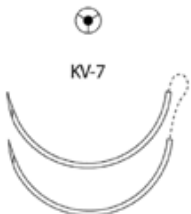
TAPERCUTTING

Needles Specifications	Size USP	EP	Length cm	Color	Units Per box	Comments	Reorder code	
KV-7 1/2 Circle 26 mm		2-0	3	90	Blue	36	Surgalloy™	88864730-51V
KV-7 1/2 Circle 26 mm Double-arm		4-0	1.5	90	Blue	36	Surgalloy™	88864731-31V
KV-7 1/2 Circle 26 mm Double-arm		3-0	2	90	Blue	36	Surgalloy™	88864731-41V
		2-0	3	90	Blue	36	Surgalloy™	88864731-51V
KV-11 3/8 Circle 13 mm Double-arm		6-0	0.7	75	Blue	36	Surgalloy™	88864734-11V
		5-0	1	75	Blue	36	Surgalloy™	88864734-21V
KV-1 3/8 Circle 9 mm Double-arm		6-0	0.7	60	Blue	36	Surgalloy™	88864714-11V

FLEXON™

Multifilament Temporary Cardiac Pacing Lead

Excellent Stability with Great Flexibility.



Please refer to the individual package IFUs for complete instructions, indications, contraindications, warnings and precautions.

Description	Flexon™ temporary cardiac pacing lead is a stainless steel twisted, multistrand wire coated with orange or white PTFE poly (tetrafluoroproethylene) or clear FEP poly (tetrafluoroethylene-co- hexafluoropropylene).
Indications	Flexon™ temporary cardiac pacing lead is indicated for use in temporary atrial and ventricular pacing and sensing during and after cardiac surgery.
Actions	Flexon™ temporary cardiac pacing lead elicits minimal acute inflammatory reaction in tissues and is not absorbed.
Tensile Strength	Permanent.
Sterilization	Ethylene oxide.
Packaging	Flexon™ temporary cardiac pacing lead are available coated with orange or white PTFE or clear FEP in size 0 (3.5 metric), size 2-0 (3 metric) and 3-0 (2 metric). Flexon™ temporary cardiac pacing lead is supplied sterile affixed to various types of needles, including Breakaway™ needles.

TAPER POINT

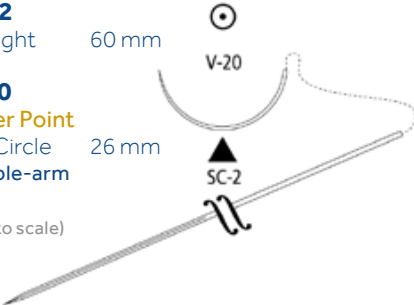
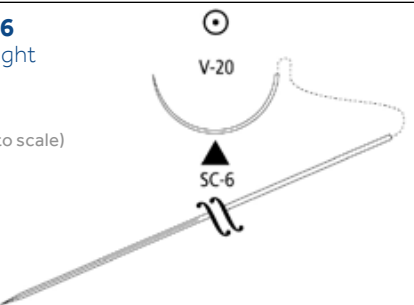
Needles Specifications	Size		Length cm	Color	Units Per box	Comments	Reorder code
	USP	EP					
<p>SC-2 Straight 60 mm</p> <p>V-20 Taper Point 1/2 Circle 26 mm Double-arm</p> <p>(Not to scale)</p> 	0	3.5	60	Undyed	12		88862597-63
<p>SC-6 Straight</p> <p>(Not to scale)</p> 	2-0	3	2 × 60	1 Orange 1 White	12		88862623-53
	2-0	3	60	Orange	12		88862617-53
	2-0	3	60	White	12		88862615-53
	0	3.5	60	Undyed	12		88862589-63

TAPER POINT

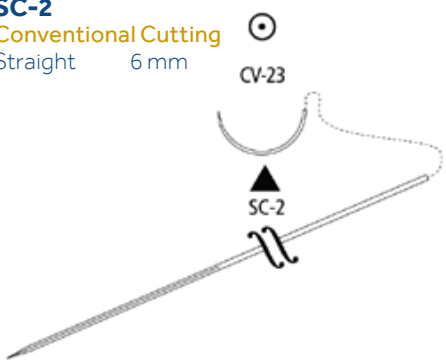
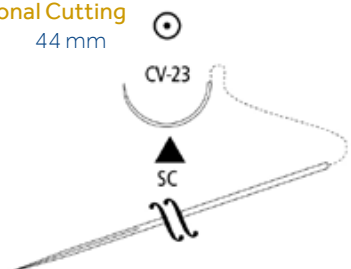
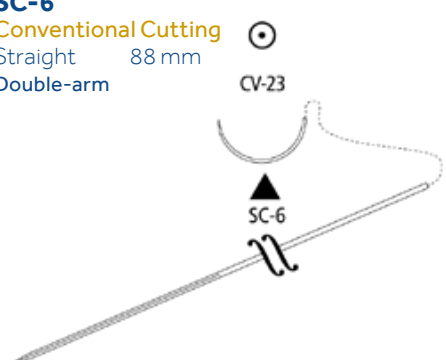
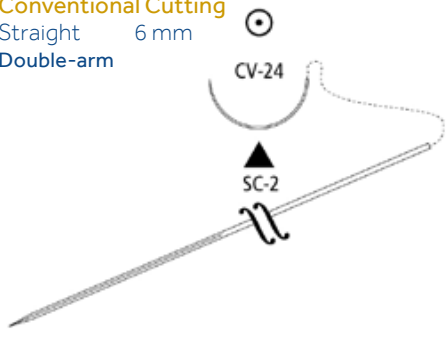
Needles Specifications	Size		Length cm	Color	Units Per box	Comments	Reorder code
	USP	EP					
CV-23 1/2 Circle 17 mm SC-2 Conventional Cutting Straight 6 mm 	3-0	2	60	Undyed	12	FEP Coating	88862592-43
SC Conventional Cutting Straight 44 mm 		2	60	Undyed	12	FEP Coating	88862591-43
SC-6 Conventional Cutting Straight 88 mm Double-arm 		2	60	Undyed	12	Breakaway™ FEP Coating	88862586-43
CV-24 1/2 Circle 20 mm SC-2 Conventional Cutting Straight 6 mm Double-arm 		3.5	60	Undyed	12	FEP Coating	88862593-63

STEEL

Monofilament Stainless Steel

Providing Maximum Tensile Strength.



Please refer to the individual package IFUs for complete instructions, indications, contraindications, warnings and precautions.



Description	Stainless monofilament steel sutures are composed of 316L stainless steel conforming to ASTM Standard F138 Grade 2 "Stainless steel bar and wire for surgical implants."
Indications	Steel sutures are indicated for use in abdominal wound closure, hernia repair and sternal closure.
Actions	Steel sutures elicit a minimal acute inflammatory reaction in tissue, and are not absorbed.
Tensile Strength	Permanent.
Sterilization	Ethylene oxide or gamma irradiation.
Packaging	Steel sutures are available in monofilament strands in size 1 (4 Metric), size 2 (6 metric), size 4 (6 metric) through 7 (9 Metric). The sutures are supplied sterile, in pre-cut lengths affixed to various types of needles using permanent needle attachment technique.

Steel

PRE-CUT

Needles Specifications	Size		Length cm	Color	Units Per box	Comments	Reorder code
	USP	EP					
	2-0	3	12 × 45	Undyed	12	Pre-cut	88862407-53
	0	3.5	12 × 45	Undyed	12	Pre-cut	88862407-63
	1	4	6 × 45	Undyed	12	Pre-cut	88862408-73
	2	5	6 × 45	Undyed	12	Pre-cut	88862408-83
	3-0	2	12 × 45	Undyed	12	Pre-cut	88862407-43
	7	9	12 × 45	Undyed	12	Pre-cut	88862408-73

REVERSE CUTTING

Needles Specifications	Size		Length cm	Color	Units Per box	Comments	Reorder code
	USP	EP					
GS-12 1/2 Circle 40 mm 	2	5	5 × 45	Undyed	12		88862413-83
GS-13 ROTO 1/2 Circle 48 mm 	2	5	2 × 45	Undyed	12	ROTOGRIP™	88862420-83
	4	6	2 × 45	Undyed	12	ROTOGRIP™	88862420-09
HOS-14 1/2 Circle 55 mm 	5	7	4 × 45	Undyed	12	ROTOGRIP™	88862410-89
	5	7	2 × 75	Undyed	12	ROTOGRIP™	88862424-89
	5	7	75	Undyed	12	ROTOGRIP™	88862412-89
	6	8	4 × 45	Undyed	12	ROTOGRIP™	88862410-69

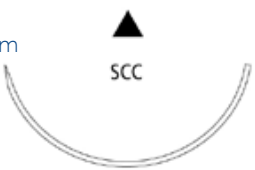
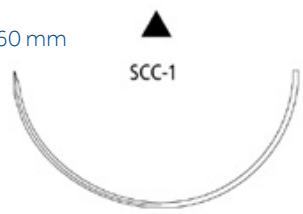

CONVENTIONAL CUTTING

Needles Specifications	Size		Length cm	Color	Units Per box	Comments	Reorder code
	USP	EP					
SCC 1/2 Circle 48 mm 	5	7	4 × 45	Undyed	12		88862224-89
	5	7	2 × 45	Undyed	12		88862222-89
	5	7	6 × 45	Undyed	12		88862226-89
	6	8	4 × 45	Undyed	12		88862224-69
	6	8	6 × 45	Undyed	12		88862226-69
	6	8	2 × 45	Undyed	12		88862222-69
	7	9	4 × 45	Undyed	12		88862224-49
SCC-1 1/2 Circle 60 mm 	5	7	2 × 75	Undyed	12		88862228-89

TAPER POINT

Needles Specifications	Size		Length cm	Color	Units Per box	Comments	Reorder code
	USP	EP					
GS-21 1/2 Circle 37 mm 	2-0	3	5 × 45	Undyed	12		88862345-53
GS-25 1/2 Circle 48 mm 	2-0	3	5 × 60	Undyed	12		88862348-53



TAPERCUTTING

Needles Specifications	Size		Length cm	Color	Units Per box	Comments	Reorder code
	USP	EP					
KV-37 1/2 Circle 40 mm 	2	5	5 × 45	Undyed	12		88862382-83
KV-40 1/2 Circle 48 mm  (Not to scale)	3	6	5 × 45	Undyed	12		88862466-25
	5	7	4 × 45	Undyed	12		88862414-89
	5	7	4 × 45	Undyed	12	ROTOGRIP	88862393-89
	5	7	2 × 45	Undyed	12		88862376-89
	6	8	2 × 45	Undyed	12		88862392-69
	6	8	4 × 45	Undyed	12		88862393-69
	7	9	2 × 45	Undyed	12		88862392-49

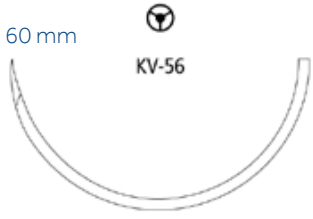
TAPERCUTTING

Needles Specifications	Size		Length cm	Color	Units Per box	Comments	Reorder code
	USP	EP					
KV-56 1/2 Circle 60 mm 	5	7	5 × 75	Undyed	12		88862396-89

BLUNT TAPER POINT

Needles Specifications	Size		Length cm	Color	Units Per box	Comments	Reorder code
	USP	EP					
BGS-26 1/2 Circle 44 mm  (Not to scale)	5	7	75	Undyed	12	ProtectPoint™	88862497-89
BGS-29 1/2 Circle 63 mm 	5	7	5 × 45	Undyed	12	ProtectPoint™	88862495-89

BLUNT POINT

Needles Specifications	Size		Length cm	Color	Units Per box	Comments	Reorder code
	USP	EP					
BP-27 1/2 Circle 64 mm 	5	7	2 × 75	None	12	ProtectPoint™	88862494-89

DERMALON™ / MONOSOF™

Monofilament Nylon

High Tensile Strength. Low tissue Reactivity.



Please refer to the individual package IFUs for complete instructions, indications, contraindications, warnings and precautions.

Description	DERMALON™ and MONOSOF™ monofilament sutures are inert, nonabsorbable, sterile surgical sutures composed of the longchain aliphatic polymers Nylon 6 and Nylon 6.6.
Indications	DERMALON™ and MONOSOF™ monofilament nylon sutures are indicated for use in general soft tissue approximation and/or ligation, including use in cardiovascular, ophthalmic, and neurological surgery.
Actions	Both DERMALON™ and MONOSOF™ monofilament nylon sutures elicit a minimal acute inflammatory reaction in tissue, which is followed by gradual encapsulation of the suture by fibrous connective tissue.
Tensile Strength	As with any nylon suture, though not absorbed, progressive hydrolysis of the suture, in vivo, may result in gradual loss of its tensile strength over time.
Sterilization	DERMALON™ and MONOSOF™ monofilament nylon sutures are sterilized by ethylene oxide or gamma irradiation.
Packaging	DERMALON™ monofilament nylon sutures are available dyed blue with FD&C Blue No. 2 in sizes 2-0 (3 Metric) through 6-0 (0.7 metric). MONOSOF™ monofilament nylon sutures are available either clear (undyed) or dyed black with Logwood extract, in sizes 2 (5 Metric) through 11-0 (0.1 Metric). Both sutures are supplied sterile, in pre-cut lengths affixed to needles using permanent needle attachment techniques.



Dermalon™ / Monosof™

Dermalon™ / Monosof™ suture is a brand you have trusted for ~ 50 years with a proven history of performance.



PRE-CUT							
Needles Specifications	Size		Length cm	Color	Units Per box	Comments	Reorder code
	USP	EP					
	3-0	2	12×45	Black	36	Pre-cut	N-63
	2-0	3	6×45	Black	36	Pre-cut	N-59
	2	5	6×45	Black	36	Pre-cut	N-64

REVERSE CUTTING							
Needles Specifications	Size		Length cm	Color	Units Per box	Comments	Reorder code
	USP	EP					
C-1 3/8 Circle 12 mm 	6-0	0.7	25	Black	12		SN-770G
	6-0	0.7	45	Black	12		SN-667G
	6-0	0.7	45	Black	36		SN-667
	6-0	0.7	45	Blue	36		88861741-11
	6-0	0.7	75	Black	36		SN-367
	5-0	1	25	Black	12		SN-771G
	5-0	1	45	Black	36		SN-871
	5-0	1	45	Blue	36		88861741-21
	5-0	1	75	Black	36		SN-368
	4-0	1.5	25	Black	12		SN-772G
	4-0	1.5	45	Black	36		SN-872
	4-0	1.5	45	Blue	36		88861741-31

REVERSE CUTTING

Needles Specifications	Size		Length cm	Color	Units Per box	Comments	Reorder code
	USP	EP					
C-12 3/8 Circle 16 mm 	6-0	0.7	45	Blue	36		88861747-11
	6-0	0.7	45	Black	36		SN-660
	6-0	0.7	75	Black	36		SN-760
	5-0	1	45	Black	36		SN-659
	5-0	1	45	Black	12		SN-659G
	5-0	1	75	Black	36		SN-761
	4-0	1.5	75	Black	36		SN-762
	3-0	2	75	Black	36		SN-763
C-13 3/8 Circle 19 mm 	6-0	0.7	45	Blue	36		88861756-11
	5-0	1	45	Blue	36		88861756-21
	5-0	1	45	Black	12		SN-661G
	5-0	1	45	Black	36		SN-661
	5-0	1	75	Black	36		SN-643
	4-0	1.5	25	Black	12		SN-552G
	4-0	1.5	45	Black	12		SN-662G
	4-0	1.5	45	Black	36		SN-662
	4-0	1.5	45	Blue	36		88861756-31
	4-0	1.5	75	Blue	36		88861757-31
	4-0	1.5	90	Black	36		SN-644
	3-0	2	45	Black	36		SN-653
	3-0	2	45	Blue	36		88861756-41
	3-0	2	75	Black	36		SN-641
	3-0	2	75	Blue	36		88861757-41
	3-0	2	90	Black	36		SN-665
	2-0	3	45	Blue	36		88861756-51
	2-0	3	75	Black	36		SN-750
	2-0	3	90	Black	36		SN-666





REVERSE CUTTING

Needles Specifications	Size		Length cm	Color	Units Per box	Comments	Reorder code
	USP	EP					
C-14 3/8 Circle 24 mm 	4-0	1.5	45	Black	36		SN-658
	4-0	1.5	45	Blue	36		88861744-31
	4-0	1.5	75	Blue	36		88861799-31
	4-0	1.5	90	Black	36		SN-649
	3-0	2	45	Black	12		SN-663G
	3-0	2	45	Black	36		SN-663
	3-0	2	45	Blue	36		88861744-41
	3-0	2	75	Blue	36		88861799-41
	3-0	2	75	Black	36		SN-669
	3-0	2	90	Black	36		SN-648
	2-0	3	45	Black	36		SN-758
	2-0	3	75	Blue	36		88861799-51
	2-0	3	90	Black	36		SN-747
C-15 3/8 Circle 26 mm 	2-0	3	45	Black	12		SN-764G
	2-0	3	45	Black	36		SN-764
	2-0	3	45	Blue	36		88861744-51
	2-0	3	75	Black	12		SN-664G
	2-0	3	75	Black	36		SN-664
	2-0	3	90	Blue	36		88861720-51
	0	3.5	75	Black	36		SN-765
C-16 3/8 Circle 30 mm 	4-0	1.5	75	Black	36		SN-670
	3-0	2	75	Blue	36		88861750-41
	3-0	2	75	Black	12		SN-671G
	3-0	2	75	Black	36		SN-671
	3-0	2	90	Black	36		SN-771
	2-0	3	75	Black	36		SN-688
	2-0	3	90	Black	36		SN-788
	0	3.5	75	Black	36		SN-689
	1	4	90	Black	36		SN-790





REVERSE CUTTING

Needles Specifications	Size		Length cm	Color	Units Per box	Comments	Reorder code
	USP	EP					
C-18 3/8 Circle 35 mm 	3-0	2	90	Black	36		SN-693
	2-0	3	90	Black	36		SN-694
C-17 3/8 Circle 39 mm 	4-0	1.5	75	Black	36		SN-672
	3-0	2	75	Black	12		SN-673G
	3-0	2	75	Black	36		SN-673
	3-0	2	75	Blue	36		88861727-41
	2-0	3	75	Blue	36		88861727-51
	2-0	3	75	Black	36		SN-674
	0	3.5	90	Black	36		SN-775
	1	4	90	Black	36		SN-776
	2	5	90	Black	36		SN-777
GS-18 3/8 Circle 77 mm 	2	5	45	Black	24	With bolster and weight	CN-290
GS-18 3/8 Circle 77 mm Double-arm 	2	5	75	Black	24		CN-490

REVERSE CUTTING

Needles Specifications	Size USP	EP	Length cm	Color	Units Per box	Comments	Reorder code
C-22 1/2 Circle 18 mm 	5-0	1	75	Black	36		SN-629
	4-0	1.5	75	Black	36		SN-630
	3-0	2	75	Black	36		SN-631
C-23 1/2 Circle 24 mm 	3-0	2	90	Black	36		SN-247
C-25 1/2 Circle 30 mm 	3-0	2	75	Black	36		SN-681
	3-0	2	90	Black	36		SN-781
	2-0	3	75	Black	36		SN-682
	2-0	3	90	Black	36		SN-782
GS-11 1/2 Circle 37 mm 	3-0	2	90	Black	36		SN-881
	2-0	3	75	Black	36		CN-819
	1	4	90	Black	36		CN-822



PREMIUM REVERSE CUTTING

Needles Specifications	Size USP	EP	Length cm	Color	Units Per box	Comments	Reorder code
P-16 3/8 Circle 7 mm 	7-0	0.5	45	Black	12		SN-1647G
	7-0	0.5	45	Black	36		SN-1647
P-10 3/8 Circle 11 mm 	7-0	0.5	45	Black	12	Surgalloy™	SN-3686
	6-0	0.7	45	Black	12	Surgalloy™	SN-3697
	6-0	0.7	45	Clear	12	Surgalloy™	SN-1689G
	6-0	0.7	45	Black	36	Surgalloy™	SN-5697
	6-0	0.7	45	Clear	36	Surgalloy™	SN-1689
	6-0	0.7	45	Blue	12		88861754-13
	5-0	1	45	Black	12	Surgalloy™	SN-3695
P-13 3/8 Circle 13 mm 	6-0	0.7	45	Black	36	Surgalloy™	SN-5696
	6-0	0.7	45	Black	12	Surgalloy™	SN-5696G
	6-0	0.7	45	Blue	12	Surgalloy™	SDN-5696G
	5-0	1	45	Black	12	Surgalloy™	SN-5698G
	5-0	1	45	Clear	12	Surgalloy™	SN-5690G
	5-0	1	45	Black	36	Surgalloy™	SN-5698
	5-0	1	45	Clear	36	Surgalloy™	SN-5690
	5-0	1	45	Blue	12	Surgalloy™	88861749-24
	4-0	1.5	45	Black	12	Surgalloy™	SN-5699G
	4-0	1.5	45	Black	36	Surgalloy™	SN-5699
	4-0	1.5	45	Clear	36	Surgalloy™	SN-5691
	4-0	1.5	45	Blue	12	Surgalloy™	SDN-5691G
P-11 3/8 Circle 16 mm 	6-0	0.7	45	Black	12	Surgalloy™	SN-5767G
	5-0	1	45	Black	12	Surgalloy™	SN-5668G
	5-0	1	45	Black	36	Surgalloy™	SN-5668
	4-0	1.5	45	Black	12	Surgalloy™	SN-5694G
	4-0	1.5	45	Black	36	Surgalloy™	SN-5694

PREMIUM REVERSE CUTTING

Needles Specifications	Size		Length cm	Color	Units Per box	Comments	Reorder code
	USP	EP					
P-12 3/8 Circle 19 mm 	6-0	0.7	45	Black	12	Surgalloy™	SN-5665G
	5-0	1	45	Black	12	Surgalloy™	SN-5666G
	5-0	1	45	Black	36	Surgalloy™	SN-5666
	4-0	1.5	45	Clear	12	Surgalloy™	SN-5677
	4-0	1.5	45	Black	12	Surgalloy™	SN-5667G
	4-0	1.5	45	Black	36	Surgalloy™	SN-5667
	4-0	1.5	45	Blue	12	Surgalloy™	SDN-5666G
	3-0	2	45	Black	12	Surgalloy™	SN-5669G
	3-0	2	45	Black	36	Surgalloy™	SN-5669
	2-0	3	45	Black	36	Surgalloy™	SN-5670



PREMIUM REVERSE CUTTING

Needles Specifications	Size		Length cm	Color	Units Per box	Comments	Reorder code
	USP	EP					
P-14 3/8 Circle 24 mm 	4-0	1.5	45	Black	12	Surgalloy™	SN-5862G
	3-0	2	45	Black	12	Surgalloy™	SN-5663G
	3-0	2	45	Black	36	Surgalloy™	SN-5663
	3-0	2	45	Blue	12	Surgalloy™	SDN-5943G
P-24 1/2 Circle 16 mm 	6-0	0.7	45	Black	12	Surgalloy™	SN-5660G
	4-0	1.5	45	Black	12	Surgalloy™	SN-5662G
	4-0	1.5	45	Black	36	Surgalloy™	SN-5662















CONVENTIONAL CUTTING

Needles Specifications	Size USP	EP	Length cm	Color	Units Per box	Comments	Reorder code
PC-13 3/8 Circle 11 mm 	6-0	0.7	45	Black	36		SN-1956
	5-0	1	45	Black	36		SN-1955
	4-0	1.5	45	Black	36		SN-1954
PC-11 3/8 Circle 16 mm 	6-0	0.7	45	Black	36		SN-1966
	5-0	1	45	Black	12	Surgalloy™	SN-3965
	4-0	1.5	45	Black	36		SN-1964
PC-12 3/8 Circle 19 mm 	5-0	1	45	Black	36		SN-1995
	4-0	1.5	45	Black	36		SN-1994
	3-0	2	45	Black	36		SN-1693
SCE-4 3/8 Circle 19 mm 	5-0	1	45	Blue	36		88861742-21
	4-0	1.5	45	Blue	36		88861742-31
	4-0	1.5	45	Black	36		SN-568
	3-0	2	45	Blue	36		88861742-41
GCC-90 3/8 Circle 90 mm 	2-0	3	100	Black	36		CN-791
	0	3.5	100	Black	36		CN-792
	1	4	100	Black	36		CN-793

CONVENTIONAL CUTTING

Needles Specifications		Size		Length cm	Color	Units Per box	Comments	Reorder code
		USP	EP					
SC-1 Straight 51 mm 		4-0	1.5	90	Black	36		SN-615
		3-0	2	90	Black	36		SN-616
		2-0	3	90	Black	36		SN-617
SC-2 Straight 60 mm 		3-0	2	75	Black	36		SN-627
		3-0	2	75	Blue	36		88861764-41
		2-0	3	75	Black	36		SN-628
		2-0	3	75	Blue	36		88861764-51
		2-0	3	100	Black	36		SN-728



TAPER POINT

Needles Specifications	Size USP	EP	Length cm	Color	Units Per box	Comments	Reorder code
MV-50-3 3/8 Circle 4 mm  MV-50-3 	11-0	0.1	13	Black	12	Surgalloy™	N-2500
MV-70-3 3/8 Circle 4 mm  MV-70-3 	11-0	0.1	13	Black	12	Surgalloy™	N-2510
	10-0	0.2	13	Black	12	Surgalloy™	N-2512
MV-135-3 3/8 Circle 4 mm  MV-135-3 	10-0	0.2	13	Black	12	Surgalloy™	N-2540
	9-0	0.3	8	Black	12	Surgalloy™	N-1603G
	8-0	0.4	13	Black	12	Surgalloy™	N-2541
MV-70-4 3/8 Circle 5 mm  MV-70-4 	10-0	0.2	13	Black	12	Surgalloy™	N-2514
MV-100-4 3/8 Circle 5 mm  MV-100-4 	10-0	0.2	13	Black	12	Surgalloy™	N-2530
	9-0	0.3	13	Black	12	Surgalloy™	N-2532
MV-135-4 3/8 Circle 5 mm  MV-135-4 	10-0	0.2	13	Black	12	Surgalloy™	N-2544
	9-0	0.3	13	Black	12	Surgalloy™	N-2546
	8-0	0.4	13	Black	12	Surgalloy™	N-2543
MV-135-5 3/8 Circle 6 mm  MV-135-5 	9-0	0.3	13	Black	12	Surgalloy™	N-2548
	8-0	0.4	13	Black	12	Surgalloy™	N-2547

TAPER POINT

Needles Specifications	Size		Length cm	Color	Units Per box	Comments	Reorder code
	USP	EP					
GS-22 1/2 Circle 27 mm 	0	3.5	100	Black	36		CN-225
GS-24 1/2 Circle 40 mm 	0	3.5	100	Black	36		CN-723
	1	4	100	Black	36		CN-722
GS-24 LOOP 1/2 Circle 40 mm 	0	3.5	150	Black	24	Loop	CN-825-L



TAPER POINT

Needles Specifications	Size		Length cm	Color	Units Per box	Comments	Reorder code
	USP	EP					
GS-25 1/2 Circle 48 mm 	1	4	100	Black	36		CN-724
GS-25 LOOP 1/2 Circle 48 mm 	1	4	150	Black	24	Loop	CN-830-L
GS-26 1/2 Circle 65 mm 	1	4	150	Black	24		CN-824
	2	5	150	Black	24		CN-825
GS-26 LOOP 1/2 Circle 65 mm 	0	3.5	240	Black	24	Loop	CN-823-L
ST Straight 60 mm Double-arm (Not to scale) 	2-0	3	90	Black	36		GN-283
	0	3.5	90	Black	36		GN-284

HEAVY TAPER POINT

Needles Specifications	Size		Length cm	Color	Units Per box	Comments	Reorder code
	USP	EP					
HGS-22 1/2 Circle 27 mm 	0	3.5	100	Black	36		CN-925
	1	4	100	Black	36		CN-926

TAPERCUTTING

Needles Specifications	Size		Length cm	Color	Units Per box	Comments	Reorder code
	USP	EP					
MVK-70-3 3/8 Circle 4 mm 	10-0	0.2	13	Black	12	Surgalloy™	N-2513
MVK-100-4 3/8 Circle 5 mm 	10-0	0.2	13	Black	12	Surgalloy™	N-2531
	9-0	0.3	13	Black	12	Surgalloy™	N-2533

BLUNT POINT

Needles Specifications	Size		Length cm	Color	Units Per box	Comments	Reorder code
	USP	EP					
BGS-25 1/2 Circle 48 mm 	1	4	100	Black	36	ProtectPoint™	CN-771

PREMIUM SPATULA

Needles Specifications	Image	Size		Length cm	Color	Units Per box	Comments	Reorder code
		USP	EP					
SE-100-8 1/4 Circle 6.3 mm Double-arm Curvature 100°		8-0	0.4	30	Black	12	Surgalloy™	N-2714K
SS-24 1/4 Circle 8.6 mm Double-arm Curvature 95°		5-0	1	45	Black	12	Surgalloy™	N-2781K
SE-140-6 3/8 Circle 6.3 mm Curvature 140°		10-0	0.2	20	Black	12	Surgalloy™	N-2730-K
SE-140-6 3/8 Circle 6.3 mm Double-arm Curvature 140°		10-0	0.2	30	Black	12	Surgalloy™	N-2770-K
		9-0	0.3	30	Black	12	Surgalloy™	N-2771-K
SE-140-8 3/8 Circle 6.3 mm Curvature 140°		10-0	0.2	20	Black	12	Surgalloy™	N-2736K
SE-140-8 3/8 Circle 6.3 mm Double-arm Curvature 140°		10-0	0.2	30	Black	12	Surgalloy™	N-2718K
		9-0	0.3	30	Black	12	Surgalloy™	N-2717-K
SE-CC-6 Compound curve 4.8 mm Double-arm Curvature 130°		10-0	0.2	30	Black	12	Surgalloy™	N-2799-K
SE-160-4 1/2 Circle 5.5 mm Double-arm Curvature 160°		11-0	0.1	30	Black	12	Surgalloy™	N-2705K
		10-0	0.2	30	Black	12	Surgalloy™	N-2704K

SPATULA

Needles Specifications		Size		Length cm	Color	Units Per box	Comments	Reorder code
		USP	EP					
SE-160-6 1/2 Circle 5.5 mm Curvature 160°	 SE-160-6 	10-0	0.2	20	Black	12	Surgalloy™	N-2734K
SE-160-6 1/2 Circle 5.5 mm Double-arm Curvature 160°	 SE-160-6  	10-0	0.2	15	Black	12	Surgalloy™	N-2757K
		10-0	0.2	30	Black	12	Surgalloy™	N-2756K
		9-0	0.3	30	Black	12	Surgalloy™	N-2760K
SE-160-8 1/2 Circle 5.5 mm Curvature 160°	 SE-160-8 	10-0	0.2	15	Black	12	Surgalloy™	N-2766K
SE-160-8 1/2 Circle 5.5 mm Double-arm Curvature 160°	 SE-160-8  	10-0	0.2	30	Black	12	Surgalloy™	N-2786K
		9-0	0.3	30	Black	12	Surgalloy™	N-2787K
SE-175-8 1/2 Circle 6.9 mm Double-arm Curvature 175°	 SE-175-8  	10-0	0.2	30	Black	12	Surgalloy™	N-2719K
		8-0	0.4	30	Black	12	Surgalloy™	N-2716K
SE-175-6 1/2 Circle 7 mm Double-arm Curvature 175°	 SE-175-6  	10-0	0.2	30	Black	12		N-2966K
		9-0	0.3	30	Black	12	Surgalloy™	N-2967
SS-2 1/2 Circle 8.6 mm Double-arm Curvature 200°	 SS-2  	5-0	1	45	Black	12	Surgalloy™	N-2761K

NOVAFIL™

Monofilament Polybutester

Supple and Flexible. Stretches with Healing.







Please refer to the individual package IFUs for complete instructions, indications, contraindications, warnings and precautions.





Description	Novafil™ monofilament polybutester sutures are nonabsorbable, sterile, surgical sutures composed of a copolymer of butylene terephthalate and polytetramethylene ether glycol.
Indications	Novafil™ polybutester sutures are indicated for use in general soft tissue approximation and/or ligation.
Actions	Novafil™ polybutester sutures elicit a minimal acute inflammatory reaction in tissues, followed by gradual encapsulation of the suture by fibrous connective tissue.
Tensile Strength	Novafil™ polybutester sutures are not absorbed, nor is any significant change in tensile strength retention known to occur in vivo.
Sterilization	Gamma irradiation.
Packaging	Novafil™ polybutester sutures are available clear or pigmented with Copper Phthalocyanine Blue, in sizes 1 (4 Metric), size 2–0 (metric 3) through 7-0 (0.5 Metric). The sutures are supplied sterile, in pre-cut lengths affixed to reverse cutting needle type using permanent needle attachment techniques. Please refer to the individual package IFUs for complete instructions, indications, contraindications, warnings and precautions.

Novafil™





Novafil™ suture is a brand you have trusted for
~ 30 years with a proven history of performance.

REVERSE CUTTING								
Needles Specifications	Size USP	EP	Length cm	Color	Units Per box	Comments	Reorder code	
C-1 3/8 Circle 12 mm 	6-0	0.7	45	Blue	12		8886441913	
	5-0	1	45	Blue	12		8886441923	
	4-0	1.5	45	Blue	12		8886441933	
C-12 3/8 Circle 16 mm 	5-0	1	45	Blue	12		88864555-23	
C-13 3/8 Circle 19 mm 	6-0	0.7	45	Blue	12	455	8886442013	
	5-0	1	45	Blue	12		8886442023	
	4-0	1.5	45	Blue	12		8886442033	
	4-0	1.5	75	Blue	36		8886403231	
	3-0	2	45	Blue	12		8886442043	
	3-0	2	75	Blue	36		88864554-41	
C-14 3/8 Circle 24 mm 	4-0	1.5	45	Blue	12		8886442233	
	3-0	2	45	Blue	12		8886442243	
	3-0	2	90	Blue	36		8886400241	
	2-0	3	45	Blue	12		8886442253	
	2-0	3	75	Blue	12		8886442153	





REVERSE CUTTING

Needles Specifications	Size		Length cm	Color	Units Per box	Comments	Reorder code
	USP	EP					
C-16 3/8 Circle 30 mm 	4-0	1.5	75	Blue	36		8886442431
	3-0	2	75	Blue	36		8886442441
	2-0	3	75	Blue	36		8886442451
	0	3.5	75	Blue	36		8886442461
C-17 3/8 Circle 39 mm 	3-0	2	75	Blue	36		8886442641
	2-0	3	75	Blue	36		8886442651
	0	3.5	75	Blue	36		8886442661
GS-11 1/2 Circle 37 mm 	0	3.5	100	Blue	12		8886400963
	1	4	75	Blue	36		8886443371
GS-13 1/2 Circle 48 mm (Not to scale) 	1	4	75	Blue	36		8886443671
	1	4	100	Blue	12		CPB-738G

PREMIUM REVERSE CUTTING

Needles Specifications	Size USP	EP	Length cm	Color	Units Per box	Comments	Reorder code
P-10 3/8 Circle 11 mm 	7-0	0.5	45	Blue	12	Surgalloy™	8886441003
	6-0	0.7	45	Blue	12	Surgalloy™	8886441013
	5-0	1	45	Blue	12	Surgalloy™	8886441023
P-13 3/8 Circle 13 mm 	6-0	0.7	45	Blue	12	Surgalloy™	SPB-1213G
	5-0	1	45	Blue	12	Surgalloy™	SPB-5223G
	5-0	1	75	Blue	36	Surgalloy™	8886402721
	4-0	1.5	45	Blue	12	Surgalloy™	SPB-1233G
SBE-2 3/8 Circle 13 mm 	6-0	0.7	45	Blue	12		8886440013
	5-0	1	45	Blue	12		8886440023
P-11 3/8 Circle 16 mm 	6-0	0.7	45	Blue	12	Surgalloy™	SPB-5413G
	5-0	1	45	Blue	12	Surgalloy™	SPB-5142G
	5-0	1	75	Blue	36	Surgalloy™	8886402821
	4-0	1.5	45	Blue	12	Surgalloy™	SPB-5143G
	4-0	1.5	45	Blue	36	Surgalloy™	8886441431
	4-0	1.5	75	Blue	36	Surgalloy™	8886402831
SBE-3 3/8 Circle 16 mm 	6-0	0.7	45	Blue	12		8886440113
	5-0	1	45	Blue	12		8886440123
	4-0	1.5	45	Blue	12		8886440133



PREMIUM REVERSE CUTTING

Needles Specifications	Size USP	EP	Length cm	Color	Units Per box	Comments	Reorder code
P-12 3/8 Circle 19 mm 	5-0	1	45	Blue	12	Surgalloy™	SPB-1623G
	4-0	1.5	45	Blue	12	Surgalloy™	SPB-5633G
	4-0	1.5	75	Blue	36	Surgalloy™	8886442531
	3-0	2	45	Blue	12	Surgalloy™	SPB-1643G
	3-0	2	45	Blue	36	Surgalloy™	8886441543
SBE-4 3/8 Circle 19 mm 	5-0	1	45	Blue	12		8886440223
	4-0	1.5	45	Blue	12		8886440233
	3-0	2	45	Blue	12		8886440243
P-14 3/8 Circle 24 mm 	4-0	1.5	45	Blue	12	Surgalloy™	SPB-5833G
	3-0	2	45	Blue	12	Surgalloy™	SPB-5843G
	3-0	2	75	Blue	36	Surgalloy™	88864582-43
	2-0	3	45	Blue	12	Surgalloy™	88864418-53
	2-0	3	75	Blue	36	Surgalloy™	88864582-53
SBE-6 3/8 Circle 24 mm 	4-0	1.5	45	Blue	12		8886440333
	3-0	2	45	Blue	12		8886440343
P-24 1/2 Circle 16 mm 	4-0	1.5	45	Clear	12	Surgalloy™	SPB-5433G







CONVENTIONAL CUTTING

Needles Specifications	Size		Length cm	Color	Units Per box	Comments	Reorder code
	USP	EP					
PC-12 3/8 Circle 19 mm 	5-0	1	45	Blue	12		SPB-1945G
SC-2 Straight 60 mm 	3-0	2	75	Blue	36		88864490-41
	2-0	3	75	Blue	36		88864490-51

X CUTTING

Needles Specifications	Size		Length cm	Color	Units Per box	Comments	Reorder code
	USP	EP					
DX-11 3/8 Circle 11 mm 	6-0	0.7	45	Blue	12	DermaX	XNF-697
DX-16 3/8 Circle 16 mm 	6-0	0.7	45	Blue	12	DermaX	XNF-1966
	5-0	1	45	Blue	12	DermaX	XNF-1965
	4-0	1.5	45	Blue	12	DermaX	XNF-1964
DX-19 3/8 Circle 19 mm 	5-0	1	45	Blue	12	DermaX	XNF-1995
	4-0	1.5	45	Blue	12	DermaX	XNF-1994
	3-0	2	45	Blue	12	DermaX	XNF-1993

TAPER POINT

Needles Specifications	Size USP	EP	Length cm	Color	Units Per box	Comments	Reorder code
V-20 1/2 Circle 26 mm 	3-0	2	75	Blue	36	Surgalloy™	8886445241
	2-0	3	75	Blue	36	Surgalloy™	8886445251
	0	3.5	75	Blue	36	Surgalloy™	8886445261
GS-22 1/2 Circle 27 mm 	2-0	3	75	Blue	36		8886445951
	2-0	3	5×45	Blue	12	D-Tach™	8886445853
	0	3.5	5×45	Blue	12	D-Tach™	8886445863
	0	3.5	75	Blue	36		8886445961
	1	4	75	Blue	36		8886445971
GS-22 LOOP 1/2 Circle 27 mm 	2-0	3	150	Blue	36	Loop	88864619-51
V-26 1/2 Circle 37 mm 	3-0	2	75	Blue	36		8886445041
GS-21 1/2 Circle 37 mm 	0	3.5	5×45	Blue	12	D-Tach™	8886445463
	0	3.5	75	Blue	36		8886445561
	1	4	5×45	Blue	12	D-Tach™	8886445473
	1	4	75	Blue	36		8886445571
GS-24 1/2 Circle 40 mm 	1	4	75	Blue	36		88864463-71



TAPER POINT

Needles Specifications	Size		Length		Color	Units Per box	Comments	Reorder code
	USP	EP	cm	Inches				
GS-25 1/2 Circle 48 mm (Not to scale) 	2	5	75	30	Blue	36		88864465-81
	1	4	5×45	18	Blue	12	D-Tach™	88864464-73
	1	4	75	30	Blue	36		88864465-71
GS-25 LOOP 1/2 Circle 48 mm 	0	3.5	200	80	Blue	12	Loop	88864538-63
GS-26 1/2 Circle 65 mm 	2	5	150	60	Blue	36		88864470-81
GS-26 LOOP 1/2 Circle 65 mm 	0	3.5	150	60	Blue	36	Loop	8886440861

HEAVY TAPER POINT

Needles Specifications	Size		Length		Color	Units Per box	Comments	Reorder code
	USP	EP	cm	Inches				
HGS-22 1/2 Circle 27 mm 	0	3.5	5×45	18	Blue	12	D-Tach™	8886446063

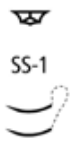
SPATULA

Needles Specifications	Size		Length		Color	Units Per box	Comments	Reorder code
	USP	EP	cm	Inches				
SS-1 1/6 Circle 5.6 mm Double-arm Curvature 60° 	5-0	1	30	12	Blue	12	Surgalloy™	PB-7740K
SS-24 1/4 Circle 8.6 mm Double-arm Curvature 95° 	6-0	0.7	30	12	Blue	12	Surgalloy™	PB-6713K
	5-0	1	30	12	Blue	12	Surgalloy™	PB-6723K

SURGILON™

Braided Nylon

Coated with Silicone to Enhance Handling.



Please refer to the individual package IFUs for complete instructions, indications, contraindications, warnings and precautions.

Description	SURGILON™ braided sutures are inert, nonabsorbable, sterile sutures composed of the long-chain aliphatic polymers Nylon 6 and Nylon 6.6. The braided sutures are coated uniformly with silicone to enhance handling characteristics, ease of passage through tissue and reduction of capillarity.
Indications	SURGILON™ braided nylon sutures are indicated for use in general soft tissue approximation and/or ligation, including use in cardiovascular, ophthalmic, and neurological surgery.
Actions	SURGILON™ braided nylon sutures all elicit a minimal acute inflammatory reaction in tissue, which is followed by gradual encapsulation of the suture by fibrous connective tissue.
Tensile Strength	As with any nylon suture, though not absorbed, progressive hydrolysis of the suture, in vivo, may result in gradual loss of its tensile strength over time.
Sterilization	Surgilon™ braided nylon sutures are sterilized by ethylene oxide in sizes 6-0 (0.7 metric) and smaller and by gamma irradiation in sizes 2 (5 metric) through 5-0 (1 metric).
Packaging	SURGILON™ braided nylon sutures are available dyed black in sizes 1 (4 Metric) through 4-0 (1.5 Metric) and size 6-0 (0.7 metric). The sutures are supplied sterile, in pre-cut lengths or affixed to needles using both permanent and removable needle attachment techniques.





PRE-CUT

Needles Specifications	Size		Length cm	Color	Units Per box	Comments	Reorder code
	USP	EP					
	4-0	1.5	12×45	Black	36	Pre-cut, RACETRAC	88861918-31
	4-0	1.5	7×75	Black	36	Pre-cut	88861919-31
	3-0	2	12×45	White	36	Pre-cut, RACETRAC	88861899-41
	3-0	2	12×45	Black	36	Pre-cut, RACETRAC	88861918-41
	3-0	2	7×75	Black	36	Pre-cut	88861919-41
	2-0	3	12×45	White	36	Pre-cut, RACETRAC	88861899-51
	2-0	3	12×45	Black	36	Pre-cut, RACETRAC	88861918-51
	2-0	3	7×75	Black	36	Pre-cut	88861919-51
	0	3.5	6×45	Black	36	Pre-cut, RACETRAC	88861917-61
	0	3.5	6×45	White	36	Pre-cut, RACETRAC	88861902-61
	0	3.5	7×75	Black	36	Pre-cut	88861919-61
	1	4	6×45	Black	36	Pre-cut, RACETRAC	88861917-71
	1	4	6×45	White	36	Pre-cut, RACETRAC	88861902-71
	1	4	7×75	Black	36	Pre-cut	88861919-71
	2	5	6×45	Black	24	Pre-cut, RACETRAC	88861917-82



REEL

Needles Specifications	Size		Length cm	Color	Units Per box	Comments	Reorder code
	USP	EP					
	3-0	2	366	Black	24	Reel	88861906-42
	2-0	3	366	Black	24	Reel	88861906-52
	0	3.5	250	Black	24	Reel	88861920-62
	1	4	250	Black	24	Reel	88861920-72
	2	5	300	Black	12	Reel	88861914-83
	3	6	238	Black	12	Reel	88861920-93



REVERSE CUTTING

Needles Specifications			Size		Length cm	Color	Units Per box	Comments	Reorder code
			USP	EP					
C-13 3/8 Circle 19 mm		3-0	2	45	Black	12		88861931-43	
		2-0	3	75	Black	36		88861982-51	
C-14 3/8 Circle 24 mm		3-0	2	75	Black	36		88861935-41	
		2-0	3	45	Black	12		88861934-53	
		2-0	3	75	Black	36		88861935-51	
		0	3.5	75	Black	36		88861935-61	
C-16 3/8 Circle 30 mm		3-0	2	5 × 45	Black	24	D-Tach™	88861991-42	
		2-0	3	75	Black	36		88861883-51	
		0	3.5	75	Black	36		88861883-61	
		1	4	75	Black	36		88861883-71	
C-18 3/8 Circle 35 mm		1	4	75	Black	36		88861922-71	
GS-10 1/2 Circle 26 mm		2-0	3	75	Black	36		88861932-51	



REVERSE CUTTING

Needles Specifications	Size		Length cm	Color	Units Per box	Comments	Reorder code
	USP	EP					
HOS-10 1/2 Circle 26 mm 	1	4	75	Black	36		88861896-71
GS-11 1/2 Circle 37 mm 	0	3.5	75	Black	36		88861915-61
	1	4	75	Black	36		88861915-71
HOS-12 1/2 Circle 40 mm 	1	4	5 × 45	Black	24	D-Tach™	88861913-72
	1	4	75	Black	36		88861895-71



PREMIUM REVERSE CUTTING

Needles Specifications	Size		Length cm	Color	Units Per box	Comments	Reorder code
	USP	EP					
P-13 3/8 Circle 13 mm 	5-0	1	45	Black	12	Surgalloy™	SBS-1928G
	4-0	1.5	45	White	12	Surgalloy™	SBS-1880G
P-11 3/8 Circle 16 mm 	4-0	1.5	45	Black	12		88861981-33
P-12 3/8 Circle 19 mm 	4-0	1.5	45	White	12	Surgalloy™	SBS-1884G
	3-0	2	45	White	12	Surgalloy™	SBS-1883G

CONVENTIONAL CUTTING

Needles Specifications	Size		Length cm	Color	Units Per box	Comments	Reorder code
	USP	EP					
SC-1 Straight 51 mm ▲ 	2-0	3	75	Black	36		88861985-51
	0	3.5	75	Black	36		88861985-61
	1	4	75	Black	36		88861985-71
SC-2 Straight 60 mm ▲ 	0	3.5	75	Black	36		88861948-61
	2	5	75	Black	36		88861948-81



TAPER POINT

Needles Specifications	Size		Length cm	Color	Units Per box	Comments	Reorder code
	USP	EP					
CV-20 1/2 Circle 10 mm ⊙ 	5-0	1	5 × 45	Black	24	D-Tach™	88861910-22
	4-0	1.5	5 × 45	Black	24	D-Tach™	88861910-32
CV-22 1/2 Circle 13 mm ⊙ 	4-0	1.5	5 × 45	Black	24	D-Tach™	88861957-32
CV-23 1/2 Circle 17 mm ⊙ 	4-0	1.5	5 × 45	Black	24	D-Tach™	88861927-32
	4-0	1.5	75	Black	36		88861995-31
	3-0	2	5 × 45	Black	24	D-Tach™	88861927-42
	3-0	2	75	Black	36		88861995-41

TAPER POINT

Needles Specifications		Size USP	EP	Length cm	Color	Units Per box	Comments	Reorder code
CV-24 1/2 Circle 20 mm		4-0	1.5	5 × 45	Black	24	D-Tach™	88861989-32
		3-0	2	5 × 45	Black	24	D-Tach™	88861989-42
GS-23 1/2 Circle 22 mm		0	3.5	5 × 45	Black	24	D-Tach™	88861993-62
V-20 1/2 Circle 26 mm		3-0	2	5 × 45	Black	24	D-Tach™	88861958-42
		3-0	2	75	Black	36		88861951-41
		3-0	2	75	Black	24	D-Tach™	88861926-42
		2-0	3	45	Black	24	D-Tach™	88861958-52
		2-0	3	5 × 75	Black	24	D-Tach™	88861967-52
		2-0	3	75	Black	36		88861951-51
		0	3.5	75	Black	36		88861951-61
GS-22 1/2 Circle 27 mm		2-0	3	5 × 45	Black	24	D-Tach™	88861969-52
		0	3.5	5 × 45	Black	24	D-Tach™	88861969-62
		0	3.5	75	Black	36		88861968-61
		1	4	5 × 45	Black	24	D-Tach™	88861969-72
V-30 1/2 Circle 30 mm		2-0	3	75	Black	36		88861964-51
		0	3.5	75	Black	36		88861964-61

TAPER POINT

Needles Specifications	Size		Length cm	Color	Units Per box	Comments	Reorder code
	USP	EP					
GS-21 1/2 Circle 37 mm 	2-0	3	5 × 45	Black	24	D-Tach™	88861962-52
	0	3.5	75	Black	36		88861971-61
	1	4	5 × 45	Black	24	D-Tach™	88861962-72
	1	4	75	Black	36		88861971-71
GS-25 1/2 Circle 48 mm 	0	3.5	5 × 45	Black	24	D-Tach™	88861998-62
SK SKI 23 mm 	2-0	3	250	Black	36		88862011-51

HEAVY TAPER POINT

Needles Specifications	Size		Length cm	Color	Units Per box	Comments	Reorder code
	USP	EP					
HGS-22 1/2 Circle 27 mm 	2-0	3	5 × 45	Black	24	D-Tach™	88861928-52
	0	3.5	5 × 45	Black	24	D-Tach™	88861928-62
	1	4	5 × 45	Black	24	D-Tach™	88861928-72

DIAMOND POINT

Needles Specifications	Size		Length cm	Color	Units Per box	Comments	Reorder code
	USP	EP					
KV-25 1/2 Circle 22 mm 	0	3.5	5 × 45	Black	24	D-Tach™	88861909-62

SOFSILK™

Silicone & Wax Coated Braided Silk

Maximum Surgical Handling.



Please refer to the individual package IFUs for complete instructions, indications, contraindications, warnings and precautions.

Description

Sofsilk™ braided silk sutures are nonabsorbable, sterile, non-mutagenic surgical sutures composed of natural proteinaceous silk fibers called fibroin. This protein is derived from the domesticated silkworm species *Bombyx mori* of the family *bombycidae*. The silk fibers are treated to remove the naturally- occurring sericin gum and braided to produce Sofsilk™ surgical silk sutures. The braided sutures are available coated uniformly with either silicone or a special wax mixture to reduce capillarity and to increase surface lubricity which enhances handling characteristics, ease of passage through tissue, and knot run-down properties.

Indications

Sofsilk™ sutures are indicated for use in general soft tissue approximation and/or ligation, including use in cardiovascular, ophthalmic, microsurgery, and neurological surgery.

Actions

Sofsilk™ sutures elicit a minimal acute inflammatory reaction in tissue, which is followed by gradual encapsulation of the suture by fibrous connective tissue.

Tensile Strength

While Sofsilk™ sutures are not absorbed, progressive degradation of the proteinaceous silk fiber in vivo may result in gradual loss of the suture's tensile strength over time.

Sterilization

Gamma irradiation.

Packaging

Sofsilk™ sutures are available in black with Logwood extract and uniformly coated with silicone or a special wax mixture, in sizes 2 (5 Metric) through 8-0 (0.4 Metric). The sutures are supplied sterile, in pre-cut lengths and ligating reels, nonneedled or affixed to needles using both permanent and removable needle attachment techniques. Please refer to the individual package IFUs for complete instructions, indications, contraindications, warnings and precautions.

PRE-CUT							
Needles Specifications	Size		Length cm	Color	Units Per box	Comments	Reorder code
	USP	EP					
	5-0	1	12×45	Black	36	Pre-cut	S-182
	4-0	1.5	12×45	Black	24	Pre-cut, racetrac	S-193
	4-0	1.5	12×45	Black	36	Pre-cut	S-183
	4-0	1.5	12×60	Black	36	Pre-cut	S-243
	4-0	1.5	12×75	Black	36	Pre-cut	S-303
	3-0	2	12×45	Black	24	Pre-cut, racetrac	S-194
	3-0	2	12×45	Black	36	Pre-cut	S-184
	3-0	2	12×60	Black	24	Pre-cut, racetrac	S-254
	3-0	2	12×60	Black	36	Pre-cut	S-244
	3-0	2	12×75	Black	24	Pre-cut, racetrac	S-404
	3-0	2	12×75	Black	36	Pre-cut	S-304
	2-0	3	12×45	Black	24	Pre-cut, racetrac	S-195
	2-0	3	12×45	Black	36	Pre-cut	S-185
	2-0	3	12×60	Black	36	Pre-cut	S-245
	2-0	3	12×75	Black	36	Pre-cut	S-305
	2-0	3	2×150	Black	36	Pre-cut	S-605
	0	3.5	6×45	Black	24	Pre-cut, racetrac	S-196
	0	3.5	12×45	Black	24	Pre-cut	S-176
	0	3.5	12×60	Black	24	Pre-cut	S-346
	0	3.5	6×60	Black	36	Pre-cut	S-246
	0	3.5	12×75	Black	24	Pre-cut	S-316
	0	3.5	2×150	Black	36	Pre-cut	S-606
	1	4	6×45	Black	24	Pre-cut, racetrac	S-197
	1	4	6×45	Black	36	Pre-cut	S-187
	1	4	12×75	Black	24	Pre-cut	S-317
	1	4	2×150	Black	36	Pre-cut	S-607
	2	5	12×75	Black	24	Pre-cut	S-318
	2	5	2×150	Black	36	Pre-cut	S-608

PRE-CUT

Needles Specifications	Size		Length cm	Color	Units Per box	Comments	Reorder code
	USP	EP					
	5	7	3 × 60	Black	36	Pre-cut	S-282
	5	7	2 × 150	Black	12	Pre-cut	S-610



NON-NEEDED-STADARD LENGHTT

Needles Specifications	Size		Length cm	Color	Units Per box	Comments	Reorder code
	USP	EP					
	2	5	100	Black	36	Standard length	S-206
	4	6	180	Black	12	Standard length	S-199

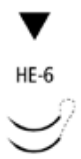

REEL

Needles Specifications	Size		Length cm	Color	Units Per box	Comments	Reorder code
	USP	EP					
	4-0	1.5	250	Black	24	Reel	LS-640
	3-0	2	250	Black	24	Reel	LS-639
	2-0	3	250	Black	24	Reel	LS-638
	0	3.5	250	Black	24	Reel	LS-637
	1	4	250	Black	24	Reel	LS-636



REVERSE CUTTING

Needles Specifications	Size		Length cm	Color	Units Per box	Comments	Reorder code	
	USP	EP						
HE-6 3/8 Circle 7.4 mm Double-arm Curvature 110°		7-0	0.5	45	Black	12	S-1768K	
		6-0	0.7	45	Black	12	Surgalloy™	S-1769K
HE-5 3/8 Circle 8.6 mm Double-arm Curvature 135°		6-0	0.7	30	Black	12	Surgalloy™	S-1746K



REVERSE CUTTING

Needles Specifications	Size USP	EP	Length cm	Color	Units Per box	Comments	Reorder code	
HE-1 3/8 Circle 11 mm Double-arm Curvature 135°	6-0	0.7	45	Black	12	Surgalloy™	S-1750K	
C-1 3/8 Circle 12 mm		6-0	0.7	45	Black	36	S-1172	
		5-0	1	45	Black	36	S-1173	
		4-0	1.5	45	Black	36	S-1174	
		4-0	1.5	75	Black	36	S-1373	
C-1 3/8 Circle 12 mm Double-arm		6-0	0.7	45	Black	12	S-1272	
		4-0	1.5	30	Black	12	S-1735	
		4-0	1.5	45	Black	12	S-1274	
HE-3 3/8 Circle 13 mm Double-arm Curvature 155°		4-0	1.5	45	Black	12	Surgalloy™	S-1789K
		4-0	1.5	45	Black	12	Surgalloy™	S-1783K



REVERSE CUTTING

Needles Specifications	Size		Length cm	Color	Units Per box	Comments	Reorder code
	USP	EP					
C-12 3/8 Circle 16 mm 	6-0	0.7	45	Black	36		SS-681
	5-0	1	75	Black	36		SS-673
	4-0	1.5	45	Black	12		SS-686
	4-0	1.5	75	Black	36		SS-645
	3-0	2	75	Black	36		SS-745
	2-0	3	75	Black	36		SS-746
C-13 3/8 Circle 19 mm 	5-0	1	45	Black	36		SS-682
	5-0	1	75	Black	36		SS-652
	4-0	1.5	45	Black	12		SS-683G
	4-0	1.5	45	Black	36		SS-683
	4-0	1.5	75	Black	36		SS-653
	3-0	2	45	Black	36		SS-694
	3-0	2	75	Black	36		SS-654
	2-0	3	75	Black	36		SS-655
	0	3.5	75	Black	36		SS-656



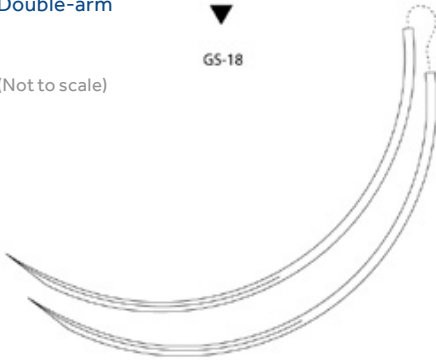

REVERSE CUTTING

Needles Specifications	Size USP	EP	Length cm	Color	Units Per box	Comments	Reorder code
C-14 3/8 Circle 24 mm 	4-0	1.5	45	Black	36		SS-629
	3-0	2	45	Black	36		SS-684
	3-0	2	45	Black	12		SS-684G
	3-0	2	75	Black	36		SS-784
	2-0	3	45	Black	36		SS-695
	2-0	3	75	Black	36		SS-785
	0	3.5	75	Black	36		SS-786
	1	4	75	Black	36		SS-787
C-15 3/8 Circle 26 mm 	2-0	3	45	Black	12		SS-685G
	2-0	3	45	Black	36		SS-685
C-16 3/8 Circle 30 mm 	3-0	2	75	Black	36		SS-675
	2-0	3	45	Black	36		SS-677
	2-0	3	75	Black	36		SS-679
	0	3.5	45	Black	36		SS-678
	0	3.5	5 × 75	Black	24	D-Tach™	SS-70-M
	0	3.5	75	Black	36		SS-680
	1	4	75	Black	36		SS-689







REVERSE CUTTING

Needles Specifications	Size		Length cm	Color	Units Per box	Comments	Reorder code
	USP	EP					
C-17 3/8 Circle 39 mm 	2-0	3	75	Black	36		SS-648
	0	3.5	75	Black	36		SS-647
	1	4	75	Black	36		SS-646
	2	5	75	Black	36		SS-651
GS-18 3/8 Circle 77 mm Double-arm (Not to scale) 	2	5	75	Black	24		CS-482
	5	7	75	Black	24		CS-485
HE-7 1/2 Circle 7.4 mm Double-arm Curvature 145° 	7-0	0.5	45	Black	12		S-1766K
	6-0	0.7	45	Black	12	Surgalloy™	S-1765K
C-21 1/2 Circle 13 mm 	4-0	1.5	5 × 45	Black	24	D-Tach™	SS-82-M



REVERSE CUTTING

Needles Specifications	Image	Size		Length cm	Color	Units Per box	Comments	Reorder code
		USP	EP					
C-22 1/2 Circle 20 mm		4-0	1.5	45	Black	36		SS-733
C-23 1/2 Circle 24 mm		3-0	2	45	Black	36		SS-732
		3-0	2	75	Black	36		SS-632
		2-0	3	45	Black	36		SS-734
		2-0	3	75	Black	36		SS-633
GS-10 1/2 Circle 26 mm		2-0	3	45	Black	36		CS-390
GS-11 1/2 Circle 37 mm		2-0	3	75	Black	36		CS-490

PREMIUM REVERSE CUTTING

Needles Specifications	Size USP	EP	Length cm	Color	Units Per box	Comments	Reorder code
P-10 3/8 Circle 11 mm 	6-0	0.7	45	Black	36	Surgalloy™	SS-5639
	6-0	0.7	45	Black	12	Surgalloy™	SS-1639G
P-13 3/8 Circle 13 mm 	6-0	0.7	45	Black	12	Surgalloy™	SS-5649G
	5-0	1	45	Black	36	Surgalloy™	SS-5640
	4-0	1.5	45	Black	12	Surgalloy™	SS-5641G
	4-0	1.5	45	Black	36	Surgalloy™	SS-5641
P-11 3/8 Circle 16 mm 	5-0	1	45	Black	36	Surgalloy™	SS-5678
P-12 3/8 Circle 19 mm 	5-0	1	45	Black	36	Surgalloy™	SS-5676
	4-0	1.5	45	Black	36	Surgalloy™	SS-5677
	3-0	2	45	Black	36	Surgalloy™	SS-5679
P-14 3/8 Circle 24 mm 	3-0	2	45	Black	36	Surgalloy™	SS-5684
	2-0	3	45	Black	12		SS-5685G
P-24 1/2 Circle 16 mm 	4-0	1.5	45	Black	12	Surgalloy™	SS-1694G

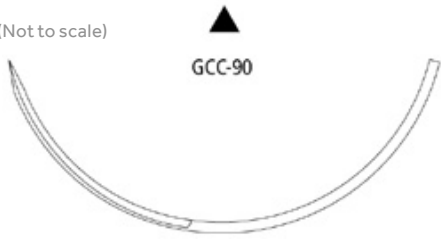

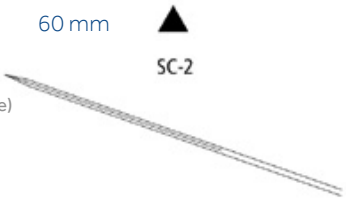

CONVENTIONAL CUTTING

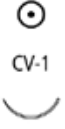
Needles Specifications	Size		Length cm	Color	Units Per box	Comments	Reorder code
	USP	EP					
GCC-90 3/8 Circle 90 mm (Not to scale) 	2-0	3	100	Black	36		CS-791
	0	3.5	100	Black	36		CS-792
	1	4	100	Black	36		CS-793
	2	5	100	Black	36		CS-794
SC-1 Straight 51 mm Double-arm (Not to scale) 	2-0	3	75	Black	36		SS-523
	1	4	75	Black	36		SS-525
SC-2 Straight 60 mm (Not to scale) 	4-0	1.5	75	Black	36		SS-621
	3-0	2	75	Black	36		SS-622
	3-0	2	100	Black	36		SS-722
	2-0	3	75	Black	36		SS-623
	2-0	3	100	Black	36		SS-723
	0	3.5	75	Black	36		SS-624



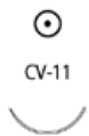

TAPER POINT

Needles Specifications	Size		Length cm	Color	Units Per box	Comments	Reorder code
	USP	EP					
CV-1 3/8 Circle 9 mm 	6-0	0.7	45	Black	36	Surgalloy™	VS-802
	7-0	0.5	45	Black	36	Surgalloy™	VS-809

TAPER POINT

Needles Specifications	Size USP	EP	Length cm	Color	Units Per box	Comments	Reorder code
CV-11 3/8 Circle 13 mm 	6-0	0.7	75	Black	36	Surgalloy™	VS-889
	5-0	1	75	Black	36	Surgalloy™	VS-890
	4-0	1.5	75	Black	36	Surgalloy™	VS-891
CV-11 3/8 Circle 13 mm Double-arm 	6-0	0.7	45	Black	36	Surgalloy™	VS-806
	6-0	0.7	5 × 60	Black	12	Surgalloy™	VS-706-M
	4-0	1.5	45	Black	36	Surgalloy™	VS-709
CV-15 3/8 Circle 17 mm 	5-0	1	75	Black	36	Surgalloy™	VS-880
	4-0	1.5	75	Black	36	Surgalloy™	VS-881
	3-0	2	75	Black	36	Surgalloy™	VS-882
	2-0	3	75	Black	36	Surgalloy™	VS-823
CV-15 3/8 Circle 17 mm Double-arm 	4-0	1.5	60	Black	36	Surgalloy™	VS-581



TAPER POINT

Needles Specifications	Size USP	EP	Length cm	Color	Units Per box	Comments	Reorder code
CVF-21 1/2 Circle 12 mm  CVF-21 	5-0	1	45	Black	36	Surgalloy™	CS-210
	4-0	1.5	45	Black	36	Surgalloy™	CS-211
CV-22 1/2 Circle 13 mm  CV-22 	4-0	1.5	5 × 45	Black	24	D-Tach™	GS-44-M

TAPER POINT

Needles Specifications	Size USP	EP	Length cm	Color	Units Per box	Comments	Reorder code
CV-23 1/2 Circle 17 mm 	5-0	1	75	Black	36	Surgalloy™	VS-870
	4-0	1.5	75	Black	36	Surgalloy™	VS-871
	3-0	2	5 × 45	Black	24	D-Tach™	GS-47-M
	3-0	2	75	Black	36	Surgalloy™	VS-872
	2-0	3	75	Black	36	Surgalloy™	VS-873
CV-24 1/2 Circle 20 mm 	4-0	1.5	75	Black	36		GS-451
	3-0	2	75	Black	36		GS-452
	2-0	3	75	Black	36		GS-453
CV-25 1/2 Circle 22 mm 	4-0	1.5	5 × 45	Black	24	D-Tach™	GS-34-M
	3-0	2	5 × 45	Black	24	D-Tach™	GS-33-M
	3-0	2	5 × 75	Black	24	D-Tach™	GS-30-M
CV-25 1/2 Circle 22 mm Double-arm 	3-0	2	75	Black	36	Surgalloy™	VS-552
GS-23 1/2 Circle 22 mm 	2-0	3	75	Black	36		CS-562



TAPER POINT

Needles Specifications	Size		Length cm	Color	Units Per box	Comments	Reorder code
	USP	EP					
V-20 1/2 Circle 26 mm 	4-0	1.5	5 × 45	Black	24	D-Tach™	GS-64-M
	4-0	1.5	75	Black	36		GS-831
	3-0	2	5 × 45	Black	24	D-Tach™	GS-63-M
	3-0	2	5 × 75	Black	24	D-Tach™	GS-67-M
	3-0	2	75	Black	36		GS-832
	2-0	3	5 × 45	Black	24	D-Tach™	GS-62-M
	2-0	3	75	Black	36		GS-833
	2-0	3	5 × 75	Black	24	D-Tach™	GS-66-M
	0	3.5	75	Black	36		GS-834
	1	4	75	Black	36		GS-835
V-20 1/2 Circle 26 mm Double-arm 	2-0	3	90	Black	36	Surgalloy™	VS-533
GS-22 1/2 Circle 27 mm 	2-0	3	5 × 45	Black	24	D-Tach™	CS-16-M
	0	3.5	5 × 45	Black	24	D-Tach™	CS-17-M



TAPER POINT

Needles Specifications	Size		Length cm	Color	Units Per box	Comments	Reorder code
	USP	EP					
V-30 1/2 Circle 30 mm 	3-0	2	75	Black	36		GS-822
	2-0	3	75	Black	36		GS-823
	0	3.5	75	Black	36		GS-824
GS-21 1/2 Circle 37 mm 	2-0	3	75	Black	36		CS-423
	0	3.5	5 × 45	Black	24	D-Tach™	CS-10-M
	0	3.5	75	Black	36		CS-424
	1	4	75	Black	36		CS-425
V-26 1/2 Circle 37 mm 	3-0	2	75	Black	36		VS-842
	2-0	3	75	Black	36		VS-843
	0	3.5	75	Black	36		VS-844
	1	4	75	Black	36		VS-845
	1	4	2 × 75	White	24	D-Tach™	CS-745
	1	4	75	White	36		CS-744
	2	5	75	Black	36		VS-846
	2	5	2 × 75	White	24	D-Tach™	CS-746



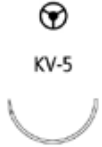

HEAVY TAPER POINT

Needles Specifications	Size USP	EP	Length cm	Color	Units Per box	Comments	Reorder code
HGS-23 1/2 Circle 22 mm 	2-0	3	5 × 45	Black	24	D-Tach™	CS-93-M
	0	3.5	5 × 45	Black	24	D-Tach™	CS-92-M
HGS-22 1/2 Circle 27 mm 	0	3.5	5 × 45	Black	24	D-Tach™	CS-85-M
HGS-20 1/2 Circle 34mm 	1	4	5 × 75	Black	12		X-1095

TAPERCUTTING

Needles Specifications	Size USP	EP	Length cm	Color	Units Per box	Comments	Reorder code
KV-5 1/2 Circle 17 mm 	3-0	2	75	Black	36	Surgalloy™	VS-863
KV-7 1/2 Circle 26 mm 	2-0	3	75	Black	36	Surgalloy™	VS-964
KV-34 1/2 Circle 37 mm 	1	4	2 × 75	White	12	D-Tach™	VS-766G

SPATULA

Needles Specifications	Image	Size		Length cm	Color	Units Per box	Comments	Reorder code
		USP	EP					
SE-100-8 1/4 Circle 6.3 mm Double-arm Curvature 100°		8-0	0.4	45	Black	12	Surgalloy™	S-2176K
SS-14 1/4 Circle 8.6 mm Double-arm Curvature 115°		6-0	0.7	45	Black	12	Surgalloy™	S-1780K
SS-24 1/4 Circle 8.6 mm Double-arm Curvature 95°		6-0	0.7	45	Black	12	Surgalloy™	S-2780K
		4-0	1.5	45	White	12		S-2782K
SE-140-8 3/8 Circle 6.3 mm Double-arm Curvature 140°		8-0	0.4	30	Black	12	Surgalloy™	S-2752K
		8-0	0.4	45	Black	12	Surgalloy™	S-1734K
		7-0	0.5	45	Black	12	Surgalloy™	S-1733K
		6-0	0.7	45	Black	12	Surgalloy™	S-1732K

V-LOC™ 90

Absorbable Wound Closure Device

Secure. Fast. Effective.†



THE V-LOC™ DEVICE
ADVANTAGE
**NOW WITH STRONGER,
SHARPER NEEDLES***

Please refer to the individual package IFUs for complete instructions, indications, contraindications, warnings and precautions.



* When compared with previous generation

† When compared with traditional suture



Description	The V-Loc™ 90 absorbable wound closure device consists of a barbed absorbable thread, armed with a surgical needle at one end and a loop end effector at the other. The barb and loop end effector design allow for tissue approximation without the need to tie surgical knots. The V-Loc™ 90 absorbable wound closure device is prepared from a synthetic polyester composed of glycolide, dioxanone, and trimethylene carbonate. The absorbable wound closure device is available undyed or violet. The device is sterile, inert, noncollagenous and nonantigenic.
Indications	V-Loc™ 90 absorbable wound closure devices are indicated for soft tissue approximation where use of an absorbable suture is appropriate. The safety and effectiveness of the V-Loc™ 90 absorbable wound closure device has not been established for use in fascial closures (abdominal wall, thoracic, extremity fascial closures), gastrointestinal anastomoses, cardiovascular anastomoses, neurological, ophthalmic, orthopedic or microsurgery.
Actions	V-Loc™ 90 absorbable wound closure devices elicit a minimal acute inflammatory reaction in tissues, which is followed by a gradual encapsulation of the device by fibrous connective tissue. Progressive loss of tensile strength and eventual absorption of V-Loc™ 90 absorbable wound closure device occurs by means of hydrolysis where the device is broken down to glycolic acid, dioxanoic acid, propane diol and carbon dioxide which are subsequently absorbed and metabolized by the body.
Tensile Strength	Approximately 90% of initial tensile strength at 1 week, 75% at 2 weeks postimplant.
Sterilization	Ethylene oxide.
Absorbtion	Absorption begins as a loss of tensile strength without appreciable loss of mass. Animal data indicates that the absorption is essentially complete between 90 and 110 days.
Packaging	The V-Loc™ 90 absorbable wound closure devices are available in USP and EP sizes 2-0 (3 metric) through 4-0 (1.5 Metric). The V-Loc™ 90 absorbable wound closure devices are available dyed violet or undyed (clear). The devices are supplied sterile, in pre-cut lengths affixed to various needle types. The devices are available in box quantities of one dozen. Please refer to the individual package IFUs for complete instructions, indications, contraindications, warnings and precautions.

V-Loc™ 90 Absorbable

V-Loc™ 90 wound closure device is a uni-directional mid-term absorbable knotless barbed suture.

PREMIUM REVERSE CUTTING								
Needles Specifications	Size USP	EP	Length cm	Color	Units Per box	Comments	Reorder code	
P-11 3/8 Circle 16 mm 	4-0	1.5	30	Undyed	12	Surgalloy™	VLOCM1413	
	4-0	1.5	45	Undyed	12	Surgalloy™	VLOCM1423	
P-12 3/8 Circle 19 mm 	4-0	1.5	15	Undyed	12	Surgalloy™	VLOCM0003	
	4-0	1.5	30	Undyed	12	Surgalloy™	VLOCM0013	
	4-0	1.5	45	Undyed	12	Surgalloy™	VLOCM0023	
	4-0	1.5	58	Undyed	12	Surgalloy™	VLOCM0033	
	3-0	2	15	Undyed	12		VLOCM0004	
	3-0	2	30	Undyed	12		VLOCM0014	
	3-0	2	45	Undyed	12		VLOCM0024	
	3-0	2	58	Undyed	12	Surgalloy™	VLOCM0034	
	2-0	3	15	Undyed	12		VLOCM0005	
	2-0	3	30	Undyed	12		VLOCM0015	
	2-0	3	45	Undyed	12		VLOCM0025	
	2-0	3	58	Undyed	12		VLOCM0035	



PREMIUM REVERSE CUTTING

Needles Specifications	Size		Length cm	Color	Units Per box	Comments	Reorder code
	USP	EP					
P-14 3/8 Circle 24 mm 	4-0	1.5	30	Undyed	12	Surgalloy™	VLOCM0113
	4-0	1.5	45	Undyed	12	Surgalloy™	VLOCM0123
	4-0	1.5	58	Undyed	12	Surgalloy™	VLOCM0133
	3-0	2	30	Undyed	12	Surgalloy™	VLOCM0114
	3-0	2	45	Undyed	12	Surgalloy™	VLOCM0124
	3-0	2	58	Undyed	12	Surgalloy™	VLOCM0134
	2-0	3	30	Undyed	12		VLOCM0115
	2-0	3	45	Undyed	12		VLOCM0125
	2-0	3	58	Undyed	12		VLOCM0135
P-17 3/8 Circle 30 mm 	3-0	2	45	Undyed	12		VLOCM1824

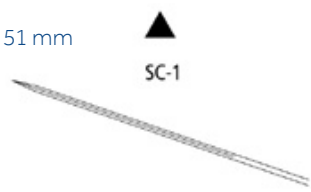
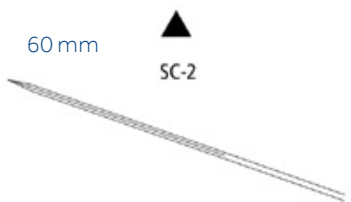

CONVENTIONAL CUTTING

Needles Specifications	Size		Length cm	Color	Units Per box	Comments	Reorder code
	USP	EP					
SC-1 Straight 51 mm 	3-0	2	45	Undyed	12	Reliapoint™	VLOCM1624
SC-2 Straight 60 mm 	4-0	1.5	45	Undyed	12	Reliapoint™	VLOCM0223
	3-0	2	45	Undyed	12		VLOCM0224

TAPER POINT

Needles Specifications	Size USP	EP	Length cm	Color	Units Per box	Comments	Reorder code
CV-15 3/8 Circle 17 mm 	4-0	1.5	15	Violet	12		VLOCM1203
	3-0	2	15	Violet	12	Surgalloy™	VLOCM1204
CV-23 1/2 Circle 17 mm 	4-0	1.5	23		12		VLOCM0843
	4-0	1.5	30	Violet	12		VLOCM0813
	3-0	2	15	Undyed	12	Surgalloy™	VLOCM1904
	3-0	2	15	Violet	12	Surgalloy™	VLOCM0804
	3-0	2	23	Undyed	12	Surgalloy™	VLOCM1944
	3-0	2	23	Violet	12	Surgalloy™	VLOCM0844
	3-0	2	30	Violet	12		VLOCM0814
	3-0	2	45	Violet	12		VLOCM0824
V-20 1/2 Circle 26 mm 	4-0	1.5	15	Violet	12	Surgalloy™	VLOCM0603
	4-0	1.5	45	Violet	12	Surgalloy™	VLOCM0623
	3-0	2	15	Violet	12		VLOCM0604
	3-0	2	15	Undyed	12	Surgalloy™	VLOCM2004
	3-0	2	23	Violet	12	Surgalloy™	VLOCM0644
	3-0	2	23	Undyed	12	Surgalloy™	VLOCM2044
	3-0	2	30	Violet	12		VLOCM0614
	3-0	2	45	Violet	12		VLOCM0624
	2-0	3	45	Violet	12		VLOCM0625

TAPER POINT

Needles Specifications	Size		Length cm	Color	Units Per box	Comments	Reorder code
	USP	EP					
GS-22 1/2 Circle 27 mm 	2-0	3	15	Violet	12		VLOCM2105
	2-0	3	15	Undyed	12		VLOCM2205
	2-0	3	23	Violet	12		VLOCM2145
	2-0	3	23	Undyed	12		VLOCM2245
	2-0	3	30	Violet	12		VLOCM2115
V-30 1/2 Circle 30 mm 	3-0	2	23	Violet	12		VLOCM1544
	2-0	3	23	Violet	12		VLOCM1545
GS-21 1/2 Circle 37 mm 	3-0	2	23	Violet	12		VLOCM0344
	3-0	2	45	Violet	12		VLOCM0324
	2-0	3	15	Violet	12		VLOCM0305
	2-0	3	23	Violet	12		VLOCM0345
	2-0	3	30	Violet	12		VLOCM0315
	2-0	3	45	Undyed	12		VLOCM3225
GU-46 5/8 Circle 27 mm 	3-0	2	15	Violet	12	Surgalloy™	VLOCM1704
	3-0	2	23	Violet	12		VLOCM1744

V-LOC™ 180

Absorbable Wound Closure Device

Secure. Fast. Effective.†



THE V-LOC™ DEVICE
ADVANTAGE
**NOW WITH STRONGER,
SHARPER NEEDLES***

Please refer to the individual package IFUs for complete instructions, indications, contraindications, warnings and precautions.

* When compared with previous generation

† When compared with traditional suture

Description

The V-Loc™ 180 absorbable wound closure device consists of a barbed absorbable thread, armed with a surgical needle at one end and a loop end effector at the other. The barb and loop end effector design allow for tissue approximation without the need to tie surgical knots. The V-Loc™ 180 absorbable wound closure device is prepared from a copolymer of glycolic acid and trimethylene carbonate. The absorbable wound closure device is available clear or green. The device is sterile, inert, noncollagenous and nonantigenic.

Indications

V-Loc™ 180 absorbable wound closure devices are indicated for soft tissue approximation where use of an absorbable suture is appropriate. The safety and effectiveness of the V-Loc™ 180 absorbable wound closure device has not been established for use in fascial closures (abdominal wall, thoracic, extremity fascial closures), gastrointestinal anastomoses, cardiovascular anastomoses, neurological, ophthalmic, orthopedic or microsurgery.

Actions

When implanted in animal tissue, V-Loc™ 180 absorbable wound closure devices elicit a minimal tissue reaction characteristic of foreign body response to substance. The tissue reaction resolves as the device is absorbed. Experimental animal studies for this absorbable material produced no evidence of antigenicity, systemic toxicity, carcinogenicity, mutagenicity, teratogenicity or adverse effects on reproductive performance.

Tensile Strength

Studies demonstrate the following approximate % of U.S.P. and E.P. knot pull minimum average specification for the labeled diameter size: Approximately 80% of initial tensile strength at 1 week, 75% at 2 weeks, and 65% at 3 weeks post implant.

Sterilization

Ethylene oxide.

Absorbtion

Animal data indicates that the absorption is minimal until about the 60th day after implantation. Absorption is substantially complete within six months.



Packaging

The V-Loc™ 180 absorbable wound closure devices are available in USP and EP sizes 4–0 (1.5 Metric) through 0 (3.5 Metric). The V-Loc™ 180 absorbable wound closure devices are dyed with D&C No. 6 or available Clear (Undyed). The devices are supplied sterile, in pre-cut lengths affixed to various needle types. The devices are available in box quantities of one dozen.

V-Loc™ 180 Absorbable

V-Loc™ 180 wound closure device is a uni-directional long-term absorbable knotless barbed suture.

REVERSE CUTTING							
Needles Specifications	Size		Length cm	Color	Units Per box	Comments	Reorder code
	USP	EP					
GS-11 1/2 Circle 37 mm 	2-0	3	30	Clear	12	Reliapoint™	VLOCL2815
	0	3.5	45	Clear	12	Reliapoint™	VLOCL2826

PREMIUM REVERSE CUTTING							
Needles Specifications	Size		Length cm	Color	Units Per box	Comments	Reorder code
	USP	EP					
P-11 3/8 Circle 16 mm 	4-0	1.5	30	Green	12		VLOCL1413
P-12 3/8 Circle 19 mm 	4-0	1.5	15	Clear	12	Surgalloy™	VLOCL0003
	4-0	1.5	30	Clear	12	Surgalloy™	VLOCL0013
	4-0	1.5	45	Clear	12	Surgalloy™	VLOCL0023
	4-0	1.5	58	Clear	12	Surgalloy™	VLOCL0033
	3-0	2	15	Clear	12		VLOCL0004
	3-0	2	30	Clear	12		VLOCL0014
	3-0	2	45	Clear	12		VLOCL0024
	3-0	2	58	Clear	12		VLOCL0034
	2-0	3	30	Clear	12		VLOCL0015
	2-0	3	45	Clear	12		VLOCL0025

PREMIUM REVERSE CUTTING

Needles Specifications	Size		Length cm	Color	Units Per box	Comments	Reorder code
	USP	EP					
P-14 3/8 Circle 24 mm 	4-0	1.5	45	Clear	12	Surgalloy™	VLOCL0123
	4-0	1.5	58	Clear	12	Surgalloy™	VLOCL0133
	3-0	2	30	Clear	12		VLOCL0114
	3-0	2	45	Clear	12		VLOCL0124
	3-0	2	60	Clear	12		VLOCL0134
	2-0	3	30	Clear	12		VLOCL0115
	2-0	3	45	Clear	12		VLOCL0125
	2-0	3	60	Clear	12		VLOCL0135



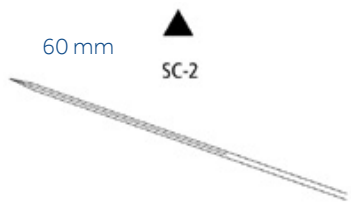

CONVENTIONAL CUTTING

Needles Specifications	Size		Length cm	Color	Units Per box	Comments	Reorder code
	USP	EP					
SC-2 Straight 60 mm 	4-0	1.5	45	Clear	12		VLOCL0223
	3-0	2	45	Clear	12		VLOCL0224

TAPER POINT

Needles Specifications	Size		Length cm	Color	Units Per box	Comments	Reorder code
	USP	EP					
CV-23 1/2 Circle 17 mm 	4-0	1.5	15	Green	12		VLOCL0803
	4-0	1.5	30	Green	12	Surgalloy™	VLOCL0813
	3-0	2	15	Green	12		VLOCL0804
	3-0	2	15	Clear	12		VLOCL1904
	3-0	2	23	Green	12	Surgalloy™	VLOCL0844
	3-0	2	30	Green	12		VLOCL0814
	3-0	2	45	Green	12		VLOCL0824

TAPER POINT

Needles Specifications	Size		Length cm	Color	Units Per box	Comments	Reorder code
	USP	EP					
V-20 1/2 Circle 26 mm 	4-0	1.5	15	Green	12		VLOCL0603
	4-0	1.5	30	Green	12		VLOCL0613
	3-0	2	15	Green	12		VLOCL0604
	3-0	2	23	Green	12	Surgalloy™	VLOCL0644
	3-0	2	30	Green	12	Surgalloy™	VLOCL0614
	3-0	2	45	Green	12	Surgalloy™	VLOCL0624
	2-0	3	30	Green	12		VLOCL0615
	2-0	3	45	Green	12		VLOCL0625
GS-22 1/2 Circle 27 mm 	2-0	3	15	Green	12		VLOCL2105
	2-0	3	23	Green	12		VLOCL2145
V-30 1/2 Circle 30 mm 	3-0	2	23	Green	12		VLOCL1544
	2-0	3	23	Green	12		VLOCL1545
GS-21 1/2 Circle 37 mm 	3-0	2	23	Green	12		VLOCL0344
	3-0	2	45	Green	12		VLOCL0324
	2-0	3	15	Green	12		VLOCL0305
	2-0	3	23	Green	12		VLOCL0345
	2-0	3	30	Green	12		VLOCL0315
	2-0	3	45	Green	12		VLOCL0325
	2-0	3	60	Green	12		VLOCL0335
	0	3.5	15	Green	12		VLOCL0306
	0	3.5	23	Green	12		VLOCL0346
	0	3.5	30	Green	12		VLOCL0316
	0	3.5	45	Green	12		VLOCL0326
	0	3.5	60	Green	12		VLOCL0336
GS-25 1/2 Circle 48 mm (Not to scale) 	0	3.5	30	Green	12		VLOCL0416
	0	3.5	45	Green	12		VLOCL0426
	0	3.5	60	Green	12		VLOCL0436

TAPER POINT

Needles Specifications	Size		Length cm	Color	Units Per box	Comments	Reorder code
	USP	EP					
SK SKI 23 mm 	3-0	2	23	Green	12		VLOCL2744

V-LOC™ PBT

PBT Non Absorbable Wound Closure Device

Secure. Fast. Effective.†





† When compared with traditional suture



Description	The V-Loc™ Polybutester (PBT) non-absorbable wound closure device consists of a barbed non-absorbable thread, armed with a surgical needle at one end and a loop end effector at the other. The barb and loop end effector design allow for tissue approximation without the need to tie surgical knots. The V-Loc™ PBT nonabsorbable wound closure device is composed of a copolymer of butylene terephthalate and polytetramethylene ether glycol. The device is sterile, inert, noncollagenous and nonantigenic.
Indications	V-Loc™ PBT non-absorbable wound closure devices are indicated for soft tissue approximation. The safety and effectiveness of the V-Loc™ PBT non-absorbable wound closure device has not been established for use in fascial closures (abdominal wall, thoracic, extremity fascial closures), gastrointestinal anastomoses, cardiovascular anastomoses, neurological, ophthalmic, orthopedic or microsurgery.
Actions	V-Loc™ PBT non-absorbable wound closure devices sutures elicit a minimal acute inflammatory reaction in tissue, which is followed by gradual encapsulation of the suture by fibrous connective tissue.
Tensile Strength	No known significant change in tensile retention occurs in vivo for the V-Loc™ PBT non-absorbable wound closure device.
Sterilization	Gamma irradiation.
Absorbtion	Permanent.
Packaging	The V-Loc™ PBT non-absorbable wound closure devices are available in USP and EP sizes 1 (4 Metric) through 3-0 (2 Metric). The V-Loc™ PBT non-absorbable wound closure devices are pigmented with Copper Phthalocyanine Blue. The devices are supplied sterile, affixed to taperpoint needle types. The devices are available in box quantities of one dozen.

V-Loc™ PBT

V-Loc™ PBT wound closure device is a uni-directional permanent knotless barbed suture.

TAPER POINT									
Needles Specifications			Size		Length cm	Color	Units Per box	Comments	Reorder code
			USP	EP					
CV-23 1/2 Circle 17 mm			3-0	2	30	Blue	12	Surgalloy™	VLOCN0814
V-20 1/2 Circle 26 mm			3-0	2	15	Blue	12		VLOCN0604
			3-0	2	23	Blue	12		VLOCN0644
			3-0	2	30	Blue	12	Surgalloy™	VLOCN0614
			2-0	3	15	Blue	12		VLOCN0605
			2-0	3	30	Blue	12		VLOCN0615
GS-22 1/2 Circle 27 mm			0	3.5	45	Blue	12		VLOCN1126

TAPER POINT

Needles Specifications	Size		Length cm	Color	Units Per box	Comments	Reorder code
	USP	EP					
GS-21 1/2 Circle 37 mm 	2-0	3	15		12		VLOCN0305
	2-0	3	45	Blue	12		VLOCN0325
	0	3.5	15	Blue	12		VLOCN0306
	0	3.5	45	Blue	12		VLOCN0326
	1	4	45	Blue	12		VLOCN0327
GS-25 1/2 Circle 48 mm 	1	4	60	Blue	12		VLOCN0437



WOUND CLOSURE ACCESSORIES

WOUND CLOSURE ACCESSORIES			
Code	Description	Dimension	Packaging Unit
DSR3	Basic suture module rack that can hold 6 suture boxes	17 × 40 × 14.6 cm	1
DSR12L	Revolving suture rack that can hold 24 suture boxes	33 × 40 × 26.7 cm	1
88868618-00	POLYESTER TAPE	2 × 75 cm	36
8886861903	UMBILICAL TAPE	2 × 75 cm	36
BW25G	BONEWAX 2.5G	2.5 grams	12

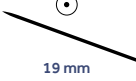

ENDOSCOPIC SUTURES

SURGITIE™ LIGATING LOOP WITH DELIVERY SYSTEM								
Size	Length		Color	Units	Comments	Reorder code		
	USP	metric					units	In.
2-0	3	1	21	53	Green	12	Surgitie™ ligating loop with delivery system with Surgidac™ coated braided polyester suture	ED-20-L
0	3.5	1	21	53	Green	12	Surgitie™ ligating loop with delivery system with Surgidac™ coated braided polyester suture	ED-21-L
2-0	3	1	21	53	Violet	6	Surgitie™ ligating loop with delivery system with Polysorb™ coated braided synthetic absorbable suture	EL-20-L
0	3.5	1	21	53	Violet	6	Surgitie™ ligating loop with delivery system with Polysorb™ coated braided synthetic absorbable suture	EL-21-L
2-0	3	1	21	53	Violet	6	Surgitie™ ligating loop without delivery system with Polysorb™ coated braided synthetic absorbable suture	EL-22-LN
0	3.5	1	21	53	Violet	6	Surgitie™ ligating loop without delivery system with Polysorb™ coated braided synthetic absorbable suture	EL-23-LN



SURGIWIP™ SINGLE-USE SUTURE LIGATURES WITH DELIVERY SYSTEM

Needles Specifications	Size		Length			Color	Units Per box	Comments	Reorder code
	USP	metric	units	In.	cm				
 <p>SK STRAIGHT TAPER</p> <p>19 mm</p>	0	3.5	1	48	120	Violet	6	Surgiwip™ suture ligature with delivery system with Polysorb™ coated braided synthetic absorbable suture	ELW-30
 <p>V-20 TAPER</p> <p>1/2 26 mm</p>	0	3.5	1	48	120	Violet	6	Surgiwip™ suture ligature with delivery system with Polysorb™ coated braided synthetic absorbable suture	ELW-42
 <p>SK SKI TAPER</p> <p>23 mm</p>	0	3.5	1	48	120	Violet	6	Surgiwip™ suture ligature with delivery system with Polysorb™ coated braided synthetic absorbable suture	ELW-50

SURGIWIP™ SINGLE-USE SUTURE LIGATURES WITH DELIVERY SYSTEM

Needles Specifications	Size		Length			Color	Units Per box	Comments	Reorder code
	USP	metric	units	In.	cm				
 <p>V-20 TAPER</p> <p>1/2 26 mm</p>	0	3.5	1	48	120	Green	12	Surgiwip™ suture ligature delivery system with Surgidac™ coated braided polyester suture	EDW-50
	2-0	3	1	48	120	Green	12	Surgiwip™ suture ligature delivery system with Surgidac™ coated braided polyester suture	EDW-51
 <p>SK SKI TAPER</p> <p>23 mm</p>	0	3.5	1	48	120	Green	12	Surgiwip™ suture ligature delivery system with Surgidac™ coated braided polyester suture	EDW-52

ADDITIONAL ENDOSCOPIC SUTURE PRODUCT CODES

Needles Specifications	Size		Length			Color	Units Per box	Comments	Reorder code
	USP	metric	units	In.	cm				
 <p>CV-25 TAPER</p> <p>1/2 22 mm</p>	3-0	2	1	48	120	Violet	24	Polysorb™ coated braided synthetic absorbable suture	EL-440
	3-0	2	1	7	120	Violet	36	Polysorb™ coated braided synthetic absorbable suture	EL-415
 <p>SK SKI TAPER</p> <p>23 mm</p>	3-0	2	1	48	120	Violet	36	Polysorb™ coated braided synthetic absorbable suture	EL-450
	4-0	1.5	1	48	120	Violet	24	Polysorb™ coated braided synthetic absorbable suture	EL-451
 <p>V-20 TAPER</p> <p>1/2 26 mm</p>	2-0	3	1	48	120	Blue	36	Ti-Cron™ coated braided synthetic non absorbable suture	88863129-51
	0	3.5	1	48	120	Blue	36	Ti-Cron™ coated braided synthetic non absorbable suture	88863015-61

NEEDLE CHART

CARDIOVASCULAR

Code	Comp	Length
⊙ taper point - $\frac{3}{8}$ circle		
CV-1/CVF-1	BV-1	9 mm
CV-310	BV	10 mm
CV/CVF	BV	11 mm
CV-11/CVF-11	C-1	13 mm
CV-301	C-1*	13 mm
CV-307	BB*	16 mm
CV-15/CVF-15	BB	17 mm
CV-327	BB*	18 mm
CV-16		20 mm
CV-13	BB-1	22 mm
CV-18	TE-2	26 mm
CV-17	TE-2	32 mm
CV-19		50 mm

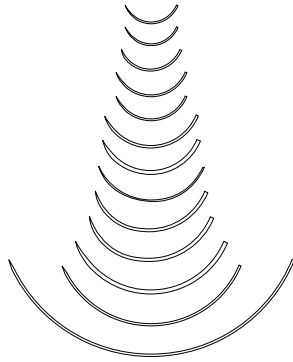

⊙ taper point - $\frac{1}{2}$ circle

CV-20	RB-3	10 mm
CV-337	RB-3	10 mm
CVF-21	TF	12 mm
CV-22/CVF-22	RB-2	13 mm
CV-330	RB-2	13 mm
CV-26	RB-1*	15 mm
CV-331	RB-1*	16 mm
CV-23/CVF-23	RB-1	17 mm
CV-316	SH-2	20 mm
CV-24	SH-2	20 mm
CV-25	SH-1	22 mm
CV-305	SH*	25 mm
V-20/VF-20	SH	26 mm
V-30		30 mm
CV-300	MH*	35 mm
V-26	MH*	37 mm

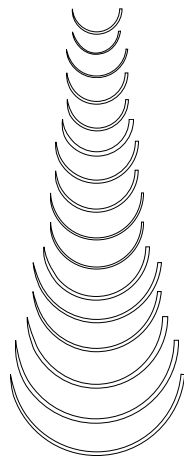

CARDIOVASCULAR

Code	Comp	Length
⊙ taper point - CardioCurve™		
CVL		11 mm
CVL-11		13 mm



⊙ penetrating taper - $\frac{3}{8}$ circle

YE-1	CC-1	13 mm
YE-7	V-4	18 mm



⊙ penetrating taper - $\frac{1}{2}$ circle

Y-31	V-5	16 mm
Y-16	V-6*	20 mm
Y-5	V-7	26 mm



⊙ tapercutting - $\frac{3}{8}$ circle

KV-1/KVF-1	CC	9 mm
KV-11/KVF-11	CC-1	13 mm
KV-15	V-4	17 mm
KV-26	V-26	26 mm

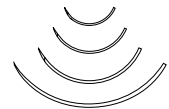

⊙ tapercutting - $\frac{1}{2}$ circle

KV-5/KVF-5	V-5	17 mm
KV-7	V-7	26 mm



▲ conventional cutting - $\frac{1}{2}$ circle

SCC	CCS	48 mm
SCC-1	CCS-1	60 mm

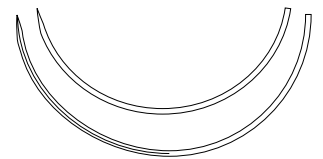

▲ conventional cutting - $\frac{3}{8}$ circle

GCC-90	90 mm
--------	-------

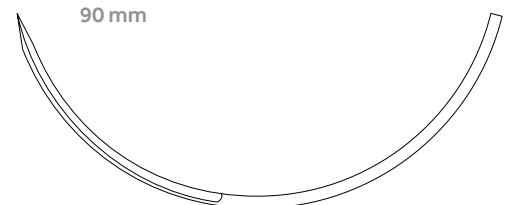

PLASTIC/COSMETIC

Code	Comp	Length
------	------	--------

▲ premium conventional cutting - 3/8 circle

PC-13	P-1	11 mm	
PC-10	PC-1	13 mm	
PC-11	PC-3	16 mm	
PC-12	PC-5	19 mm	

▼ premium reverse cutting - 3/8 circle

P-16	P-6	7 mm	
P-10	P-1	11 mm	
P-13	P-3	13 mm	
P-15		15 mm	
P-11	PS-3	16 mm	
P-12	PS-2	19 mm	
P-14	PS-1	24 mm	
P-17	PSL	30 mm	
P-18	PSLX	39 mm	

▼ premium reverse cutting - 1/2 circle

P-21	P-2	9 mm	
P-22	PS-5	13 mm	
P-24	PS-4*	16 mm	

◆ DermaX™ premium X cutting · 3/8 circle

DX-11		11 mm	
DX-13		13 mm	
DX-16		16 mm	
DX-19		19 mm	

◆ DermaX™ premium X cutting · 1/2 circle

DXH-16		16 mm	1/2
--------	--	-------	-----

CUTICULAR

Code	Comp	Length
------	------	--------

▼ reverse cutting - 3/8 circle

C-1	C-2*	12 mm	
C-12	FS-3	16 mm	
C-13	FS-2	19 mm	
C-14	FS-1	24 mm	
C-15	FS	26 mm	
C-16	FSL	30 mm	
C-18		35 mm	
C-17	FSLX*	39 mm	
C-50	LS-1*	50 mm	
GS-18	LS-1*	77 mm	

▼ reverse cutting - 1/2 circle

C-21	M-1*	13 mm	
C-26	J-1*	15 mm	
C-22	J-1	18 mm	
C-27		20 mm	
C-23	X-1*	24 mm	
C-25	CP-2*	30 mm	

▲ cutting - straight

SC-11	SC-1*	11 mm	
SC-4		24 mm	
SC		44 mm	
SC-1	TS*	51 mm	
SC-2	KS	60 mm	
SC-250		254 mm	

*Suggested

GENERAL SURGERY

Code	Comp	Length
⊙ taper point - ½ circle		
GS-23	CT-3	22 mm
HGS-23	MO-7	22 mm
GS-22	CT-2	27 mm
HGS-22	MO-6	27 mm
GS-20	CT-1*	34 mm
HGS-20	MO-5*	34 mm
GS-21	CT-1	37 mm
HGS-21	MO-4	37 mm
GS-24	CT	40 mm
HGS-24	MO-2	40 mm
GS-25	CTX	48 mm
GS-26	TP-1	65 mm
GS-27	XLH	76 mm

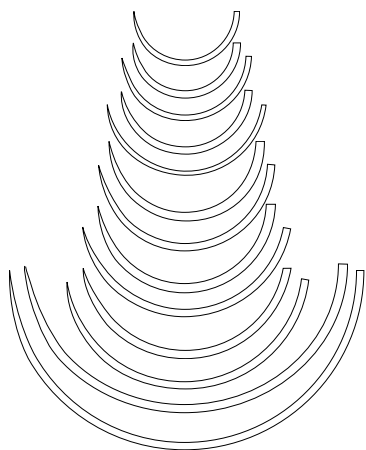

⊙ taper point - straight

ST-4	ST-4	19 mm	
ST-3		38 mm	
ST-2		44 mm	
ST-1	ST	51 mm	
ST		60 mm	

⊙ taper point - ski

SK		23 mm	
----	--	-------	--

● blunt taper point - Protect•Point™ - ½ circle

BTV-20	SHB	26 mm
BGS-21	CTB-1	37 mm
HBSG-21	MOB-4	37 mm
BTP-1	CTB-1	37 mm
BGS-24		40 mm
BGS-25	CTX-B	48 mm
BTP-X	CTX-B	48 mm
BGS-29	BP-1	65 mm
BGST-29	BP-1	65 mm
BGS-28	BP*	85 mm

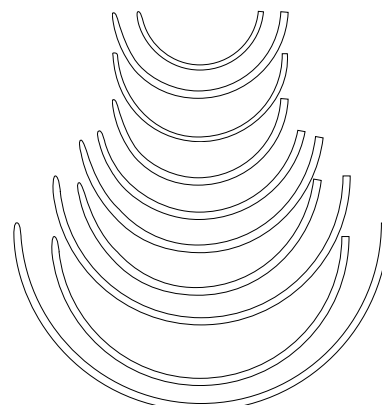

● blunt point - Protect•Point™ - ½ circle

BP-27		64 mm	
-------	--	-------	--

⊙ diamond point - ⅓ circle

KV-20		20 mm	
-------	--	-------	--

GENERAL SURGERY

Code	Comp	Length
⊙ diamond point - ½ circle		
KV-25		22 mm
KV-30		27 mm
KV-8		30 mm
KV-9		35 mm

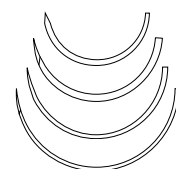

⊙ tapercutting - ½ circle

KV-34	V-34	37 mm
KV-37	V-37	40 mm
KV-40	V-40	48 mm
KV-56	V-56	60 mm

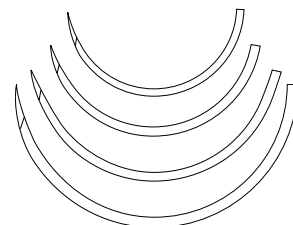

MICROSURGERY

Code	Comp	Length
⊙ taper point - ⅓ circle		
MV-100-3	BV-100-3	4 mm
MV-50-3	BV-50-3	4 mm
MV-70-3	BV-75-3	4 mm
MV-135-3	BV-130-3*	4 mm
MV-70-4	BV-75-4	5 mm
MV-135-4	BV-130-4*	5 mm
MV-100-4	BV-100-4	5 mm
CV-345	BV-130-5	6 mm
MVF-135-5	BV-130-5	6 mm
MV-135-5	BV-130-5	6 mm
CV-351	BV-175-6	8 mm
MV-175-8	BV-175-6	8 mm
MVF-175-8	BV-175-6	8 mm
MV-175-9	BV-175-8	10 mm

⊙ tapercutting - ⅓ circle

MVK-70-3	BV-75-3	4 mm
MVK-100-4	BV-100-4	5 mm

UROLOGY

Code	Comp	Length
⊙ taper point - ⅓ circle		
GU-46	UR-6	27 mm
HGU-46	UR-6	27 mm
GU-45	UR-5	37 mm
GU-44	UR-4	40 mm

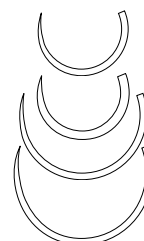

ORTHOPEDIC

Code	Comp	Length
------	------	--------

▼ reverse cutting - 3/8 circle

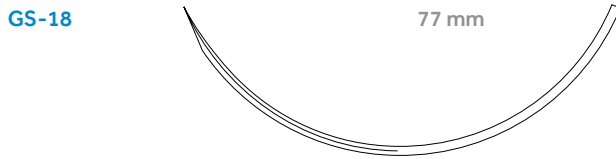

▼ reverse cutting - 1/2 circle

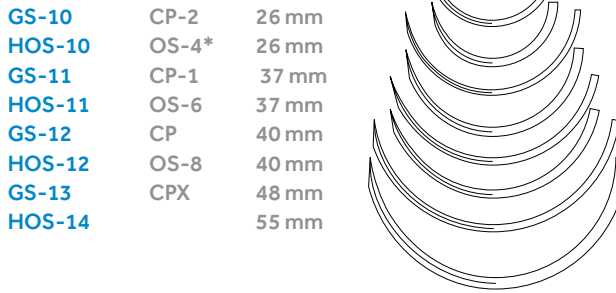

🔪 tapercutting - straight



*Suggested

MULTI-PURPOSE

Code	Comp	Length
------	------	--------

🔪 multi-purpose - 3/8 circle



🔪 multi-purpose - 1/2 circle

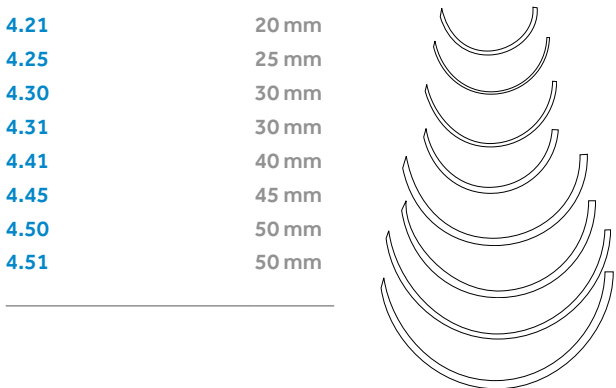

🔪 multi-purpose - 3/4 circle

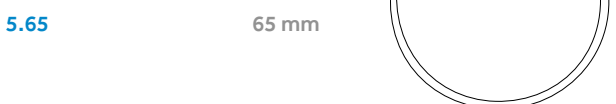

OPHTHALMIC

Code	Length	Curvature	Comp
------	--------	-----------	------

▼ reverse cutting - 3/8 circle

HE-10	5.6 mm	130°	G-6° 110°	
HE-6	7.4 mm	110°	G-6° 110°	
HE-7	7.4 mm	145°	G-7° 165°	
HE-5	8.6 mm	135°		
HE-1	11.0 mm	135°	G-1° 135°	
HE-3	13.0 mm	155°	G-3° 155°	

▼ reverse cutting - 1/2 circle

HE-2	8.6 mm	205°	G-2° 180°	
------	--------	------	-----------	--

🔪 inverted premium spatula - 1/4 circle

SS-29	7.4 mm	110°	S-29° 110°	
-------	--------	------	------------	--

🔪 inverted premium spatula - 3/8 circle

SS-28	7.4 mm	145°	S-28° 163°	
-------	--------	------	------------	--

🔪 premium spatula - 1/8 circle

SS-1	5.6 mm	60°	SM-1° 60°	
------	--------	-----	-----------	--

🔪 premium spatula - 1/4 circle

SE-100-8	6.3 mm	100°	TG-100-8 97°	
SD-1	8.1 mm	90°	RD-1 90°	
SS-24	8.6 mm	95°	S-24 90°	
SS-14	8.6 mm	115°	S-14 112°	

🔪 premium spatula - 5/16 circle

SE-110-11	8.0 mm	110°	S-29° 110°	
-----------	--------	------	------------	--

(previously SLO-110-11)

🔪 premium spatula - 3/8 circle

SE-140-6	6.3 mm	140°	TG-140-6/CS-140-6 140°	
SE-140-8	6.3 mm	140°	TG-140-8/CS-140-8 140°	
SE-140-9	6.5 mm	140°	TG-140-8 137°	

🔪 premium spatula - 1/2 circle

SE-160-4	5.5 mm	160°	TG-160-4/CS-160-4 160°	
SE-160-6	5.5 mm	160°	TG-160-6/CS-160-6 160°	
SE-160-8	5.5 mm	160°	TG-160-8/CS-160-8 160°	
SE-160-9	5.5 mm	160°	TG-160-8/CS-160-8 160°	
SE-175-6	7.0 mm	175°	TG-175-6/CS-175-6 175°	
SE-175-8	6.9 mm	175°	TG-175-8/CS-175-8 175°	
SS-22	7.4 mm	170°	S-22 170°	
SS-2	8.6 mm	200°	S-2 180°	

🔪 premium spatula - compound curve

SE-CC-6	4.8 mm	130°	TG6-S	
---------	--------	------	-------	--

ORDERING INFORMATION

Velosorb™ Fast

CV-8977	8	CV-485	10	SV-9944G	13
CV-8643	8	CV-486	10	CV-9916G	13
CV-8978	8	SV-9913	11	CV-1213	13
CV-8644	8	SV-32	11	CV-1214	13
CV-8979	8	SV-4893	11	CV-1215	13
CV-8653	8	SV-9915	11	CV-3100	13
CV-8980	8	SV-493	11	CV-3110	13
SV-2289	8	SV-494	11	CV-3120	13
SV-1290	8	SVP-494	11	CV-415	14
SV-2290	8	SVP-2296	11	CV-416G	14
SV-2296	8	SVP-2294	11	CV-417G	14
SV-2294	8	SVP-2295	11	CV-418	14
SV-2295	8	SV-496G	11	CV-55	14
SV-2910	9	SV-496	11	CV-56	14
SV-2920	9	SV-426	11	CV-57	14
SV-2297	9	SV-412	11	CV-318	14
SV-2930	9	SV-497G	11	CV-319	14
SV-2298	9	SV-425	11	CV-9975G	14
SV-2299	9	SV-424	11	CV-322	14
SV-2251	9	SVP-2251	11	CV-944	14
SV-4431	9	SV-6830	11	CV-323	14
SV-2252	9	SV-935	11	CV-945	14
SV-2253	9	SV-6840	11	CV-1324	14
SV-9940G	9	SV-439	11	CV-946	14
SV-9941G	9	SVP-2285	11	CV-947	14
SV-2285	9	SV-9910G	12	CV-9592	15
SV-2286	9	SV-9911G	12	CV-9591	15
SV-2287	9	SV-834G	12	CV-9590	15
SV-9961G	9	SV-835G	12	CV-606	15
SV-4550	10	SV-489G	12	CV-604	15
SV-9926	10	SV-844G	12	CV-605	15
SV-9927	10	SV-845G	12	UV-412	15
SV-9928	10	SV-488G	12	UV-401	15
CV-9936G	10	SV-487G	12	UV-1381	15
CV-931G	10	SV-9909G	12	UV-1382	15
CV-4721	10	SV-2238	13	CV-1673	15
CV-932G	10	SV-2239	13	CV-2293	16
CV-4731	10	SV-2240	13	CV-2275G	16
		SV-9943	13	CV-2279	16

CV-2280	16	L-27	20	LL-116	22
CV-1674G	16	L-24	20	LL-226	22
CV-2003G	16	L-14	20	L-1551-K	23
CV-1002	16	L-34	20	SL-171	23
CV-916	16	L-404	20	SL-172	23
CV-917	16	L-40	20	L-4323K	23
CV-927	16	L-75	20	SL-630	24
CV-919	16	L-5	20	SL-607	24
CV-918	16	L-35	20	SL-605	24
CV-0146	16	L-25	20	SL-608	24
Episiotomy set	16	L-15	20	SL-639	24
CV-2218	17	L-36	20	SL-634	24
CV-2217	17	L-41	21	SL-690	24
CV-2216	17	L-405	21	SL-638	24
CV-0046	17	L-76	21	SL-691G	24
Episiotomy set	17	L-28	21	SL-691	24
CV-7192	17	L-26	21	SL-635G	24
CV-7191	17	L-42	21	SL-635	24
CV-7190	17	L-406	21	SL-637	24
CV-9953	17	L-111	21	SL-822	24
CV-501G	17	L-102	21	SL-822G	24
CV-500G	17	L-112	21	SL-636	24
		L-103	21	SL-695	24
Polysorb™	²	L-113	21	SL-692	24
L-71	20	L-114	21	SL-693	24
L-20	20	L-104	21	SL-694	24
L-11	20	L-116	21	SL-823	24
L-1-	20	L-115	21	CL-823	24
L-72	20	LL-111	22	SL-73-MG	24
L-22	20	LL-101	22	SL-586	24
L-2-	20	LL-221	22	SL-587	24
L-12	20	LL-112	22	SL-696	25
L-32	20	LL-102	22	SL-714	25
L-402	20	LL-322	22	SL-611	25
L-38	20	LL-222	22	SL-713	25
L-73	20	LL-113	22	SL-610	25
L-3	20	LL-103	22	SL-712	25
L-23	20	LL-323	22	CL-976	25
L-13-	20	LL-223	22	CL-977	25
L-33	20	LL-233	22	SL-674	25
L-43	20	LL-114	22	SL-675	25
L-403	20	LL-104	22	CL-85	25
L-39	20	LL-224	22	SL-85-MG	25
L-74	20	LL-115	22	SL-83-MG	25
L-4	20	LL-225	22	SL-632	25

SL-613	25	CL-537	27	SL-5621	29
SL-631	25	CL-538	27	SL-5636-G	29
SL-612	25	CL-528	27	SL-5636	29
CL-53MG	25	CL-833	27	SL-5629	29
CL-868	25	CL-595	27	SL-5627-G	29
CL-52-MG	25	CL-804	27	SL-5627	29
CL-869	25	CL-596	27	SL-5637	29
CL-769	25	CL-933	27	SL-5628G	29
CL-870	25	CL-805	27	SL-5628	29
CL-867	25	CL-597	27	SL-5638	29
CL-356-MG	26	CL-936	27	SL-5641G	30
CL-354-MG	26	CL-937	27	SL-5641	30
CL-55-MG	26	CL-382-MG	27	SL-5678	30
CL-355-MG	26	CL-380-MG	27	SL-5640G	30
CL-358-MG	26	CL-376-MG	27	SL-5640	30
CL-581	26	CL-381-MG	27	SL-5679G	30
CL-547	26	CL-377-MG	27	SL-5679	30
CL-552	26	CL-97-MG	27	SL-5680	30
SL-622	26	CL-383-MG	27	SL-1596	30
SL-721	26	CL-568	28	SL-1510G	30
SL-722	26	CL-554	28	SL-1644G	30
CL-815	26	CL-927	28	SL-1645G	30
CL-542	26	CL-569	28	SL-1613	30
CL-816	26	CL-555	28	SL-1614	30
CL-543	26	CL-928	28	SL-1614G	30
CL-916	26	CL-570	28	SL-1615	30
CL-817	26	CL-939	28	SL-5632G	30
CL-544	26	CL-929	28	SL-5632	30
CL-917	26	CL-979	28	SL-5633G	30
CL-534	26	SL-1624G	28	SL-5633	30
CL-818	26	SL-1625	28	SL-1660	31
CL-545	26	SL1625G	28	SL-1659	31
CL-918	26	SL-1689	28	SL-1658	31
CL-535	26	SL-1689G	28	SL-1655G	31
CL-919	26	SL-5688	29	SL-1656	31
CL-533	26	SL-5688-G	29	SL-1657	31
CL-982	26	SL-5687G	29	SL-1653	31
CL-992	26	SL-5687	29	SL-1654	31
CL-374-MG	27	SL-5691G	29	SL-654	31
CL-369-MG	27	SL-5690	29	SL-644	31
CL-526	27	SL-5626	29	SL-653	31
CL-536	27	SL-5686	29	SL-643	31
CL-375-MG	27	SL-5686G	29	SL-652	31
CL-370-MG	27	SL-5620	29	SL-642	31

L-2800	32	GL-192	34	CL-886-M	36
GL-889-2	32	GL-182-M	34	CL-884	36
GL-890	32	EL-440	34	CL-831	36
GL-881	32	GL-32-MG	34	CL-330	36
GL-882	32	GL-183	34	CL-885	36
CL-304	32	GL-282	34	CL-885-M	36
GL-303	32	CL-892	34	CL-832	36
GL-302	32	CL-42-MG	34	CL-331	36
CL-457	32	CL-893	34	CL-232	36
GL-522	32	CL-894	34	GL-222	36
GL-523	32	GL-120	35	GL-223	36
GL-524	32	GL-64-MG	35	GL-228	36
UL-102	33	GLS-321	35	GL-223-M	36
UL-101	33	GLS-121	35	GL-224	36
SL-432	33	GL-68-M	35	GL-225	36
SL-431	33	GL-321	35	CL-809	37
GL-45-MG	33	GL-121	35	CL-8-MG	37
GL-885	33	GL-69-MG	35	CL-842	37
GL-44-MG	33	GL-63-MG	35	CL-810	37
GL-884	33	GLS-322	35	CL-922	37
CL-782	33	GLS-122	35	CL-952	37
UL-201-2	33	GL-67-M	35	CL-9-MG	37
UL-202	33	GL-322	35	CL-13-MG	37
UL-213	33	GL-122	35	CL-843	37
GL-46-MG	33	GL-226	35	CL-811	37
UL-303	33	GL-62-MG	35	CL-4M	37
UL-212	33	GL-61-MG	35	CL-923	37
UL-47-MG	33	GLS-323	35	CL-953	37
GL-47-MG	33	GLS-123	35	CL-14-MG	37
UL-204	33	GL-66-M	35	CL-10-MG	37
UL-215	33	GL-323	35	CL-844	37
UL-216	33	GL-123	35	CL-812	37
UL-205	33	GL-125	35	CL-5-M	37
UL-214	33	GL-324	35	CL-2M	37
UL-203	33	GL-124	35	CL-812	37
CL-219	33	GL-332	35	CL-954	37
CL-460	34	GL-333	35	CL-924	37
CL-461	34	CL-882	36	CL-15-MG	37
CL-462	34	CL-829	36	CL-11-MG	37
GL-34-MG	34	CL-16-MG	36	CL-845	37
GL-181	34	CL-830	36	CL-813	37
GL-191	34	CL-883	36	CL-6-M	37
GL-33-MG	34	CL-17-MG	36	CL-925	37
GL-182	34	CLS-884	36	CL-955	37

CL-814	37	CL-644-M	39	CL-871-L	42
CL-926	37	CL-866	39	CL-576	42
GL-126	38	CL-665-M	39	CL-677	42
GL-127	38	CL-906	39	UL-676	42
GL-128	38	CL-63	39	CL-510	42
GL-129	38	CL-60-M	39	CL-511	42
CL-800	38	CL-968	39	CL-942	42
CL-962	38	CL-824	39	CL-837	42
CL-912	38	CL-659-M	39	CL-943	42
CL-22-MG	38	CL-969	39	CL-946	42
CL-853	38	CL-880	39	CL-838	42
CL-801	38	CL-825	39	CL-515	42
CL-913	38	CL824L	40	CL-944	42
CL-963	38	CL-835-L	40	CL-839	42
CL-20-MG	38	CL-53	40	CL-516	42
CL-802	38	SL-603	40	CL-945	42
CL-914	38	UL-879	40	CL-517	42
CL-964	38	UL-878	40	CL-603	43
CL-21-MG	38	UL-877	40	CL-602	43
CL-803	38	UL-876	40	CL-739	43
CL-855	38	UL-240	40	CL-840	43
CL-915	38	UL-245	40	CL-940	43
CL-965	38	UL-246	40	CL-841	43
CL-623-M	38	UL-146	40	CL-941	43
CL-622-M	38	EL415	41	CL-740-L	43
CL-779	38	EL450	41	CL-741-L	43
CL-911	38	CL-673G	41	GLT-69-MG	43
CL-990	38	CL-673	41	CL-956	43
CL-862	39	CL-86-MG	41	CL-259	43
CL-972	39	CL-87-MG	41	CL-250-M	43
CL-36-MG	39	CL-871	41	CL-240-M	43
CL-863	39	CL-996-MG	41	CL-957	43
CL-973	39	CL-997-MG	41	CL-958	43
CL-903	39	CL-998-MG	41	CLT-952	44
CL-35-MG	39	CL-202-M	41	CLT-9-MG	44
CL-30-MG	39	CL-930	41	CLT-13-MG	44
CL-864	39	CL-970	41	CLT-259	44
CL-974	39	CL-200-M	41	CLT-953	44
CL-904	39	CL-931	41	CLT-250-MG	44
CL-31-MG	39	CL-71-M	41	CLT-957	44
CL-865	39	CL-971	41	CLT-954	44
CL-64-M	39	CL-201-M	41	CLT-15-MG	44
CL-975	39	CL-932	41	CLT-11-MG	44
CL-905	39	CL-239	41	CLT-958	44
CL-633-M	39	CL-934	41	CLT-955	44

CL-950	44	L-1562-K	48	SC-542	55
CL-951	44	L-2574K	49	SC-644	55
CLT-850-MG	44	L-2749K	49	SC-643	55
CLT-20-MG	44	L-1787K	49	XC-834	55
CLT-851-MG	44	L-0223K	49	XC-844	55
CLT-21-MG	44			XC-845	55
CLT-855	44	Caprosyn™		XC-823	56
CLT-623-M	44	C-212	52	UC-202	56
CL-948	45	C-214	52	UC-203	56
CL-949	45	SC-3634	52	UC-214	56
2-CL-852	45	SC-690G	52	UC-213	56
CL-271	45	SC-691	52	UC-204	56
CL-270	45	SC-694G	52	UC-403	56
CLT-633-M	45	SC-692	52	GC-33-M	56
CL-513	46	SC-693	52	UC-404	56
CL-730	46	SC-693G	52	UC-863	56
CL-005	46	SC-587	52	GC-321	57
CL-015	46	SC-586	52	GC-121	57
CL-030	46	SC-585	52	GC-122	57
CL-045	47	CC-543	53	GC-322	57
UL-046	47	CC-983	53	GC-123	57
CL-047	47	SC-3625G	53	GC-323	57
CL-055	47	SC-3626G	53	GC-124	57
CL-060	47	SC-5688G	53	CC-883	57
L-1750K	47	SC-5588G	53	CC-830	57
L-1756K	47	SC-5689G	53	CC-884	57
L-1755K	47	SC-5587G	53	CC-831	57
L-1791K	48	SC-5690G	53	CC-885	57
L-1670-K	48	SC-5590G	53	CC-810	57
L-1792K	48	SC-5635G	54	CC-922	57
L-1669-K	48	SC-5626G	54	CC-843	57
L-1740-K	48	SC-5626	54	CC-811	57
L-1742K	48	SC-5686G	54	CC-923	57
L-1745K	48	SC-5616G	54	CC-844	57
L-2752K	48	SC-5617G	54	CC-812	57
L-1739-K	48	SC-5627G	54	CC-924	57
L-1785K	48	SC-5637-G	54	CC-845	57
L-2753K	48	SC-5618G	54	CC-813	57
L-2750K	48	SC-5638-G	54	CC-925	57
L-2751K	48	SC-5679	54	CC-801	58
L-2747K	48	SC-5779	54	CC-915	58
L-2748K	48	SC-5640	54	CC-802	58
L-5118K	48	SC-5780G	54	CC-913	58
L-1796K	48	SC-5643G	54	CC-803	58
L-1897K	48	SC-543	55	CC-914	58

CC-872	58	SM-5624	64	GM-322	68
CC-904	58	SM-5627	64	GM-123	68
CC-975	58	SM-5637	64	GM-323	68
CC-905	58	SM-5628	64	GM-125	68
UC-879	58	SM-5638	64	GM-421	68
UC-978	58	SM-5679	65	GM-432	68
CC-658	58	SM-5678	65	GM-332	68
CC-1945G	59	SM-5679G	65	CM-882	68
CC-196	59	CM-401	65	CM-883	68
		CM-400	65	CM-830	68
Biosyn™		SM-644	65	CM-884	68
M-31-	62	SM-643	65	CM-831	68
M-72	62	XM-834	66	CM-832	68
M-32-	62	XM-845	66	GM-222	68
M-33-	62	XM-822	66	GM-223	68
M-23-	62	XM-823	66	GM-326	68
M-74	62	SM-432	66	GM-327	68
M-75	62	SM-431	66	GM-226	69
M-114	62	SM-434	66	GM-227	69
SM-690	62	CM-126	66	CM-738-M	69
SM-791	62	UM-986	67	CM-842	69
SM-691G	62	UM-886	67	CM-810	69
SM-691	62	GM-875	67	CM-922	69
SM-822	62	UM-201	67	CM-9M	69
SM-922	62	UM-202	67	CM-843	69
SM-693	63	UM-213	67	CM-811	69
SM-923	63	UM-214	67	CM-953	69
SM-823	63	UM-203	67	CM-923	69
SM-633	63	UM-215	67	CM-14-M	69
SM-83-M	63	UM-204	67	CM-10-M	69
SM-632	63	UM-403	67	CM-844	69
CM-879	63	CM-208	67	CM-812	69
CM-816	63	GM-34-M	67	CM-924	69
CM-543	63	GM-181	67	CM-954	69
CM-817	63	GMJ33M	67	CM-11-M	69
CM-544	63	GM-324	67	CM-845	69
CM-991	63	GM-183	67	CM-813	69
CM-932	63	GM-281	67	CM-925	69
CM-528	63	GM-291	67	CM-962	70
CM-222	64	GM-282	67	CM-801	70
SM-3625	64	GM-121	68	CM-914	70
SM-3626	64	GM-321	68	CM-964	70
SM-5688	64	GM-69-M	68	CM-966	70
SM-5687	64	GM-122	68	CM-765-L	70
SM-5690	64	GM-67-M	68	CM-767-L	70

CM-903	70	8886660831	78	8886614501	83
CM-974	70	8886663931	78	8886613901	83
CM-904	70	8886661231	78	8886612701	83
CM-31-M	70	8886660841	78	8886613911	83
CM-975	70	8886663941	78	8886612711	83
CM-905	70	8886661241	78	8886611511	83
CM-790L	70	8886661831	79	8886614811	83
CM-776L	70	8886661841	79	8886614821	83
CM-779L	70	8886664141	79	8886612111	83
CM-780L	70	8886664151	79	8886614711	83
UM-879	71	8886661851	79	8886612411	83
UM-978	71	8886662651	79	8886616523	83
UM-878	71	88866605941	79	8886614721	83
UM-877	71	8886674441	79	8886612421	83
UM-977	71	CMM-435-MG	79	8886612821	83
CM-558	71	8886674551	79	8886605731	83
UM-345	71	8886674451	79	8886646221	83
UM-245	71	88866751-71	79	8886646231	83
UM-243	71	8886675551	80	8886600111	84
UM-383	71	8886675561	80	8886621311	84
CM-90-M	72	8886675571	80	8886621321	84
CM-436	72	88866757-71	80	8886620133	84
CM-827	73	8886678771	80	8886621331	84
CM-740L	73	8886676971	80	8886613211	84
GMT-226	74	8886653311	81	8886612221	84
CMT-811	74	8886653211	81	8886620721	84
CMT-740-M	74	8886653221	81	8886620731	84
CMT-812	74	SMM-5516	81	8886620741	84
CMT-967	74	SMM-5526	81	8886614921	84
CMT-741-M	74	SMM-5536	81	8886613431	84
CM-951	74	SMM-5221	81	8886621721	84
CM-949-M	74	SMM-5431	81	8886621933	84
CMT-950-M	75	SMM-5042	81	8886621731	84
CMT-974	75	SMM-5043	81	8886621943	84
CMT-949-M	75	SMM-5033	81	8886621741	84
CMT-789-L	75	SMM-5323	81	8886622131	84
		SMM-5044	81	8886603641	84
Maxon™		8886663241	81	8886622933	85
8886600741	78	SMM-5241	81	8886603433	85
8886600751	78	8886662451	81	8886623331	85
8886601563	78	88866704-23	82	8886622943	85
8886660521	78	SMM-5831	82	8886623341	85
8886660531	78	8886690831	82	8886623241	85
8886611831	78	8886690841	82	8886603443	85
8886660821	78	8886639053	82	8886622953	85

8886623351	85	GMM-341L	87	SP-661G	96
8886623131	85	GMM-343L	87	SP-683	96
8886623531	85	GMM-344L	87	SP-683G	96
8886614331	85	8886640351	87	SP-665G	96
8886623541	85	8886640451	87	SP-665	96
8886624541	85	8886623741	88	SP-655	96
8886624753	85	8886623761	88	SP-629	96
8886624551	85	8886624961	88	SP-684	96
8886624561	85	8886633961	88	SP-684G	96
8886624571	85	88866339-71	88	SP-868G	97
8886626131	85	8886645561	88	SP-868	97
8886626141	85	8886645661	88	SP-685	97
8886626151	85	8886641971	88	SP-670	97
8886626161	85	88866768-11	89	SP-675	97
8886626741	86	88866297-11	89	SP-624-BC	97
8886627553	86	88866297-21	89	SP-649	97
8886626751	86	88866288-11	89	SP-689	97
8886626951	86	88866288-21	89	SP-690	97
GMM-951	86	VMM-137	89	CP-460	98
8886627563	86	88866292-51	89	3-CP-360	98
8886626761	86	8886627761	89	CP-443	98
8886626961	86	GMM-873L	90	CP-453	98
8886627573	86	8886629571	90	SP-1696G	99
8886626771	86	GMM-806L	90	SP-1696	99
8886626971	86	GMM-807L	90	SP-1697	99
8886625741	86	GMMT-951	90	SP-1606	99
8886625751	86	GMMT-563-MG	90	SP-5697G	99
8886625761	86	GMMT-961	90	SP-2698G	99
8886628751	86	GMMT-541-MG	91	SP-5695-G	99
8886628561	86	GMMT-540-MG	91	SP-5695	99
8886628761	86	GMMT-89L	91	SP-5698-G	99
8886628571	86	GMMT-90L	91	SP-5698	99
8886628771	86	8886606163	91	SP-5699G	99
GMM-563L	86	8886606173	91	SP-5699	99
GMM573L	86	8886606773	91	SP-5680G	99
8886631163	87	GMM-496L	92	SP-5681G	99
8886630761	87	GMM-497L	92	SP-5681	99
8886631173	87	8886662801	92	SP-5692G	99
8886630771	87			SP-1693G	99
8886630972	87	Surgipro™ / Surgipro™ II		SP-5686G	99
GMM-634L	87	SP-660G	96	SP-5686	99
GMM-632L	87	SP-660	96	SP-5682G	99
8886631962	87	SP-559G	96	SP-5682	99
8886632271	87	SP-631	96	SP-5687	99
8886631972	87	SP-661	96	SP-5687G	99

SP-5587	99	VP-738-MX	103	VP-726-MX	104
SP-5663G	99	VP-630-X	103	VP-726-X	104
SP-5563	99	VP-631-X	103	VP-76-MX	104
SP-1617	100	VP-72-X	103	VP-76-X	104
SP-1618	100	VP-72-MX	103	VP-78-X	105
SP-1636	100	VP-37-MX	103	VP-705-MX	105
SP-1635	100	VP-701-X	103	VP-705-X	105
SP-1634	100	VP-701-MX	103	VP-70-X	105
SP-1644	100	VP-702-X	103	VP-719-X	105
SP-1643	100	VP-702-MX	103	VP-720-X	105
SP-621	100	VP-713-X	103	VP-725-MX	105
SP-622	100	VP-713-MX	103	VP-725-X	105
SP-622-BC	100	VP-746-X	103	VP-75-X	105
SP-623-BC	100	VP-746-MX	103	VP-719-MX	105
SP-623	100	VP-703-X	103	VP-897-M	105
SP-8656G	100	VP-703-MX	103	VP-720-MX	105
P-2790G	101	VP-709-MX	103	VP-813-X	105
P-2794G	101	VP-709-X	103	VPF-726-X	105
P-2795G	101	VP-365-X	103	VP-126-MX	105
VP-900-X	101	VP-73-X	103	VPF-706-X	105
VP-901-MX	101	VP-73-MX	103	VPF-720-X	105
VP-900-MX	101	VP-102-MX	103	VP-120-MX	105
VP-902-X	101	VPF-702-X	103	VP-86-X	105
VP-903-MX	101	VPF-713-X	103	VP-881-X	105
VP-902-MX	101	VPF-703-X	103	VP-570X	105
VP-973-X	101	VPF-709-X	103	VP-580-X	105
VP-904-X	101	VPF-703-MX	103	VP-584-X	105
VP-904-MX	101	VP-763-X	104	VP-582-X	105
VP-209MX	102	VP-875-MX	104	VP-581-X	105
VP-744-X	102	VP-875-X	104	VP-583-X	105
VP-744-MX	102	VP-759-MX	104	VP-585-X	105
VP-745-X	102	VP-74-X	104	VP-841-X	105
VP-743-MX	102	VP-776-X	104	VP-851-X	105
VP-753-MX	102	VPF-776-X	104	VP-532-X	105
VP-736-M	102	VP-652-MX	104	VP-533	105
VP-628	102	VP-889-X	104	VP-772-X	106
VP-734-MX	102	VP-890-X	104	VP-754-X	106
VP-735-X	102	VP-812-X	104	VP-755-X	106
VP-737-MX	102	VP-727-X	104	VP-854-X	106
VP-735-MX	102	VP-800-X	104	VPF-610-X	106
VP-747-X	102	VP-363X	104	VP-714-X	106
VP-747-MX	102	VP-706-MX	104	VP-711-X	106
VPF-738-MX	102	VP-706-X	104	VP-733-MX	106
VPF-735-X	102	VP-718-MX	104	VP-733-X	106
VP-738-X	103	VP-718-X	104	VP-715-X	106

VP-205-X	106	VPF354X	108	VP-708-X	111
VP-710-MX	106	VPF-521-X	108	VP-751-X	111
VP-710-X	106	VPF-522-X	108	VPF-728-X	111
VP-204-X	106	VPF-354-X	108	VP-941-X	112
VPF-733-X	106	VPF-543	108	VP-942-X	112
VPF-710-X	106	CP-16-M	108	VP-914-X	112
VPF-711-X	106	CP-411	108	VP-924-X	112
VP-972X	106	CP-17-M	108	VP-925-X	112
VP-870-X	106	CP-412	108	VP-926-X	112
VP-871-X	106	VP-945	109	VP-965	112
VP-872-X	106	CP-422	109	VP-956	112
VP-555X	107	CP-423	109	VP-934-X	112
VP-660-X	107	CP-10-M	109	VP-935-X	112
VP-556X	107	CP-424	109	VP-435-X	112
VP-566X	107	CP-425	109	VP-936-X	112
VP-556MX	107	VP-842-X	109	VP-937	112
VPP-557-X	107	VP-843	109	VP-975-X	112
VP-557MX	107	VP-853	109	VP-976-X	112
VP-757-X	107	CP-433	109	VP-986-X	112
VP-557X	107	CP-434	109	VP-977	112
VP-558X	107	CP-435	109	VP-978	112
VP-559-X	107	CP-535	109	CP-844	112
VPF-557-X	107	CP-30-M	109	CP-845	112
VP-331X	107	CP-454	109	CP-957	113
VP-771-X	107	CP-455	109	CP-836	113
VP-761-X	107	3CP-444	109	P-2771K	113
VP-761-MX	107	CP-824	109	P-2756K	113
VP-760-X	107	CP-825	109		
VP-762-X	107	CP-824-L	110		
VP-831X	108	CP-834-L	110	Ti-Cron™ / Surgidac™	
VP-832X	108	GP-282	110	88863008-21	116
VP-833	108	CP-92-M	110	88863008-31	116
VP-834	108	CP-414	110	88863003-32	116
VP-510X	108	CP-415	110	88863008-41	116
VP-520X	108	VP-721-MX	111	88863001-41	116
VP-511-X	108	VP-704-X	111	88863003-42	116
VP-621-X	108	VP-704-MX	111	88863011-51	116
VP-521-X	108	VP-712-X	111	88863008-51	116
VP-421X	108	VP-712-MX	111	88863003-52	116
VP-541X	108	VPF-704-X	111	88863001-62	116
VP-522-X	108	VPF-807-X	111	88863002-62	116
VP-422X	108	VP-911-X	111	88863001-72	116
VP-542-X	108	VP-707-X	111	88863380-42	116
VP-523	108	VP-728-X	111	88863380-52	116
VP-543	108	VP-728-MX	111	88863380-62	116
				88863380-72	116

88863380-82	116	SCD-3049G	119	88863086-56	122
88863381-09	116	88862854-33	120	88863083-56	122
88863381-89	116	88863109-43	120	88863084-56	122
88863045-21	117	88863059-53	120	88863091-56	122
88863046-31	117	88863127-79	120	88863087-51	122
88863047-31	117	88863163-51	120	88863273-56	122
88863047-41	117	88863163-61	120	88863269-56	122
88863055-41	117	88863163-71	120	VCD20331FE	122
88863048-51	117	88863062-41	120	88863267-42	123
88863069-41	117	88863062-51	120	88863348-31	123
88863050-41	117	88863165-51	120	88863369-31	123
88863050-51	117	88863062-61	120	88863227-41	123
88863065-51	117	88862947-53	120	88863369-41	123
88863050-61	117	88863288-01	121	88863385-56	123
88863065-61	117	88863106-31	121	88863227-51	123
88863070-51	117	88863280-11	121	88863348-51	123
88863023-51	117	88863314-21	121	88863323-56	123
88863023-61	117	88863280-21	121	88862978-51	123
88863012-61	117	88862801-21	121	88863277-56	123
88863023-71	117	88863314-31	121	VCD20316MFE	123
88863054-51	118	88863280-31	121	VCD20316MSE	123
88863054-61	118	88863280-41	121	VCD20316FE	123
88863054-71	118	8886263656	121	VCD20316SE	123
88863054-81	118	88862775-21	121	88863344-56	123
88863056-89	118	88862775-31	121	88862839-51	123
88863128-79	118	88862775-41	121	88863369-51	123
88863128-82	118	88862627-41	121	88863257-62	124
CD-496	118	88863230-56	121	88863370-51	124
88863395-51	118	88863298-21	122	88863185-31	125
88863395-61	118	88863297-21	122	88863185-41	125
88863395-71	118	88863139-21	122	88863353-56	125
88863395-81	118	88863226-21	122	88863033-52	125
88863309-51	118	88863226-31	122	88863185-61	125
88863309-61	118	88863249-31	122	88863185-71	125
88863309-71	118	88863295-41	122	88863185-51	125
88863154-09	118	88863226-41	122	88863256-31	125
88863028-71	118	88863186-21	122	88863336-41	125
88863028-81	118	88863186-31	122	88863256-41	125
88863155-81	119	88863186-41	122	88863035-41	125
88863026-71	119	88863186-51	122	88863324-56	125
88863026-81	119	88863271-21	122	VCD-346	125
88863027-79	119	88863087-31	122	88863356-56	125
SCD-3058G	119	88863271-31	122	88863040-56	125
SCD-2864G	119	88863084-46	122	88863037-56	125
SCD-3059G	119	88863087-41	122	VCD20305MFE	125
88862862-34	119	88863271-41	122	VCD20305MSE	125

VCD20305FE	125	88863261-82	128	88863303-56	131
VCD20305SE	125	88863190-61	128	88863241-56	131
VCD2030556MFE	125	88862768-51	128	88863157-51	131
VCD2030556MSE	125	88863017-51	128	88863088-41	132
88863336-51	125	88863017-61	128	88863088-51	132
88863256-51	125	88863103-71	128	88863167-31	132
88862981-56	125	88863374-52	129	88863088-41	132
88862914-51	125	88863374-62	129	88863167-41	132
88862953-51	125	88863375-71	129	88863222-56	132
VCD2036305FE	125	88863386-62	129	88863213-56	132
88863307-56	126	88863379-52	129	88863203-56	132
88863306-56	126	88863372-72	129	88863202-51	132
88863220-56	126	88863372-82	129	88863088-51	132
88863035-51	126	88863113-71	129	88862855-51	132
88863256-61	126	88863113-81	129	88863290-56	132
88862914-61	126	88863111-79	129	88863212-51	132
88863258-32	126	88863376-81	130	88863167-51	132
88863258-42	126	88863107-31	130	88862815-51	132
88863258-52	126	88863182-31	130	88862852-56	132
88863129-51	126	88863182-41	130	88862840-51	132
88863015-61	126	88863365-56	130	88863213-66	132
88863251-51	126	88863233-51	130	88863202-61	132
88863093-51	126	88863211-56	130	88863167-61	132
88863259-62	126	88863182-51	130	88863131-56	133
88863093-61	126	88863052-56	130	88863275-56	133
88863205-41	127	88862658-56	130	88863159-31	133
88863205-51	127	88862631-51	130	88863159-41	133
88863205-61	127	88863218-36	131	88863236-56	133
88863082-61	127	88863160-31	131	88863235-56	133
88863082-51	127	88862880-41	131	88862879-56	133
88863274-51	127	88863160-41	131	88863159-51	133
88863393-51	127	88863221-56	131	88863193-51	133
88863274-61	127	88863219-56	131	88863319-51	133
88863393-61	127	88863218-56	131	88863240-56	133
88863260-52	127	VCD2031MFE	131	88863228-56	133
88863090-51	127	VCD2031MSE	131	88863239-51	133
88863260-62	127	88863125-51	131	88863168-51	133
88863090-61	127	88862880-51	131	88863119-61	133
88863260-72	127	88862877-56	131	88863092-61	134
88863090-71	127	88862811-51	131	88863092-71	134
88863146-81	127	88862808-51	131	88863147-83	134
88863090-81	127	88863191-51	131	88863147-89	134
88863261-62	128	88863255-56	131	88862818-89	134
88863097-61	128	88863204-51	131	D-1764K	135
88863261-72	128	88863160-51	131	D-1763K	135
88863097-71	128	88862851-56	131	D-1722K	135

D-1760K	135	88864710-11V	142	88862424-89	150
D-1683K	135	88864709-21V	142	88862412-89	150
D-1780K	135	88864710-21V	142	88862410-69	150
D-1779K	135	88864711-21V	142	88862224-89	151
		88864739-21V	142	88862222-89	151
		88864739-31V	142	88862226-89	151
Pledgets		88864716-21V	142	88862224-69	151
VCD20331FE	138	88864716-31V	142	88862226-69	151
VCD2031MFE	138	88864742-15V	143	88862222-69	151
VCD2031MSE	138	88864741-11V	143	88862224-49	151
VCD20316MFE	138	88864794-01V	143	88862228-89	151
VCD20316MSE	138	88864719-21V	143	88862345-53	152
VCD20316FE	138	88864719-31V	143	88862348-53	152
VCD20316SE	138	88864750-51V	143	88862382-83	152
VCD20305MFE	138	88864750-41V	143	88862466-25	152
VCD20305MSE	138	88864750-31V	143	88862414-89	152
VCD20305FE	138	88864730-51V	143	88862393-89	152
VCD20305SE	138	88864731-31V	143	88862376-89	152
VCD2030556MFE	138	88864731-41V	143	88862392-69	152
VCD2030556MSE	138	88864731-51V	143	88862393-69	152
VCD2036305FE	138	88864734-11V	143	88862392-49	152
VPG36FE	138	88864734-21V	143	88862396-89	153
VPG36SE	138	88864714-11V	143	88862497-89	153
VPG56FE	138			88862495-89	153
VPG56SE	138			88862494-89	153
88868675-01	138	Flexon™			
88868677-01	138	88862597-63	146		
88868682-01	138	88862623-53	146	Dermalon™ / Monosof™	
88868678-01	138	88862617-53	146	N-63	156
88868679-01	138	88862615-53	146	N-59	156
		88862589-63	146	N-64	156
Vascufil™		88862592-43	147	SN-770G	156
88864741-21V	142	88862591-43	147	SN-667G	156
88864788-05V	142	88862586-43	147	SN-667	156
88864795-06V	142	88862593-63	147	88861741-11	156
88864703-01V	142			SN-367	156
88864705-01V	142	Steel		SN-771G	156
88864702-05V	142	88862407-53	150	SN-871	156
88864704-01V	142	88862407-63	150	88861741-21	156
88864701-05V	142	88862408-73	150	SN-368	156
88864703-11V	142	88862408-83	150	SN-772G	156
88864705-11V	142	88862407-43	150	SN-872	156
88864704-11V	142	88862408-73	150	88861741-31	156
88864756-11V	142	88862413-83	150	88861747-11	157
88864722-21V	142	88862420-83	150	SN-660	157
88864707-11V	142	88862420-09	150	SN-760	157
88864709-11V	142	88862410-89	150		

SN-659	157	SN-671G	158	SN-5690	161
SN-659G	157	SN-671	158	88861749-24	161
SN-761	157	SN-771	158	SN-5699G	161
SN-762	157	SN-688	158	SN-5699	161
SN-763	157	SN-788	158	SN-5691	161
88861756-11	157	SN-689	158	SDN-5691G	161
88861756-21	157	SN-790	158	SN-5767G	161
SN-661G	157	SN-693	159	SN-5668G	161
SN-661	157	SN-694	159	SN-5668	161
SN-643	157	SN-672	159	SN-5694G	161
SN-552G	157	SN-673G	159	SN-5694	161
SN-662G	157	SN-673	159	SN-5665G	162
SN-662	157	88861727-41	159	SN-5666G	162
88861756-31	157	88861727-51	159	SN-5666	162
88861757-31	157	SN-674	159	SN-5677	162
SN-644	157	SN-775	159	SN-5667G	162
SN-653	157	SN-776	159	SN-5667	162
88861756-41	157	SN-777	159	SDN-5666G	162
SN-641	157	CN-290	159	SN-5669G	162
88861757-41	157	CN-490	159	SN-5669	162
SN-665	157	SN-629	160	SN-5670	162
88861756-51	157	SN-630	160	SN-5862G	163
SN-750	157	SN-631	160	SN-5663G	163
SN-666	157	SN-247	160	SN-5663	163
SN-658	158	SN-681	160	SDN-5943G	163
88861744-31	158	SN-781	160	SN-5660G	163
88861799-31	158	SN-682	160	SN-5662G	163
SN-649	158	SN-782	160	SN-5662	163
SN-663G	158	SN-881	160	SN-1956	164
SN-663	158	CN-819	160	SN-1955	164
88861744-41	158	CN-822	160	SN-1954	164
88861799-41	158	SN-1647G	161	SN-1966	164
SN-669	158	SN-1647	161	SN-3965	164
SN-648	158	SN-3686	161	SN-1964	164
SN-758	158	SN-3697	161	SN-1995	164
88861799-51	158	SN-1689G	161	SN-1994	164
SN-747	158	SN-5697	161	SN-1693	164
SN-764G	158	SN-1689	161	88861742-21	164
SN-764	158	88861754-13	161	88861742-31	164
88861744-51	158	SN-3695	161	SN-568	164
SN-664G	158	SN-5696	161	88861742-41	164
SN-664	158	SN-5696G	161	CN-791	164
88861720-51	158	SDN-5696G	161	CN-792	164
SN-765	158	SN-5698G	161	CN-793	164
SN-670	158	SN-5690G	161	SN-615	165
88861750-41	158	SN-5698	161	SN-616	165

SN-617	165	N-2704K	170	8886402721	176
SN-627	165	N-2734K	171	SPB-1233G	176
88861764-41	165	N-2757K	171	8886440013	176
SN-628	165	N-2756K	171	8886440023	176
88861764-51	165	N-2760K	171	SPB-5413G	176
SN-728	165	N-2766K	171	SPB-5142G	176
N-2500	166	N-2786K	171	8886402821	176
N-2510	166	N-2787K	171	SPB-5143G	176
N-2512	166	N-2719K	171	8886441431	176
N-2540	166	N-2716K	171	8886402831	176
N-1603G	166	N-2966K	171	8886440113	176
N-2541	166	N-2967	171	8886440123	176
N-2514	166	N-2761K	171	8886440133	176
N-2530	166			SPB-1623G	177
N-2532	166	Novafil™		SPB-5633G	177
N-2544	166	8886441913	174	8886442531	177
N-2546	166	8886441923	174	SPB-1643G	177
N-2543	166	8886441933	174	8886441543	177
N-2548	166	88864555-23	174	8886440223	177
N-2547	166	8886442013	174	8886440233	177
CN-225	167	8886442023	174	8886440243	177
CN-723	167	8886442033	174	SPB-5833G	177
CN-722	167	8886403231	174	SPB-5843G	177
CN-825-L	167	8886442043	174	88864582-43	177
CN-724	168	88864554-41	174	88864418-53	177
CN-830-L	168	8886442233	174	88864582-53	177
CN-824	168	8886442243	174	8886440333	177
CN-825	168	8886400241	174	8886440343	177
CN-823-L	168	8886442253	174	SPB-5433G	177
GN-283	168	8886442153	174	SPB-1945G	178
GN-284	168	8886442431	175	88864490-41	178
CN-926	169	8886442441	175	88864490-51	178
N-2513	169	8886442451	175	XNF-697	178
N-2531	169	8886442461	175	XNF-1966	178
N-2533	169	8886442641	175	XNF-1965	178
CN-771	169	8886442651	175	XNF-1964	178
N-2714K	170	8886442661	175	XNF-1995	178
N-2781K	170	8886400963	175	XNF-1994	178
N-2730-K	170	8886443371	175	XNF-1993	178
N-2770-K	170	8886443671	175	8886445241	179
N-2771-K	170	CPB-738G	175	8886445251	179
N-2736K	170	8886441003	176	8886445261	179
N-2718K	170	8886441013	176	8886445951	179
N-2717-K	170	8886441023	176	8886445853	179
N-2799-K	170	SPB-1213G	176	8886445863	179
N-2705K	170	SPB-5223G	176	8886445961	179

8886445971	179	88861935-51	185	88861964-61	188
88864619-51	179	88861935-61	185	88861962-52	189
8886445041	179	88861991-42	185	88861971-61	189
8886445463	179	88861883-51	185	88861962-72	189
8886445561	179	88861883-61	185	88861971-71	189
8886445473	179	88861883-71	185	88861998-62	189
8886445571	179	88861922-71	185	88862011-51	189
88864463-71	179	88861932-51	185	88861928-52	189
88864465-81	180	88861896-71	186	88861928-62	189
88864464-73	180	88861915-61	186	88861928-72	189
88864465-71	180	88861915-71	186	88861909-62	189
88864538-63	180	88861913-72	186		
88864470-81	180	88861895-71	186	Sofsilik™	
8886440861	180	SBS-1928G	186	S-182	192
8886446063	181	SBS-1880G	186	S-193	192
PB-7740K	181	88861981-33	186	S-183	192
PB-6713K	181	SBS-1884G	186	S-243	192
PB-6723K	181	SBS-1883G	186	S-303	192
		88861985-51	187	S-194	192
Surgilon™		88861985-61	187	S-184	192
88861918-31	184	88861985-71	187	S-254	192
88861919-31	184	88861948-61	187	S-244	192
88861899-41	184	88861948-81	187	S-404	192
88861918-41	184	88861910-22	187	S-304	192
88861919-41	184	88861910-32	187	S-195	192
88861899-51	184	88861957-32	187	S-185	192
88861918-51	184	88861927-32	187	S-245	192
88861919-51	184	88861995-31	187	S-305	192
88861917-61	184	88861927-42	187	S-605	192
88861902-61	184	88861995-41	187	S-196	192
88861919-61	184	88861989-32	188	S-176	192
88861917-71	184	88861989-42	188	S-346	192
88861902-71	184	88861993-62	188	S-246	192
88861919-71	184	88861958-42	188	S-316	192
88861917-82	184	88861951-41	188	S-606	192
88861906-42	184	88861926-42	188	S-197	192
88861906-52	184	88861958-52	188	S-187	192
88861920-62	184	88861967-52	188	S-317	192
88861920-72	184	88861951-51	188	S-607	192
88861914-83	184	88861951-61	188	S-318	192
88861920-93	184	88861969-52	188	S-608	192
88861931-43	185	88861969-62	188	S-282	193
88861982-51	185	88861968-61	188	S-610	193
88861935-41	185	88861969-72	188	S-206	193
88861934-53	185	88861964-51	188	S-199	193
				LS-640	193

LS-639	193	SS-70-M	196	VS-889	201
LS-638	193	SS-680	196	VS-890	201
LS-637	193	SS-689	196	VS-891	201
LS-636	193	SS-648	197	VS-806	201
S-1768K	193	SS-647	197	VS-706-M	201
S-1769K	193	SS-646	197	VS-709	201
S-1746K	193	SS-651	197	VS-880	201
S-1750K	194	CS-482	197	VS-881	201
S-1172	194	CS-485	197	VS-882	201
S-1173	194	S-1766K	197	VS-823	201
S-1174	194	S-1765K	197	VS-581	201
S-1373	194	SS-82-M	197	CS-210	202
S-1272	194	SS-733	198	CS-211	202
S-1735	194	SS-732	198	GS-44-M	202
S-1274	194	SS-632	198	VS-870	203
S-1789K	194	SS-734	198	VS-871	203
S-1783K	194	SS-633	198	GS-47-M	203
SS-681	195	CS-390	198	VS-872	203
SS-673	195	CS-490	198	VS-873	203
SS-686	195	SS-5639	199	GS-451	203
SS-645	195	SS-1639G	199	GS-452	203
SS-745	195	SS-5649G	199	GS-453	203
SS-746	195	SS-5640	199	GS-34-M	203
SS-682	195	SS-5641G	199	GS-33-M	203
SS-652	195	SS-5641	199	GS-30-M	203
SS-683G	195	SS-5678	199	VS-552	203
SS-683	195	SS-5676	199	CS-562	203
SS-653	195	SS-5677	199	GS-64-M	204
SS-694	195	SS-5679	199	GS-831	204
SS-654	195	SS-5684	199	GS-63-M	204
SS-655	195	SS-5685G	199	GS-67-M	204
SS-656	195	SS-1694G	199	GS-832	204
SS-629	196	CS-791	200	GS-62-M	204
SS-684	196	CS-792	200	GS-833	204
SS-684G	196	CS-793	200	GS-66-M	204
SS-784	196	CS-794	200	GS-834	204
SS-695	196	SS-523	200	GS-835	204
SS-785	196	SS-525	200	VS-533	204
SS-786	196	SS-621	200	CS-16-M	204
SS-787	196	SS-622	200	CS-17-M	204
SS-685G	196	SS-722	200	GS-822	205
SS-685	196	SS-623	200	GS-823	205
SS-675	196	SS-723	200	GS-824	205
SS-677	196	SS-624	200	CS-423	205
SS-679	196	VS-802	200	CS-10-M	205
SS-678	196	VS-809	200	CS-424	205

CS-425	205	VLOCM0115	211	VLOCL0003	216
VS-842	205	VLOCM0125	211	VLOCL0013	216
VS-843	205	VLOCM0135	211	VLOCL0023	216
VS-844	205	VLOCM1824	211	VLOCL0033	216
VS-845	205	VLOCM1624	211	VLOCL0004	216
CS-745	205	VLOCM0223	211	VLOCL0014	216
CS-744	205	VLOCM0224	211	VLOCL0024	216
VS-846	205	VLOCM1203	212	VLOCL0034	216
CS-746	205	VLOCM1204	212	VLOCL0015	216
CS-93-M	206	VLOCM0843	212	VLOCL0025	216
CS-92-M	206	VLOCM0813	212	VLOCL0123	217
CS-85-M	206	VLOCM1904	212	VLOCL0133	217
X-1095	206	VLOCM0804	212	VLOCL0114	217
VS-863	206	VLOCM1944	212	VLOCL0124	217
VS-964	206	VLOCM0844	212	VLOCL0134	217
VS-766G	206	VLOCM0814	212	VLOCL0115	217
S-2176K	207	VLOCM0824	212	VLOCL0125	217
S-1780K	207	VLOCM0603	212	VLOCL0135	217
S-2780K	207	VLOCM0623	212	VLOCL0223	217
S-2782K	207	VLOCM0604	212	VLOCL0224	217
S-2752K	207	VLOCM2004	212	VLOCL0803	217
S-1734K	207	VLOCM0644	212	VLOCL0813	217
S-1733K	207	VLOCM2044	212	VLOCL0804	217
S-1732K	207	VLOCM0614	212	VLOCL1904	217
		VLOCM0624	212	VLOCL0844	217
		VLOCM0625	212	VLOCL0814	217
V-Loc™ 90		VLOCM2105	213	VLOCL0824	217
VLOCM1413	210	VLOCM2205	213	VLOCL0603	218
VLOCM1423	210	VLOCM2145	213	VLOCL0613	218
VLOCM0003	210	VLOCM2245	213	VLOCL0604	218
VLOCM0013	210	VLOCM2115	213	VLOCL0644	218
VLOCM0023	210	VLOCM1544	213	VLOCL0614	218
VLOCM0033	210	VLOCM1545	213	VLOCL0624	218
VLOCM0004	210	VLOCM0344	213	VLOCL0615	218
VLOCM0014	210	VLOCM0324	213	VLOCL0625	218
VLOCM0024	210	VLOCM0305	213	VLOCL2105	218
VLOCM0034	210	VLOCM0345	213	VLOCL2145	218
VLOCM0005	210	VLOCM0315	213	VLOCL1544	218
VLOCM0015	210	VLOCM3225	213	VLOCL1545	218
VLOCM0025	210	VLOCM1704	213	VLOCL0344	218
VLOCM0035	210	VLOCM1744	213	VLOCL0324	218
VLOCM0113	211			VLOCL0305	218
VLOCM0123	211	V-Loc™ 180		VLOCL0345	218
VLOCM0133	211	VLOCL2815	216	VLOCL0315	218
VLOCM0114	211	VLOCL2826	216	VLOCL0325	218
VLOCM0124	211	VLOCL1413	216		
VLOCM0134	211				

VLOCL0335	218	EDW-51	225
VLOCL0306	218	EDW-52	225
VLOCL0346	218	EL-440	225
VLOCL0316	218	EL-415	225
VLOCL0326	218	EL-450	225
VLOCL0336	218	EL-451	225
VLOCL0416	218	88863129-51	225
VLOCL0426	218	88863015-61	225
VLOCL0436	218		
VLOCL2744	219		

V-Loc™ PBT

VLOCN0814	222	Cardiovascular	226
VLOCN0604	222	Plastic/Cosmetic	227
VLOCN0644	222	Cuticular	227
VLOCN0614	222	General Surgery	228
VLOCN0605	222	Microsurgery	228
VLOCN0615	222	Urology	228
VLOCN1126	222	Orthopedic	229
VLOCN0305	223	Multi-purpose	229
VLOCN0325	223	Ophthalmic	229
VLOCN0306	223		
VLOCN0326	223		
VLOCN0327	223		
VLOCN0437	223		

Wound Closure accessories

DSR3	224
DSR12L	224
88868618-00	224
8886861903	224
BW25G	224

Endoscopic sutures

ED-20-L	224
ED-21-L	224
EL-20-L	224
EL-21-L	224
EL-22-LN	224
EL-23-LN	224
ELW-30	225
ELW-42	225
ELW-50	225
EDW-50	225

Medtronic

IMPORTANT: Please refer to the package insert for complete instructions, contraindications, warnings and precautions.

© 2020 Medtronic. All rights reserved. Medtronic, Medtronic logo and Further, Together are trademarks of Medtronic.

^{TM*} Third party brands are trademarks of their respective owners. All other brands are trademarks of a Medtronic company.

20-weu-sutures-catalogue-dec20-4865125

[medtronic.com/covidien/uk](https://www.medtronic.com/covidien/uk)