



# *SCHEREN – SCISSORS*

*By*

Fizza Surgical International





<b>Standard</b>	<b>Blunt/Blunt</b>	<b>Sharp/Blunt</b>	<b>Sharp/Sharp</b>
	Fig. 1	Fig. 2	Fig. 3
105 mm – 4 1/4"	SC02-10-01	SC02-11-01	SC02-12-01
115 mm – 4 1/2"	SC02-10-02	SC02-11-02	SC02-12-02
<b>130 mm – 5"</b>	SC02-10-03	SC02-11-03	<b>SC02-12-03</b>
145 mm – 5 3/4"	SC02-10-04	<b>SC02-11-04</b>	SC02-12-04
<b>155 mm – 6"</b>	<b>SC02-10-05</b>	<b>SC02-11-05</b>	SC02-12-05
165 mm – 6 1/2"	SC02-10-06	SC02-11-06	SC02-12-06
175 mm – 7"	SC02-10-07	SC02-11-07	SC02-12-07
185 mm – 7 1/4"	SC02-10-08	SC02-11-08	SC02-12-08
200 mm – 8"	SC02-10-09	SC02-11-09	SC02-12-09



<b>Standard</b>	<b>Blunt/Blunt</b>	<b>Sharp/Blunt</b>	<b>Sharp/Sharp</b>
	Fig. 1	Fig. 2	Fig. 3
115 mm – 4 1/2"	SC02-15-01	SC02-16-01	SC02-17-01
<b>130 mm – 5"</b>	<b>SC02-15-02</b>	SC02-16-02	SC02-17-02
<b>145 mm – 5 3/4"</b>	<b>SC02-15-03</b>	SC02-16-03	SC02-17-03
155 mm – 6"	SC02-15-04	SC02-16-04	SC02-17-04
<b>165 mm – 6 1/2"</b>	<b>SC02-15-05</b>	SC02-16-05	<b>SC02-17-05</b>
<b>175 mm – 7"</b>	<b>SC02-15-06</b>	SC02-16-06	SC02-17-06
185 mm – 7 1/4"	SC02-15-07	SC02-16-07	SC02-17-07
200 mm – 8"	SC02-15-08	SC02-16-08	SC02-17-08



<b>Graziol</b>	<b>Blunt/Blunt</b>	<b>Sharp/Blunt</b>	<b>Sharp/Sharp</b>
	Fig. 1	Fig. 2	Fig. 3
130 mm – 5"	SC02-20-01	SC02-21-01	SC02-22-01
145 mm – 5 3/4"	SC02-20-02	SC02-21-02	SC02-22-02



Graziol	Blunt/Blunt	Sharp/Blunt	Sharp/Sharp
	Fig. 1	Fig. 2	Fig. 3
130 mm - 5"	SC02-25-01	SC02-26-01	SC02-27-01
145 mm - 5 <sup>3</sup> / <sub>4</sub> "	SC02-25-02	SC02-26-02	SC02-27-02



Deaver	Sharp/Blunt	Sharp/Blunt	Sharp/Blunt	Sharp/Blunt
145 mm - 5 <sup>3</sup> / <sub>4</sub> "	SC02-30-01	SC02-31-01	SC02-32-01	SC02-33-01
	<i>straight</i>	<i>curved</i>	<i>straight, Serrated Blade</i>	<i>curved, Serrated Blade</i>

Deaver	Blunt/Blunt	Blunt/Blunt	Blunt/Blunt	Blunt/Blunt
145 mm - 5 <sup>3</sup> / <sub>4</sub> "	SC02-30-01	SC02-31-01	SC02-32-01	SC02-33-01
	<i>straight</i>	<i>curved</i>	<i>straight, Serrated Blade</i>	<i>curved, Serrated Blade</i>



Lange	Sharp/Blunt	Sharp/Blunt	Sharp/Blunt	Sharp/Blunt
145 mm - 5 <sup>3</sup> / <sub>4</sub> "	SC02-35-01	SC02-36-01	SC02-37-01	SC02-38-01
	<i>straight</i>	<i>curved</i>	<i>straight, Serrated Blade</i>	<i>curved, Serrated Blade</i>



Mixer

155 mm - 6"



1:2

straight

SC02-40-01

straight, saw edge

SC02-40-02



1:2

curved

SC02-41-01

curved, Serrated Blade

SC02-41-02



Lexer

160 mm - 6<sup>1</sup>/<sub>4</sub>"

SC02-45-01

SC02-46-01

210 mm - 8<sup>1</sup>/<sub>4</sub>"

SC02-45-02

SC02-46-02



Fergusson

140 mm - 5<sup>1</sup>/<sub>2</sub>"

SC02-55-01

160 mm - 6<sup>1</sup>/<sub>4</sub>"

SC02-55-03

180 mm - 7"

SC02-55-03



Richter

140 mm - 5<sup>1</sup>/<sub>2</sub>"

SC02-50-01

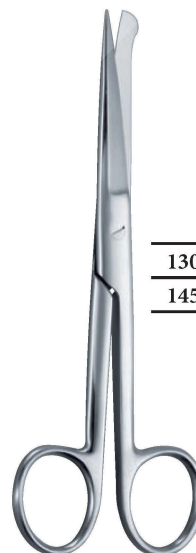

130 mm - 5"

SC02-60-01

145 mm - 5<sup>3</sup>/<sub>4</sub>"

SC02-60-02





**Mayo**

145 mm - 5 <sup>3</sup> / <sub>4</sub> "	SC02-65-01	SC02-66-01
150 mm - 6"	SC02-65-02	SC02-66-02
170 mm - 6 <sup>3</sup> / <sub>4</sub> "	SC02-65-03	SC02-66-03
230 mm - 9"	SC02-65-04	SC02-66-04
200 mm - 8"	SC02-65-05	SC02-66-05
160 mm - 6 <sup>1</sup> / <sub>4</sub> "	SC02-65-06	SC02-66-06
250 mm - 10"	SC02-65-07	SC02-66-07
300 mm - 12"	SC02-65-08	SC02-66-08



**Mayo - Stille**

150 mm - 6"	SC02-70-01	SC02-71-01
170 mm - 6 <sup>3</sup> / <sub>4</sub> "	SC02-70-02	SC02-71-02
195 mm - 7 <sup>3</sup> / <sub>4</sub> "	SC02-70-03	SC02-71-03
210 mm - 8 <sup>3</sup> / <sub>4</sub> "	SC02-70-04	SC02-71-04

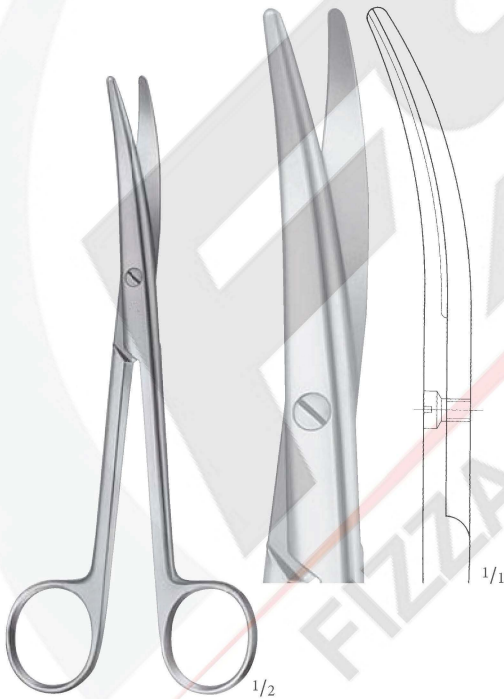

**Mayo-Lexer**

165 mm, 6 1/2"

SC 02-72-01

Standard-Modell  
Standard pattern



**Mayo - Harrington**

220 mm - 8 <sup>3</sup> / <sub>4</sub> "	SC02-75-01
--	------------



SC02-76-01

*Operating scissors – Dissecting scissors*



**Mayo - Noble**

170 mm – 6<sup>3</sup>/<sub>4</sub>"



1:2



1:2

SC 02-80-01

SC 02-81-01

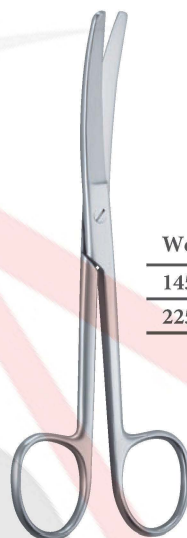

**Wertheim**

145 mm – 5<sup>3</sup>/<sub>4</sub>"

SC 02-85-01

225 mm – 8<sup>3</sup>/<sub>4</sub>"

SC 02-85-02



1:2



1:2



1:2

**Metzenbaum**

150 mm – 6"

SC 02-90-01

SC 02-91-01

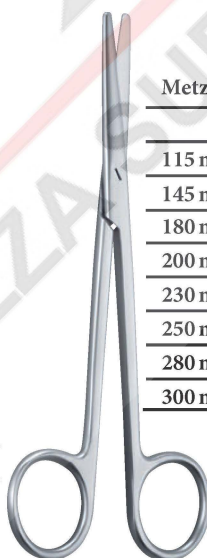

**Metzenbaum**



1:2



1:2

	Fig. 1	Fig. 2	Fig. 3
115 mm – 4 <sup>1</sup> / <sub>2</sub> "	SC 02-95-01	SC 02-96-01	SC 02-97-01
145 mm – 5 <sup>3</sup> / <sub>4</sub> "	SC 02-95-02	SC 02-96-02	SC 02-97-02
180 mm – 7"	SC 02-95-03	SC 02-96-03	SC 02-97-03
200 mm – 8"	SC 02-95-04	SC 02-96-04	SC 02-97-04
230 mm – 9"	SC 02-95-05	SC 02-96-05	SC 02-97-05
250 mm – 10"	SC 02-95-06	SC 02-96-06	SC 02-97-06
280 mm – 11"	SC 02-95-07	SC 02-96-07	SC 02-97-07
300 mm – 12"	SC 02-95-08	SC 02-96-08	SC 02-97-08

*Operating scissors – Dissecting scissors*



**Metzenbaum**



	Fig. 1	Fig. 2	Fig. 3
115 mm – 4 1/2"	SC 02-100-01	SC 02-101-01	SC 02-102-01
145 mm – 5 3/4"	SC 02-100-02	SC 02-101-02	SC 02-102-02
180 mm – 7"	SC 02-100-03	SC 02-101-03	SC 02-102-03
200 mm – 8"	SC 02-100-04	SC 02-101-04	SC 02-102-04
230 mm – 9"	SC 02-100-05	SC 02-101-05	SC 02-102-05
250 mm – 10"	SC 02-100-06	SC 02-101-06	SC 02-102-06
280 mm – 11"	SC 02-100-07	SC 02-101-07	SC 02-102-07
300 mm – 12"	SC 02-100-08	SC 02-101-08	SC 02-102-08



**Metzenbaum-Nelson**



	Fig. 1	Fig. 2	Fig. 3
180 mm – 7"	SC 02-105-01	SC 02-106-01	SC 02-107-01
200 mm – 8"	SC 02-105-02	SC 02-106-02	SC 02-107-02
230 mm – 9"	SC 02-105-03	SC 02-106-03	SC 02-107-03
250 mm – 9 3/4"	SC 02-105-04	SC 02-106-04	SC 02-107-04
280 mm – 11"	SC 02-105-05	SC 02-106-05	SC 02-107-05
300 mm – 12"	SC 02-105-06	SC 02-106-06	SC 02-107-06



**Metzenbaum-Nelson**







	Fig. 1	Fig. 2	Fig. 3
180 mm – 7"	SC 02-110-01	SC 02-111-01	SC 02-112-01
200 mm – 8"	SC 02-110-02	SC 02-111-02	SC 02-112-02
230 mm – 9"	SC 02-110-03	SC 02-111-03	SC 02-112-03
<b>250 mm – 9 3/4"</b>	<b>SC 02-110-04</b>	<b>SC 02-111-04</b>	<b>SC 02-112-04</b>
280 mm – 11"	SC 02-110-05	SC 02-111-05	SC 02-112-05
300 mm – 12"	SC 02-110-06	SC 02-111-06	SC 02-112-06

**Chirurgische Scheren – Präparierscheren**  
**Operating scissors – Dissecting scissors**



**Metzenbaum-Fino**

	 1:2	 1:2	 1:2	 1:2
	Fig. 1	Fig. 3	Fig. 1	Fig. 3
145 mm – 5 <sup>3</sup> / <sub>4</sub> "	SC 02-115-01	SC 02-116-01	SC 02-117-01	SC 02-118-01



**FOMON**

135 mm – 5<sup>1</sup>/<sub>4</sub>"  
SC 02-125-01



**Metzenbaum-Fino**

180 mm – 7"	SC 02-120-01	SC 02-121-01	SC 02-122-01
220 mm – 8"	SC 02-120-02	SC 02-121-02	SC 02-122-02
230 mm – 9"	SC 02-120-03	SC 02-121-03	SC 02-122-03

S-förmig gebogen  
S-curved



**Thorek**

190 mm – 7<sup>1</sup>/<sub>2</sub>"  
SC 02-130-01



**SCHEREN – SCISSORS**

*Gynaecological scissors*

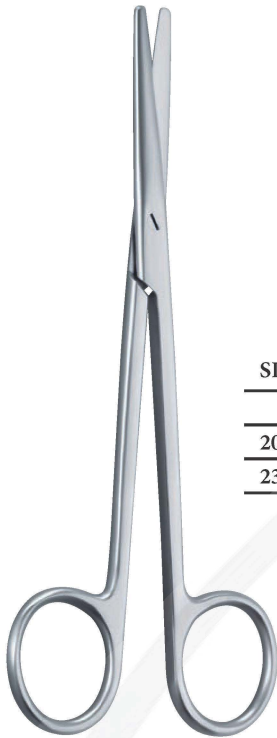

SIMS

	Fig. 1	Fig. 2	Fig. 1	Fig. 2
200 mm – 8"	SC 02-135-01	SC 02-136-01	SC 02-137-01	SC 02-138-01
230 mm – 9"	SC 02-135-02	SC 02-136-02	SC 02-137-02	SC 02-138-02



DUBOIS

270 mm – 10 <sup>3</sup> / <sub>4</sub> "	SC 02-140-01
---	--------------



SC 02-141-01



DOYEN

175 mm – 7"	SC 02-145-01	SC 02-146-01
-------------	--------------	--------------



SIEBOLD

240 mm – 9<sup>1</sup>/<sub>2</sub>"

SC 02-150-01

S-CURVED



1:2

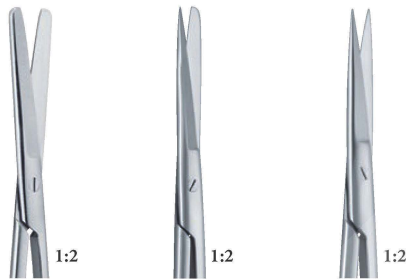

1:2 1:2 1:2

	Fig. 1	Fig. 2	Fig. 3
120 mm – 4 <sup>3</sup> / <sub>4</sub> "	SC 02-155-01	SC 02-156-01	SC 02-157-01



1:2



1:2 1:2 1:2

	Fig. 1	Fig. 2	Fig. 3
120 mm – 4 <sup>3</sup> / <sub>4</sub> "	SC 02-160-01	SC 02-161-01	SC 02-162-01



1:2

**Knapp**



1:2 1:2

105 mm – 4 <sup>1</sup> / <sub>4</sub> "	SC 02-165-01	SC 02-166-01
--	--------------	--------------

*blunt*



**Littler**



115 mm – 4 <sup>1</sup> / <sub>2</sub> "	SC 02-180-01
145 mm – 5 <sup>3</sup> / <sub>4</sub> "	SC 02-180-02



1:2

**Wagner**



1:2 1:2

120 mm – 4 <sup>3</sup> / <sub>4</sub> "	SC 02-170-01	SC 02-170-02	SC 02-171-01	SC 02-171-02
--	--------------	--------------	--------------	--------------

*straight*

*straight, Serrated Blade curved*

*curved, Serrated Blade*

*Fine scissors*



**Locklin**

165 mm – 6 1/2"

SC 02-185-01



SC 02-186-01



**Quinby**

125 mm – 5"

SC 02-190-01

*Serrated Blade,*

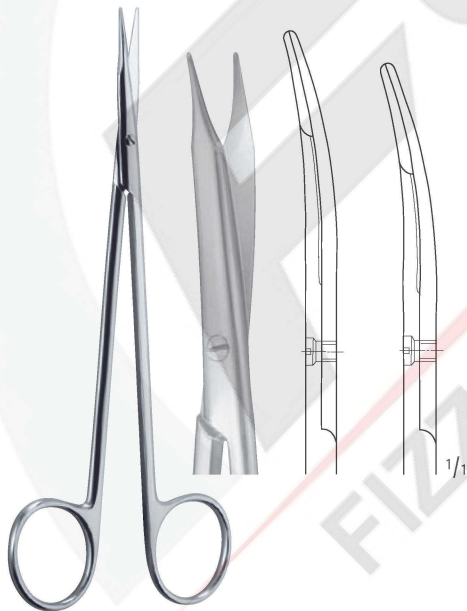

**Reynolds Jameson**

160 mm – 6 1/4"

SC 02-195-01

180 mm – 7"

SC 02-195-02

145 mm – 5 3/4"

SC 02-195-03

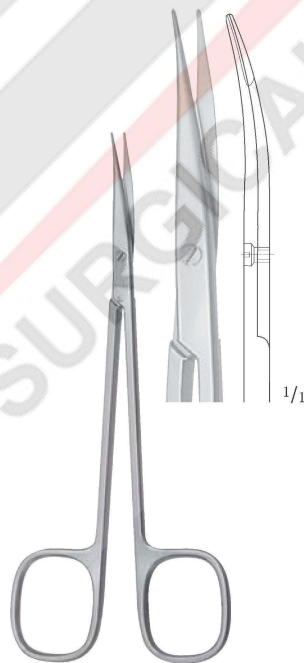

**Reynolds-Jameson**

140 mm, 5 1/2"

SC 02-196-01

Gefäß-Schere

Vascular scissors



**Neumann**

120 mm – 4 3/4"

SC 02-200-01

*S-curved*





*Fistula scissors*

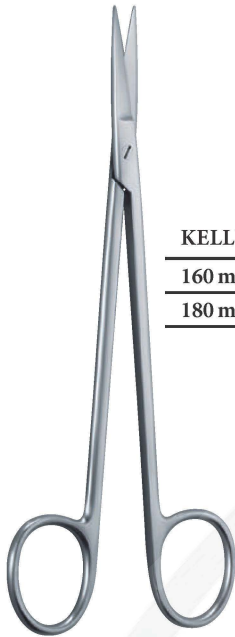

**KELLY**

160 mm - 6 <sup>1</sup> / <sub>4</sub> "	SC 02-235-01	SC 02-236-01
180 mm - 7"	SC 02-235-02	SC 02-236-02



**Enukleationsscheren Enucleation scissors**



**LANDOLT**

125 mm - 5"	SC 02-240-01	SC 02-241-01
-------------	--------------	--------------

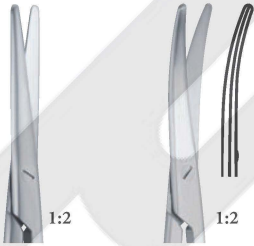

**CHADWICK**

110 mm - 4 <sup>1</sup> / <sub>4</sub> "	SC 02-245-01
--	--------------

110 mm - 4 <sup>1</sup> / <sub>4</sub> "	SC 02-250-01
--	--------------



**JOSEPH**

140 mm - 5 <sup>1</sup> / <sub>2</sub> "	SC 02-255-01	SC 02-256-01
--	--------------	--------------



**KILNER (Ragnell)**

120 mm - 4 <sup>3</sup> / <sub>4</sub> "	SC 02-260-01
150 mm - 6"	SC 02-260-02



*Plastic surgery scissors*

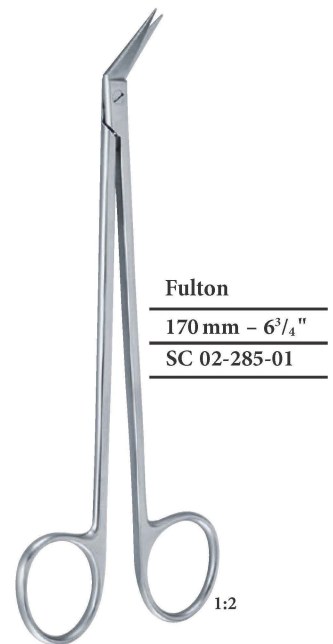
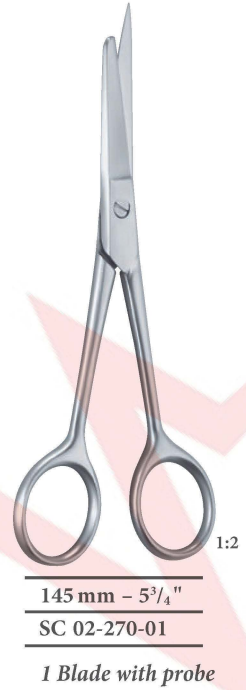
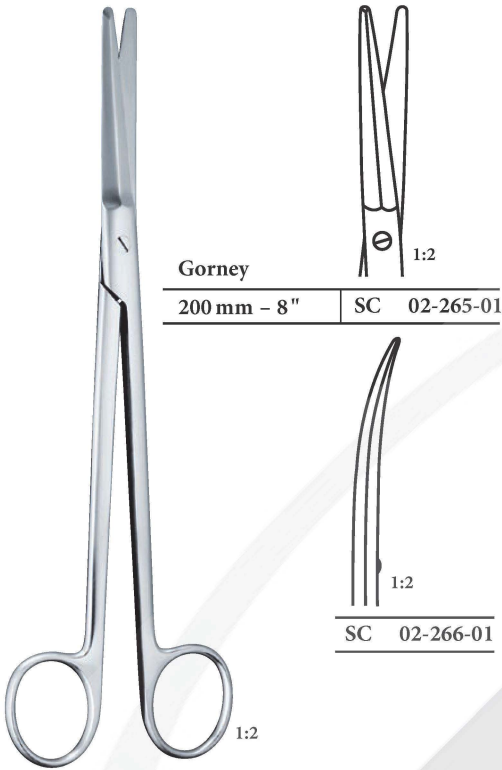

**Cottle-Knapp**  
105 mm, 4 1/8"  
Scheren für die plastische Chirurgie  
Scissors for plastic surgery

**COTTLE**  
115 mm, 4 1/2"  
SC 02-294-01  
Bulldog-Schere  
Bulldog scissors

*Artery scissors*



**Potts - Smith  
(de Martel)**  
195 mm – 7<sup>3</sup>/<sub>4</sub>"  
SC 02-290-01

1:2

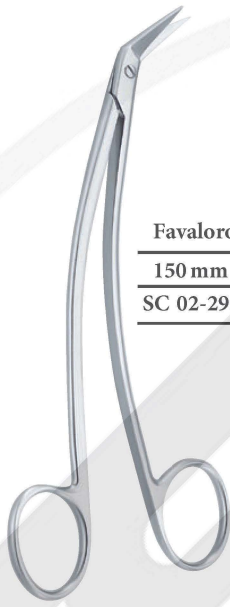

**Favaloro**  
150 mm – 6"  
SC 02-295-01

1:2



1:2

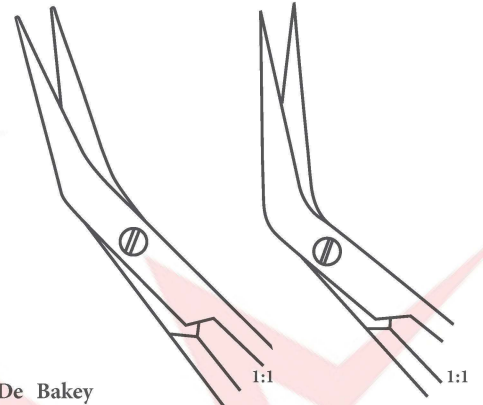

**De Baakey**  
155 mm – 6" | SC 02-300-01 | SC 02-301-01  
*Offset scissors, s-shaped*

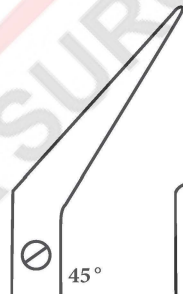
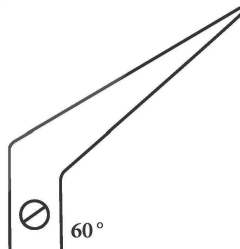

<b>De Baakey</b>	 25°	 45°	 60°
160 mm – 6 <sup>1</sup> / <sub>4</sub> "	SC 02-305-01	SC 02-306-01	SC 02-307-01
230 mm – 9"	SC 02-305-02	SC 02-306-02	SC 02-307-02
280 mm – 11"	SC 02-305-03	SC 02-306-03	SC 02-307-03



1:2

**Mills**  
225 mm – 8<sup>3</sup>/<sub>4</sub>"  
SC 02-310-01

*Artery scissors*

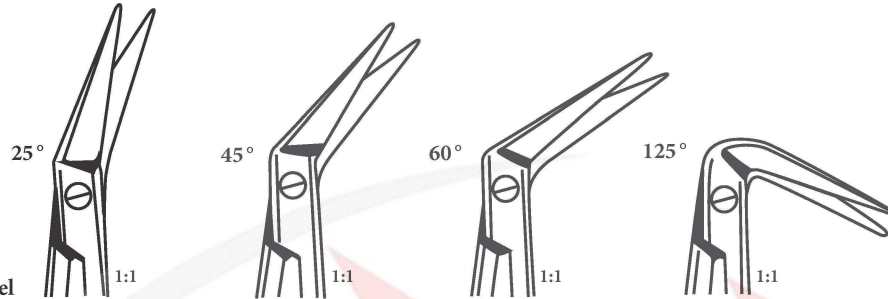
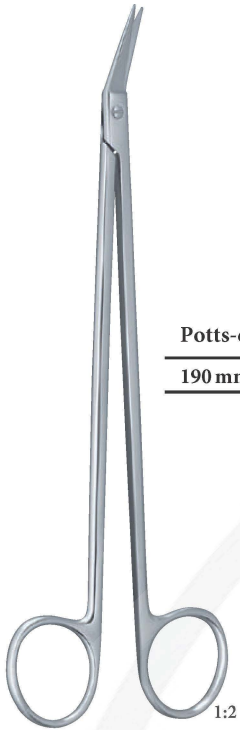

**Potts-de Martel**

190 mm - 7 1/2"	SC 02-315-01	SC 02-315-02	SC 02-315-03	SC 02-315-04
-----------------	--------------	--------------	--------------	--------------

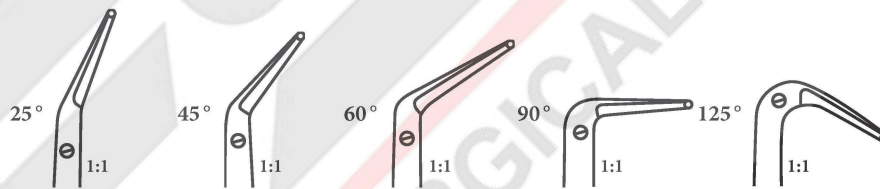

180 mm - 7"	SC 02-320-01	SC 02-320-02	SC 02-320-03	SC 02-320-04	SC 02-320-05
-------------	--------------	--------------	--------------	--------------	--------------



SC 02-320-07	SC 02-320-08	SC 02-320-09	SC 02-320-10	SC 02-320-11
--------------	--------------	--------------	--------------	--------------



*Artery scissors*

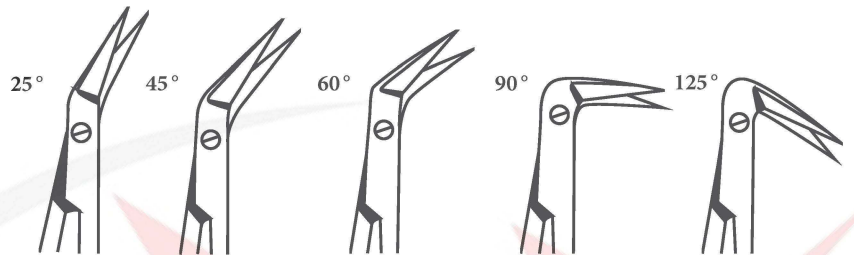
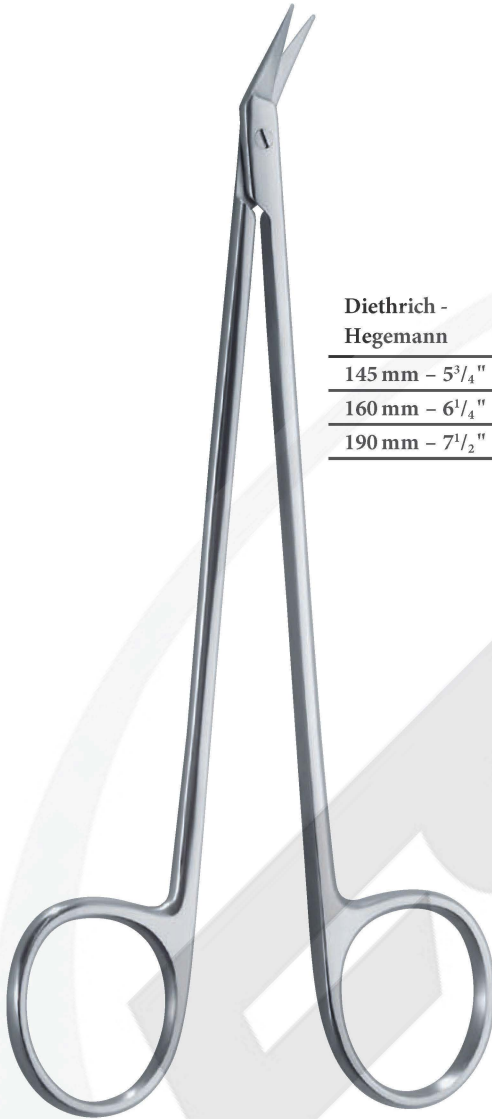

**Diethrich - Hegemann**

145 mm - 5 <sup>3</sup> / <sub>4</sub> "	SC 02-325-01	SC 02-326-01	SC 02-327-01	SC 02-328-01	SC 02-329-01
160 mm - 6 <sup>1</sup> / <sub>4</sub> "	SC 02-325-02	SC 02-326-02	SC 02-327-02	SC 02-328-02	SC 02-329-02
190 mm - 7 <sup>1</sup> / <sub>2</sub> "	SC 02-325-03	SC 02-326-03	SC 02-327-03	SC 02-328-03	SC 02-329-03



**Martin - Cartilage**  
190 mm - 7<sup>1</sup>/<sub>2</sub>" | SC 02-330-01  
*curved, Serrated Blade*



**Mc Indoe**  
190 mm - 7<sup>1</sup>/<sub>2</sub>" | SC 02-335-01

*Cartilage scissors*



**Potts - Smith**

190 mm - 7½"	SC 02-340-01
--------------	--------------



**Prince**

175 mm - 7"	SC 02-350-01
-------------	--------------



**Toennis**

180 mm - 7"
-------------



SC 02-360-01
--------------



SC 02-361-01
--------------



**Boettcher**

180 mm - 7"	SC 02-345-01
-------------	--------------



**Toennis - Adson**

170 mm - 6¾"	SC 02-355-01
--------------	--------------



**Dean**

170 cm - 6¾"
--------------

SC 02-365-01
--------------

*curved*

SC 02-366-01
--------------

*curved, Serrated Blade*

*Tonsil scissors*



<b>Wertheim</b>	
190 mm – 7½"	SC 02-370-01

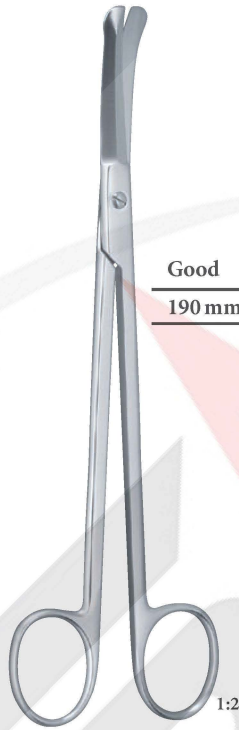

<b>Good</b>	
190 mm – 7½"	SC 02-380-01



<b>Crafoord</b>	
300 mm – 12"	SC 02-385-01



<b>Olivecrona</b>	
230 mm – 9"	SC 02-375-01

*Trigeminal scissors*

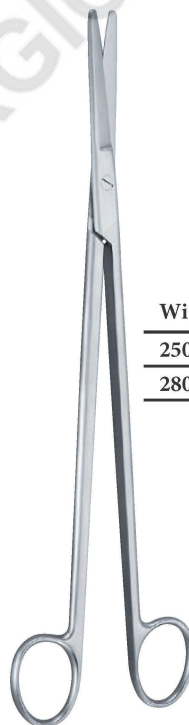
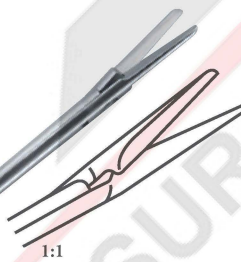

<b>Willauer</b>		
250 mm – 9¾"	SC 02-390-01	SC 02-391-01
280 mm – 11"	SC 02-390-02	SC 02-392-02

*straight                  curved*

*Lobectomy scissors*



**Finochietto**  
270 mm – 10<sup>3</sup>/<sub>4</sub>" | SC 02-400-01

1:3



**Resano**  
250 mm – 10" | SC 02-405-01

1:3



**Satinsky**  
245 mm – 9<sup>3</sup>/<sub>4</sub>" | SC 02-406-01

1:2

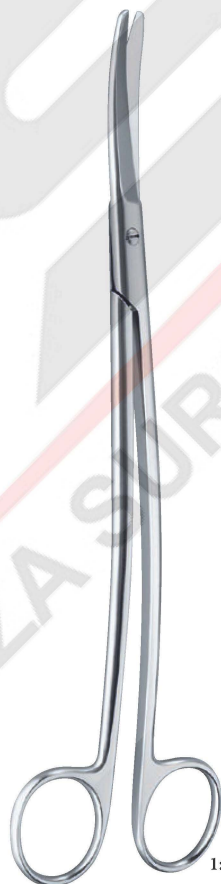

**Klinkenberg - Loth**  
230 mm – 9" | SC 02-410-01

1:2



**Jorgenson**  
220 mm – 8<sup>3</sup>/<sub>4</sub>" | SC 02-411-01

1:2



**Darmscheren *Enterotomy scissors***

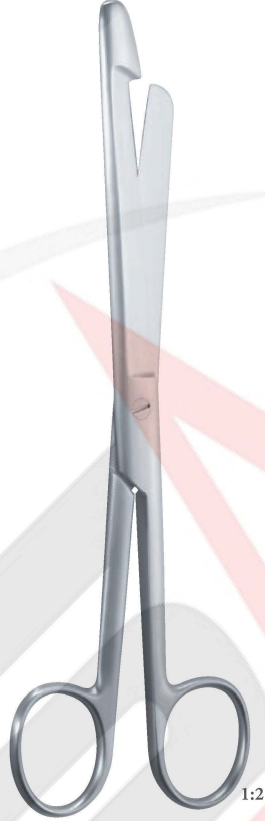

	<b>Fig. 1</b>	<b>Fig. 2</b>	<b>Fig. 3</b>
<b>210 mm – 8 1/4"</b>	<b>SC 02-415-01</b>	<b>SC 02-420-01</b>	<b>SC 02-425-01</b>

**Umbilical scissors**



**Busch**

<b>130 mm – 5"</b>	<b>SC 02-426-01</b>	<b>SC 02-427-01</b>
<b>160 mm – 6 1/4"</b>	<b>SC 02-426-02</b>	<b>SC 02-427-02</b>

**Schumacher**

<b>160 mm – 6 1/4"</b>	<b>SC 02-430-01</b>
------------------------	---------------------

**Mod. USA**

<b>105 mm – 4 1/4"</b>	<b>SC 02-435-01</b>
------------------------	---------------------

*Serrated Blade*

*Episiotomy scissors*

*Parametrium scissors*



**Braun - Stadler**

145 mm - 5 <sup>3</sup> / <sub>4</sub> "
220 mm - 8 <sup>3</sup> / <sub>4</sub> "

SC 02-440-01
SC 02-440-02

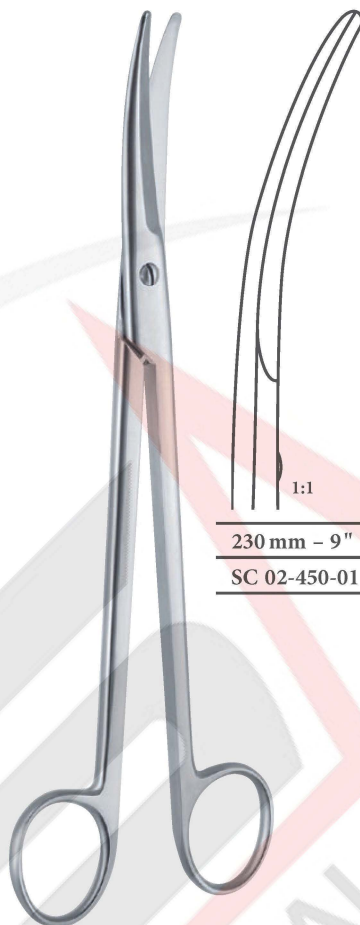

1:1

1:1

230 mm - 9"

225 mm - 8<sup>3</sup>/<sub>4</sub>"

SC 02-450-01

SC 02-451-01



1:2

**Waldmann**

180 mm - 7"
-------------

SC 02-445-01
--------------

*Nasal scissors*



**Sailer**

170 mm - 6 <sup>3</sup> / <sub>4</sub> "	SC 02-455-01
--	--------------

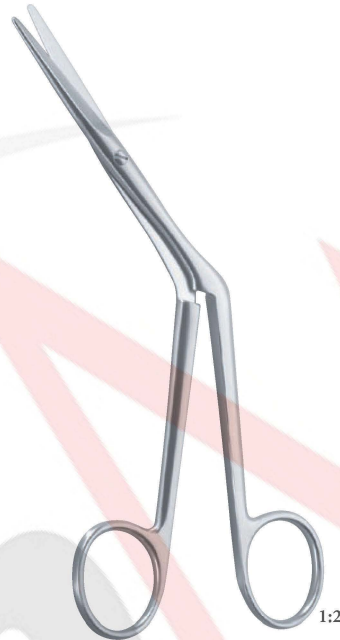

**Heymann**

180 mm - 7"	SC 02-460-01
-------------	--------------



**Fomon**

130 mm - 5"	SC 02-465-01
-------------	--------------



**Cottle**

160 mm - 6 <sup>1</sup> / <sub>4</sub> "	SC 02-470-01
--	--------------

*Operating scissors – Dissecting scissors*



**Mayo**

145 mm – 5 <sup>3</sup> / <sub>4</sub> "	SC 02-805-01	SC 02-806-01
170 mm – 6 <sup>3</sup> / <sub>4</sub> "	SC 02-805-02	SC 02-806-02
230 mm – 9"	SC 02-805-03	SC 02-806-03

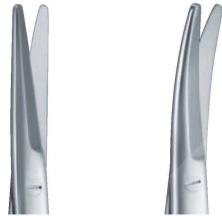

**Mayo - Stille**

150 mm – 6"	SC 02-810-01	SC 02-811-01
170 mm – 6 <sup>3</sup> / <sub>4</sub> "	SC 02-810-02	<b>SC 02-811-02</b>



**Metzenbaum**

	Fig. 1	Fig. 2	Fig. 3
115 mm – 4 <sup>1</sup> / <sub>2</sub> "	SC 02-815-01	SC 02-816-01	SC 02-817-01
145 mm – 5 <sup>3</sup> / <sub>4</sub> "	SC 02-815-02	SC 02-816-02	SC 02-817-02
180 mm – 7"	SC 02-815-03	SC 02-816-03	SC 02-817-03
200 mm – 8"	SC 02-815-04	SC 02-816-04	SC 02-817-04
230 mm – 9"	SC 02-815-05	SC 02-816-05	SC 02-817-05
250 mm – 10"	SC 02-815-06	SC 02-816-06	SC 02-817-06
280 mm – 11"	SC 02-815-07	SC 02-816-07	SC 02-817-07
300 mm – 12"	SC 02-815-08	SC 02-816-08	SC 02-817-08



**Metzenbaum**

	Fig. 1	Fig. 2	Fig. 3
115 mm – 4 <sup>1</sup> / <sub>2</sub> "	<b>SC 02-827-01</b>	SC 02-828-01	SC 02-829-01
145 mm – 5 <sup>3</sup> / <sub>4</sub> "	SC 02-827-02	SC 02-828-02	SC 02-829-02
180 mm – 7"	<b>SC 02-827-03</b>	<b>SC 02-828-03</b>	<b>SC 02-829-03</b>
200 mm – 8"	SC 02-827-04	SC 02-828-04	SC 02-829-04
230 mm – 9"	SC 02-827-05	SC 02-828-05	SC 02-829-05
250 mm – 10"	<b>SC 02-827-06</b>	<b>SC 02-828-06</b>	<b>SC 02-829-06</b>
280 mm – 11"	SC 02-827-07	SC 02-828-07	SC 02-829-07
300 mm – 12"	<b>SC 02-827-08</b>	<b>SC 02-828-08</b>	<b>SC 02-829-08</b>





*Artery scissors*

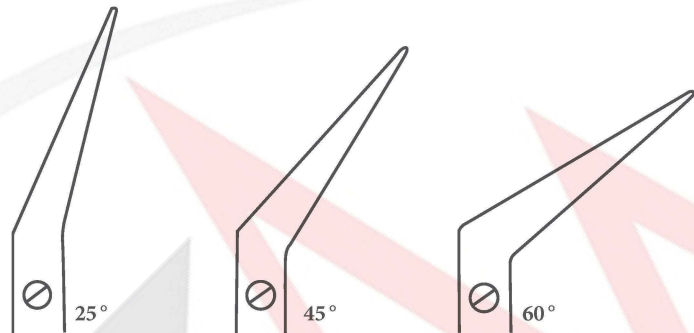

De Bakey			
160 mm – 6 1/4"	SC 02-875-01	SC 02-876-02	SC 02-877-03
230 mm – 9"	SC 02-875-02	SC 02-876-02	SC 02-877-02
280 mm – 11"	SC 02-875-03	SC 02-876-03	SC 02-877-03

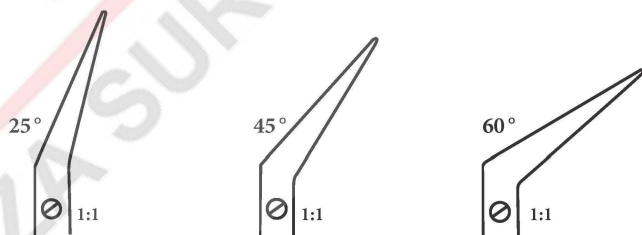

<b>Potts - de Martel</b>			
<b>190 mm – 7 1/2"</b>	SC 02-880-01	SC 02-881-01	<b>SC 02-882-01</b>