

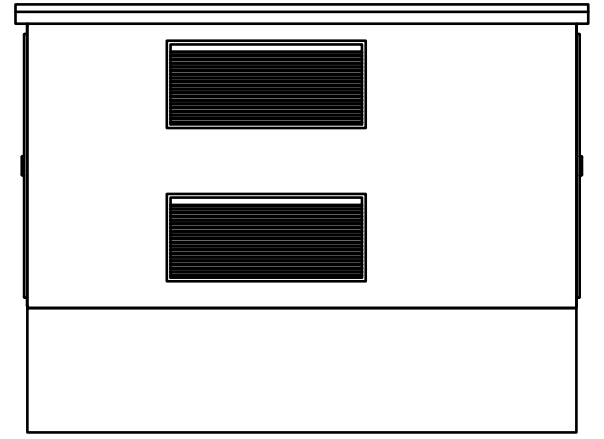

Schema de interconectare e-RTU2020-4S cu celule CGM Cosmos

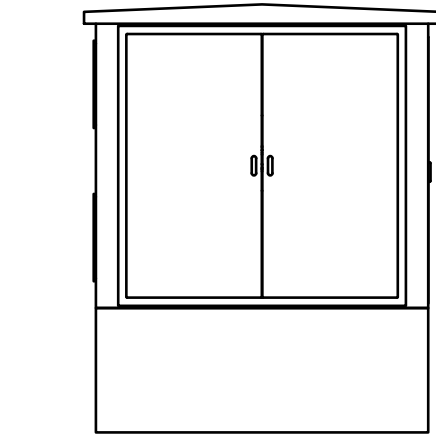
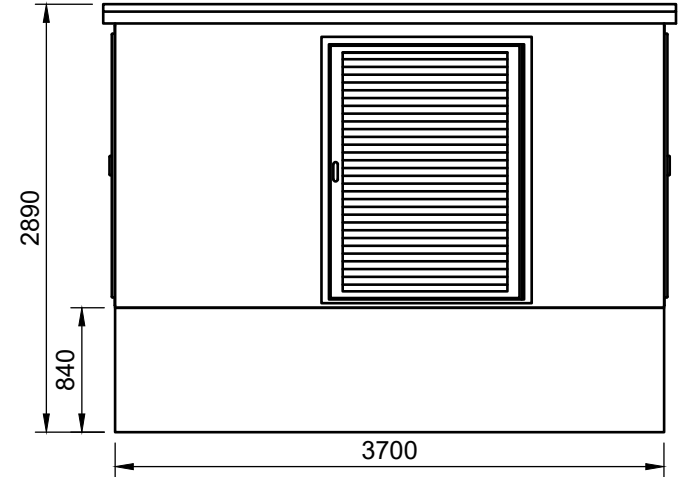
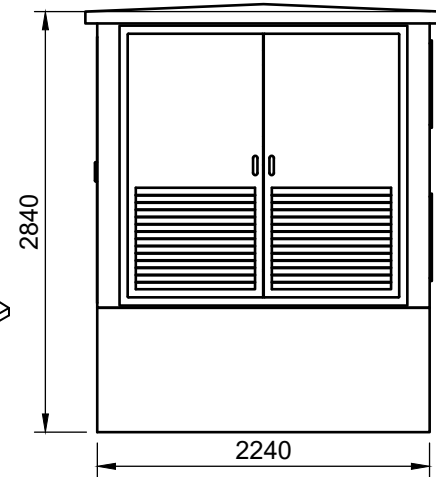
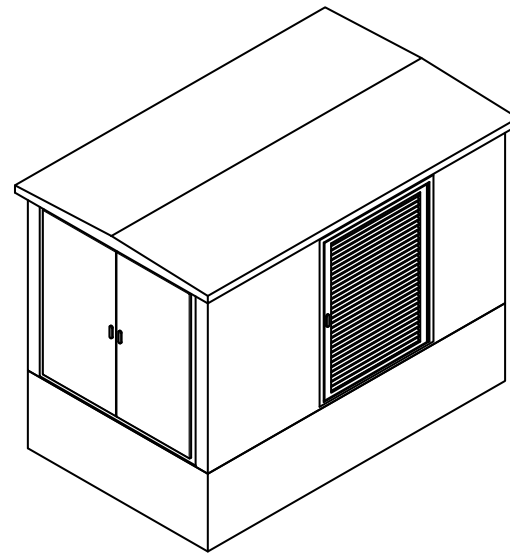
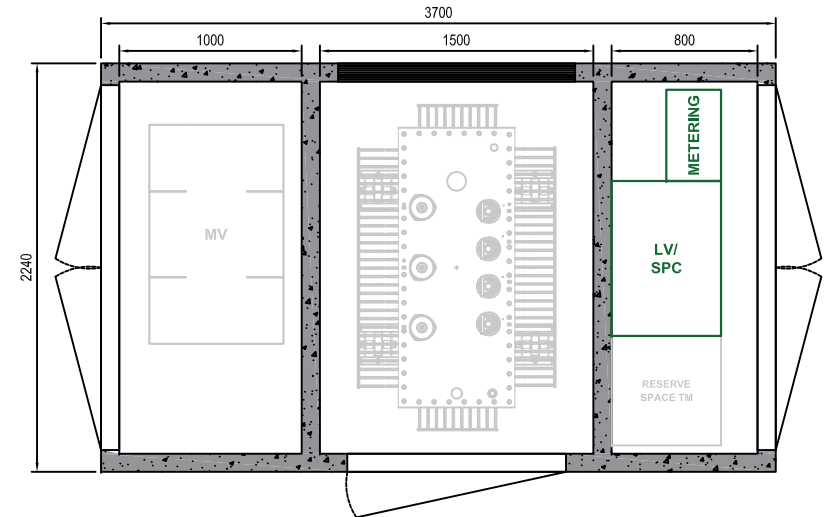
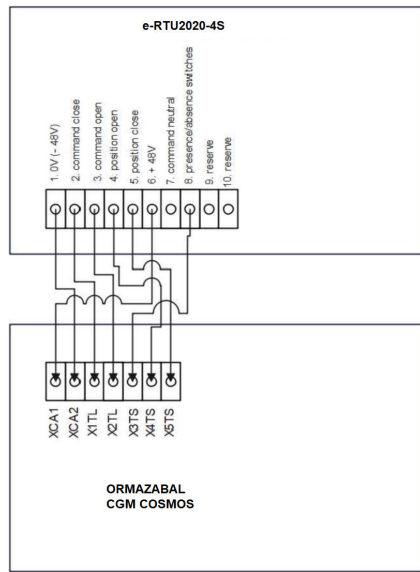
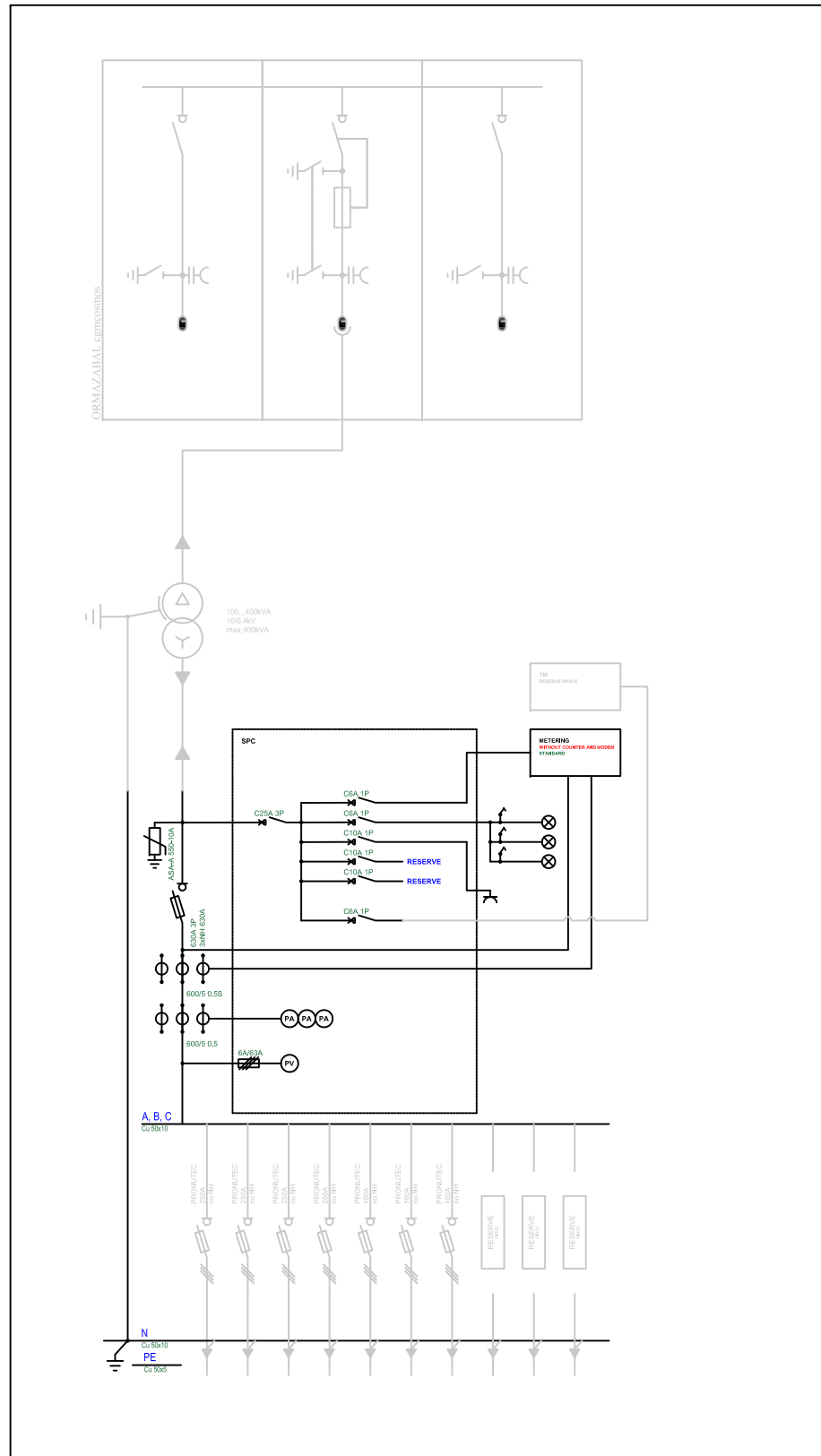

	Contract No 15007	Executed	Date	I checked	Date
		Document type		Document status	
		Object PT129CCR1		Name	
		M	1:1	Date of dispatch	Letter
		Format	A3		