



AESCULAP® POWER SYSTEMS

CATALOG 2022

ELAN 4 and Acculan 4

CONTENT

ELAN 4

- ELAN 4 electro
 - ELAN 4 Accessories
-

Acculan 4

- Acculan 4 & Acculan 4 Small Drill
 - Acculan 4 Electro
 - Acculan 4 Accessories
-

PROCESSING

- Sterilit® Power Systems
 - Processing
-

OTHERS

- Tool Attachments Overview
 - Signs & Symbols
 - Brochures
 - Index
-

AESCULAP® ELAN 4

PRECISION. PERFORMANCE. PLEASURE.

With its technical concept ELAN 4 addresses important requirements of the surgeon and all parties involved in handling power systems in the hospital.

- Convenient and reliable grip
- Powerful, precise and reliable work
- Easy to set up and simple to use



AESCLAP® ELAN 4

ELAN 4 electro

ELECTRIC HIGHSPEED SYSTEM



ELAN 4 electro BASIC COMPONENTS

GA800

ELAN 4 electro CONTROL UNIT

with irrigation pump; touch screen;
power cord not included
pump flow 0 - 65 ml/min

100 - 240 V AC; 50/60 Hz;
380 x 330 x 200 mm; 9,500 g

consisting parts:
GD412804 bottle holder

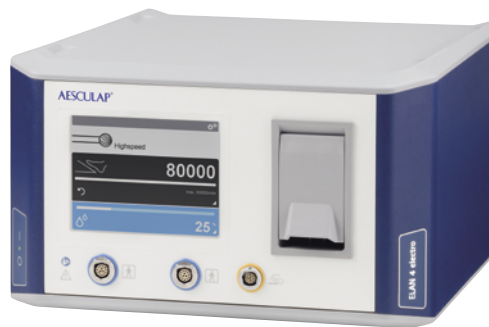

GA808

ELAN 4 electro FOOT CONTROL

protection type IPX8; anaesthetic
proof class AP

5.0 m;
245 x 144 x 76 mm; 2,240 g



GA810

ELAN 4 electro WIRELESS FOOT CONTROL

protection type IPX8; anaesthetic
proof class AP

271 x 266 x 85 mm; 3,800 g

Requires control unit with software
version V3.00.



GA806

GB073R

ELAN 4 electro MOTOR CABLE

for use with ELAN 4 electro applied
parts

4.0 m; 270 g

consisting parts:
GB600860 Sterilit® spray adapter
ELAN 4 electro



AESCULAP® ELAN 4

ELAN 4 electro

BASIC COMPONENTS, PERFORATOR DRIVER & LOWSPEED MOTOR

GA804

GB073R

ELAN 4 electro MOTOR CABLE
WITH HAND SWITCH

for use with ELAN 4 electro applied
parts

4.0 m; 374 g

consisting parts:
GB600860 Sterilit® spray adapter
ELAN 4 electro



GA805

GB073R

ELAN 4 electro MOTOR CABLE
WITH HAND CONTROL

for use with ELAN 4 electro applied
parts

4.0 m; 369 g

consisting parts:
GB600860 Sterilit® spray adapter
ELAN 4 electro



GA822

GB076R

ELAN 4 electro PERFORATOR DRIVER

for use with cranial perforators with
Hudson shank

180 W; 0 - 1,200 rpm; 250 Ncm;
166 x 35 mm; 410 g



GA824

GB077R

ELAN 4 electro LOWSPEED MOTOR

with intra coupling

180 W; 0 - 40,000* rpm;
10 Ncm; 123 x 23 mm; 150 g

* Requires control unit with software
version V3.00. With lower versions
the motor runs max. 20,000 rpm.



ELAN 4 electro CRANIOTOME & ATTACHMENTS

GA849

GB085R

ELAN 4 electro CRANIOTOME AND MULTIFUNCTION HANDPIECE

2-ring coding; for use with
dura guards and holding sleeves
GB941R - GB947R; spray nozzle
GA259SU (not included)

140 W; ↻ ↺; 0 - 80,000 rpm; 2.2 Ncm;
156 x 17 mm; 📖 121 g



GB941R

GB719R

ELAN 4 DURA GUARD PEDIATRIC

fixed; 1 dot coding;
for craniotome and multifunction
handpieces GA749, GA849



GB942R

GB719R

ELAN 4 DURA GUARD STANDARD

fixed; 2 dot coding;
for craniotome and multifunction
handpieces GA749, GA849



GB943R

GB719R

ELAN 4 DURA GUARD LONG

fixed; 3 dot coding;
for craniotome and multifunction
handpieces GA749, GA849



GB945R

GB719R

ELAN 4 HOLDING SLEEVE

for craniotome and multifunction
handpieces GA749, GA849



GB947R

GB719R

ELAN 4 DURA GUARD STANDARD

turnable; 2 dot coding;
for craniotome and multifunction
handpieces GA749, GA849



AESCULAP® ELAN 4

ELAN 4 electro

1-RING HIGHSPEED HANDPIECES

GA861

GB083R

ELAN 4 electro 1-RING HANDPIECE
L4

1-ring coding;
spray nozzle GA261SU (not included)
140 W; ↻ ↻; 0 - 80,000 rpm; 2.2 Ncm;
152 x 16 mm; 📖 80 g



GA862

GB083R

ELAN 4 electro 1-RING HANDPIECE
L7

1-ring coding;
spray nozzle GA262SU (not included)
140 W; ↻ ↻; 0 - 80,000 rpm; 2.2 Ncm;
177 x 16 mm; 📖 83 g



GA863

GB083R

ELAN 4 electro 1-RING HANDPIECE
L10

1-ring coding;
spray nozzle GA263SU (not included)
140 W; ↻ ↻; 0 - 80,000 rpm; 2.2 Ncm;
206 x 16 mm; 📖 87 g

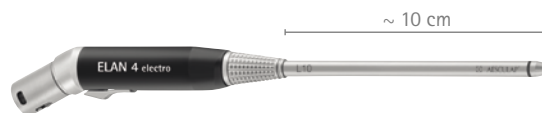

GA864

GB083R

ELAN 4 electro 1-RING HANDPIECE
L13

1-ring coding;
spray nozzle GA264SU (not included)
140 W; ↻ ↻; 0 - 80,000 rpm; 2.2 Ncm;
237 x 16 mm; 📖 91 g





ELAN 4 electro 2-RING HIGH SPEED HANDPIECES

GA865

GB083R

ELAN 4 electro 2-RING HANDPIECE
L7



2-ring coding;
spray nozzle GA265SU (not included)
140 W;  ; 0-80,000 rpm; 2.2 Ncm;
176 x 16 mm;  89 g



GA866

GB083R

ELAN 4 electro 2-RING HANDPIECE
L10



2-ring coding;
spray nozzle GA266SU (not included)
140 W;  ; 0-80,000 rpm; 2.2 Ncm;
206 x 16 mm;  95 g



GA867

GB083R

ELAN 4 electro 2-RING HANDPIECE
L13

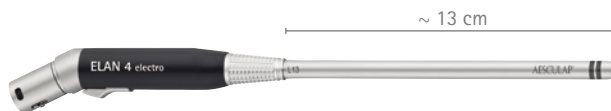

2-ring coding;
spray nozzle GA267SU (not included)
140 W;  ; 0-80,000 rpm; 2.2 Ncm;
236 x 16 mm;  100 g



GA868

GB083R

ELAN 4 electro 2-RING HANDPIECE
L17



2-ring coding;
spray nozzle GA268SU (not included)
140 W;  ; 0-80,000 rpm; 2.2 Ncm;
276 x 16 mm;  108 g



GA869

GB083R

ELAN 4 electro 2-RING HANDPIECE
L22

2-ring coding;
spray nozzle GA269SU (not included)
140 W;  ; 0-80,000 rpm; 2.2 Ncm;
326 x 16 mm;  118 g



AESCULAP® ELAN 4

ELAN 4 electro

MIS HANDPIECE & HANDPIECE SHAFTS



GA860

GB084R

ELAN 4 electro MIS HANDPIECE

for use with MIS handpiece shafts
GB920R - GB927R

140 W; ↖ ↗; 0 - 80,000 rpm;
2.2 Ncm; 118 x 17 mm; 100 g



GB920R

GB723R

**ELAN 4 MIS HANDPIECE SHAFT
L10 STRAIGHT**

spray nozzle GB796SU (not included)



GB921R

GB723R

**ELAN 4 MIS HANDPIECE SHAFT
L10 CURVED**

spray nozzle GB796SU (not included)



GB922R

GB723R

**ELAN 4 MIS HANDPIECE SHAFT
L10 HEAVY CURVED**

spray nozzle GB796SU (not included)



GB925R

GB723R

**ELAN 4 MIS HANDPIECE SHAFT
L13 STRAIGHT**

spray nozzle GB797SU (not included)



GB926R

GB723R

**ELAN 4 MIS HANDPIECE SHAFT
L13 CURVED**

spray nozzle GB797SU (not included)



GB927R

GB723R

**ELAN 4 MIS HANDPIECE SHAFT
L13 HEAVY CURVED**

spray nozzle GB797SU (not included)



AESCLAP[®] ELAN 4

ELAN 4 electro

SAWS



GA836

GB086R

ELAN 4 electro MICRO SAGITTAL SAW
spray nozzle GA258SU (not included)
180 W; 0 - 20,000 rpm; 161 x 23 mm;
 \sphericalangle 7°; \updownarrow 190 g

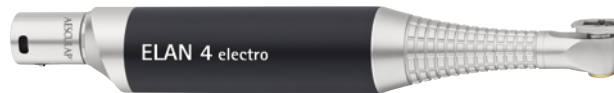

GA837

GB087R

ELAN 4 electro
MICRO RECIPROCATING SAW
spray nozzle GA258SU (not included)
180 W; 0 - 20,000 rpm; 184 x 23 mm;
 \updownarrow 1.3 mm; \updownarrow 198 g



GA831

GB088R

ELAN 4 electro SAGITTAL SAW
spray nozzle GA258SU (not included)
180 W; 0 - 20,000 rpm; 129 x 23 mm;
 \sphericalangle 4.5°; \updownarrow 220 g



GA832

GB087R

ELAN 4 electro RECIPROCATING SAW
spray nozzle GA258SU (not included)
180 W; 0 - 20,000 rpm; 194 x 23 mm;
 \updownarrow 2.5 mm; \updownarrow 238 g



GA833

GB088R

ELAN 4 electro TRANSVERSAL SAW
spray nozzle GA258SU (not included)
180 W; \sphericalangle \sphericalangle ; 0 - 20,000 rpm; 10 Ncm;
130 x 23 mm; \sphericalangle 10°; \updownarrow 185 g
to be used with saw blade shafts
GP580R, GP582R, GP586R and GP590R

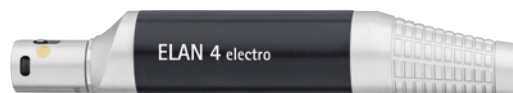

AESCULAP® ELAN 4

ELAN 4 electro

DRILL





GA844

GB482R

ELAN 4 electro DRILL

with fixed motor cable, oscillating and tapping mode

200 W;  3.2 mm;
122 x 130 x 27 mm;  800 g

consisting parts:

GA344244 K-wire protection guide

TA011944 cleaning brush

GA344211 rinsing adapter

GB600880 Sterilit® spray adapter

Requires control unit with software version V3.00.





GB870R

GB716R

INTRAMEDULLARY REAMER ATTACHMENT

with Jacobs chuck 0.5 - 7.4 mm, not for use with acetabulum reamers

0 - 320 rpm; 6.5 Nm;  3.2 mm;
105 x 29 mm;  230 g

consisting parts:

key GA031R





GB871R

GB716R

INTRAMEDULLARY REAMER ATTACHMENT

with large AO chuck, not for use with acetabulum reamers

0 - 320 rpm; 6.5 Nm;  3.2 mm;
88 x 29 mm;  170 g





GB872R

GB716R

INTRAMEDULLARY REAMER ATTACHMENT

with Hudson/Zimmer chuck, not for use with acetabulum reamers

0 - 320 rpm; 6.5 Nm;  3.2 mm;
86 x 25 mm;  150 g



AESCULAP® ELAN 4



ELAN 4 electro ATTACHMENTS

GB881R

GB716R

DRILL ATTACHMENT

with Jacobs chuck 0.5 - 7.4 mm

0 - 1,250 rpm; 2 Nm;  3.2 mm;
89 x 29 mm;  163 g

consisting parts:
key GA031R

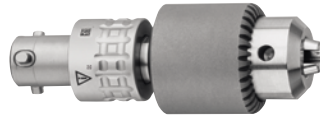



GB882R

GB716R

DRILL ATTACHMENT

with Jacobs chuck 0.5 - 4 mm

0 - 1,250 rpm; 2 Nm;  3.2 mm;
76 x 22 mm;  100 g

consisting parts:
key GA062R





GB884R

GB716R

DRILL ATTACHMENT

with small AO chuck

0 - 1,250 rpm; 2 Nm;  2.8 mm;
60 x 22 mm;  66 g





GB886R

GB716R

DRILL ATTACHMENT

with AESCULAP® hexagonal chuck

0 - 1,250 rpm; 2 Nm;  3.2 mm;
57 x 24 mm;  67 g





GB887R

GB716R

DRILL ATTACHMENT

with Dental shank

0 - 1,250 rpm; 2 Nm;  1.8 mm;
56 x 22 mm;  50 g



GB878R

GB716R

DRILL ATTACHMENT

for Synthes radiolucent drive 511.300

0 - 1,250 rpm; 2 Nm;
111 x 27 mm; 181 g



GB894R

GB716R

K-WIRE ATTACHMENT

for K-wires from 0.6 - 3.2 mm

0 - 1,250 rpm; 3.2 mm;
92 x 27 x 124 mm; 179 g



GB891R

GB716R

SAGITTAL SAW ATTACHMENT

for "L-sagittal" sawblades

0 - 15,750 rpm; 74 x 33.5 mm;
4.5°; 179 g



GB892R

GB716R

RECIPROCATING SAW ATTACHMENT

for reciprocating sawblades

0 - 15,750 rpm; 135 x 24.5 mm;
2.5 mm; 166 g



AESCULAP® ELAN 4



ELAN 4 electro
ATTACHMENTS

GB896R

GB716R

SCREW ATTACHMENT

with small AO chuck

0 - 165 rpm; 12 Nm;  1.7 mm;
95 x 28 x 129.5 mm;  235 g





GB897R

GB716R

SCREW ATTACHMENT

with AESCULAP® hexagonal chuck

0 - 165 rpm; 12 Nm;  1.7 mm;
92 x 28 x 129.5 mm;  231 g



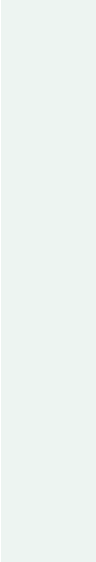

AESCLAP® ELAN 4

ELAN 4 ACCESSORIES

GB861P

GB727R

ELAN 4 LENGTH REDUCTION SLEEVE
for use with 1-ring handpieces



GB863P

GB727R

ELAN 4 LENGTH REDUCTION SLEEVE
for use with 2-ring handpieces



GB862P

GB727R

ELAN 4 MIS SLEEVE
for use with 1-ring handpieces



GB866R

ELAN 4 LATERAL BURR GUARD
for use with 1-ring handpieces and
burrs up to 4.5 mm diameter



TE780

POWER CORD
Europe,  1.5 m

TE730

POWER CORD
Europe,  5.0 m

TE734

POWER CORD
UK,  5.0 m

TE735

POWER CORD
USA, Canada, Japan,  3.5 m



GA395SU

sterile  

ELAN 4 electro DISPOSABLE TUBE SET

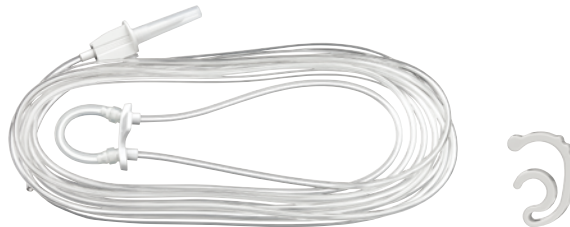

ELAN 4 SPRAY NOZZELS

sterile 

GA259SU

for craniotome attachments

GA261SU

for 1-ring handpiece L4

GA262SU

for 1-ring handpiece L7

GA263SU

for 1-ring handpiece L10

GA264SU

for 1-ring handpiece L13

GA265SU

for 2-ring handpiece L7

GA266SU

for 2-ring handpiece L10

GA267SU

for 2-ring handpiece L13

GA268SU

for 2-ring handpiece L17

GA269SU

for 2-ring handpiece L22

GB796SU

for MIS handpiece shafts L10

GB797SU

for MIS handpiece shafts L13



GA258SU

for saws



AESCLAP® Acculan 4

LOOK. FEEL. EXPERIENCE.

Acculan 4 the battery-operated power system for orthopaedics, traumatology, cardiothoracic surgery and dermatology

- Powerful
- Longevity – Exclusion of battery and electronic control from sterilization process
- Easy handling – **Titanium** housing allows mechanical alkaline reprocessing



AESCULAP® Acculan 4

DRILL & ATTACHMENTS

GA330

GB495R

Acculan 4 DRILL AND REAMER

250 W;  4.0 mm;
207 x 121 x 55 mm;  1,250 g

consisting parts:

GA678 sterile funnel

GA672207 K-wire protection sleeve

TA011944 cleaning brush

GA672211 rinsing adapter

GB600840 Sterilit® spray adapter

Acculan

Lid GA675 and NiMH battery GA676 to be ordered separately.

Measurements and weight are including battery and lid.





GB620R

GB496R

Acculan 4 DRILL ATTACHMENT

with Jacobs chuck keyless 0.5 - 7.4 mm

 4.0 mm;
0 - 1,000 rpm; 5.0 Nm;  397 g





GB621R

GB496R

Acculan 4 DRILL ATTACHMENT

with Jacobs chuck 0.5 - 7.4 mm

 4.0 mm;
0 - 1,000 rpm; 5.0 Nm;  300 g

consisting parts:

key GA031R

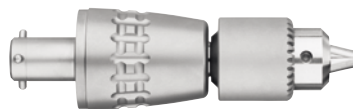



GB623R

GB496R

Acculan 4 DRILL ATTACHMENT

with small AO chuck

 2.8 mm;
0 - 1,250 rpm; 4.0 Nm;  210 g





ATTACHMENTS

GB639R

GB496R

Acculan 4 DRILL ATTACHMENT

with Jacobs chuck 0.5 – 4.0 mm

0 – 1,250 rpm; 4.0 Nm;  4.0 mm;
105 x 35 mm;  243 g

consisting parts:
key GA062R



GB645R

GB496R

Acculan DRILL ATTACHMENT

for Synthes radiolucent drive 511.300

0 – 900 rpm; 110 x 35 mm;  225 g





GB663R

GB496R

Acculan 4 DRILL ATTACHMENT

with trinkle chuck

0 – 1,000 rpm; 5.0 Nm;  4.0 mm;
93 x 35 mm;  217 g





GB664R

GB496R

Acculan 4 DRILL ATTACHMENT

with AESCULAP® hexagonal chuck

0 – 1,000 rpm; 5.0 Nm;  4.0 mm;
86 x 35 mm;  225 g





GB665R

GB496R

Acculan 4 DRILL ATTACHMENT

with Hudson / Zimmer chuck

0 – 1,000 rpm; 5.0 Nm;  4.0 mm;
100 x 35 mm;  230 g



AESCULAP® Acculan 4



ATTACHMENTS

GB657R

GB496R

Acculan 4 INTRAMEDULLAR ATTACHMENT

with large AO chuck

0 - 370 rpm; 12.0 Nm;  4.0 mm;
108 x 35 mm;  300 g





GB667R

GB496R

Acculan 4 REAMER ATTACHMENT

with Jacobs chuck 0.5 - 7.4 mm chuck

0 - 250 rpm; 19.0 Nm;  4.0 mm;
133 x 35 mm;  280 g

consisting parts:
key GA031R

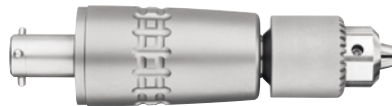



GB668R

GB496R

Acculan 4 REAMER ATTACHMENT

with large AO chuck

0 - 250 rpm; 19.0 Nm;  4.0 mm;
108 x 35 mm;  300 g





GB669R

GB496R

Acculan 4 REAMER ATTACHMENT

with Hudson / Zimmer chuck

0 - 250 rpm; 19.0 Nm;  4.0 mm;
118 x 35 mm;  300 g





GB670R

GB496R

Acculan 4 REAMER ATTACHMENT

with Harris chuck

0 - 250 rpm; 19.0 Nm;  4.0 mm;
106 x 35 mm;  290 g



GB660R

GB496R

Acculan **SAGITTAL SAW ATTACHMENT**

for Acculan rapid action saw blades with a **maximum useable length of 50 mm**

«» **0 - 17,000 rpm**; \angle 4°47';
89 x 36 x 44 mm; ♁ 270 g



GB641R

GB496R

Acculan **K-WIRE ATTACHMENT**

for K-wires from **0.6 - 4.0 mm**

0 - 1,250 rpm; 93 x 36 x 137 mm;
 ♁ 285 g



AESCULAP® Acculan 4

OSCILLATING SAWS

GA331

GB495R

Acculan 4 OSCILLATING SAW

250 W; \leftrightarrow 0 - 13,000 rpm; \sphericalangle 4.1°;
211 x 177 x 55 mm; \updownarrow 1,600 g

consisting parts:
GA678 sterile funnel

Lid GA675 and NiMH battery GA676 to
be ordered separately.

Measurements and weight are including
battery and lid.



GA336

GB498R

Acculan 4 OSCILLATING SAW STRAIGHT

250 W; \leftrightarrow 0 - 13,000 rpm; \sphericalangle 4.1°;
290 x 55 x 84 mm; \updownarrow 1,480 g

consisting parts:
GA678 sterile funnel

Lid GA675 and NiMH battery GA676 to
be ordered separately.

Measurements and weight are including
battery and lid.



GA337

GB498R

Acculan 4 OSCILLATING STERNUM SAW

250 W; \leftrightarrow 0 - 13,000 rpm; \sphericalangle 4.1°;
290 x 55 x 84 mm; \updownarrow 1,480 g

consisting parts:
GA678 sterile funnel

Lid GA675 and NiMH battery GA676 to
be ordered separately.

Measurements and weight are including
battery and lid.



RECIPROCATING SAW

GA334

GB495R

Acculan 4 RECIPROCATING SAW

250 W; ↔ 0 - 15,000 rpm; ↓ 3.2 mm;
207 x 180 x 55 mm; ⚖ 1,540 g

consisting parts:

GA678 sterile funnel

GB440215 cleaning plate

GA674890 cleaning adapter

Lid GA675 and NiMH battery GA676 to
be ordered separately.

Measurements and weight are including
battery and lid.



GB436R

GB686R

PROTECTION GUIDE

for use with GA334 and saw blade
GC761R



AESCULAP® Acculan 4

DERMATOME

GA340

GB498R

Acculan 4 DERMATOME

width keyless adjustable;
thickness adjustable (1 / 10 mm steps);
cutting thickness: 0.2 - 1.2 mm;
cutting width: max. 78 mm;
suitable blades: GB228R
(to be ordered separately)

250 W; ↔ 0 - 6,500 rpm; ↑↓ 3.1 mm;
277 x 113 x 83 mm; ⚖ 1,650 g

consisting parts:
GA678 sterile funnel

Lid GA675 and small Li-Ion battery
GA346 to be ordered separately.

Measurements and weight are including
battery and lid.



GA341

GB498R

Acculan 4 DERMATOME 0.1 MM

width keyless adjustable;
thickness adjustable (1 / 10 mm steps);
cutting thickness: 0.1 - 1.1 mm;
cutting width: max. 78 mm;
suitable blades: GB228R
(to be ordered separately)

250 W; ↔ 0 - 6,500 rpm; ↑↓ 3.1 mm;
277 x 113 x 83 mm; ⚖ 1,650 g

consisting parts:
GA678 sterile funnel

Lid GA675 and small Li-Ion battery
GA346 to be ordered separately.

Measurements and weight are including
battery and lid.



BA720R

GB688R

SKIN GRAFT MESHER

for use in combination with skin graft
carriers BA721 (1:1.5) / BA722 (1:3) /
BA723 (1:6)

150 x 195 x 105 mm; ⚖ 4,800 g

consisting parts:
BA725R cutting roller
BA726R ratchet wrench



AESCULAP® Acculan 4

LOOK. FEEL. EXPERIENCE.

Acculan 4 small drill – the smallest member of the Acculan 4 family can be used for small fragment Osteosynthesis as well as for reamed intramedullary nailing.



AESCULAP® Acculan 4

SMALL DRILL

DRILL & ATTACHMENTS

GA344

GB482R

Acculan 4 SMALL DRILL

with oscillating and tapping mode;
not for use with acetabulum reamers

85 W;  3.2 mm;
177 x 124 x 55 mm;  840 g

consisting parts:

GA678 sterile funnel

GA344244 K-wire protection guide

TA011944 cleaning brush

GA344211 rinsing adapter

GB600880 Sterilit® spray adapter

Lid GA675 and small Li-Ion battery
GA346 to be ordered separately.

Measurements and weight are including
battery and lid.





GB870R

GB716R

INTRAMEDULLARY REAMER ATTACHMENT

with Jacobs chuck 0.5 - 7.4 mm,
not for use with acetabulum reamers

0 - 320 rpm; 5 Nm;  3.2 mm;
105 x 29 mm;  230 g

consisting parts:

key GA031R





GB871R

GB716R

INTRAMEDULLARY REAMER ATTACHMENT

with large AO chuck,
not for use with acetabulum reamers

0 - 320 rpm; 5 Nm;  3.2 mm;
88 x 29 mm;  170 g





GB872R

GB716R

INTRAMEDULLARY REAMER ATTACHMENT

with Hudson/Zimmer chuck,
not for use with acetabulum reamers

0 - 320 rpm; 5 Nm;  3.2 mm;
86 x 25 mm;  150 g





SMALL DRILL ATTACHMENTS

GB881R

GB716R

DRILL ATTACHMENT

with Jacobs chuck 0.5 - 7.4 mm

0 - 1,250 rpm; 1.5 Nm;  3.2 mm;
89 x 29 mm;  163 g

consisting parts:
key GA031R





GB882R

GB716R

DRILL ATTACHMENT

with Jacobs chuck 0.5 - 4 mm

0 - 1,250 rpm; 1.5 Nm;  3.2 mm;
76 x 22 mm;  100 g

consisting parts:
key GA062R

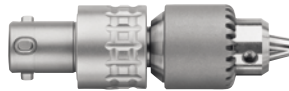



GB884R

GB716R

DRILL ATTACHMENT

with small AO chuck

0 - 1,250 rpm; 1.5 Nm;  2.8 mm;
60 x 22 mm;  66 g





GB886R

GB716R

DRILL ATTACHMENT

with AESCULAP® hexagonal chuck

0 - 1,250 rpm; 1.5 Nm;  3.2 mm;
57 x 24 mm;  67 g





GB887R

GB716R

DRILL ATTACHMENT

with Dental shank

0 - 1,250 rpm; 1.5 Nm;  1.8 mm;
56 x 22 mm;  50 g



AESCU LAP[®] Acculan 4

SMALL DRILL ATTACHMENTS

GB878R

GB716R

DRILL ATTACHMENT

for Synthes radiolucent drive 511.300

0 - 1,250 rpm; 1.5 Nm;
111 x 27 mm; 181 g

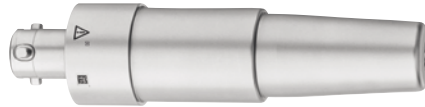

GB894R

GB716R

K-WIRE ATTACHMENT

for K-wires from 0.6 - 3.2 mm

0 - 1,250 rpm; 3.2 mm;
92 x 27 x 124 mm; 179 g



GB891R

GB716R

SAGITTAL SAW ATTACHMENT

for "L-sagittal" sawblades

0 - 15,750 rpm; 74 x 33.5 mm;
4.5°; 179 g



GB892R

GB716R

RECIPROCATING SAW ATTACHMENT

for reciprocating saw blades

0 - 15,750 rpm; 135 x 24.5 mm;
166 g; 2.5 mm





GB896R

GB716R

SCREW ATTACHMENT

with small AO chuck

0 - 165 rpm; 10 Nm;  1.7 mm;
95 x 28 x 129.5 mm;  235 g





GB897R

GB716R

SCREW ATTACHMENT

with AESCULAP® hexagonal chuck

0 - 165 rpm; 10 Nm;  1.7 mm;
92 x 28 x 129.5 mm;  231 g



AESCULAP® Acculan 4

CHARGER & BATTERIES

GA320

Acculan 4 CHARGER

for Acculan Li-Ion and NiMH batteries
GA346, GA676; 4 charging bays;
automatic battery diagnosis function;
power cord not included

100 - 240 V AC; 50 / 60 Hz;
410 x 120 x 160 mm; 2,300 g



GA346

Acculan 4 LI-ION BATTERY SHORT

only for GA340, GA341 and GA344;
with integrated electronic motor
control 9.9 V; 10.89 Wh

120 x 43 x 50 mm; 265 g



GA676

Acculan NIMH BATTERY

only for GA330, GA331, GA334, GA336,
GA337; with integrated electronic
motor control 9.6 V; 1.95 Ah

140 x 43 x 50 mm; 425 g



GA679

GB489R

Acculan BATTERY REMOVAL DEVICE



GA675

GB487R

Acculan LID

90 g



GA678

GB488R

Acculan STERILE FUNNEL



AESCULAP® Acculan 4 Electro

LOOK. FEEL. EXPERIENCE.

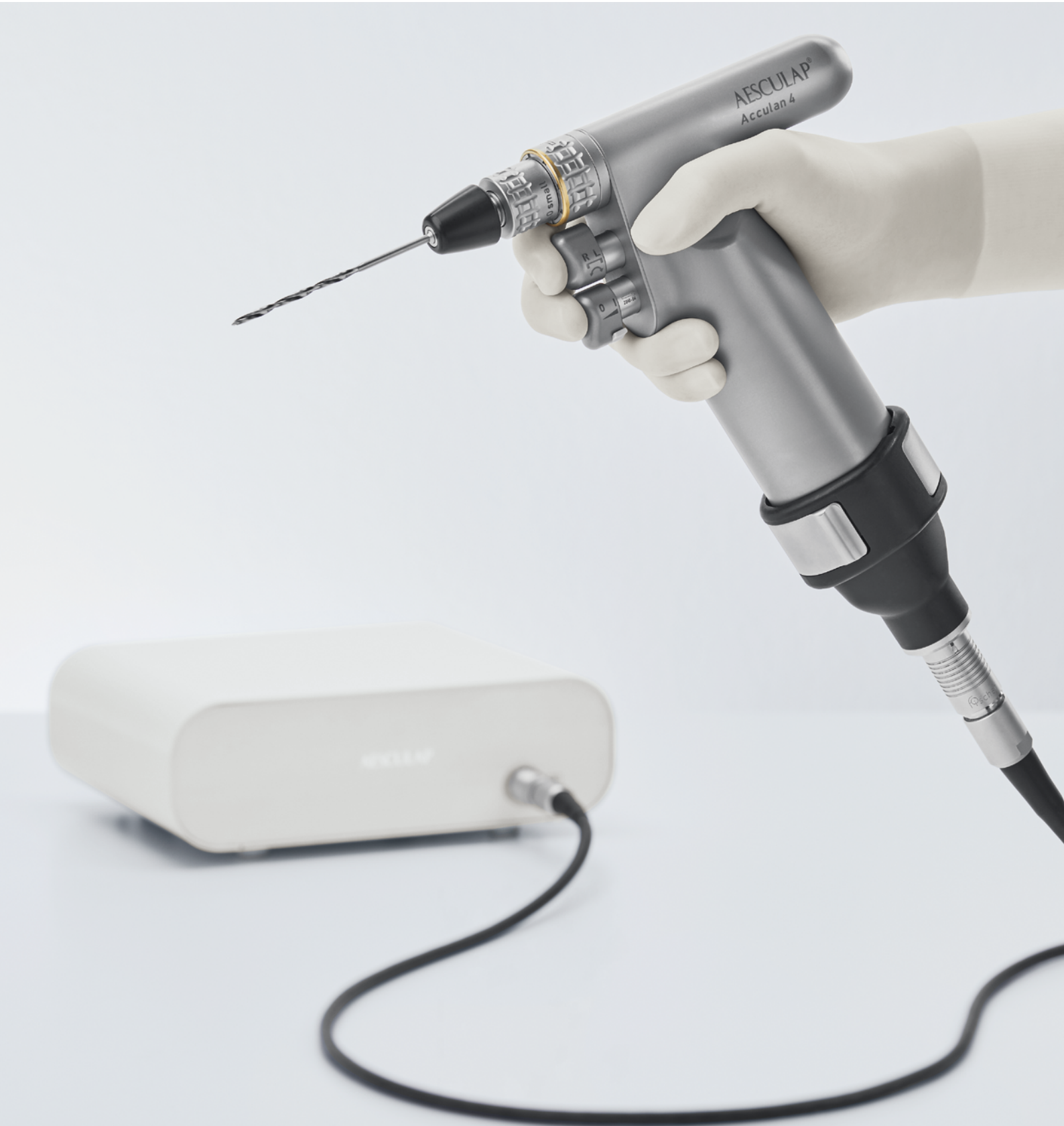

CONSOLE & BATTERIES

GA877

Acculan Electro CONSOLE
power cord not included
100 – 240 V AC; 50 / 60 Hz;
255 x 217 x 90 mm; 2,930 g

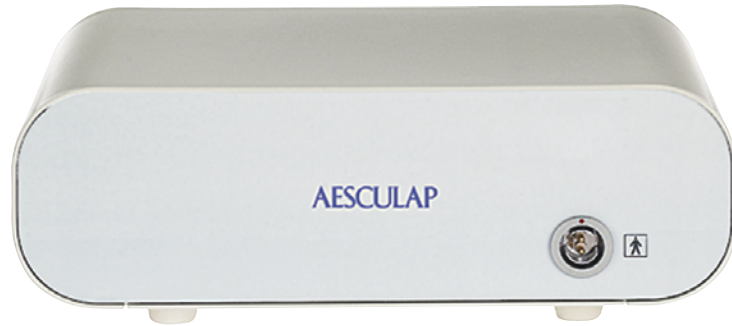

GA878

GB486R

Acculan Electro CONNECTION CABLE
for use with Acculan 4 handpieces
3.0 m; 410 g



GA875

GB485R

Acculan Electro LID



GA876

Acculan Electro ADAPTER
120 x 49 x 42 mm; 165 g



GA678















GB488R

Acculan STERILE FUNNEL



AESCULAP® Acculan 4 ACCESSORIES

ADAPTERS, KEYS & POWER CORD

| | | | |
|--------------------------------------------------------------------------------------------------------------------------------------------------------------------------------------------------------------------------------------------------------------------------------------------------------------------|----------------------------------------------------------------------------------------------------------------------------------------------------------------------------------------------------------------------------------------------------------|----------------------------------------------------------------------------------------------------------------------------------------------------------------------------------------------------------------------------------------------------------|--|
| <p>GB176R GB690R</p> <p>ZIMMER ADAPTER</p> <p>tool: Zimmer motor: Hudson/Zimmer only in combination with GB630R, GB656R, GB665R, GB669R or GB872R</p> <p> 3.0 mm</p> | <p>GB414R JG344</p> <p>AESCULAP® HEX ADAPTER</p> <p>tool: AESCULAP® hexagonal motor: triangular</p> <p> 3.5 mm</p> | <p>GB628R JG344</p> <p>SYNTHES DHS /DCS ADAPTER</p> <p>tool: Synthes DHS /DCS motor: AO large</p> <p> 4.0 mm</p> | |
|  |  |  | |
| <p>GB184R JG344</p> <p>HARRIS ADAPTER</p> <p>tool: Harris motor: AO large</p> <p> 3.4 mm</p> | <p>XF457R JG344</p> <p>DIN ADAPTER</p> <p>tool: DIN motor: AO large</p> <p> 3.7 mm</p> | <p>GA031R JG342 + JG344</p> <p>KEY</p> <p>for large Jacobs chuck suitable for GB620R, GB621R, GB667R, GB870R, GB881R</p> | |
|  |  |  | |
| <p>GA062R JG342</p> <p>KEY</p> <p>for small 4 mm Jacobs chuck suitable for GB639R, GB882R</p> | | | |
|  | | | |
| <p>TE780</p> | <p>TE734</p> |  | |
| <p>POWER CORD Europe,  1.5 m</p> | <p>POWER CORD UK,  5.0 m</p> | | |
| <p>TE730</p> | <p>TE735</p> | | |
| <p>POWER CORD Europe,  5.0 m</p> | <p>POWER CORD USA, Canada, Japan,  3.5 m</p> | | |

AESFULAP® PROCESSING

Sterilit® POWER SYSTEMS



PROCESSING

AESCALAP® PROCESSING

Sterilit® POWER SYSTEMS

GB600



Sterilit® POWER SYSTEMS
oil spray; 300 ml



GB600860

Sterilit® POWER SYSTEMS SPRAY
ADAPTER

for ELAN 4 electro



GB600870

Sterilit® POWER SYSTEMS SPRAY
ADAPTER

for ELAN 4 MIS handpiece shafts



GB600840

Sterilit® POWER SYSTEMS SPRAY
ADAPTER

for Acculan 4



GB600880

Sterilit® POWER SYSTEMS SPRAY
ADAPTER

for Acculan 4 small drill and ELAN 4
electro drill



AESFULAP® MECHANICAL PROCESSING

- The solution for storage and mechanical reprocessing of our AESFULAP® Power Systems.
- For detailed information please refer to the instructions for use.



AESULAP[®] MECHANICAL PROCESSING

ECCOS[®] SETS

ELAN 4

GB261R

ELAN 4 electro ECCOS[®] SET

 56 mm

consisting parts:

GB073R

GB076R

GB083R

GB085R

GB719R

GB072R

JF212R

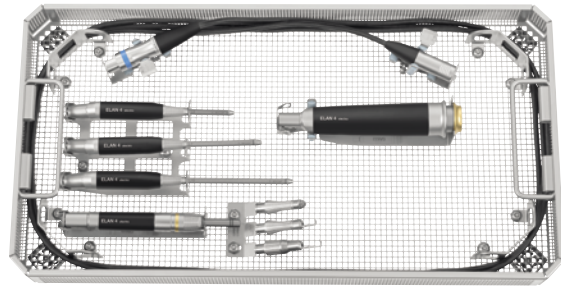

GB262R

ELAN 4 electro ECCOS[®] SET FOR DRILL GA844

 106 mm

consisting parts:

GB072R

GB073R

GB482R

GB715R

GB716R







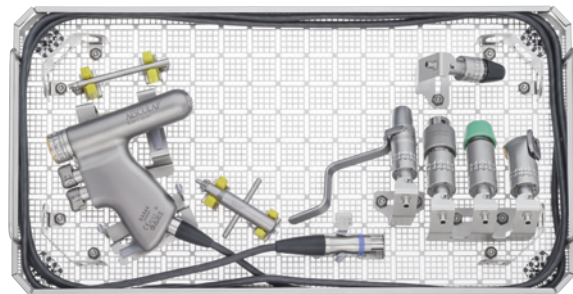





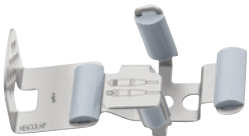
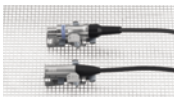









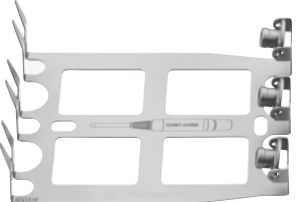

2x GB690R

JG342

JG344









ECCOS®
ELAN 4 electro

| | | |
|-------------------------------------------------------------------------------------------------------------------------------------------------------------------------------------------------------------------|------------------------------------------------------------------------------------------------------------------------------------------------------------------------------------|---------------------------------------------------------------------------------------------------------------------------------------------------------------------------|
| <p>GB073R</p> <p>ECCOS® HOLDER for motor cable GA804, GA805, GA806 (set consisting of 2 pieces)</p>  56 mm | <p>GB076R</p> <p>ECCOS® HOLDER for perforator driver GA822</p>  56 mm | <p>GB077R</p> <p>ECCOS® HOLDER for intra motor GA824</p>  56 mm |
|   |   |   |
| <p>GB082R</p> <p>ECCOS® HOLDER for 1 handpiece</p>  56 mm | <p>GB083R</p> <p>ECCOS® HOLDER for 3 handpieces</p>  56 mm | <p>GB085R</p> <p>ECCOS® HOLDER for craniotome GA849</p>  56 mm |
|   |   |   |
| <p>GB086R</p> <p>ECCOS® HOLDER for micro sagittal saw GA836</p>  56 mm | <p>GB087R</p> <p>ECCOS® HOLDER for reciprocating saws GA832, GA837</p>  56 mm | <p>GB088R</p> <p>ECCOS® HOLDER for saws GA831, GA833</p>  56 mm |
|   |   |   |

AESULAP[®] MECHANICAL PROCESSING

ECCOS[®]

ELAN 4 electro

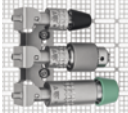
| GB482R | GB715R | GB716R |
|----------------------------------------------------------------------------------------------------------------------------------------------------------------------|------------------------------------------------------------------------------------------------------------------------------------------------------------------------------------------------------------------------------|---------------------------------------------------------------------------------------------------------------------------------------------------------------------------------------------------------------------------------|
| <p>ECCOS[®] HOLDER for ELAN 4 electro drill GA844</p>  106 mm | <p>ECCOS[®] HOLDER for 1 attachment GB870R, GB871R, GB872R, GB878R, GB881R, GB884R, GB892R, GB896R, GB897R</p>  106 mm | <p>ECCOS[®] HOLDER for 3 attachments GB870R, GB871R, GB872R, GB878R, GB881R, GB884R, GB892R, GB896R, GB897R</p>  106 mm |
|   |   |   |

ECCOS® & RINSING DEVICES

ELAN 4 electro

GB084R

ECCOS® HOLDER

for MIS handpiece GA860

 56 mm

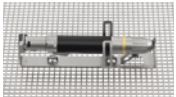

GB723R

ECCOS® HOLDER

for MIS handpiece shafts GB920R - GB927R

 56 mm



GB692R

RINSING DEVICE

for applied parts, incl. ceramic filter GB693 
(not suitable for autoclaving)

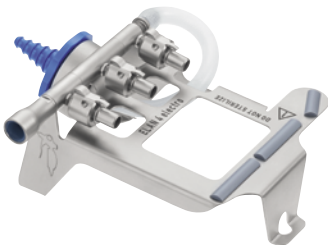

GB679R

RINSING DEVICE

for 4 MIS shafts, incl. ceramic filter GB693 
(not suitable for autoclaving)

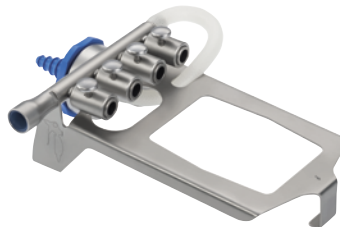

GB698R

RINSING ADAPTER

for applied parts
(for manual cleaning)



GB699R

RINSING ADAPTER













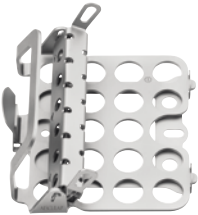









for MIS shafts
(for manual cleaning)



AESCULAP® MECHANICAL PROCESSING

ECCOS®

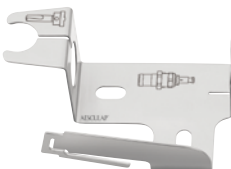
ELAN 4 ACCESSORIES

| | | |
|---------------------------------------------------------------------------------------------------------------------------------------------------------------------------------|-----------------------------------------------------------------------------------------------------------------------------------------------------|-------------------------------------------------------------------------------------------------------------------------------------------------------------------------------|
| <p>GB718R</p> | <p>GB719R</p> | <p>GB720R</p> |
| <p>ECCOS® HOLDER for 12 1- and 2-ring burrs  56 mm</p> | <p>ECCOS® HOLDER for 3 craniotome attachments  56 mm</p> | <p>ECCOS® UNIVERSAL HOLDER for saw blades  56 mm</p> |
|  |  |  |
|  |  |  |
| <p>GB729R</p> | <p>GB730R</p> | <p>GB072R</p> |
| <p>ECCOS® HOLDER for 2 reciprocating saw shafts  56 mm</p> | <p>ECCOS® HOLDER for 2 transversal saw shafts  56 mm</p> | <p>ECCOS® CABLE/HOSE POS. GUIDE for cable and hoses (set of 4 pieces)  56 mm</p> |
|  |  |  |
|  |  |  |
| <p>GB727R</p> | <p>GB572R</p> | |
| <p>ECCOS® HOLDER for handpiece holding-sleeves GB861P, GB862P, GB863P  56 mm</p> | <p>ECCOS® FIXATION for GB300R - GB304R  56 mm</p> | |
|  |  | |
|  |  | |

ECCOS® SETS

Acculan 4

GB257R

ECCOS® SET

for Acculan 4 small drill GA344

 106 mm

consisting parts:

GB482R

GB487R

GB488R

GB715R

GB716R

2x GB690R

JG342

JG344

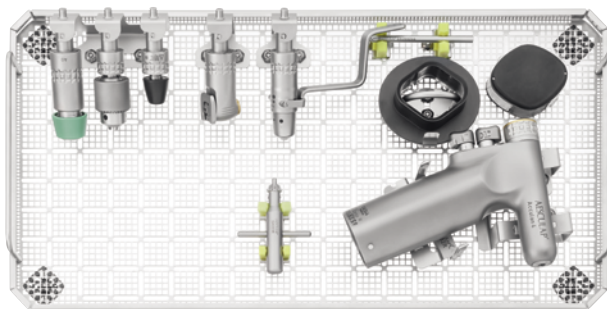

GB243R

ECCOS® SET

for 2 Acculan 4 machines

 106 mm

consisting parts:

GB481R

GB487R

GB488R

GB495R

GB496R

GB497R

2x GB690R

JG342

JG344

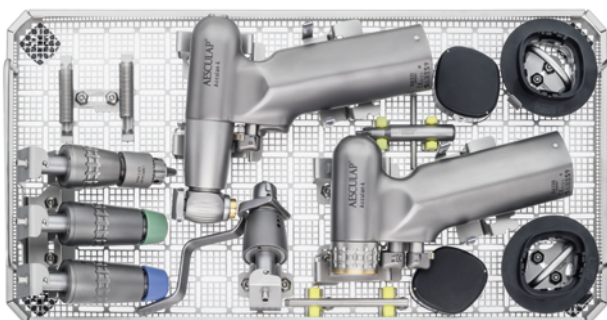

GB256R

ECCOS® SET

for Acculan 4 dermatome

 106 mm

consisting parts:

GB487R

GB488R

GB498R



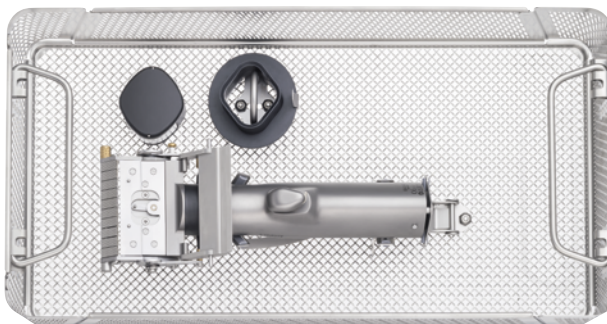











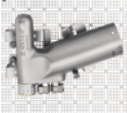

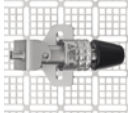
JJ464R



AESULAP[®] MECHANICAL PROCESSING

ECCOS[®]

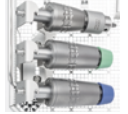
Acculan 4

| | | |
|-----------------------------------------------------------------------------------------------------------------------------------------------------------------------------------|-------------------------------------------------------------------------------------------------------------------------------------------------------------------------------------------------------------------------------------------------------------------------------|---------------------------------------------------------------------------------------------------------------------------------------------------------------------------------------------------------------------------------------------------------------------------------|
| <p>GB482R</p> <p>ECCOS[®] HOLDER for Acculan 4 small drill GA344</p>  106 mm | <p>GB715R</p> <p>ECCOS[®] HOLDER for 1 attachment GB870R, GB871R, GB872R, GB878R, GB881R, GB884R, GB892R, GB896R, GB897R</p>  106 mm | <p>GB716R</p> <p>ECCOS[®] HOLDER for 3 attachments GB870R, GB871R, GB872R, GB878R, GB881R, GB884R, GB892R, GB896R, GB897R</p>  106 mm |
|   |   |   |
| <p>GB495R</p> <p>ECCOS[®] HOLDER for GA330, GA331, GA334</p>  106 mm | <p>GB496R</p> <p>ECCOS[®] HOLDER for GB620R, GB621R, GB623R, GB639R, GB641R, GB645R GB660R, GB663R, GB664R, GB665R, GB657R, GB667R, GB668R, GB669R, GB670R</p>  106 mm | <p>GB497R</p> <p>ECCOS[®] HOLDER for GB620R, GB621R, GB623R, GB639R, GB641R, GB645R GB660R, GB663R, GB664R, GB665R, GB657R, GB667R, GB668R, GB669R, GB670R</p>  106 mm |
|   |   |   |

GB487R

ECCOS® HOLDER
for GA675

 56 mm

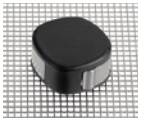
**GB488R**

ECCOS® HOLDER
for GA678

 76 mm

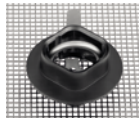
**GB489R**

ECCOS® HOLDER
for GA679

 106 mm

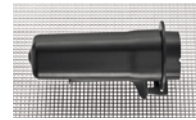
**GB498R**

ECCOS® HOLDER
for GA336, GA337, GA340, GA341

 106 mm

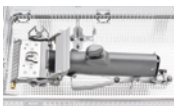
**GB686R**

ECCOS® HOLDER
for GB436R











 56 mm

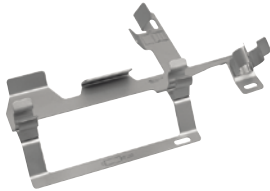
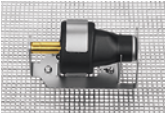
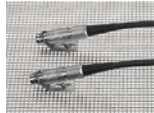

AESCALAP® MECHANICAL PROCESSING



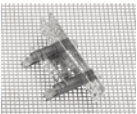

ECCOS® HOLDER

Acculan 4

| | | |
|-------------------------------------------------------------------------------------------------------------------------------------------------------------------------|--------------------------------------------------------------------------------------------------------------------------------------------------------------------------------------------|--------------------------------------------------------------------------------------------------------------------------------|
| <p>GB485R</p> | <p>GB486R</p> | <p>GB688R</p> |
| <p>ECCOS® HOLDER for GA875</p>  56 mm | <p>ECCOS® HOLDER for GA878</p>  56 mm | <p>ECCOS® HOLDER for BA720R</p>  106 mm |
|  |  |  |
|  |  |  |
| <p>GB481R</p> | <p>JF148R</p> | <p>JJ589R</p> |
| <p>ECCOS® HOLDER for saw blades and other accessories</p>  56 mm | <p>MINI TRAY WITH LID outer size: 145 x 44 x 25 mm inner size: 140 x 39 x 18 mm for storage of Acculan 4 Dermatome rod and flaps during automatic cleaning process</p> | <p>SOCKET WRENCH AF7</p> |
|   |  |  |

ECCOS® HOLDER

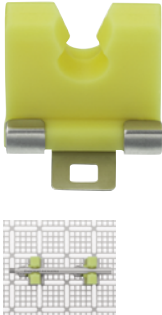
Universal Tools

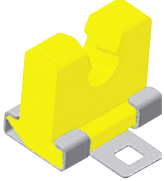
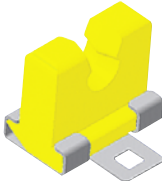
| | | |
|------------------------------------------------------------------------------------------------------------------------------------------------|-----------------------------------------------------------------------------------------------------------------------------------------|-------------------------------------------------------------------------------------------------------------------------------------------------------------------------------|
| <p>GB459R</p> <p>ECCOS® MOUNTING KIT consisting of: socket wrench AF10 and hex-wrench</p> | <p>GB690R</p> <p>ECCOS® HOLDER 5 mm for drilling wire guide GA672207, GA344244</p> | <p>JG303R </p> <p>REPLACEMENT SCREWS-SET screw nut size AF7</p> |
|  |  |  |
| <p>JG342</p> <p>SILICONE CLAMP 8.5 mm screw JG303R to be ordered separately</p> | <p>JG344</p> <p>SILICONE CLAMP 12 mm screw JG303R to be ordered separately</p> | |
|  |  | |

AESCALAP® POWER SYSTEMS

TOOL ATTACHMENTS OVERVIEW

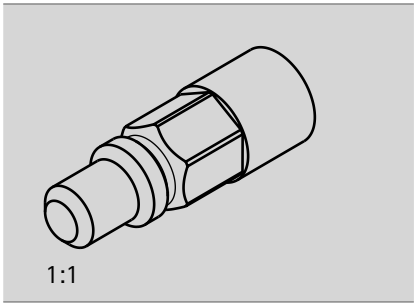

AO LARGE

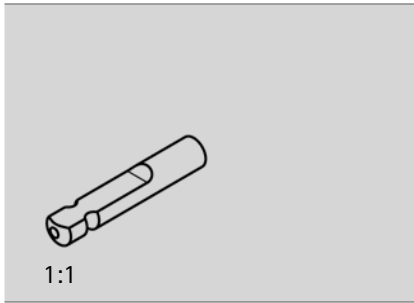

AO SMALL

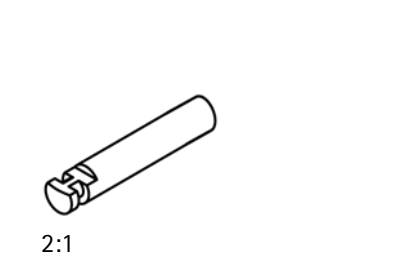

DENTAL

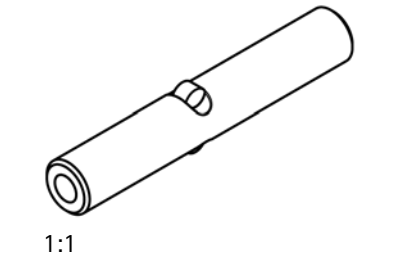

DIN

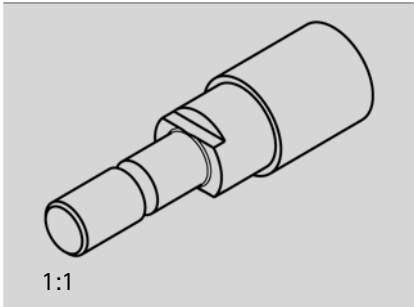

HARRIS

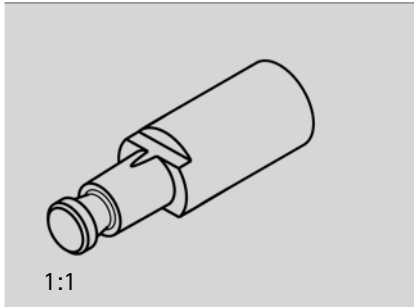

HUDSON

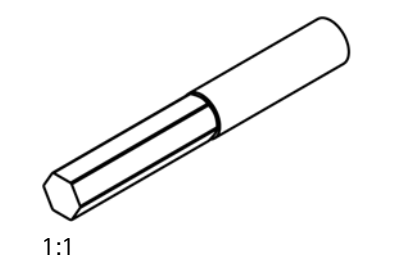

HEXAGON

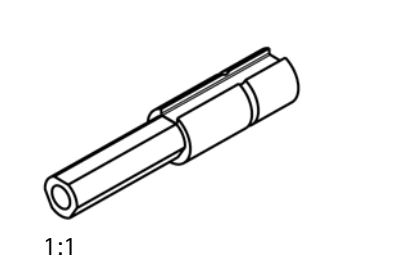

SYNTHES
DHS/DCS

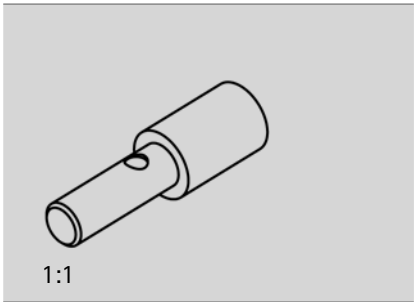



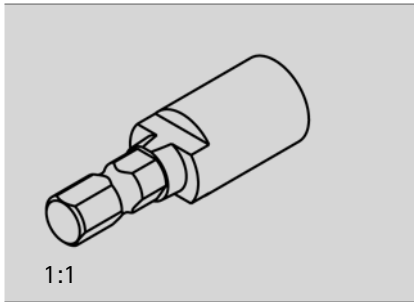











TRINKLE



ZIMMER

SIGNS & SYMBOLS

| | |
|-------------------------------------------------------------------------------------|-----------------------------------------------------------------------------------|
|  | <p>LATEX-FREE All products listed in this catalogue are latex-free</p> |
|  | <p>ARTICLE CODE ECCOS® FIXATION</p> |
|  | <p>FORWARD / REVERSE DRIVE</p> |
|  | <p>FORWARD DRIVE</p> |
|  | <p>OSCILLATION FREQUENCY</p> |
|  | <p>OSCILLATION ANGLE</p> |
|  | <p>STROKE</p> |
|  | <p>CANNULATION</p> |
|  | <p>CABLE LENGTH</p> |
|  | <p>WEIGHT</p> |
|  | <p>PACKAGING UNIT</p> |
|  | <p>SINGLE USE</p> |
|  | <p>REQUIRED HEIGHT OF TRAY</p> |
|  | <p>STERILE</p> |

AESCALAP® POWER SYSTEMS

BROCHURES

Main Catalogues

084002
Power Systems

017599
Burrs & Blades

[CLICK HERE
for Electronic Instructions for Use \(eIFU\)](#)

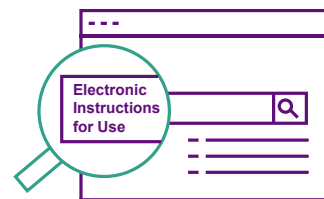

ELAN 4

071602
ELAN 4

071511
Mechanical Cleaning

012002
Manual Cleaning

Acculan 4

001802
Acculan 4

001902
Acculan 4 Dermatome

002002
Acculan 4 Electro

002102
Acculan 4 Sternum Saws

INDEX

| Art. No. |  |
|----------|-----------------------------------------------------------------------------------|
| BA720R | 32 |
| GA031R | 42 |
| GA062R | 42 |
| GA258SU | 23 |
| GA259SU | 23 |
| GA261SU | 23 |
| GA262SU | 23 |
| GA263SU | 23 |
| GA264SU | 23 |
| GA265SU | 23 |
| GA266SU | 23 |
| GA267SU | 23 |
| GA268SU | 23 |
| GA269SU | 23 |
| GA320 | 38 |
| GA330 | 26 |
| GA331 | 30 |
| GA334 | 31 |
| GA336 | 30 |
| GA337 | 30 |
| GA340 | 32 |
| GA341 | 32 |
| GA344 | 34 |
| GA346 | 38 |
| GA395SU | 23 |
| GA675 | 38 |
| GA676 | 38 |
| GA678 | 38, 41 |
| GA679 | 38 |
| GA800 | 7 |
| GA804 | 8 |
| GA805 | 8 |
| GA806 | 7 |
| GA808 | 7 |
| GA810 | 7 |
| GA822 | 8 |
| GA824 | 8 |
| GA831 | 15 |
| GA832 | 15 |
| GA833 | 15 |
| GA836 | 15 |
| GA837 | 15 |
| GA844 | 17 |
| GA849 | 9 |
| GA860 | 13 |
| GA861 | 10 |
| GA862 | 10 |
| GA863 | 10 |
| GA864 | 10 |
| GA865 | 11 |

| Art. No. |  |
|----------|-----------------------------------------------------------------------------------|
| GA866 | 11 |
| GA867 | 11 |
| GA868 | 11 |
| GA869 | 11 |
| GA875 | 41 |
| GA876 | 41 |
| GA877 | 41 |
| GA878 | 41 |
| GB072R | 50 |
| GB073R | 47 |
| GB076R | 47 |
| GB077R | 47 |
| GB082R | 47 |
| GB083R | 47 |
| GB084R | 49 |
| GB085R | 47 |
| GB086R | 47 |
| GB087R | 47 |
| GB088R | 47 |
| GB176R | 42 |
| GB184R | 42 |
| GB243R | 51 |
| GB256R | 51 |
| GB257R | 51 |
| GB261R | 46 |
| GB262R | 46 |
| GB414R | 42 |
| GB436R | 31 |
| GB459R | 55 |
| GB481R | 54 |
| GB482R | 48, 52 |
| GB485R | 54 |
| GB486R | 54 |
| GB487R | 53 |
| GB488R | 53 |
| GB489R | 53 |
| GB495R | 52 |
| GB496R | 52 |
| GB497R | 52 |
| GB498R | 53 |
| GB572R | 50 |
| GB600 | 44 |
| GB600840 | 44 |
| GB600860 | 44 |
| GB600870 | 44 |
| GB600880 | 44 |
| GB620R | 26 |
| GB621R | 26 |
| GB623R | 26 |
| GB628R | 42 |

| Art. No. |  |
|----------|------------------------------------------------------------------------------------|
| GB639R | 27 |
| GB641R | 29 |
| GB645R | 27 |
| GB657R | 28 |
| GB660R | 29 |
| GB663R | 27 |
| GB664R | 27 |
| GB665R | 27 |
| GB667R | 28 |
| GB668R | 28 |
| GB669R | 28 |
| GB670R | 28 |
| GB679R | 49 |
| GB686R | 53 |
| GB688R | 54 |
| GB690R | 55 |
| GB692R | 49 |
| GB698R | 49 |
| GB699R | 49 |
| GB715R | 48, 52 |
| GB716R | 48, 52 |
| GB718R | 50 |
| GB719R | 50 |
| GB720R | 50 |
| GB723R | 49 |
| GB727R | 50 |
| GB729R | 50 |
| GB730R | 50 |
| GB796SU | 23 |
| GB797SU | 23 |
| GB861P | 22 |
| GB862P | 22 |
| GB863P | 22 |
| GB866R | 22 |
| GB870R | 17, 34 |
| GB871R | 17, 34 |
| GB872R | 17, 34 |
| GB878R | 19, 36 |
| GB881R | 18, 35 |
| GB882R | 18, 35 |
| GB884R | 18, 35 |
| GB886R | 18, 35 |
| GB887R | 18, 35 |
| GB891R | 19, 36 |
| GB892R | 19, 36 |
| GB894R | 19, 36 |
| GB896R | 20, 37 |
| GB897R | 20, 37 |
| GB920R | 13 |
| GB921R | 13 |

| Art. No. |  |
|----------|-------------------------------------------------------------------------------------|
| GB922R | 13 |
| GB925R | 13 |
| GB926R | 13 |
| GB927R | 13 |
| GB941R | 9 |
| GB942R | 9 |
| GB943R | 9 |
| GB945R | 9 |
| GB947R | 9 |
| JF148R | 54 |
| JF212R | 46 |
| JG303R | 55 |
| JG342 | 55 |
| JG344 | 46, 55 |
| JJ589R | 54 |
| TE730 | 22, 42 |
| TE734 | 22, 42 |
| TE735 | 22, 42 |
| TE780 | 22, 42 |
| XF457R | 42 |

AESCULAP® – a B. Braun brand

Aesculap AG | Am Aesculap-Platz | 78532 Tuttlingen | Germany
Phone +49 7461 95-0 | Fax +49 7461 95-2600 | www.aesculap.com

The main product trademark "AESCULAP" and the product trademarks "ECCOS" and "Sterilit" are registered trademarks of Aesculap AG.

Subject to technical changes. All rights reserved. This brochure may only be used for the exclusive purpose of obtaining information about our products. Reproduction in any form partial or otherwise is not permitted.