

KNEE



ArthVIEW® 4K TELESCOPES

State-of-the-art Arthroscopes to achieve excellent image quality and finest details in Ultra High Definition.

4K



0° DIRECTION OF VIEW

175mm working length
225mm overall length

225-140-400



30° DIRECTION OF VIEW

175mm working length
225mm overall length

225-140-430

ArthVIEW® TELESCOPES, Ø 4.0mm

Full HD high definition pictures with increased detail-resolution through newest CAD-designed rod-lens systems.

FULL HD

● 0°
 ● 30°
 ● 45°
 ● 70°



0° DIRECTION OF VIEW

175mm working length 225-140-000



30° DIRECTION OF VIEW

175mm working length 225-140-030



45° DIRECTION OF VIEW

175mm working length 225-140-045



70° DIRECTION OF VIEW

175mm working length 225-140-070

ArthFLOW® SHEATH SYSTEM

Color coded, 360° rotating system with telescope stabilizing, for use with Ø 4.0mm telescopes.



For 30°



Universal
0°/30°/45°/70°



Operating sheath with 2 stopcocks,
Ø 5.5mm, blue colour code
225-500-255 for 30°
225-500-355 for 0°/30°/45°/70°



225-500-555 Blunt Obturator for Operating sheath Ø 5.5mm, blue colour code



225-500-655 Sharp Trocar for Operating sheath Ø 5.5mm, blue colour code

For 30°



Universal
0°/30°/45°/70°



HighFlow Operating sheath with round perforation,
with 2 stopcocks, Ø 6.0mm, red colour code

225-500-260 for 30°

225-500-360 for 0°/30°/45°/70°



225-500-560 Blunt Obturator for HighFlow Operating sheath, Ø 6.0mm
red colour code



225-500-660 Sharp Trocar for HighFlow Operating sheath, Ø 6.0mm,
red colour code

For 30°



Universal
0°/30°/45°/70°

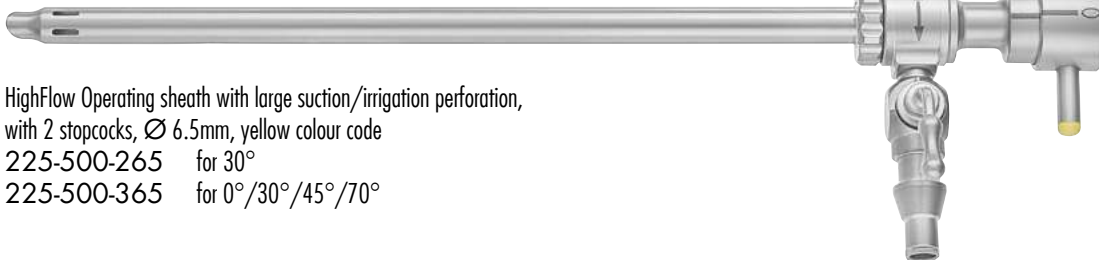

HighFlow Operating sheath with large suction/irrigation perforation,
with 2 stopcocks, Ø 6.5mm, yellow colour code

225-500-265 for 30°

225-500-365 for 0°/30°/45°/70°



225-500-565 Blunt Obturator for HighFlow Operating sheath, Ø 6.5mm,
yellow colour code



225-500-665 Sharp Trocar for HighFlow Operating sheath, Ø 6.5mm,
yellow colour code

ArthFLOW® SHEATH SYSTEM WITH QUICK-LOCK



For 30°



Universal
0°/30°/45°/70°



Quick-lock Telescope locking

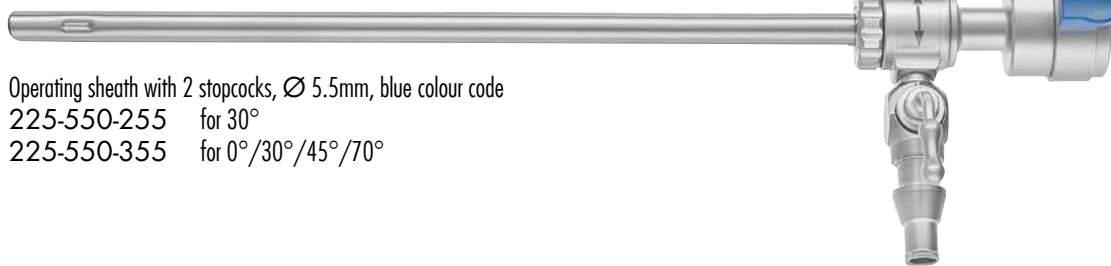

Operating sheath with 2 stopcocks, Ø 5.5mm, blue colour code
 225-550-255 for 30°
 225-550-355 for 0°/30°/45°/70°



225-500-555 Blunt Obturator for Operating sheath Ø 5.5mm, blue colour code

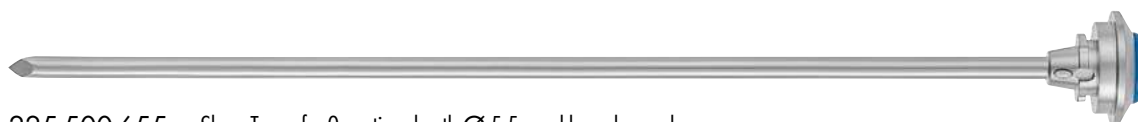

225-500-655 Sharp Trocar for Operating sheath Ø 5.5mm, blue colour code

For 30°



Universal
0°/30°/45°/70°



HighFlow Operating sheath with round perforation,
with 2 stopcocks, Ø 6.0mm, red colour code
225-550-260 for 30°
225-550-360 for 0°/30°/45°/70°

225-500-560 Blunt Obturator for HighFlow Operating sheath, Ø 6.0mm, red colour code

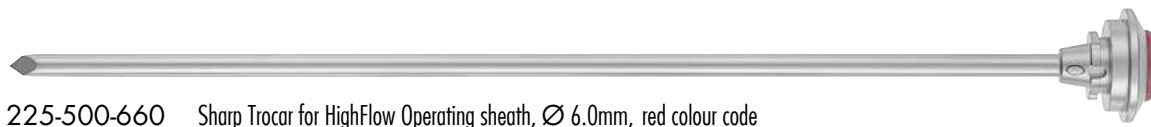

225-500-660 Sharp Trocar for HighFlow Operating sheath, Ø 6.0mm, red colour code

For 30°



Universal
0°/30°/45°/70°

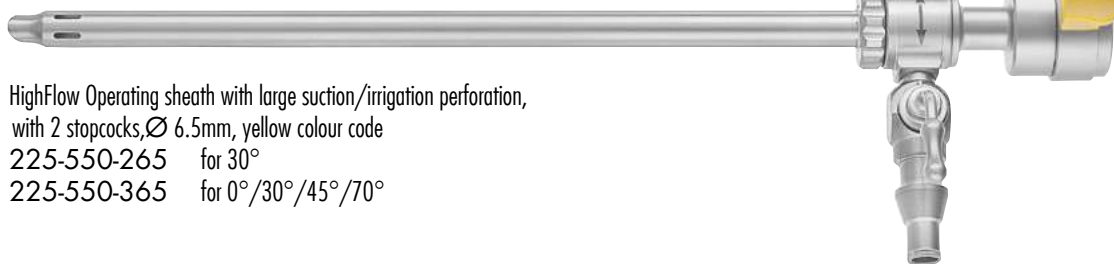

HighFlow Operating sheath with large suction/irrigation perforation,
with 2 stopcocks, Ø 6.5mm, yellow colour code
225-550-265 for 30°
225-550-365 for 0°/30°/45°/70°

225-500-565 Blunt Obturator for HighFlow Operating sheath, Ø 6.5mm, yellow colour code

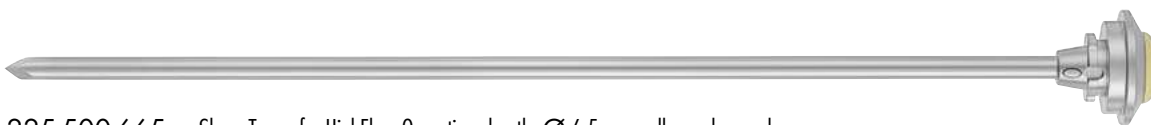

225-500-665 Sharp Trocar for HighFlow Operating sheath, Ø 6.5mm, yellow colour code

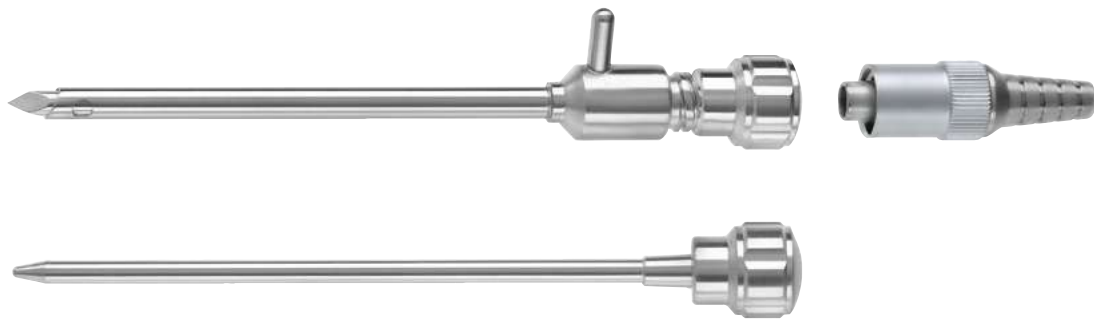

225-850-145 Inflow-Cannula 4.5mm, complete set with shaft, trocar with sharp tip, blunt obturator and irrigation adaptor



ACCESSORIES FOR SUCTION- AND IRRIGATION SYSTEM

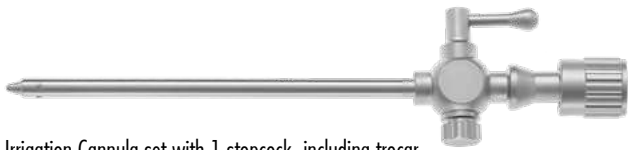

Irrigation Cannula set with 1 stopcock, including trocar and obturator, 70mm working length
 225-850-000 ∅ 2.3mm
 225-850-001 ∅ 3.5mm



300-011-181
 LuerLock tube connector 9mm



Obturator, blunt, 70mm working length
 225-850-002 ∅ 2.3mm
 225-850-004 ∅ 3.5mm



300-011-506
 LuerLock tube connector 6mm



Obturator, sharp, 70mm working length
 225-850-003 ∅ 2.3mm
 225-850-005 ∅ 3.5mm



225-852-000
 Irrigation syringe, 100ml



Guiding and changing rods for use with trocar sheath
 225-865-027 ∅ 2.7mm x 230mm
 225-865-030 ∅ 3.5mm x 230mm
 225-865-040 ∅ 4.0mm x 230mm

ArthVANCE® INSTRUMENTS

- Large product range
- Different jaws, handles and sizes
- Reliability and quality
- Made in Germany



Handle selection



1 RING HANDLE
for all Punches, Rongeurs and
different Graspers

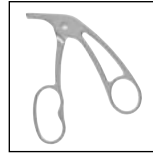

3 PRO HANDLE
special ergonomics for Scissors
and Graspers



2 RING HANDLE
with Slidlock – safe grip
for Graspers



4 CIGAR HANDLE
available for Scissors and rotatable
Punches



Shape selection

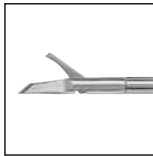

STRAIGHT
straight tip and shaft for direct access

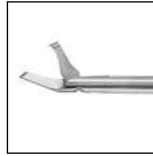

CURVED UP
instrument tip allows extended access to
posterior meniscus

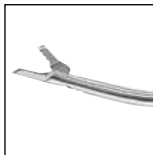

ANGLED UP
follows the shape of the condylar process
to maintain a parallel cutting surface to the
tibial plateau



**LEFT & RIGHT
CURVED AT THE SHAFT**
to reach the anterior and posterior meniscus



Note:
all Instruments could be ordered without
LuerLock optionally.



Traditional Duckbill Low profile jaw



DUCKBILL BASKET PUNCH

Multi-Purpose, low profile punches with a square bite and 3 different sizes

Small Duckbill (S)



2.5mm

Medium Duckbill (M)*



3.2mm

Large Duckbill (L)



4.5mm



RING HANDLE

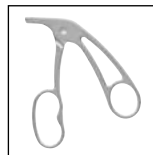

PRO HANDLE

Straight (S)
Straight (M)
Straight (L)

225-800-101
225-800-102*
225-800-103

225-700-102

UpBiter (S)
UpBiter (M)
UpBiter (L)

225-800-104
225-800-105*
225-800-106

225-700-105

Upbiter (M) Left
Upbiter (M) Right

225-800-107
225-800-109

225-700-107
225-700-109

UpSwept (M)

225-800-111

*most common pattern



Advanced Duckling Low profile jaw
Flat Upper jaw moves completely into the Lower jaw.

DUCKLING BASKET PUNCH

Multi-Purpose, low profile punches with a square bite and 2 different sizes.

Small Duckbill (S)



2.5mm

Medium Duckbill (M)*



3.5mm

Medium Duckbill (M)



RING HANDLE

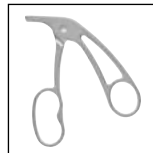

PRO HANDLE

Straight (S)

225-800-401

Straight (M)

225-800-402*

225-700-402

UpBiter (S)

225-800-404

UpBiter (M)

225-800-405*

225-700-405

UpSwept (M)

225-800-411

Straight (M) Left

225-800-413

Straight (M) Right

225-800-415



Duckling Elevator -
with flat shovel for easy access



RING HANDLE



PRO HANDLE

Straight

225-800-420

225-700-420

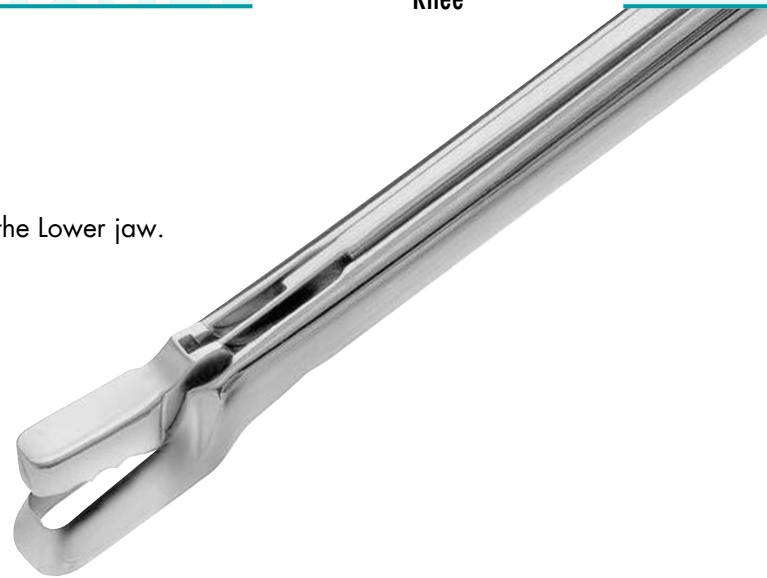



4.4mm

OVAL PUNCH

The Oval Punch offers the lowest profile and the largest bite size for end-on as well as lateral cutting – the All-rounder Punch



RING HANDLE



PRO HANDLE

„Halfmoon“ punch



RING HANDLE

Straight	225-800-202	225-700-202	Straight, left	225-800-120
UpBiter	225-800-205	225-700-205	Straight, right	225-800-121
UpSwept	225-800-211		Curved to the right	225-800-122
Straight Left	225-800-213		Curved to the left	225-800-123
Straight Right	225-800-215			



1.7mm

SLIMLINE BASKET PUNCH

The narrow shaft and compact jaw design allows access and use in tight spaces such as the posterior aspect of the knee.



RING HANDLE

Straight	225-800-002			
UpBiter	225-800-005			
UpBiter Left	225-800-007			
UpBiter Right	225-800-009			
UpSwept	225-800-011			
Jaw 45° Left	225-800-003			
Jaw 45° Right	225-800-004			





1.3mm bite

MENISCAL ELEVATOR BASKET PUNCH

The low profile extended lip of the lower jaw helps in placing the lower jaw underneath less-mobile menisci



RING HANDLE

Straight
UpBiter

225-800-902
225-800-905



1.7mm

BLUNT NOSE BASKET PUNCH

The Blunt Nose Basket Punch with square jaws enables a flush contouring of the meniscus



RING HANDLE

Straight

225-800-302



2.2mm

POSTERIOR PUNCH

Specially designed for the specific requirements of the posterior horn of the meniscus. The short and low profile jaw enables the surgeon working in the cramped confines of the posterior side of the knee.



RING HANDLE

Straight

225-800-602

UpBiter

225-800-605

UpSwept

225-800-611

Straight Left
Straight Right

225-800-613
225-800-615





BASKET PUNCHES

Basket Punches are the traditional style instruments with a classical punch shape and the parrot peak upper jaw for a safe capture of tissue



STRAIGHT

1.0mm
1.5mm
2.7mm
3.4mm

RING HANDLE

225-800-802
225-800-060
225-800-040
225-800-050



CURVED LEFT

Cut size

1.3mm
1.3mm

RING HANDLE

225-800-813
225-800-807 UpBiter



CURVED RIGHT

Cut size

1.3mm
1.3mm

RING HANDLE

225-800-815
225-800-809 UpBiter



UP BITER

Cut size

1.3mm
1.5mm

RING HANDLE

225-800-805
225-800-055



DOWN BITER

Cut size

1.3mm

RING HANDLE

225-800-806



UP SWEPT

Cut size

1.3mm
1.5mm

RING HANDLE

225-800-865
225-800-061





SIDE CUTTER

Left and Right Side Cutter Punches allow easy access to anterior meniscal tears. The special designed Pencil handle makes all Side Cutters „Rotator“ Punches.

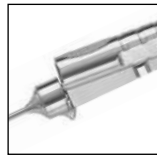

PENCIL HANDLE



2.2mm Left
2.2mm Right

225-800-955
225-800-957

3.4mm Left
3.4mm Right

225-800-965
225-800-967

■ 2.2mm

■ 3.4mm



RING HANDLE



2.2mm Left
2.2mm Right

225-770-955
225-770-957

3.4mm Left
3.4mm Right

225-770-965
225-770-967



2mm

BACKBITER

The RZ Backbiter Basket Punches enable an simple access to the anterior horn of the meniscus

Left
Right



RING HANDLE

225-800-707
225-800-709



PRO HANDLE

225-700-707
225-700-709



RING HANDLE

Straight

225-800-708



RONGEUR

Sharp Cups enable the surgeon to remove tissue and take biopsies

Straight



RING HANDLE

225-800-920



RZ offers a wide range of **ARTHVANCE**® scissors and scissor punches in different angles to enable the surgeon to effectively dissect any part of the meniscus from virtually any direction.

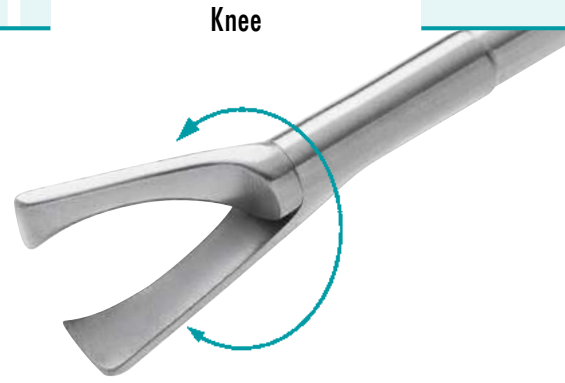

20° angled

HOOK SCISSORS

20° angled Left
20° angled Right



PENCIL HANDLE

225-800-507
225-800-509



RING HANDLE

225-770-507
225-770-509



60° angled

60° angled Left
60° angled Right



PENCIL HANDLE

225-800-517
225-800-519



RING HANDLE

225-770-517
225-770-519

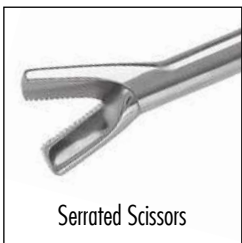

Serrated Scissors

Left curved 20°
Right curved 20°



PENCIL HANDLE

225-800-527
225-800-529

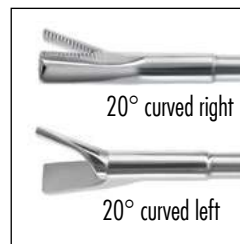

20° curved right

20° curved left



1mm

SCISSORS PUNCH

Straight
UpBiter
UpBiter Left
UpBiter Right



RING HANDLE

225-800-532
225-800-535
225-800-537
225-800-539

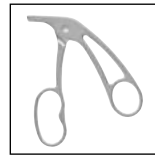

PRO HANDLE

225-700-532
225-700-535



HOOK SCISSORS

Straight
Left
Right



RING HANDLE

225-800-472
225-800-477
225-800-479



RZ offers a wide selection of specific tip configurations to provide a maximum grasping capability and allow easy access to all areas of the meniscus. All RZ Graspers come with the infinite-position, **SlideLock handle** for easy and intuitive grasping. The **Pro Handle** comes without locking mechanism.

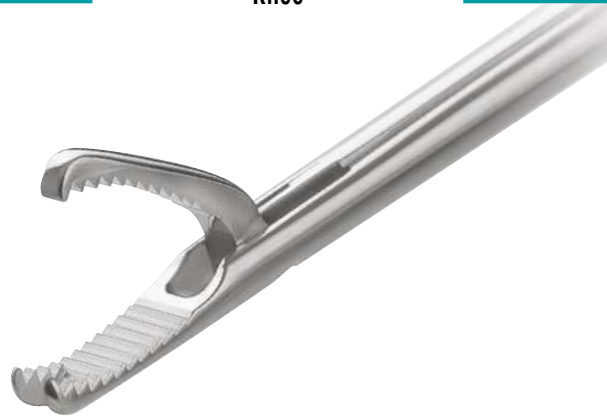

SHARK GRASPER

With blunt 1x2 teeth and serrated inner jaws

Straight



SLIDE LOCK RING HANDLE

225-800-820



PRO HANDLE

225-700-820



ALLIGATOR GRASPER

Short jaw with multiple serrations

Straight 2.7mm
UpSwept 2.7mm

Upbiter 2.7mm



SLIDE LOCK RING HANDLE

225-800-825
225-800-827

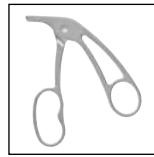

PRO HANDLE

225-700-825
225-700-827





HEAVY ALLIGATOR GRASPER

Long and heavy jaw with multiple serrations

Straight



SLIDE LOCK RING HANDLE

225-800-835

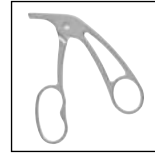

PRO HANDLE

225-700-835



CUPPED GRASPER

Cupped jaw with atraumatic serrations

3.3mm jaw
2.7mm jaw



SLIDE LOCK RING HANDLE

225-800-833
225-800-832

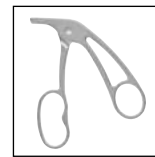

PRO HANDLE

225-700-833



ATRAUMA GRASPER

Cupped jaw with atraumatic serrations

Non-Cannulated
With guide for K-wires \varnothing 2mm/0.077"



SLIDE LOCK RING HANDLE

225-800-850
225-800-855



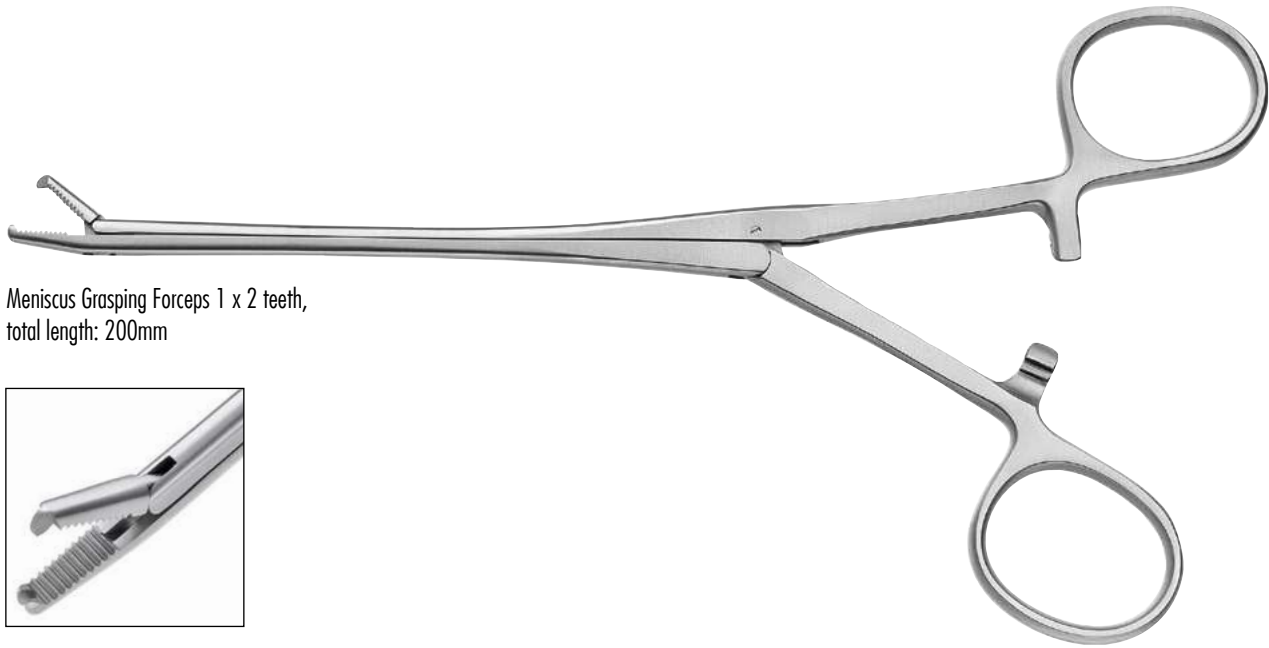

Meniscus Grasping Forceps 1 x 2 teeth,
total length: 200mm

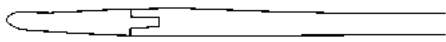

225-360-000
straight

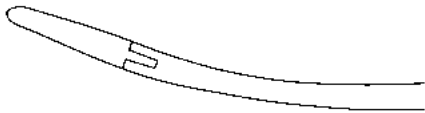

225-360-002
curved Right

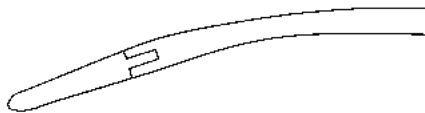

225-360-001
curved Left



225-360-500

Schlesinger Meniscus Grasping Forceps, serrated jaws
with 1 x 2 teeth, straight, 13cm, with ratchet

225-360-550

without ratchet



225-360-600

Schlesinger Meniscus Grasping Forceps,
serrated jaws, straight, 13cm, with ratchet



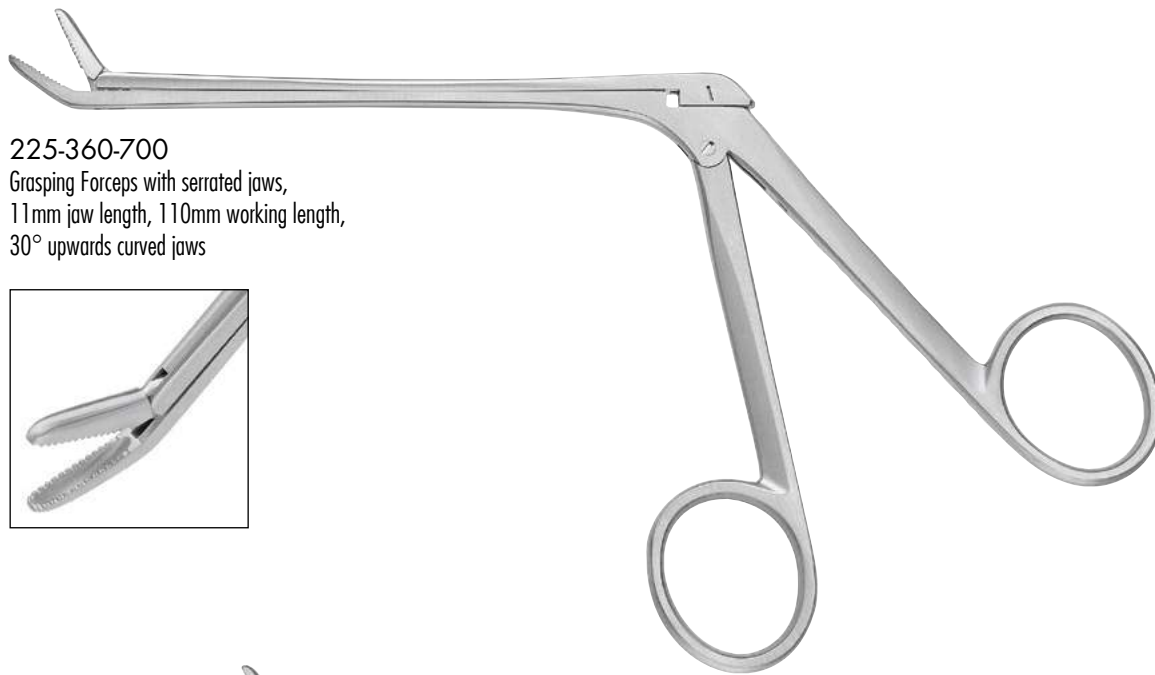

225-360-700
 Grasping Forceps with serrated jaws,
 11mm jaw length, 110mm working length,
 30° upwards curved jaws

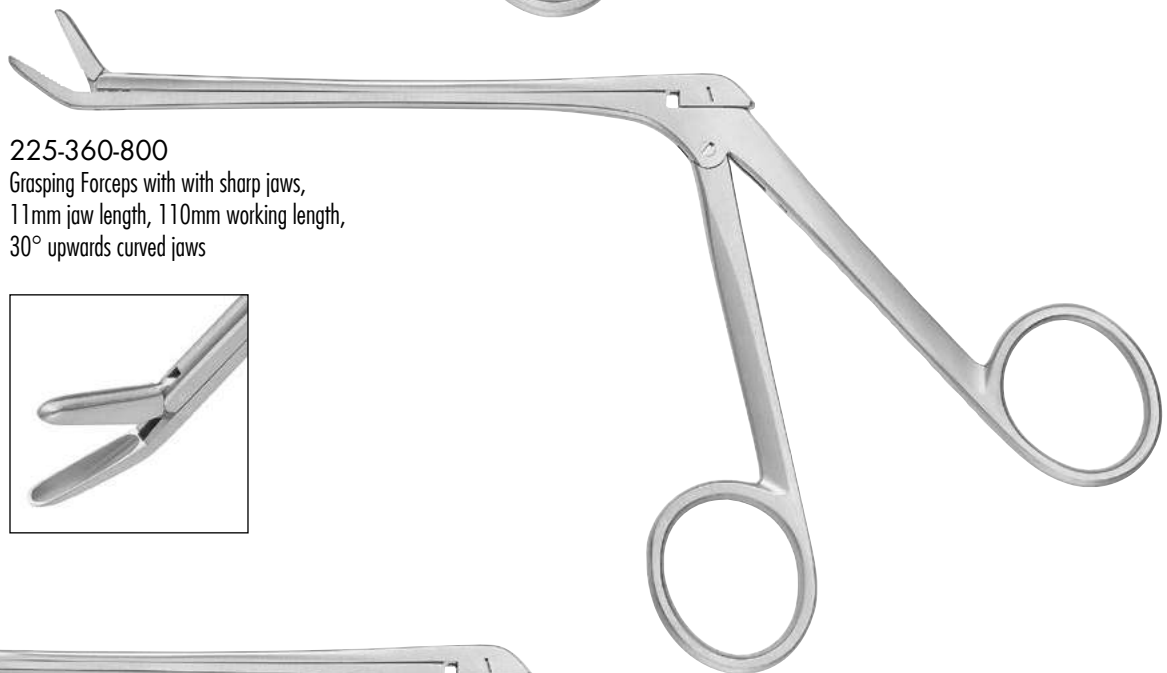

225-360-800
 Grasping Forceps with sharp jaws,
 11mm jaw length, 110mm working length,
 30° upwards curved jaws

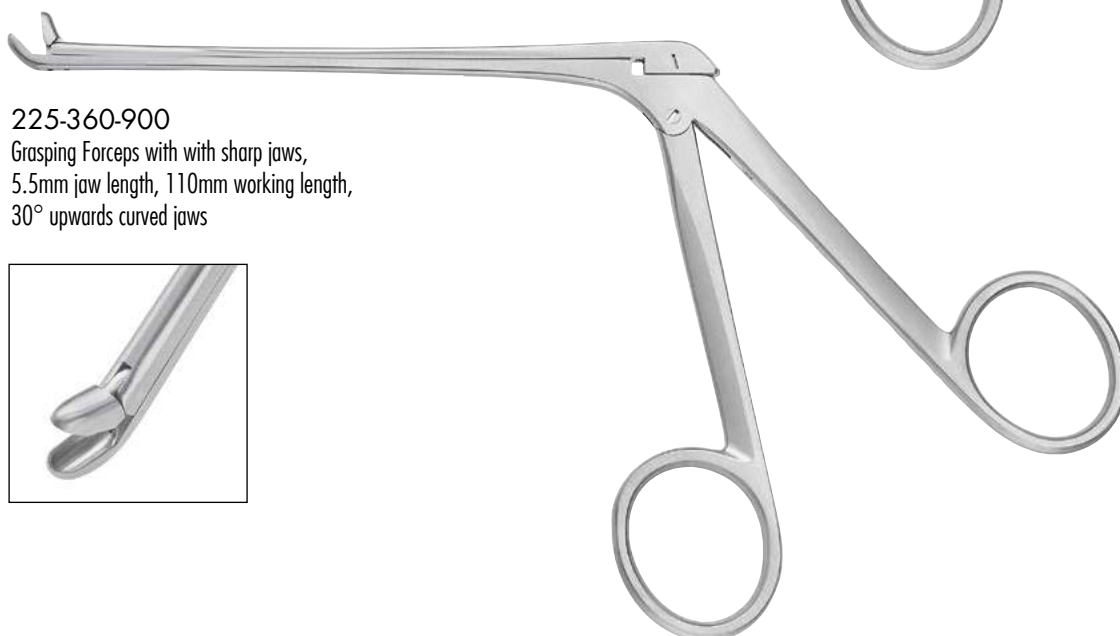

225-360-900
 Grasping Forceps with sharp jaws,
 5.5mm jaw length, 110mm working length,
 30° upwards curved jaws



ArthVANCE® SUCTION PUNCHES
with universal tube connector, 110mm working length



225-695-045 UpBiter
Ø 4.5mm, upwards cutting,
5mm jaw opening

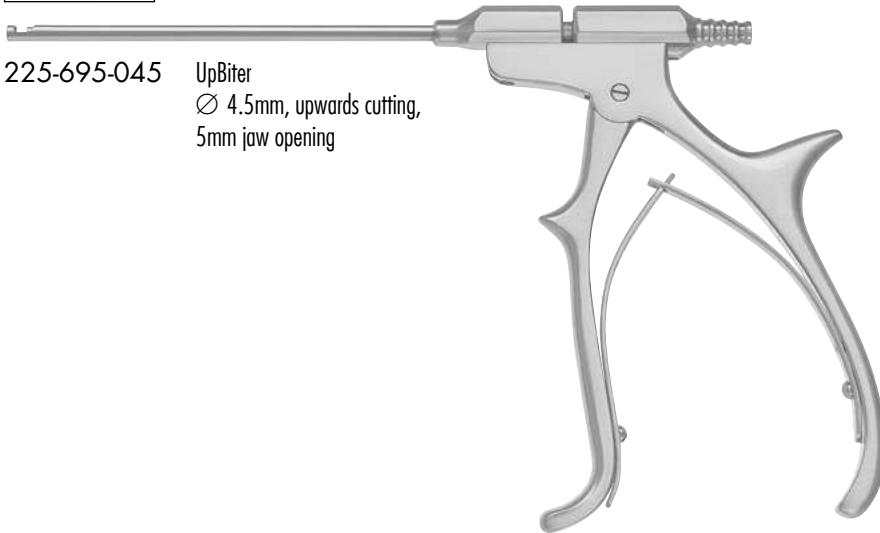

225-696-045 DownBiter,
Ø 4.5mm, downwards cutting,
5mm jaw opening

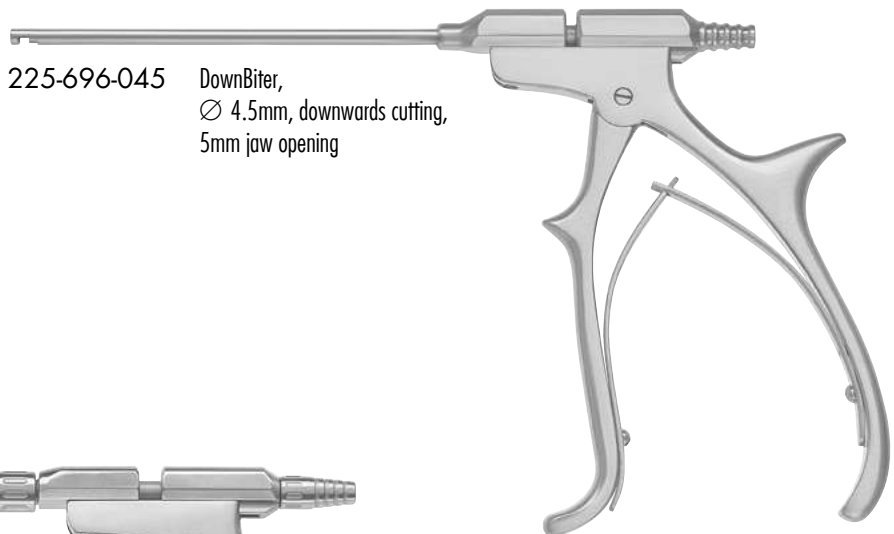

225-699-045 Rotator
Ø 4.5mm, 360° rotating,
detachable

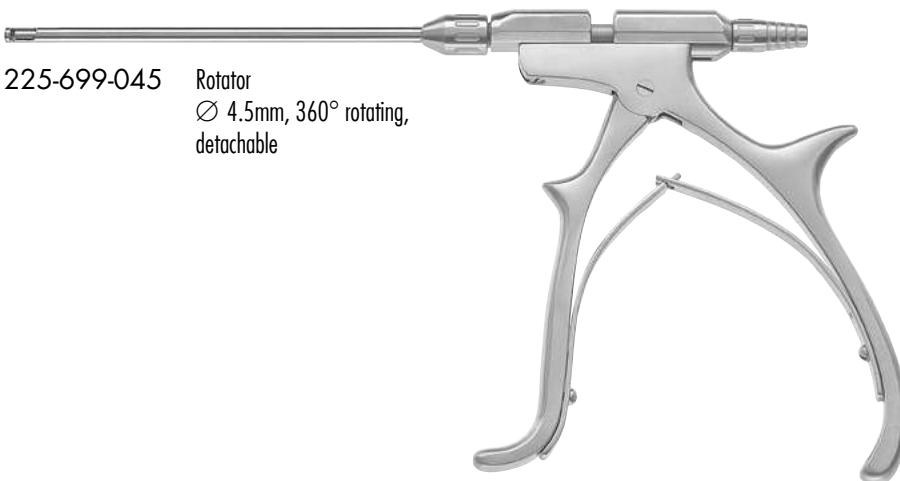

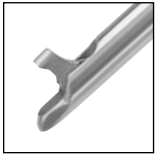

225-697-045 Scoop Punch, \varnothing 4.5mm

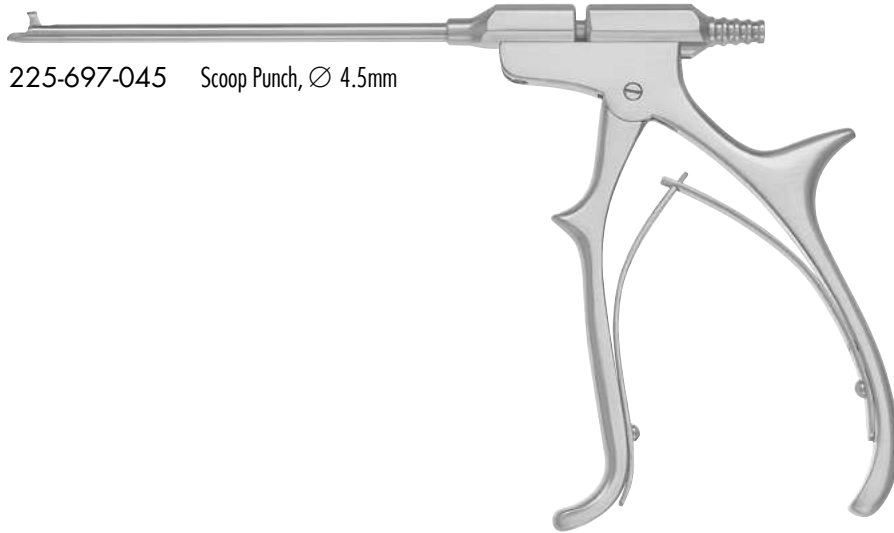

225-697-050 Scoop Punch, \varnothing 5.0mm

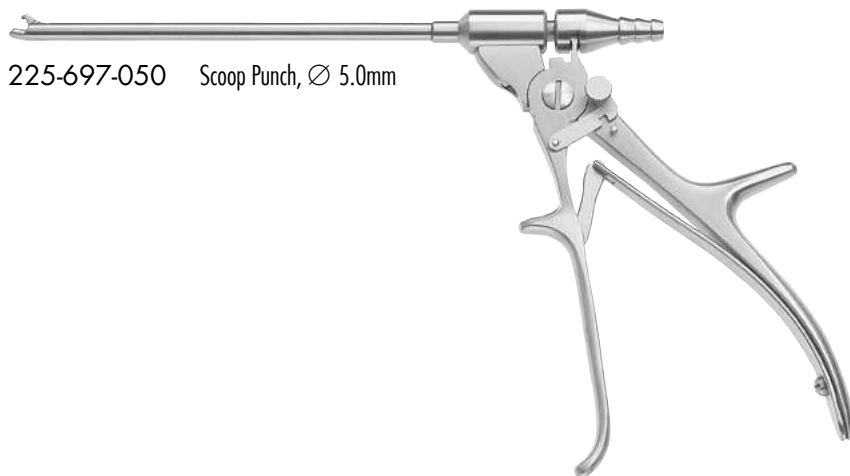

PUNCHES & SCISSORS



Parrot Beak Tear



Transverse Tear



Flap Tear



Bucket Handle Tear



Complex Tear



Discoid Meniscus Degenerative Tear

	PAGE	PAGE	PAGE	PAGE	PAGE	PAGE
POSTERIOR	Slimline Punch	14	Slimline Punch	14	Slimline Punch	14
	Duckling	13	Duckling	13	Duckling	13
	Scissors Punch	20	Scissors Punch	20	Basket Punch UpBiter 1.3mm	20
	Oval Punch	14	Oval Punch	14	Hook Scissors 60°	14
PARS INTERMEDIA	Duckling	13	Duckling	13	Duckling	13
	Basket Punch 1.5mm	16	Basket Punch 1.5mm	16	Oval Punch	14
	Basket Punch 1.3mm	16	Basket Punch 1.3mm	16	Basket Punch 1.3mm	16
	Punch 1.0 mm	16	Punch 1.0 mm	16	Basket Punch 2.7mm	16
	Basket Punch 2.7mm	16	Scissors Punch	16	Duckling UpSwept	13
	Basket Punch 3.4mm	16	Oval Punch	14	Scissors Punch Upbiter	20
	Oval Punch	14	Meniscal Elevator	15	Meniscal Elevator	15
			Oval Punch	14		
ANTERIOR	Side Cutter 90°	17	Side Cutter 90°	17	Side Cutter 90°	17
	Hook Scissors 60°	19	Hook Scissors 60°	19	Hook Scissors 60°	19
	Duckbill Left up	12	Duckbill Left up	12	Duckbill Left up	12
	Duckbill Right up	12	Duckbill Right up	12	Duckbill Right up	12
	Backbiter	18	Scissors 20°	19	Backbiter	18
	Oval Punch	16	Backbiter	18	Oval Punch	14
			Oval Punch	14		

GRASPING FORCEPS

	PAGE	PAGE	PAGE	PAGE	PAGE	PAGE
FOR ALL JOINT PARTS	Shark	21	Cupped, 2.7mm	22	Rongeur	18
			Alligator	21		
			Heavy Alligator	22	Shark	21

Free Joint parts Narrow Joint parts Bucket Handle tear Biopsy Bone block at reconstruction of crutiate ligament Flap tear Small Joint fragments

BASIC INSTRUMENT SET

		PAGE	
BASIC EQUIPMENT EACH 1 ITEM	225-400-002	Exploring Probe 2.5mm	48
	225-800-105	Duckbill Basket Punch, UpBiter	12
	225-800-205	Oval Punch, UpBiter	14
	225-800-835	Heavy Alligator Grasper, Straight	22
	225-800-405	Duckling Basket Punch, UpBiter	13
	225-800-055	Basket Punch, 1.5mm UpBiter	16
	225-800-820	Shark Grasper, Straight	21
	225-800-707	Backbiter Left	18
EXTENSION	225-697-050	Scoop suction Punch, 5.0mm Ø	27
	225-800-905	Meniscal Elevator Basket Punch, UpBiter	15
	225-800-107	Duckbill Basket Punch, UpBiter Left	12
	225-800-413	Duckling Basket Punch Straight Left	13

Table shows only a basic Instrument set that can be completed or changed with other instruments concerning indication of surgery.
Please feel free to ask for combination options.

4.0mm SCOPE AND SHEATH SYSTEM

	Scope	Sheath Trocar blunt Trocar sharp	Sheath QuickLock Trocar blunt Trocar sharp	HighFlow Trocar blunt Trocar sharp	HighFlow QuickLock Trocar blunt Trocar sharp	HighFlow large Trocar blunt Trocar sharp	HighFlow large Quicklock Trocar blunt Trocar sharp
0°	225-140-000	225-500-355 225-500-655 225-500-555	225-550-355 225-500-655 225-500-555	225-500-360 225-500-560 225-500-660	225-550-360 225-500-560 225-500-660	225-500-365 225-500-565 225-500-665	225-550-365 225-500-565 225-500-665
30°	225-140-030	225-500-255 225-500-655 225-500-556	225-550-255 225-500-655 225-500-556	225-500-260 225-500-560 225-500-660	225-550-260 225-500-560 225-500-660	225-500-265 225-500-565 225-500-665	225-550-265 225-500-565 225-500-665
45°	225-140-045	225-500-355 225-500-655 225-500-555	225-550-355 225-500-655 225-500-555	225-500-360 225-500-560 225-500-660	225-550-360 225-500-560 225-500-660	225-500-365 225-500-565 225-500-665	225-550-365 225-500-565 225-500-665
70°	225-140-070	225-500-355 225-500-655 225-500-555	225-550-355 225-500-655 225-500-555	225-500-360 225-500-560 225-500-660	225-550-360 225-500-560 225-500-660	225-500-365 225-500-565 225-500-665	225-550-365 225-500-565 225-500-665

ArthVANCE® HANDGRIP INSTRUMENTS

- Wide range of different tip designs
- Special hardened stainless steel
- Carbon fibre handle with integrated impact protection

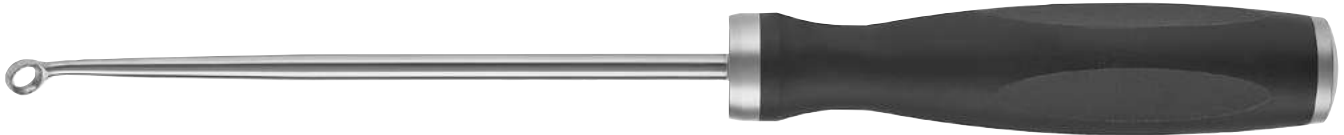

OVAL CURETTES

130mm working length

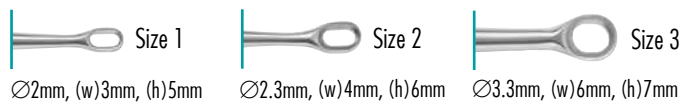

10° angled tip
 225-600-511 Size 1
 225-600-512 Size 2
 225-600-513 Size 3



30° angled tip
 225-600-531 Size 1
 225-600-532 Size 2
 225-600-533 Size 3

TWO-SIDED CURETTES

130mm working length, both sides sharp

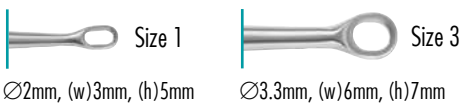

20° angled tip
 225-600-521 Size 1
 225-600-523 Size 3



30° angled tip
 225-600-541 Size 1
 225-600-543 Size 3

SPOONS

130mm working length

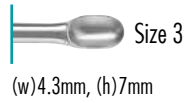
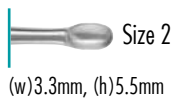
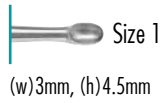

5° angled tip
225-600-401 Size 1
225-600-402 Size 2
225-600-403 Size 3



25° angled tip
225-600-411 Size 1
225-600-412 Size 2
225-600-413 Size 3

RASPS

130mm working length



Small Rasp
225-600-610 straight tip, fine serration
225-600-611 curved tip, fine serration
225-600-612 straight tip, coarse serration
225-600-613 curved tip, coarse serration



Large Rasp
225-600-614 straight tip, fine serration
225-600-615 curved tip, fine serration
225-600-616 straight tip, coarse serration
225-600-617 curved tip, coarse serration

HOOKE PROBE

130mm working length



225-600-004 Hook Probe

MICRO FRACTURE CHONDRO PICKS

- Treatment of cartilage defects
- Special hardened stainless steel
- Carbon fibre handle with integrated impact protection



straight

225-600-200



25° angled tip

225-600-225



40° angled tip

225-600-240



60° angled tip

225-600-260



90° angled tip

225-600-290



225-600-300 Mallet for Chondro-Picks

HAND INSTRUMENTS, TRIANGULAR HANDLE



	Exploring Probe 3.5mm, 5mm graduated	225-400-002
	Exploring Probe 5.0mm, 5mm graduated	225-400-004
	3mm Spoon, angled tip	225-400-006
	Smilie Menisctome, 3mm wide, straight cutting edge	225-400-020
	Smilie Menisctotme, 5mm wide, straight cutting edge	225-400-022
	Smilie Menisctome 7mm wide, curved cutting edge	225-400-023
	Diamond Rasp 90° angled, meniscal tear refreshing	225-400-090
	Diamond Rasp 45° angled, meniscal tear refreshing	225-400-045
	Rosen Knife, toothed blade	225-400-025
	Scalpel Knife	225-400-034
	Banana Knife	225-400-029
	Hook Knife, reverse cutting	225-400-038
	Retrograde Knife, 45° angled blade	225-400-041
	Sickle Knife	225-400-043

MONOPOLAR ELECTRODES

reusable, autoclavable, insulated, 115mm working length











4.0mm plug



2.4mm plug



	Needle Electrode, tip 90° angled, 1.5mm x Ø 0.6mm	225-700-001	225-710-001
	Needle Electrode, tip 90° angled, 4.0mm x Ø 0.6mm	225-700-002	225-710-002
	Knife Electrode, 45° angled, cranked	225-700-003	225-710-003
	Palpation Electrode, tip 90° angled, 4.0mm x Ø 1.5mm	225-700-005	225-710-005
	Ball Electrode, Ø 3.0mm	225-700-006	225-710-006
	Hollow Ball Electrode	225-700-007	225-710-007
	Brush Electrode	225-700-008	225-710-008
	Brush Electrode	225-700-009	225-710-009







Handle with 2 buttons with firm 4m cable

700-214-040 Ø 4.0mm electrodes

700-214-024 Ø 2.4mm electrodes

Monopolar Arthroscopy Electrodes, reusable, autoclavable 134°C,
4.0mm plug, insulated and handle



	Needle Electrode, 1.5mm x 0.6mm, 90°	225-720-001
	Needle Electrode, 4mm x 0.6mm, 90°	225-720-002
	Knife Electrode, 45° angled, cranked	225-720-003
	Palpation Electrode, tip 90° angled	225-720-005
	Ball Electrode, Ø 3.0mm	225-720-006

MONOPOLAR HF CABLES

4,5mm length



253-610-001* with 5 mm plug for Erbe HF-unit

253-610-002* with 4 mm plug for Martin HF-unit

253-610-003* with 8 mm plug for Valleylab HF-unit

253-610-004* with 4 mm plug for older HF-units

700-501-453* SDS plug

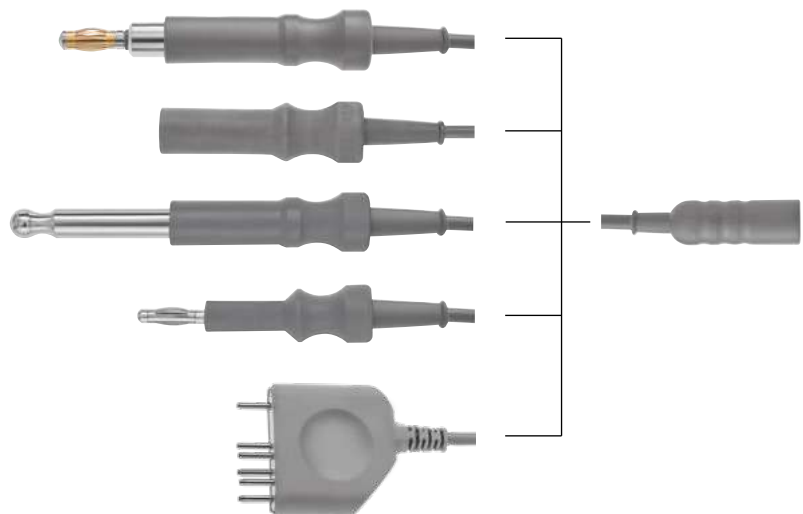

BIPOLAR ELECTRODES







reusable, autoclavable, insulated

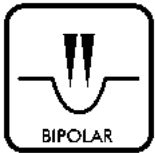

Ø 16mm handle
170mm
working length

Ø 12mm handle
115mm
working length



	Vapor Electrode with ceramic tip	225-730-300	225-700-300
	Hook Electrode, tip Ø 0.6mm, 90° angled	225-730-400	225-700-400
	Hook Electrode, tip Ø 1.5mm, 90° angled	225-730-500	225-700-500
	Palpation Electrode, tip 90° angled, 4.0mm x Ø 1.5mm	225-730-600	225-700-600
	Vapor Electrode, tip Ø 2.4mm, 70° angled	225-730-700	225-700-700
	Vapor Electrode, tip Ø 2.4mm, 90° angled	-	225-700-701



225-730-800 Bipolar Electrode for efficient removal of cartilage tissue,
225mm working length, flat plug



BIPOLAR HF CABLES



253-400-601 for Erbe HF-unit



253-400-602 for Martin HF-unit



700-500-300 SDS plug



LEG HOLDER / LEG REST

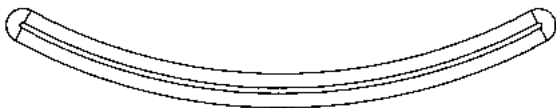

Wide, slightly convex support for femoral



Smaller, more round support for shank

- Surgical table mounting bar not necessary
- Easy to clean and sterilizing
- Can be placed at femoral and shank

225-900-020 LEGère Leg Rest Set with
 large (195 x 85mm) and
 small (145 x 85mm) support

ACL / PCL SET 225-000-000

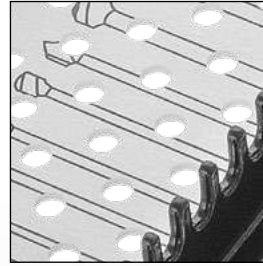

Predestined instrument areas for useful composing

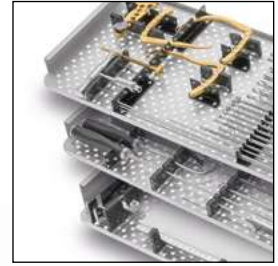

Complete, multi-layered, cost-efficient set

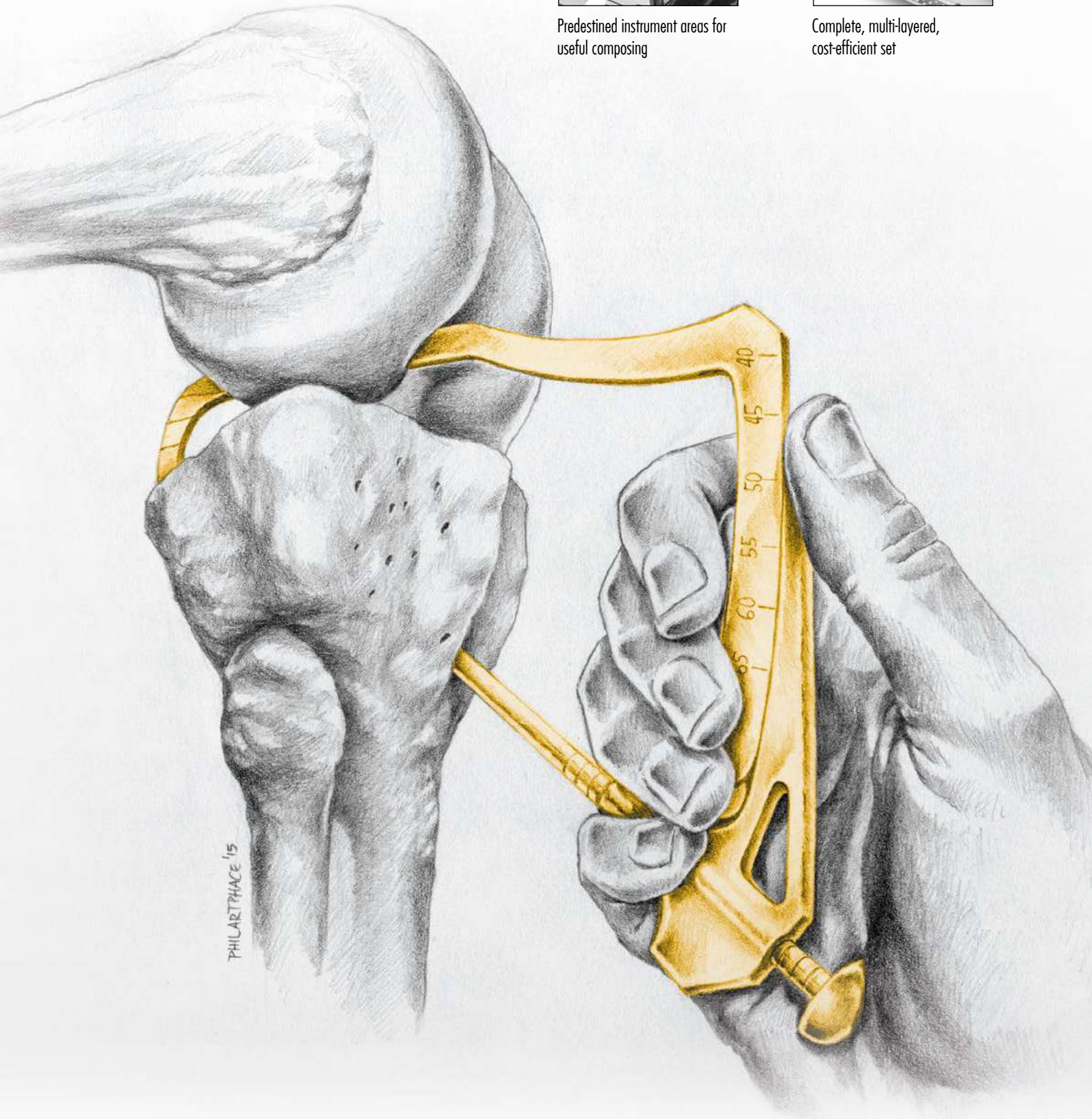

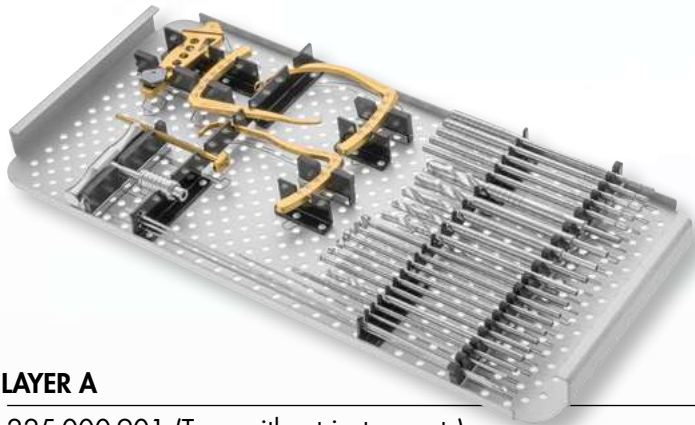

- Drill Guide System
- Tunnel Dilators
- Cannulated Tibial Reamers
- Cannulated Femoral Reamers
- Endoscopic Reamers
- Guide Wire Screws

LAYER A

225-000-901 (Tray without instruments)

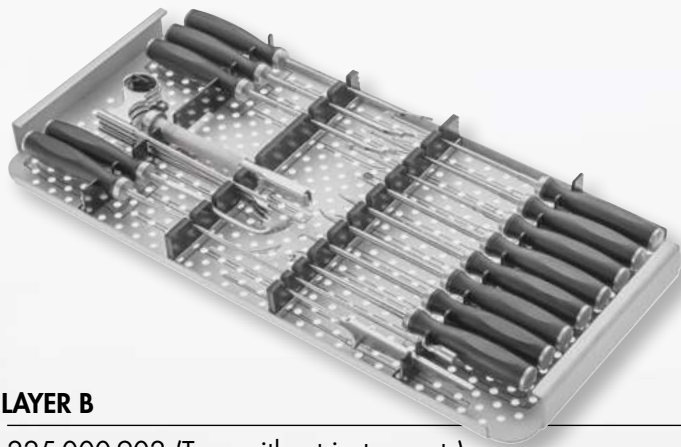

- Microfracture Chondro Picks
- Impactor
- Transportal Femoral Offset Guide
- PCL Rasp and Elevators
- Tendon Strippers
- Arthroscopic Probes

LAYER B

225-000-902 (Tray without instruments)

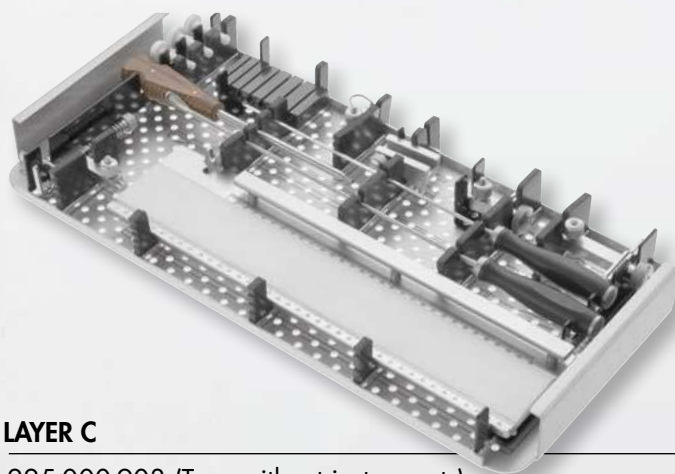

- Graft Preparation Station
- Graft Sizing Block
- Tunnel Plugs
- Tendon Strippers
- Cannulated Screwdriver
- Depth Gauges

LAYER C

225-000-903 (Tray without instruments)

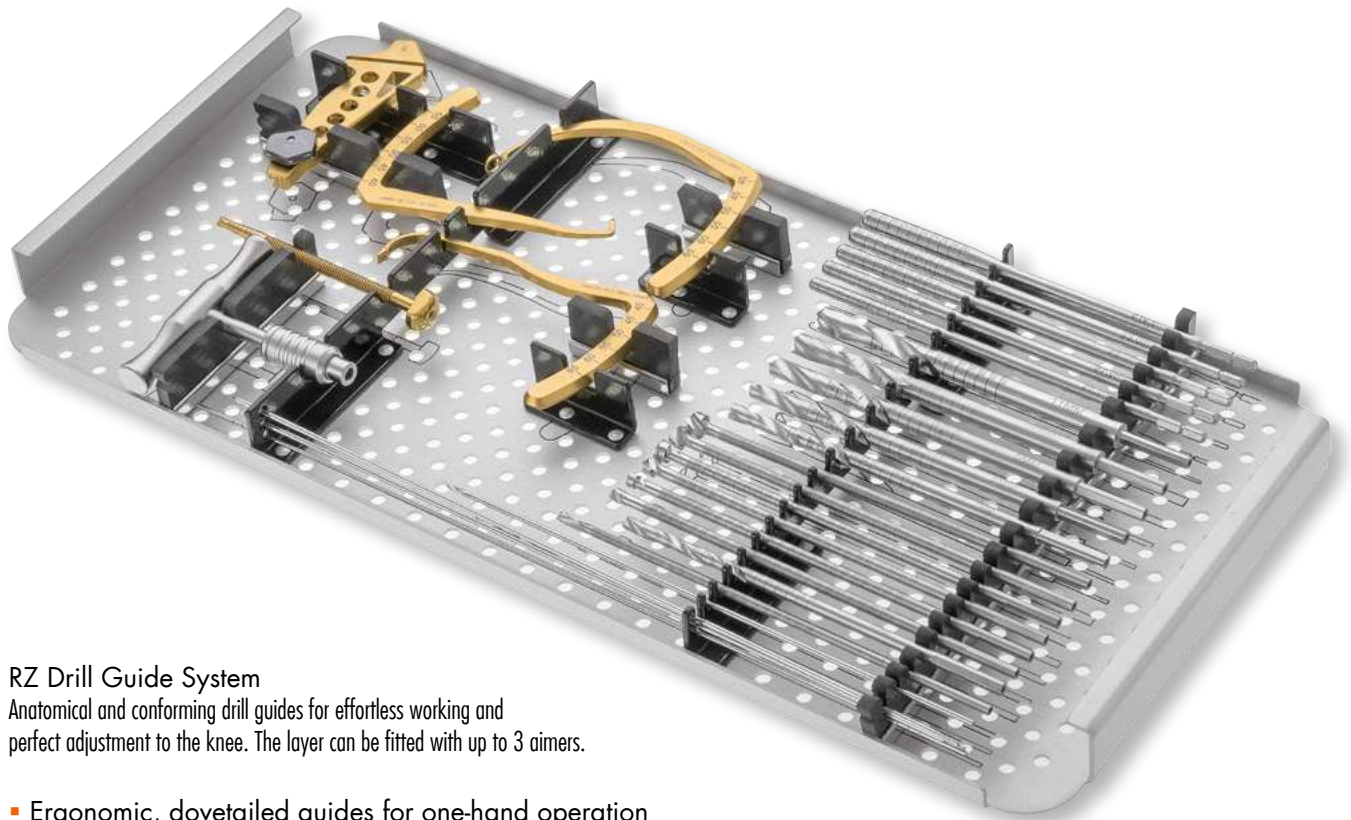

RZ Drill Guide System

Anatomical and conforming drill guides for effortless working and perfect adjustment to the knee. The layer can be fitted with up to 3 aimers.

- Ergonomic, dovetailed guides for one-hand operation thanks to locking mechanism
- Lightweight and compact design
- Ergonomic, dove-tailed guides
- Secure placement on the tibia
- Posterior capsule is protected during guide wire drilling



225-001-101 ACL / PCL Handle



225-001-102 ACL / PCL Bullet



AIMER

- 1 225-001-105 ACL Tip
- 2 225-001-106 ACL Tip O
- 3 225-001-107 ACL Tip C left
- 4 225-001-108 ACL Tip C right
- 5 225-001-115 PCL Tibial Aimer
- 6 225-001-116 PCL Tibial Aimer
- 7 225-001-117 PCL Femoral Aimer



Used to expand tibial and femoral tunnels while compressing the cancellous bone without drilling

TUNNEL DILATORS / T-HANDLE

- 225-000-406 6mm, cannulated
- 225-000-407 7mm, cannulated
- 225-000-408 8mm, cannulated
- 225-000-409 9mm, cannulated
- 225-000-410 10mm, cannulated
- 225-000-400 T-Handle (suitable for 225-000-406 to -410)



CANNULATED TIBIAL REAMERS

- | | | | |
|-------------|--------|-------------|---------|
| 225-000-060 | 6.0mm | 225-000-095 | 9.5mm* |
| 225-000-065 | 6.5mm* | 225-000-100 | 10.0mm |
| 225-000-070 | 7.0mm | 225-000-105 | 10.5mm* |
| 225-000-075 | 7.5mm* | 225-000-110 | 11.0mm |
| 225-000-080 | 8.0mm | 225-000-115 | 11.5mm* |
| 225-000-085 | 8.5mm* | 225-000-112 | 12.0mm* |
| 225-000-090 | 9.0mm | | |



ENDOSCOPIC REAMER

- 225-000-008 \varnothing 4.7mm, cannulated, 200mm

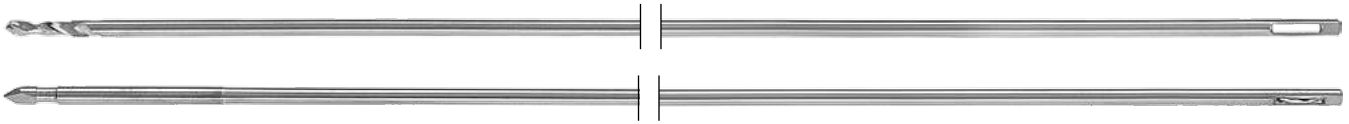

DRILL / GRAFT PASSING GUIDE PINS

- 225-000-005 Drill bit, \varnothing 2.4mm
- 225-000-006 Pin, Drill-tip
- 225-000-007 Pin, Diamond-tip



CANNULATED FEMORAL REAMERS

- | | | | |
|-------------|--------|-------------|---------|
| 225-000-260 | 6.0mm | 225-000-295 | 9.5mm* |
| 225-000-265 | 6.5mm* | 225-000-300 | 10.0mm |
| 225-000-270 | 7.0mm | 225-000-305 | 10.5mm* |
| 225-000-275 | 7.5mm* | 225-000-310 | 11.0mm |
| 225-000-280 | 8.0mm | 225-000-315 | 11.5mm* |
| 225-000-285 | 8.5mm* | 225-000-312 | 12.0mm* |
| 225-000-290 | 9.0mm | | |



GUIDE WIRE FOR SCREWS

- 225-000-009 \varnothing 2.0mm
- 259-120-400 \varnothing 1.2mm (made of Nitinol)

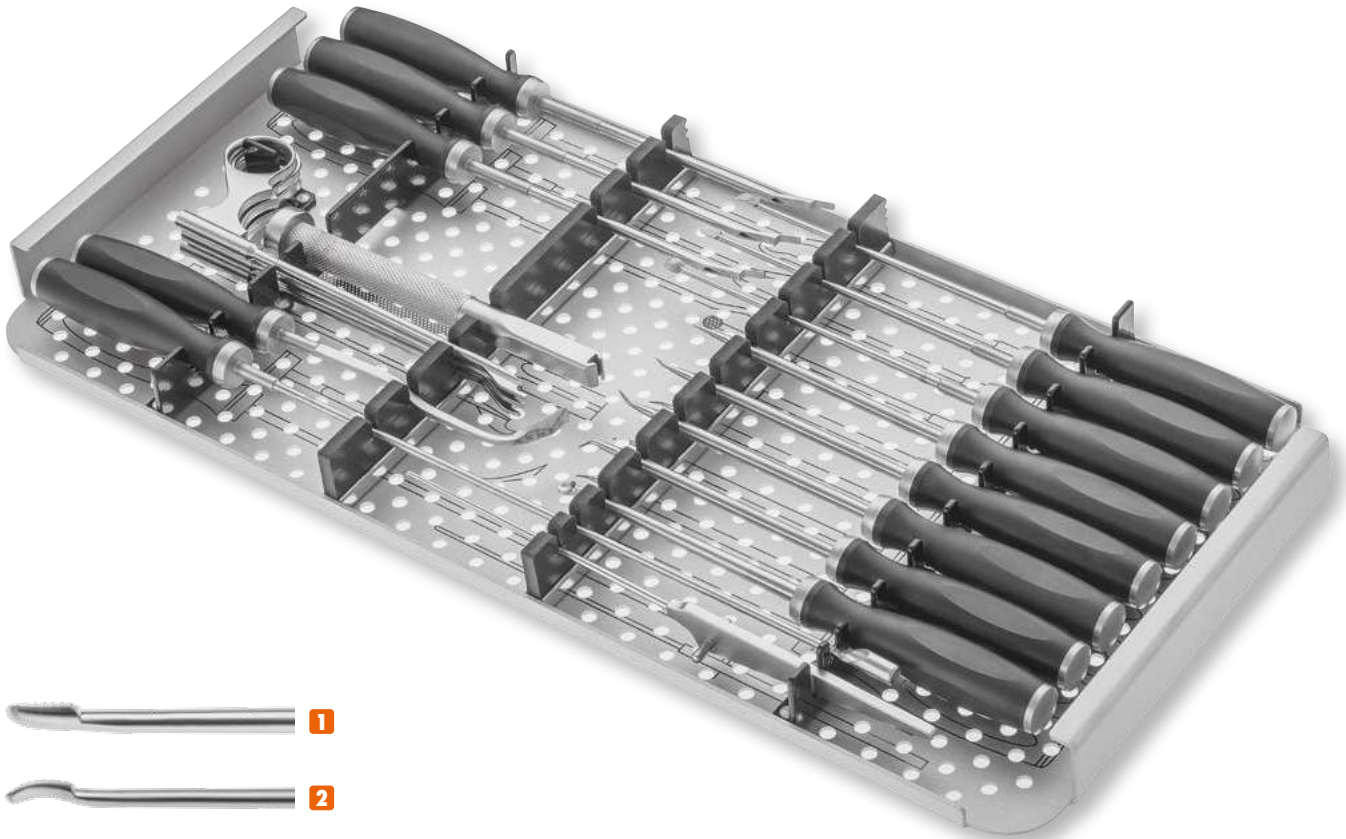

RASPS

- 1** 225-000-500 Straight rasp
- 2** 225-000-501 Convex rasp
- 3** 225-000-502 Half-round rasp

* Item not included in the set and can be ordered separately.

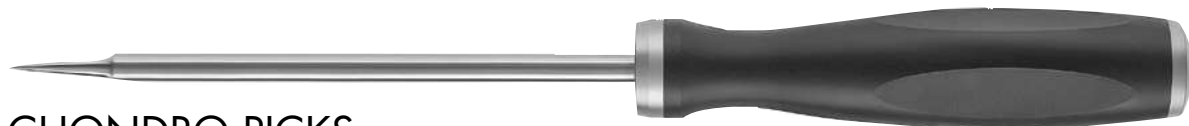

CHONDRO PICKS

- 1** 225-600-200 0° / straight
- 2** 225-600-225 25°
- 3** 225-600-240 40°
- 4** 225-600-260 60°



CURETTE

225-000-507 25° angled down



TRANSPORTAL FEMORAL OFFSET GUIDE

- 225-000-015 5.0mm
- 225-000-016 6.0mm
- 225-000-017 7.0mm

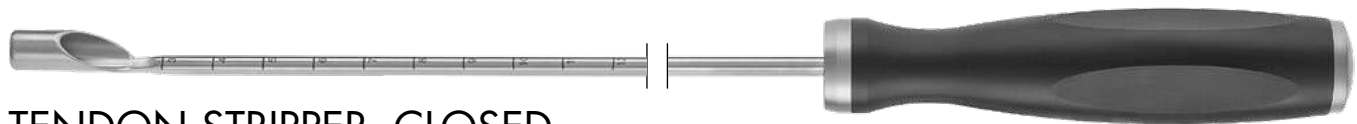

TENDON STRIPPER, CLOSED

225-000-606 6.0mm*

225-000-607 7.0mm

225-000-608 8.0mm*



PCL ELEVATOR

225-000-503 with wire capture hole



ARTHROSCOPIC PROBE

225-400-002 5mm graduations

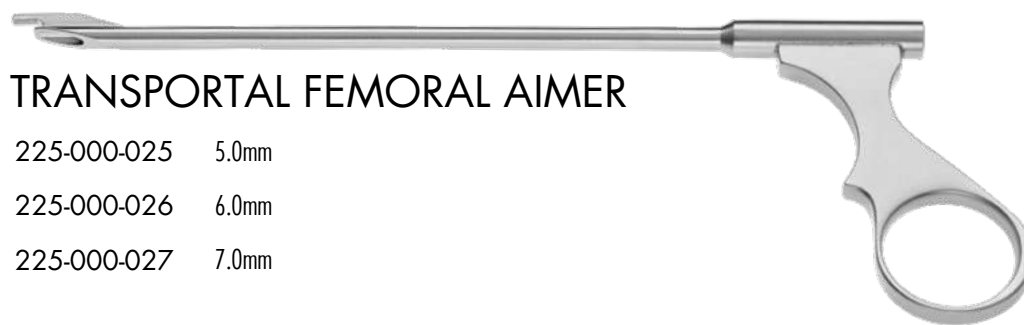

TRANSPORTAL FEMORAL AIMER

225-000-025 5.0mm

225-000-026 6.0mm

225-000-027 7.0mm

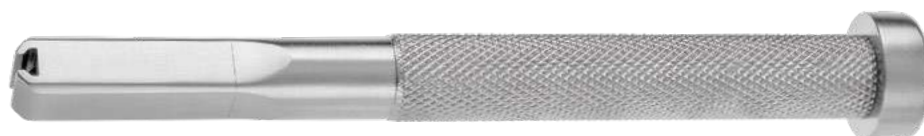

IMPACTOR

225-000-012 For spiked ligament staple

* Item not included in the set and can be ordered separately.

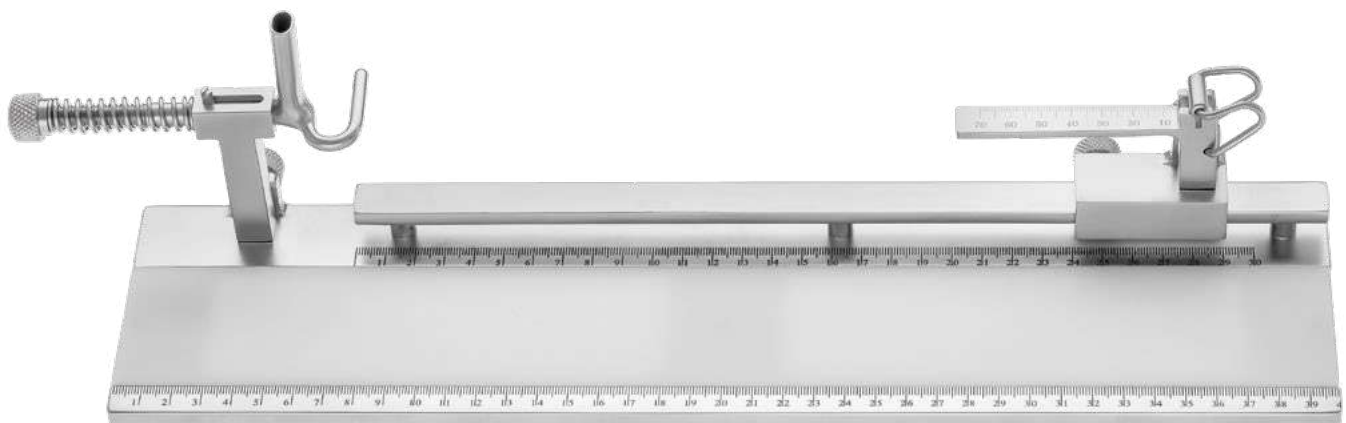
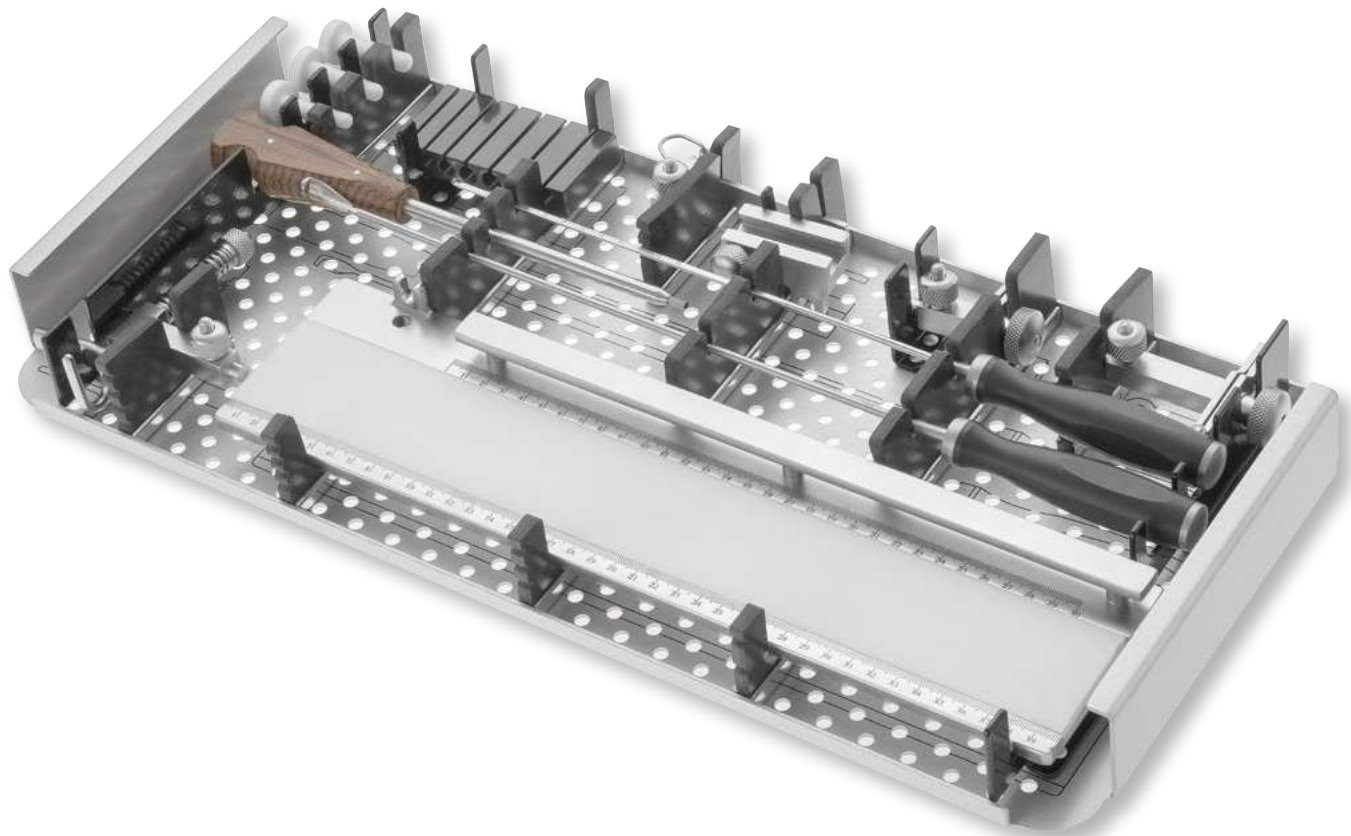

GRAFT PREPERATION STATION

225-000-700 Fully modular system for 6 to 12 increments

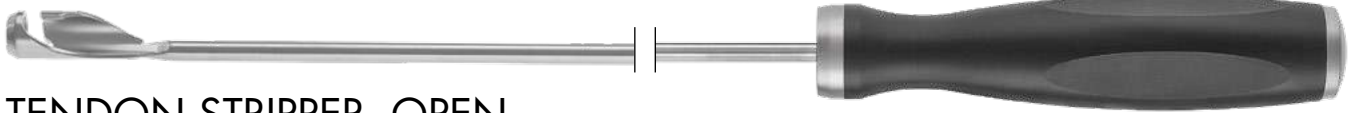

TENDON STRIPPER, OPEN

- 225-000-616 6.0mm*
- 225-000-617 7.0mm
- 225-000-618 8.0mm*

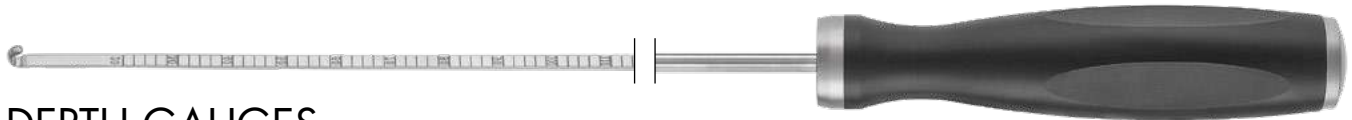

DEPTH GAUGES

- 225-000-010 For measuring the total length of femoral channel



SCREWDRIVER

- 225-000-011 Cannulated



GRAFT SIZING BLOCK

- 225-000-800 From 6mm to 12mm (in 1mm steps)
- 225-000-801 From 6.5mm to 11.5mm (in 1mm steps)*

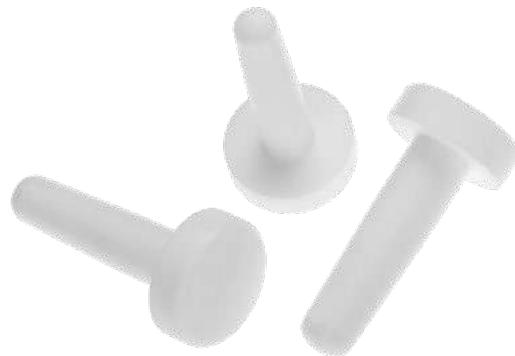

TUNNEL PLUGS

- 225-000-037 7-8mm
- 225-000-038 8-9mm
- 225-000-039 9-10mm

* Item not included in the set and can be ordered separately.

SHOULDER



ArthVIEW® 4K TELESCOPES

State-of-the-art Arthroscopes to achieve excellent image quality and finest details in Ultra High Definition.

4K



0° DIRECTION OF VIEW

330mm working length
405mm overall length 225-140-400



30° DIRECTION OF VIEW

330mm working length
405mm overall length 225-140-430

ArthVIEW® TELESCOPES, Ø 4.0mm

Full HD high definition pictures with increased detail-resolution through newest CAD-designed rod-lens systems.

FULL HD

● ● ● ●
 0° 30° 45° 70°



0° DIRECTION OF VIEW

175mm working length 225-140-000



30° DIRECTION OF VIEW

175mm working length 225-140-030



45° DIRECTION OF VIEW

175mm working length 225-140-045



70° DIRECTION OF VIEW

175mm working length 225-140-070

ArthFLOW® SHEATH SYSTEM

Color coded, 360° rotating system with telescope stabilizing, for use with Ø 4.0mm telescopes.



For 30°

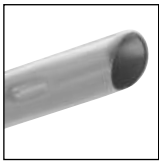

Universal
0°/30°/45°/70°



Operating sheath with 2 stopcocks,

Ø 5.5mm, blue colour code

225-500-255 for 30°

225-500-355 for 0°/30°/45°/70°



225-500-555 Blunt Obturator for Operating sheath Ø 5.5mm, blue colour code



225-500-655 Sharp Trocar for Operating sheath Ø 5.5mm, blue colour code



HighFlow Operating sheath with round perforation,
with 2 stopcocks, Ø 6.0mm, red colour code
225-500-260 for 30°
225-500-360 for 0°/30°/45°/70°

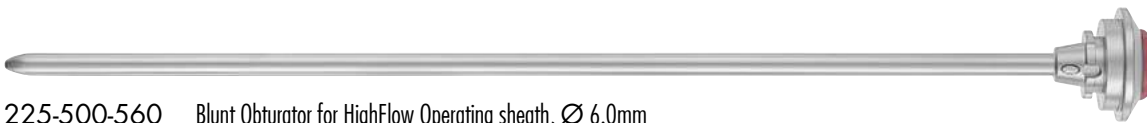

225-500-560 Blunt Obturator for HighFlow Operating sheath, Ø 6.0mm
red colour code



225-500-660 Sharp Trocar for HighFlow Operating sheath, Ø 6.0mm,
red colour code

For 30°

Universal
0°/30°/45°/70°

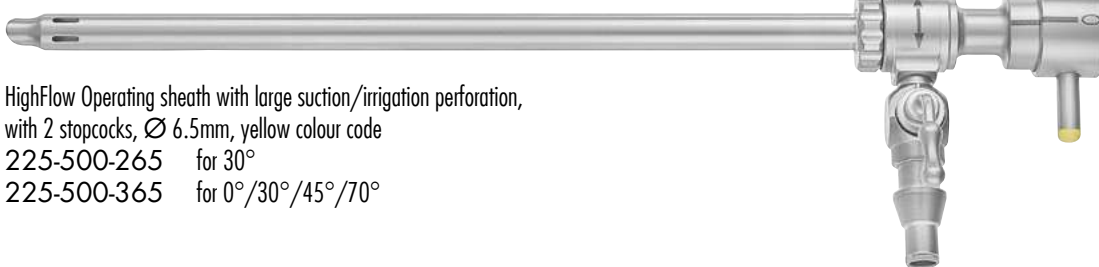

HighFlow Operating sheath with large suction/irrigation perforation,
with 2 stopcocks, Ø 6.5mm, yellow colour code
225-500-265 for 30°
225-500-365 for 0°/30°/45°/70°



225-500-565 Blunt Obturator for HighFlow Operating sheath, Ø 6.5mm,
yellow colour code



225-500-665 Sharp obturator for HighFlow Operating sheath, Ø 6.5mm,
yellow colour code

ArthFLOW® SHEATH SYSTEM WITH QUICK-LOCK



For 30°



Universal
0°/30°/45°/70°

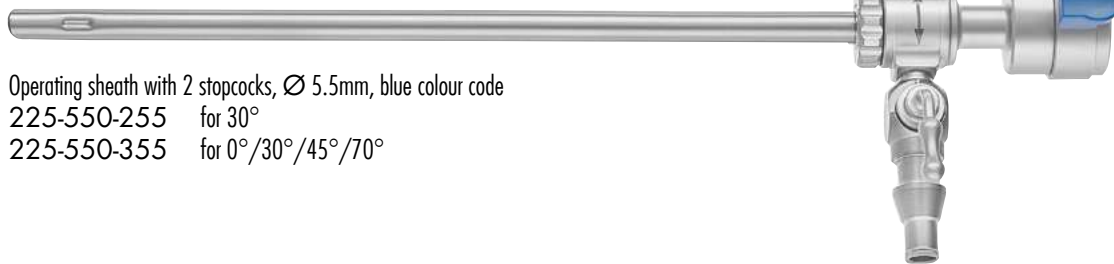

Operating sheath with 2 stopcocks, Ø 5.5mm, blue colour code
 225-550-255 for 30°
 225-550-355 for 0°/30°/45°/70°



225-500-555 Blunt Obturator for Operating sheath Ø 5.5mm, blue colour code

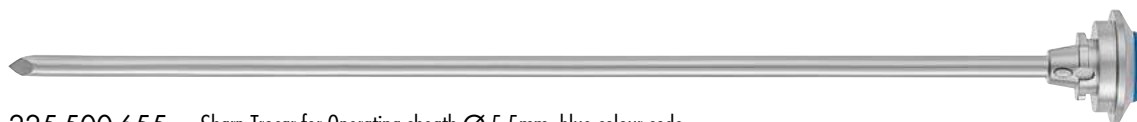

225-500-655 Sharp Trocar for Operating sheath Ø 5.5mm, blue colour code

For 30°



Universal
0°/30°/45°/70°



HighFlow Operating sheath with round perforation,
with 2 stopcocks, Ø 6.0mm, red colour code
225-550-260 for 30°
225-550-360 for 0°/30°/45°/70°

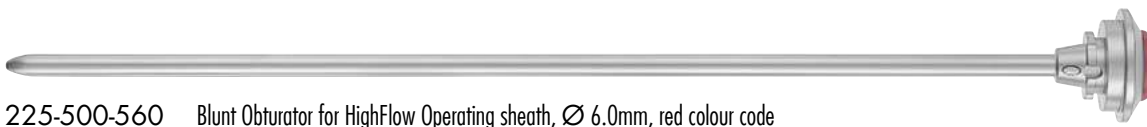

225-500-560 Blunt Obturator for HighFlow Operating sheath, Ø 6.0mm, red colour code



225-500-660 Sharp Trocar for HighFlow Operating sheath, Ø 6.0mm, red colour code

For 30°



Universal
0°/30°/45°/70°

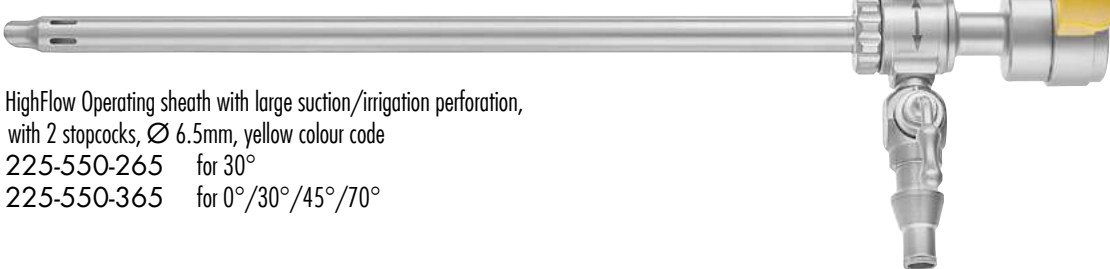

HighFlow Operating sheath with large suction/irrigation perforation,
with 2 stopcocks, Ø 6.5mm, yellow colour code
225-550-265 for 30°
225-550-365 for 0°/30°/45°/70°

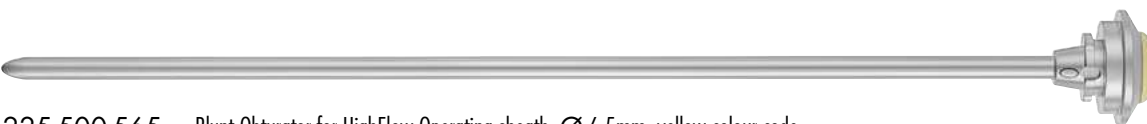

225-500-565 Blunt Obturator for HighFlow Operating sheath, Ø 6.5mm, yellow colour code



225-500-665 Sharp Trocar for HighFlow Operating sheath, Ø 6.5mm, yellow colour code

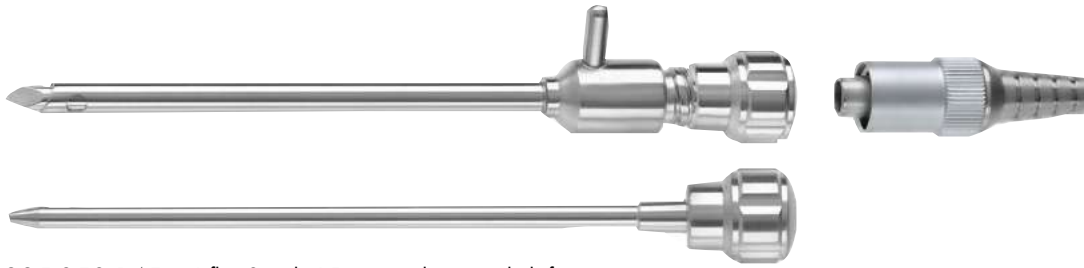

225-850-145 Inflow-Cannula 4.5mm, complete set with shaft, trocar with sharp tip, blunt obturator and irrigation adaptor

Accessories for Suction- and Irrigation System



Irrigation Cannula set with 1 stopcock, including trocar and obturator

225-850-000 Ø 2.3mm

225-850-001 Ø 3.5mm



300-011-181 LuerLock tube connector, 9mm



300-011-506 LuerLock tube connector, 6mm



Obturator, blunt

225-850-002 Ø 2.3mm

225-850-004 Ø 3.5mm



Obturator, sharp, 70mm working length

225-850-003 Ø 2.3mm

225-850-005 Ø 3.5mm



225-852-000 Irrigation syringe, 100ml



Guiding and changing rods for use with trocar sheath

225-865-027 Ø 2.7mm x 230mm

225-865-030 Ø 3.5mm x 230mm

225-865-040 Ø 4.0mm x 230mm

SUTURE PASSER

Simultaneously one-handed passing and retrieving of suture

- Wide jaw opening and deep bite
- Minimal trauma at tissue penetration
- Reusable instrument and reliable construction



Automatic trap loop hold

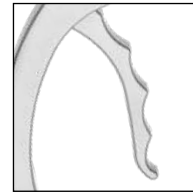

Strong grip with 4-finger trigger

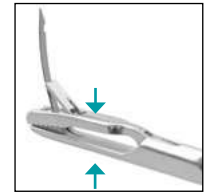

Slim design

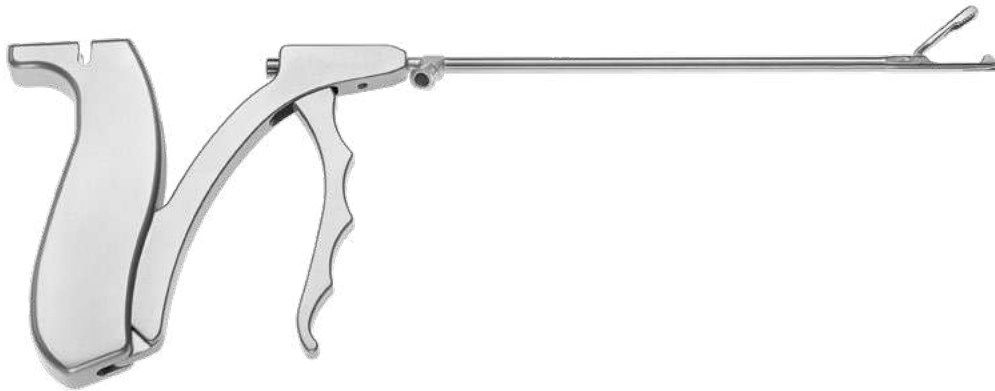

225-820-217 Suture Passer with trap door, frontal opening, without ratchet, 170mm working length

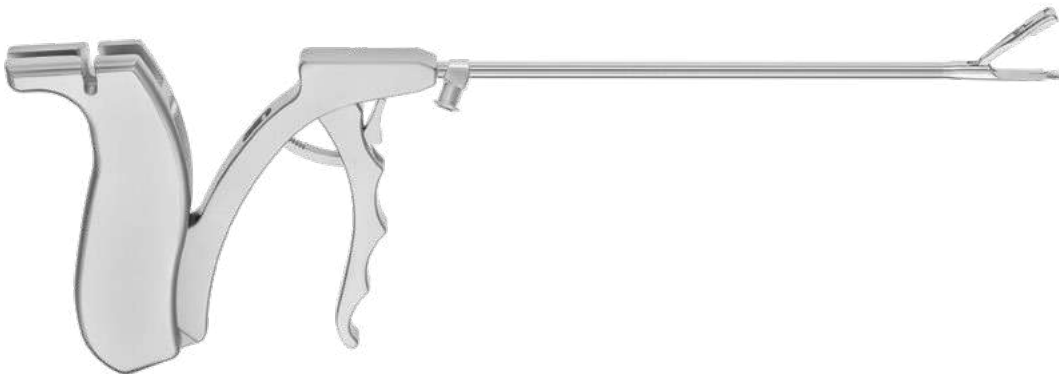

225-820-213 Suture Passer with trap door, frontal opening, with ratchet, 170mm working length



225-820-219 Needle with lateral opening, 0.3 x 240mm



225-225-225 Rotator Cuff Simulator (available on request)



225-259-000 Knot Pusher, single-hole, for sliding knots and half-stitches, modified distal tip for easy slipknots, 175mm

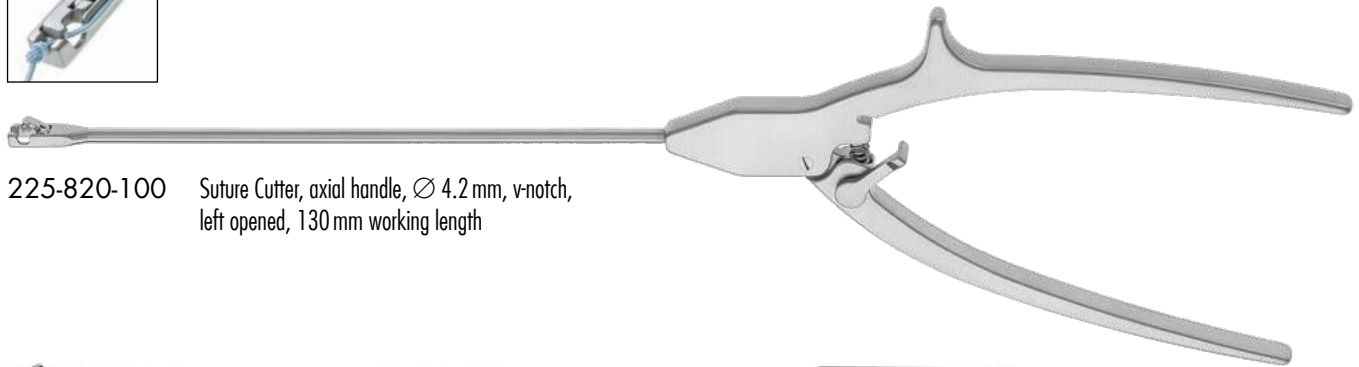

225-820-100 Suture Cutter, axial handle, \varnothing 4.2 mm, v-notch, left opened, 130 mm working length

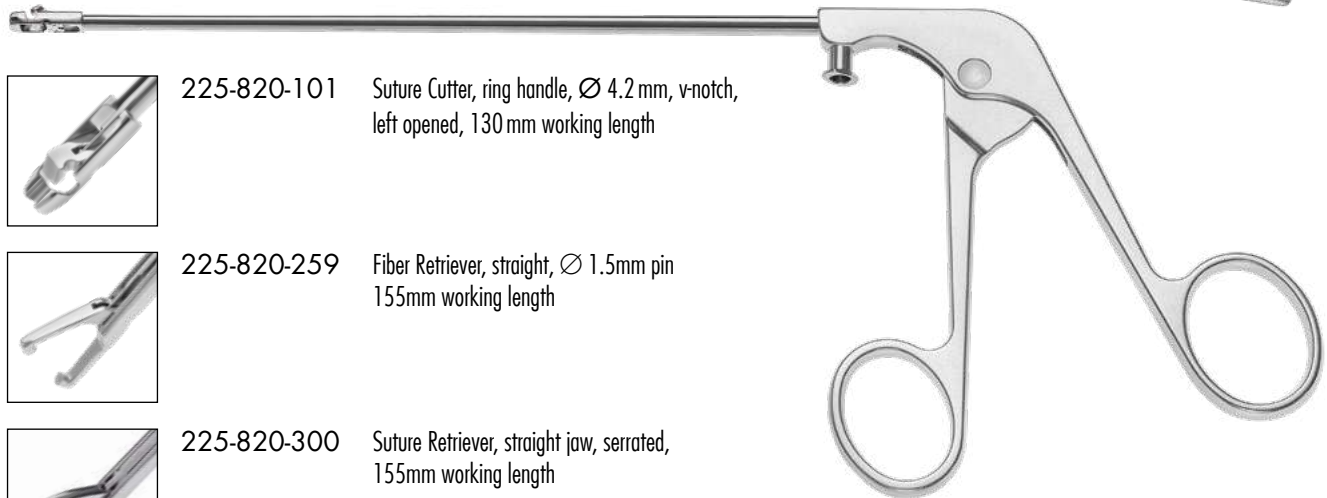
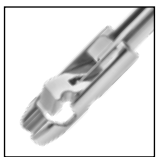

225-820-101 Suture Cutter, ring handle, \varnothing 4.2 mm, v-notch, left opened, 130 mm working length



225-820-259 Fiber Retriever, straight, \varnothing 1.5mm pin 155mm working length



225-820-300 Suture Retriever, straight jaw, serrated, 155mm working length



225-600-630 Debridement Rasp, razor sharp, with PEEK handle



225-600-650 Tissue Elevator, precise, 15° angled, with PEEK handle

SUTURE INSTRUMENTS

For rotator and labral repair



Smart Hook



Left curved jaw

- 1** 225-820-307
- 2** 225-840-307



Right curved jaw

- 1** 225-820-309
- 3** 225-840-309

Sixer



Twisted left

- 1** 225-820-306
- 2** 225-840-306



Twisted right

- 1** 225-820-308
- 3** 225-840-308

Birdy



Straight jaw, upcurved shaft

1 225-820-400

2 225-840-400



20° upwards angled

1 225-820-402

2 225-840-402



40° upwards angled

1 225-820-404

2 225-840-404



45° right angled

1 225-820-406

2 225-840-406



45° left angled

1 225-820-408

2 225-840-408

HIP



ArthFLOW® SHEATH SYSTEM 270mm working length

- 360° rotating stopcocks
- Stainless steel only
- Colour coded for easy identification of diameters
- Telescope stabilizing system
- For use with RZ 0°, 30°, 45° and 70° telescopes

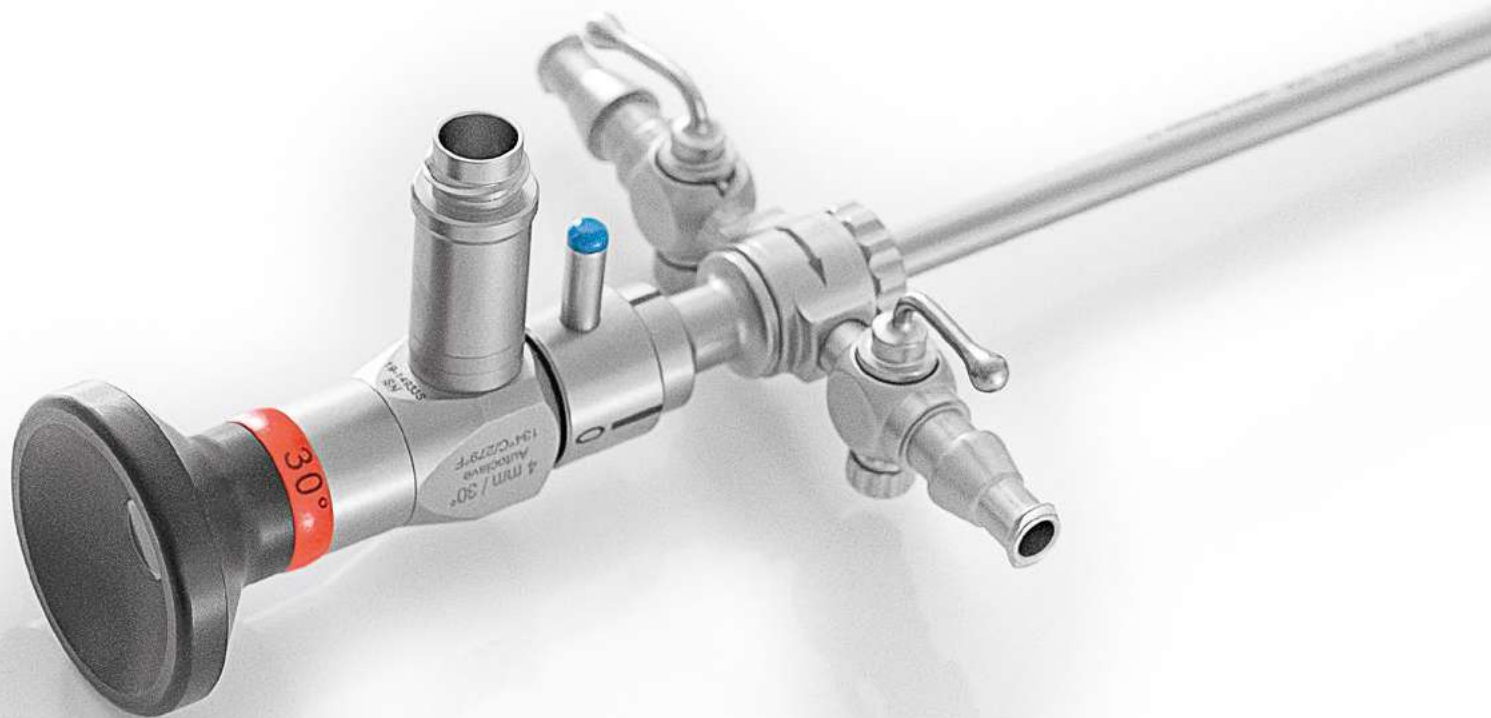

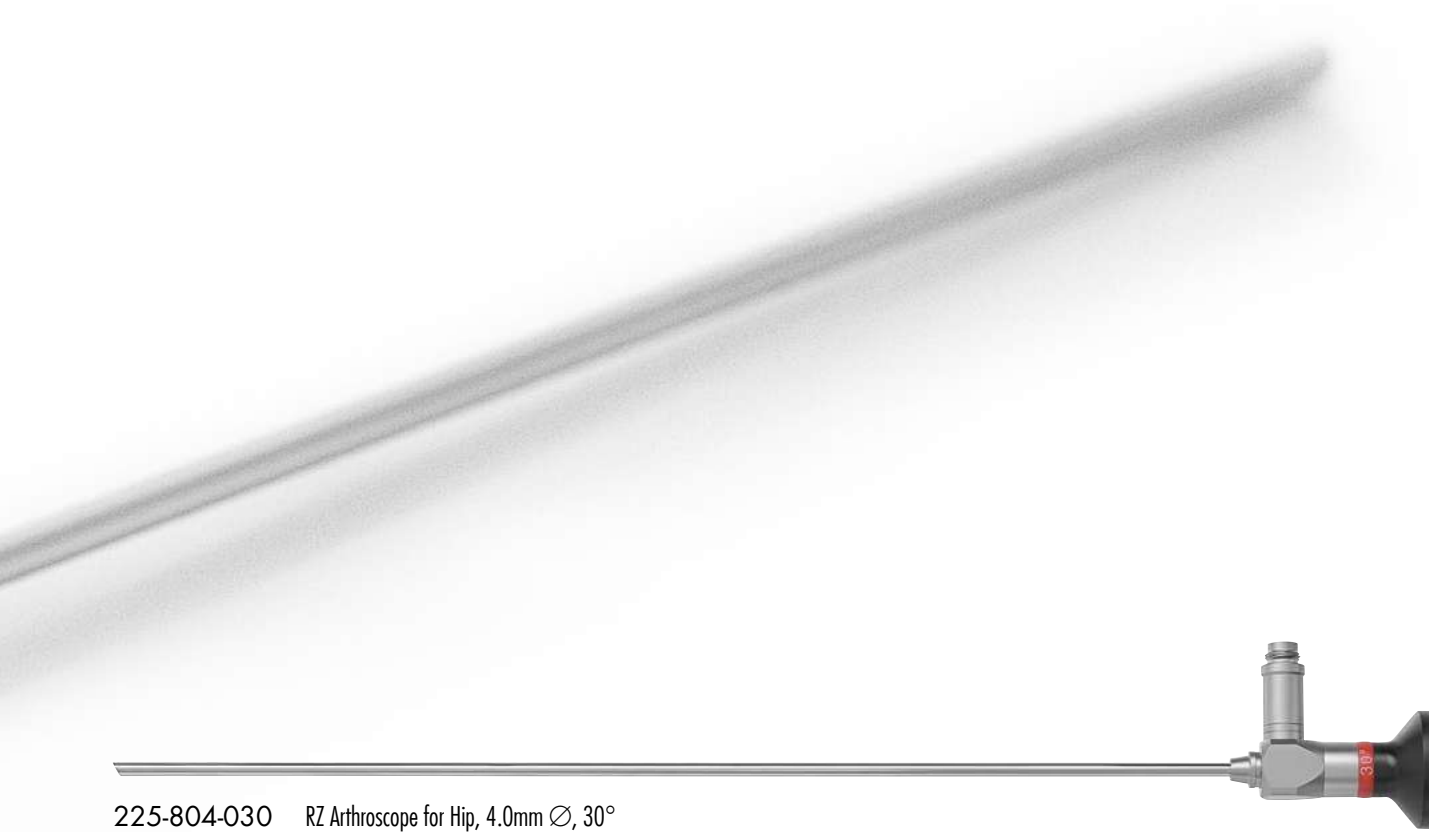

225-804-030 RZ Arthroscope for Hip, 4.0mm \varnothing , 30°



225-501-255 Operating sheath with 2 stopcocks, 5.5mm diameter, blue colour code

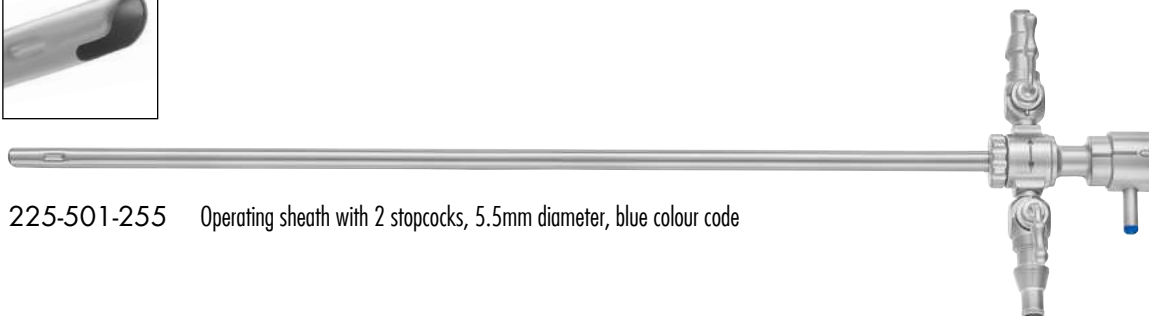

225-501-555 Blunt Obturator for Operating sheath 5.5mm diameter, blue colour code



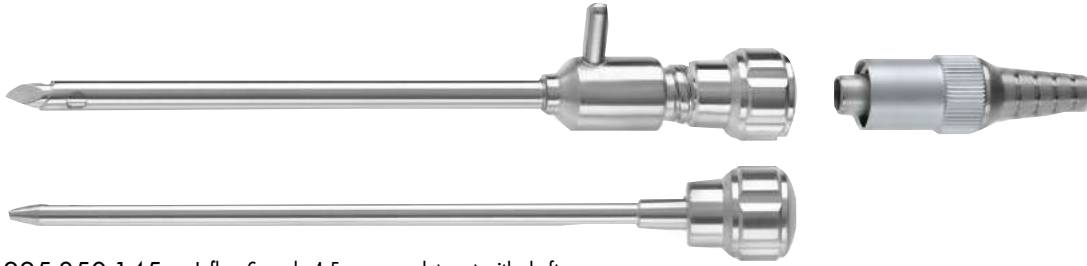

225-850-145 Inflow-Cannula 4.5mm, complete set with shaft, trocar with sharp tip, blunt obturator and irrigation adaptor

Accessories for Suction- and Irrigation System



Irrigation Cannula set with 1 stopcock, including trocar and obturator

- 225-850-000 ∅ 2.3mm
- 225-850-001 ∅ 3.5mm



300-011-181 LuerLock tube connector, 9mm



- Obturator, blunt
- 225-850-002 ∅ 2.3mm
- 225-850-004 ∅ 3.5mm



300-011-506 LuerLock tube connector, 6mm



- Obturator, sharp, 70mm working length
- 225-850-003 ∅ 2.3mm
- 225-850-005 ∅ 3.5mm

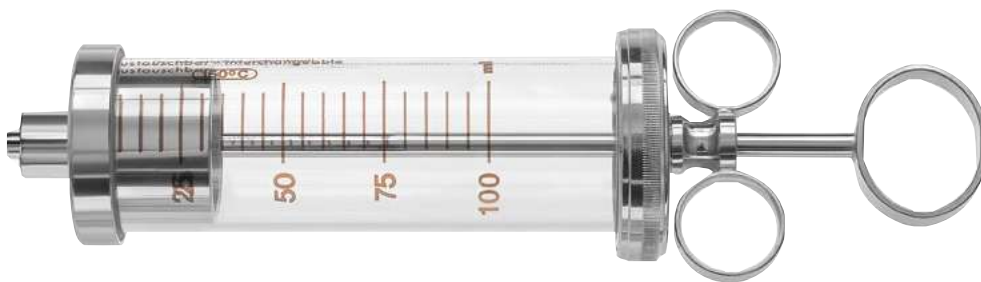

225-852-000 Irrigation syringe, 100ml



- Guiding and changing rods for use with trocar sheath
- 225-865-027 ∅ 2.7mm x 230mm
- 225-865-030 ∅ 3.5mm x 230mm
- 225-865-040 ∅ 4.0mm x 230mm

ArthVANCE® Punches and Graspers, 220mm working length



 cut size

SLIMLINE BASKET PUNCH
 220mm working length
 The narrow shaft and compact jaw design allows access and use in tight spaces



RING HANDLE

Straight
 UpBiter

225-830-002
 225-830-005

Jaw 45° Left
 Jaw 45° Right

225-830-003
 225-830-004



 cut size

DUCKLING BASKET PUNCH
 220mm working length
 Advanced Duckling Low profile jaw
 Flat Upper jaw moves completely into the Lower jaw.



RING HANDLE

Straight (Medium)

225-830-402

UpBiter (Medium)
 UpSwept (Medium)

225-830-405
 225-830-411





cut size

BACKBITER
220mm working length

Left
Right



RING HANDLE

225-830-707
225-830-709



220mm working length



RING HANDLE

cut size 2.2mm

cut size 3.4mm

2.2mm Left
2.2mm Right

225-830-955
225-830-957

3.4mm Left
3.4mm Right

225-830-965
225-830-967





SHARK GRASPER
220mm working length
With blunt 1x2 teeth and
serrated inner jaws

Straight



SLIDE LOCK RING HANDLE

225-830-820



HEAVY ALLIGATOR GRASPER
220mm working length
Long and heavy jaw with
multiple serrations

Straight



SLIDE LOCK RING HANDLE

225-830-835



All RZ Graspers come with the infinite-position,
SlideLock handle with self holding function.



CUPPED GRASPER
220mm working length
Cupped jaw with atraumatic serrations

HANDLE

3.3mm jaw



SLIDE LOCK RING

225-830-833



RONGEUR
220mm working length
Sharp Cups enable the surgeon to remove tissue and take biopsies

Straight



RING HANDLE

225-830-920



SMALL JOINT

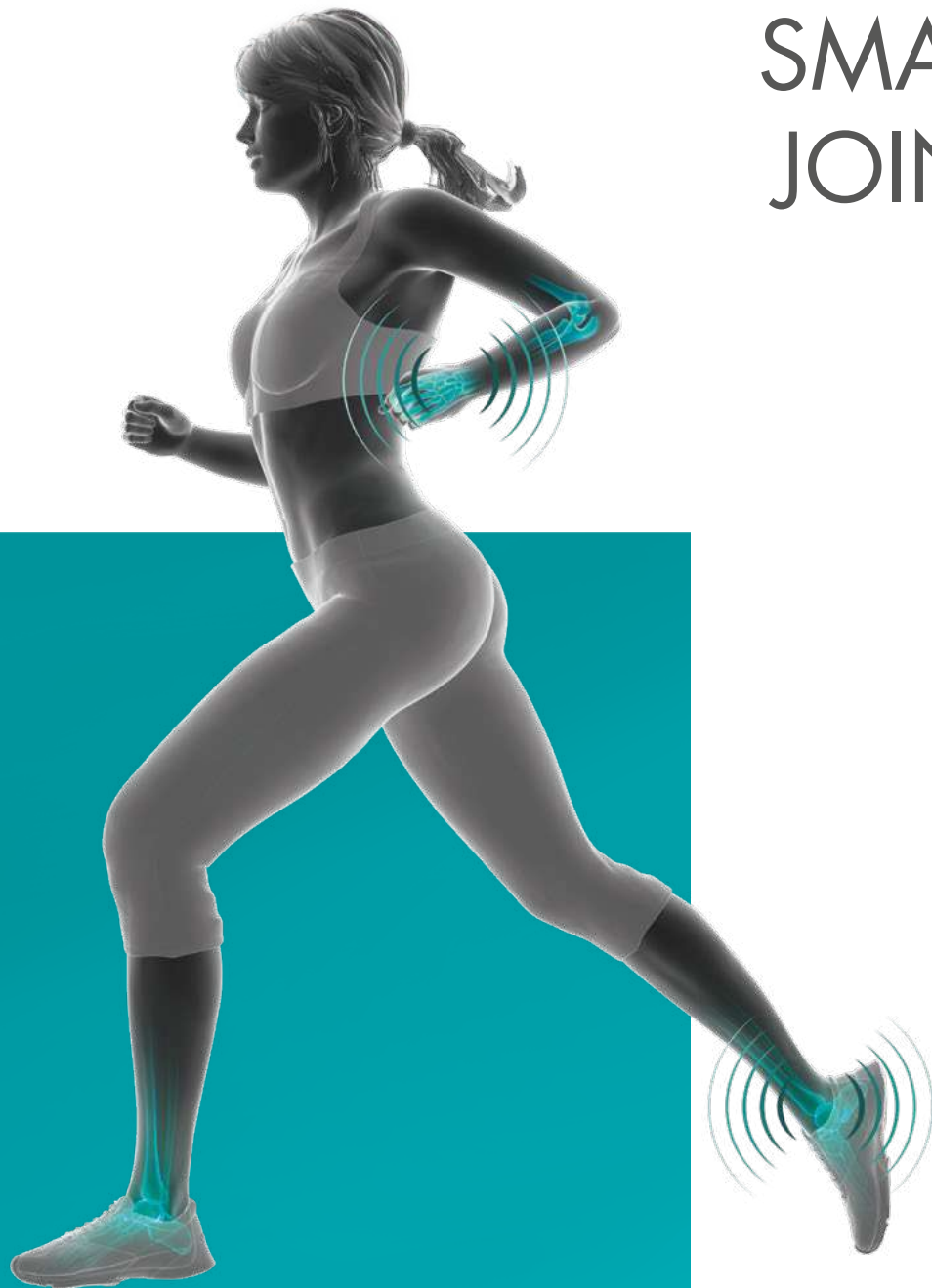

1.9
1.9mm

ArthVIEW® MINI TELESCOPE AND SHEATH SYSTEM ArthFLOW®

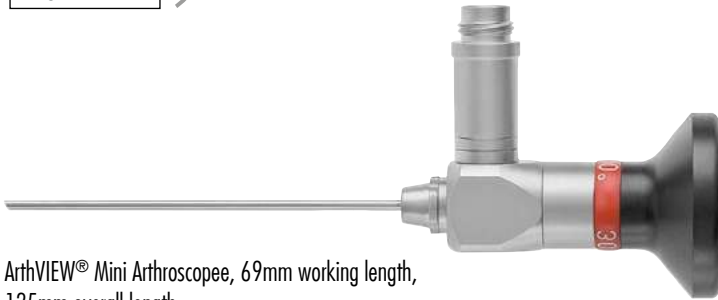

ArthVIEW® Mini Arthroscope, 69mm working length,
125mm overall length
225-019-000 0°
225-019-030 30°

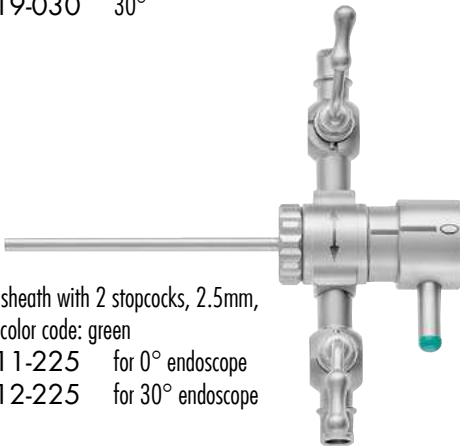

Operating sheath with 2 stopcocks, 2.5mm,
rotatable, color code: green
225-511-225 for 0° endoscope
225-512-225 for 30° endoscope

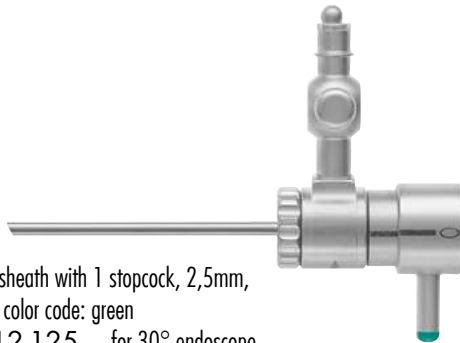

Operating sheath with 1 stopcock, 2.5mm,
rotatable, color code: green
225-512-125 for 30° endoscope,



225-511-525 Obturator, blunt, for 2.5mm
operating sheath, color code: green



225-511-625 Trocar, sharp, for 2.5mm
operating sheath, color code: green



1.9
1.9mm

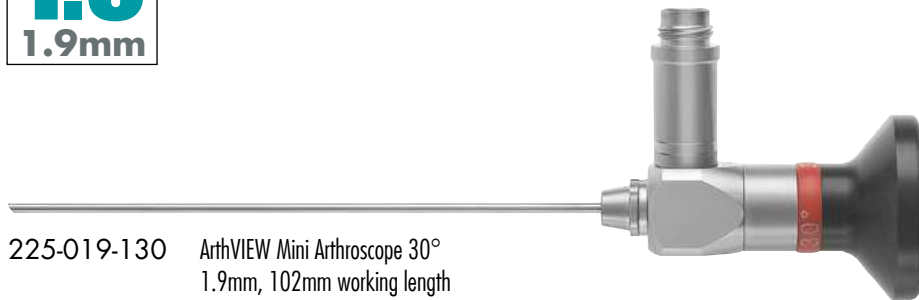

225-019-130 ArthVIEW Mini Arthroscope 30°
1.9mm, 102mm working length
155mm overall length

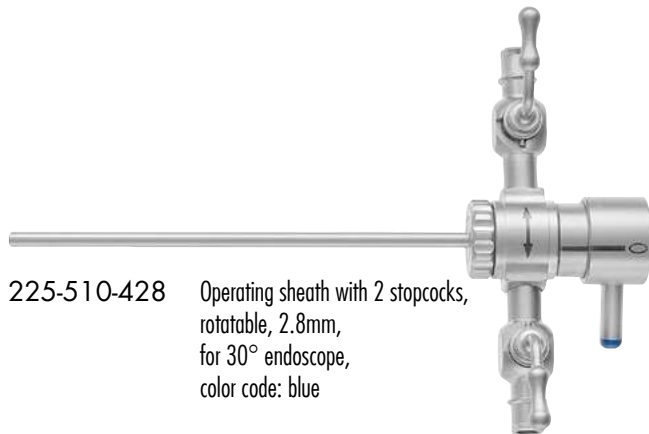

225-510-428 Operating sheath with 2 stopcocks,
rotatable, 2.8mm,
for 30° endoscope,
color code: blue

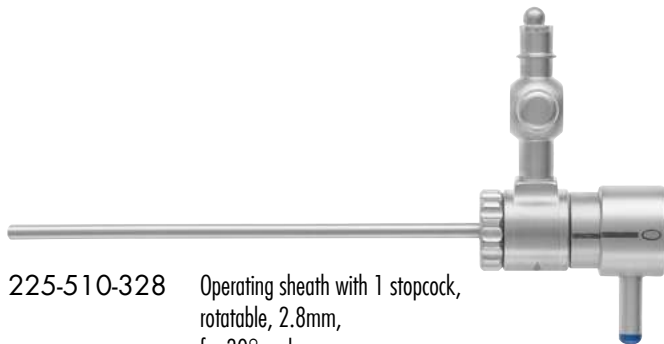

225-510-328 Operating sheath with 1 stopcock,
rotatable, 2.8mm,
for 30° endoscope,
color code: blue



225-510-528 Obturator, blunt, for 2.8mm
operating sheath, color code: blue



225-510-628 Trocar, sharp, for 2.8mm
operating sheath, color code: blue

2.4
2.4mm

ArthVIEW® TELESCOPE AND SHEATH SYSTEM ArthFLOW®

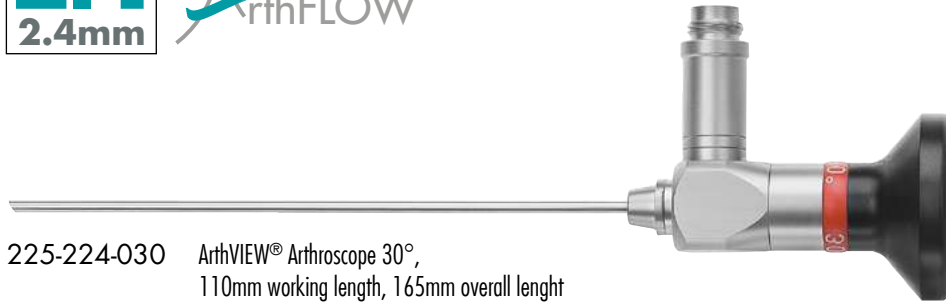

225-224-030 ArthVIEW® Arthroscope 30°,
110mm working length, 165mm overall length

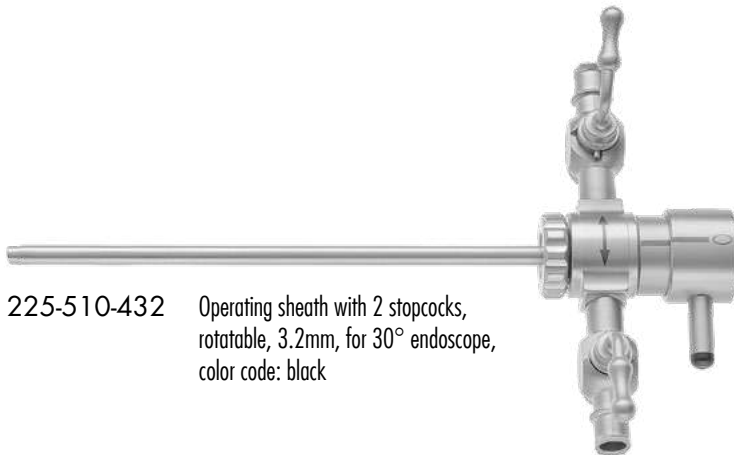

225-510-432 Operating sheath with 2 stopcocks,
rotatable, 3.2mm, for 30° endoscope,
color code: black

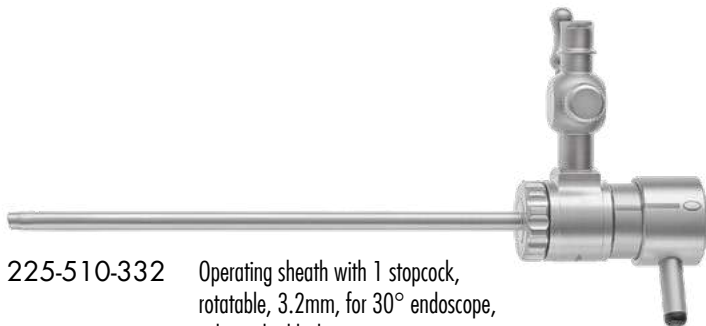

225-510-332 Operating sheath with 1 stopcock,
rotatable, 3.2mm, for 30° endoscope,
color code: black

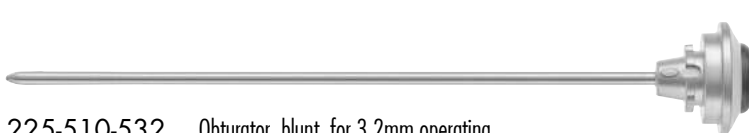

225-510-532 Obturator, blunt, for 3.2mm operating
sheath, color code: black



225-510-632 Trocar, sharp, for 3.2mm
operating sheath, color code: black



2.4
2.4mm

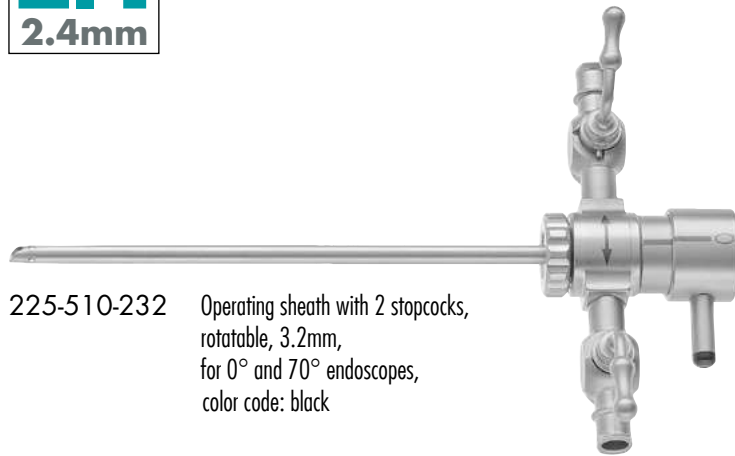

225-510-232 Operating sheath with 2 stopcocks, rotatable, 3.2mm, for 0° and 70° endoscopes, color code: black

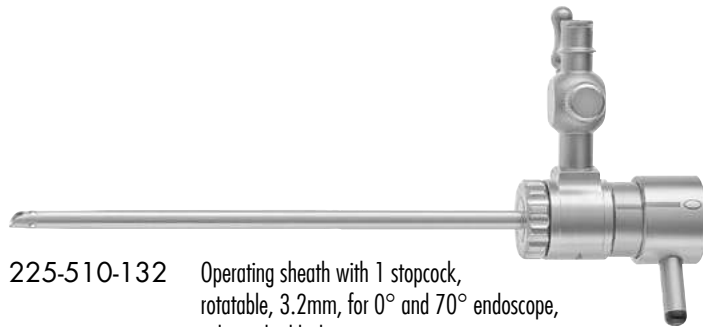

225-510-132 Operating sheath with 1 stopcock, rotatable, 3.2mm, for 0° and 70° endoscope, color code: black



225-510-532 Obturator, blunt, for 3.2mm operating sheath, color code: black



225-510-632 Trocar, sharp, for 3.2mm operating sheath, color code: black



2.7
2.7mm

ArthVIEW® TELESCOPE AND SHEATH SYSTEM ArthFLOW®

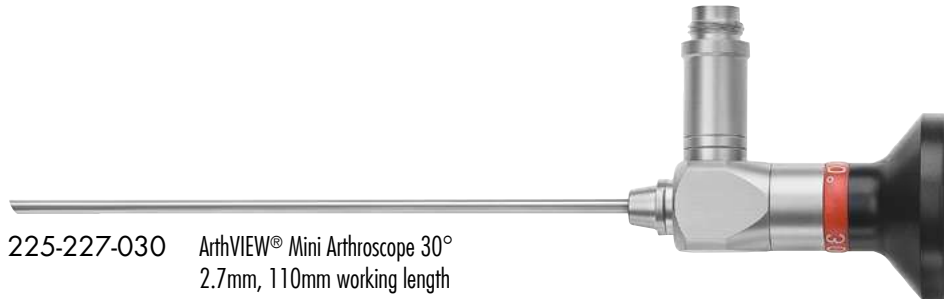

225-227-030 ArthVIEW® Mini Arthroscope 30°
2.7mm, 110mm working length

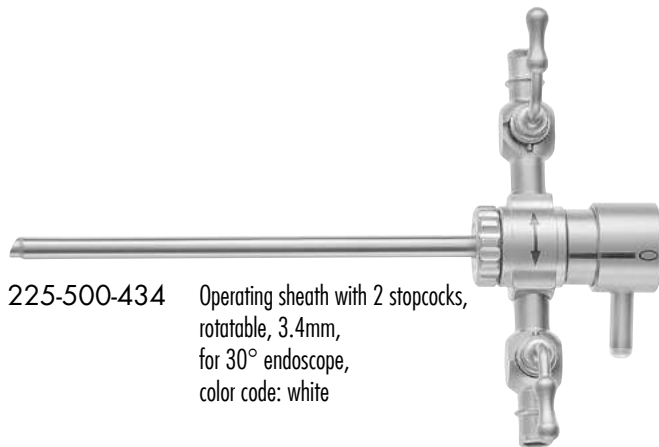

225-500-434 Operating sheath with 2 stopcocks,
rotatable, 3.4mm,
for 30° endoscope,
color code: white



225-500-534 Obturator, blunt, for 3.4mm operating
sheath, color code: white



225-500-634 Trocar, sharp, for 3.4mm
operating sheath, color code: white

2.7
2.7mm

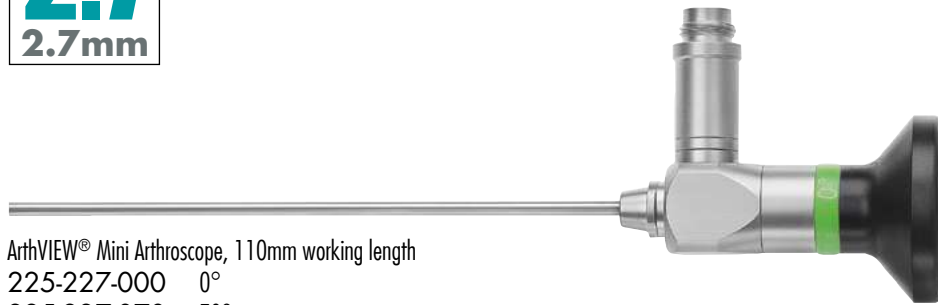

ArthVIEW® Mini Arthroscope, 110mm working length
225-227-000 0°
225-227-070 70°

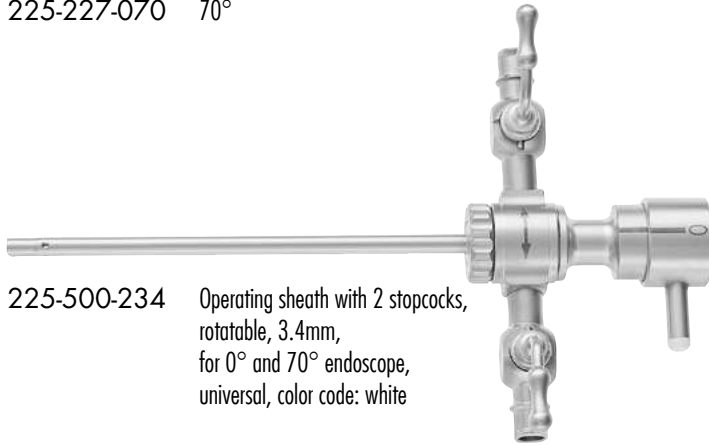

225-500-234 Operating sheath with 2 stopcocks, rotatable, 3.4mm, for 0° and 70° endoscope, universal, color code: white

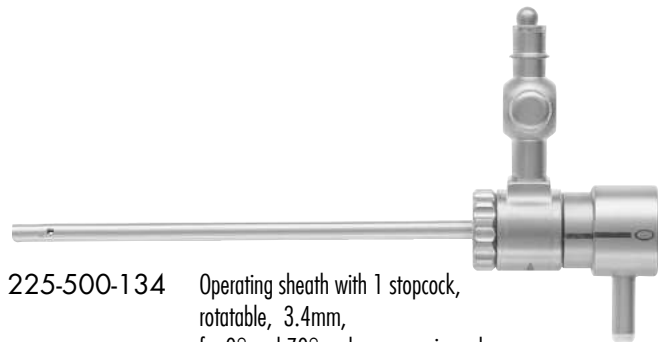

225-500-134 Operating sheath with 1 stopcock, rotatable, 3.4mm, for 0° and 70° endoscope, universal, color code: white



225-500-534 Obturator, blunt, for 3.4mm operating sheath, color code: white



225-500-634 Trocar, sharp, for 3.4mm operating sheath, color code: white



ArthVANCE® MINI PUNCHES

- Fine jaws
- Shorter shafts
- Ergonomic handles



RING
HANDLE



- DUCKBILL MINI Punch cut 1.5mm
- 225-810-102 straight jaws, straight shaft
 - 225-810-105 Upbiter
 - 225-810-107 Straight jaws, left curved shaft
 - 225-810-109 Straight jaws, right curved shaft



- 225-810-202
OVAL MINI PUNCH, straight jaws, straight shaft



- 225-810-302
BLUNT NOSE MINI Basket Punch, straight jaws, straight shaft



- 225-810-203
OVAL MINI PUNCH, left jaws, straight shaft



- 225-810-204
OVAL MINI PUNCH, right jaws, straight shaft



- 225-810-472
HOOK SCISSORS, straight, 2.7mm Ø



- 225-810-930
MINI RONGEUR, straight



SLIDE-
LOCK HANDLE



225-810-820
SHARK MINI Grasping Forceps, straight jaws, straight shaft



225-810-825
ALLIGATOR MINI Grasping Forceps, straight jaws, straight shaft



PENCIL
HANDLE



225-810-955
Side Cutter MINI Basket Punch, Left side cutting, 2.2mm



225-810-957
Side Cutter MINI Basket Punch, right side cutting, 2.2mm

MINI INSTRUMENTS

Ø 2mm, 100mm working length

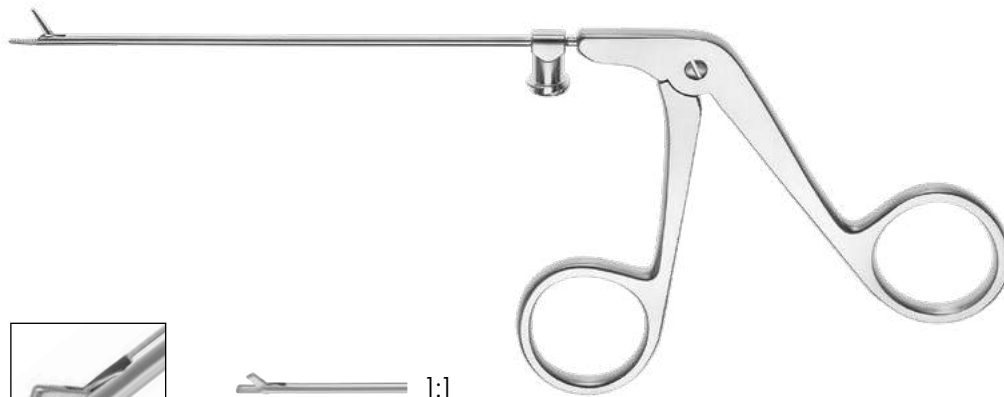

225-305-020 1:1
Mini Punch



225-307-020 1:1
Mini Cupped Forceps
Ø 2mm



225-310-020 1:1
Mini Scissors, upwards cutting



225-309-020 1:1
Mini Grasping Forceps



225-311-020 1:1
Mini Scissors, short, upwards cutting



Wire finger grip
215-000-001 small
215-000-002 medium
215-000-003 large

ArthVANCE® SUCTION PUNCHES

with universal tube connector, 110mm working length



225-695-027

UpBiter
 Ø 2.7mm, upwards cutting,
 5mm jaw opening

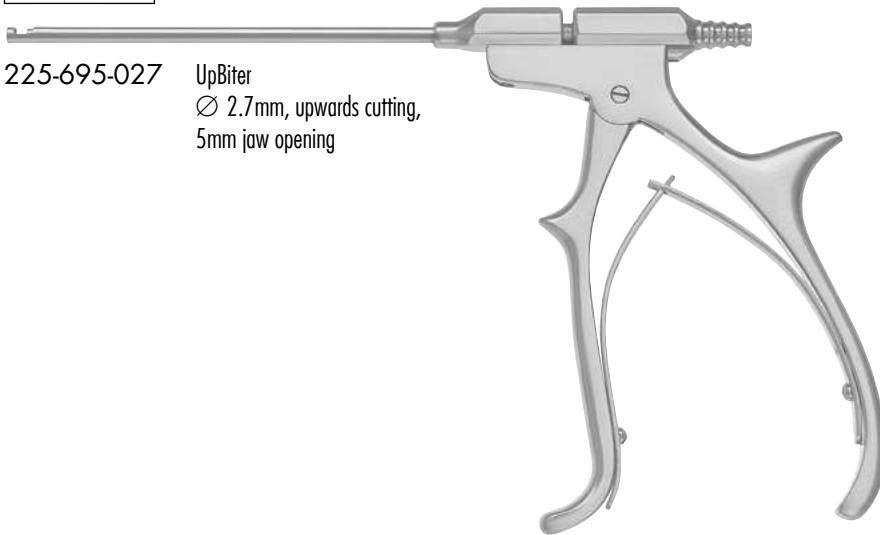

225-696-027

DownBiter,
 Ø 2.7mm, downwards cutting,
 5mm jaw opening

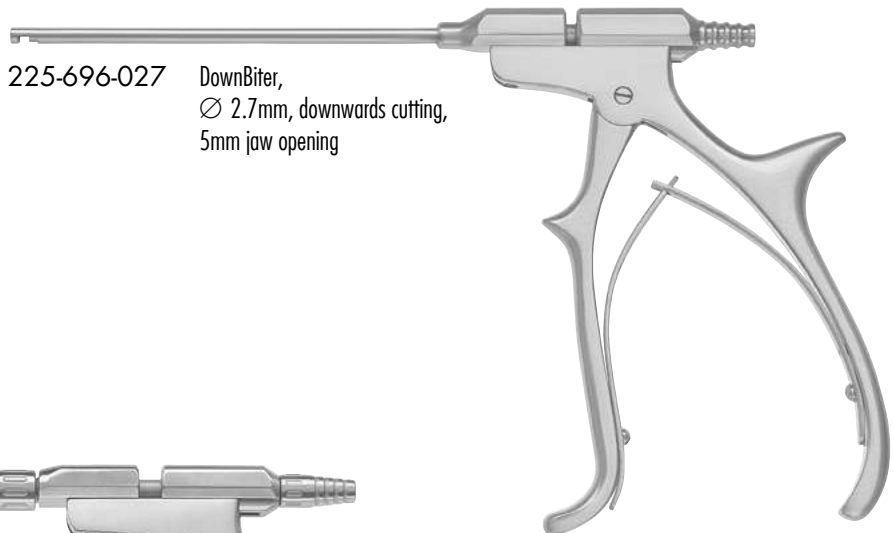

225-699-027



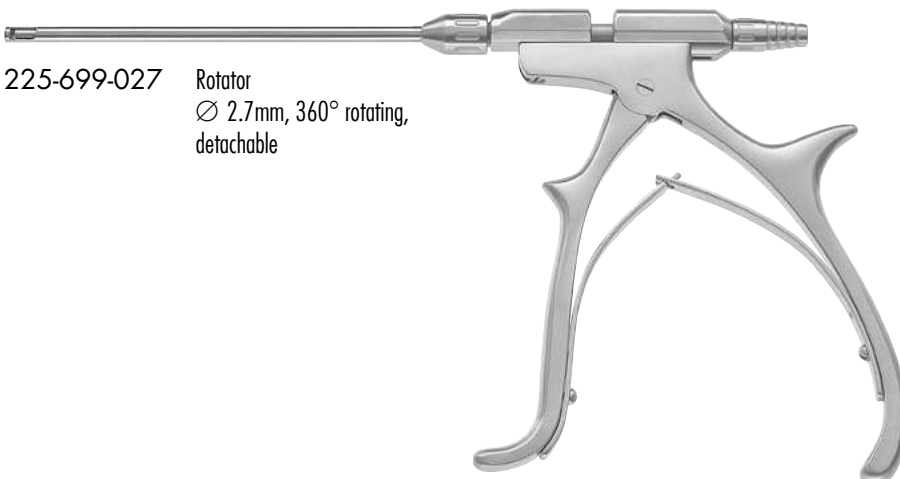





Rotator
 Ø 2.7mm, 360° rotating,
 detachable



HAND INSTRUMENTS



90mm working length

	Exploring Probe, graduated, straight	225-090-001
	Mini Rasp, concave jaw	225-090-004
	Mini-Rasp, convex jaw	225-090-005
	Mini Knife	225-090-006
	Mini Knife	225-090-008
	Mini Knife	225-090-007
	Exploring Probe, graduated, curved	225-090-002
	Mini-Bone Curette	225-090-009



Hook Probe and Retractor, 40mm working length

225-400-102 2mm hook length, 90° angled hook

225-400-103 3mm hook length, 45° angled hook



Probe Hook, graduated, 1mm hook

225-100-115 ∅ 1.5mm, 75mm working length









225-100-123 ∅ 2.3mm, 140mm working length



225-100-004





Exploring Probe, 90° angled, Tip 1.0mm diameter, graduated, working length: 130mm, knurled handle



	Spoon, 3mm, angled tip	225-100-006
	Smilie Meniscotome, 3mm wide, straight cutting edge	225-100-020
	Smilie Meniscotome, 5mm wide, straight cutting edge	225-100-022
	Smilie Meniscotome 7mm wide, curved cutting edge	225-100-023
	Rosen Knife, toothed blade	225-100-025
	Scalpel Knife	225-100-034
	Banana Knife	225-100-029
	Hook Knife, reverse cutting	225-100-038
	Retrograde Knife, 45° angled blade	225-100-041

RZ MINI CHONDRO PICKS



	25° angled	225-600-125
	45° angled	225-600-145
	60° angled	225-600-160
	90° angled	225-600-190
	115° angled	225-600-215

DEVICES & CLEANING





Features:

- Versatile Irrigation Pump
- Pump leveling adjustment
- Pressure controlled roller pump

225-906-000 Basic Irrigation Pump P1

DELIVERY CONTAINS:

- Pump device
- Tubing set (253-910-001)
- Mains cable
- 2 Spare fuses
- Operating manual

Technical data

Line voltage	100-240 VAC
Power input	80VA
Irrigation power	0 - 1.0L/min
Pressure range	10 - 150mmHG
Measurements	380 x 130 x 400mm (WxHxD)
Weight	approx. 11kg



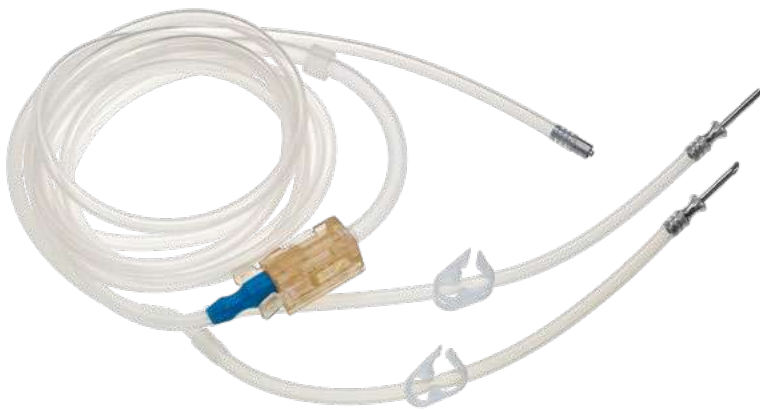

Accessories

225-910-001	Irrigation Tubing Set, silicone, autoclavable	non-sterile	included
225-910-002	Irrigation Tubing Set, PVC, 20 pieces, daily tube	sterile	optional
225-910-003	Patient tube, PVC, 2.5m, 40 pieces	sterile	optional





Features:

- 4K UHD resolution with 3-chip technology
- Image algorithm enhancement of color and structure
- 4K video recording
- 4K image saving
- Camera head with 4 programmable buttons
- Boost function
- Fog reduction
- Freeze function
- 2.5x digital zoom
- 10 USER mode configurations
- Multilingual on screen menu
- SDI 4K Output
- Text generator (optional with keyboard)

DELIVERY CONTAINS:

- Main Unit (300-001-840)
- Camera head (300-001-841)
- HDMI cable
- USB Pen Drive
- Mains cable
- Operating manual

300-001-840 4K 3-Chip UHD-Camera K 4000

4K

Technical data

Line voltage	100-240 VAC
Power consumption	60VA
Image sensor	3 MOS
Resolution	3840 x 2160 pixels (4K)
Index ratio	16:9
N/N ratio	54db

Video outputs	1x HDMI 4K 1x HDMI FullHD 1x SDI 4K 1x SDI FullHD
Dimensions	Control unit: 355 x 103 x 350mm (WxHxD) Weight control unit: 6.2kg Weight camera head: 145g

Accessories



300-001-841
UHD 3-Chip Camera Head
(included in the set)



300-001-615
Title generator keyboard, waterproof IP68
US-Layout, cable 1.8m, color: grey,
305x140x15mm, 600gr.



300-001-610
Footswitch for HD Cameras
cable length: 2m



Features:

- Full HD camera with 3-chip MOS technology
- Pure Natural Colors technology
- Full HD video recording (F4 only)
- Full HD image saving (F4 only)
- Camera head with 3 programmable buttons
- Boost function
- Freeze function
- 2.5x digital zoom
- 3 USER mode configurations
- Multilingual on screen menu
- Different digital video outputs
- Text generator (optional with keyboard)

DELIVERY CONTAINS:

- Main Unit
- Camera head
- YPbPr/RGB cable
- 2x BNC cable
- Jack Cable
- HDMI - DVI cable
- HDMI cable
- S-Video cable
- USB Pen Drive (F4 only)
- Mains cable
- Operating manual

- 300-001-800 3 Chip HD-Camera F3
- 300-001-804 3 Chip HD-Camera F4 (with recording function)

FULL HD

Technical data

Line voltage	100-240 VAC
Power input	20W
Image sensor	3 MOS
Resolution	1920 x 1080 pixels (FullHD)
Image resolution	>1000 TV lines, horizontal
Index ratio	16:9
Min. sensitivity	< 3lx (1/1.4)
Shutter speed	1/50 (1/60) to 1/100.000sec

Video outputs (F4)	2 x HD SDI 1x HDMI / DVI 2x CVBS 1 x YPbPr / RGB 1 x Y/C (Pal/NTSC) 1x CVBS (Pal/NTSC)
Video outputs (F3)	1 x HDMI / DVI 1 x YPbPr (Component) 1 x Y/C (Pal/NTSC) 1x CVBS (Pal/NTSC)
Dimensions	Control unit: 380 x 120 x 360mm (WxHxD) Weight control unit: 11kg Weight camera head: 145g

Accessories



300-001-802
High-End 3-MOS Camera Head
FullHD (included in the set)



300-001-615
Title generator keyboard, waterproof IP68
US-Layout, cable 1.8m, color: grey,
305x140x15mm, 600gr.



300-001-610
Footswitch for HD Cameras
cable length: 2m

TV COUPLER



4K
FULL HD

300-001-823 f=14mm
300-001-824 f=25mm
300-001-825 f=28mm
c-mount, soakable



4K
FULL HD

250-015-030
Zoom-TV-Adapter
f=15 - 30mm
c-mount, soakable



FULL HD

250-020-025 F=25mm (splitting 90/10)
250-020-030 F=30mm (splitting 90/10)
Beamsplitter, allows simultaneous video
and direct views, c-mount, soakable



FULL HD

300-001-813 f=14mm
300-001-814 f=25mm
c-mount, soakable



Features:

- 6500K daylight color temperature
- 375 Watt equivalent output power
- > 20.000 hours lifetime
- Turret connector for the most common light cables (Olympus, Wolf, Gyros ACMI, Storz)
- Manual or automatic light control
- Waterproof touch control panel
- Low heat conduction by improved LED technology
- Boost function: light increase of 20%

300-900-300 LUMEN LED 3 PRO Light Source, 110 - 230V

DELIVERY CONTAINS:

- Main Unit (300-900-300)
- BNC cable (optional)
- Mains cable
- Operating manual



Technical data

Line voltage	100-240 VAC
Video input	1x Video, BNC
Protection class	1 (acc. IEC 60601-1) 1 (acc. MDD 93/42/EEC)
Safety class	BF
Standard	IEC 60601-1-2
Dimensions	380 x 120 x 360mm (WxHxD)
Weight	approx. 11kg



A OLYMPUS

B WOLF

C GYRUS ACMI

D STORZ
KARL STORZ ENDOSKOP
TECHNIK

Turret, multi connector



Features:

- More than 20.000h lamp lifetime
- 180 Watt equivalent power output
- Manual or automatic light control
- Waterproof touch control panel
- Low heat conduction by improved LED technology
- Daylight color temperature 6000 – 6500° K for accurate color representation
- Boost function: light increase of 20%

300-900-180 LUMEN LED 1 Light Source

DELIVERY CONTAINS:

- Main Unit (300-900-180)
- BNC cable
- Mains cable
- Operating manual



Technical data

Line voltage	100-240 VAC
Power consumption	130VA
Video input	1x Video, 1x S-Video (Y/C) (automatic version only)
Protection class	1 (acc. IEC 60601-1) 1 (acc. MDD 93/42/EEC)
Safety class	BF
Dimensions	380 x 120 x 360mm (WxHxD)
Weight	approx. 11kg

HIGH TEMPERATURE LED/XENON LIGHT CABLES



Adaptor pieces to use with **endoscope**



250-042-000
RZ/Storz/Olympus



250-040-000
Wolf



250-041-000
ACMI/British Standard

XENON/LED Light Guide Cables
with melt and bending protection

250-025-230 Ø 2.5 mm, 2300 mm

250-025-300 Ø 2.5 mm, 3000 mm

250-035-180 Ø 3.5 mm, 1800 mm

250-035-230 Ø 3.5 mm, 2300 mm

250-035-300 Ø 3.5 mm, 3000 mm

250-048-180 Ø 4.8 mm, 1800 mm

250-048-230 Ø 4.8 mm, 2300 mm

250-048-300 Ø 4.8 mm, 3000 mm

Adaptor pieces to use with **light source**



250-039-000
RZ/Storz



250-038-000
ACMI/CUDA



250-048-000
Luxtec



250-051-000
Stryker



250-037-000
Wolf



250-044-000
Olympus



250-045-000
Olympus - Standard



250-052-000
Heine



250-059-000
Pentax



COMPATIBILITY NOTE:

A fiber optic cable with a large diameter should not be connected to a smaller diameter scope.
For example: Ø 4.8mm fiber optic cables connected to a Ø 2.9mm may risk high temperature at the light entry of the endoscope and may risk patient safety.



Features:

- Open window calibration of shaver blades
- 9 oscillation modes
- Forward / Backward 500 - 8000rpm
- Controlled by handpiece or by footswitch
- Fully autoclavable, small and ergonomic handpiece
- Dedicated shaver blades



227-001-110 Stunner Shaver Unit

DELIVERY CONTAINS (complete Set 227-001-110):

- Main Unit (227-001-101)
- Handpiece, without blade (227-001-102)
- Footswitch (227-001-103)
- Mains Cable

Technical data STUNNER CONTROL UNIT S

Line voltage	100-240 VAC
Power consumption	20 - 35VA
Speed range	FWD, REV: 500 - 8000 RPM (+/- 10%) OSC: 500 - 3500 RPM (+/- 10%)
Oscillation modes	9
Dimensions	380 x 360 x 125 (WxDxH)
Weight	7.62kg

Technical data STUNNER HANDPIECE

Buttons	ON/OFF, window calibration, direction change (FWD, OSC, REV) change of oscillation modes
Dimensions	164mm, 3m cable length
Weight	350g

Technical data STUNNER FOOTSWITCH

Functions	Speed Up, Speed Down, START/STOP, Window Size, Direction (FWD, OSC, REV)
Dimensions	280 x 215 x 28 (WxDxH), 3.2m cable length

Accessories (included)

Stunner Hand Piece
227-001-102



Stunner Footswitch
227-001-103



RZ MEDIA WORKSTATION Innovative Documentation System – the stand alone “all in one” solution

Sophisticated users get a comprehensive tool for creating, documenting and archiving of videos, pictures and findings.

An extensive set of tools gives the ability for easy creation of individual and complex findings reports. Easy integration into IT-environment ensures an optimal workflow. The database provides long-term availability of picture findings with almost no capacity limitation.

Diagnostics & Results

- Recording of videos and pictures
- PACS support DICOM worklist/store
- Playing videos with abstraction of individual images
- Manual input of comments and markers for sessions and recordings
- Graphical markers with individual comments
- Creation of reports incl. patient information, pictures, videos and comments
- Full-text search in data base
- User management including import, adaption and export of patients
- LIVE OR communication via e.g. Zoom, Skype or Teams
- Hospital Safety guidelines
(Windows based network and firewall)



Documentation System 21" touch

300-001-199 OR version with DICOM worklist

300-001-198 without DICOM worklist





300-001-168
Endovue 32" HD Monitor

300-001-158
Endovue 24" HD Monitor

Technical data

Screen size	31.5" / 24" diagonal
Resolution	1920 x 1080
Aspect ratio	16:9
Viewing angle	178°
Numbers of colors	16.7 Million (8-bit)
Video Inputs	DVI-D, RGBS/VGA/YpPr (HD-15 or DVI-I via adapter), S-Video, Composite
Video Outputs	DVI-D
Weight	8.8kg (300-001-168) 6.7kg (300-001-158)



300-001-232
Radiance 32" HD Monitor

300-010-226
Radiance 27" HD Monitor

Technical data

Screen size	32" / 27" diagonal
Resolution	1920 x 1080
Aspect ratio	16:9
Viewing angle	178°
Numbers of colors	1.07 Billion (10-bit)
Video Inputs	DVI-I and 3G-SDI Input/Output
Video Outputs	DVI-D
Weight	11.0kg (300-001-232) 8.9kg (300-010-226)



300-001-031
UHD 4K Monitor, 31"

Technical data

Screen size	31" diagonal
Resolution	4096 x 2160
Aspect ratio	17:9
Viewing angle	178°
Number of colors	1.08 Billion (10-bit)
Video Inputs	1 x HDMI 2.0 1 x DP 1.2 (SST) & 1 x DP 1.2 (MST) 1 x DVI (single link), 4 x SDI (3G)
Video Outputs	1 x DP 1.2 (SST) 1 x DVI (single link), 4 x SDI (3G)
Weight	10.5kg



300-001-055
UHD 4K Monitor, 55"

Technical data

Screen size	55" diagonal
Resolution	3840 x 2160
Aspect ratio	16:9
Viewing angle	178°
Numbers of colors	1.08 Billion (10-bit)
Video Inputs	1 x HDMI 2.0, 2 x DP 1.2 (55T) 1 x DVI (single link), 2 x DVI (dual link) 4 x SOi (3G), 2 x SOi (12G)
Video Outputs	1 x DVI (single link), 1 x DP 1.2 (SST) 4 x SDI (3G), 2x SDI (12G)
Weight	37.35kg



300-001-999
 Dimensions: 1600mm x 500mm x 625mm
 with rollers Ø 125mm, complete

The RZ Trolley 300-001-999 is the universal solution for all applications.
 A range of diagnostic instrumentation, treatment and measuring equipment, plus PCs, eg. with monitor arm or infusion stand and gas bottles.



Modular, easy changeable setup



Optional: Keyboard holder



Optional: Camera head holder



Optional: CO2 Bottle holder



300-001-988
 Hydraulic monitor holding
 400mm

ARTHROSCOPY INSTRUMENTS CONTAINER

600-513-000

Container for 8 instruments in upright position
with utility space for extra instruments



600-513-005

Container Case with inner tray
for 5 Chondro Picks + Hammer
or 6 Hand Grip Instruments
Dimensions: 400 x 45 x 250mm

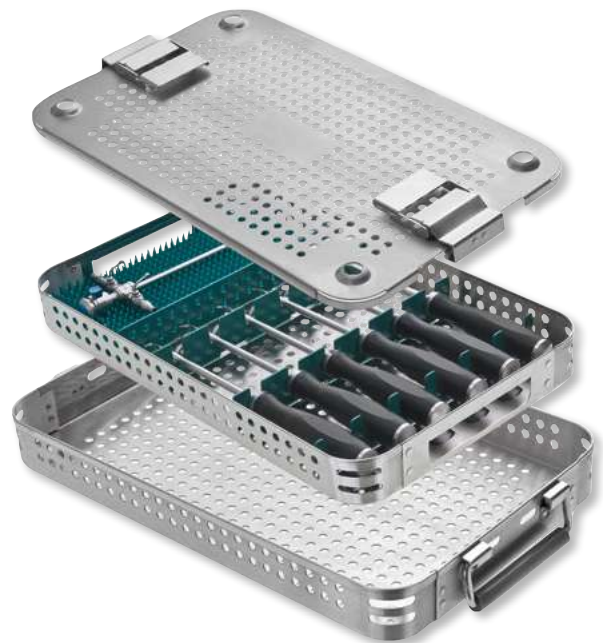

600-513-004

Storage rack for shaft instruments
Dimensions: 220 x 232 x 155mm

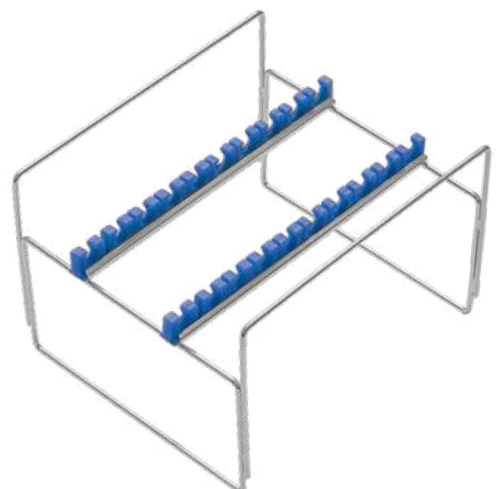

SAFE+ CLEAN ENDOSCOPE PLASTIC CONTAINER with silicone bars on base and lid

600-505-000

Endoscopes	1 (∅ 1-10mm)
Endoscope length	max. 270mm
Dimensions	271 x 70 x 35mm

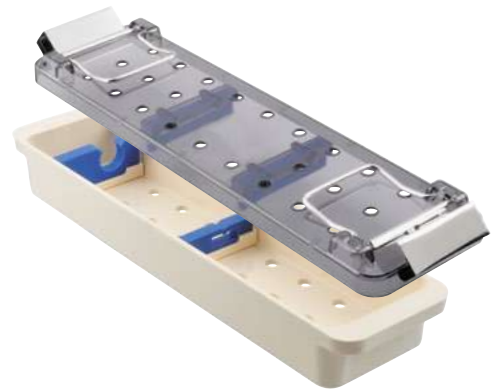

600-505-002

Endoscopes	max. 2
Endoscope length	max. 190mm
Dimensions	271 x 70 x 35mm

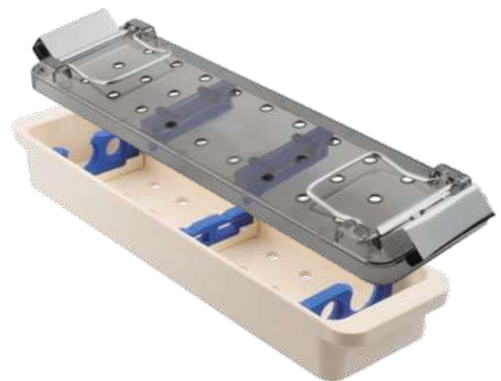

600-506-002*

Endoscopes	max. 2
Endoscope length	max. 390mm
Dimensions	394 x 70 x 35mm

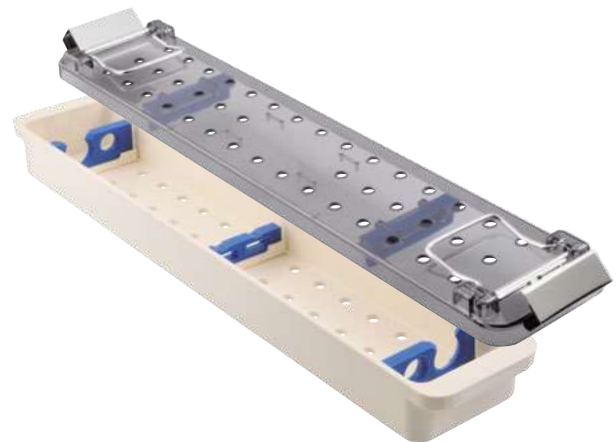

600-501-000

Endoscopes 1

600-501-002

Endoscopes max. 2

Endoscope length	max. 450mm
Dimensions	457 x 70 x 35mm

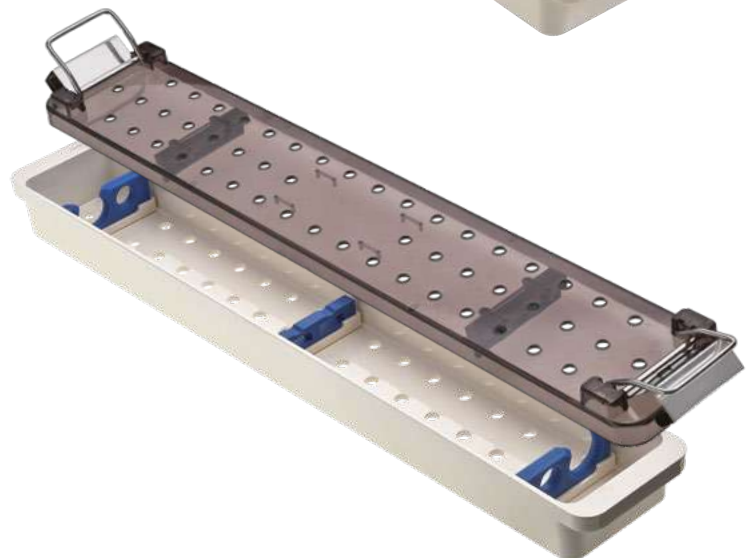

ENDOSCOPE & INSTRUMENT CONTAINERS

600-508-000	for scopes and light guide cables
Endoscopes	max. 3 (Ø 5-10mm)
Fiber Optic Light Cable	1
Endoscope length	max. 450mm
Dimensions	465 x 212 x 51mm

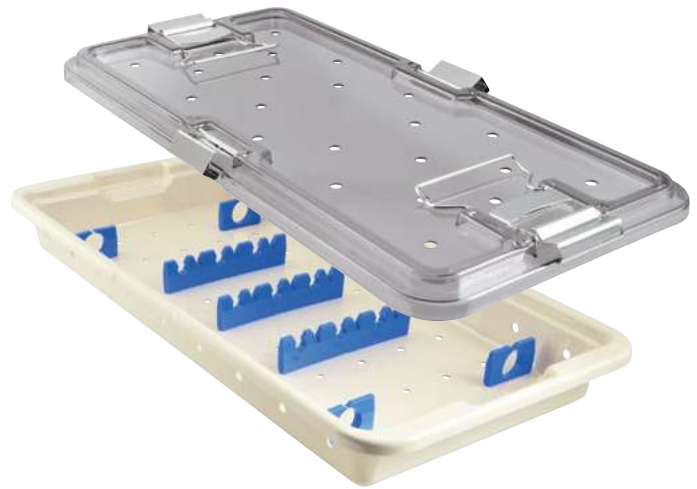

600-464-229	for fixation of instruments with rubber ties
Dimensions	464 x 229 x 51mm



600-511-000	for instruments with rubber ties on 2 levels
Dimensions	502 x 239 x 102mm



ENDOSCOPE CLEANING BASKETS & CONTAINERS with silicone bars on base and lid

600-292-052*

Endoscopes	max. 2
Endoscope length	max. 190mm
Dimensions	290 x 80 x 52mm

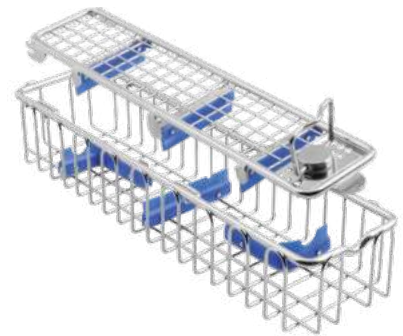

600-462-052*

Endoscopes	max. 2
Endoscope length	max. 350mm
Dimensions	460 x 80 x 52mm

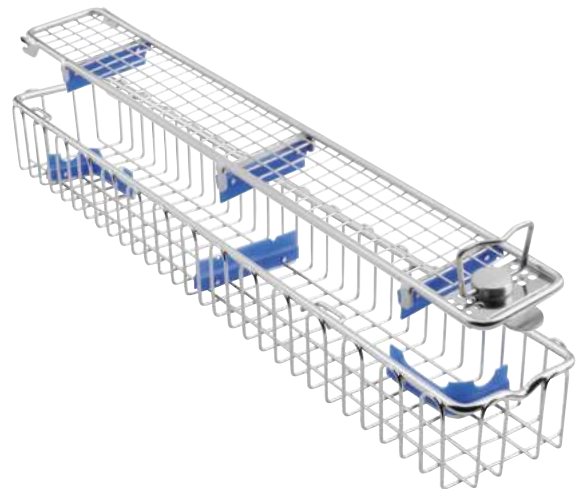

600-460-055	Endoscopes 1
600-460-056	Endoscopes max. 2
Endoscope length	max. 340mm
Dimensions	455 x 86 x 43mm

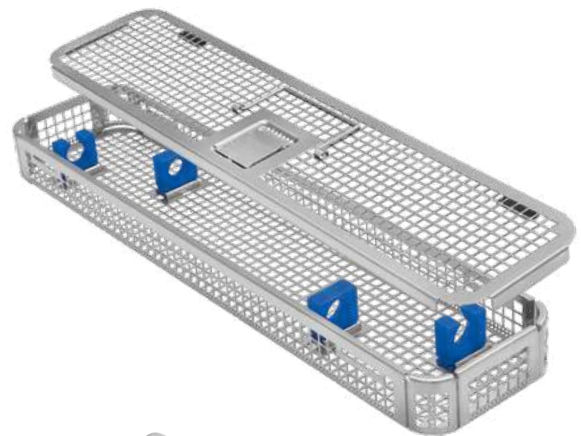

600-450-070

Endoscopes	max. 2
Endoscope length	max. 330mm
Dimensions	450 x 70 x 70mm

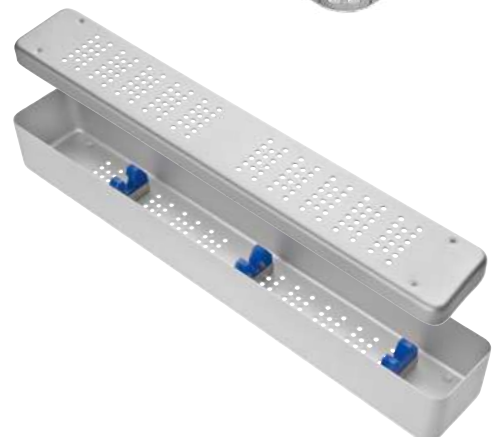

Cleaning



600-100-000
RZ-Aquajet
Water Jet Pistol complete
with 9 tips and 1m pressure
tubing, with strap and
suspension hook



600-050-000
Hand brush, autoclavable
(10 pcs. per box)



600-950-100
RZ - Brush dispenser
for 10 brushes with suspension hook



700-900-220 Special Cotton for polishing metal sheaths and instruments

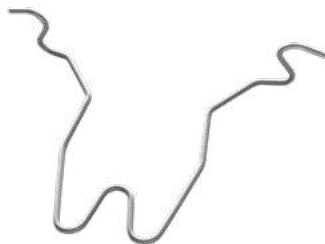

660-166-100
Holding Device for cleaning & sterilization

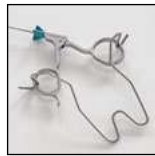

700-900-160
Instrument Oil in 50ml bottle



700-900-250
Oil Dispenser, 140mm



Cleaning brush (1 piece per box), 500mm length
300-135-905 for \varnothing 5 mm
300-135-910 for \varnothing 10 mm



300-215-000 Cleaning Brush, \varnothing 13mm, 215mm length, 60mm brush length



300-420-065 Cleaning Brush, \varnothing 3mm, 420mm length, 65mm brush length