

Fisa tehnica lampa

SLB – 150 W

INTRODUCERE

Ultima generatie de rampe luminoase produsa de firma romaneasca MTX LED SOLUTIONS este ideala pentru utilizarea in sistemele de avertizare a vehiculelor cu destinatie luminoasa. Lampa SLB poate fi folosita in sistemele de avertizare ale masinilor de politie, pompieri, ambulante si masini de asistenta rutiera. Materialele de inalta calitate utilizate in constructie garanteaza rezistenta extraordinara la impact mecanic sau umiditate ridicata. Specificatiile tehnice si aspectul inovativ, coroborat cu materialele si optica special proiectata ofera un avantaj competitiv semnificativ fata de solutiile existente.



SPECIFICATII

Tip LEDs	LED CREE 3W
Moduri avertizare	5
Tensiune nominala	12/24VDC
Putere medie consumata	120W – 190W*
Putere maxim consumata*	310W*
Putere difuzor integrat	150W
Flux minim LED albastru	> 60 lumeni/LED
Temperature functionare	-30 °C/ +50 °C
Norme respectate	R65 class 2, R10
Lungime cablu	400 mm
Tip cablu	12 x G0.75 black
Durata de functionare**	≥ 35000 h
Clasa de protectie	IP66
Numar flashuri/min.	80
Nr. Leduri/modul	24

* Exemplu versiunea SLB-2x6ML6-BLU (6 x module albastre) + 4xML6-WHITE (4 x module albe frontale)

** Timp de functionare estimate pe baza estimarii duratei de functionare a componentelor critice.

CARACTERISTICI PRINCIPALE

- LED Cree®
- Profil Aluminiu
- Eficienta ridicata si rezistenta la intemperii.
- Comutare automata zi/noapte
- 5 moduri Flash disponibile
- Protectie la polaritate inversa

DIMENSIUNI

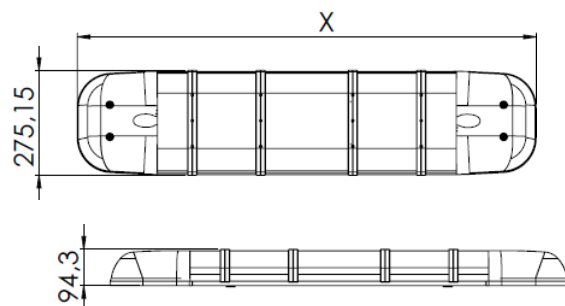

APLICABILITATE LAMPA

SLB poate fi utilizat in diferite tipuri de aplicatii cum ar fi:

- Masini de politie
- Masini de pompieri
- Ambulante
- Vehiculare auxiliare directionare trafic
- Vehicule asistenta rutiera

Lungime totala lampa- X*
1100 mm
1200 mm
1300 mm
1400 mm
1500 mm
1600 mm
1700 mm
1800mm
*Alte dimensiuni disponibile la cerere

Contact:



+40 752 015 605

sales@mtxledsolutions.com www.mtxledsolutions.com

MTX LED Solutions isi rezerva dreptul de a efectua modificari tehnice fara notificare prealabila.

Toate drepturile rezervate © MTX LED Solutions 06.05.2020 R01

Fisa tehnica lampa

SLB – 150 W

VARIANTE DE CULOARE

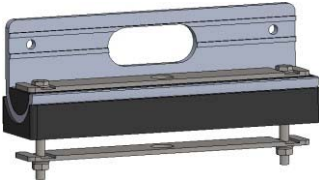
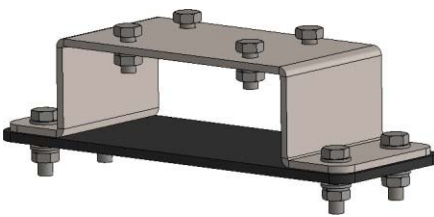

ACCESORII

SLB-MK1	SLB-MK2	SLB-MK3
		

COD DE COMANDA

Ordering code	Item	Description
DK171111.00000000*	SLB-aa-b-c-dd-AP-e	Versiune particularizata
*versiune particularizata: putere (aa), culoare lumina (b), culoare dispersor (c), conexiune (e) versiune speciala CCT(temperature de culoare corelata) (yy) si culoare radiator (x)		

Contact:



+40 752 015 605

sales@mtxledsolutions.com www.mtxledsolutions.com

DECLARATIE DE CONFORMITATE Nr. 20200624001



MTX LED SOLUTIONS

Taietura Turcului Str. no. 47
400221 CLUJ-NAPOCA
ROMANIA

Prin prezenta declaram ca produsele:

name: **SLB**
type: **Rampa Luminoasa**
variants: **SLB-2x6ML12B/R**
parameters: **12/24VDC, SELV, IP66, P≤ 250W; CISPR class5**

Sunt conforme cu dispozitiile urmatoarelor directive EC:

Directiva (LVD) – 2014/35/EU

Directiva (EMC) - 2014/30/EU

Directiva(RoHS) - 2015/863

Referințe la standarde și / sau specificații tehnice aplicate pentru această declarație de conformitate:

EN 55015:2013+A1:2015

EN 55025:2017

EN 61547:2009

EN 60598-1:2015

Ultimele două cifre ale anului în care marcajul CE a fost aplicat: **20**

Director zonal

Oprita Liviu

Semnatura autorizata

2020-06-24





ZAWIADOMIENIE

COMMUNICATION

Wydane przez: **DYREKTORA TRANSPORTOWEGO
DOZORU TECHNICZNEGO**
issued by: **DIRECTOR OF TRANSPORTATION
TECHNICAL SUPERVISION**
**ul. Puławska 125, 02-707 Warszawa,
Polska / Poland**



Dotyczące:¹⁾ - UDZIELENIA HOMOLOGACJI
Concerning:¹⁾ APPROVAL GRANTED
- ROZSZERZENIA HOMOLOGACJI / APPROVAL EXTENDED
- ODMOWY HOMOLOGACJI / APPROVAL REFUSED
- COFNIĘCIA HOMOLOGACJI / APPROVAL WITHDRAWN
- OSTATECZNEGO ZANIECHANIA PRODUKCJI / PRODUCTION DEFINITELY DISCONTINUED

typu specjalnego światła ostrzegawczego do pojazdów samochodowych na podstawie Regulaminu ONZ nr 65.

of a type of special warning lamp for motor vehicles, pursuant to UN Regulation No. 65.

Nr homologacji: E20*65R00/10*020157*00
Approval No.:

- Specjalne światło ostrzegawcze /obrotowe/ stacjonarne błyskowe /kierunkowe błyskowe/ belka /półbelka/ niebieska /żółta samochodowa/ czerwona ¹⁾**
Special warning lamp /rotating/ stationary flashing lamp /directional flashing lamp/ complete bar /half bar/ blue /amber/red ¹⁾
- Specjalne światło ostrzegawcze ma jeden/ dwa poziom(-y) światłości ¹⁾**
Special warning lamp has ~~one~~/ two levels of intensity ¹⁾
Specjalne światło ostrzegawcze składa się z jednego oddzielnego elementu ¹⁾
Special warning lamp consists of one separate units.
- Dla specjalnych świateł ostrzegawczych mających dwa poziomy światłości, wskazanie układu stosowanego do uzyskania zwiększonej światłości w czasie dnia:**
For special warning lamps having two levels of intensity, indicate the system used to obtain increased intensity at daytime:
Modulacja PWM modułu sterującego SLB-CONTROL
PWM modulation controlled SLB-CONTROL
- Zastosowane źródło światła / Used light source,**
- **kategoria żarówki lub / category of filament lamp or;** **Tak /yes Nie / no ¹⁾**
- **Wyladowcze źródło światła lub /gas discharge light source or;** **Tak /yes Nie / no ¹⁾**
- **LED / LED** **Tak /yes Nie /no ¹⁾**
lub / or
Moduł źródła światła / Light source module: **Tak /yes Nie / no ¹⁾**
Kod identyfikacyjny modułu źródła światła / Light source module specific identification code: . **Nie dotyczy / N/A**
- Napięcie znamionowe specjalnego światła ostrzegawczego:** **12V / 24V**
Rated voltage of special warning lamp:
- Nazwa handlowa lub marka:** **MTX LED SOLUTIONS**
Trade name or mark:
Typ / Type : **SLB-2x6ML6-BLUE ; kat. / cat. TB2**

7. **Nazwa wytwórcy i adres:** **MTX LED SOLUTIONS SRL**
Manufacturer's name and address: **Taietura Turcului Str. no.47**
400221 Cluj-Napoca, Rumunia / Romania
8. **Nazwa i adres przedstawiciela wytwórcy (o ile występuje)** **Nie dotyczy**
If applicable, name and address of manufacturer's representative: **Not applicable**
9. **Data przedstawienia do homologacji:** **2020-06-24**
Submitted for approval on:
10. **Placówka techniczna odpowiedzialna za przeprowadzanie badań homologacyjnych:** **Instytut Transportu Samochodowego ,**
Technical Service responsible for approval tests: **ul. Jagiellońska 80 , 03-301 Warszawa, Polska**
Motor Transport Institute ,
80 Jagiellonska str. , 03-301 Warsaw, Poland
11. **Data sprawozdania wydanego przez tę placówkę:** **16.06.2020 r.**
Date of report issued by that service:
12. **Numer sprawozdania wydanego przez tę placówkę:** **0449/ZBH/20/2**
Number of report issued by that service:
13. **Homologacji udzielono** ~~/rozszerzono / odmówiono / cofnięto~~¹⁾
*Approval granted / extended / refused / withdrawn*¹⁾
14. **Powód (powody) rozszerzenia (o ile występują):** **Nie dotyczy**
Reason(s) for the extension (if applicable): **Not applicable**
15. **Miejscowość / Place:** **Warszawa / Warsaw**
16. **Data / Date:** **26 czerwca 2020 r. / 26th of June 2020**
17. **Podpis:**
Signature:
- z up. **DYREKTOR**
Małgorzata Moździerz - Zarzyka
Zastępca Dyrektora
- 
18. **Wykaz dokumentów złożonych w Jednostce Administracyjnej, która udzieliła homologacji i dostępnych na żądanie, załączonych do niniejszego zawiadomienia:**
The list of documents, deposited at the Administrative Service which has granted approval and available on request is annexed to this communication :
1. **Dokumentacja techniczna specjalnej lampy ostrzegawczej LEDOWEJ, typ:** **SLB-2x6ML6-BLUE**
Approval documentation for special LED warning lamp, type: **z dnia / dated: 05.06.2020**
2. **Sprawozdanie z badań nr:** **0449/ZBH/20/2**
Test report No:

¹⁾ Niepotrzebne skreślić / Strike out what does not apply

COMUNICARE

E20

Emisă de: DIRECTOR TRANSPORTURI, SUPRAVEGHERE TEHNICĂ

Ul. Pulawska 125, 02-707 Varșovia, Polonia

Cu privire la¹: **APROBAREA ACORDATĂ**

APROBAREA EXTINSĂ

APROBAREA REFUZATĂ

APROBAREA RETRASĂ

PRODUCȚIA ÎNTRERUPTĂ DEFINITIV

A unui tip de lampă de avertizare specială pentru vehiculele cu motor, în conformitate cu Regulamentul UN nr. 65.

Aprobarea nr. E20*65R00/10*020157*00

1. **Lampă de avertizare specială/lanternă rotativă/lanternă staționară/lanternă direcțională/bară completă/jumătate de bară/albastră/chilimbarie/roșie**
2. Lampa de avertizare specială are ~~unu~~/două niveluri de intensitate
Lampa de avertizare specială constă în unități separate.
3. Pentru lămpile de avertizare speciale care au două niveluri de intensitate, indicați sistemul folosit pentru a obține o intensitate mai mare în timpul zilei:

Modulația PWM controlată cu SLB-CONTROL

4. Sursa de lumină folosită
 - Categoria de lampă cu filament: NU
 - Sursa de lumină a descărcării de gaze: NU
 - LED: da
 - Modulul sursei de lumină: NU
 - Codul de identificare al modulului sursei de lumină: N/A
5. Tensiunea nominală a lămpii de avertizare speciale: 12V/24V
6. Marca înregistrată sau marca: MTX LED SOLUTIONS
Tipul: SLB-2x6ML6-BLUE; categoria TB2
7. Numele și adresa producătorului:
MTX LED SOLUTIONS SRL
Str. Tăietura Turcului nr.47

¹ Tăiați ce nu se aplică

400221 Cluj-Napoca, România

8. Dacă este cazul, numele și adresa reprezentantului producătorului: Nu este cazul.
9. Depusă pentru aprobare în data de: 24.06.2020
10. Serviciul tehnic responsabil pentru testele de aprobare:
Motor Transport Institute,
80 Jagiellonska Str., 03-301 Varșovia, Polonia
11. Data raportului emis de acel serviciu: 16.06.2020
12. Numărul raportului emis de acel serviciu: 0449/ZBH/20/2
13. Aprobare acordată/~~extinsă/refuzată/retrasă~~
14. Motivul pentru extindere (dacă este cazul): Nu este cazul.
15. Locul: Varșovia
16. Data: 26 iunie 2020
17. Semnătura: Semnătură indescifrabilă și ștampilă
18. Lista de documente depuse la Serviciul administrativ care a acordat aprobarea și disponibile la cerere este anexată la această comunicare:
 1. Documentația tehnică de aprobare pentru lampa de avertizare specială cu LED, de tipul: SLB-2x6ML6-BLUE din data de: 05.06.2020
 2. Raportul de test nr. 0449/ZBH/20/2

Subsemnatul **CIUHU BOGDAN CONSTANTIN**,

traducător autorizat cu nr. 7319/2002 certific exactitatea traducerii cu textul documentului, redactat în limba **engleză** și vizat de mine.

Traducător Autorizat
CIUHU BOGDAN CONSTANTIN
Spaniolă, Engleză
Aut. M.I. 7319/2002

DataSheet GT-PR4100

INTRODUCTION

Generator and sirens/speakers are important element of an effective audio-visual warning system. Our products are characterized by high quality, which allows for high-quality sound.

The products are designed for installation in vehicles - they have increased resistance to vibration and IP class.

The device generates 4 basic warning sounds + the microphone.

Generator and sirens are short range secondary devices. The use of a siren/speaker does not mean that all drivers react to an emergency warning signal, especially when ride with a high speeds. For the safety and correctness operation of the device important is correct installation to the vehicle.

If some obstructions are in front of sirens/speakers maximum sound output will be reduced.



SPECIFICATION

GT-PR4100

Nominal power	100W
Impedance	11 Ohms Nominal
Power supply voltage	10-16VDC
Power consumption	8,5A @ 13,6 VDC
Working temperature range	-25 to +50°C
Dimensions of the central unit [mm]	160 mm x 150 mm x 60 mm
Dimensions of the manipulator [mm]	100 mm x 30 mm x 40 mm
TONES:	Hi-Lo, Yelp, Wail, Microphone

APPLICATIONS

GT-PR4100 100W can be used for voice communication while driving and for the emission of warning signals

- Ambulance
- Fire-fighting vehicles
- Police car
- Emergency vehicles
- Cars burdensome in traffic

Contact:



+40 748 751 465

sales@mtxledsolutions.com

www.mtxledsolutions.com

MTX LED reserves the right to make technical changes without prior notice.

Copyright © MTX LED 18.10.2018 VA05

INTRODUCERE

Ultima generație de lămpi de avertizare direcțională SWL a producătorului român MTX, reprezintă soluția ideală în ce privește echipamentul suplimentar de avertizare pentru vehicule speciale și privilegiate în traficul rutier. Lămpile sunt utilizate pe scară largă la mașinile de poliție, vehiculele de pompieri, ambulanțe, vehiculele de transport rutier și în asistența rutieră. Calitatea ridicată a materialelor garantează o rezistență excelentă la deteriorarea mecanică și umiditate. Parametrii tehnici, designul modern, optica dedicată și carcasa special proiectată, conferă lampii un avantaj semnificativ pe piață.



SPECIFICAȚII

FWL-Xx*2-y**-ALP-z

LED	CREE 3W LED ; 6 -12 buc.
Modele de avertizare	4
Tensiune de alimentare	10.9-30VDC
Curent mediu	A/B*: 0.5A-12V DC/ 0.25A-24V DC R*: 0.4A-12V DC/ 0.2A-24V DC
Putere medie	A/B*: 6 W (în funcție de model) R*: 4 W (în funcție de model)
Curent maxim	A/B*: 1.2A-12V DC / 0.6A-24V DC R*: 0.65A-12V DC / 0.35A-24V DC
Putere maximă	A/B*: 12W R*: 8W
Dimensiuni	125x28x16,5 mm
Cod IP	IP67
Culoarea luminii*	B*-Albastră, A*-portocalie, R*-roșie
Culoarea carcasei**	B**-Albastră, A**-portocalie, R**-roșie, C**-incoloră
Temperatură	-30 °C/ +50 °C
Sincronizare	Max. 10 buc
Cerințe	R65 class 2 , R10
Fire	Rosu- VCC-200mm (20AWG) Negru- GND-200mm (20AWG) Galben-Modele semnalizare & Sincro -200mm (20AWG)
Durata de viață***	≥ 35000 h

* Culoarea luminii și clasa

** Culoarea carcasei

*** Durata de viață estimată pe baza duratei de viață calculate a

CARACTERISTICI

- LED-uri Cree®
- Protecție împotriva tensiunii inverse
- Eficiență ridicată și rezistență la intemperii
- Mod zi/noapte
- Memorarea setărilor ultimului model de semnalizare
- 4 Modele de semnalizare
- Sincronizarea a pînă la 10 buc.
- Posibilitatea de a lucra alternativ

DIMENSIUNI



APLICAȚII

FWL poate fi folosită pe scară largă, în diferite tipuri de aplicații:

- Lumini pentru mașini de poliție
- Lumini pentru ambulanțe
- Lumini pentru autospeciale
- Lumini autospeciale pompieri
- Lumini pentru vehicule care asigură asistență rutieră intervenție drumuri

Contact:



+40 748 751 465

sales@mtxledsolutions.com

www.mtxledsolutions.com

MTXLED S își rezervă dreptul de a efectua modificări tehnice fără notificare prealabilă.
Copyright © MTX LED 23.12.2019 V01

MARCAJE

- XA2- Culoarea luminii-portocalie/ Clasa 2, mod zi/noapte
- XB2- Culoarea luminii-albastră/ Clasa 2, mod zi/noapte
- XR2- Culoarea luminii-roșie/ Clasa 2, mod zi/noapte

MODELE SEMNALIZARE

	Modele semnalizare
1	Singular
2	Dublu
3	Triplu
4	Quad

ACCESORII

FWL-ACC		
Nr.	Descriere	Cant.
1	Tampon cauciuc	1
3	St. 3,5x20 Surub	2

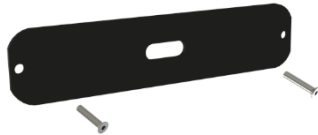

COD DE COMANDĂ

Cod de comandă	Articol	Descriere
190916.063A4023	FWL-XA2-A-ALP	Lumină portocalie, carcasă portocalie, clasa II, 6 LED-uri
190916.063A5023	FWL-XA2-C-ALP	Lumină portocalie, carcasă incoloră, clasa II, 6 LED-uri
190916.063B3023	FWL-XB2-B-ALP	Lumină albastră, carcasă albastră, clasa II, 6 LED-uri
190916.063B5023	FWL-XB2-C-ALP	Lumină albastră, carcasă incoloră, clasa II, 6 LED-uri
190916.063C1023	FWL-XR2-R-ALP	Lumină roșie, carcasă roșie, clasa II, 6 LED-uri
190916.063C5023	FWL-XR2-C-ALP	Lumină roșie, carcasă incoloră, clasa II, 6 LED-uri
190916.083B3023	FWL-XB2-B-ALP-8	Lumină albastră, carcasă albastră, clasa II, 8 LED-uri
190916.123B3023	FWL-XB2-B-ALP-12	Lumină albastră, carcasă albastră, clasa II, 12 LED-uri
190916.00000001	FWL-ACC	Pachet accesorii

Contact:



+40 748 751 465

sales@mtxledsolutions.com

www.mtxledsolutions.com

MXTLEDS își rezervă dreptul de a efectua modificări tehnice fără notificare prealabilă.
Copyright © MTX LED 23.12.2019 V01

DECLARATIA DE CONFORMITATE Nr. 20210701002



MTX LED SOLUTIONS

Str. Taietura Turcului Nr. 47
400221 CLUJ-NAPOCA
ROMANIA

Prin prezenta declaram ca produsele:

Nume:	FWL
Tip:	Lampa cu LED de avertizare
Versiuni:	FWL-XA2-A-ALP, MTXLED-FWL-XA2-A-ALP FWL-XA2-C-ALP, MTXLED-FWL-XA2-C-ALP FWL-XB2-B-ALP, MTXLED-FWL-XB2-B-ALP FWL-XB2-C-ALP, MTXLED-FWL-XB2-C-ALP FWL-XR2-R-ALP, MTXLED-FWL-XR2-R-ALP FWL-XR2-C-ALP, MTXLED-FWL-XR2-C-ALP
Parametrii:	12/24VDC, SELV, IP67, P\leq 15W, CISPR clasa 5
Observatii	-

Sunt in conformitate cu prevederile urmatoarelor directive CE:

Directiva (LVD) – 2014/35/EU

Directiva (EMC) - 2014/30/EU

Directiva (RoHS) – 2015/863

Referintele la standardele si/sau specificatiile tehnice aplicabile prezentei declaratii de conformitate:

EN 55015:2013+A1:2015

EN 55025:2017

EN 61547:2009

EN 60598-1:2021

Last two digits of the year in which the CE marking was affixed: **21**

Regional Director

Liviu Oprita

Authorized signature

2021-07-01

DataSheet AWL

INTRODUCTION

The latest generation of worklights by MTX LED, a Romanian manufacturer, is ideally for working in the most demanding applications. The worklights are widely applied in ambulances, fire-fighting vehicles and police car.



The use of latest-generation high efficient LEDs enables output values between 1400 lm for the 15 W AWL lamp and 3000 lm, 25 W for high power version. The aluminum fixtures (body) guarantee adequate LED cooling, extraordinary resistance to mechanic damages, impacts or humidity. AWL lamp is waterproof and has IP67 code. This features establishes a new standard on the market of lamps intended to work in the most demanding environments. The innovative appearance and good performance give the lamp a significant competitive advantage on the market.

SPECIFICATION

	AWL-14-CW-75-AAG-x*	AWL-22-CW-75-AAG-x*	AWL-30-CW-75-AAG-x*
Compliance		R10	
Module Luminous flux	1770 lm	2800 lm	3700 lm
Lamp Luminous flux	1400 lm	2200 lm	3000 lm
LED family	PC33H07	PC33H07	JK3030
Colour Temperature		5000 K	
CRI Colour Rendering Index		80	
Supply Voltage Range		9-31 V	
Power supply type		DC	
Maximum Power	15 W	25 W	25W
Number of LEDs		24	
Ambient Temperature Range		-30°C ÷ 50°C	
Tc max.		85°C	
Dimensions		270/52.2/33.5 mm	
IP rating		IP67	
Radiator colour*	B*-Black, R*-Red, W*-White, Y- Yellow		
Cable length	300 mm		
Cable type	UL1007/UL1569 (AWG18)		
Weight	450 g		
Beam Angle	100° x 75° (v x h)		
Available Connectors**	OH-2, ATM		
Lifetime***	≥ 35000 h		

*Radiator colour

FEATURES

- High efficiency
- Reverse voltage protection
- Overheat protection
- Heavy duty construction – aluminum heatsink

DIMENSIONS

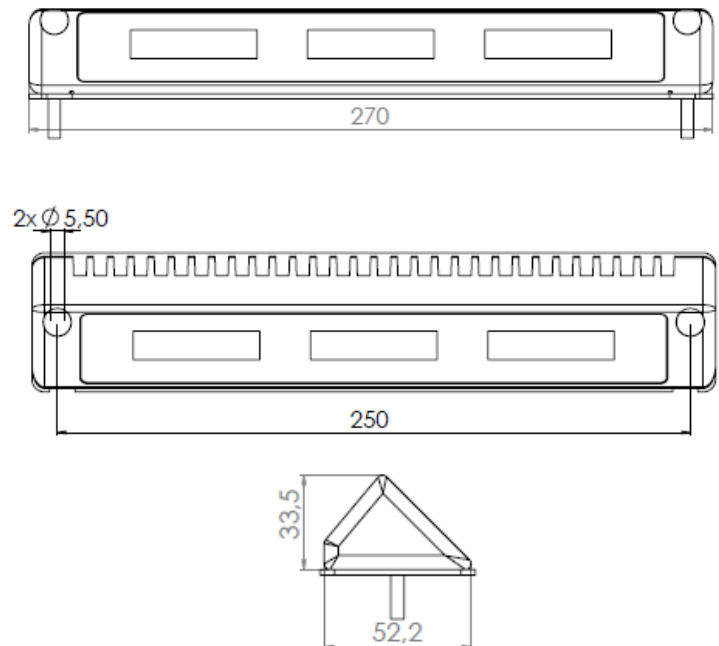

APPLICATIONS

AWL can be widely used in different types of application:

- Ambulance lights
- Fire-fighting vehicles lights
- Car police lights
- Work area lights
- Auxiliary vehicle lights

Contact:



+40 752 015 605

sales@mtxledsolutions.com

www.mtxledsolutions.com

MTX LED reserves the right to make technical changes without prior notice.

Copyright © MTX LED 24.09.2020 R01

DataSheet AWL

ACCESSORIES

AWL-ACC		
NO	Description	QTY.
1	Rubber foam pad	1
2	Plug	2
3	St.4.8x25 Screw	2

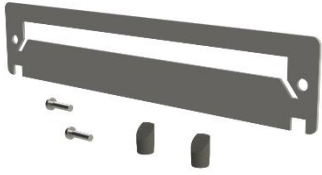

ORDERING CODE

Ordering code	Item	Description
160712.14330753	AWL-14-CW-75-AAG-B	15 W AWL Lamp, 5000 K, 75° FWHM, black
160712.14331753	AWL-14-CW-75-AAG-R	15 W AWL Lamp, 5000 K, 75° FWHM, red
160712.14332753	AWL-14-CW-75-AAG-W	15 W AWL Lamp, 5000 K, 75° FWHM, white
160721.14333753	AWL-14-CW-75-AAG-Y	15 W AWL Lamp, 5000 K, 75° FWHM, yellow
160712.143y9753*	AWL-14-yy-75-AAG-x*	15 W AWL Lamp, 75° FWHM, Custom Version*
160712.22330753	AWL-22-CW-75-AAG-B	25 W AWL Lamp, 5000 K, 75° FWHM, black
160712.22331753	AWL-22-CW-75-AAG-R	25 W AWL Lamp, 5000 K, 75° FWHM, red
160712.22332753	AWL-22-CW-75-AAG-W	25 W AWL Lamp, 5000 K, 75° FWHM, white
160712.22333753	AWL-22-CW-75-AAG-Y	25 W AWL Lamp, 5000 K, 75° FWHM, yellow
160712.30330753	AWL-30-CW-75-AAG-B	25 W AWL Lamp, 3000 lm, 5000 K, 75° FWHM, black
160712.30331753	AWL-30-CW-75-AAG-R	25 W AWL Lamp, 3000 lm, 5000 K, 75° FWHM, red
160712.30332753	AWL-30-CW-75-AAG-W	25 W AWL Lamp, 3000 lm, 5000 K, 75° FWHM, white
160712.30333753	AWL-30-CW-75-AAG-Y	25 W AWL Lamp, 3000 lm, 5000 K, 75° FWHM, yellow
160712.303y9753*	AWL-30-yy-75-AAG-x*	25 W AWL Lamp, 3000lm, 75° FWHM, Custom Version*
160712.00000003	AWL-ACC	Accessory pack

*custom version possible change CCT (correlated color temperature) (yy) and radiator colour (x)

Contact:



+40 752 015 605

sales@mtxledsolutions.com

www.mtxledsolutions.com

ZAWIADOMIENIE

COMMUNICATION



wydane przez: **DYREKTORA TRANSPORTOWEGO
DOZORU TECHNICZNEGO**
issued by: **DIRECTOR OF TRANSPORTATION
TECHNICAL SUPERVISION**
**ul. Chalubińskiego 8
00-613 WARSZAWA**

dotyczące¹:
concerning¹:

UDZIELENIA HOMOLOGACJI
APPROVAL GRANTED
ROZSZERZENIA HOMOLOGACJI
APPROVAL EXTENDED
ODMOWY HOMOLOGACJI
APPROVAL REFUSED
COFNIĘCIA HOMOLOGACJI
APPROVAL WITHDRAWN
OSTATECZNEGO ZANIECHANIA PRODUKCJI
PRODUCTION DEFINITELY DISCONTINUED



typu podzespołu elektrycznego/elektronicznego¹ w odniesieniu do Regulaminu ONZ nr 10.05
of a type of electrical/electronic¹ sub-assembly with regard to UN Regulation No. 10.05

Homologacja nr: **E20*10R05/01*004304*00**
Approval No:

1. **Marka (nazwa handlowa producenta):** **MTX LED SOLUTIONS**
Make (trade name of manufacturer):

2. **Typ i ogólny(-e) opis(-y) handlowy(-e):** **AWL**
Type and general commercial description(s):

Waarianty/Variants:

AWL-22-yy-75-AAG-x **AWL-14-yy-75-AAG-x**

Wersje/Version:

AWL-22-CW-75-AAG-B **AWL-14-CW-75-AAG-B**
AWL-22-CW-75-AAG-R **AWL-14-CW-75-AAG-R**
AWL-22-CW-75-AAG-W **AWL-14-CW-75-AAG-W**
AWL-22-yy-75-AAG-x **AWL-14-yy-75-AAG-x**

Lampa AWL jest to lampa oparta o technologię LED przeznaczona do oświetlenia roboczego terenu wokół pojazdu.

AWL lamp is based on LED light. The lamp is used to light area around the vehicle.

3. **Sposób identyfikacji typu, jeżeli oznaczono go na po-
jeździe/części/oddzielnym zespole technicznym¹:** **AWL**
Means of identification of type, if marked on the
vehicle/component/separate unit¹:

3.1. **Miejsce umieszczenia tego oznaczenia:** **Tabliczka znamionowa na korpusie**
Location of that marking: Identification plate on the body

4. **Kategoria pojazdu / Category of vehicle:** **M, N, O, L**

5. **Nazwa i adres producenta:** **MTX LED SOLUTIONS SRL**
Name and address of manufacturer: **Taietura Turcului Str. No.47 corp.A
400221 Cluj-Napoca, Romania**

6. **W przypadku części i oddzielnych zespołów technicznych – miejsce i sposób umieszczenia znaku homologacji:** **na korpusie**
 In the case of components and separate technical units, location and method of affixing of the approval mark: **on the body**
7. **Adres(-y) zakładu(-ów) montażowego(-ch):** **Principala Str. No. 52,**
 Address(es) of assembly plant(s): **407310 Gilau, Cluj Conty, Romania**
8. **Dodatkowe informacje (w stosownych przypadkach):** **Patrz dodatek poniżej**
 Additional information (where applicable): **See appendix below**
9. **Upoważniona placówka techniczna odpowiedzialna za wykonanie badań:** **Przemysłowy Instytut Motoryzacji,**
 Technical Service responsible for carrying out the tests: **03-301 Warszawa, ul. Jagiellońska 55**
Automotive Industry Institute,
03-301 Warsaw, 55 Jagiellonska str., Poland
10. **Data sprawozdania z badań:** **16.04.2018**
 Date of test report:
11. **Numer sprawozdani badań:** **BLE.040.18H**
 No. of test report:
12. **Uwagi (jeżeli są): zob. dodatek:** **bez uwag**
 Remarks (if any): See appendix: **without remarks**
13. **Miejscowość:** **Warszawa**
 Place: **Warsaw**
14. **Data:** **20 sierpnia 2018 r.**
 Date: **20th of August 2018**
15. **Podpis:** **DYREKTOR**
 Signature: **z up.**
Małgorzata Możdziej - Zarzyka
Zastępca Dyrektora
16. **Wykaz dokumentów pakietu informacyjnego przechowywanego przez organ udzielający homologacji, który może być udostępniany na wniosek:**
 The index to the information package lodged with the Approval Authority, which may be obtained on request, is attached:
- **Dokument informacyjny nr** **MTX LED SOLUTIONS/R10/AWL/1**
 The information document No
 - **Sprawozdanie z badań nr** **BLE.040.18H**
 Test report No
17. **Powód rozszerzenia:** **Nie dotyczy**
 Reasons for extension: **Not applicable**



¹ Nieporzebne skreślić / Strike out what does not apply

**Dodatek do zawiadomienia o udzieleniu homologacji nr E20*10R05/01*004304*00
dotyczącego homologacji typu podzespołu elektrycznego/ elektronicznego¹
zgodnie z Regulaminem nr 10**

Appendix to type approval communication form No. E20*10R05/01*004304*00
concerning the type approval of an ~~electrical~~/ electronic¹ sub-assembly
with regard to UN Regulation No. 10

- | | |
|---|---|
| 1. Dodatkowe informacje:
Additional information: | -- |
| 1.1. Znamionowe napięcie systemu elektrycznego:
Electrical system rated voltage: | 12 V lub 24V, plus-/ minus¹ na masę
12 V or 24V , pos / neg. ¹ ground |
| 1.2. Ten PZE może być stosowany we wszystkich typach pojazdów , z zastrzeżeniem następujących ograniczeń:
This ESA can be used on any vehicle type with the following restrictions: | pojazdy kategorii M, N, O, L ;
bez ograniczeń

category of vehicle: M, N, O, L ;
without restrictions |
| 1.2.1. Warunki instalowania, jeśli są:
Installation conditions, if any: | zgodnie z instrukcją montażu
according to the mounting instruction |
| 1.3. Ten PZE może być stosowany wyłącznie w następujących typach pojazdów:
This ESA can be used only on the following vehicle types: | nie dotyczy

not applicable |
| 1.3.1. Warunki instalowania, jeśli są:
Installation conditions, if any: | nie dotyczy
not applicable |
| 1.4. Wykorzystana(-e) metoda(-y) badawcza(-e) oraz badane zakresy częstotliwości w celu określenia odporności: (należy wskazać metodę określoną w załączniku 9):
The specific test method(s) used and the frequency ranges covered to determine immunity were:
(Please specify precise method used from Annex 9): | punkt 1.2.1 b)
dla zakresu częstotliwości
20 ÷ 2 000 MHz

paragraph 1.2.1 b)
for frequency range
20 ÷ 2 000 MHz |
| 1.5. Laboratorium akredytowane zgodnie z normą ISO 17025, uznane przez organ udzielający homologacji, odpowiedzialne za przeprowadzenie badań:
Laboratory accredited to ISO 17025 and recognized by the Approval Authority responsible for carrying out the test: | Przemysłowy Instytut Motoryzacji ,
03-301 Warszawa, ul. Jagiellońska 55,

Automotive Industry Institute,,
03-301 Warsaw, 55 Jagiellonska str.,
Poland, |
| 2. Uwagi:
Remarks: | bez uwag
without remarks |



¹ Nieporzebne skreślić / Strike out what does not apply

DECLARATIA DE CONFORMITATE NR. 20180430094



MTX LED SOLUTIONS

Str. Taietura Turcului Nr. 47
400221 CLUJ-NAPOCA
ROMANIA

Prin prezenta declarăm ca produsele:

Nume: **AWL**
Tip: **Lumina de lucru**
Versiuni: **AWL-14-CW-75-AAG-x**
AWL-22-CW-75-AAG-x
AWL-YY-ZZ-75-AAG-xw
Parametrii: **12/24VDC, SELV, IP67, P ≤ 25W**
Observatii: **x- culoare radiator**
yy- multiplu x 100 a intensitatii Luminoase
zz-versiune culoare lumina
w – alte particularizari

Sunt in conformitate cu prevederile urmatoarelor directive CE:

Directiva (LVD) – 2014/35/EU

Directiva (EMC) - 2014/30/EU

Directiva (RoHS) - 2011/65/EU

Referintele spre standardele si/sau specificatiile tehnice aplicabile acestei declaratii de conformitate:

EN 55015:2013+A1:2015

EN 61547:2009

EN 60598-1:2015

Ultimele 2 cifre ale anului in care a fost aplicat marcajul CE: **18**

Director de zona

Liviu Oprita

Semnatura autorizata

2018-04-30

