



ENDOSCOPY
LAPAROSCOPY



Laparoskopie | Laparoscopie
Laparoscopy | *Laparoscopia*
Laparoscopia

Katalog
Catalogue
Catalogue
Catálogo
Catalogo

No. **207**

Kataloge | Catalogues
 Catalogues | Catálogos
 Cataloghi

SURGERY



Hauptkatalog Chirurgie
 Main catalogue surgery
 Catalogue général
 Catálogo general
 Catalogo generale

No. 111



Plastische Chirurgie
 Plastic surgery
 Chirurgie plastique
 Cirugía plástica
 Chirurgia plastica

No. 112



Ophthalmologie
 Ophthalmology
 Ophtalmologie
 Oftalmología
 Oftalmologia

No. 113



Traumatologie
 Traumatology
 Traumatologie
 Traumatología
 Traumatologia

No. 114



Gefäßchirurgie
 Vascular surgery
 Chirurgie vasculaire
 Cirugía vascular
 Chirurgia vascolare

No. 115



Retraktor Systeme
 Retractor systems
 Systèmes des écarteurs
 Sistema de retractores
 Sistemi di retrattori

No. 133



Aneurysmen Clips
 Aneurysm clips
 Clips pour anévrismes
 Clips para aneurismas
 Clips per aneurismi

No. 134



HNO Hauptkatalog
 ENT main catalogue
 ORL catalogue général
 ORL catálogo general
 ORL catalogo generale

No. 501

CONTAINER



Container I
 Container I
 Contenaires I
 Contenedores I
 Container I

No. 302



Container II
 Container II
 Contenaires II
 Contenedores II
 Container II

No. 303

OR LIGHTS

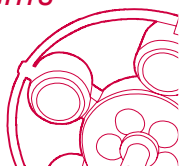

ATRIA 1
 ATRIA 1
 ATRIA 1
 ATRIA 1
 ATRIA 1

No. 701



ATRIA 2
 ATRIA 2
 ATRIA 2
 ATRIA 2
 ATRIA 2

No. 702



ATRIA 3
 ATRIA 3
 ATRIA 3
 ATRIA 3
 ATRIA 3

No. 703



ATRIA 5
 ATRIA 5
 ATRIA 5
 ATRIA 5
 ATRIA 5

No. 704

Kataloge
Catalogues
Catálogos
Cataloghi

ENDOSCOPY



Geräte
Units
Appareils
Equipos
Apparecchi

No. 205



Optiken
Scopes
Optiques
Ópticas
Ottiche

No. 206



Laparoskopie
Laparoscopy
Laparoscopia
Laparoscopia

No. 207



Urologie
Urology
Urologie
Urología
Urologia

No. 208



Gynäkologie
Gynaecology
Gynécologie
Ginecología
Ginecologia

No. 209



Arthroskopie
Arthroscopy
Arthroscopia
Artroscopia

No. 210



Sinuskopie
Sinuscopy
Sinuscopia
Sinuscopia

No. 211

ELECTRO SURGERY

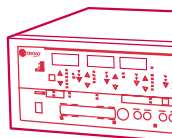

Elektro Chirurgie
Electro surgery
Électrochirurgie
Electro-Cirurgia
Elettrobisturi

No. 212

DENTAL



Dental
Dental
Dentaire
Dental
Dentale

No. 402

OR TABLES

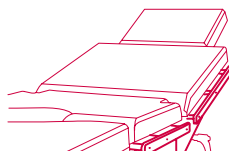

VECTOR 1
VECTOR 1
VECTOR 1
VECTOR 1
VECTOR 1

No. 601



VECTOR 3
VECTOR 3
VECTOR 3
VECTOR 3
VECTOR 3

No. 602



VECTOR 5
VECTOR 5
VECTOR 5
VECTOR 5
VECTOR 5

No. 603



VECTOR 9
VECTOR 9
VECTOR 9
VECTOR 9
VECTOR 9









No. 604







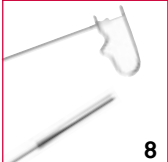

Zubehör
Accessories
Accessoires
Accesorios
Accessori

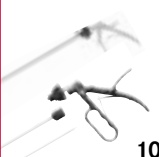
No. 610

Inhalt Content	Contenu Indice Indice
-------------------	-----------------------------

	Laparoskope <i>Laparoscopes</i> Laparoscopes <i>Laparoscopios</i> Laparoscopi	8
	Trokare <i>Trocars</i> Trocarts <i>Trócares</i> Trocar	12
	Zusatzinstrumente und Insufflationskanülen <i>Additional instruments and insufflation needles</i> Instruments additionnels et aiguilles d'insufflation <i>Instrumentos adicionales y agujas de insuflación</i> Strumenti addizionali e aghi d'insufflazione	25
	Saug- und Spülkanülen <i>Suction and irrigation cannulas</i> Canules d'irrigation et aspiration <i>Cánulas de irrigación y aspiración</i> Cannule per aspirazione ed irrigazione	27
	Saug- und Spülsysteme / Monopolare Elektroden <i>Suction and irrigation system / Monopolar electrodes</i> Système d'aspiration et irrigation / Electrodes monopolaires <i>Sistema de aspiración y irrigación / Electrodos monopoloares</i> Sistema aspirazione ed irrigazione / Elettrodi monopolari	30
	Tekno Line Instrumente <i>Tekno Line instruments</i> Instruments Tekno line <i>Instrumentos Tekno line</i> Strumenti Tekno line	35
	Bipolare Instrumente <i>Bipolar instruments</i> Instruments bipolaires <i>Instrumentos bipolares</i> Strumenti bipolari	65
	Knotenschieber & Fasszangen <i>Knotguides & Grasping forceps</i> <i>Pousse-noeuds & Pincas á saisir</i> Guía de ligaduras & <i>Pinzas de baarre</i> <i>Spingi-nodi & Pinze da presa</i>	72
	Nahtinstrumente & Nadelhalter <i>Closure instruments & Needle holders</i> Instruments de suture & Porte-aiguilles <i>Instrumentos de sutura & Porta-agujas</i> Strumenti per la sutura & Port'aghi	73

 <p>10</p>	<p>Clip Anlegezangen <i>Clip application forceps</i> Pincas para clips <i>Pinzas para clips</i> Pinze per mettere clips</p>	<p>79</p>
 <p>11</p>	<p>Endoretractoren <i>Endo-retractors</i> Endo-retracteurs <i>Endo-retractores</i> Endo-retrattori</p>	<p>81</p>
 <p>12</p>	<p>Monopolare Elektroden <i>Monopolar electrodes</i> Électrodes monopolaires <i>Electrodes monopolares</i> Elettrodi monopolari</p>	<p>84</p>
 <p>13</p>	<p>Bipolare Koagulationselektroden <i>Bipolar coagulation electrodes</i> Electrodes à coagulation bipolaire <i>Electrodos para la coagulación bipolar</i> Elettrodi per coagulazione bipolare</p>	<p>87</p>
 <p>14</p>	<p>Ring Applikatoren, Uterusmanipulator & Instrumente <i>Ring applicators, Uterus manipulator & Instruments</i> Applicateurs des anneaux, Manipulator utérin & Instruments <i>Aplicadores de anillos, Manipulador uterino & Instrumentos</i> Applicatore per anelli, Manipolatore uterino & Strumenti</p>	<p>89</p>
 <p>15</p>	<p>Reinigungs- und Sterilisationszubehör <i>Cleaning and sterilizing accessories</i> Accessoires pour nettoyage et stérilisation <i>Accesorios para limpieza y esterilización</i> Accessori per pulizia e sterilizzazione</p>	<p>92</p>
 <p>16</p>	<p>Ersatzteile, Pflegemittel <i>Spare parts, detergent for instruments</i> Pièces de réchange, détergents <i>Piezas de recambio, detergentes</i> Pezzi di ricambio, detergenti</p>	<p>94</p>
<p>tk 775-40 tk 704-360 17</p>	<p>Nummernverzeichnis <i>Numerical index</i> Index numérique <i>Indice numerico</i> Indice dei numeri d'articolo</p>	<p>96</p>

Hochauflösende Endoskope *High definition endoscopes*

Endoscopes de haute définition
Endoscopios de alta definición
Endoscopi ad alta definizione

Unsere Endoskope zeichnen sich durch ein speziell berechnetes Linsensystem aus, welches optimal auf die in HD und 4K Kameras verwendeten Sensor Formate abgestimmt ist. Diese Optimierung überzeugt im Einsatz durch ein brillantes, klares Bild. Unsere neue Optiken-Linie "ULTRA-SHARP" besteht darüber hinaus durch eine außergewöhnliche Schärfe im Randbereich des Bildes.

Our endoscopes stand out for their especially designed lens system, which is optimized for the sensor formats, used in HD and 4K cameras. This improvement convinces during use by a brilliant clear image. Our optics line "ULTRA SHARP" also impresses with its extraordinary sharpness at the edge of the image.

Nos endoscopes se distinguent par leur système de lentilles, spécialement évalué et optimisé pour des formats des capteurs des caméras HD et 4K. Cette amélioration convainc pendant l'utilisation par un image brillante et clair. Notre ligne optique «ULTRA SHARP» impressionne également par son extraordinaire netteté au bord de l'image.

Nuestros endoscopios se caracterizan por su sistema de lentes, especialmente evaluado y optimado para los formatos de los sensores en las cámaras HD y 4K. Este ameliación convence durante la utilización por un imagen brillante y claro. Nuestra línea óptica "ULTRA SHARP" también impresiona por su extraordinaria nitidez en el borde de la imagen.

I nostri endoscopi si caratterizzano per il loro sistema di lenti, che è ottimizzato per il formato del sensore utilizzato nelle telecamere HD e 4K. I miglioramenti permettono di ottenere durante l'utilizzo un'immagine nitida e chiara. La nostra linea ottica "ULTRA SHARP" impressiona anche per la sua straordinaria definizione ai bordi dell'immagine.

Kompatibilität *Compatibility*

Compatibilité
Compatibilidad
Compatibilità

Tekno
Storz
Olympus

Wolf

ACMI

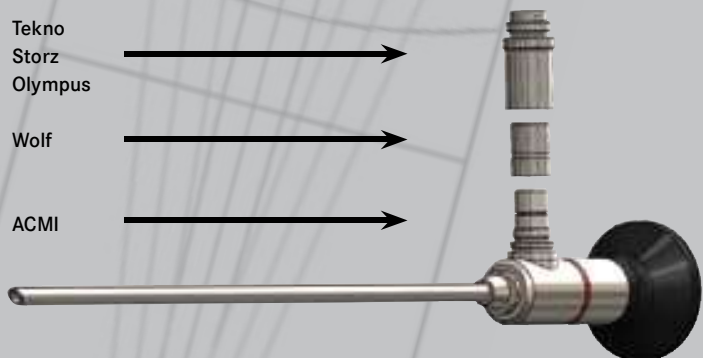

Spezielle Eigenschaften

Aufgrund unserer langjährigen Erfahrung erfüllen unsere Optiken alle Voraussetzungen für ein qualitativ hochwertiges Produkt:

- **Kompakt-Objektive**
Die in unseren Endoskopen verwendete neue Generation von Kompakt-Objektiven bietet die Gewähr für volle Autoklavierbarkeit, auch über einen langen Zeitraum hinweg und gibt damit dem Anwender die Sicherheit für eine lange Lebensdauer des Produktes.
- **Stablinsen-System**
Neuberechnete Stablinsen-Systeme garantieren eine nicht zu übertreffende Bildhelligkeit
- **Großbildoptik**
Eine hohe Vergrößerung garantiert dem Anwender ein angenehmes Arbeiten, auch wenn sich der Monitor nicht direkt am Operationsfeld befindet
- **Distal und proximal Saphirgläser**
- **Anwendungsbezogene Blickwinkel bei allen Optiken**
- **Exzellente Brillanz und Auflösung**
- **Natürliche Farbwiedergabe bei gleichmäßiger Bildschärfe**
- **Optimale Tiefenschärfe, ebenfalls ausgerichtet an den Erfordernissen des Einsatzgebietes**

Qualités particulières

A cause de notre longue expérience, nos optiques répondent à toutes exigences pour des produits de haute gamme

- **objectif compact**
la nouvelle génération des objectifs utilisés dans nos endoscopes garantie que les produits peuvent être autoclavés, même pendant une très longue période, et donne à l'utilisateur la sécurité pour une longue vie du produit.
- **système des lentilles en tiges**
ce système, nouvellement évalué, garantit la meilleure clarté de l'image
- **grandeur de l'image**
le grossissement le plus grand possible garantit un travail agréable pour l'utilisateur, surtout quand l'écran ne se trouve pas à côté de l'opérateur.
- **différents angles, selon les besoins du travail**
- **illumination brillante et très haute résolution**
- **reproduction des couleurs naturelles en netteté constante de l'image**
- **profondeur de champ optimale, selon les nécessités de l'opération**



Kompakt-Objektiv
Compact objective

Objectif compact
Objetivos compactos
Obiettivi compatti

Particular attributes

Due to our long experience, our scopes meet all technical requirements of a first class product:

- *compact objectives*
the new generation of compact objectives used in our endoscopes provides the guarantee of full autoclavability even for a long period and gives the user the security of a long life of the product.
- *rod lens system*
the new evaluated rod lens systems guarantees an illumination which really is second to none
- *large image size*
a high enlargement guarantees a comfortable working, even if the monitor is not so close to the operation field
- *distal and proximal saphire windows*
- *comfortable direction of view on all scopes according to the necessity of the operation*
- *brilliant illumination and crystal clear resolution*
- *true colour reflection and regular focus on the whole image*
- *optimal depth of field, also according to the necessity of the operation*

Características particulares

En base a nuestra larga eperiencia, nuestras ópticas satisfacen todas las normas de los productos de alta calidad.

- *objetivos compactos*
la nueva generación de objetivos, incorporados en nuestras ópticas, ofrece la garantía de esterilización por autoclave durante un largo periodo de tiempo y da de durabilidad al producto.
- *sistema de lentes a varillas*
este nuevo sistema garantiza la mejor luminosidad de la imagen.
- *dimensión de la imagen*
el aumento de la dimensión da la imagen, garantiza un trabajo agradable, aunque el monitor está posicionado lejos de la mesa.
- *diferentes ángulos visuales según las necesidades de trabajo*
- *iluminación brillante y una resolución muy alta*
- *reproducción de los colores naturales a una nitidez constante de la imagen*
- *profundidad del campo según las necesidades de trabajo*

Caratteristiche particolari

Grazie alla nostra lunga esperienza, i nostri endoscopi presentano tutte le caratteristiche dei prodotti di alto livello:

- **obiettivi compatti:** la nuova generazione di obiettivi compatti usata nei nostri endoscopi garantisce la totale autoclavabilità anche per un lungo periodo e da all'utilizzatore la certezza di una lunga durata del prodotto
- **sistema rod lens:** la nuova generazione del sistema di rod lens assicura una illuminazione che non è seconda a nessun altro prodotto
- **immagine di grandi dimensioni:** un elevato fattore di ingrandimento permette un lavoro confortabile, anche se il monitor non è vicino all'operatore
- **lenti prossimali e distali in zaffiro**
- **angolo di visione perfetto, specifico per ogni campo di utilizzo**
- **illuminazione brillante e risoluzione cristallina**
- **trasmissione dei colori reale, e immagine perfettamente a fuoco su tutto il campo**
- **profondità di campo ottimale, studiata per le necessità dei diversi campi di utilizzo**

Laparoskope | Laparoscopes
 Laparoscopes | Laparoscopios
 Laparoscopi

autoklavierbar / autoclavable
 134°C / 273°F - 18 min.

1

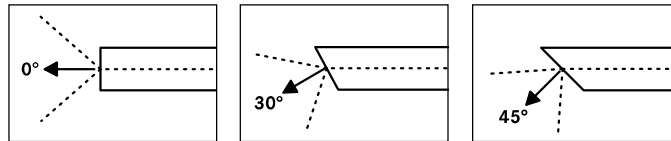

Ø 5.0 mm - 240 mm	tk 700-001	tk 700-011	-
Ø 5.0 mm - 300 mm	tk 700-000	tk 700-003	tk 700-004
Ø 5.0 mm - 360 mm	tk 700-002	tk 700-012	-
Ø 10.0 mm - 310 mm	tk 700-020	tk 700-023	tk 700-024
Ø 10.0 mm - 450 mm	tk 700-420	tk 700-423	tk 700-424
Ø 10.0 mm - 540 mm	tk 700-430	tk 700-433	-

FULL SCREEN

Ø 5.5 mm - 310 mm	tk 700-450	tk 700-453	-
-------------------	------------	------------	---



ULTRA SHARP

Ø 5.5 mm - 300 mm	tk 700-300	tk 700-301	tk 700-302
Ø 10.0 mm - 330 mm	tk 700-028	tk 700-029	-
Ø 10.0 mm - 450 mm	tk 700-310	tk 700-311	tk 700-312

Ø, Arbeitslänge
 Ø, Working length
 Ø, Longueur de travail
 Ø, Longitud de trabajo
 Ø, Lunghezza operativa

Mini-Laparoskope
Mini laparoscopes

Mini laparoscopes
Mini laparoscopios
Mini laparoscopi

autoklavierbar / autoclavable
134°C / 273°F - 18 min.

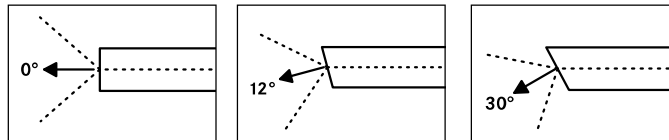
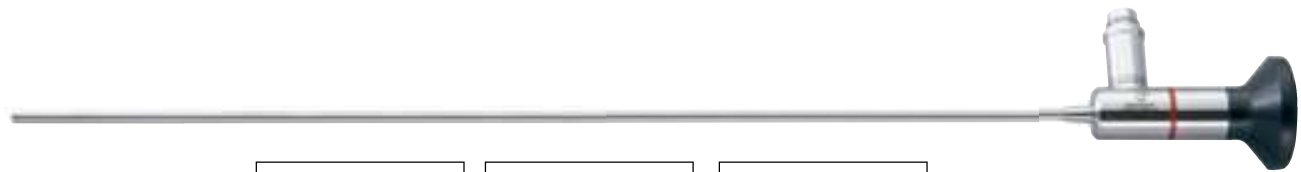

Ø 2.7 mm - 270 mm	tk 700-275	-	tk 700-276
Ø 3.0 mm - 300 mm	tk 700-204	tk 700-205	tk 700-203
Ø 4.0 mm - 200 mm	tk 700-030	-	tk 700-033
Ø 2.7 mm - 270 mm	tk 700-275SF	-	tk 700-276SF

Ø, Arbeitslänge
Ø, Working length
Ø, Longueur de travail
Ø, Longitud de trabajo
Ø, Lunghezza operativa

SF = Tekno-Flex

OP - Laparoscope
OP - Laparoscopes

OP - Laparoscopes
OP - Laparoscopios
Laparoscopi operativi

OP - Laparoskop mit integriertem Instrumentenkanal, 0° Weitwinkel, Paralleleinblick
OP - Laparoscope with integrated instrument channel, 0° wide angle, parallel view
 OP - Laparoscope avec canal d'instruments incorporé, 0° grand angle, vision parallèle
OP - Laparoscopio con canal incorporado para instrumentos, 0° gran ángulo, vista paralela
 Laparoscopio operativo con canale di lavoro, 0° grandangolo, oculare parallela

autoklavierbar / autoclavable
 134°C / 273°F 18 min.

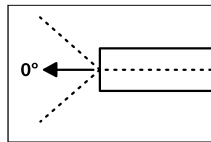
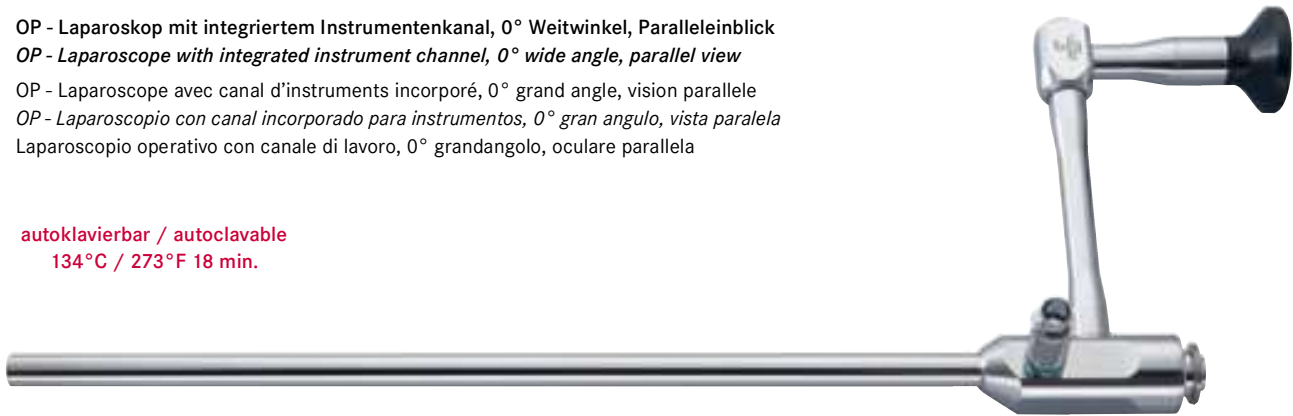

Ø 10.0 mm – 268 mm	Ø 6.0 mm	tk 700-250
Ø, Arbeitslänge Ø, Working length	Instrumentenkanal Instrument channel	inkl. Adapter incl. adapter
Ø, Longueur de travail Ø, Longitud de trabajo	Canal d'instrument Canal para instrumentos	incl. adaptateur adaptador incluido
Ø, Lunghezza operativa	Canale operativo	adattore incluso

tk 700-255

Adapter
 Adapter
 Adaptateur
 Adaptador
 Adattore

OP - Laparoskop mit integriertem Instrumentenkanal, 0° Weitwinkel, Lateraleinblick
OP - Laparoscope with integrated instrument channel, 0° wide angle, lateral view
 OP - Laparoscope avec canal d'instruments incorporé, 0° grand angle, vision latéral
OP - Laparoscopio con canal incorporado para instrumentos, 0° gran ángulo, vista lateral
 Laparoscopio operativo con canale di lavoro, 0° grandangolo, oculare angolato

autoklavierbar / autoclavable
 134°C / 273°F

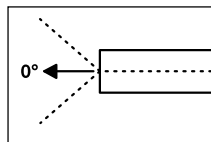
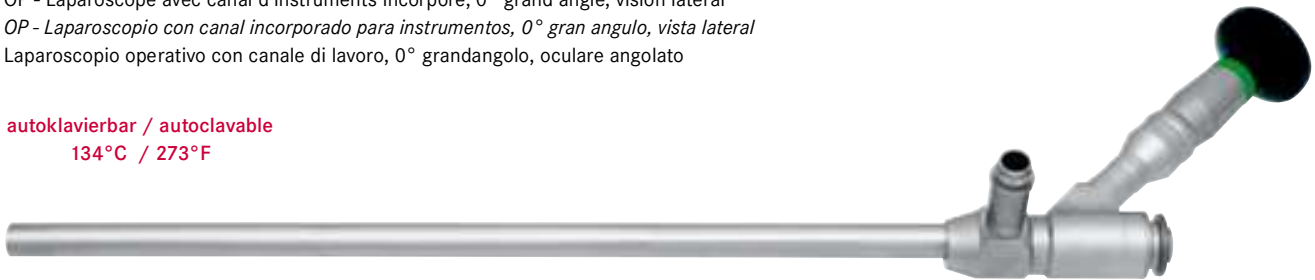

Ø 10.0 mm – 268 mm	Ø 6.0 mm	tk 700-251
Ø, Arbeitslänge Ø, Working length	Instrumentenkanal Instrument channel	inkl. Adapter incl. adapter
Ø, Longueur de travail Ø, Longitud de trabajo	Canal d'instrument Canal para instrumentos	incl. adaptateur adaptador incluido
Ø, Lunghezza operativa	Canale operativo	adattore incluso

tk 700-256

Adapter
 Adapter
 Adaptateur
 Adaptador
 Adattore

Haltearm für Optiken
Holding arm for scopes

Support pour endoscopes
Soporte para endoscopios
Supporto per endoscopi



tk 700-990

Haltearm für Optiken (Ø 5 + 10mm)
Holding arm for scopes (Ø 5 + 10mm)

Support pour endoscopes (Ø 5 + 10mm)
Soporte para endoscopios (Ø 5 + 10mm)
Supporto per endoscopi (Ø 5 + 10mm)

Trokare Trocars

Trocarts
Trócares
Trocar

LIGHTWEIGHT-LINE

LIGHTWEIGHT LW

- Ultra-leichtgewichtig durch Kunststoff-Grundkörper
- Wiederverwendbare Silikondichtung
- Erhältlich in: \varnothing 5,5mm und \varnothing 11,0mm
- *Ultra lightweight plastic body*
- *Reusable silicone valve*
- *Available in: \varnothing 5.5mm and \varnothing 11.0mm*
- Tête ultra-légère en matière plastique
- Valve en silicone, réutilisable
- Disponible en: \varnothing 5,5mm et \varnothing 11,0mm
- *Cuerpo ultraligero de plastica*
- *Valvula de silicona, reutilizable*
- *Disponibile en: \varnothing 5,5mm y \varnothing 11,0mm*
- Molto leggera grazie al corpo di plastica
- Valvola di silicone riutilizzabile
- Fornibile nelle grandezze: \varnothing 5,5mm e \varnothing 11,0mm

LW

SLIM-LINE

SLIM SL

- Bis zu 25% Gewichtersparnis gegenüber der Classic-Line
- Farbkennzeichnung an Schaft und Grundkörper
- Erhältlich in: \varnothing 5,5mm und \varnothing 11,0mm und \varnothing 13,0mm
- *Up to 25% saving on weight compared with Classic-Line*
- *Colour coding at sheath and body*
- *Available in: \varnothing 5.5mm, \varnothing 11.0mm and \varnothing 13.0mm*
- Jusqu'à 25% de réduction de poids par rapport à la CLASSIC-LINE
- Codage par couleurs sur le tube et le corps
- Disponible en : \varnothing 5,5 mm, \varnothing 11,0 mm et \varnothing 13,0 mm
- *Hasta un 25% de reducción de peso en comparación con la CLASSIC-LINE*
- *Codificación de colores en el tubo y en el cuerpo*
- *Disponibile en: \varnothing 5,5mm, \varnothing 11,0mm y \varnothing 13,0mm*
- Riduzione del peso fino al 25% rispetto a CLASSIC-LINE
- Codificazione a colori su tubo e corpo
- Disponibile in: \varnothing 5,5 mm, \varnothing 11,0 mm e \varnothing 13,0 mm

SL

CLASSIC-LINE

CLASSIC CL

- Leichte Handhabung
- Jahrzehnte bewährtes Standard-Modell
- Erhältlich in: \varnothing 3,5mm, \varnothing 5,5mm, \varnothing 7,0mm, \varnothing 11,0mm, \varnothing 15,0mm und \varnothing 20,0mm
- *Easy handling*
- *Since decades proven standard model*
- *Available in: \varnothing 3.5mm, \varnothing 5.5mm, \varnothing 7.0mm, \varnothing 11.0mm, \varnothing 15.0mm and \varnothing 20.0mm*
- Manipulation facile
- Modèle standard éprouvé depuis décennies
- Disponible en : \varnothing 3,5 mm, \varnothing 5,5 mm, \varnothing 7,0 mm, \varnothing 11,0 mm, \varnothing 15,0 mm et \varnothing 20,0 mm
- *Fácil manejo*
- *Modelo estándar probado desde décadas*
- *Disponibile en: \varnothing 3.5mm, \varnothing 5.5mm, \varnothing 7.0mm, \varnothing 11.0mm, \varnothing 15.0mm y \varnothing 20.0mm*
- Semplice manipolazione
- Modello standard provato da decenni
- Disponibile in: \varnothing 3.5mm, \varnothing 5.5mm, \varnothing 7.0mm, \varnothing 11.0mm, \varnothing 15.0mm e \varnothing 20.0mm

CL



Trokare | Trocars
Trocars | Trócares
 Trocar

Trokarhülse, allein
Trocar sleeve, only
 Gaine de trocart, seule
Vaina de trocar, sola
 Camicia, sola



	x = 60 mm	x = 100 mm
Ø 2.9 mm	tk 730-170	tk 730-160

Metallrohr, glatt
Metal tube, smooth
 Tube metalique, lisse
Tubo de metal, lisa
 Tubo metallico, liscio

Metallrohr, glatt
Metal tube, smooth
 Tube metalique, lisse
Tubo de metal, lisa
 Tubo metallico, liscio

Trokare | Trocarts
Trocars | Trócares
Trocar

Leichtgewicht Trokarhülse mit Valve und Hahn
Lightweight trocar sheath with valve and stopcock

Gaine de trocart légères avec valve en silicone et robinet

Vaina de trocar ligeros con valvula y robinete

Camicia leggera con valvola e rubinetto

2



LIGHTWEIGHT LW

Ø 5.5 mm	x = 95 mm	tk 704-687	tk 704-688
Ø 11.0 mm	x = 105 mm	tk 704-691	tk 704-692

Metallrohr, glatt
Metal tube, smooth
Tube metalique, lisse
Tubo de metal, lisa
Tubo metallico, liscio

Metallrohr mit Gewinde
Metal tube, threaded
Tube metallique avec filetage
Tubo de metal con rosco
Tubo metallico con filetto



LIGHTWEIGHT LW

Ø 5.5 mm	x = 95 mm	tk 704-689	tk 704-690
Ø 11.0 mm	x = 101 mm	tk 704-693	tk 704-694

Kunststoffrohr, glatt
Plastic tube, smooth
Tube plastique, lisse
Tubo plastico, lisa
Tubo di plastica, liscia

Kunststoffrohr mit Gewinde
Plastic tube, threaded
Tube plastique avec filetage
Tubo de plastico con rosca
Tubo di plastica con filetto

Trokare | Trocarts
Trocars | Trócares
Trocar

Trokarhülse mit Automatik-Ventil, manueller Klappenöffnung und Hahn
Trocar sheath with multifunctional valve and stopcock

Gaine de trocar avec valve automatique, ouverture manuelle et robinet
Vaina de trócar con valvula automatica, apertura manual y robinete
Camicia con valvola automatica con leva apriporta e rubinetto

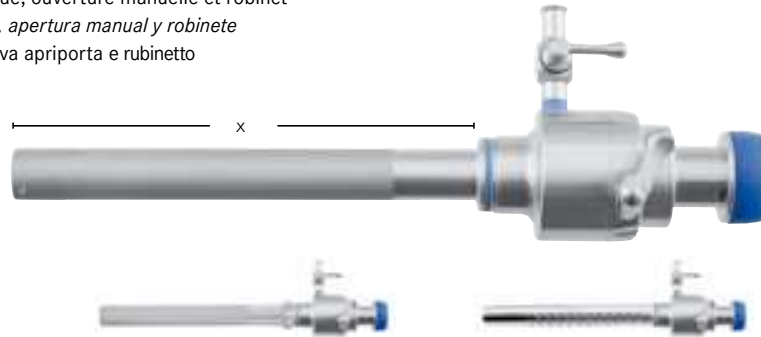

SLIM SL

Ø 5.5 mm	○	x = 103 mm	tk 704-360	tk 704-670
Ø 11.0 mm	●	x = 105 mm	tk 704-365	tk 704-673
Ø 13.0 mm	●	x = 102 mm	tk 704-295	tk 704-676

Metallrohr, glatt
Metal tube, smooth
Tube metalique, lisse
Tubo de metal, lisa
Tubo metallico, liscio

Metallrohr mit Gewinde
Metal tube, threaded
Tube metalique avec filetage
Tubo de metal con rosco
Tubo metallico con filetto

SLIM SL

Ø 5.5 mm	○	x = 95 mm	tk 704-671	tk 704-672
Ø 11.0 mm	●	x = 97 mm	tk 704-674	tk 704-675
Ø 13.0 mm	●	x = 94 mm	tk 704-677	tk 704-678

Kunststoffrohr, glatt
Plastic tube, smooth
Tube plastique, lisse
Tubo plastico, lisa
Tubo di plastica, liscia

Kunststoffrohr mit Gewinde
Plastic tube, threaded
Tube plastique avec filetage
Tubo de plastico con rosca
Tubo di plastica con filetto

SLIM SL-XL

Ø 5.5 mm	○	x = 150 mm	tk 704-4002-15
Ø 11.0 mm	●	x = 150 mm	tk 704-4010-15
Ø 13.0 mm	●	x = 150 mm	tk 704-4012-15

Metallrohr, glatt
Metal tube, smooth
Tube metalique, lisse
Tubo de metal, lisa
Tubo metallico, liscio

Trokare | Trocars
Trocars | *Trócares*
 Trocar

High Flow Trokarhülse mit Automatik-Ventil, manueller Klappenöffnung und Hahn
High Flow trocar sheath with multifunctional valve and stopcock

High Flow gaine de trocar avec valve automatique, ouverture manuelle et robinet
High Flow vaina de trócar con valvula automatic, aperatura manual y robinete

High Flow camicia con valvola automatic con leva aprivalvola e rubinetto

2

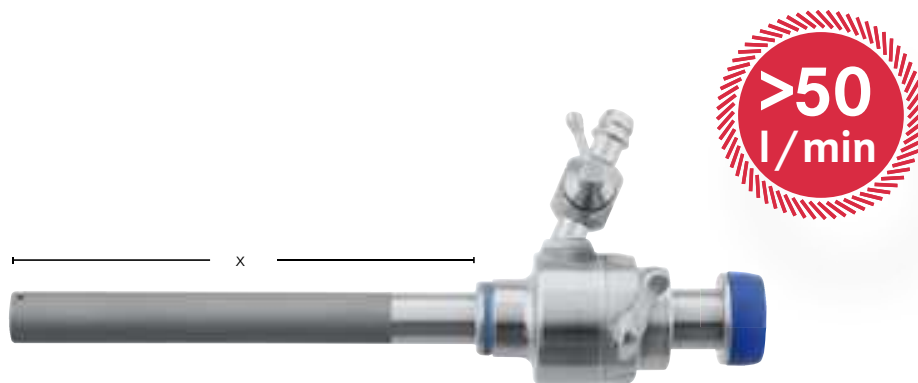

SLIM^{SL}

Ø 11.0 mm ●	x = 105 mm	tk 704-308
-------------	------------	-------------------

Metallrohr, glatt
Metal tube, smooth

Tube metalique, lisse
Tubo de metal, lisa
 Tubo metallico, liscio

Trokare | Trocarts
 Trocars | Trócares
 Trocar

Trokarhülle mit Automatik-Ventil, manueller Klappenöffnung und Hahn
Trocar sheath with multifunctional valve and stopcock

Gaine de trocart avec valve automatique, ouverture manuelle et robinet

Vaina de trócar con valvula automatica, apertura manual y robinete

Camicie con valvola automatica con leva aprivalvola e rubinetto



CLASSIC

Ø 3.5 mm	x = 70 mm	tk 730-210	-
Ø 5.5 mm	x = 95 mm	tk 704-679	tk 704-680
Ø 7.0 mm	x = 95 mm	tk 704-362	-
Ø 11.0 mm	x = 101 mm	tk 704-683	tk 704-684

Metallrohr, glatt
Metal tube, smooth
 Tube metalique, lisse
Tubo de metal, lisa
 Tubo metallico, liscio

Metallrohr mit Gewinde
Metal tube, threaded
 Tube metallique avec filetage
Tubo de metal con rosco
 Tubo metallico con filetto



CLASSIC

Ø 5.5 mm	x = 95 mm	tk 704-681	tk 704-682
Ø 11.0 mm	x = 101 mm	tk 704-685	tk 704-686

Kunststoffrohr, glatt
Plastic tube, smooth
 Tube plastique, lisse
Tubo plastico, lisa
 Tubo di plastica, liscia

Kunststoffrohr mit Gewinde
Plastic tube, threaded
 Tube plastique avec filetage
Tubo de plastico con rosca
 Tubo di plastica con filetto



Trokare | Trocarts
Trocars | *Trócares*
 Trocar

Trokarhülse mit Automatik-Ventil, manueller Klappenöffnung und Hahn
Trocar sheath with multifunctional valve and stopcock

Gaine de trocart avec valve automatique, ouverture manuelle et robinet

Vaina de trocar con valvula automatica, apertura manual y robinete

Camicia con valvola automatica con leva aprivalvola e rubinetto

2

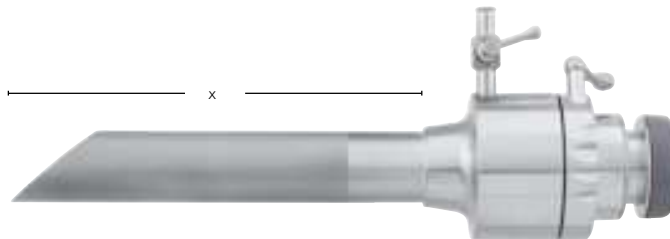

CLASSIC 

Ø 15.0 mm	x = 110 mm	tk 704-367
Ø 20.0 mm	x = 119 mm	tk 704-368

Metallrohr glatt, nicht abnehmbar
Metal tube smooth, not removable

Tube metalique lisse, non démontables

Tubo de metal lisa, no desmontables

Tubo metallico liscio, non smontabile

Trokare | Trocarts
 Trocars | Trócares
 Trocar

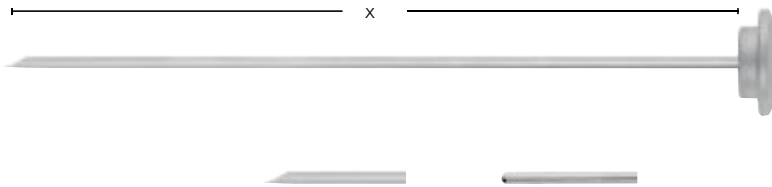

Ø 2.8 mm	x = 108 mm	x = 148 mm
	tk 730-171	tk 730-161
	tk 730-172	tk 730-162
	für tk 730-170 for tk 730-170 pour tk 730-170 para tk 730-170 per tk 730-170	für tk 730-160 for tk 730-160 pour tk 730-160 para tk 730-160 per tk 730-160



Ø 3.5 mm	CL	tk 704-070	tk 730-220	tk 704-072
Ø 5.5 mm	CL SL AW	tk 704-016	tk 704-022	tk 704-031
Ø 7.0 mm	CL	tk 704-014	tk 704-018	-
Ø 10.0 mm		-	-	tk 704-033
Ø 11.0 mm	CL SL AW	tk 704-006	tk 704-026	tk 704-035
Ø 12.5 mm		-	-	tk 704-036
Ø 13.0 mm	SL	tk 704-093	tk 704-092	-
Ø 15.0 mm	CL	tk 704-015	tk 704-028	-
Ø 20.0 mm	CL	tk 704-020	tk 704-029	-

Ø 5.5 mm	SL-XL	tk 704-016-15	tk 704-022-15	-
Ø 11.0 mm	SL-XL	tk 704-006-15	tk 704-026-15	-
Ø 13.0 mm	SL-XL	tk 704-012-15	tk 704-027-15	-

Für Trokar-System For trocar system	Trokar (dreikant) Trocar (pyramidal)	Trokar (Kegelform) Trocar (conical tip)	Trokar (stumpf) Trocar (blunt)
Pour système trocart	Trocart (pyramidal)	Trocart (conique)	Trocart (mousse)
Para el sistema de trócares	Trócar (piramidal)	Trócar (conico)	Trócar (romo)
Sistema per trocar	Trocar (piramidale)	Trocar (conico)	Trocar (smusso)

Sicherheitstrokare
Safety trocars

Trocarts de sécurité
Trócares de seguridad
Trocars di sicurezza



Ø 3.5 mm	x = 132 mm	tk 704-090
----------	------------	-------------------

Sicherheitstrokare, demontierbar
Safety trocar, detachable

Trocarts de sécurité, démontable
Trócar de seguridad, desmontable
Trocar di sicurezza, smontabile

2



Ø 5.5 mm	LW SL CL	tk 704-087	tk 704-060	tk 704-065
Ø 5.5 mm	SL-XL	-	-	tk 704-076
Ø 11.0 mm	LW SL CL	tk 704-088	tk 704-061	tk 704-067
Ø 11.0 mm	SL-XL	-	-	tk 704-077
Ø 13.0 mm	SL	tk 704-160	tk 704-161	tk 704-162
Ø 13.0 mm	SL-XL	-	-	tk 704-078

Für Trokar-System
For trocar system

Pour système trocar
Para el sistema de trócares
Sistema per trocar

Messerform
Knife shape

Forme de couteau
Forme de cuchillo
Forma a coltello

schräg
oblique

obliques
oblicuos
taglio inclinato

dreikant
pyramidal

pyramidales
piramidales
piramidale

Zubehör für Trokare
Accessories for trocars

Accessoires pour trocars
Accesorios para trócares
Accessorio per trocar



	35.0 mm
Ø 5.5 mm	tk 704-436
Ø 10.0 mm	tk 704-437
Ø 11.0 mm	tk 704-438
Ø 12.5 mm	tk 704-439
Ø 13.0 mm	tk 704-440

Ø Trokar Abstandshalter mit Fixiergewinde
 Ø Trocar Distance holder with fixation thread
 Ø Trocart Pièce de distance avec vis de fixation
 Ø Trócar Pieza de distancia con tornillo de fijación
 Ø Trocar Distanziatore con vite di fissaggio



Ø 5.5 mm	Ø 3.0 mm	tk 704-233
Ø 10.0 mm	Ø 5.5 mm	tk 704-240
Ø 11.0 mm	Ø 5.5 mm	tk 704-241
Ø 12.5 mm	Ø 5.5 mm	tk 704-242
Ø 12.5 mm	Ø 10.0 mm	tk 704-243
Ø 13.0 mm	Ø 5.5 mm	tk 704-244
Ø 13.0 mm	Ø 10.0 mm	tk 704-245

Ø Trokar Reduzieraufsatz mit Silikonhalterung
 Ø Trocar Reduction adaptors with silicon-holder
 Ø Trocart Réducteur avec support de silicone
 Ø Trócar Reductor con soporte de silicona
 Ø Trocar Riduttore con supporto in silicone



Ø 5.0 mm	Ø 4.0 mm	tk 704-200
Ø 11.0/10.0 mm	Ø 5.5 mm	tk 704-000
Ø 12.5 mm	Ø 5.5 mm	tk 704-216
Ø 15.0 mm	Ø 5.5 mm	tk 704-203
Ø 12.5 mm	Ø 10.0 mm	tk 704-217
Ø 15.0 mm	Ø 10.0 mm	tk 704-204
Ø 20.0 mm	Ø 10.0 mm	tk 704-207
Ø 20.0 mm	Ø 15.0 mm	tk 704-218

Ø Trokar Reduzierhülsen
 Ø Trocar Reduction sleeves
 Ø Trocart Gaine de réduction
 Ø Trócar Vaina para reducción
 Ø Trocar Riduttore



Zubehör für Trokare
Accessories for trocars

Accessoires pour trocars
Accesorios para trócares
Accessorio per trocar

2



Ø 3.5 mm	tk 704-395 K
Ø 5.5 mm	tk 704-397 K
Ø 10.0 mm	tk 704-398 K
Ø 11.0 mm	tk 704-399 K
Ø 12.5 mm	tk 704-389 K
Ø 13.0 mm	tk 704-390 K

Ø Trokar Hasonkonus fixierbar mit Fadenthaltern
Ø Trocar *Hasoncone fixable with suture holder*
Ø Trocart Conus de Hasson à fixer, avec porte-fils
Ø Trócar *Cono de Hasson fijable, con porta suturas*
Ø Trocar Cono di Hasson con levette porta sutura



Ø 3.5 mm	tk 704-0022	●
Ø 5.5 mm	tk 704-0023	●
Ø 10.0 mm	tk 704-0024	●
Ø 11.0 mm	tk 704-0025	●
Ø 12.5 mm	tk 704-0026	●
Ø 13.0 mm	tk 704-0027	●

Ø Trokar Dichtkappe (Farbe), Pack mit 10 Stück
Ø Trocar *Sealing cap (colour), pack of 10 pieces*
Ø Trocart Capuchon (couleur), paquet de 10 pièces
Ø Trócar *Capuchón (color), paquetes de 10 piezas*
Ø Trocar Cappuccio (colore), conf. da 10 pezzi



Ø 10.0 mm	Ø 5.5 mm	tk 704-235
Ø 11.0 mm	Ø 5.5 mm	
Ø 11.0 mm	Ø 10.0 mm	
Ø 12.5 mm	Ø 5.5 mm	
Ø 13.0 mm	Ø 5.5 mm	
Ø 12.5 mm	Ø 10.0 mm	tk 704-238
Ø 13.0 mm	Ø 10.0 mm	

Ø Trokar Schiebereduzierer verwendbar für alle TEKNO Automatiktrokarhülsen
Ø Trocar *Reduction piece for all TEKNO automatic trocars*
Ø Trocart Réducteur pour tous les trocars automatiques de TEKNO
Ø Trócar *Reductor para todos trócares automáticos de TEKNO*
Ø Trocar Riduttore per tutti trocar automatici TEKNO

Zubehör für Trokare
Accessories for trocars

Accessoires pour trocars
Accesorios para trócares
Accessorio per trocar

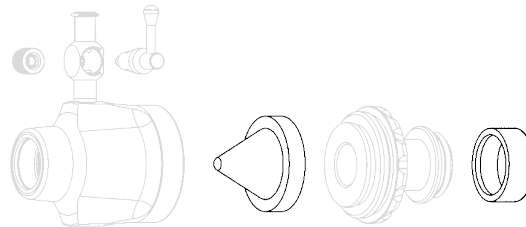

LIGHTWEIGHT LW

Packaging unit		5 Pcs.	10 Pcs.
Ø 5.5 mm	LW	tk 704-0020	tk 704-0004 ○
Ø 11.0 mm	LW	tk 704-0021	tk 704-0008 ●
Ø Trocar	Für Trokar-System	Silikonventil	Dichtkappe (Farbe)
Ø Trocar	For trocar system	Silicone valve	Sealing cap (colour)
Ø Trocart	Pour système trocart	Valve silicon	Capuchon (couleur)
Ø Trócar	Para el sistema de trócares	Valvula silicona	Capuchón (color)
Ø Trocar	Sistema per trocar	Valvola silicone	Cappuccio (colore)

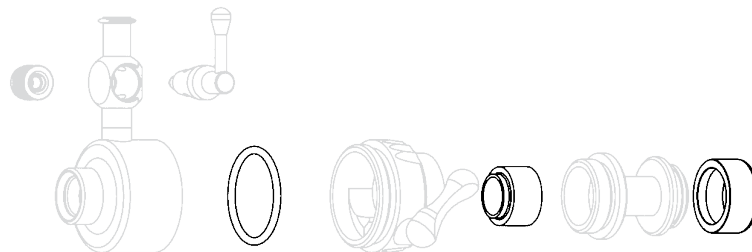

SLIM SL
CLASSIC

Packaging unit		1 Pcs.	10 Pcs.	10 Pcs.
Ø 3.5 mm	SL	tk 704-0122	tk 704-0202 ●	tk 704-0002 ●
Ø 5.5 mm	SL	tk 704-0124	tk 704-0200A ●	tk 704-0004A ●
Ø 5.5 mm	SL	tk 704-0123	tk 704-0200 ○	tk 704-0004 ○
Ø 7.0 mm	SL	tk 704-0124	tk 704-0200A ●	tk 704-0006 ●
Ø 11.0 mm	SL	tk 704-0127	tk 704-0201A ●	tk 704-0008 ●
Ø 11.0 mm	SL	tk 704-0124	tk 704-0201 ●	tk 704-0008 ●
Ø 13.0 mm	SL	tk 704-0124	tk 704-0205 ●	tk 704-0010 ●
Ø 15.0 mm	SL	tk 704-0128	tk 704-0204 ●	tk 704-0013 ●
Ø 20.0 mm	SL	tk 704-0129	tk 704-0204 ●	tk 704-0018 ●
Ø Trocar	Für Trokar-System	O-Ring	Innendichtung (Farbe)	Dichtkappe (Farbe)
Ø Trocar	For trocar system	O ring	Inner sealing (colour)	Sealing cap (colour)
Ø Trocart	Pour système trocart	Anneau O	Jointe interne (couleur)	Capuchon (couleur)
Ø Trócar	Para el sistema de trócares	Anillo O	Guarnición interna (color)	Capuchón (color)
Ø Trocar	Sistema per trocar	O Ring	Guarnizione interna (colore)	Cappuccio (colore)

Thoraxtrokare | Trocarts thoraciques
Thoracic trocars | Trócares torácicos
 Trocar per torace

2

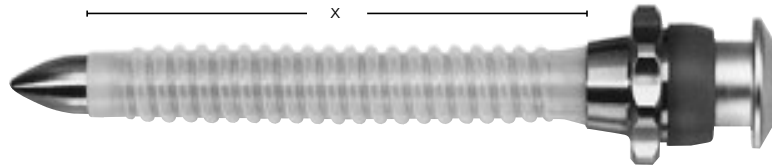

Ø 9.0 mm	Ø 6.0 mm	x = 100 mm	tk 712-440	tk 712-441	tk 712-442	tk 712-443
Ø 9.0 mm	Ø 6.0 mm	x = 70 mm	tk 712-450	tk 712-451	tk 712-452	tk 712-453
Ø 14.2 mm	Ø 11.0 mm	x = 100 mm	tk 712-460	tk 712-461	tk 712-462	tk 712-463
Ø 14.2 mm	Ø 11.0 mm	x = 70 mm	tk 712-470	tk 712-471	tk 712-472	tk 712-473

Flexible Thoraxtrokare
Flexible thoracic trocars

Trocarts thoraciques, flexibles
 Trócares torácicos, flexibles
 Trocar per torace, flessibile

Komplett mit Obturator
Complete with obturator

Complet avec obturateur
 Completo con obturador
 Completo con otturatore

Trocarhülse allein
Trocar sleeve only

Gaine seule
 Vaina sola
 Camicia sola

Obturator allein
Obturator only

Obturateur seul
 Obturador solo
 Otturatore solo

Flexible Kunststoffrohre (5 Stck)
Flexible plastic tubes (5 pcs.)

Gaines en plastique (5 pcs)
 Vainas de plastica (5 pzas)
 Tubi di plastica (5 pezzi)



Weitere Thorax-Instrumente finden Sie in unserem VATS Katalog
 More thoracic instruments can be found in our VATS catalogue

Vous trouverez plus d'instruments thoraciques dans notre VATS catalogue

Más instrumentos torácicos en nuestro catálogo VATS

Altri strumenti toracici si possono trovare nel nostro catalogo VATS

Zusatzinstrumente | Instruments additionnels
Additional instruments | Instrumentos adicionales
 Strumenti addizionali



Ø 5.0 mm	Ø 10.0 mm	tk 704-220
Ø 5.0 mm	Ø 11.0 mm	tk 704-225
Ø 5.0 mm	Ø 15.0 mm	tk 704-221
Ø 5.0 mm	Ø 20.0 mm	tk 704-222
Ø 10.0 mm	Ø 15.0 mm	tk 704-223
Ø 10.0 mm	Ø 20.0 mm	tk 704-224

Dilations - Satz von Ø auf Ø
Dilatation - Set from Ø to Ø
 Jeu des dilateurs de Ø à Ø
 Juego de dilatadores de Ø a Ø
 Dilatori-Set da Ø a Ø



	Ø 2.8 mm	Ø 5.0 mm
250 mm	tk 760-000-25	-
300 mm	-	tk 704-801
330 mm	tk 760-000	tk 704-800
400 mm	-	tk 704-803
450 mm	-	tk 704-802

Taststab, graduiert
Palpation probe, graduated
 Palpateur gradué
 Palpador, graduado
 Palpatore, graduato

Insufflationskanülen
Insufflation needles

Aiguilles d'insufflation
Agujas de insuflación
 Aghi d'insufflazione



Veress

	Ø 2.0 mm (STANDARD)	Ø 2.7 mm (HIGH FLOW)
55 mm	tk 704-095	-
70 mm	tk 704-156	-
80 mm	tk 704-096	-
100 mm	tk 704-098	tk 704-151
120 mm	tk 704-100	tk 704-150
130 mm	tk 704-157	-
150 mm	tk 704-101	tk 704-152
170 mm	-	tk 704-154
230 mm	tk 754-159	-
260 mm	tk 704-104	-

Saug- und Spülkanülen
Suction and irrigation cannulas

Canules d'irrigation et aspiration
Cánulas de irrigación y aspiración
Cannule per aspirazione ed irrigazione

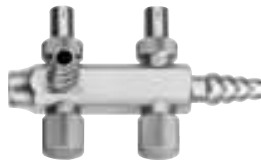

tk 704-642

Saug-Spülgriff mit Trompetenventilen
Suction/irrigation handle with trumpet valves

Manche de suction/irrigation avec piston
Mango de irrigación/aspiración con válvula de trompeta
Impugnatura di irrigazione/aspirazione con valvola a trompeta



tk 704-644

Saug-Spülgriff mit LL-Anschluss weiblich und Trompetenventilen
Suction/irrigation handle with LL-connection female and trumpet valves

Poignée pour irrigation/aspiration avec connecteurs LL femelles et valves à piston
Mango para irrigación/aspiración con conexiones LL hembras y valvulas de trompeta
Impugnatura di irrigazione/aspirazione con attacco LL female e valvole a trompeta



tk 704-646

Saug-Spülgriff mit Schiebeventil
Suction/irrigation handle with sliding valve

Manche de lavage/aspiration avec valve à pousser
Mango de irrigación/aspiración con válvula deslizante
Impugnatura di irrigazione/aspirazione con valvola a slitta



2.0 mm

1.8 mm

Ø 2.8 mm - 250 mm	tk 770-111-25	-	-	-	-	-	tk 770-110-25
Ø 2.8 mm - 330 mm	tk 770-111	-	-	-	-	-	tk 770-110
Ø 5.0 mm - 500 mm	-	-	-	tk 704-654	-	-	-
Ø 5.0 mm - 330 mm	tk 704-660	tk 704-656	tk 704-650	-	tk 704-652	tk 704-658	tk 704-662

Rundlochsauger Suction tubes	Standard standard	stumpf blunt	stumpf blunt	stumpf blunt	Dissektionskanüle Dissection cannula	Punktionskanüle Punction cannula
Canules d'aspiration Cánulas de aspiración Tubo d'aspirazione	Standard Estándar Standard	mousse roma smusso	mousse roma smusso	mousse roma smusso	Canule de dissection Cánula de disección Cannula da dissezione	Canule de ponction Cánula de punción Canula a punta d'ago



Saug- und Spülkanülen
Suction and irrigation cannulas

Canules d'irrigation et aspiration
Cánulas de irrigación y aspiración
Cannule per aspirazione ed irrigazione



4

	240 mm	330 mm	330 mm	
Ø 3.5 mm	tk 704-609			
Ø 5.0 mm		tk 704-608		
Ø 10.0 mm			tk 704-607	
				tk 704-605
tk 704-610		x	x	x

Satz
Set
Jeu
Juego
Serie

Spülgriff mit Trompetenventilen
und großem Schlauchanschluss
Handle with trumpet valves
and large tube connector

Poignée pour irrigation/aspiration avec
valves à piston et connection grande
Mango para irrigación/aspiración con
valvulas de trompeta y conexión grande
Impugnatura con valvola a trombetta
e connessione grande per tubo



Ø 5.0 mm	391 mm	tk 704-580	-
Ø 5.0 mm	340 mm	-	tk 704-582

mit Trompetenventilen
with trumpet valves

avec valves à piston
con valvulas de trompeta
con valvola a trombetta

mit Laserführung
with laser tube

avec guidage à laser
con guía laser
con canale per Laser

ohne Laserführung
without laser tube

sans guidage à laser
sin guía laser
senza canale per Laser

Saug- und Spülkanülen
Suction and irrigation cannulas

Canules d'irrigation et aspiration
Cánulas de irrigación y aspiración
Cannule per aspirazione ed irrigazione



tk 704-121

Zwei-Wege-Anschluss mit LL für Kontrastmittel
Two way stopcock with LL for contrast medium

Poignée avec deux robinets, connecteur LL, pour substance de contraste
Mango con dos grifos, conexión LL, para medio de contraste
Raccordo a due vie, LL, per mezzo di contrasto



	Ø 5.0 mm
330 mm	tk 704-602

Saugrohr mit LL-Anschluss
Suction tube with LL-connection

Canule d'aspiration avec connecteur LL
Cánula de aspiración con conexión LL
Tubo d'aspirazione, LL



	Ø 5.0 mm
300 mm	tk 704-603

Cholangiographie-Führungsrohr mit LL-Anschluss, gebogen
Cholangiogram guide with LL-connection, curved

Canule de guidage cholangiographie, courbe, avec connecteur LL
Cánula de guía cholangiografica, curva, con conexión LL
Guida per colangiografia, LL, curva

20.0 mm



	Ø 5.0 mm
330 mm	tk 704-120
450 mm	tk 704-122

Punktions- und Injektionskanüle, LL-Anschluss, Nadel - Ø 1,4 mm
Punction and injection cannula, LL-connection, needle - Ø 1.4 mm

Canule de ponction et injection, aiguille Ø 1,4mm, avec connecteur LL
Cánula de punción y de inyección, aguja Ø 1,4mm, con conexión LL
Canula per punzione ed iniezione, LL, ago - Ø 1.4 mm

Modulares Saug- und Spülsystem
Modular suction / irrigation system

Système modulaire d'aspiration et irrigation
Sistema modular de aspiración y irrigación
 Sistema aspirazione / irrigazione modulare



tk 704-715

Saug-/Spül - Pistolenhandgriff mit 2-Wege-Ventil und 2 Schlauchanschlüssen, für adaptierbare Rohre (M8x1 mm)
Suction/irrigation pistol handle with 2 way valve and 2 tube connectors, for adaptable tubes (M8x1 mm)

Poignée d'aspiration/irrigation avec valve de deux voies et 2 connecteurs, connecteur pour tubes d'aspiration (M8x1 mm)
Mango de irrigación/aspiración con valvula y 2 conexiones, conexión para vainas de aspiración (M8x1 mm)

Impugnatura a forma di pistola con valvola a 2 vie, 2 attacchi p. tubi e attacco per tubi d'aspirazione (M8x1 mm)

5



	x = 340 mm	x = 340 mm
Ø 3.0 mm	tk 704-720	tk 704-730
Ø 5.0 mm	tk 704-721	tk 704-731
Ø 10.0 mm	tk 704-722	tk 704-732

mit 4 Bohrungen
with 4 holes

avec 4 trous
con 4 orificios
 con 4 fori

mit 4x4 Bohrungen
with 4x4 holes

avec 4x4 trous
con 4x4 orificios
 con 4x4 fori



	x = 340 mm
Ø 5.0 mm	tk 704-745

Punktions-/Injektionsnadel Ø 1 mm, Anschluss (M8x1 mm)
Punction/injection needle Ø 1 mm, connection (M8x1 mm)

Canule de ponction et injection, Ø 1mm, connecteur (M8x1 mm)
Cánula de punción y inyección, Ø 1mm, conexión (M8x1 mm)
 Canula per punzione ed iniezione, Ø 1 mm (M8x1 mm)

Ventilhandgriffe und monopolare Elektroden
Valve handles and monopolar electrodes

Poignées avec valves, électrodes monopolaires
Mangos con valvulas, electrodos monopolares
 Manico con valvola, elettrodi monopolari



tk 704-750

Saug-/Spül - Pistolenhandgriff mit 2 Wege Schiebeventil und Schlauchanschlüssen, ergonomische Griffform, vergrößerter Saugkanal, gerade Durchgänge, Komfortbedienung durch kleinen Schwenkbereich des Schiebeventils
Suction / irrigation pistol handle with 2 way valve and tube connectors, ergonomic handle, larger suction canula, straight channels, comfortable handling due to movement of the lever

Poignée d'aspiration/irrigation avec valve de deux voies et 2 connecteurs, forme ergonomique, canaux larges, manipulation confortable

Mango de irrigación/aspiración con valvula y 2 conexiones, forma ergonomica, canales grandes, manipulación comfortable

Impugnatura a forma di pistola con valvola a 2 vie, 2 attacchi p. tubi e attacco per tubi d'aspirazione (M8x1 mm)



	330 mm	450 mm
Ø 3.0 mm	tk 704-751	
Ø 5.0 mm	tk 704-752	tk 704-752-45
Ø 10.0 mm	tk 704-753	tk 704-753-45

Saug-/Spülrohr
Suction/irrigation tube

Tube d'irrigation/aspiration

Vaina de irrigación/aspiración

Tubo d'aspirazione/irrigazione



tk 704-760

Elektrodenadapter für Saug-/Spül-Pistolenhandgriff (tk 704-750), 360° drehbar
Adapter for electrodes for suction/irrigation handle (tk 704-750), 360° rotatable

Adapteur pour électrodes pour poignée (tk 704-750), rotatif de 360°

Adaptator para electrodos para mango (tk 704-750), giratorio de 360°

Adattore per elettrodi per impugnatura (tk 704-750), rotante 360°

Ventilhandgriffe und monopolare Elektroden
Valve handles and monopolar electrodes

Poignées avec valves, électrodes monopolaires
Mangos con valvulas, electrodos monopolares
 Manico con valvola, elettrodi monopolari



tk795-4910

Pistolengriff mit wartungsfreiem 2-Wegeventil für adaptierbare HF-Elektroden mit Saug-/Spülkanal. Mit Drehadapter und seitlichem HF-Anschluss. 2 Universal-Schlauchanschlüsse.
Handle with 2-way-valve for adaptable HF-electrodes with suction/irrigation channel. With rotating adaptor and lateral HF-connector. Two universal hose connectors.

Poignée d'aspiration/irrigation avec valve de deux voies et 2 connecteurs, forme ergonomique, connecteur monopolaire latéral
Mango de irrigación/aspiración con valvula y 2 conexiones, forma ergonomica, conexión monopolar lateral
 Impugnatura a forma di pistola con valvola a 2 vie, per elettrodi AF con canale d'aspirazione / irrigazione, attacco AF

5



1:1

Ø 5.0mm	330 mm
Knopf <i>Ball point</i>	
Boule <i>Bola</i> Sfera	tk 704-761



1:1

Rundhaken <i>Hook</i>	
Crochet <i>Gancho</i> Uncino curvo	tk 704-762



1:1

Haken 90° <i>Hook 90°</i>	
Crochet 90° <i>Gancho 90°</i> Uncino 90°	tk 704-763



1:1

Spatel <i>Spatula</i>	
Spatule <i>Espátula</i> Spatola	tk 704-764



1:1

Nadel <i>Needle</i>	
Aiguille <i>Aguja</i> Ago	tk 704-765

Koagulations-Saugkanülen, monopolar
Coagulation suction tubes, monopolar

Canules á coagulation, monopolaires
Cánulas para coagulación, monopolares
 Canule per aspirazione, monopolari

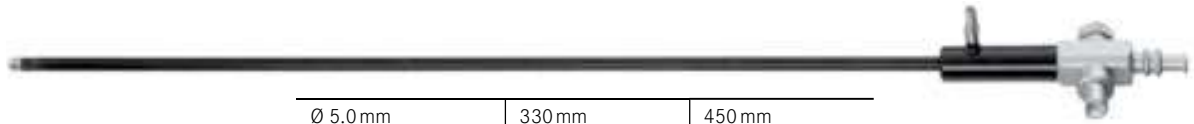

1:1



1:1



1:1



1:1



1:1

Ø 5.0 mm	330 mm	450 mm
Spatel Spatula Spatule <i>Espátula</i> Spatola	tk 706-180	tk 706-180-45
Rundhaken Hook Crochet <i>Gancho</i> Uncino curvo	tk 706-182	tk 706-182-45
Haken 90° Hook 90° Crochet 90° <i>Gancho 90°</i> Uncino 90°	tk 706-184	tk 706-184-45
Knopf Ball point Boule <i>Bola</i> Sfera	tk 706-186	tk 706-186-45
Nadel Needle Aiguille <i>Aguja</i> Ago	tk 706-187	tk 706-187-45

Elektrode, Saugkanüle mit Trompetenventil und LL-Ansatz
Electrode, suction tube with trumpet valve and LL-connection
 Électrode, canule avec valve à piston et connecteur LL
Electrodo, cánula con valvula de trompeta y conexión LL
 Elettrodi, canule per aspirazione con valvola a trombetta, attacco LL

TEKNO LINE

Laparoscopy Instruments

Tekno-Medical Laparoskopie-Instrumente sind dreiteilig zerlegbar, autoklavierbar und wiederverwendbar. Alle Instrumente sind komplett drehbar für eine maximale Beweglichkeit.

Unsere Laparoskopie-Instrumente sind robust ausgeführt und sie zeichnen sich durch eine qualitativ hochwertige Verarbeitung aus. Tekno-Medical Kunststoff-Handgriffe bestehen darüber hinaus durch einen großen Daumenring, sowie ein ergonomisches Design, welches bestmöglich das ermüdungsfreie Arbeiten unterstützt.

These instruments are detachable in three parts, autoclavable and reusable. All systems are completely rotatable, for universal use.

Our laparoscopy instruments are robust and safe.

Their outstanding quality is achieved to latest knowledge in production.

Tekno-Medical plastic handles also convince with a large thumb ring as well as an ergonomic design which supports fatigue-free work in the best possible way.

Les instruments de coelioscopie de Tekno-Medical sont démontables en trois pièces, autoclavables et réutilisables. Tous les instruments sont complètement rotatif pour une agilité maximale.

Nos instruments sont robustes et se distinguent par leur haut niveau de qualité. Les poignées en plastique de Tekno-Medical convainquent également par leur large anneau pour le pouce et leur design ergonomique, qui facilite le travail sans fatigue.

Los instrumentos de laparoscopia de Tekno-Medical son desmontables en tres partes, autoclavables y reutilisables. Todos los instrumentos son completamente giratorios para una movilidad maxima. Nuestros instrumentos son robustos y se caracterizan por su alto nivel de calidad. Los mangos de plástico de Tekno-Medical convencen también por su gran anillo para el pulgar y por su diseño ergonómico que facilita el trabajo sin fatiga de la mejor manera posible.

Strumenti per Laparoscopia delta Tekno-Medical sono smontabili, autoclavabili ed in tre pezzi riusabili. Tutti gli strumenti sono girevoli a 360°. I ns. strumenti sono molto robusti e di altissima qualità. Le maniglie in plastica di Tekno-Medical convincono anche per l'ampio anello per il pollice e il design ergonomico, che rende il lavoro senza fatica il più semplice possibile.



Laparoskopie-Handgriffe
Handles for laparoscopy instruments

Poignées de coelioscopie
Mangos de laparoscopia
Manici per pinze per laparoscopia

			
		<p>tk 775-4003</p>	<p>tk 775-4004</p>
<p>für System for system</p>		<p>ohne Sperre without ratchet</p>	<p>mit Sperre with ratchet</p>
<p>pour système para sistema</p>		<p>sans crémaillère sin cremallera</p>	<p>avec crémaillère con cremallera</p>
<p>per sistema</p>		<p>senza cremagliera</p>	<p>con cremagliera</p>

			
		<p>tk 775-3995</p>	<p>tk 775-4005</p>
<p>für System for system</p>		<p>mit zuschaltbarer Sperre with shiftable ratchet</p>	<p>mit Sperre with ratchet</p>
<p>pour système para sistema</p>		<p>avec crémaillère à rajouter con cremallera a adjuntar</p>	<p>avec crémaillère con cremallera</p>
<p>per sistema</p>		<p>con cremagliera disattivabile</p>	<p>con cremagliera</p>

Laparoskopie-Handgriffe
Handles for laparoscopy instruments

Poignées de coelioscopie
Mangos de laparoscopia
Manici per pinze per laparoscopia

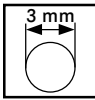

	tk 775-4303	tk 775-4304
für System <i>for system</i>	ohne Sperre <i>without ratchet</i>	mit Sperre <i>with ratchet</i>
pour système <i>para sistema</i>	sans crémaillère <i>sin cremallera</i>	avec crémaillère <i>con cremallera</i>
per sistema	senza cremagliera	con cremagliera

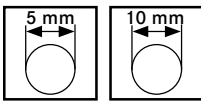

	tk 775-4002	tk 775-4001
für System <i>for system</i>	ohne Sperre <i>without ratchet</i>	mit Sperre <i>with ratchet</i>
pour système <i>para sistema</i>	sans crémaillère <i>sin cremallera</i>	avec crémaillère <i>con cremallera</i>
per sistema	senza cremagliera	con cremagliera

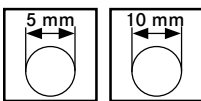

	tk 775-4000	tk 775-4006
für System <i>for system</i>	ohne Sperre <i>without ratchet</i>	mit Sperre <i>with ratchet</i>
pour système <i>para sistema</i>	sans crémaillère <i>sin cremallera</i>	avec crémaillère <i>con cremallera</i>
per sistema	senza cremagliera	con cremagliera

Schaftrohre für Laparoskopie-Instrumente
Shafts for laparoscopy instruments

Gaines pour les instruments de coelioscopie
Vainas para los instrumentos de laparoscopia
Tubi d'asta per pinze per laparoscopia



TEKNOLINE

	Ø 3.0 mm	Ø 5.0 mm	Ø 10.0 mm	Ø 5.0 mm	Ø 5.0 mm	Ø 10.0 mm
250 mm	tk 775-4114-25	tk 775-4009	tk 775-4012-25	-	tk 775-4013	-
330 mm	tk 775-4114	tk 775-4010	tk 775-4012	tk 775-4010LL	tk 775-4014	tk 775-4016
450 mm	tk 775-4114-45	tk 775-4011	tk 775-4012-45	tk 775-4010-45LL	tk 775-4015	-

Außenrohr isoliert
Shaft insulated

Gaine isolée
Vaina aislada
Tubi esterni isolati

mit LL-Spülanschluss
with LL irrigation connection

avec raccord d'irrigation LL
con conexión de irrigación LL
con accesso LL

Außenrohr nicht isoliert
Shaft not insulated

Gaine non isolée
Vaina no aislada
Tubi esterni non isolati



TEKNOLINE

	Ø 5.0 mm	Ø 5.0 mm	Ø 5.0 mm	Ø 5.0 mm
330 mm	tk 775-4110 ●	tk 775-4111 ●	tk 775-4112 ●	tk 775-4113 ●

Außenrohr isoliert
Shaft insulated

Gaine isolée
Vaina aislada
Tubi esterni isolati



Andere Längen auf Anfrage lieferbar
Other lengths available upon request

Autres longueurs sont disponibles sur demande
Otras longitudes son disponibles según demanda
Altre lunghezze a richiesta



MIKRO Instrumente, nicht zerlegbar, mit LL
MICRO instruments, not detachable, with LL

MICRO instruments non-démontables, connecteur LL
MICRO instrumentos non desmontables, conexión LL
MICRO strumenti non smontabili, con LL

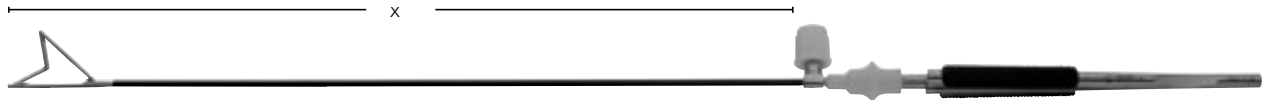

	x = 220 mm	x = 250 mm
Ø 2.8 mm	tk 783-710	tk 783-711



Fasszange, atraumatisch, gebogen, isoliert, mit Sperre
Grasping forceps, atraumatic, curved, insulated, with ratchet

Pince à saisir, atraumatique, courbe, isolée, avec crémaillère

Pinza de agarre, atraumatica, curva, aislada, con cierre

Pinza da presa, atraumatica, curva, isolata con cremagliera

	x = 220 mm	x = 250 mm
Ø 2.8 mm	tk 783-720	tk 783-721



Schere, stumpf, gebogen, isoliert
Scissors, blunt, curved, insulated

Ciseaux, mousse, courbe, isolé

Tijera, roma, curva, aislada

Forbice, smussa, curva, isolata

	x = 220 mm	x = 250 mm
Ø 2.8 mm	tk 783-730	tk 783-731



Nadelhalter, gerade, isoliert, mit Sperre
Needleholder, straight, insulated, with ratchet

Porte-aiguille, droit, isolé, avec crémaillère

Porta-agujas, recto, aislado, con cierre

Portaghi, retto, isolato con cremagliera

	x = 220 mm	x = 250 mm
Ø 2.8 mm	tk 783-740	tk 783-741



Fasszange, atraumatisch, gerade, gefenstert, isoliert, mit Sperre
Grasping forceps, atraumatic, straight, fenestrated, insulated, with ratchet

Pince à saisir, atraumatique, droite, fenêtrée, isolée, avec crémaillère

Pinza de agarre, atraumatica, recta, fenestrada, aislada, con cierre

Pinza da presa, atraumatica, retta, fenestrata, isolata con cremagliera

	x = 220 mm	x = 250 mm
Ø 2.8 mm	tk 783-750	tk 783-751



Retraktor, isoliert, mit Sperre
Tissue retractor, insulated, with ratchet

Retracteur, isolé, avec crémaillère

Separador, aislado, con cierre

Retratore, isolato, con cremagliera

Mini-Instrumente, zerlegbar
Mini-Instruments, detachable

Mini instruments, démontables
Mini instrumentos, desmontables
Strumenti mini, smontabili

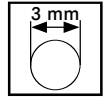

ohne Sperre
without ratchet
sans crémaillère
sin cremallera
senza cremagliera











mit Sperre
with ratchet
avec crémaillère
con cremallera
con cremagliera



Einsatz allein
Insert only
Insert seul
Inserto solo
Inserto, solo

TEKNOLINE

		Ø 3.0 mm	Ø 3.0 mm	Ø 3.0 mm
 1:1 Cobra, Fassungzange, 2x1 Zähne Cobra, grasping forceps 2x1 teeth Pince à saisir Cobra, 2x1 dents Cobra, pinza da agarre 2x1 dientes Cobra, pinze da presa 2x1 denti	250 mm	tk 783-102-25	tk 783-202-25	tk 783-602-25
	330 mm	tk 783-102	tk 783-202	tk 783-602
	450 mm	tk 783-102-45	tk 783-202-45	tk 783-602-45
 1:1 MARYLAND Dissektor/Fassungzange MARYLAND dissecting/grasping forceps MARYLAND pince à dissection/saisir MARYLAND disectora/pinza de agarre MARYLAND pinza da dissezione/presa	250 mm	tk 783-104-25	tk 783-204-25	tk 783-604-25
	330 mm	tk 783-104	tk 783-204	tk 783-604
	450 mm	tk 783-104-45	tk 783-204-45	tk 783-604-45
 1:1 DELPHIN Präparier- und Fassungzange DOLPHIN dissecting and grasping forceps Dauphin, pince à dissection Delfin, pinza de dissección Delfino, pinza de presa e dissezione	250 mm	tk 783-106-25	tk 783-206-25	tk 783-606-25
	330 mm	tk 783-106	tk 783-206	tk 783-606
	450 mm	tk 783-106-45	tk 783-206-45	tk 783-606-45
 1:1 Fassungzange, gefenestert Grasping forceps, fenestrated Pince à saisir, fenêtré Pinza de agarre, fenestrada Pinza da presa, finestrata	250 mm	tk 783-107-25	tk 783-207-25	tk 783-607-25
	330 mm	tk 783-107	tk 783-207	tk 783-607
	450 mm	tk 783-107-45	tk 783-207-45	tk 783-607-45
 1:1 METZENBAUM Schere, gebogen METZENBAUM scissors, curved METZENBAUM ciseaux, courbes METZENBAUM tijera, curva METZENBAUM forbice curva	250 mm	tk 783-120-25	-	tk 783-620-25
	330 mm	tk 783-120	-	tk 783-620
	450 mm	tk 783-120-45	-	tk 783-620-45
 1:1 METZENBAUM Schere, gerade METZENBAUM scissors, straight METZENBAUM ciseaux, droites METZENBAUM tijera, recta METZENBAUM forbice retta	250 mm	tk 783-123-25	-	tk 783-623-25
	330 mm	tk 783-123	-	tk 783-623
	450 mm	tk 783-123-45	-	tk 783-623-45
 1:1 Hakenschere Hook scissors Ciseaux à crochet Tijera de gancho Forbice ad uncino	250 mm	tk 783-124-25	-	tk 783-624-25
	330 mm	tk 783-124	-	tk 783-624
	450 mm	tk 783-124-45	-	tk 783-624-45
 1:1 Biopsiestanze, durchschneidend Biopsy forceps, through cutting type Pince à biopsie, coupante Pinza biopsia, cortante Pinza tagliente per biopsia	250 mm	tk 783-125-25	tk 783-225-25	tk 783-625-25
	330 mm	tk 783-125	tk 783-225	tk 783-625
	450 mm	tk 783-125-45	tk 783-225-45	tk 783-625-45
 1:1 Biopsiezange Biopsy forceps Pince à biopsie Pinza biopsia Pinza per biopsia	250 mm	tk 783-128-25	tk 783-228-25	tk 783-628-25
	330 mm	tk 783-128	tk 783-228	tk 783-628
	450 mm	tk 783-128-45	tk 783-228-45	tk 783-628-45



Mini-Instrumente, zerlegbar
Mini-Instruments, detachable

Mini instruments, démontables
Mini instrumentos, desmontables
Strumenti mini, smontabili



ohne Sperre
without ratchet
sans crémaillère
sin cremallera
senza cremagliera











mit Sperre
with ratchet
avec crémaillère
con cremallera
con cremagliera



Einsatz allein
Insert only
Insert seul
Inserto solo
Inserto, solo

TEKNOLINE

		Ø 3.0 mm	Ø 3.0 mm	Ø 3.0 mm
	Biopsie Stanze <i>Biopsy forceps</i>	250 mm 330 mm 450 mm	tk 783-145-25 tk 783-145 tk 783-145-45	tk 783-245-25 tk 783-245 tk 783-245-45
1:1	Pince à biopsie <i>Pinza de biopsia</i> Pinze per biopsia			tk 783-645-25 tk 783-645 tk 783-645-45
	Löffelzange <i>Spoon-forceps</i>	250 mm 330 mm 450 mm	tk 783-127-25 tk 783-127 tk 783-127-45	tk 783-227-25 tk 783-227 tk 783-227-45
1:1	Pince à cuillère <i>Pinza de cuchara</i> Pinza a cucchiaio			tk 783-627-25 tk 783-627 tk 783-627-45
	DEBAKEY, atraumatisch, 14mm lang <i>DEBAKEY, atraumatic, 14mm jaw length</i>	250 mm 330 mm 450 mm	tk 783-159-25 tk 783-159 tk 783-159-45	tk 783-259-25 tk 783-259 tk 783-259-45
1:1	DEBAKEY, atraumatique, 14mm <i>DEBAKEY, atraumatica, 14mm</i> DEBAKEY atraumatica, morso lungo 14mm			tk 783-659-25 tk 783-659 tk 783-659-45
	JOHAN, 20 mm, gezahntes Maul <i>JOHAN, 20 mm, serrated jaws</i>	250 mm 330 mm 450 mm	tk 783-158-25 tk 783-158 tk 783-158-45	tk 783-258-25 tk 783-258 tk 783-258-45
1:1	JOHAN, 20mm, dentelée <i>JOHAN, 20mm, dentada</i> JOHAN, 20 mm, morso zigrinato			tk 783-658-25 tk 783-658 tk 783-658-45
	BABCOCK Fasszange <i>BABCOCK-forceps</i>	250 mm 330 mm 450 mm	tk 783-157-25 tk 783-157 tk 783-157-45	tk 783-257-25 tk 783-257 tk 783-257-45
1:1	BABCOCK pince à saisir <i>BABCOCK pinza de agarre</i> BABCOCK pinza da presa			tk 783-657-25 tk 783-657 tk 783-657-45
	Multiple Fasszange <i>Multiple grasping forceps</i>	250 mm 330 mm 450 mm	tk 783-155-25 tk 783-155 tk 783-155-45	tk 783-255-25 tk 783-255 tk 783-255-45
1:1	Pince strié, multiple <i>Pinza estriada, multiple</i> Pinza da presa universale			tk 783-655-25 tk 783-655 tk 783-655-45
	Fasszange mit starker Zahnung <i>Grasping forceps, strong teeth</i>	250 mm 330 mm 450 mm	tk 783-154-25 tk 783-154 tk 783-154-45	tk 783-254-25 tk 783-254 tk 783-254-45
1:1	Mors fortement strié <i>Boca fuertemente estriada</i> Pinza da presa con dentatura forte			tk 783-654-25 tk 783-654 tk 783-654-45
	Fasszange mit 4x5 Zähnen, glatt <i>Grasping forceps, 4x5 teeth, smooth</i>	250 mm 330 mm 450 mm	tk 783-152-25 tk 783-152 tk 783-152-45	tk 783-252-25 tk 783-252 tk 783-252-45
1:1	Pince à saisir, 4x5 dents, lisse <i>Pinza de agarre, 4x5 dientes, lisa</i> Pinza da presa, 4x5 denti, liscia			tk 783-652-25 tk 783-652 tk 783-652-45
	Fasszange, 2x4 gezahnt <i>Grasping forceps, 2x4 teeth</i>	250 mm 330 mm 450 mm	tk 783-151-25 tk 783-151 tk 783-151-45	tk 783-251-25 tk 783-251 tk 783-251-45
1:1	Pince à saisir, 2x4 dents <i>Pinza de agarre, 2x4 dientes</i> Pinza da presa, 2x4 denti			tk 783-651-25 tk 783-651 tk 783-651-45

Mini-Instrumente, zerlegbar
Mini-Instruments, detachable

Mini instruments, démontables
Mini instrumentos, desmontables
Strumenti mini, smontabili

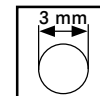

ohne Sperre
without ratchet
sans crémaillère
sin cremallera
senza cremagliera











mit Sperre
with ratchet
avec crémaillère
con cremallera
con cremagliera



Einsatz allein
Insert only
Insert seul
Inserto solo
Inserto, solo

TEKNOLINE

		Ø 3.0 mm	Ø 3.0 mm	Ø 3.0 mm
 1:1 MARYLAND, kreuzgerieft MARYLAND, cross serrated MARYLAND, strié en cruciforme MARYLAND, estriada en cruciforma MARYLAND, zigrinatura a croce	250 mm	tk 783-156-25	tk 783-256-25	tk 783-656-25
	330 mm	tk 783-156	tk 783-256	tk 783-656
	450 mm	tk 783-156-45	tk 783-256-45	tk 783-656-45
 1:1 Fasszange, gerieft Grasping forceps, serrated Pince strié Pinza estriada Pinza da presa zigrinata	250 mm	tk 783-150-25	tk 783-250-25	tk 783-650-25
	330 mm	tk 783-150	tk 783-250	tk 783-650
	450 mm	tk 783-150-45	tk 783-250-45	tk 783-650-45
 1:1 Mikroschere Micro scissors Ciseaux micro Tijera micro Forbici micro	250 mm	tk 783-143-25	-	tk 783-643-25
	330 mm	tk 783-143	-	tk 783-643
	450 mm	tk 783-143-45	-	tk 783-643-45
 1:1 Peritoneal-Schere, 1 Blatt gezahnt Peritoneal scissors, 1 blade serrated Ciseaux péritonéales, une lame crantée Tijera peritoneal, una hoja dentada Forbici paritoneale, 1 lama dentellata	250 mm	tk 783-141-25	-	tk 783-641-25
	330 mm	tk 783-141	-	tk 783-641
	450 mm	tk 783-141-45	-	tk 783-641-45
 1:1 Fasszange mit Reservoir Grasping forceps with cup Pince avec cuillère Pinza con cuchara Pinza da presa con cucchiaio	250 mm	tk 783-132-25	tk 783-232-25	tk 783-632-25
	330 mm	tk 783-132	tk 783-232	tk 783-632
	450 mm	tk 783-132-45	tk 783-232-45	tk 783-632-45
 1:1 KELLY Fasszange KELLY grasping forceps KELLY, pince à saisir KELLY, pinza de agarre KELLY, pinza da presa	250 mm	tk 783-129-25	tk 783-229-25	tk 783-629-25
	330 mm	tk 783-129	tk 783-229	tk 783-629
	450 mm	tk 783-129-45	tk 783-229-45	tk 783-629-45
 1:1 MIXTER Fasszange, 90° gewinkelt MIXTER grasping forceps, 90° angled MIXTER, 90° angulé MIXTER, 90° angulada MIXTER, pinza da presa angolata a 90°	250 mm	tk 783-130-25	tk 783-230-25	tk 783-630-25
	330 mm	tk 783-130	tk 783-230	tk 783-630
	450 mm	tk 783-130-45	tk 783-230-45	tk 783-630-45
 1:1 Mikroschere, gebogen Micro scissors, curved Ciseaux micro, courbes Tijera micro, curva Forbici micro, curva	250 mm	tk 783-142-25	-	tk 783-642-25
	330 mm	tk 783-142	-	tk 783-642
	450 mm	tk 783-142-45	-	tk 783-642-45



Scheren, zerlegbar
Scissors, detachable

Ciseaux, démontables
Tijeras, desmontables
Forbici, smontabili

TEKNOSTEEL

Die Schneide der **TEKNOSTEEL** - Schere besteht aus einer speziellen rostfreien Stahllegierung, die für lange Zeit die optimale Schärfe und Widerstand gegen Korrosion bietet. Die verbesserte Härte des verwendeten Materials sorgt für lange konstante Schärfe und spart dadurch unnötige Kosten für häufiges Nachschleifen und der damit verbundenen Ausfallzeit des Instruments. Schneidet sogar mehrfach Federstahlblech ohne spürbaren Schärfeverlust.

The **TEKNOSTEEL** - scissors are made of a special stainless steel which guarantees an optimal sharpness for a long time and a resistance against corrosion. The improved hardness of this type of steel leads to a long and constant sharpness and helps to save a lot of costs for resharpening the scissors frequently. It repeatedly cuts steel sheets without losing sharpness.

Les lames des ciseaux **TEKNOSTEEL** sont produites d'une alliage d'acier spéciale, qui garantit la maintenance de la coupe pour longtemps et une haute résistance contre corrosion. La dureté améliorée des matériaux utilisés réduit la nécessité d'affûtage. Les ciseaux coupent même des lames d'acier fines.

Las hojas de las tijeras **TEKNOSTEEL** son producidas de una aleación de acero especial, que garantiza la calidad del corte mas larga y una alta resistencia contro corrosión. La dureza ameliorada del material utilizado reduce la necesidad de afilar las tijeras. Las tijeras cortan también hojas de acero finas.

Il morso della forbici **TEKNOSTEEL** è prodotto con un acciaio inossidabile speciale che assicura un taglio ottimale ed una resistenza contro la corrosione per un tempo lungo. Ciò vi fa risparmiare dei costi per ulteriori affilature ed evita la manutenzione dello strumento.

6



ohne Sperre
without ratchet

sans crémaillère
sin cremallera
senza cremagliera



ohne Sperre
without ratchet

sans crémaillère
sin cremallera
senza cremagliera

Einsatz allein
Insert only

Insert seul
Inserto solo
Inserto, solo

TEKNOLINE

		Ø 5.0 mm	Ø 5.0 mm	Ø 5.0 mm
 1:1 Hakenschere Hook scissors Ciseaux à crochet Tijera de gancho Forbici a gancio	250 mm	tk 775-4020-25 TSC	tk 775-4020-25 TSCM	tk 775-4020-25 TS
	330 mm	tk 775-4020 TSC	tk 775-4020 TSCM	tk 775-4020 TS
	450 mm	tk 775-4020-45 TSC	tk 775-4020-45 TSCM	tk 775-4020-45 TS
 1:1 Peritoneal-Schere Peritoneal-scissors Ciseaux péritonéales Tijera peritonal Forbici peritoneale	250 mm	tk 775-4026-25 TSC	tk 775-4026-25 TSCM	tk 775-4026-25 TS
	330 mm	tk 775-4026 TSC	tk 775-4026 TSCM	tk 775-4026 TS
	450 mm	tk 775-4026-45 TSC	tk 775-4026-45 TSCM	tk 775-4026-45 TS
 1:1 Metzenbaum-Schere, gebogen Metzenbaum-scissors, curved Metzenbaum ciseaux, courbes Metzenbaum tijera, curva Metzenbaum forbici, curva	250 mm	tk 775-4027-25 TSC	tk 775-4027-25 TSCM	tk 775-4027-25 TS
	330 mm	tk 775-4027 TSC	tk 775-4027 TSCM	tk 775-4027 TS
	450 mm	tk 775-4027-45 TSC	tk 775-4027-45 TSCM	tk 775-4027-45 TS

Nadelhalter, zerlegbar
Needleholder, detachable

Porte-aiguilles, démontables
Porta-agujas, desmontables
Porta aghi, smontabili

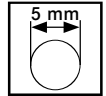

TEKNOSTEEL

Die Maulteile der **TEKNOSTEEL** - Instrumente bestehen aus einer speziellen rostfreien Stahllegierung, die für lange Zeit die optimale Beibehaltung der Maulstruktur und Widerstand gegen Korrosion bietet. Die verbesserte Härte des verwendeten Materials spart unnötige Kosten für häufiges Nacharbeiten und der damit verbundenen Ausfallzeit des Instruments.

The **TEKNOSTEEL** - instruments are made of a special stainless steel which guarantees the keeping of the optimal jaw structure for a long time and a resistance against corrosion. The improved hardness of this type of steel helps to save a lot of costs for frequent rework.

Les mors du instruments **TEKNOSTEEL** sont produites d'une alliage d'acier spéciale, qui garantit la maintenance de la structure du mors pour longtemps et une haute résistance contre corrosion. La dûtreté amélioré des matériaux utilisés réduit la nécessité d'affûtage.

Las bocas de los instrumentos **TEKNOSTEEL** son producidas de una aleación de acero especial, que garantiza la estructura de la boca mas larga y una alta resistencia contro corrosión. La dureza mejorada del material utilizado reduce la necesidad de controlas frecuentes.

Il morso dei porta aghi **TEKNOSTEEL** è prodotto con un acciaio inossidabile speciale che assicura una presa ottimale ed una resistenza contro corrosione per un lungo tempo. Ciò vi fa risparmiare dei costi per eventuali riparazioni dello strumento.



ohne Sperre
without ratchet
sans crémaillère
sin cremallera
senza cremagliera







mit Sperre
with ratchet
avec crémaillère
con cremallera
con cremagliera



Einsatz allein
Insert only
Insert seul
Inserto solo
Inserto, solo

TEKNOLINE

		Ø 5.0 mm	Ø 5.0 mm	Ø 5.0 mm
 1:1 Nadelhalter gerade <i>Needle holder pointed model</i> Porte-aiguilles droite Porta-agujas recta Porta aghi retto	250 mm	tk 775-4214-25 TSC	tk 775-4214-25 TSCS	tk 775-4214-25 TS
	330 mm	tk 775-4214 TSC	tk 775-4214 TSCS	tk 775-4214 TS
	450 mm	tk 775-4214-45 TSC	tk 775-4214-45 TSCS	tk 775-4214-45 TS
 1:1 Nadelhalter rechts gebogen <i>Needle holder right curved</i> Porte-aiguilles droite courbe Porta-agujas derecha curva Porta aghi a destra curvo	250 mm	tk 775-4212-25 TSC	tk 775-4212-25 TSCS	tk 775-4212-25 TS
	330 mm	tk 775-4212 TSC	tk 775-4212 TSCS	tk 775-4212 TS
	450 mm	tk 775-4212-45 TSC	tk 775-4212-45 TSCS	tk 775-4212-45 TS
 1:1 Nadelhalter links gebogen <i>Needle holder left curved</i> Porte-aiguilles gauche courbe Porta-agujas izquierda curva Porta aghi a sinistra curvo	250 mm	tk 775-4213-25 TSC	tk 775-4213-25 TSCS	tk 775-4213-25 TS
	330 mm	tk 775-4213 TSC	tk 775-4213 TSCS	tk 775-4213 TS
	450 mm	tk 775-4213-45 TSC	tk 775-4213-45 TSCS	tk 775-4213-45 TS
 1:1 Nadelhalter schnabelförmig <i>Needle holder beaked</i> Porte-aiguilles en forme de bec Porta-agujas curva en forma de pico Porta aghi a forma di becco	250 mm	tk 775-4210-25 TSC	tk 775-4210-25 TSCS	tk 775-4210-25 TS
	330 mm	tk 775-4210 TSC	tk 775-4210 TSCS	tk 775-4210 TS
	450 mm	tk 775-4210-45 TSC	tk 775-4210-45 TSCS	tk 775-4210-45 TS

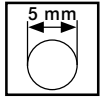

Scheren, zerlegbar
Scissors, detachable

Ciseaux, démontables
Tijeras, desmontables
Forbici, smontabili











ohne Sperre
without ratchet
sans crémaillère
sin cremallera
senza cremagliera



Einsatz allein
Insert only
Insert seul
Inserto solo
Inserto, solo

TEKNOLINE

		Ø 5.0 mm	Ø 5.0 mm			
 1:1	Hakenschere <i>Hook scissors</i> Ciseaux à crochet <i>Tijera de gancho</i> Forbici a gancio	250 mm 330 mm 450 mm	tk 775-4020-25 C tk 775-4020 C tk 775-4020-45 C	tk 775-4020-25 tk 775-4020 tk 775-4020-45		
	 1:1	METZENBAUM-Schere <i>METZENBAUM-scissors</i> METZENBAUM ciseaux <i>METZENBAUM tijera</i> METZENBAUM forbici	250 mm 330 mm 450 mm	tk 775-4022-25 C tk 775-4022 C tk 775-4022-45 C	tk 775-4022-25 tk 775-4022 tk 775-4022-45	
		 1:1	METZENBAUM-Schere, gebogen <i>METZENBAUM-scissors, curved</i> METZENBAUM ciseaux, courbes <i>METZENBAUM tijera, curva</i> METZENBAUM forbici, curve	250 mm 330 mm 450 mm	tk 775-4023-25 C tk 775-4023 C tk 775-4023-45 C	tk 775-4023-25 tk 775-4023 tk 775-4023-45
			 1:1	Mikroschere <i>Micro scissors</i> Ciseaux micro <i>Tijera micro</i> Forbici micro	250 mm 330 mm 450 mm	tk 775-4024-25 C tk 775-4024 C tk 775-4024-45 C
 1:1	Mikroschere, gebogen <i>Micro scissors, curved</i> Ciseaux micro, courbes <i>Tijera micro, curva</i> Forbici micro, curve			250 mm 330 mm 450 mm	tk 775-4025-25 C tk 775-4025 C tk 775-4025-45 C	tk 775-4025-25 tk 775-4025 tk 775-4025-45
	 1:1	Peritoneal-Schere, 1 Blatt gezahnt <i>Peritoneal scissors, 1 blade serrated</i> Ciseaux péritonéales, une lame crantée <i>Tijera peritoneal, una hoja dentada</i> Forbici paritoneale, 1 lama dentellata		250 mm 330 mm 450 mm	tk 775-4026-25 C tk 775-4026 C tk 775-4026-45 C	tk 775-4026-25 tk 775-4026 tk 775-4026-45
		 1:1	METZENBAUM-Schere, gebogen, lang <i>METZENBAUM-scissors, curved, long</i> METZENBAUM ciseaux, courbes, longue <i>METZENBAUM tijera, curva, larga</i> METZENBAUM forbici, curve, lama lunga	250 mm 330 mm 450 mm	tk 775-4027-25 C tk 775-4027 C tk 775-4027-45 C	tk 775-4027-25 tk 775-4027 tk 775-4027-45
 1:1			OP-Schere <i>OP-scissors</i> Ciseaux à opérations <i>Tijera para operaciones</i> Forbici per operazione	250 mm 330 mm 450 mm	tk 775-3928-25 C tk 775-3928 C tk 775-3928-45 C	tk 775-3928-25 tk 775-3928 tk 775-3928-45
	 1:1		OP-Schere, gebogen <i>OP-scissors, curved</i> Ciseaux à opérations, courbes <i>Tijera para operaciones, curva</i> Forbici per operazione, curve	250 mm 330 mm 450 mm	tk 775-3929-25 C tk 775-3929 C tk 775-3929-45 C	tk 775-3929-25 tk 775-3929 tk 775-3929-45

Biopsiezangen, zerlegbar
Biopsy forceps, detachable

Pincés à biopsie, démontables
Pinzas de biopsia, desmontables
 Pinze per biopsia, smontabili

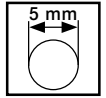

ohne Sperre
without ratchet
 sans crémaillère
sin cremallera
 senza cremagliera

mit Sperre
with ratchet
 avec crémaillère
con cremallera
 con cremagliera

Einsatz allein
Insert only
 Insert seul
Inserto solo
 Inserto, solo

TEKNOLINE

		Ø 5.0 mm	Ø 5.0 mm	Ø 5.0 mm
 1:1	Biopsie Stanze <i>Biopsy forceps</i> Pince à biopsie <i>Pinza de biopsia</i> Pinze per biopsia	250 mm 330 mm 450 mm	tk 775-4030-25 C tk 775-4030 C tk 775-4030-45 C	tk 775-4030-25 CS tk 775-4030 CS tk 775-4030-45 CS
 1:1	Biopsie Stanze, gerieft mit Zahn <i>Biopsy forceps, serrated with tooth</i> Pince à biopsie, striée, avec dent <i>Pinza de biopsia, estriada, con diente</i> Pinze per biopsia dentellata, con dente	250 mm 330 mm 450 mm	tk 775-4031-25 C tk 775-4031 C tk 775-4031-45 C	tk 775-4031-25 CS tk 775-4031 CS tk 775-4031-45 CS
 1:1	Biopsie Stanze, durchschneidend <i>Biopsy forceps, through cutting</i> Pince à biopsie, coupante <i>Pinza de biopsia, cortante</i> Pinze per biopsia, tagliente	250 mm 330 mm 450 mm	tk 775-4034-25 C tk 775-4034 C tk 775-4034-45 C	tk 775-4034-25 CS tk 775-4034 CS tk 775-4034-45 CS
 1:1	Biopsie Stanze <i>Biopsy forceps</i> Pince à biopsie <i>Pinza de biopsia</i> Pinze per biopsia	250 mm 330 mm 450 mm	tk 775-4033-25 C tk 775-4033 C tk 775-4033-45 C	tk 775-4033-25 CS tk 775-4033 CS tk 775-4033-45 CS
 1:1	Biopsie Stanze mit Zahn <i>Biopsy forceps with tooth</i> Pince à biopsie, avec dent <i>Pinza de biopsia, con diente</i> Pinze per biopsia, con dente	250 mm 330 mm 450 mm	tk 775-4032-25 C tk 775-4032 C tk 775-4032-45 C	tk 775-4032-25 CS tk 775-4032 CS tk 775-4032-45 CS
 1:1	Löffelzange <i>Spoon-forceps</i> Pince à cuillère <i>Pinza de cuchara</i> Pinza a cucchiaio	250 mm 330 mm 450 mm	tk 775-4245-25 C tk 775-4245 C tk 775-4245-45 C	tk 775-4245-25 CS tk 775-4245 CS tk 775-4245-45 CS
 1:1	Alligator-Biopsie-Fasszange <i>Alligator-biopsy-forceps</i> Pince à biopsie, crocodile <i>Pinza de biopsia, cocodrilo</i> Morso alligatore	250 mm 330 mm 450 mm	tk 775-4066-25 C tk 775-4066 C tk 775-4066-45 C	tk 775-4066-25 CS tk 775-4066 CS tk 775-4066-45 CS

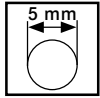

Fasszangen, zerlegbar
Grasping forceps, detachable

Pincès à saisir, démontables
Pinzas de agarre, desmontables
Pinze da presa, smontabili











ohne Sperre
without ratchet
sans crémaillère
sin cremallera
senza cremagliera

mit Sperre
with ratchet
avec crémaillère
con cremallera
con cremagliera

Einsatz allein
Insert only
Insert seul
Inserto solo
Inserto, solo

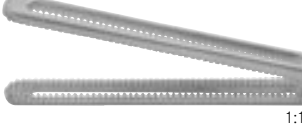
TEKNOLINE

		Ø 5.0 mm	Ø 5.0 mm	Ø 5.0 mm
 <p>Dissektor, kurz, gezahnt <i>Dissecting forceps, short serrated</i></p>	250 mm	tk 775-4086-25 C	tk 775-4086-25 CS	tk 775-4086-25
	330 mm	tk 775-4086 C	tk 775-4086 CS	tk 775-4086
	450 mm	tk 775-4086-45 C	tk 775-4086-45 CS	tk 775-4086-45
 <p>PETELIN Dissektor, leicht gebogen <i>PETELIN dissecting forceps, slightly curved</i></p>	250 mm	tk 775-4084-25 C	tk 775-4084-25 CS	tk 775-4084-25
	330 mm	tk 775-4084 C	tk 775-4084 CS	tk 775-4084
	450 mm	tk 775-4084-45 C	tk 775-4084-45 CS	tk 775-4084-45
 <p>PETELIN Dissektor, stark gebogen <i>PETELIN dissecting forceps, strong curved</i></p>	250 mm	tk 775-4083-25 C	tk 775-4083-25 CS	tk 775-4083-25
	330 mm	tk 775-4083 C	tk 775-4083 CS	tk 775-4083
	450 mm	tk 775-4083-45 C	tk 775-4083-45 CS	tk 775-4083-45
 <p>Dissektor, kurz gebogen, gezahnt <i>Dissecting forceps, short curved, serrated</i></p>	250 mm	tk 775-4085-25 C	tk 775-4085-25 CS	tk 775-4085-25
	330 mm	tk 775-4085 C	tk 775-4085 CS	tk 775-4085
	450 mm	tk 775-4085-45 C	tk 775-4085-45 CS	tk 775-4085-45
 <p>Fasszange wellenförmig <i>Grasping forceps, wavy</i></p>	250 mm	tk 775-4062-25 C	tk 775-4062-25 CS	tk 775-4062-25
	330 mm	tk 775-4062 C	tk 775-4062 CS	tk 775-4062
	450 mm	tk 775-4062-45C	tk 775-4062-45CS	tk 775-4062-45
 <p>JOHAN, 20 mm, gezahntes Maul <i>JOHAN, 20 mm, serrated jaws</i></p>	250 mm	tk 775-4096-25 C	tk 775-4096-25 CS	tk 775-4096-25
	330 mm	tk 775-4096 C	tk 775-4096 CS	tk 775-4096
	450 mm	tk 775-4096-45 C	tk 775-4096-45 CS	tk 775-4096-45
 <p>JOHAN 45 mm, gezahntes Maul <i>JOHAN 45 mm, serrated jaws</i></p>	250 mm	tk 775-4097-25 C	tk 775-4097-25 CS	tk 775-4097-25
	330 mm	tk 775-4097 C	tk 775-4097 CS	tk 775-4097
	450 mm	tk 775-4097-45 C	tk 775-4097-45 CS	tk 775-4097-45
 <p>KOCHER Fasszange, 2x1 Zähne <i>KOCHER Grasping forceps, 2x1 teeth</i></p>	250 mm	tk 775-4087-25 C	tk 775-4087-25 CS	tk 775-4087-25
	330 mm	tk 775-4087 C	tk 775-4087 CS	tk 775-4087
	450 mm	tk 775-4087-45 C	tk 775-4087-45 CS	tk 775-4087-45

Fasszangen, zerlegbar
Grasping forceps, detachable

Pincés à saisir, démontables
Pinzas de agarre, desmontables
Pinze da presa, smontabili

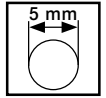

ohne Sperre
without ratchet
sans crémaillère
sin cremallera
senza cremagliera

mit Sperre
with ratchet
avec crémaillère
con cremallera
con cremagliera

Einsatz allein
Insert only
Inserto solo
Inserto, solo

TEKNOLINE

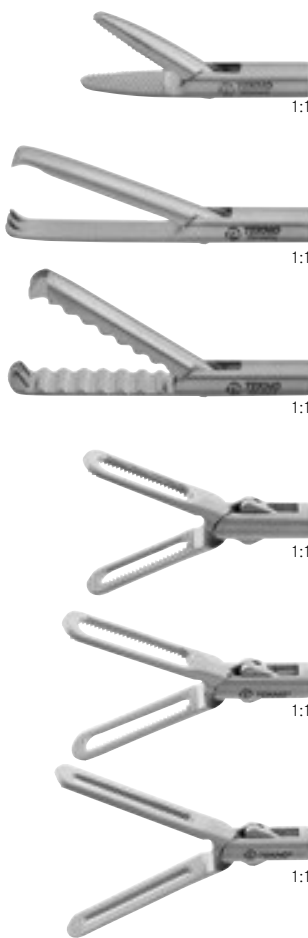

		Ø 5.0 mm	Ø 5.0 mm	Ø 5.0 mm
Needle nose Fasszange Needle nose grasping forceps	250 mm 330 mm 450 mm	tk 775-4082-25 C tk 775-4082 C tk 775-4082-45 C	tk 775-4082-25 CS tk 775-4082 CS tk 775-4082-45 CS	tk 775-4082-25 tk 775-4082 tk 775-4082-45
Pinze Needle Nose Pinza Needle Nose Pinza da presa, piatte				
Krallengreifer Claw grasping forceps	250 mm 330 mm 450 mm	tk 775-4243-25 C tk 775-4243 C tk 775-4243-45 C	tk 775-4243-25 CS tk 775-4243 CS tk 775-4243-45 CS	tk 775-4243-25 tk 775-4243 tk 775-4243-45
Pince à griffes Pinza de garras Pinza per estrazione				
Retraktionszange, atraumatisch Retraction forceps, atraumatic inner teeth	250 mm 330 mm 450 mm	tk 775-4093-25 C tk 775-4093 C tk 775-4093-45 C	tk 775-4093-25 CS tk 775-4093 CS tk 775-4093-45 CS	tk 775-4093-25 tk 775-4093 tk 775-4093-45
Retractor atraumatico Retractor atraumatico Pinza per estrazione				
JOHAN, 17mm, gezahntes Maul, doppelbeweglich JOHAN, 17mm, serrated jaws, double action	250 mm 330 mm 450 mm	tk 775-4119-25 C tk 775-4119 C tk 775-4119-45 C	tk 775-4119-25 CS tk 775-4119 CS tk 775-4119-45 CS	tk 775-4119-25 tk 775-4119 tk 775-4119-45
JOHAN, 17mm, mors dentelee, double action JOHAN, 17mm, estriada boca, doble acción JOHAN, 17mm, morso zigrinato, doppia azione				
JOHAN, 20mm, gezahntes Maul, doppelbeweglich JOHAN, 20mm, serrated jaws, double action	250 mm 330 mm 450 mm	tk 775-4120-25 C tk 775-4120 C tk 775-4120-45 C	tk 775-4120-25 CS tk 775-4120 CS tk 775-4120-45 CS	tk 775-4120-25 tk 775-4120 tk 775-4120-45
JOHAN, 20mm, mors dentelee, double action JOHAN, 20mm, estriada boca, doble acción JOHAN, 20mm, morso zigrinato, doppia azione				
JOHAN, 25mm, gezahntes Maul, doppelbeweglich JOHAN, 25mm, serrated jaws, double action	250 mm 330 mm 450 mm	tk 775-4121-25 C tk 775-4121 C tk 775-4121-45 C	tk 775-4121-25 CS tk 775-4121 CS tk 775-4121-45 CS	tk 775-4121-25 tk 775-4121 tk 775-4121-45
JOHAN, 25mm, mors dentelee, double action JOHAN, 25mm, estriada boca, doble acción JOHAN, 25mm, morso zigrinato, doppia azione				

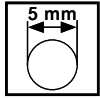

Fasszangen, zerlegbar
Grasping forceps, detachable









Pincés à saisir, démontables
Pinzas de agarre, desmontables
Pinze da presa, smontabili



ohne Sperre <i>without ratchet</i> sans crémaillère <i>sin cremallera</i> senza cremagliera	mit Sperre <i>with ratchet</i> avec crémaillère <i>con cremallera</i> con cremagliera	Einsatz allein <i>Insert only</i> Insert seul <i>Inserto solo</i> Inserto, solo
--	--	--

TEKNOLINE

6

		Ø 5.0 mm	Ø 5.0 mm	Ø 5.0 mm	
 1:1	DUCKBILL Fasszange <i>DUCKBILL grasping forceps,</i> DUCKBILL pince, <i>DUCKBILL pinza,</i> DUCKBILL pinza da presa	250 mm 330 mm 450 mm	tk 775-4095-25 C tk 775-4095 C tk 775-4095-45 C	tk 775-4095-25 CS tk 775-4095 CS tk 775-4095-45 CS	tk 775-4095-25 tk 775-4095 tk 775-4095-45
 1:1	Fasszange, gerieft <i>Grasping forceps, serrated</i> Pince strié <i>Pinza estriada</i> Pinza da presa zigrinata	250 mm 330 mm 450 mm	tk 775-4036-25 C tk 775-4036 C tk 775-4036-45 C	tk 775-4036-25 CS tk 775-4036 CS tk 775-4036-45 CS	tk 775-4036-25 tk 775-4036 tk 775-4036-45
 1:1	Fasszange, gerieft <i>Grasping forceps, serrated</i> Pince strié <i>Pinza estriada</i> Pinza da presa zigrinata	250 mm 330 mm 450 mm	tk 775-4067-25 C tk 775-4067 C tk 775-4067-45 C	tk 775-4067-25 CS tk 775-4067 CS tk 775-4067-45 CS	tk 775-4067-25 tk 775-4067 tk 775-4067-45
 1:1	KELLY Fasszange <i>KELLY grasping forceps</i> KELLY, pince à saisir <i>KELLY, pinza de agarre</i> KELLY, pinza da presa	250 mm 330 mm 450 mm	tk 775-4094-25 C tk 775-4094 C tk 775-4094-45 C	tk 775-4094-25 CS tk 775-4094 CS tk 775-4094-45 CS	tk 775-4094-25 tk 775-4094 tk 775-4094-45
 1:1	Fasszange mit Reservoir, spitz <i>Grasping forceps with cup, pointed</i> Pince avec cuillère, pointu <i>Pinza con cuchara, aguda</i> Pinza da presa con cucchiaio, acuta	250 mm 330 mm 450 mm	tk 775-4063-25 C tk 775-4063 C tk 775-4063-45 C	tk 775-4063-25 CS tk 775-4063 CS tk 775-4063-45 CS	tk 775-4063-25 tk 775-4063 tk 775-4063-45
 1:1	Fasszange mit Reservoir <i>Grasping forceps with cup</i> Pince avec cuillère <i>Pinza con cuchara</i> Pinza da presa con cucchiaio	250 mm 330 mm 450 mm	tk 775-4038-25 C tk 775-4038 C tk 775-4038-45 C	tk 775-4038-25 CS tk 775-4038 CS tk 775-4038-45 CS	tk 775-4038-25 tk 775-4038 tk 775-4038-45
 1:1	Fasszange mit Delphin Nase, kurz <i>Dolphin-nose forceps, short</i> Pince à nez du dauphin, court <i>Pinza nariz de delfin, corta</i> Pinza da presa forma naso di delfino, corta	250 mm 330 mm 450 mm	tk 775-4037-25 C tk 775-4037 C tk 775-4037-45 C	tk 775-4037-25 CS tk 775-4037 CS tk 775-4037-45 CS	tk 775-4037-25 tk 775-4037 tk 775-4037-45
 1:1	Fasszange gebogen <i>Grasping forceps, curved</i> Pince, courbe <i>Pinza, curva</i> Pinza da presa, curva	250 mm 330 mm 450 mm	tk 775-4080-25 C tk 775-4080 C tk 775-4080-45 C	tk 775-4080-25 CS tk 775-4080 CS tk 775-4080-45 CS	tk 775-4080-25 tk 775-4080 tk 775-4080-45

Fasszangen, zerlegbar
Grasping forceps, detachable

Pincès à saisir, démontables
Pinzas de agarre, desmontables
Pinze da presa, smontabili

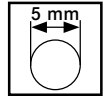









ohne Sperre
without ratchet
sans crémaillère
sin cremallera
senza cremagliera

mit Sperre
with ratchet
avec crémaillère
con cremallera
con cremagliera

Einsatz allein
Insert only
Insert seul
Inserto solo
Inserto, solo

TEKNOLINE

		Ø 5.0 mm	Ø 5.0 mm	Ø 5.0 mm
	Fasszange, gerieft Grasping forceps, serrated	250 mm	tk 775-4225-25 C	tk 775-4225-25 CS
	Pince strié	330 mm	tk 775-4225 C	tk 775-4225 CS
	Pinza estriada	450 mm	tk 775-4225-45 C	tk 775-4225-45 CS
	Multiple Fasszange Multiple grasping forceps	250 mm	tk 775-4090-25 C	tk 775-4090-25 CS
	Pince strié, multiple	330 mm	tk 775-4090 C	tk 775-4090 CS
	Pinza estriada, multiple	450 mm	tk 775-4090-45 C	tk 775-4090-45 CS
	Fasszange glatt Forceps smooth	250 mm	tk 775-4035-25 C	tk 775-4035-25 CS
	Pince lisse	330 mm	tk 775-4035 C	tk 775-4035 CS
	Pinza lisa	450 mm	tk 775-4035-45 C	tk 775-4035-45 CS
	FUNDUS Fasszange mit Zähnen FUNDUS grasping forceps with teeth	250 mm	tk 775-4074-25 C	tk 775-4074-25 CS
	FUNDUS pince, dentelé	330 mm	tk 775-4074 C	tk 775-4074 CS
	FUNDUS pinza, dentada	450 mm	tk 775-4074-45 C	tk 775-4074-45 CS
	Fasszange, lang Grasping forceps, long	250 mm	tk 775-4076-25 C	tk 775-4076-25 CS
	Mors longue	330 mm	tk 775-4076 C	tk 775-4076 CS
	Boca larga	450 mm	tk 775-4076-45 C	tk 775-4076-45 CS
	Mini Fasszange, gefenstert Mini grasping forceps, fenestrated	250 mm	tk 775-4079-25 C	tk 775-4079-25 CS
	Mors mini, fenêtré	330 mm	tk 775-4079 C	tk 775-4079 CS
	Boca mini, fenestrada	450 mm	tk 775-4079-45 C	tk 775-4079-45 CS
	Fasszange gerieft, gefenstert Grasping forceps, serrated with window	250 mm	tk 775-4068-25 C	tk 775-4068-25 CS
	Mors strié, fenêtré	330 mm	tk 775-4068 C	tk 775-4068 CS
	Boca estriada, fenestrada	450 mm	tk 775-4068-45 C	tk 775-4068-45 CS
	Fasszange mit starker Zahnung Grasping forceps, strong teeth	250 mm	tk 775-4081-25 C	tk 775-4081-25 CS
	Mors fortement strié	330 mm	tk 775-4081 C	tk 775-4081 CS
	Boca fuertemente estriada	450 mm	tk 775-4081-45 C	tk 775-4081-45 CS
	Pinza da presa con dentatura robusta			

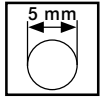

Fasszangen, zerlegbar
Grasping forceps, detachable

Pincès à saisir, démontables
Pinzas de agarre, desmontables
Pinze da presa, smontabili











ohne Sperre
without ratchet
sans crémaillère
sin cremallera
senza cremagliera

mit Sperre
with ratchet
avec crémaillère
con cremallera
con cremagliera

Einsatz allein
Insert only
Insert seul
Inserto solo
Inserto, solo

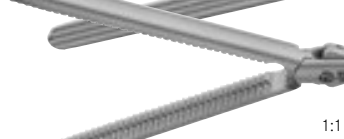
TEKNOLINE

		Ø 5.0 mm	Ø 5.0 mm	Ø 5.0 mm
	DEBAKEY, atraumatisch, 20 mm lang DEBAKEY, atraumatic, 20mm jaw length	250 mm	tk 775-4099-25 C	tk 775-4099-25 CS
	DEBAKEY, atraumatique, 20 mm	330 mm	tk 775-4099 C	tk 775-4099 CS
	DEBAKEY, atraumatica, 20 mm	450 mm	tk 775-4099-45 C	tk 775-4099-45 CS
	DEBAKEY, atraumatisch, 30 mm lang DEBAKEY, atraumatic, 30mm jaw length	250 mm	tk 775-4100-25 C	tk 775-4100-25 CS
	DEBAKEY, atraumatique, 30 mm	330 mm	tk 775-4100 C	tk 775-4100 CS
	DEBAKEY, atraumatica, 30 mm	450 mm	tk 775-4100-45 C	tk 775-4100-45 CS
	DEBAKEY, atraumatisch, 40 mm lang DEBAKEY, atraumatic, 40mm jaw length	250 mm	tk 775-4101-25 C	tk 775-4101-25 CS
	DEBAKEY, atraumatique, 40 mm	330 mm	tk 775-4101 C	tk 775-4101 CS
	DEBAKEY, atraumatica, 40 mm	450 mm	tk 775-4101-45 C	tk 775-4101-45 CS
	DEBAKEY, atraumatisch, 50 mm lang DEBAKEY, atraumatic, 50mm jaw length	250 mm	tk 775-4249-25 C	tk 775-4249-25 CS
	DEBAKEY, atraumatique, 50 mm	330 mm	tk 775-4249 C	tk 775-4249 CS
	DEBAKEY, atraumatica, 50 mm	450 mm	tk 775-4249-45 C	tk 775-4249-45 CS
	KOCHER, längs gerieft, 40 mm lang KOCHER, lengthwise serrated, 40mm length	250 mm	tk 775-4236-25 C	tk 775-4236-25 CS
	KOCHER, strié le long du mors, 40mm	330 mm	tk 775-4236 C	tk 775-4236 CS
	KOCHER, estriada lo larga de la boca, 40mm	450 mm	tk 775-4236-45 C	tk 775-4236-45 CS
	KOCHER, längs gerieft, 60 mm lang KOCHER, lengthwise serrated, 60mm length	250 mm	tk 775-4235-25 C	tk 775-4235-25 CS
	KOCHER, strié le long du mors, 60mm	330 mm	tk 775-4235 C	tk 775-4235 CS
	KOCHER, estriada lo larga de la boca, 60mm	450 mm	tk 775-4235-45 C	tk 775-4235-45 CS
	Starke Fasszange, atraumatisch Strong grasping forceps, atraumatic	250 mm	tk 775-4232-25 C	tk 775-4232-25 CS
	Pince forte, atraumatique	330 mm	tk 775-4232 C	tk 775-4232 CS
	Pinza fuerte, atraumatica	450 mm	tk 775-4232-45 C	tk 775-4232-45 CS
	GLASSMANN, Fasszange, atraumatisch GLASSMANN, grasping forceps, atraumatic	250 mm	tk 775-4091-25 C	tk 775-4091-25 CS
	GLASSMANN, atraumatique	330 mm	tk 775-4091 C	tk 775-4091 CS
	GLASSMANN, atraumatica	450 mm	tk 775-4091-45 C	tk 775-4091-45 CS
	GLASSMANN, pinza da presa atraumatica			

6

Fasszangen, zerlegbar
Grasping forceps, detachable

Pincés à saisir, démontables
Pinzas de agarre, desmontables
Pinze da presa, smontabili

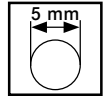







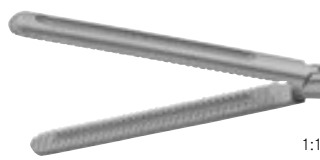

ohne Sperre
without ratchet
sans crémaillère
sin cremallera
senza cremagliera

mit Sperre
with ratchet
avec crémaillère
con cremallera
con cremagliera

Einsatz allein
Insert only
Insert seul
Inserto solo
Inserto, solo

TEKNOLINE

		Ø 5.0 mm	Ø 5.0 mm	Ø 5.0 mm			
 <p>1:1</p>	FUNDUS Fasszange <i>FUNDUS grasping forceps</i> FUNDUS, pince à saisir <i>FUNDUS, pinza de agarre</i> FUNDUS, pinza da presa	250 mm 330 mm 450 mm	tk 775-4073-25 C tk 775-4073 C tk 775-4073-45 C	tk 775-4073-25 CS tk 775-4073 CS tk 775-4073-45 CS	tk 775-4073-25 tk 775-4073 tk 775-4073-45		
	 <p>1:1</p>	Fasszange gewellt, mit Löffel <i>Grasping forceps, waved with pocket</i> Mors ondulé, avec cuillère <i>Boca ondulada, con cuchara</i> Pinza da presa ondulata, con cucchiaio	250 mm 330 mm 450 mm	tk 775-4072-25 C tk 775-4072 C tk 775-4072-45 C	tk 775-4072-25 CS tk 775-4072 CS tk 775-4072-45 CS	tk 775-4072-25 tk 775-4072 tk 775-4072-45	
		 <p>1:1</p>	ENDO CLINCH, atraumatich gezahnt <i>ENDO CLINCH, atraumatic serrated</i> ENDO CLINCH, atraumatique, dentelé <i>ENDO CLINCH, atraumatica, dentada</i> ENDO CLINCH, atraumatica dentata	250 mm 330 mm 450 mm	tk 775-4089-25 C tk 775-4089 C tk 775-4089-45 C	tk 775-4089-25 CS tk 775-4089 CS tk 775-4089-45 CS	tk 775-4089-25 tk 775-4089 tk 775-4089-45
			 <p>1:1</p>	ENDO CLINCH, atraumatich gezahnt, fein <i>ENDO CLINCH, atraumatic serrated, fein</i> ENDO CLINCH, atraumatique, dentelé, fin <i>ENDO CLINCH, atraumatica, dentada, fina</i> ENDO CLINCH, atraumatica dentata, fine	250 mm 330 mm 450 mm	tk 775-4053-25 C tk 775-4053 C tk 775-4053-45 C	tk 775-4053-25 CS tk 775-4053 CS tk 775-4053-45 CS
 <p>1:1</p>	Fasszange, 2x4 gezahnt <i>Grasping forceps, 2x4 teeth</i> Pince à saisir, 2x4 dents <i>Pinza de agarre, 2x4 dientes</i> Pinza da presa, 2x4 denti			250 mm 330 mm 450 mm	tk 775-4065-25 C tk 775-4065 C tk 775-4065-45 C	tk 775-4065-25 CS tk 775-4065 CS tk 775-4065-45 CS	tk 775-4065-25 tk 775-4065 tk 775-4065-45
	 <p>1:1</p>	Fasszange mit 4x5 Zähnen, glatt <i>Grasping forceps, 4x5 teeth, smooth</i> Pince à saisir, 4x5 dents, lisse <i>Pinza de agarre, 4x5 dientes, lisa</i> Pinza da presa, 4x5 denti, liscia		250 mm 330 mm 450 mm	tk 775-4078-25 C tk 775-4078 C tk 775-4078-45 C	tk 775-4078-25 CS tk 775-4078 CS tk 775-4078-45 CS	tk 775-4078-25 tk 775-4078 tk 775-4078-45
		 <p>1:1</p>	SCHROEDER Hakenzange, 1x1 Zähne, scharf <i>SCHROEDER, hook forceps, sharp teeth</i> SCHROEDER, pince à crochet, pointue <i>SCHROEDER, pinza de gancho, aguda</i> SCHROEDER pinza ad uncino, 1x1 denti, acuta	250 mm 330 mm 450 mm	tk 775-4244-25 C tk 775-4244 C tk 775-4244-45 C	tk 775-4244-25 CS tk 775-4244 CS tk 775-4244-45 CS	tk 775-4244-25 tk 775-4244 tk 775-4244-45
 <p>1:1</p>			Knotenschnürer <i>Knot tier</i> Pince pousse noeuds <i>Pinza baja nudo</i> Pinza spingi nodo	250 mm 330 mm 450 mm	tk 704-109-25 C tk 704-109 C tk 704-109-45 C	tk 704-109-25 CS tk 704-109 CS tk 704-109-45 CS	tk 704-109-25 tk 704-109 tk 704-109-45

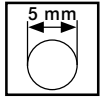

Fasszangen, zerlegbar
Grasping forceps, detachable

Pincès à saisir, démontables
Pinzas de agarre, desmontables
Pinze da presa, smontabili









ohne Sperre
without ratchet
sans crémaillère
sin cremallera
senza cremagliera

mit Sperre
with ratchet
avec crémaillère
con cremallera
con cremagliera

Einsatz allein
Insert only
Insert seul
Inserto solo
Inserto, solo

TEKNOLINE

6

		Ø 5.0 mm	Ø 5.0 mm	Ø 5.0 mm	
 <p>1:1</p>	Fasszange, atraumatisch, spitz <i>Grasping forceps pointed, atraumatic</i>	250 mm	tk 775-4064-25 C	tk 775-4064-25 CS	tk 775-4064-25
	Pincès à saisir, atraumatique, pointu	330 mm	tk 775-4064 C	tk 775-4064 CS	tk 775-4064
	Pinza de agarre, atraumatica, aguda Pinza da prega atraumatica, acuta	450 mm	tk 775-4064-45 C	tk 775-4064-45 CS	tk 775-4064-45
 <p>1:1</p>	MARYLAND Fasszange, grob gerieft, gebogen <i>MARYLAND coarse serrated, curved</i>	250 mm	tk 775-4069-25 C	tk 775-4069-25 CS	tk 775-4069-25
	MARYLAND, strié fort, courbe	330 mm	tk 775-4069 C	tk 775-4069 CS	tk 775-4069
	MARYLAND, estriada fuerte, curva MARYLAND, zigrinatura larga, curva	450 mm	tk 775-4069-45 C	tk 775-4069-45 CS	tk 775-4069-45
 <p>1:1</p>	MARYLAND Fasszange, fein gerieft, gebogen <i>MARYLAND grasping forceps, fine serrated</i>	250 mm	tk 775-4021-25 C	tk 775-4021-25 CS	tk 775-4021-25
	MARYLAND, strié fin	330 mm	tk 775-4021 C	tk 775-4021 CS	tk 775-4021
	MARYLAND, estriada fina MARYLAND, pinza da presa, zigrinatura fine	450 mm	tk 775-4021-45 C	tk 775-4021-45 CS	tk 775-4021-45
 <p>1:1</p>	MARYLAND, kreuzgerieft <i>MARYLAND, cross serrated</i>	250 mm	tk 775-4075-25 C	tk 775-4075-25 CS	tk 775-4075-25
	MARYLAND, strié en cruciforme	330 mm	tk 775-4075 C	tk 775-4075 CS	tk 775-4075
	MARYLAND, estriada en cruciforma MARYLAND, zigrinatura a croce	450 mm	tk 775-4075-45 C	tk 775-4075-45 CS	tk 775-4075-45
 <p>1:1</p>	MARYLAND, DEBAKEY, gebogen <i>MARYLAND, DEBAKEY, curved</i>	250 mm	tk 775-4088-25 C	tk 775-4088-25 CS	tk 775-4088-25
	MARYLAND, DEBAKEY, courbe	330 mm	tk 775-4088 C	tk 775-4088 CS	tk 775-4088
	MARYLAND, DEBAKEY, curva MARYLAND, DEBAKEY, curva	450 mm	tk 775-4088-45 C	tk 775-4088-45 CS	tk 775-4088-45
 <p>1:1</p>	MIXTER Fasszange, 45° gewinkelt <i>MIXTER grasping forceps, 45° angled</i>	250 mm	tk 775-4228-25 C	tk 775-4228-25 CS	tk 775-4228-25
	MIXTER, 45° angulé	330 mm	tk 775-4228 C	tk 775-4228 CS	tk 775-4228
	MIXTER, 45° angulada MIXTER, pinza da presa angolata a 45°	450 mm	tk 775-4228-45 C	tk 775-4228-45 CS	tk 775-4228-45
 <p>1:1</p>	MIXTER Fasszange, 45° gebogen <i>MIXTER grasping forceps, 45° curved</i>	250 mm	tk 775-4222-25 C	tk 775-4222-25 CS	tk 775-4222-25
	MIXTER, 45° courbé	330 mm	tk 775-4222 C	tk 775-4222 CS	tk 775-4222
	MIXTER, 45° curvada MIXTER, pinza da presa curva a 45°	450 mm	tk 775-4222-45 C	tk 775-4222-45 CS	tk 775-4222-45

Fasszangen, zerlegbar
Grasping forceps, detachable

Pincès à saisir, démontables
Pinzas de agarre, desmontables
Pinze da presa, smontabili

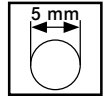

ohne Sperre
without ratchet

sans crémaillère
sin cremallera
senza cremagliera



mit Sperre
with ratchet

avec crémaillère
con cremallera
con cremagliera

Einsatz allein
Insert only

Insert seul
Inserto solo
Inserto, solo

TEKNOLINE

		Ø 5.0 mm	Ø 5.0 mm	Ø 5.0 mm
 <p>MIXTER Fasszange, 90° gewinkelt MIXTER grasping forceps, 90° angled</p>	250 mm	tk 775-4092-25 C	tk 775-4092-25 CS	tk 775-4092-25
	330 mm	tk 775-4092 C	tk 775-4092 CS	tk 775-4092
	450 mm	tk 775-4092-45 C	tk 775-4092-45 CS	tk 775-4092-45
 <p>COLLIN Fasszange COLLIN grasping forceps</p>	250 mm	tk 775-4246-25 C	tk 775-4246-25 CS	tk 775-4246-25
	330 mm	tk 775-4246 C	tk 775-4246 CS	tk 775-4246
	450 mm	tk 775-4246-45 C	tk 775-4246-45 CS	tk 775-4246-45
 <p>DUVAL, Fasszange DUVAL grasping forceps</p>	250 mm	tk 775-4233-25 C	tk 775-4233-25 CS	tk 775-4233-25
	330 mm	tk 775-4233 C	tk 775-4233 CS	tk 775-4233
	450 mm	tk 775-4233-45 C	tk 775-4233-45 CS	tk 775-4233-45
 <p>TC-COLLIN Fasszange, kreuzgerieft TC-COLLIN grasping forceps, cross serrated</p>	250 mm	tk 775-4234-25 C	tk 775-4234-25 CS	tk 775-4234-25
	330 mm	tk 775-4234 C	tk 775-4234 CS	tk 775-4234
	450 mm	tk 775-4234-45 C	tk 775-4234-45 CS	tk 775-4234-45
 <p>PENNINGTON Fasszange PENNINGTON grasping forceps</p>	250 mm	tk 775-4224-25 C	tk 775-4224-25 CS	tk 775-4224-25
	330 mm	tk 775-4224 C	tk 775-4224 CS	tk 775-4224
	450 mm	tk 775-4224-45 C	tk 775-4224-45 CS	tk 775-4224-45
 <p>BABCOCK Fasszange BABCOCK-forceps</p>	250 mm	tk 775-4098-25 C	tk 775-4098-25 CS	tk 775-4098-25
	330 mm	tk 775-4098 C	tk 775-4098 CS	tk 775-4098
	450 mm	tk 775-4098-45 C	tk 775-4098-45 CS	tk 775-4098-45
 <p>ALLIS Fasszange ALLIS grasping forceps</p>	250 mm	tk 775-4229-25 C	tk 775-4229-25 CS	tk 775-4229-25
	330 mm	tk 775-4229 C	tk 775-4229 CS	tk 775-4229
	450 mm	tk 775-4229-45 C	tk 775-4229-45 CS	tk 775-4229-45

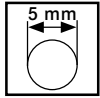

Fasszangen, zerlegbar
Grasping forceps, detachable

Pinces à saisir, démontables
Pinzas de agarre, desmontables
Pinze da presa, smontabili



ohne Sperre
without ratchet

sans crémaillère
sin cremallera
senza cremagliera

mit Sperre
with ratchet

avec crémaillère
con cremallera
con cremagliera

Einsatz allein
Insert only

Insert seul
Inserto solo
Inserto, solo

TEKNOLINE

6



		Ø 5.0 mm	Ø 5.0 mm	Ø 5.0 mm
ALLIS Fasszange, kreuzgerieft ALLIS grasping forceps, cross serrated	250 mm	tk 775-4070-25 C	tk 775-4070-25 CS	tk 775-4070-25
ALLIS pince à saisir, strié transversal	330 mm	tk 775-4070 C	tk 775-4070 CS	tk 775-4070
ALLIS pinza de agarre, estriada transversal	450 mm	tk 775-4070-45 C	tk 775-4070-45 CS	tk 775-4070-45
ALLIS pinza da presa, zigrinata a croce				
DEBAKEY Fasszange, atraumatisch DEBAKEY grasping forceps, atraumatic	250 mm	tk 775-4226-25 C	tk 775-4226-25 CS	tk 775-4226-25
DEBAKEY, atraumatique	330 mm	tk 775-4226 C	tk 775-4226 CS	tk 775-4226
DEBAKEY, atraumatica	450 mm	tk 775-4226-45 C	tk 775-4226-45 CS	tk 775-4226-45
DEBAKEY pinza da presa atraumatica				
ALLIS Fasszange, längsgezahnt ALLIS grasping forceps, lengthwise serrated	250 mm	tk 775-4071-25 C	tk 775-4071-25 CS	tk 775-4071-25
ALLIS pince à saisir, strié longitudinal	330 mm	tk 775-4071 C	tk 775-4071 CS	tk 775-4071
ALLIS pinza de agarre, estriada longitudinal	450 mm	tk 775-4071-45 C	tk 775-4071-45 CS	tk 775-4071-45
ALLIS pinza da presa, zigrinata longitudinale				
TENACULUM Hakenzange, scharf TENACULUM forceps, sharp	250 mm	tk 775-4253-25 C	tk 775-4253-25 CS	tk 775-4253-25
TENACULUM, pince à crochet, pointue	330 mm	tk 775-4253 C	tk 775-4253 CS	tk 775-4253
TENACULUM, pinza de gancho, aguda	450 mm	tk 775-4253-45 C	tk 775-4253-45 CS	tk 775-4253-45
TENACULUM pinza ad uncino, acuta				

Biopsiezangen, zerlegbar
Biopsy forceps, detachable

Pincés à biopsie, démontables
Pinzas de biopsia, desmontables
 Pinze per biopsia, smontabili

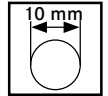







ohne Sperre
without ratchet
 sans crémaillère
sin cremallera
 senza cremagliera

mit Sperre
with ratchet
 avec crémaillère
con cremallera
 con cremagliera

Einsatz allein
Insert only
 Insert seul
Inserto solo
 Inserto, solo

TEKNOLINE

		Ø 10.0 mm	Ø 10.0 mm	Ø 10.0 mm
 1:2 Biopsie Stanze <i>Biopsy forceps</i> Pince à biopsie <i>Pinza de biopsia</i> Pinze per biopsia	250 mm	tk 775-5050-25 C	tk 775-5050-25 CS	tk 775-5050-25
	330 mm	tk 775-5050 C	tk 775-5050 CS	tk 775-5050
	450 mm	tk 775-5050-45 C	tk 775-5050-45 CS	tk 775-5050-45
 1:2 Biopsie Stanze, durchschneidend <i>Biopsy forceps, through cutting</i> Pince à biopsie, coupante <i>Pinza de biopsia, cortante</i> Pinze per biopsia, taglienti	250 mm	tk 775-5054-25 C	tk 775-5054-25 CS	tk 775-5054-25
	330 mm	tk 775-5054 C	tk 775-5054 CS	tk 775-5054
	450 mm	tk 775-5054-45 C	tk 775-5054-45 CS	tk 775-5054-45
 1:2 Biopsie Stanze <i>Biopsy forceps</i> Pince à biopsie <i>Pinza de biopsia</i> Pinze per biopsia	250 mm	tk 775-5053-25 C	tk 775-5053-25 CS	tk 775-5053-25
	330 mm	tk 775-5053 C	tk 775-5053 CS	tk 775-5053
	450 mm	tk 775-5053-45 C	tk 775-5053-45 CS	tk 775-5053-45
 1:2 Biopsie Stanze mit Zahn <i>Biopsy forceps with tooth</i> Pince à biopsie, avec dent <i>Pinza de biopsia, con diente</i> Pinze per biopsia, con dente	250 mm	tk 775-5052-25 C	tk 775-5052-25 CS	tk 775-5052-25
	330 mm	tk 775-5052 C	tk 775-5052 CS	tk 775-5052
	450 mm	tk 775-5052-45 C	tk 775-5052-45 CS	tk 775-5052-45
 1:2 Löffelzange <i>Spoon-forceps</i> Pince à cuillère <i>Pinza de cuchara</i> Pinza a cucchiaio	250 mm	tk 775-5045-25 C	tk 775-5045-25 CS	tk 775-5045-25
	330 mm	tk 775-5045 C	tk 775-5045 CS	tk 775-5045
	450 mm	tk 775-5045-45 C	tk 775-5045-45 CS	tk 775-5045-45
 1:2 Alligator-Biopsie-Fasszange <i>Alligator-biopsy-forceps</i> Pince à biopsie, crocodile <i>Pinza de biopsia, cocodrilo</i> Pinza da presa, morso alligatore	250 mm	tk 775-5066-25 C	tk 775-5066-25 CS	tk 775-5066-25
	330 mm	tk 775-5066 C	tk 775-5066 CS	tk 775-5066
	450 mm	tk 775-5066-45 C	tk 775-5066-45 CS	tk 775-5066-45



Fasszangen, zerlegbar
Grasping forceps, detachable

Pincès à saisir, démontables
Pinzas de agarre, desmontables
Pinze da presa, smontabili



ohne Sperre
without ratchet
sans crémaillère
sin cremallera
senza cremagliera

mit Sperre
with ratchet
avec crémaillère
con cremallera
con cremagliera

Einsatz allein
Insert only
Insert seul
Inserto solo
Inserto, solo

TEKNOLINE

6



1:2

PETELIN Dissektor, leicht gebogen
PETELIN dissecting forceps, slightly curved
250 mm
330 mm
450 mm
PETELIN disecteur, légèrement courbé
PETELIN disetcora, ligeramente curvo
PETELIN pinza per dissezione corta, leggermente curva

	Ø 10.0 mm	Ø 10.0 mm	Ø 10.0 mm
	tk 775-5084-25 C	tk 775-5084-25 CS	tk 775-5084-25
	tk 775-5084 C	tk 775-5084 CS	tk 775-5084
	tk 775-5084-45 C	tk 775-5084-45 CS	tk 775-5084-45



1:2

PETELIN Dissektor, stark gebogen
PETELIN dissecting forceps, strong curved
250 mm
330 mm
450 mm
PETELIN disecteur, fortement courbé
PETELIN disetcora, fuertemente curva
PETELIN pinza per dissezione corta, fortemente curva

	tk 775-5083-25 C	tk 775-5083-25 CS	tk 775-5083-25
	tk 775-5083 C	tk 775-5083 CS	tk 775-5083
	tk 775-5083-45 C	tk 775-5083-45 CS	tk 775-5083-45



1:2

JOHAN, 20 mm, gezahntes Maul
JOHAN, 20 mm, serrated jaws
250 mm
330 mm
450 mm
JOHAN, 20mm, dentelée
JOHAN, 20mm, dentada
JOHAN, 20 mm, morso zigrinato

	tk 775-5096-25 C	tk 775-5096-25 CS	tk 775-5096-25
	tk 775-5096 C	tk 775-5096 CS	tk 775-5096
	tk 775-5096-45 C	tk 775-5096-45 CS	tk 775-5096-45



1:2

JOHAN 45 mm, gezahntes Maul
JOHAN 45 mm, serrated jaws
250 mm
330 mm
450 mm
JOHAN, 45mm, dentelée
JOHAN, 45mm, dentada
JOHAN, 45 mm, morso zigrinato

	tk 775-5097-25 C	tk 775-5097-25 CS	tk 775-5097-25
	tk 775-5097 C	tk 775-5097 CS	tk 775-5097
	tk 775-5097-45 C	tk 775-5097-45 CS	tk 775-5097-45



1:2

KOCHER Fasszange, 2x1 Zähne
KOCHER Grasping forceps, 2x1 teeth
250 mm
330 mm
450 mm
KOCHER pince, 2 x 1 dents
KOCHER pinza, 2 x 1 dientes
KOCHER pinza da presa, 2x1 denti

	tk 775-5087-25 C	tk 775-5087-25 CS	tk 775-5087-25
	tk 775-5087 C	tk 775-5087 CS	tk 775-5087
	tk 775-5087-45 C	tk 775-5087-45 CS	tk 775-5087-45

Fasszangen, zerlegbar
Grasping forceps, detachable

Pincés à saisir, démontables
Pinzas de agarre, desmontables
Pinze da presa, smontabili

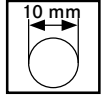



ohne Sperre
without ratchet
sans crémaillère
sin cremallera
senza cremagliera

mit Sperre
with ratchet
avec crémaillère
con cremallera
con cremagliera

Einsatz allein
Insert only
Insert seul
Inserto solo
Inserto, solo

TEKNOLINE

		Ø 10.0 mm	Ø 10.0 mm	Ø 10.0 mm
 1:2 Krallengreifer <i>Claw grasping forceps</i> Pince à griffes Pinza de garras Pinza per estrazione	250 mm	tk 775-5043-25 C	tk 775-5043-25 CS	tk 775-5043-25
	330 mm	tk 775-5043 C	tk 775-5043 CS	tk 775-5043
	450 mm	tk 775-5043-45 C	tk 775-5043-45 CS	tk 775-5043-45
 1:2 Retraktionszange, atraumatisch <i>Retraction forceps, atraumatic</i> Retracteur atraumatique Retractor atraumatico Pinza per estrazione, atraumatica	250 mm	tk 775-5093-25 C	tk 775-5093-25 CS	tk 775-5093-25
	330 mm	tk 775-5093 C	tk 775-5093 CS	tk 775-5093
	450 mm	tk 775-5093-45 C	tk 775-5093-45 CS	tk 775-5093-45



Fasszangen, zerlegbar
Grasping forceps, detachable

Pincès à saisir, démontables
Pinzas de agarre, desmontables
Pinze da presa, smontabili



ohne Sperre
without ratchet

sans crémaillère
sin cremallera
senza cremagliera

mit Sperre
with ratchet

avec crémaillère
con cremallera
con cremagliera

Einsatz allein
Insert only

Inserto solo
Inserto, solo

TEKNOLINE

		Ø 10.0 mm	Ø 10.0 mm	Ø 10.0 mm
 1:2 Fasszange, gerieft <i>Grasping forceps, serrated</i> Pince strié <i>Pinza estriada</i> Pinza da presa zigrinata	250 mm	tk 775-5056-25 C	tk 775-5056-25 CS	tk 775-5056-25
	330 mm	tk 775-5056 C	tk 775-5056 CS	tk 775-5056
	450 mm	tk 775-5056-45 C	tk 775-5056-45 CS	tk 775-5056-45
 1:2 Fasszange, gerieft <i>Grasping forceps, serrated</i> Pince strié <i>Pinza estriada</i> Pinza da presa zigrinata	250 mm	tk 775-5067-25 C	tk 775-5067-25 CS	tk 775-5067-25
	330 mm	tk 775-5067 C	tk 775-5067 CS	tk 775-5067
	450 mm	tk 775-5067-45 C	tk 775-5067-45 CS	tk 775-5067-45
 1:2 KELLY Fasszange <i>KELLY grasping forceps</i> KELLY, pince à saisir <i>KELLY, pinza de agarre</i> KELLY, pinza da presa	250 mm	tk 775-5094-25 C	tk 775-5094-25 CS	tk 775-5094-25
	330 mm	tk 775-5094 C	tk 775-5094 CS	tk 775-5094
	450 mm	tk 775-5094-45 C	tk 775-5094-45 CS	tk 775-5094-45
 1:2 Fasszange mit Reservoir <i>Grasping forceps with cup</i> Pince avec cuillère <i>Pinza con cuchara</i> Pinza da presa con cucchiaio	250 mm	tk 775-5058-25 C	tk 775-5058-25 CS	tk 775-5058-25
	330 mm	tk 775-5058 C	tk 775-5058 CS	tk 775-5058
	450 mm	tk 775-5058-45 C	tk 775-5058-45 CS	tk 775-5058-45

Fasszangen, zerlegbar
Grasping forceps, detachable

Pincés à saisir, démontables
Pinzas de agarre, desmontables
Pinze da presa, smontabili

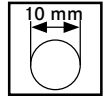









ohne Sperre
without ratchet
sans crémaillère
sin cremallera
senza cremagliera

mit Sperre
with ratchet
avec crémaillère
con cremallera
con cremagliera

Einsatz allein
Insert only
Insert seul
Inserto solo
Inserto, solo

TEKNOLINE

		Ø 10.0 mm	Ø 10.0 mm	Ø 10.0 mm
 1:2	Fasszange, gerieft <i>Grasping forceps, serrated</i>	250 mm	tk 775-5025-25 C	tk 775-5025-25 CS
	Pince strié	330 mm	tk 775-5025 C	tk 775-5025 CS
	<i>Pinza estriada</i>	450 mm	tk 775-5025-45 C	tk 775-5025-45 CS
	Pinza da presa zigrinata			tk 775-5025-45
 1:2	Multiple Fasszange <i>Multiple grasping forceps</i>	250 mm	tk 775-5090-25 C	tk 775-5090-25 CS
	Pince strié, multiple	330 mm	tk 775-5090 C	tk 775-5090 CS
	<i>Pinza estriada, multiple</i>	450 mm	tk 775-5090-45 C	tk 775-5090-45 CS
	Pinza da presa universale			tk 775-5090-45
 1:2	Fasszange glatt <i>Forceps smooth</i>	250 mm	tk 775-5055-25 C	tk 775-5055-25 CS
	Pince lisse	330 mm	tk 775-5055 C	tk 775-5055 CS
	<i>Pinza lisa</i>	450 mm	tk 775-5055-45 C	tk 775-5055-45 CS
	Pinza da presa, liscia			tk 775-5055-45
 1:2	FUNDUS Fasszange mit Zähnen <i>FUNDUS grasping forceps with teeth</i>	250 mm	tk 775-5074-25 C	tk 775-5074-25 CS
	FUNDUS pince, dentelé	330 mm	tk 775-5074 C	tk 775-5074 CS
	<i>FUNDUS pinza, dentada</i>	450 mm	tk 775-5074-45 C	tk 775-5074-45 CS
	FUNDUS pinza da presa con denti			tk 775-5074-45
 1:2	Fasszange, lang <i>Grasping forceps, long</i>	250 mm	tk 775-5076-25 C	tk 775-5076-25 CS
	Mors longue	330 mm	tk 775-5076 C	tk 775-5076 CS
	<i>Boca larga</i>	450 mm	tk 775-5076-45 C	tk 775-5076-45 CS
	Pinza da presa, lunga			tk 775-5076-45
 1:2	Mini Fasszange, gefenstert <i>Mini grasping forceps, fenestrated</i>	250 mm	tk 775-5079-25 C	tk 775-5079-25 CS
	Mors mini, fenêtré	330 mm	tk 775-5079 C	tk 775-5079 CS
	<i>Boca mini, fenestrada</i>	450 mm	tk 775-5079-45 C	tk 775-5079-45 CS
	Pinza da presa mini, fenestrata			tk 775-5079-45
 1:2	Fasszange gerieft, gefenstert <i>Grasping forceps, serrated with window</i>	250 mm	tk 775-5068-25 C	tk 775-5068-25 CS
	Mors strié, fenêtré	330 mm	tk 775-5068 C	tk 775-5068 CS
	<i>Boca estriada, fenestrada</i>	450 mm	tk 775-5068-45 C	tk 775-5068-45 CS
	Pinza da presa zirinata, fenestrata			tk 775-5068-45
 1:2	Fasszange mit starker Zahnung <i>Grasping forceps, strong teeth</i>	250 mm	tk 775-5081-25 C	tk 775-5081-25 CS
	Mors fortement strié	330 mm	tk 775-5081 C	tk 775-5081 CS
	<i>Boca fuertemente estriada</i>	450 mm	tk 775-5081-45 C	tk 775-5081-45 CS
	Pinza da presa con dentatura forte			tk 775-5081-45



Fasszangen, zerlegbar
Grasping forceps, detachable

Pincès à saisir, démontables
Pinzas de agarre, desmontables
Pinze da presa, smontabili



ohne Sperre
without ratchet
sans crémaillère
sin cremallera
senza cremagliera

mit Sperre
with ratchet
avec crémaillère
con cremallera
con cremagliera

Einsatz allein
Insert only
Insert seul
Inserto solo
Inserto, solo

TEKNOLINE

6

		Ø 10.0 mm	Ø 10.0 mm	Ø 10.0 mm
<p>1:2 DEBAKEY, atraumatisch, 20 mm lang DEBAKEY, atraumatic, 20mm jaw length</p>	250 mm	tk 775-5099-25 C	tk 775-5099-25 CS	tk 775-5099-25
	330 mm	tk 775-5099 C	tk 775-5099 CS	tk 775-5099
	450 mm	tk 775-5099-45 C	tk 775-5099-45 CS	tk 775-5099-45
	DEBAKEY atraumatica, morso lungo 20 mm			
<p>1:2 DEBAKEY, atraumatisch, 30 mm lang DEBAKEY, atraumatic, 30mm jaw length</p>	250 mm	tk 775-5047-25 C	tk 775-5047-25 CS	tk 775-5047-25
	330 mm	tk 775-5047 C	tk 775-5047 CS	tk 775-5047
	450 mm	tk 775-5047-45 C	tk 775-5047-45 CS	tk 775-5047-45
	DEBAKEY atraumatica, morso lungo 30 mm			
<p>1:2 DEBAKEY, atraumatisch, 40 mm lang DEBAKEY, atraumatic, 40mm jaw length</p>	250 mm	tk 775-5048-25 C	tk 775-5048-25 CS	tk 775-5048-25
	330 mm	tk 775-5048 C	tk 775-5048 CS	tk 775-5048
	450 mm	tk 775-5048-45 C	tk 775-5048-45 CS	tk 775-5048-45
	DEBAKEY atraumatica, morso lungo 40 mm			
<p>1:2 DEBAKEY, atraumatisch, 50 mm lang DEBAKEY, atraumatic, 50mm jaw length</p>	250 mm	tk 775-5049-25 C	tk 775-5049-25 CS	tk 775-5049-25
	330 mm	tk 775-5049 C	tk 775-5049 CS	tk 775-5049
	450 mm	tk 775-5049-45 C	tk 775-5049-45 CS	tk 775-5049-45
	DEBAKEY atraumatica, morso lungo 50 mm			
<p>1:2 KOCHER, längs gerieft, 40 mm lang KOCHER, lengthwise serrated, 40mm length</p>	250 mm	tk 775-5036-25 C	tk 775-5036-25 CS	tk 775-5036-25
	330 mm	tk 775-5036 C	tk 775-5036 CS	tk 775-5036
	450 mm	tk 775-5036-45 C	tk 775-5036-45 CS	tk 775-5036-45
	KOCHER, strié le long du mors, 40mm KOCHER, estriada lo larga de la boca, 40mm KOCHER, zigrinatura longitudinale, 40 mm			
<p>1:2 KOCHER, längs gerieft, 60 mm lang KOCHER, lengthwise serrated, 60mm length</p>	250 mm	tk 775-5035-25 C	tk 775-5035-25 CS	tk 775-5035-25
	330 mm	tk 775-5035 C	tk 775-5035 CS	tk 775-5035
	450 mm	tk 775-5035-45 C	tk 775-5035-45 CS	tk 775-5035-45
	KOCHER, strié le long du mors, 60mm KOCHER, estriada lo larga de la boca, 60mm KOCHER, zigrinatura longitudinale, 60 mm			
<p>1:2 Starke Fasszange, atraumatisch Strong grasping forceps, atraumatic</p>	250 mm	tk 775-5032-25 C	tk 775-5032-25 CS	tk 775-5032-25
	330 mm	tk 775-5032 C	tk 775-5032 CS	tk 775-5032
	450 mm	tk 775-5032-45 C	tk 775-5032-45 CS	tk 775-5032-45
	Pince forte, atraumatique Pinza fuerte, atraumatica Pinza da presa molto forte, atraumatica			

Fasszangen, zerlegbar
Grasping forceps, detachable

Pincès à saisir, démontables
Pinzas de agarre, desmontables
Pinze da presa, smontabili

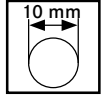





ohne Sperre
without ratchet
sans crémaillère
sin cremallera
senza cremagliera

mit Sperre
with ratchet
avec crémaillère
con cremallera
con cremagliera

Einsatz allein
Insert only
Insert seul
Inserto solo
Inserto, solo

TEKNOLINE

		Ø 10.0 mm	Ø 10.0 mm	Ø 10.0 mm
 <p>FUNDUS Fasszange <i>FUNDUS grasping forceps</i> FUNDUS, pince à saisir <i>FUNDUS, pinza de agarre</i> FUNDUS, pinza da presa</p>	250 mm	tk 775-5073-25 C	tk 775-5073-25 CS	tk 775-5073-25
	330 mm	tk 775-5073 C	tk 775-5073 CS	tk 775-5073
	450 mm	tk 775-5073-45 C	tk 775-5073-45 CS	tk 775-5073-45
 <p>ENDO CLINCH, atraumatisch gezahnt, <i>ENDO CLINCH, atraumatic serrated</i> ENDO CLINCH, atraumatique, dentelé <i>ENDO CLINCH, atraumatica, dentada</i> ENDO CLINCH, atraumatica dentata</p>	250 mm	tk 775-5089-25 C	tk 775-5089-25 CS	tk 775-5089-25
	330 mm	tk 775-5089 C	tk 775-5089 CS	tk 775-5089
	450 mm	tk 775-5089-45 C	tk 775-5089-45 CS	tk 775-5089-45
 <p>Fasszange, 2x3 gezahnt <i>Grasping forceps, 2x3 teeth</i> Pince à saisir, 2x3 dents <i>Pinza de agarre, 2x3 dientes</i> Pinza da presa, 2x3 denti</p>	250 mm	tk 775-5065-25 C	tk 775-5065-25 CS	tk 775-5065-25
	330 mm	tk 775-5065 C	tk 775-5065 CS	tk 775-5065
	450 mm	tk 775-5065-45 C	tk 775-5065-45 CS	tk 775-5065-45
 <p>Fasszange mit 3x4 Zähnen, glatt <i>Grasping forceps, 3x4 teeth, smooth</i> Pince à saisir, 3x4 dents, lisse <i>Pinza de agarre, 3x4 dientes, lisa</i> Pinza da presa, 3x4 denti, liscia</p>	250 mm	tk 775-5078-25 C	tk 775-5078-25 CS	tk 775-5078-25
	330 mm	tk 775-5078 C	tk 775-5078 CS	tk 775-5078
	450 mm	tk 775-5078-45 C	tk 775-5078-45 CS	tk 775-5078-45

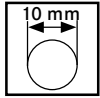

Fasszangen, zerlegbar
Grasping forceps, detachable

Pincas à saisir, démontables
Pinzas de agarre, desmontables
Pinze da presa, smontabili









ohne Sperre
without ratchet
sans crémaillère
sin cremallera
senza cremagliera

mit Sperre
with ratchet
avec crémaillère
con cremallera
con cremagliera

Einsatz allein
Insert only
Inserto solo
Inserto, solo

TEKNOLINE

		Ø 10.0 mm	Ø 10.0 mm	Ø 10.0 mm
 1:2	Fasszange, atraumatisch, spitz <i>Grasping forceps pointed, atraumatic</i>	250 mm 330 mm 450 mm	tk 775-5064-25 C tk 775-5064 C tk 775-5064-45 C	tk 775-5064-25 CS tk 775-5064 CS tk 775-5064-45 CS
	Pince à saisir, atraumatique, pointu			tk 775-5064
	Pinza de agarre, atraumatica, aguda			
	Pinza da prega atraumatica, acuta			
 1:2	MARYLAND Fasszange, grob gerieft, gebogen <i>MARYLAND coarse-serrated, curved</i>	250 mm 330 mm 450 mm	tk 775-5069-25 C tk 775-5069 C tk 775-5069-45 C	tk 775-5069-25 CS tk 775-5069 CS tk 775-5069-45 CS
	MARYLAND, strié fort, courbe			tk 775-5069
	MARYLAND, estriada fuerte, curva			
	MARYLAND, zigrinatura larga, curva			
 1:2	MARYLAND Fasszange, fein gerieft, gebogen <i>MARYLAND grasping forceps, fine serrated</i>	250 mm 330 mm 450 mm	tk 775-5021-25 C tk 775-5021 C tk 775-5021-45 C	tk 775-5021-25 CS tk 775-5021 CS tk 775-5021-45 CS
	MARYLAND, strié fin			tk 775-5021
	MARYLAND, estriada fina			
	MARYLAND, pinza da presa, zigrinatura fina			
 1:2	MARYLAND, kreuzgerieft <i>MARYLAND, cross serrated</i>	250 mm 330 mm 450 mm	tk 775-5027-25 C tk 775-5027 C tk 775-5027-45 C	tk 775-5027-25 CS tk 775-5027 CS tk 775-5027-45 CS
	MARYLAND, strié en cruciforme			tk 775-5027
	MARYLAND, estriada en cruciforma			
	MARYLAND, zigrinatura a croce			
 1:2	MARYLAND, DEBAKEY, gebogen <i>MARYLAND, DEBAKEY, curved</i>	250 mm 330 mm 450 mm	tk 775-5088-25 C tk 775-5088 C tk 775-5088-45 C	tk 775-5088-25 CS tk 775-5088 CS tk 775-5088-45 CS
	MARYLAND, DEBAKEY, courbe			tk 775-5088
	MARYLAND, DEBAKEY, curva			
	MARYLAND, DEBAKEY, curva			
 1:2	MIXTER Fasszange, 45° gewinkelt <i>MIXTER grasping forceps, 45° angled</i>	250 mm 330 mm 450 mm	tk 775-5028-25 C tk 775-5028 C tk 775-5028-45 C	tk 775-5028-25 CS tk 775-5028 CS tk 775-5028-45 CS
	MIXTER, 45° angulé			tk 775-5028
	MIXTER, 45° angulada			
	MIXTER, pinza da presa angolata a 45°			
 1:2	MIXTER Fasszange, 45° gebogen <i>MIXTER grasping forceps, 45° curved</i>	250 mm 330 mm 450 mm	tk 775-5022-25 C tk 775-5022 C tk 775-5022-45 C	tk 775-5022-25 CS tk 775-5022 CS tk 775-5022-45 CS
	MIXTER, 45° courbé			tk 775-5022
	MIXTER, 45° curvada			
	MIXTER, pinza da presa curva a 45°			

Fasszangen, zerlegbar
Grasping forceps, detachable

Pincès à saisir, démontables
Pinzas de agarre, desmontables
Pinze da presa, smontabili

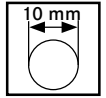







ohne Sperre
without ratchet
sans crémaillère
sin cremallera
senza cremagliera

mit Sperre
with ratchet
avec crémaillère
con cremallera
con cremagliera

Einsatz allein
Insert only
Insert seul
Inserto solo
Inserto, solo

TEKNOLINE

		Ø 10.0 mm	Ø 10.0 mm	Ø 10.0 mm
 1:2 MIXTER Fasszange, 90° gewinkelt MIXTER grasping forceps, 90° angled MIXTER, 90° angulé MIXTER, 90° angulada MIXTER, pinza da presa angolata a 90°	250 mm	tk 775-5023-25 C	tk 775-5023-25 CS	tk 775-5023-25
	330 mm	tk 775-5023 C	tk 775-5023 CS	tk 775-5023
	450 mm	tk 775-5023-45 C	tk 775-5023-45 CS	tk 775-5023-45
 1:2 COLLIN Fasszange COLLIN grasping forceps COLLIN pince à saisir COLLIN pinza de agarre COLLIN pinza da presa	250 mm	tk 775-5046-25 C	tk 775-5046-25 CS	tk 775-5046-25
	330 mm	tk 775-5046 C	tk 775-5046 CS	tk 775-5046
	450 mm	tk 775-5046-45 C	tk 775-5046-45 CS	tk 775-5046-45
 1:2 TC-COLLIN Fasszange, kreuzgerieft TC-COLLIN grasping forceps, cross serrated TC-COLLIN pince à saisir, strié TC-COLLIN pinza de agarre, estriada TC-COLLIN pinza da presa ziggrinata a croce	250 mm	tk 775-5034-25 C	tk 775-5034-25 CS	tk 775-5034-25
	330 mm	tk 775-5034 C	tk 775-5034 CS	tk 775-5034
	450 mm	tk 775-5034-45 C	tk 775-5034-45 CS	tk 775-5034-45
 1:2 PENNINGTON Fasszange PENNINGTON grasping forceps PENNINGTON pince à saisir PENNINGTON pinza de agarre PENNINGTON pinza da presa	250 mm	tk 775-5024-25 C	tk 775-5024-25 CS	tk 775-5024-25
	330 mm	tk 775-5024 C	tk 775-5024 CS	tk 775-5024
	450 mm	tk 775-5024-45 C	tk 775-5024-45 CS	tk 775-5024-45
 1:2 BABCOCK Fasszange BABCOCK-forceps BABCOCK pince à saisir BABCOCK pinza de agarre BABCOCK pinza da presa	250 mm	tk 775-5044-25 C	tk 775-5044-25 CS	tk 775-5044-25
	330 mm	tk 775-5044 C	tk 775-5044 CS	tk 775-5044
	450 mm	tk 775-5044-45 C	tk 775-5044-45 CS	tk 775-5044-45
 1:2 ALLIS Fasszange ALLIS grasping forceps ALLIS pince à saisir ALLIS pinza de agarre ALLIS pinza da presa	250 mm	tk 775-5029-25 C	tk 775-5029-25 CS	tk 775-5029-25
	330 mm	tk 775-5029 C	tk 775-5029 CS	tk 775-5029
	450 mm	tk 775-5029-45 C	tk 775-5029-45 CS	tk 775-5029-45



Fasszangen, zerlegbar
Grasping forceps, detachable

Pinces à saisir, démontables
Pinzas de agarre, desmontables
Pinze da presa, smontabili



ohne Sperre
without ratchet

mit Sperre
with ratchet

Einsatz allein
Insert only

sans crémaillère
sin cremallera
senza cremagliera

avec crémaillère
con cremallera
con cremagliera

Insert seul
Inserto solo
Inserto, solo

TEKNOLINE

6



1:2

		Ø 10.0 mm	Ø 10.0 mm	Ø 10.0 mm
DEBAKEY Fasszange, atraumatisch DEBAKEY grasping forceps, atraumatic	250 mm	tk 775-5026-25 C	tk 775-5026-25 CS	tk 775-5026-25
DEBAKEY, atraumatique	330 mm	tk 775-5026 C	tk 775-5026 CS	tk 775-5026
DEBAKEY, atraumatica	450 mm	tk 775-5026-45 C	tk 775-5026-45 CS	tk 775-5026-45
DEBAKEY pinza da presa atraumatica				
ANVIL Fasszange ANVIL grasping forceps	250 mm	tk 775-5038-25 C	tk 775-5038-25 CS	tk 775-5038-25
ANVIL pince à saisir	330 mm	tk 775-5038 C	tk 775-5038 CS	tk 775-5038
ANVIL pinza de agarre	450 mm	tk 775-5038-45 C	tk 775-5038-45 CS	tk 775-5038-45
ANVIL pinza da presa				
ALLIS Fasszange ALLIS grasping forceps	250 mm	tk 775-5041-25 C	tk 775-5041-25 CS	tk 775-5041-25
ALLIS pince à saisir	330 mm	tk 775-5041 C	tk 775-5041 CS	tk 775-5041
ALLIS pinza de agarre	450 mm	tk 775-5041-45 C	tk 775-5041-45 CS	tk 775-5041-45
ALLIS pinza da presa				
TENACULUM Hakenzange, scharf TENACULUM forceps, sharp	250 mm	tk 775-5253-25 C	tk 775-5253-25 CS	tk 775-5253-25
TENACULUM, pince à crochet, pointue	330 mm	tk 775-5253 C	tk 775-5253 CS	tk 775-5253
TENACULUM, pinza de gancho, aguda	450 mm	tk 775-5253-45 C	tk 775-5253-45 CS	tk 775-5253-45
TENACULUM pinza ad uncino, acuta				

Bipolare Instrumente, zerlegbar
 Bipolar instruments, detachable

Instruments bipolaires, démontables
 Instrumentos bipolares, desmontables
 Strumenti bipolari, smontabili

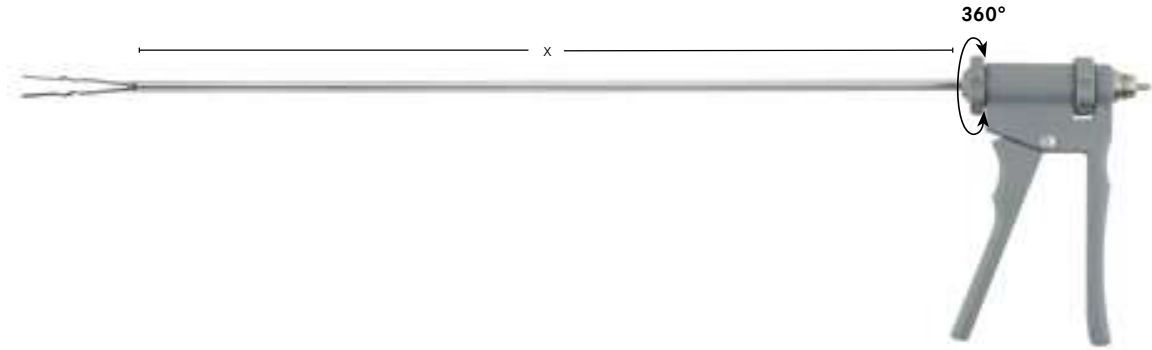
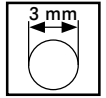

Ø 3.0 mm	x = 340 mm	x = 340 mm	
Gewellter Steg <i>Rippled bar</i> Mors avec insert ondulé Boca con inserto ondulado Morso finestrato ondulato	tk 707-012 ZDR	tk 707-112 ZDR	tk 707-012 E
Pinzettenspitze <i>Fluted tip</i> Mors fins Boca fina Morso fine	tk 707-013 ZDR	tk 707-113 ZDR	tk 707-013 E
Bipolare Instrumente <i>Bipolar instruments</i> Instruments bipolaires Instrumentos bipolares Strumenti bipolari	Zange, komplett <i>Forceps, complete</i> Pince, complète <i>Pinza, completa</i> Strumento, completo	Zange, komplett <i>Forceps, complete</i> Pince, complète <i>Pinza, completa</i> Strumento, completo	Elektrode, allein <i>Electrode, only</i> Electrode, seule <i>Electrodo, solo</i> Elettrodo, solo



Bipolare Instrumente, zerlegbar
Bipolar instruments, detachable

Instruments bipolaires, démontables
Instrumentos bipolares, desmontables
Strumenti bipolari, smontabili

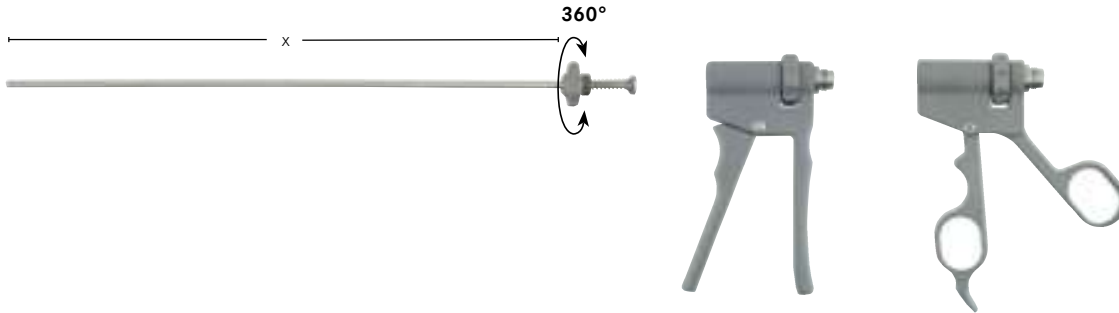

Ø 3.0 mm / x = 340 mm	tk 707-040	tk 707-041	tk 707-042
Ersatzteile <i>Spare parts</i> Pièces de réchange <i>Piezas de recambio</i> Pezzi di ricambio	Doppelschaft <i>Double shaft</i> Tige double <i>Cánula doble</i> Camicia doppia	Standardgriff <i>Standard handle</i> Poignée standard <i>Mango estándar</i> Manico Standard	Ringgriff <i>Ring handle</i> Poignée à bagues <i>Mango de anillos</i> Manico ad anelli

7

autoklavierbar / autoclavable
134°C / 273°F - 18 min.

	Erbe ICC/ACC, Wisap, Storz	3m	tk 707-340	
	Martin, Berchtold	3m	tk 707-341	
	TEKNO, Valleylab USA	3m	tk 707-342	
	TEKNO, Valleylab Europe	3m	tk 707-343	

Geräteseite
Unit side
Coté appareil
Lado equipo
Lato elettrobisturi

Instrumentenseite
Instrument side
Coté instrument
Lado instrumento
Lato strumento

Bipolare Instrumente, zerlegbar
 Bipolar instruments, detachable

Instruments bipolaires, démontables
 Instrumentos bipolares, desmontables
 Strumenti bipolari, smontabili

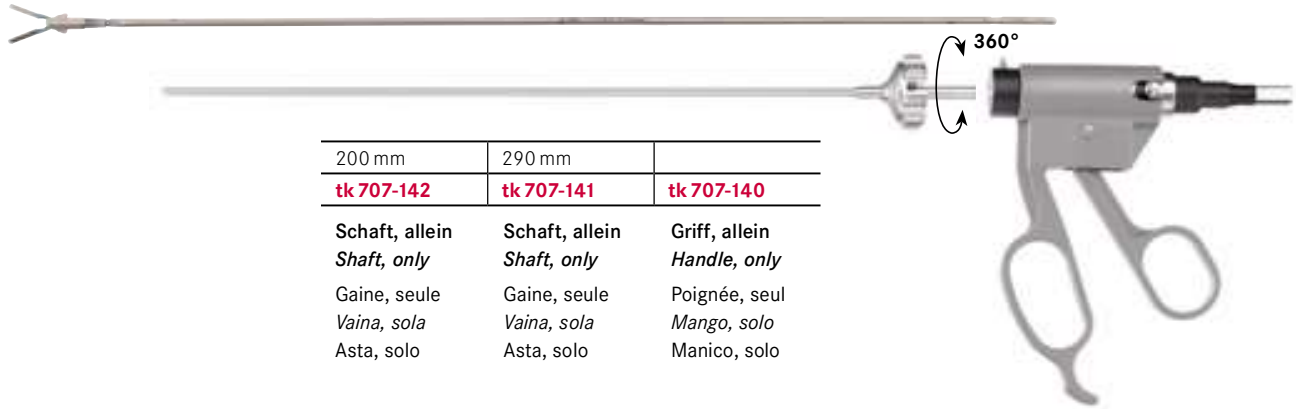
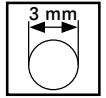

200 mm	290 mm	
tk 707-142	tk 707-141	tk 707-140

Schaft, allein <i>Shaft, only</i>	Schaft, allein <i>Shaft, only</i>	Griff, allein <i>Handle, only</i>
Gaine, seule <i>Vaina, sola</i>	Gaine, seule <i>Vaina, sola</i>	Poignée, seul <i>Mango, solo</i>
Asta, solo	Asta, solo	Manico, solo



1:1



1:1

Ø 3.0 mm			
MARYLAND Fasszange <i>MARYLAND grasping forceps</i>			
MARYLAND pince <i>MARYLAND pinza</i> MARYLAND pinza	200 mm 290 mm	tk 707-146 tk 707-144	tk 707-046 tk 707-044
Fasszange, gefenstert <i>Grasping forceps, fenestrated</i>			
Pince à saisir, fenêtrée <i>Pinza de agarre, fenestrada</i> Pinza da presa, fenestrata	200 mm 290 mm	tk 707-147 tk 707-145	tk 707-047 tk 707-045

Zange, komplett <i>Forceps, complete</i>	Einsatz, allein <i>Insert, only</i>
Pince, complète <i>Pinza, completa</i>	Insert, seul <i>Inserto, solo</i>
Strumento, completo	Inserto, solo

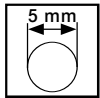





Bipolare Instrumente, zerlegbar
Bipolar instruments, detachable

Instrumentos bipolares, desmontables
Instrumentos bipolares, desmontables
Strumenti bipolari, smontabili





7

	Ø 5.0 mm	340 mm	340 mm	
	Gewellter Steg <i>Rippled bar</i> Mors avec insert ondulé <i>Boca con inserto ondulado</i> Morso fenestrato ondulado	tk 707-000 ZDR	tk 707-100 ZDR	tk 707-000 E
	Zangenartiges Maul <i>Tong-typ jaw</i> Pince <i>Pinza</i> Pinza da presa	tk 707-001 ZDR	tk 707-101 ZDR	tk 707-001 E
	Pinzettenspitze <i>Fluted tip</i> Mors fins <i>Boca fina</i> Morso fine	tk 707-003 ZDR	tk 707-103 ZDR	tk 707-003 E
	Schere, gebogen <i>Scissors, curved</i> Ciseaux courbes <i>Tijera curva</i> forbice, curva	tk 707-005 ZDR	tk 707-105 ZDR	tk 707-005 E
	Schere mit HM, gebogen <i>Scissors with TC-blades, curved</i> Ciseaux TC courbes <i>Tijera TC curva</i> Forbice con lame TC, curva	tk 707-006 ZDR	tk 707-106 ZDR	tk 707-006 E
	mit Adapter für Flachstecker <i>with adaptor for flat plug</i> avec adaptateur avec raccord plat <i>con adaptator con conexión plana</i> con adattore per spina piatta	Zange, komplett <i>Forceps, complete</i> Pince, completè <i>Pinza, completa</i> Strumento, completo	Zange, komplett <i>Forceps complete</i> Pince, completè <i>Pinza, completa</i> Strumento, completo	Elektrode, allein <i>Electrode, only</i> Electrode, seule <i>Electrodo, solo</i> Elettrodo, solo

Bipolare Instrumente, zerlegbar
Bipolar instruments, detachable

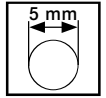
Instrumentes bipolaires, démontables
Instrumentos bipolares, desmontables
Strumenti bipolari, smontabili



	Ø 5.0 mm	340 mm	340 mm	
 1:2	KLEPPINGER, gerieft KLEPPINGER, serrated KLEPPINGER, strié KLEPPINGER, estriada KLEPPINGER, zigrinato	tk 707-008 ZDR	tk 707-108 ZDR	tk 707-008 E
	 1:2 MARYLAND Dissektor, gebogen MARYLAND dissector, curved MARYLAND dissector, courbe MARYLAND dissector, curvo MARYLAND dissettore, curvo	tk 707-009 ZDR	tk 707-109 ZDR	tk 707-009 E
	mit Adapter für Flachstecker with adaptor for flat plug	Zange, komplett Forceps, complete	Zange, komplett Forceps, complete	Elektrode, allein Electrode, only
	avec adaptateur avec raccord plat con adaptator con conexión plana con adattore per spina piatta	Pince, completè Pinza, completa Strumento, completo	Pince, completè Pinza, completa Strumento, completo	Electrode, seule Electrodo, solo Elettrodo, solo

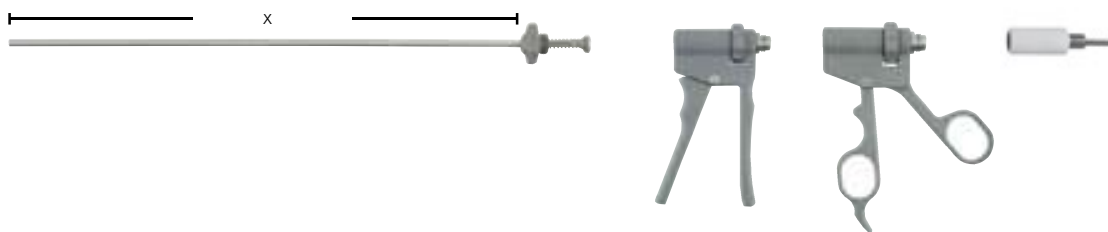

Ø 5 mm - x = 340 mm	tk 707-013	tk 707-014	tk 707-015	tk 707-016	tk 707-010
Ersatzteile Spare parts	Innenrohr Inner tube	Außenrohr Outer tube	Standardgriff Standard handle	Ringgriff Ring handle	Adapter mit Flachstecker Adaptor with flat plug
Pièces de réchange Piezas de recambio Pezzi di ricambio	Gaine interne Vaina interna Tubo interno	Gaine externe Vaina externa Tubo esterno	Poignée standard Mango estándar Manico Standard	Poignée à bagues Mango de anillos Manico ad anelli	Adaptateur avec raccord plat Adaptator con conexión plana Adattatore con spina piatta

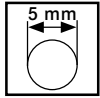

Bipolare Koagulationszange EVO II
Bipolar coagulation forceps EVO II

Pince bipolaire EVO II
Pinza bipolar EVO II
Pinza bipolari, EVO II

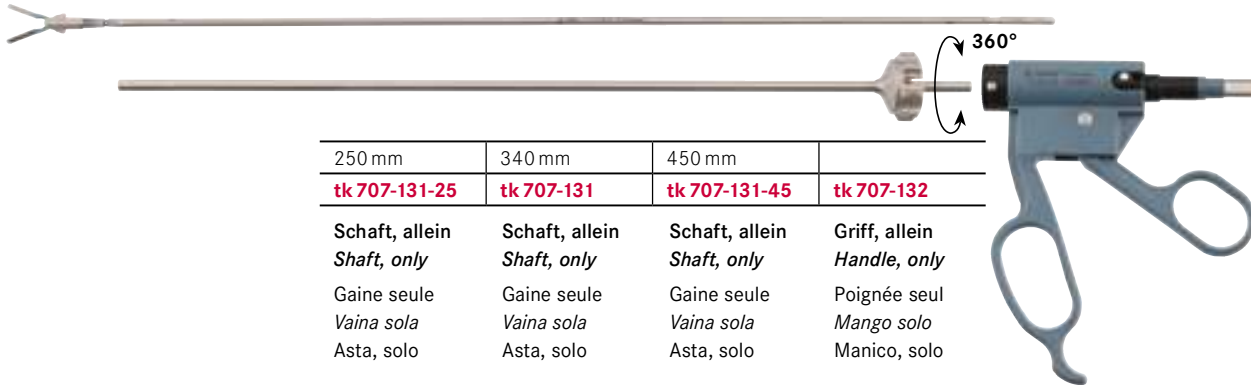

250 mm	340 mm	450 mm	
tk 707-131-25	tk 707-131	tk 707-131-45	tk 707-132
Schaft, allein <i>Shaft, only</i>	Schaft, allein <i>Shaft, only</i>	Schaft, allein <i>Shaft, only</i>	Griff, allein <i>Handle, only</i>
Gaine seule <i>Vaina sola</i>	Gaine seule <i>Vaina sola</i>	Gaine seule <i>Vaina sola</i>	Poignée seul <i>Mango solo</i>
Asta, solo	Asta, solo	Asta, solo	Manico, solo

Ø 5.0 mm			
MARYLAND Faszange <i>MARYLAND grasping forceps</i>			
MARYLAND pince <i>MARYLAND pinza</i>	250 mm	tk 707-120-25	tk 707-020-25
MARYLAND pince <i>MARYLAND pinza</i>	340 mm	tk 707-120	tk 707-020
MARYLAND pince <i>MARYLAND pinza</i>	450 mm	tk 707-120-45	tk 707-020-45
METZENBAUM Schere, gebogen <i>METZENBAUM scissors, curved</i>			
METZENBAUM ciseaux, courbes <i>METZENBAUM tijera, curva</i>	250 mm	tk 707-121-25	tk 707-021-25
METZENBAUM ciseaux, courbes <i>METZENBAUM tijera, curva</i>	340 mm	tk 707-121	tk 707-021
METZENBAUM ciseaux, courbes <i>METZENBAUM tijera, curva</i>	450 mm	tk 707-121-45	tk 707-021-45
Faszange, gefenstert <i>Grasping forceps, fenestrated</i>			
Pince à saisir, fenêtrée <i>Pinza de agarre, fenestrada</i>	250 mm	-	-
Pince à saisir, fenêtrée <i>Pinza de agarre, fenestrada</i>	340 mm	tk 707-122	tk 707-022
Pince à saisir, fenêtrée <i>Pinza de agarre, fenestrada</i>	450 mm	tk 707-122-45	tk 707-022-45
Faszange, gefenstert, spitz <i>Grasping forceps, fenestrated, pointed</i>			
Pince à saisir, fenêtrée, pointue <i>Pinza de agarre, fenestrada, aguda</i>	250 mm	-	-
Pince à saisir, fenêtrée, pointue <i>Pinza de agarre, fenestrada, aguda</i>	340 mm	tk 707-123	tk 707-023
Pince à saisir, fenêtrée, pointue <i>Pinza de agarre, fenestrada, aguda</i>	450 mm	tk 707-123-45	tk 707-023-45
Faszange, gefenstert, gebogen <i>Grasping forceps, fenestrated, curved</i>			
Pince à saisir, fenêtrée, courbe <i>Pinza de agarre, fenestrada, curva</i>	250 mm	tk 707-124-25	tk 707-024-25
Pince à saisir, fenêtrée, courbe <i>Pinza de agarre, fenestrada, curva</i>	340 mm	tk 707-124	tk 707-024
Pince à saisir, fenêtrée, courbe <i>Pinza de agarre, fenestrada, curva</i>	450 mm	tk 707-124-45	tk 707-024-45
Pinzettenspitze <i>Fluted tip</i>			
Mors fins <i>Boca fina</i>	250 mm	tk 707-125-25	tk 707-025-25
Mors fins <i>Boca fina</i>	340 mm	tk 707-125	tk 707-025
Mors fins <i>Boca fina</i>	450 mm	tk 707-125-45	tk 707-025-45
Hakenzange <i>Claw forceps</i>			
Pince á griffes <i>Pinza de gaucho</i>	250 mm	-	-
Pince á griffes <i>Pinza de gaucho</i>	340 mm	tk 707-126	tk 707-026
Pince á griffes <i>Pinza de gaucho</i>	450 mm	tk 707-126-45	tk 707-026-45

Zange, komplett
Forceps, complete
Pince, complète
Pinza, completa
Strumento, completo

Einsatz, allein
Insert, only
Insert, seul
Inserto, solo
Inserto, solo

7

Bipolare Koagulationszange EVO III
Bipolar coagulation forceps EVO III

Pince bipolaire EVO III
Pinza bipolar EVO III
Pinza bipolari, EVO III

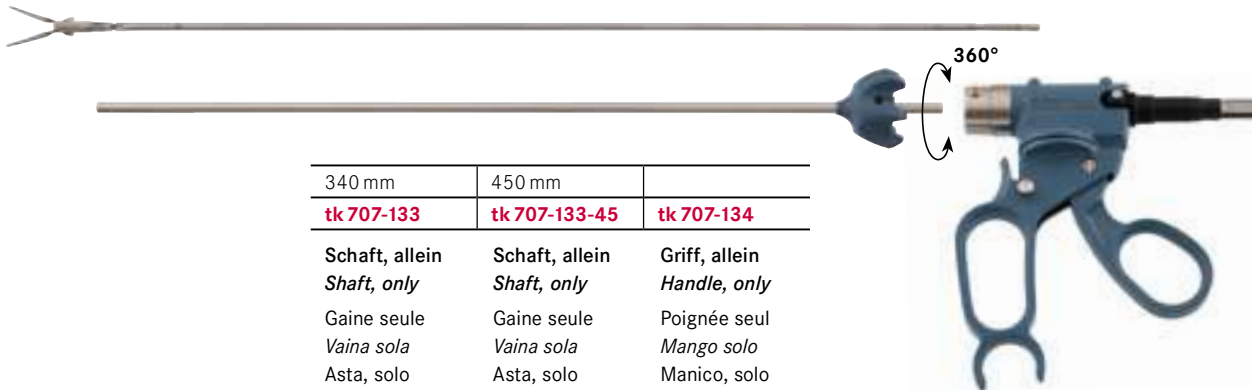
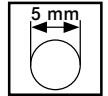

340 mm	450 mm	
tk 707-133	tk 707-133-45	tk 707-134
Schaft, allein <i>Shaft, only</i>	Schaft, allein <i>Shaft, only</i>	Griff, allein <i>Handle, only</i>
Gaine seule <i>Vaina sola</i>	Gaine seule <i>Vaina sola</i>	Poignée seul <i>Mango solo</i>
Asta, solo	Asta, solo	Manico, solo

	Ø 5.0 mm			
 1:1	MARYLAND Fasszange <i>MARYLAND grasping forceps</i>			
	MARYLAND pince <i>MARYLAND pinza</i> MARYLAND pinza	340 mm 450 mm	tk 707-170 tk 707-170-45	tk 707-070 tk 707-070-45
 1:1	METZENBAUM Schere, gebogen <i>METZENBAUM scissors, curved</i>			
	METZENBAUM ciseaux, courbes <i>METZENBAUM tijera, curva</i> METZENBAUM forbice curva	340 mm 450 mm	tk 707-171 tk 707-171-45	tk 707-071 tk 707-071-45
 1:1	Fasszange, gefenstert <i>Grasping forceps, fenestrated</i>			
	Pince à saisir, fenêtrée <i>Pinza de agarre, fenestrada</i> Pinza da presa, fenestrata	340 mm 450 mm	tk 707-173 tk 707-173-45	tk 707-073 tk 707-073-45
 1:1	Fasszange, gefenstert, gebogen <i>Grasping forceps, fenestrated, curved</i>			
	Pince à saisir, fenêtrée, courbe <i>Pinza de agarre, fenestrada, curva</i> Pinza da presa, fenestrata, curva	340 mm 450 mm	tk 707-172 -	tk 707-072 -







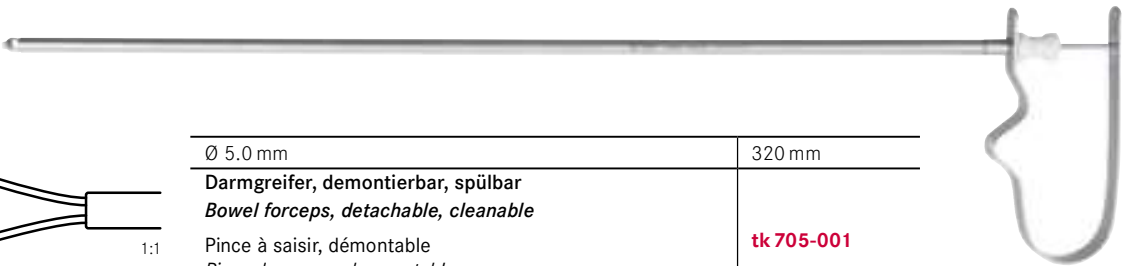

Zange, komplett <i>Forceps, complete</i>	Einsatz, allein <i>Insert, only</i>
Pince, complète <i>Pinza, completa</i>	Insert, seul <i>Inserto, solo</i>
Strumento, completo	Inserto, solo

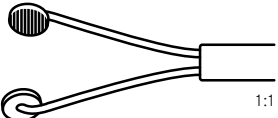

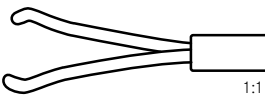
Knotenschieber, Fasszangen
Knotguides, Grasping forceps

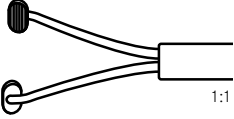
Pousse-nœuds, pinces à saisir
Guía de ligaduras, pinzas de agarre
Spingi-nodi, pinze da presa

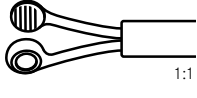

	Ø 5.0 mm	320 mm
	Darmgreifer, demontierbar, spülbar <i>Bowel forceps, detachable, cleanable</i>	tk 705-001
	Pince à saisir, démontable <i>Pinza de agarre, desmontable</i> Pinza intestinale, smontabile	
	Atraumatische Fasszange, demontierbar, spülbar <i>Atraumatic grasping forceps, detachable, cleanable</i>	tk 705-002
	Pince à saisir, atraumatique, démontable <i>Pinza de agarre, atraumatica, desmontable</i> Pinza da presa atraumatica, smontabile	
	Eileiter-Fasszange, T-förmig, demontierbar, spülbar <i>Fimbrial holding forceps, T-pattern, detachable, cleanable</i>	tk 705-004
	Pince à saisir les trompes, en forme "T", démontable <i>Pinza para tener las trompas, en forma de "T", desmontable</i> Pinza presa-tube, forma "T", smontabile	
	Eileiter-Fasszange, ring-förmig, demontierbar, spülbar <i>Fimbrial holding forceps, ring-pattern, detachable, cleanable</i>	tk 705-005
	Pince à saisir les trompes, ronde, démontable <i>Pinza para tener las trompas, redonda, desmontable</i> Pinza presa tube, forma d'anello, smontabile	

8

	Ø 5 mm
330 mm	tk 704-106
450 mm	tk 704-108

Knotenschieber mit Öse
Knotguide with eyelet

Pousse-nœuds avec œillet
Guía de ligaduras con ojete
Spingi-nodo con cruna

	Ø 5 mm
330 mm	tk 704-107

Knotenschieber mit Längsschlitz
Knotguide with slit

Pousse-nœuds avec fissure
Guía de ligaduras con abertura
Spingi-nodo con fessura

Nahtinstrumente
Closure instruments

Instruments de suture
Instrumentos de sutura
Strumenti per sutura

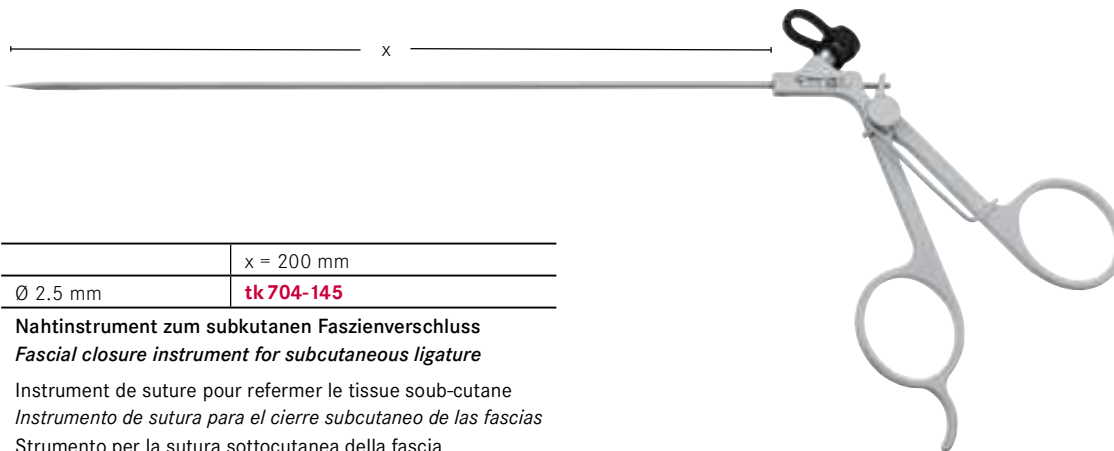

	x = 200 mm
Ø 2.5 mm	tk 704-145

Nahtinstrument zum subkutanen Faszienschluss
Fascial closure instrument for subcutaneous ligature

Instrument de suture pour refermer le tissu soub-cutane
Instrumento de sutura para el cierre subcutaneo de las fascias
Strumento per la sutura sottocutanea della fascia

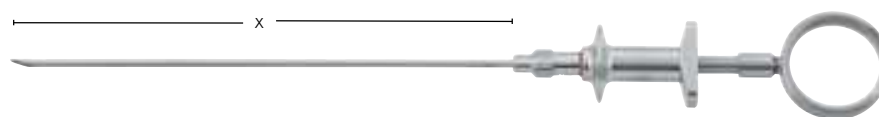

FSAD - FASCIA SUTURE ASSISTING DEVICE

	x = 140 mm
Ø 2.3 mm	tk 704-140

Nahtinstrument
Fascial closure instrument

Instrument de suture
Instrumento de sutura
Strumento per della fascia sutura

Leichtgewicht Nadelhalter, nicht zerlegbar
Lightweight needle holder, not detachable

Porte-aiguilles légères, non-démontables
Porta-agujas ligeros, no desmontables
Port'aghi leggero, non smontabile



		Ø 3.0 mm	Ø 3.0 mm
Nadelhalter, gerade <i>Needle holder, straight</i> Porte-aiguilles, droit Porta-agujas, recta Port'aghi, retto	250 mm	tk 708-560	tk 708-561
	330 mm	tk 708-562	tk 708-563
Nadelhalter, links gebogen <i>Needle holder, left curved</i> Porte-aiguilles, courbe à gauche Porta-agujas, curva a la izquierda Port'aghi, curvo a sinistra	250 mm	tk 708-564	tk 708-565
	330 mm	tk 708-566	tk 708-567
Nadelhalter, rechts gebogen <i>Needle holder, right curved</i> Porte-aiguilles, courbe à droite Porta-agujas, curva a la derecha Port'aghi, curvo a destra	250 mm	tk 708-568	tk 708-569
	330 mm	tk 708-570	tk 708-571
		Ø 5.0 mm	Ø 5.0 mm
Nadelhalter, gerade <i>Needle holder, straight</i> Porte-aiguilles, droit Porta-agujas, recta Port'aghi, retto	330 mm	tk 708-540	tk 708-541
	450 mm	tk 708-542	tk 708-543
Nadelhalter, links gebogen <i>Needle holder, left curved</i> Porte-aiguilles, courbe à gauche Porta-agujas, curva a la izquierda Port'aghi, curvo a sinistra	330 mm	tk 708-544	tk 708-545
	450 mm	tk 708-546	tk 708-547
Nadelhalter, rechts gebogen <i>Needle holder, right curved</i> Porte-aiguilles, courbe à droite Porta-agujas, curva a la derecha Port'aghi, curvo a destra	330 mm	tk 708-548	tk 708-549
	450 mm	tk 708-550	tk 708-551
Nadelhalter Flamingo, gerade <i>Needle holder Flamingo, straight</i> Porte-aiguilles Flamant, droit Porta-agujas Flamenco, recta Port'aghi Flamingo, retto	330 mm	tk 708-552	tk 708-553
	450 mm	tk 708-554	tk 708-555
Nadelhalter 1x2 Zähne, gerade <i>Needle holder 1x2 teeth, straight</i> Porte-aiguilles 1x2 dents, droit Porta-agujas 1x2 dientes, recta Port'aghi, 1x2 denti, dritto	330 mm	tk 708-556	tk 708-557
	450 mm	tk 708-558	tk 708-559

Handgriff, gerade
Handle, straight

Manche, droit
Mango, recta
Manico, dritta

Handgriff, gebogen
Handle, curved

Manche, courbe
Mango, curva
Manico, curva

Leichtgewicht Nadelhalter, zerlegbar
Lightweight needle holder, detachable

Porte-aiguilles légères, démontables
Porta-agujas ligeros, desmontables
Port'aghi leggero, smontabile



		Ø 5.0 mm	Ø 5.0 mm	Ø 5.0 mm
Nadelhalter, TC, gerade <i>Needle holder, TC, straight</i> Porte-aiguilles, TC, droit Porta-agujas, TC, recta Port'aghi, TC, retto	330 mm	tk 708-640	tk 708-641	tk 708-634
Nadelhalter, TC, links gebogen <i>Needle holder, TC, left curved</i> Porte-aiguilles, TC, courbe à gauche Porta-agujas, TC, curva a la izquierda Port'aghi, TC, curvo a sinistra	330 mm	tk 708-644	tk 708-645	tk 708-635
Nadelhalter, TC, rechts gebogen <i>Needle holder, TC, right curved</i> Porte-aiguilles, TC, courbe à droite Porta-agujas, TC, curva a la derecha Port'aghi, TC, curvo a destra	330 mm	tk 708-648	tk 708-649	tk 708-636
Nadelhalter Flamingo, diamantiert, gerade <i>Needle holder Flamingo, diamond coated, straight</i> Porte-aiguilles Flamant, diamanté, droit Porta-agujas Flamingo, diamantada, recta Port'aghi Flamingo, diamantata, retto	330 mm	tk 708-652	tk 708-653	tk 708-637
Nadelhalter 1x2 Zähne, TC, gerade <i>Needle holder 1x2 teeth, TC, straight</i> Porte-aiguilles 1x2 dents, TC, droit Porta-agujas 1x2 dientes, TC, recta Port'aghi, 1x2 denti, TC, retto	330 mm	tk 708-656	tk 708-657	tk 708-638
Nadelhalter, gerade, gerieft <i>Needle holder, straight, serrated</i> Porte-aiguilles, droit, strié Porta-agujas, boca recta, estriada Port'aghi, morso retto, zigrinato	330 mm	tk 708-660	tk 708-661	tk 708-639

komplett <i>complete</i>	komplett <i>complete</i>	Einsatz allein <i>Insert, only</i>
complet <i>completo</i>	complet <i>completo</i>	Insert, seul <i>Inserto, solo</i>
completo	completo	Inserto, solo

tk 708-630	tk 708-631
Handgriff, gerade <i>Handle, straight</i> Manche, droit <i>Mango, recta</i> Impugnatura, retta	Handgriff, gebogen <i>Handle, curved</i> Manche, courbe <i>Mango, curva</i> Impugnatura, angolata

	Ø 5.0 mm
330 mm	tk 708-633
	Metallschaft <i>Metal shaft</i> Gaine métallique <i>Vaina de metal</i> Camicia di metallo

Nadelhalter mit Axial-Griff, mit LL
Needle holders with axial handle, with LL

Porte-aiguilles avec manche axial, connecteur LL
Porta-agujas con mango axial, conexión LL
Port'aghi con impugnatura assiale, con LL



1:1



1:1









1:1

Ø 5.0 mm - 330 mm	
Maul kreuzgerieft mit Hartmetalleinsatz, gerade <i>Jaw cross serrated with TC-inserts, straight</i> Mors strié transversal, inserts TC, droit <i>Boca estriada transversal, insertos TC, recta</i> Morso zigrinato a croce, inserto TC, retto	tk 708-520
Maul kreuzgerieft mit Hartmetalleinsatz, links gebogen <i>Jaw cross serrated with TC-inserts, left curved</i> Mors strié transversal, inserts TC, courbe à gauche <i>Boca estriada transversal, insertos TC, curva a la izquierda</i> Morso zigrinato a croce, inserto TC, curvo a sinistra	tk 708-521
Maul kreuzgerieft mit Hartmetalleinsatz, rechts gebogen <i>Jaw cross serrated with tungsten carbide inserts, right curved</i> Mors strié transversal, inserts TC, courbe à droite <i>Boca estriada transversal, insertos TC, curva a la derecha</i> Morso zigrinato a croce, inserto TC, curvo a destra	tk 708-522

Nadelhalter mit Axial-Griff, mit LL
Needle holders with axial handle, with LL

Porte-aiguilles avec manche axial, connecteur LL
Porta-agujas con mango axial, conexión LL
Port'aghi con impugnatura assiale, con LL



	Ø 5.0 mm - 320 mm	
	Maul kreuzgerieft, gerade <i>Jaw cross serrated, straight</i> Mors strié transversal, droit <i>Boca estriada transversal, recta</i> Morso zigrinato a croce, retto	tk 708-100 LL
	Maul kreuzgerieft, TEKNO-FLAM <i>Jaw cross serrated, TEKNO-FLAM</i> Mors strié transversal, TEKNO-FLAM <i>Boca estriada transversal, TEKNO-FLAM</i> Morso zigrinato a croce, TEKNO-FLAM	tk 708-110 LL
	Maul kreuzgerieft mit Hartmetalleinsatz, gerade <i>Jaw cross serrated with TC-inserts, straight</i> Mors strié transversal, inserts TC, droit <i>Boca estriada transversal, insertos TC, recta</i> Morso zigrinato a croce, inserto TC, retto	tk 708-511 LL
	Maul kreuzgerieft mit Hartmetalleinsatz, links gebogen <i>Jaw cross serrated with TC-inserts, left curved</i> Mors strié transversal, inserts TC, courbe á gauche <i>Boca estriada transversal, insertos TC, curva a la izquierda</i> Morso zigrinato a croce, inserto TC, curvo a sinistra	tk 708-512 LL
	Maul kreuzgerieft mit Hartmetalleinsatz, rechts gebogen <i>Jaw cross serrated with TC-inserts, right curved</i> Mors strié transversal, inserts TC, courbe á droite <i>Boca estriada transversal, insertos TC, curva a la derecha</i> Morso zigrinato a croce, inserto TC, curvo a destra	tk 708-513 LL
	Maul diamantiert, automatische Nadelaufrichtung <i>Jaw diamond coated, automatic needle positioning</i> Mors diamanté, positionnement automatique de l'aiguille <i>Boca diamantada, posicionar automatico de la aguja</i> Morso diamantato, posizionamento automatico dell'ago	tk 708-530

Instrumente, nicht zerlegbar, mit LL
Instruments, not detachable, with LL

Instruments non-démontables, connecteur LL
Instrumentos no desmontables, conexión LL
 Strumenti non smontabile, con LL



1:1



1:1



1:1

		Ø 3.0 mm	Ø 5.0 mm
Nadelhalter, Maul kreuzgerieft <i>Needle holder, jaw cross serrated</i>	320 mm	tk 703-102 LL	-
Porte-aiguilles, mors strié transversal <i>Porta-agujas, boca estriada transversal</i>	330 mm	-	tk 703-100 LL
Port'aghi, morso zigrinato a croce <i>Maul kreuzgerieft mit Hartmetalleinlage</i> <i>Jaw cross serrated with TC-inserts</i>	330 mm	-	tk 703-510 LL
Mors strié transversal avec inserts TC <i>Boca estriada transversal con insertos TC</i> <i>Morso zigrinato a croce con inserti TC</i>	320 mm	-	tk 703-512 LL
Maul kreuzgerieft mit Hartmetalleinlage, gebogen <i>Jaw cross serrated with TC-inserts, curved</i>	320 mm	-	tk 703-512 LL
Mors strié transversal avec inserts TC, courbe <i>Boca estriada transversal con insertos TC, curva</i> <i>Morso zigrinato a croce con inserti TC, curvo</i>	320 mm	-	tk 703-512 LL

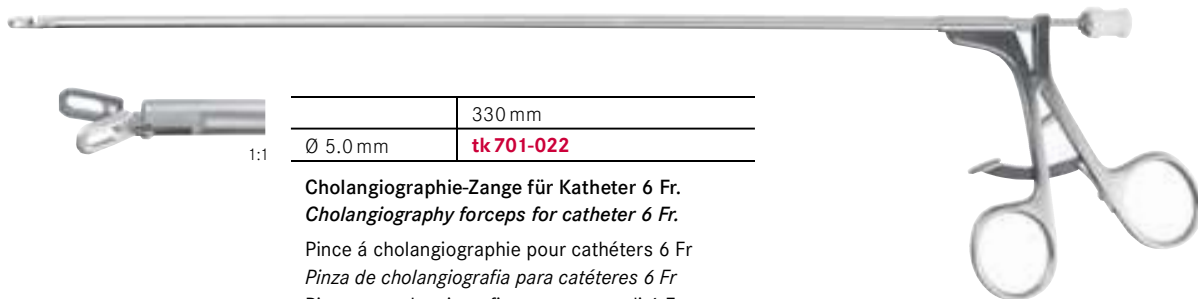

1:1

	330 mm
Ø 5.0 mm	tk 701-022

Cholangiographie-Zange für Katheter 6 Fr.
Cholangiography forceps for catheter 6 Fr.
 Pince à cholangiographie pour cathéters 6 Fr.
Pinza de cholangiografia para catéteres 6 Fr
 Pinza per colangiografia per catetere di 6 Fr.

Clip Anlegezangen
Clip application forceps

Pincès à poser des clips
Pinzas para clips
Pinze per applicatori di clip

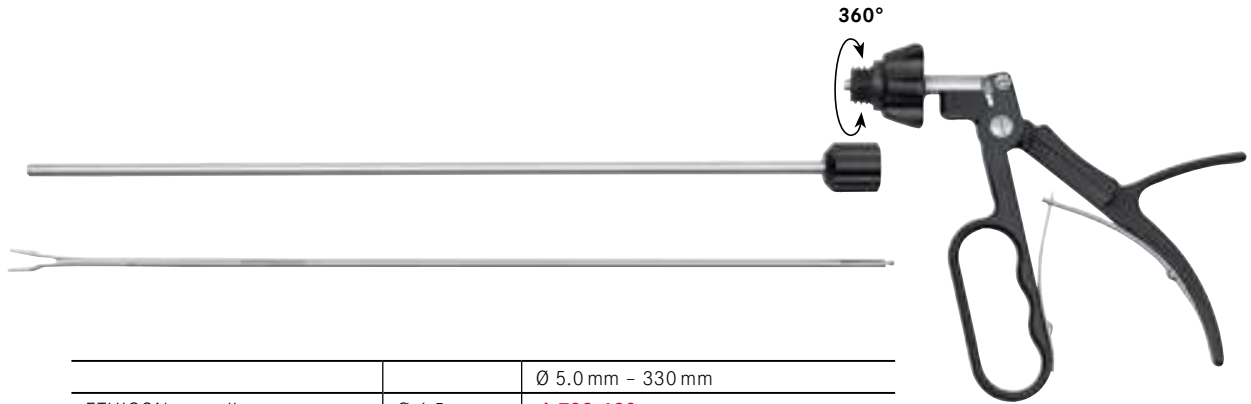

		Ø 5.0 mm - 330 mm
ETHICON - small	Ø 6.5 mm	tk 708-680

für Clips Typ
for clips type

pour clips, type
para clips, tipo
per clips tipo

für Trokare
for trocars

pour trocars
para trócares
per trequarti

zerlegbar, 360° drehbar, für Titan-Clips
detachable, 360° rotatable, for Titanium clips

démontable, rotative de 360°, pour clips en titane
desmontable, giratoria de 360°, para clips en titanio
smontabile, rotante 360°, per clips di titanio



		Ø 10.0 mm - 330 mm
ETHICON - medium	Ø 10.0 mm	tk 708-701
ETHICON - medium/large	Ø 10.0 mm	tk 708-702
ETHICON - large	Ø 12.5 mm	tk 708-703
PILLING-WECK - small	Ø 10.0 mm	tk 708-710
PILLING-WECK - medium	Ø 10.0 mm	tk 708-711
PILLING-WECK - medium/large	Ø 10.0 mm	tk 708-712
PILLING-WECK - large	Ø 12.5 mm	tk 708-713

für Clips Typ
for clips type

pour clips, type
para clips, tipo
per clips tipo

für Trokare
for trocars

pour trocars
para trócares
per trequarti

360° drehbar, für Titan-Clips, mit LL-Spülkanal
360° rotatable, for Titanium clips, with LL-rising channel

rotative de 360°, pour clips en titane, avec connecteur LL
giratoria de 360°, para clips en titanio, con conexión LL
rotante 360°, per clips di titanio, con canale di lavaggio LL

Clip Anlegezangen
Clip application forceps

 Pincès à poser des clips
 Pinzas para clips
 Pinze per applicatore di clip

		Ø 10.0 mm - 330 mm	Ø 10.0 mm - 330 mm
ETHICON - small	Ø 10.0 mm	tk 708-750	-
ETHICON - medium	Ø 10.0 mm	tk 708-751	tk 708-741
ETHICON - medium/large	Ø 10.0 mm	tk 708-752	tk 708-742
ETHICON - large	Ø 12.5 mm	tk 708-753	tk 708-743
PILLING-WECK - small	Ø 10.0 mm	tk 708-770	-
PILLING-WECK - medium	Ø 10.0 mm	tk 708-771	tk 708-761
PILLING-WECK - medium/large	Ø 10.0 mm	tk 708-772	tk 708-762
PILLING-WECK - large	Ø 12.5 mm	tk 708-773	tk 708-763

für Clips Typ
for clips type

 pour clips, type
 para clips, tipo
 per clips tipo

für Trokare
for trocars

 pour trocars
 para trócares
 per trequarti

Einsatz, allein
Insert, only
 Insert, seul
 Inserto, solo
 Inserto, solo

Zange komplett, zerlegbar, 360° drehbar
Forceps, complete, detachable, 360° rotatable
 Pince complete, démontable, rotative de 360°
 Pinza completa, desmontable, giratoria de 360°
 Pinza completa, smontabile, rotante 360°

10

ETHICON clips - small	-	tk 708-705 / LT 100
ETHICON clips - medium	-	tk 708-706 / LT 200
ETHICON clips - medium/large	tk 708-707 / LT 300	-
ETHICON clips - large	tk 708-708 / LT 400	-

Pack mit 18 Magazinen à 6 Stck.
Pack with 18 magazines à 6 pcs.
 Paquet de 18 magasins de 6 pcs
 Paquetes. de 18 cargadores de 6 pzas
 Confezione con 18 cartucce di 6 pezzi

Pack mit 36 Magazinen à 6 Stck.
Pack with 36 magazines à 6 pcs.
 Paquet de 36 magasins de 6 pcs
 Paquetes. de 36 cargadores de 6 pzas
 Confezione con 36 cartucce di 6 pezzi

Endoretractoren | Endo-retracteurs
Endo-retractors | *Endo-retractores*
 Endo-retrattori



x

x



1:1



1:1

	x = 40 mm	x = 70 mm
∅ 5 mm – 360 mm	tk 704-123	tk 704-124
∅ 5 mm – 450 mm	tk 704-123-45	tk 704-124-45

Finger-Retractor
Finger retractor
 Rétracteur de doigts
Retractor de dedo
 Retrattore a dito

Triangular-Retractor
Triangular retractor
 Rétracteur triangulaire
Retractor triangular
 Retrattore triangolare

Endoretraktor, Elevator
Endo-retractor, elevator

Endo-retracteur, elevateur
Endo-retractor, elevator
Retrattore, Elevatore



	450 mm	
Ø 5 mm	tk 704-115	tk 704-125

gerade <i>straight</i>	gebogen <i>curved</i>
droit <i>recto</i>	courbe <i>curva</i>
retto	curvo



	340 mm
Ø 5 mm	tk 704-110

Fächer-Retraktor (3 Finger) mit Spülvorrichtung
Fan-Retractor (3 fingers) with rinsing channel

Retracteur en éventail, (3 doigts), avec connecteur LL
Retractor en abanico, (3 dedos), con conexión LL
Retrattore a ventaglio (3 lame), con LL



	336 mm
Ø 5 mm	tk 704-111

Fächer-Retraktor (3 Finger) mit Spülvorrichtung, abwinkelbar
Fan-Retractor (3 fingers) with rinsing channel, angleable

Retracteur en éventail, (3 doigts), avec connecteur LL, pliable
Retractor en abanico, (3 dedos), con conexión LL, boca para doblar
Retrattore a ventaglio (3 lame), angolabile, con LL

Endoretraktor, Elevator | Endo-retracteur, elevateur
Endo-retractor, elevator | *Endo-retractor, elevator*
 Retrattore, Elevatore



	380 mm
Ø 10 mm	tk 704-112

Fächer-Retraktor (5 Finger) mit Spülvorrichtung
Fan-Retractor (5 fingers) with rinsing channel

Retracteur en éventail, (5 doigts), avec connecteur LL
Retractor en abanico, (5 dedos), con conexión LL
 Retrattore a ventaglio (5 lame), con LL



	347 mm
Ø 10 mm	tk 704-113





Fächer-Retraktor (5 Finger) mit Spülvorrichtung, abwinkelbar
Fan-Retractor (5 fingers) with rinsing channel, angleable

Retracteur en éventail, (5 doigts), avec connecteur LL, pliable
Retractor en abanico, (5 dedos), con conexión LL, boca para doblar
 Retrattore a ventaglio (5 lame), angolabile, con LL

Elektroden, monopolar
Electrodes monopolar

Electrodes monopolaires
Electrodos monopolares
Elettrodi monopolari



	Ø 2.8 mm		Ø 5.0 mm	
	250 mm	330 mm	330 mm	450 mm
 Spatel <i>Spatula</i> Spatule <i>Espátula</i> Spatola	tk 762-103-25	tk 762-103	tk 706-152	tk 706-152-45
 Rundhaken <i>Hook</i> Crochet <i>Gancho</i> Uncino	tk 762-101-25	tk 762-101	tk 706-154	tk 706-154-45
 Haken 90° <i>Hook 90°</i> Crochet 90° <i>Gancho 90°</i> Uncino 90°	tk 762-102-25	tk 762-102	tk 706-156	tk 706-156-45
 Kugel <i>Ball point</i> Boule <i>Bola</i> Sfera	tk 762-104-25	tk 762-104	tk 706-158	tk 706-158-45
 Nadel <i>Needle</i> Aiguille <i>Aguja</i> Ago	tk 762-105-25	tk 762-105	tk 706-159	tk 706-159-45

Elektrode, monopolar, massive Ausführung
Electrode, monopolar, solid model
Electrode, monopolaire, modèle solide
Electrodo, monopolar, modelo sólido
Elettrodi, monopolari, modello solido



tk 706-150

Komfort-Handgriff für Elektroden (tk 706-152 - tk 706-158)
Comfort-handle for electrodes (tk 706-152 - tk 706-158)
Poignée de confort pour électrodes (tk 706-152 - tk 706-158)
Mango de confort para electrodos (tk 706-152 - tk 706-158)
Manico confortabile per elettrodi (tk 706-152 - tk 706-158)

Elektroden mit auswechselbaren Spitzen
Electrodes with interchangeable tips

Electrodes avec inserts interchangeables
Electrodo con insertos intercambiables
Elettrodi con punte intercambiabili

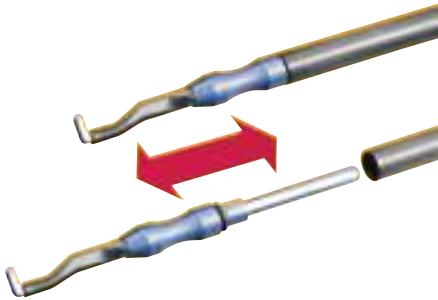

tk 706-170

Schaft und Griff
Shaft and handle

Tige et poignée
Vaina y mango
Asta e manico



Ø 5.0 mm – ~350 mm		
Haken 90° Hook 90° Crochet 90° Gancho 90° Uncino 90°	tk 706-191	tk 706-171
Spatel, kurz Spatula, short Spatule, courte Espátula, corta Spatola	tk 706-192	tk 706-172
Draht Wire hook Crochet fin Gancho fino Uncino fine	tk 706-193	tk 706-173
Knopf Ball point Boule Bola Sfera	tk 706-194	tk 706-174
Spatel Spatula Spatule Espátula Spatola	tk 706-195	tk 706-175
Rundhaken Round hook Crochet rond Gancho redondo Uncino rotondo	tk 706-196	tk 706-176

komplett
complete
 complet
completo
 completo

Einsatz, allein
Insert, only
 Insert, seul
Inserto, solo
 Inserto, solo

Monopolare Hochfrequenzkabel
Monopolar high frequency cables

Cables monopolaires
Cables monopolares
 Cavi monopolari

autoklavierbar / *autoclavable*
 134°C / 273°F

	TEKNO, Berchtold, Martin, Erbe T-series	3 m	tk 707-510	
		5 m	tk 707-511	
	TEKNO, Storz, Erbe, Martin, Berchtold	3 m	tk 707-520	
		5 m	tk 707-521	
	Valleylab	3 m	tk 707-525	
		5 m	tk 707-526	







Geräteseite
Units side
 Coté appareil
Lado equipo
 Lato apparecchio

Instrumentenseite
Instrument side
 Coté instrument
Lado instruments
 Lato strumento

Bipolare Koagulationselektroden
Bipolar coagulation electrodes

Electrodes à coagulation bipolaire
Electrodos para la coagulación bipolar
Elettrodi per coagulazione bipolare

















	Ø 3.0mm	x = 340mm
 1:1	L-Haken <i>L-hook</i> Crochet en L <i>Gancho L</i> Uncino L	tk 707-160
 1:1	V-Haken <i>V-hook</i> Crochet en V <i>Gancho V</i> Uncino V	tk 707-161
 1:1	Nadel <i>Needle</i> Aiguille <i>Aguja</i> Ago	tk 707-162
	Ø 5.0mm	x = 340mm
 1:1	Rundhaken <i>Hook</i> Crochet <i>Gancho</i> Uncino	tk 707-150
 1:1	Haken 90° <i>Hook 90°</i> Crochet 90° <i>Gancho 90°</i> Uncino 90°	tk 707-151
 1:1	Spatel <i>Spatula</i> Spatule <i>Espátula</i> Spatola	tk 707-152
 1:1	Knopf <i>Ball point</i> Boule <i>Bola</i> <i>Sfera</i>	tk 707-153

Bipolare Instrumentenkabel | Cables bipolaires
Bipolar instrument cables | *Cables bipolares*
 Cavi bipolari

Hochfrequenzkabel, 3 m
High frequency cable, 3 m
 Câble de haute fréquence, 3 m
Cable alta frecuencia, 3 m
 Cavo ad alta frequenza, 3 m

autoclavable
 134°C / 273°F

	Erbe ICC/ACC, Wisap, Storz	tk 707-330	Flat plug round	
		tk 707-300	Flat plug square	
	Martin, Berchtold	tk 707-331	Flat plug round	
		tk 707-301	Flat plug square	
	TEKNO, Valleylab USA	tk 707-332	Flat plug round	
		tk 707-302	Flat plug square	
	TEKNO, Valleylab Europe	tk 707-333	Flat plug round	
		tk 707-303	Flat plug square	
	TEKNO, 19 mm for TOM 80/100 212/212A/ 412/412A only	tk 707-338	Flat plug round	

Geräteseite <i>Unit side</i>	Instrumentenseite <i>Instrument side</i>
Coté appareil	Coté instrument
<i>Lado equipo</i>	<i>Lado instrumento</i>
Lato elettrobisturi	Lato strumento



Andere Anschlüsse auf Anfrage lieferbar
Other connectors are available upon request
 Autres raccords sont disponibles sur demande
Otras conexiones son disponibles según demanda
 Altri attacchi a richiesta

Ring Applikatoren
Ring applicators

Applicateurs des anneaux
Aplicadores de anillos
Applicatore per anelli



	x = 332 mm
Ø 6 mm - 18 Charr.	tk 791-180

Zur Anwendung mit OP-Laparoskop tk 700-250.
Für einen Einstich; komplett mit Ladevorrichtung und Konusteil.
For use with OP-Laparoscope tk 700-250.
For single puncture; complete with loading device and cone part.
Pour l'utilisation avec laparoscope tk 700-250.
Pour une ponction; complet avec chargeur et conus.
Para la utilización con laparoscop tk 700-250.
Para una punción; completo con cargador y punta conica.
Per utilizzo con laparoscopia operativo tk 700-250.
Per singola incisione; completo di strumenti di carica e parte a cono.

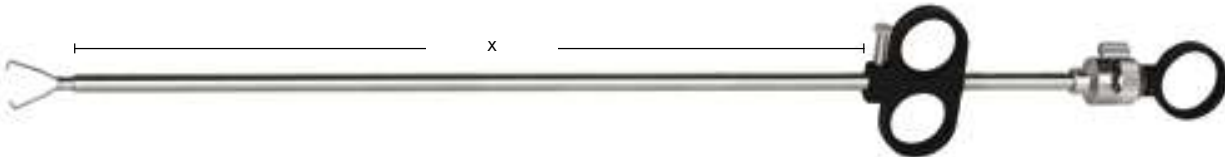

	x = 287 mm
Ø 6.5 mm - 20 Charr.	tk 791-185

Zur Anwendung mit einer regulären Trokarhülse (7 mm).
Für den zweiten Einstich; komplett mit Ladevorrichtung und Konusteil.
For use with a regular trocar sheath (7 mm).
For second puncture; complete with loading device and cone part.
Pour l'utilisation avec un trocar standard (7 mm).
Pour la deuxième ponction; complet avec chargeur et conus.
Para la utilización con un trocar estandard (7 mm).
Para segundo punción, completo con cargador y punta conica.
Per utilizzo con trocar normale (7 mm).
Per due incisioni; completo di strumenti di carica e parte a cono.



tk 791-187

Konusteil für tk 791-180 / tk 791-185
Cone part for tk 791-180 / tk 791-185
Conus pour tk 791-180 / tk 791-185
Punta conica para tk 791-180 / tk 791-185
Parte conica per tk 791-180 / tk 791-185



tk 791-189

Ladevorrichtung für tk 791-180 / tk 791-185
Loading device for tk 791-180 / tk 791-185
Chargeur pour tk 791-180 / tk 791-185
Cargador para tk 791-180 / tk 791-185
Caricatore per tk 791-180 / tk 791-185

Uterusmanipulator | Manipulator utérin
Uterus manipulator | *Manipulador uterino*
 Manipolatore uterino



	tk 791-151	tk 791-152	tk 791-153	tk 791-154	tk 791-155	tk 791-156	tk 791-157
Manipulator <i>Manipulator</i> Manipulator <i>Manipulador</i> Manipolatore		Ø 3.0 x 45 mm	Ø 3.0 x 55 mm	Ø 3.2 x 34 mm	Ø 3.2 x 45 mm	Ø 8.0 x 80 mm	Ø 10.0 x 100 mm
tk 791-150	x	x	x	x	x	x	x

14

komplett
complete
 complet
completo
 completo

Instrumente
Instruments
Instrumentos
Strumenti

Myombohrer
Myoma drill
Mèche pour myomes
Taladro para miomas
Fissatore per mioma



	x = 330 mm	x = 420 mm
Ø 5.0 mm	tk 791-170	tk 791-176



	x = 330 mm	x = 420 mm
Ø 10.0 mm	tk 791-174	tk 791-175



COHEN
tk 791-161

Intra-Uterin-Sonde mit 1 kleinen und 1 großen Portio-Kegelansatz
Intra-uterine probe with 1 small and 1 large cervical cone
Sonde intra utérin avec 1 petit et 1 grand adaptateur conique
Sonda intra-uterina con 1 pequeño y 1 grande adaptador conico
Sonda intra-uterina con un cono cervicale piccolo ed uno grande

Reinigungs- und Sterilisationszubehör
Cleaning and sterilizing accessories

Accessoires pour nettoyage et stérilisation
Accesorios para limpieza y esterilización
Accessori per pulizia e sterilizzazione



tk 707-600

Reinigungspistole komplett mit 9 Adaptern
Cleaning gun complete with 9 adaptors

Pistolet de nettoyage avec 9 adaptateurs
Pistola de limpieza con 9 adaptadores
Pistola per pulire completa di 9 adattatori



	480 mm
Ø 3 mm	tk 707-604
Ø 5 mm	tk 707-605
Ø 10 mm	tk 707-610

für Ø Rohr
for Ø tube
pour Ø tube
para Ø tubos
per Ø tubi

Reinigungsbürste (10 Stück)
Cleaning brush (10 pieces)
Brosse de nettoyage (10 pièces)
Cepillo de limpieza (10 piezas)
Spazzolini (10 pezzi)

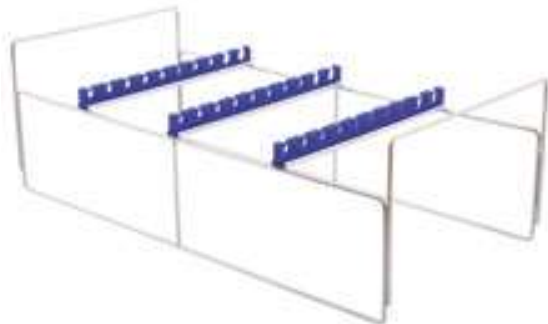

tk 87295-00

Halter für Laparoskopie-Instrumente (490 x 235 x 160 mm)
Sterilization tray for laparoscopy instruments (490 x 235 x 160 mm)
Support pour instruments de coelioscopie (490 x 235 x 160 mm)
Soporte para instrumentos de laparoscopia (490 x 235 x 160 mm)
Sostegno per strumenti di laparoscopia (490 x 235 x 160 mm)



tk 87015-20

Siebkorb (510 x 255 x 50 mm) für tk 87295-00
Wire basket (510 x 255 x 50 mm) for tk 87295-00
Panier (510 x 255 x 50 mm) pour tk 87295-00
Cesta (510 x 255 x 50 mm) para tk 87295-00
Cestello (510 x 255 x 50 mm) per tk 87295-00



tk 87200-1F-SI

Container für tk 87295-00
Container for tk 87295-00
Contenaire pour tk 87295-00
Contenedor para tk 87295-00
Container per tk 87295-00

Reinigungs- und Sterilisationszubehör
Cleaning and sterilizing accessories

Accessoires pour nettoyage et stérilisation
Accesorios para limpieza y esterilización
Accessori per pulizia e sterilizzazione



Perforierter Boden und Deckel, ohne Filter.
Silikonhalterungen für zwei Endoskope.

Perforated bottom and lid, without filter.
Silicon fittings for two endoscopes.

Couvercle et fond perforés, sans filtres.
Pièces en silicon pour 2 optiques.

Tapa y fondo perforados, sin filtros.
Piezas en silicona para 2 ópticas.

Coperchio e fondo perforato, senza filtri.
Sostegno di silicone per 2 ottiche.

250 x 60 x 50 mm		tk87280-2F-SI
250 x 60 x 50 mm		tk87280-2F-YE
250 x 60 x 50 mm		tk87280-2F-GR
250 x 60 x 50 mm		tk87280-2F-BL
250 x 60 x 50 mm		tk87280-2F-RE
250 x 60 x 50 mm		tk87280-2F-BK

Deckelfarbe
Lid colour

Couleur du couvercle
Color de la tapa
Colore del coperchio

450 x 70 x 70 mm		tk 87290-2F-SI
450 x 70 x 70 mm		tk 87290-2F-YE
450 x 70 x 70 mm		tk 87290-2F-GR
450 x 70 x 70 mm		tk 87290-2F-BL
450 x 70 x 70 mm		tk 87290-2F-RE
450 x 70 x 70 mm		tk 87290-2F-BK

Deckelfarbe
Lid colour

Couleur du couvercle
Color de la tapa
Colore del coperchio

460 x 80 x 52 mm	tk707-650
290 x 80 x 52 mm	tk707-651

Siebkorb für Optiken > ø 2,7mm
Wire basket for endoscopes > ø 2.7 mm
Panier pour optiques > ø 2,7 mm
Cesta para ópticas > ø 2,7 mm
Cestello per endoscopi con diametro > ø 2,7 mm



tk 700-999

Autoklavierbare Schutzhülse für Endoskope bis Ø 5 mm, durch Zusammenstecken von 2 Hülsen erweiterbar für Urologie / Laparoskopie / Gynäkologie - Optiken
Autoclavable protection tube for endoscopes up to Ø 5 mm, assembling of two tubes will allow a protection for Urology / Laparoscopy / Gynaecology scopes

Gaines de protection autoclavables pour optiques jusqu'au 5mm Ø. En combinant deux gaines, élargable pour des optiques d'urologie / laparoscopie et gynécologie.

Vainas de protección autoclavables para ópticas fino a Ø 5mm. Conectando dos vainas se pueden utilizar también para ópticas de Urología / Laparoscopia / Ginecología

Tubi di protezione autoclavabili per ottiche fino a 5 mm di diametro. L'assemblaggio di due tubi consentirà la protezione di ottiche per urologia/laparoscopia/ginecologia

Ersatzteile, Pflegemittel
Spare parts, detergents for instruments

Pièces de réchange, détergents
Piezas de recambio, detergentes
Pezzi di ricambio, detergenti



	30 ml	25 ml	15 ml
	tk 95000-50	tk 95000-51	tk 95000-52
Antibeslagmittel <i>Antifog solution</i>	Durchstichflasche (steril) <i>Pierce bottle (sterile)</i>	Pipettenflasche <i>Pipette bottle</i>	Sprühflasche <i>Spray bottle</i>
Solution antibuée	Bouteille perforée (stérile)	Bouteille pipette	Bouteille spray
Solución antiraho	Botella perforada (estéril)	Botella con pipeta	Botella de spray
Anti appannante	Bottiglia perforabile (sterile)	Bottiglia con pipetta	Bottiglia spray



	tk 95011-00	tk 95011-02	tk 95012-00
LL-Verschlusschrauben <i>End screws for LL channels</i>	Kunststoff, weiß <i>Plastic, white</i>	Kunststoff, schwarz <i>Plastic, black</i>	Edelstahl <i>Stainless steel</i>
Vis pour connecteur LL	Plastifié, blanc	Plastifié, noir	Acier inoxydable
Tornillos para conexión LL	Plástico blanco	Plástico negro	Acero inoxidable
Tappi di chiusura LL	Plastica bianca	Plastica nero	Acciaio inossidabile



tk 95010-00

Dichtungskappe, Silikon (10 Stück)
Silicon cap (10 pieces)

Capuchon de silicon (10 pièces)
Capuchón de silicona (10 piezas)
Cappuccio in silicone (10 pezzi)



500 ml

tk 95000-00

100 ml

tk 95100-00

TEKNO Spezial-Öl zur Instrumentenpflege
TEKNO special oil for surgical instruments

TEKNO hুলieux pour des instruments
TEKNO aceite para instrumentos

TEKNO olio speciale per strumentario chirurgico

Ersatzteile, Pflegemittel
Spare parts, detergent for instruments

Pièces de réchange, détergents
Piezas de recambio, detergentes
Pezzi di ricambio, detergenti

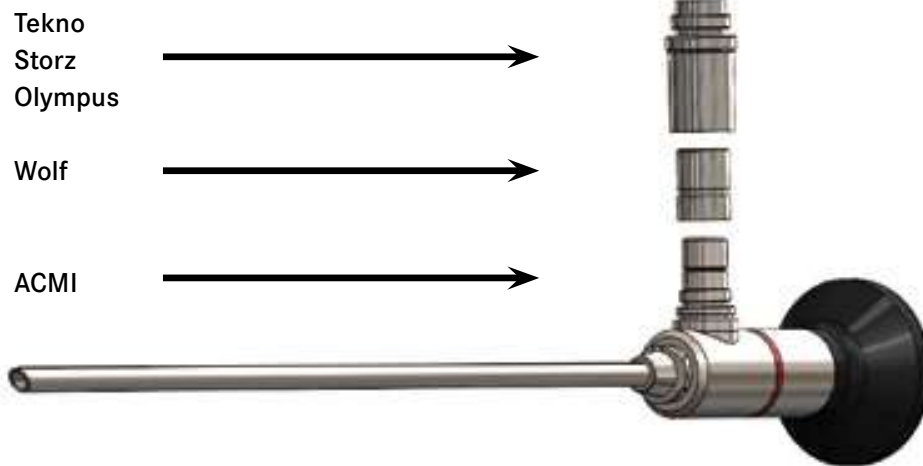

tk 700-997

Adapter für TEKNO Optiken zum Anschluss von TEKNO, Storz und Olympus Kaltlichtkabeln.
Adaptor for TEKNO endoscopes to connect TEKNO, Storz, Olympus cold light cables.

Adaptateur pour connecter des optiques TEKNO avec des cables de lumière froide TEKNO, Storz, Olympus
Adaptador para la conexión de las ópticas TEKNO con los cables de luz fría de TEKNO, Storz, Olympus
 Adattatore per ottiche TEKNO per la connessione con cavi di luce fredda TEKNO, Storz ed Olympus



tk 700-998

Adapter für TEKNO Optiken zum Anschluss von Wolf Kaltlichtkabeln.
Adaptor for TEKNO endoscopes to connect Wolf cold light cables.

Adaptateur pour connecter des optiques TEKNO avec des cables de lumière froide Wolf
Adaptador para la conexión de las ópticas TEKNO con los cables de luz fría de Wolf
 Adattatore per ottiche TEKNO per la connessione con cavi di luce fredda Wolf

Nummernverzeichnis
Numerical Index

Index numérique
Indice numerico
Indice dei numeri d'articolo

Art. No.	Page	Art. No.	Page	Art. No.	Page	Art. No.	Page
tk 700-000	8	tk 704-0018	23	tk 704-088	20	tk 704-238	22
tk 700-001	8	tk 704-0020	23	tk 704-090	20	tk 704-240	21
tk 700-002	8	tk 704-0021	23	tk 704-092	19	tk 704-241	21
tk 700-003	8	tk 704-0022	22	tk 704-093	19	tk 704-242	21
tk 700-004	8	tk 704-0023	22	tk 704-095	26	tk 704-243	21
tk 700-011	8	tk 704-0024	22	tk 704-096	26	tk 704-244	21
tk 700-012	8	tk 704-0025	22	tk 704-098	26	tk 704-245	21
tk 700-020	8	tk 704-0026	22	tk 704-100	26	tk 704-295	15
tk 700-023	8	tk 704-0027	22	tk 704-101	26	tk 704-308	16
tk 700-024	8	tk 704-006	19	tk 704-104	26	tk 704-360	5
tk 700-028	8	tk 704-006-15	19	tk 704-106	72	tk 704-360	15
tk 700-029	8	tk 704-012-15	19	tk 704-107	72	tk 704-362	17
tk 700-030	9	tk 704-0122	23	tk 704-108	72	tk 704-365	15
tk 700-033	9	tk 704-0123	23	tk 704-109	51	tk 704-367	18
tk 700-203	9	tk 704-0124	23	tk 704-109 C	51	tk 704-368	18
tk 700-204	9	tk 704-0124	23	tk 704-109 CS	51	tk 704-389 K	22
tk 700-205	9	tk 704-0124	23	tk 704-109-25	51	tk 704-390 K	22
tk 700-250	10	tk 704-0124	23	tk 704-109-25 C	51	tk 704-395 K	22
tk 700-251	10	tk 704-0127	23	tk 704-109-25 CS	51	tk 704-397 K	22
tk 700-255	10	tk 704-0127	23	tk 704-109-45	51	tk 704-398 K	22
tk 700-256	10	tk 704-0128	23	tk 704-109-45 C	51	tk 704-399 K	22
tk 700-275	9	tk 704-0129	23	tk 704-109-45 CS	51	tk 704-4002-15	15
tk 700-275SF	9	tk 704-014	19	tk 704-110	82	tk 704-4010-15	15
tk 700-276	9	tk 704-015	19	tk 704-111	82	tk 704-4012-15	15
tk 700-276SF	9	tk 704-016	19	tk 704-112	83	tk 704-436	21
tk 700-300	8	tk 704-016-15	19	tk 704-113	83	tk 704-437	21
tk 700-301	8	tk 704-018	19	tk 704-115	82	tk 704-438	21
tk 700-302	8	tk 704-020	19	tk 704-120	29	tk 704-439	21
tk 700-310	8	tk 704-0200	23	tk 704-121	29	tk 704-440	21
tk 700-311	8	tk 704-0200A	23	tk 704-122	29	tk 704-580	28
tk 700-312	8	tk 704-0200A	23	tk 704-123	81	tk 704-582	28
tk 700-420	8	tk 704-0201	23	tk 704-123-45	81	tk 704-602	29
tk 700-423	8	tk 704-0201A	23	tk 704-124	81	tk 704-603	29
tk 700-424	8	tk 704-0201A	23	tk 704-124-45	81	tk 704-605	28
tk 700-430	8	tk 704-0202	23	tk 704-125	82	tk 704-607	28
tk 700-433	8	tk 704-0204	23	tk 704-150	26	tk 704-608	28
tk 700-450	8	tk 704-0204	23	tk 704-151	26	tk 704-609	28
tk 700-453	8	tk 704-0205	23	tk 704-152	26	tk 704-610	28
tk 700-990	11	tk 704-022	19	tk 704-154	26	tk 704-642	27
tk 700-997	95	tk 704-022-15	19	tk 704-156	26	tk 704-644	27
tk 700-998	95	tk 704-026	19	tk 704-157	26	tk 704-646	27
tk 700-999	93	tk 704-026-15	19	tk 704-160	20	tk 704-650	27
tk 701-022	78	tk 704-027-15	19	tk 704-161	20	tk 704-652	27
tk 703-100 LL	78	tk 704-028	19	tk 704-162	20	tk 704-654	27
tk 703-102 LL	78	tk 704-029	19	tk 704-200	21	tk 704-656	27
tk 703-510 LL	78	tk 704-031	19	tk 704-203	21	tk 704-658	27
tk 703-512 LL	78	tk 704-033	19	tk 704-204	21	tk 704-660	27
tk 704-000	21	tk 704-035	19	tk 704-207	21	tk 704-662	27
tk 704-0002	23	tk 704-036	19	tk 704-216	21	tk 704-670	15
tk 704-0004	23	tk 704-060	20	tk 704-217	21	tk 704-671	15
tk 704-0004	23	tk 704-061	20	tk 704-218	21	tk 704-672	15
tk 704-0004A	23	tk 704-065	20	tk 704-220	25	tk 704-673	15
tk 704-0006	23	tk 704-067	20	tk 704-221	25	tk 704-674	15
tk 704-0008	23	tk 704-070	19	tk 704-222	25	tk 704-675	15
tk 704-0008	23	tk 704-072	19	tk 704-223	25	tk 704-676	15
tk 704-0008	23	tk 704-076	20	tk 704-224	25	tk 704-677	15
tk 704-0010	23	tk 704-077	20	tk 704-225	25	tk 704-678	15
tk 704-0010	23	tk 704-078	20	tk 704-233	21	tk 704-679	17
tk 704-0013	23	tk 704-087	20	tk 704-235	22	tk 704-680	17

Nummernverzeichnis
Numerical Index

Index numérique
Indice numerico
Indice dei numeri d'articolo

Art. No.	Page	Art. No.	Page	Art. No.	Page	Art. No.	Page
tk704-681	17	tk706-176	85	tk707-041	66	tk707-161	87
tk704-682	17	tk706-180	33	tk707-042	66	tk707-162	87
tk704-683	17	tk706-180-45	33	tk707-044	67	tk707-170	71
tk704-684	17	tk706-182	33	tk707-045	67	tk707-170-45	71
tk704-685	17	tk706-182-45	33	tk707-046	67	tk707-171	71
tk704-686	17	tk706-184	33	tk707-047	67	tk707-171-45	71
tk704-687	14	tk706-184-45	33	tk707-070	71	tk707-172	71
tk704-688	14	tk706-186	33	tk707-070-45	71	tk707-173	71
tk704-689	14	tk706-186-45	33	tk707-071	71	tk707-173-45	71
tk704-690	14	tk706-187	33	tk707-071-45	71	tk707-300	88
tk704-691	14	tk706-187-45	33	tk707-072	71	tk707-301	88
tk704-692	14	tk706-191	85	tk707-073	71	tk707-302	88
tk704-693	14	tk706-192	85	tk707-073-45	71	tk707-303	88
tk704-694	14	tk706-193	85	tk707-100 ZDR	68	tk707-330	88
tk704-715	30	tk706-194	85	tk707-101 ZDR	68	tk707-331	88
tk704-720	30	tk706-195	85	tk707-103 ZDR	68	tk707-332	88
tk704-721	30	tk706-196	85	tk707-105 ZDR	68	tk707-333	88
tk704-722	30	tk707-000 E	68	tk707-106 ZDR	68	tk707-338	88
tk704-730	30	tk707-000 ZDR	68	tk707-108 ZDR	69	tk707-340	66
tk704-731	30	tk707-001 E	68	tk707-109 ZDR	69	tk707-341	66
tk704-732	30	tk707-001 ZDR	68	tk707-112 ZDR	65	tk707-342	66
tk704-745	30	tk707-003 E	68	tk707-113 ZDR	65	tk707-343	66
tk704-750	31	tk707-003 ZDR	68	tk707-120	70	tk707-510	86
tk704-751	31	tk707-005 E	68	tk707-120-25	70	tk707-511	86
tk704-752	31	tk707-005 ZDR	68	tk707-120-45	70	tk707-520	86
tk704-752-45	31	tk707-006 E	68	tk707-121	70	tk707-521	86
tk704-753	31	tk707-006 ZDR	68	tk707-121-25	70	tk707-525	86
tk704-753-45	31	tk707-008 E	69	tk707-121-45	70	tk707-526	86
tk704-760	31	tk707-008 ZDR	69	tk707-122	70	tk707-600	92
tk704-761	32	tk707-009 E	69	tk707-122-45	70	tk707-604	92
tk704-762	32	tk707-009 ZDR	69	tk707-123	70	tk707-605	92
tk704-763	32	tk707-010	69	tk707-123-45	70	tk707-610	92
tk704-764	32	tk707-012 E	65	tk707-124	70	tk707-650	93
tk704-765	32	tk707-012 ZDR	65	tk707-124-25	70	tk707-651	93
tk704-800	25	tk707-013	69	tk707-124-45	70	tk708-100 LL	77
tk704-801	25	tk707-013 E	65	tk707-125	70	tk708-110 LL	77
tk704-802	25	tk707-013 ZDR	65	tk707-125-25	70	tk708-511 LL	77
tk704-803	25	tk707-014	69	tk707-125-45	70	tk708-512 LL	77
tk705-001	72	tk707-015	69	tk707-126	70	tk708-513 LL	77
tk705-002	72	tk707-016	69	tk707-126-45	70	tk708-520	76
tk705-004	72	tk707-020	70	tk707-131	70	tk708-521	76
tk705-005	72	tk707-020-25	70	tk707-131-25	70	tk708-522	76
tk706-150	84	tk707-020-45	70	tk707-131-45	70	tk708-530	77
tk706-152	84	tk707-021	70	tk707-132	70	tk708-540	74
tk706-152-45	84	tk707-021-25	70	tk707-133	71	tk708-541	74
tk706-154	84	tk707-021-45	70	tk707-133-45	71	tk708-542	74
tk706-154-45	84	tk707-022	70	tk707-134	71	tk708-543	74
tk706-156	84	tk707-022-45	70	tk707-140	67	tk708-544	74
tk706-156-45	84	tk707-023	70	tk707-141	67	tk708-545	74
tk706-158	84	tk707-023-45	70	tk707-142	67	tk708-546	74
tk706-158-45	84	tk707-024	70	tk707-144	67	tk708-547	74
tk706-159	84	tk707-024-25	70	tk707-145	67	tk708-548	74
tk706-159-45	84	tk707-024-45	70	tk707-146	67	tk708-549	74
tk706-170	85	tk707-025	70	tk707-147	67	tk708-550	74
tk706-171	85	tk707-025-25	70	tk707-150	87	tk708-551	74
tk706-172	85	tk707-025-45	70	tk707-151	87	tk708-552	74
tk706-173	85	tk707-026	70	tk707-152	87	tk708-553	74
tk706-174	85	tk707-026-45	70	tk707-153	87	tk708-554	74
tk706-175	85	tk707-040	66	tk707-160	87	tk708-555	74

Nummernverzeichnis
Numerical Index
Index numérique
Indice numerico
Indice dei numeri d'articolo

Art. No.	Page	Art. No.	Page	Art. No.	Page	Art. No.	Page
tk 708-556	74	tk 708-773	80	tk 775-4004	35	tk 775-4025 C	44
tk 708-557	74	tk 712-440	24	tk 775-4005	35	tk 775-4025-25	44
tk 708-558	74	tk 712-441	24	tk 775-4006	36	tk 775-4025-25 C	44
tk 708-559	74	tk 712-442	24	tk 775-4009	37	tk 775-4025-45	44
tk 708-560	74	tk 712-443	24	tk 775-4010	37	tk 775-4025-45 C	44
tk 708-561	74	tk 712-450	24	tk 775-4010-45LL	37	tk 775-4026	44
tk 708-562	74	tk 712-451	24	tk 775-4010LL	37	tk 775-4026 C	44
tk 708-563	74	tk 712-452	24	tk 775-4011	37	tk 775-4026 TS	42
tk 708-564	74	tk 712-453	24	tk 775-4012	37	tk 775-4026 TSC	42
tk 708-565	74	tk 712-460	24	tk 775-4012-25	37	tk 775-4026 TSCM	42
tk 708-566	74	tk 712-461	24	tk 775-4012-45	37	tk 775-4026-25	44
tk 708-567	74	tk 712-462	24	tk 775-4013	37	tk 775-4026-25 C	44
tk 708-568	74	tk 712-463	24	tk 775-4014	37	tk 775-4026-25 TS	42
tk 708-569	74	tk 712-470	24	tk 775-4015	37	tk 775-4026-25 TSC	42
tk 708-570	74	tk 712-471	24	tk 775-4016	37	tk 775-4026-25 TSCM	42
tk 708-571	74	tk 712-472	24	tk 775-4020	44	tk 775-4026-45	44
tk 708-634	75	tk 712-473	24	tk 775-4020 C	44	tk 775-4026-45 C	44
tk 708-635	75	tk 730-160	13	tk 775-4020 TS	42	tk 775-4026-45 TS	42
tk 708-636	75	tk 730-161	19	tk 775-4020 TSC	42	tk 775-4026-45 TSC	42
tk 708-637	75	tk 730-162	19	tk 775-4020 TSCM	42	tk 775-4026-45 TSCM	42
tk 708-638	75	tk 730-170	13	tk 775-4020-25	44	tk 775-4027	44
tk 708-639	75	tk 730-171	19	tk 775-4020-25 C	44	tk 775-4027 C	44
tk 708-640	75	tk 730-172	19	tk 775-4020-25 TS	42	tk 775-4027 TS	42
tk 708-641	75	tk 730-210	17	tk 775-4020-25 TSC	42	tk 775-4027 TSC	42
tk 708-644	75	tk 730-220	19	tk 775-4020-25 TSCM	42	tk 775-4027 TSCM	42
tk 708-645	75	tk 754-159	26	tk 775-4020-45	44	tk 775-4027-25	44
tk 708-648	75	tk 760-000	25	tk 775-4020-45 C	44	tk 775-4027-25 C	44
tk 708-649	75	tk 760-000-25	25	tk 775-4020-45 TS	42	tk 775-4027-25 TS	42
tk 708-652	75	tk 762-101	84	tk 775-4020-45 TSC	42	tk 775-4027-25 TSC	42
tk 708-653	75	tk 762-101-25	84	tk 775-4020-45 TSCM	42	tk 775-4027-25 TSCM	42
tk 708-656	75	tk 762-102	84	tk 775-4021	52	tk 775-4027-45	44
tk 708-657	75	tk 762-102-25	84	tk 775-4021 C	52	tk 775-4027-45 C	44
tk 708-660	75	tk 762-103	84	tk 775-4021 CS	52	tk 775-4027-45 TS	42
tk 708-661	75	tk 762-103-25	84	tk 775-4021-25	52	tk 775-4027-45 TSC	42
tk 708-680	79	tk 762-104	84	tk 775-4021-25 C	52	tk 775-4027-45 TSCM	42
tk 708-701	79	tk 762-104-25	84	tk 775-4021-25 CS	52	tk 775-4030	45
tk 708-702	79	tk 762-105	84	tk 775-4021-45	52	tk 775-4030 C	45
tk 708-703	79	tk 762-105-25	84	tk 775-4021-45 C	52	tk 775-4030 CS	45
tk 708-705 / LT 100	80	tk 770-110	27	tk 775-4021-45 CS	52	tk 775-4030-25	45
tk 708-706 / LT 200	80	tk 770-110-25	27	tk 775-4022	44	tk 775-4030-25 C	45
tk 708-707 / LT 300	80	tk 770-111	27	tk 775-4022	5	tk 775-4030-25 CS	45
tk 708-708 / LT 400	80	tk 770-111-25	27	tk 775-4022 C	44	tk 775-4030-45	45
tk 708-710	79	tk 775-3928	44	tk 775-4022-25	44	tk 775-4030-45 C	45
tk 708-711	79	tk 775-3928 C	44	tk 775-4022-25 C	44	tk 775-4030-45 CS	45
tk 708-712	79	tk 775-3928-25	44	tk 775-4022-45	44	tk 775-4031	45
tk 708-713	79	tk 775-3928-25 C	44	tk 775-4022-45 C	44	tk 775-4031 C	45
tk 708-741	80	tk 775-3928-45	44	tk 775-4023	44	tk 775-4031 CS	45
tk 708-742	80	tk 775-3928-45 C	44	tk 775-4023 C	44	tk 775-4031-25	45
tk 708-743	80	tk 775-3929	44	tk 775-4023-25	44	tk 775-4031-25 C	45
tk 708-750	80	tk 775-3929 C	44	tk 775-4023-25 C	44	tk 775-4031-25 CS	45
tk 708-751	80	tk 775-3929-25	44	tk 775-4023-45	44	tk 775-4031-45	45
tk 708-752	80	tk 775-3929-25 C	44	tk 775-4023-45 C	44	tk 775-4031-45 C	45
tk 708-753	80	tk 775-3929-45	44	tk 775-4024	44	tk 775-4031-45 CS	45
tk 708-761	80	tk 775-3929-45 C	44	tk 775-4024 C	44	tk 775-4032	45
tk 708-762	80	tk 775-3995	35	tk 775-4024-25	44	tk 775-4032 C	45
tk 708-763	80	tk 775-4000	36	tk 775-4024-25 C	44	tk 775-4032 CS	45
tk 708-770	80	tk 775-4001	36	tk 775-4024-45	44	tk 775-4032-25	45
tk 708-771	80	tk 775-4002	36	tk 775-4024-45 C	44	tk 775-4032-25 C	45
tk 708-772	80	tk 775-4003	35	tk 775-4025	44	tk 775-4032-25 CS	45

Nummernverzeichnis
Numerical Index

Index numérique
Indice numerico
Indice dei numeri d'articolo

Art. No.	Page	Art. No.	Page	Art. No.	Page	Art. No.	Page
tk775-4032-45	45	tk775-4053 CS	51	tk775-4067-45 C	48	tk775-4074-25	49
tk775-4032-45 C	45	tk775-4053-25	51	tk775-4067-45 CS	48	tk775-4074-25 C	49
tk775-4032-45 CS	45	tk775-4053-25 C	51	tk775-4068	49	tk775-4074-25 CS	49
tk775-4033	45	tk775-4053-25 CS	51	tk775-4068 C	49	tk775-4074-45	49
tk775-4033 C	45	tk775-4053-45	51	tk775-4068 CS	49	tk775-4074-45 C	49
tk775-4033 CS	45	tk775-4053-45 C	51	tk775-4068-25	49	tk775-4074-45 CS	49
tk775-4033-25	45	tk775-4053-45 CS	51	tk775-4068-25 C	49	tk775-4075	52
tk775-4033-25 C	45	tk775-4062	46	tk775-4068-25 CS	49	tk775-4075 C	52
tk775-4033-25 CS	45	tk775-4062 C	46	tk775-4068-45	49	tk775-4075 CS	52
tk775-4033-45	45	tk775-4062 CS	46	tk775-4068-45 C	49	tk775-4075-25	52
tk775-4033-45 C	45	tk775-4062-25	46	tk775-4068-45 CS	49	tk775-4075-25 C	52
tk775-4033-45 CS	45	tk775-4062-25 C	46	tk775-4069	52	tk775-4075-25 CS	52
tk775-4034	45	tk775-4062-25 CS	46	tk775-4069 C	52	tk775-4075-45	52
tk775-4034 C	45	tk775-4062-45	46	tk775-4069 CS	52	tk775-4075-45 C	52
tk775-4034 CS	45	tk775-4062-45C	46	tk775-4069-25	52	tk775-4075-45 CS	52
tk775-4034-25	45	tk775-4062-45CS	46	tk775-4069-25 C	52	tk775-4076	49
tk775-4034-25 C	45	tk775-4063	48	tk775-4069-25 CS	52	tk775-4076 C	49
tk775-4034-25 CS	45	tk775-4063 C	48	tk775-4069-45	52	tk775-4076 CS	49
tk775-4034-45	45	tk775-4063 CS	48	tk775-4069-45 C	52	tk775-4076-25	49
tk775-4034-45 C	45	tk775-4063-25	48	tk775-4069-45 CS	52	tk775-4076-25 C	49
tk775-4034-45 CS	45	tk775-4063-25 C	48	tk775-4070	54	tk775-4076-25 CS	49
tk775-4035	49	tk775-4063-25 CS	48	tk775-4070 C	54	tk775-4076-45	49
tk775-4035 C	49	tk775-4063-45	48	tk775-4070 CS	54	tk775-4076-45 C	49
tk775-4035 CS	49	tk775-4063-45 C	48	tk775-4070-25	54	tk775-4076-45 CS	49
tk775-4035-25	49	tk775-4063-45 CS	48	tk775-4070-25 C	54	tk775-4078	51
tk775-4035-25 C	49	tk775-4064	52	tk775-4070-25 CS	54	tk775-4078 C	51
tk775-4035-25 CS	49	tk775-4064 C	52	tk775-4070-45	54	tk775-4078 CS	51
tk775-4035-45	49	tk775-4064 CS	52	tk775-4070-45 C	54	tk775-4078-25	51
tk775-4035-45 C	49	tk775-4064-25	52	tk775-4070-45 CS	54	tk775-4078-25 C	51
tk775-4035-45 CS	49	tk775-4064-25 C	52	tk775-4071	54	tk775-4078-25 CS	51
tk775-4036	48	tk775-4064-25 CS	52	tk775-4071 C	54	tk775-4078-45	51
tk775-4036 C	48	tk775-4064-45	52	tk775-4071 CS	54	tk775-4078-45 C	51
tk775-4036 CS	48	tk775-4064-45 C	52	tk775-4071-25	54	tk775-4078-45 CS	51
tk775-4036-25	48	tk775-4064-45 CS	52	tk775-4071-25 C	54	tk775-4079	49
tk775-4036-25 C	48	tk775-4065	51	tk775-4071-25 CS	54	tk775-4079 C	49
tk775-4036-25 CS	48	tk775-4065 C	51	tk775-4071-45	54	tk775-4079 CS	49
tk775-4036-45	48	tk775-4065 CS	51	tk775-4071-45 C	54	tk775-4079-25	49
tk775-4036-45 C	48	tk775-4065-25	51	tk775-4071-45 CS	54	tk775-4079-25 C	49
tk775-4036-45 CS	48	tk775-4065-25 C	51	tk775-4072	51	tk775-4079-25 CS	49
tk775-4037	48	tk775-4065-25 CS	51	tk775-4072 C	51	tk775-4079-45	49
tk775-4037 C	48	tk775-4065-45	51	tk775-4072 CS	51	tk775-4079-45 C	49
tk775-4037 CS	48	tk775-4065-45 C	51	tk775-4072-25	51	tk775-4079-45 CS	49
tk775-4037-25	48	tk775-4065-45 CS	51	tk775-4072-25 C	51	tk775-4080	48
tk775-4037-25 C	48	tk775-4066	45	tk775-4072-25 CS	51	tk775-4080 C	48
tk775-4037-25 CS	48	tk775-4066 C	45	tk775-4072-45	51	tk775-4080 CS	48
tk775-4037-45	48	tk775-4066 CS	45	tk775-4072-45 C	51	tk775-4080-25	48
tk775-4037-45 C	48	tk775-4066-25	45	tk775-4072-45 CS	51	tk775-4080-25 C	48
tk775-4037-45 CS	48	tk775-4066-25 C	45	tk775-4073	51	tk775-4080-25 CS	48
tk775-4038	48	tk775-4066-25 CS	45	tk775-4073 C	51	tk775-4080-45	48
tk775-4038 C	48	tk775-4066-45	45	tk775-4073 CS	51	tk775-4080-45 C	48
tk775-4038 CS	48	tk775-4066-45 C	45	tk775-4073-25	51	tk775-4080-45 CS	48
tk775-4038-25	48	tk775-4066-45 CS	45	tk775-4073-25 C	51	tk775-4081	49
tk775-4038-25 C	48	tk775-4067	48	tk775-4073-25 CS	51	tk775-4081 C	49
tk775-4038-25 CS	48	tk775-4067 C	48	tk775-4073-45	51	tk775-4081 CS	49
tk775-4038-45	48	tk775-4067 CS	48	tk775-4073-45 C	51	tk775-4081-25	49
tk775-4038-45 C	48	tk775-4067-25	48	tk775-4073-45 CS	51	tk775-4081-25 C	49
tk775-4038-45 CS	48	tk775-4067-25 C	48	tk775-4074	49	tk775-4081-25 CS	49
tk775-4053	51	tk775-4067-25 CS	48	tk775-4074 C	49	tk775-4081-45	49
tk775-4053 C	51	tk775-4067-45	48	tk775-4074 CS	49	tk775-4081-45 C	49

Nummernverzeichnis
Numerical Index

Index numérique
Indice numerico
Indice dei numeri d'articolo

Art. No.	Page	Art. No.	Page	Art. No.	Page	Art. No.	Page
tk 775-4081-45 CS	49	tk 775-4088-25 C	52	tk 775-4095	48	tk 775-4101-25 CS	50
tk 775-4082	47	tk 775-4088-25 CS	52	tk 775-4095 C	48	tk 775-4101-45	50
tk 775-4082 C	47	tk 775-4088-45	52	tk 775-4095 CS	48	tk 775-4101-45 C	50
tk 775-4082 CS	47	tk 775-4088-45 C	52	tk 775-4095-25	48	tk 775-4101-45 CS	50
tk 775-4082-25	47	tk 775-4088-45 CS	52	tk 775-4095-25 C	48	tk 775-4110	37
tk 775-4082-25 C	47	tk 775-4089	51	tk 775-4095-25 CS	48	tk 775-4111	37
tk 775-4082-25 CS	47	tk 775-4089 C	51	tk 775-4095-45	48	tk 775-4112	37
tk 775-4082-45	47	tk 775-4089 CS	51	tk 775-4095-45 C	48	tk 775-4113	37
tk 775-4082-45 C	47	tk 775-4089-25	51	tk 775-4095-45 CS	48	tk 775-4114	37
tk 775-4082-45 CS	47	tk 775-4089-25 C	51	tk 775-4096	46	tk 775-4114-25	37
tk 775-4083	46	tk 775-4089-25 CS	51	tk 775-4096 C	46	tk 775-4114-45	37
tk 775-4083 C	46	tk 775-4089-45	51	tk 775-4096 CS	46	tk 775-4119	47
tk 775-4083 CS	46	tk 775-4089-45 C	51	tk 775-4096-25	46	tk 775-4119 C	47
tk 775-4083-25	46	tk 775-4089-45 CS	51	tk 775-4096-25 C	46	tk 775-4119 CS	47
tk 775-4083-25 C	46	tk 775-4090	49	tk 775-4096-25 CS	46	tk 775-4119-25	47
tk 775-4083-25 CS	46	tk 775-4090 C	49	tk 775-4096-45	46	tk 775-4119-25 C	47
tk 775-4083-45	46	tk 775-4090 CS	49	tk 775-4096-45 C	46	tk 775-4119-25 CS	47
tk 775-4083-45 C	46	tk 775-4090-25	49	tk 775-4096-45 CS	46	tk 775-4119-45	47
tk 775-4083-45 CS	46	tk 775-4090-25 C	49	tk 775-4097	46	tk 775-4119-45 C	47
tk 775-4084	46	tk 775-4090-25 CS	49	tk 775-4097 C	46	tk 775-4119-45 CS	47
tk 775-4084 C	46	tk 775-4090-45	49	tk 775-4097 CS	46	tk 775-4120	47
tk 775-4084 CS	46	tk 775-4090-45 C	49	tk 775-4097-25	46	tk 775-4120 C	47
tk 775-4084-25	46	tk 775-4090-45 CS	49	tk 775-4097-25 C	46	tk 775-4120 CS	47
tk 775-4084-25 C	46	tk 775-4091	50	tk 775-4097-25 CS	46	tk 775-4120-25	47
tk 775-4084-25 CS	46	tk 775-4091 C	50	tk 775-4097-45	46	tk 775-4120-25 C	47
tk 775-4084-45	46	tk 775-4091 CS	50	tk 775-4097-45 C	46	tk 775-4120-25 CS	47
tk 775-4084-45 C	46	tk 775-4091-25	50	tk 775-4097-45 CS	46	tk 775-4120-45	47
tk 775-4084-45 CS	46	tk 775-4091-25 C	50	tk 775-4098	53	tk 775-4120-45 C	47
tk 775-4085	46	tk 775-4091-25 CS	50	tk 775-4098 C	53	tk 775-4120-45 CS	47
tk 775-4085 C	46	tk 775-4091-45	50	tk 775-4098 CS	53	tk 775-4121	47
tk 775-4085 CS	46	tk 775-4091-45 C	50	tk 775-4098-25	53	tk 775-4121 C	47
tk 775-4085-25	46	tk 775-4091-45 CS	50	tk 775-4098-25 C	53	tk 775-4121 CS	47
tk 775-4085-25 C	46	tk 775-4092	53	tk 775-4098-25 CS	53	tk 775-4121-25	47
tk 775-4085-25 CS	46	tk 775-4092 C	53	tk 775-4098-45	53	tk 775-4121-25 C	47
tk 775-4085-45	46	tk 775-4092 CS	53	tk 775-4098-45 C	53	tk 775-4121-25 CS	47
tk 775-4085-45 C	46	tk 775-4092-25	53	tk 775-4098-45 CS	53	tk 775-4121-45	47
tk 775-4085-45 CS	46	tk 775-4092-25 C	53	tk 775-4099	50	tk 775-4121-45 C	47
tk 775-4086	46	tk 775-4092-25 CS	53	tk 775-4099 C	50	tk 775-4121-45 CS	47
tk 775-4086 C	46	tk 775-4092-45	53	tk 775-4099 CS	50	tk 775-4210 TS	43
tk 775-4086 CS	46	tk 775-4092-45 C	53	tk 775-4099-25	50	tk 775-4210 TSC	43
tk 775-4086-25	46	tk 775-4092-45 CS	53	tk 775-4099-25 C	50	tk 775-4210 TSCS	43
tk 775-4086-25 C	46	tk 775-4093	47	tk 775-4099-25 CS	50	tk 775-4210-25 TS	43
tk 775-4086-25 CS	46	tk 775-4093 C	47	tk 775-4099-45	50	tk 775-4210-25 TSC	43
tk 775-4086-45	46	tk 775-4093 CS	47	tk 775-4099-45 C	50	tk 775-4210-25 TSCS	43
tk 775-4086-45 C	46	tk 775-4093-25	47	tk 775-4099-45 CS	50	tk 775-4210-45 TS	43
tk 775-4086-45 CS	46	tk 775-4093-25 C	47	tk 775-4100	50	tk 775-4210-45 TSC	43
tk 775-4087	46	tk 775-4093-25 CS	47	tk 775-4100 C	50	tk 775-4210-45 TSCS	43
tk 775-4087 C	46	tk 775-4093-45	47	tk 775-4100 CS	50	tk 775-4212 TS	43
tk 775-4087 CS	46	tk 775-4093-45 C	47	tk 775-4100-25	50	tk 775-4212 TSC	43
tk 775-4087-25	46	tk 775-4093-45 CS	47	tk 775-4100-25 C	50	tk 775-4212 TSCS	43
tk 775-4087-25 C	46	tk 775-4094	48	tk 775-4100-25 CS	50	tk 775-4212-25 TS	43
tk 775-4087-25 CS	46	tk 775-4094 C	48	tk 775-4100-45	50	tk 775-4212-25 TSC	43
tk 775-4087-45	46	tk 775-4094 CS	48	tk 775-4100-45 C	50	tk 775-4212-25 TSCS	43
tk 775-4087-45 C	46	tk 775-4094-25	48	tk 775-4100-45 CS	50	tk 775-4212-45 TS	43
tk 775-4087-45 CS	46	tk 775-4094-25 C	48	tk 775-4101	50	tk 775-4212-45 TSC	43
tk 775-4088	52	tk 775-4094-25 CS	48	tk 775-4101 C	50	tk 775-4212-45 TSCS	43
tk 775-4088 C	52	tk 775-4094-45	48	tk 775-4101 CS	50	tk 775-4213 TS	43
tk 775-4088 CS	52	tk 775-4094-45 C	48	tk 775-4101-25	50	tk 775-4213 TSC	43
tk 775-4088-25	52	tk 775-4094-45 CS	48	tk 775-4101-25 C	50	tk 775-4213 TSCS	43

Nummernverzeichnis
Numerical Index

Index numérique
Indice numerico
Indice dei numeri d'articolo

Art. No.	Page	Art. No.	Page	Art. No.	Page	Art. No.	Page
tk775-4213-25 TS	43	tk775-4228-45 CS	52	tk775-4243-25 C	47	tk775-5021-45 C	62
tk775-4213-25 TSC	43	tk775-4229	53	tk775-4243-25 CS	47	tk775-5021-45 CS	62
tk775-4213-25 TSCS	43	tk775-4229 C	53	tk775-4243-45	47	tk775-5022	62
tk775-4213-45 TS	43	tk775-4229 CS	53	tk775-4243-45 C	47	tk775-5022 C	62
tk775-4213-45 TSC	43	tk775-4229-25	53	tk775-4243-45 CS	47	tk775-5022 CS	62
tk775-4213-45 TSCS	43	tk775-4229-25 C	53	tk775-4244	51	tk775-5022-25	62
tk775-4214 TS	43	tk775-4229-25 CS	53	tk775-4244 C	51	tk775-5022-25 C	62
tk775-4214 TSC	43	tk775-4229-45	53	tk775-4244 CS	51	tk775-5022-25 CS	62
tk775-4214 TSCS	43	tk775-4229-45 C	53	tk775-4244-25	51	tk775-5022-45	62
tk775-4214-25 TS	43	tk775-4229-45 CS	53	tk775-4244-25 C	51	tk775-5022-45 C	62
tk775-4214-25 TSC	43	tk775-4232	50	tk775-4244-25 CS	51	tk775-5022-45 CS	62
tk775-4214-25 TSCS	43	tk775-4232 C	50	tk775-4244-45	51	tk775-5023	63
tk775-4214-45 TS	43	tk775-4232 CS	50	tk775-4244-45 C	51	tk775-5023 C	63
tk775-4214-45 TSC	43	tk775-4232-25	50	tk775-4244-45 CS	51	tk775-5023 CS	63
tk775-4214-45 TSCS	43	tk775-4232-25 C	50	tk775-4245	45	tk775-5023-25	63
tk775-4222	52	tk775-4232-25 CS	50	tk775-4245 C	45	tk775-5023-25 C	63
tk775-4222 C	52	tk775-4232-45	50	tk775-4245 CS	45	tk775-5023-25 CS	63
tk775-4222 CS	52	tk775-4232-45 C	50	tk775-4245-25	45	tk775-5023-45	63
tk775-4222-25	52	tk775-4232-45 CS	50	tk775-4245-25 C	45	tk775-5023-45 C	63
tk775-4222-25 C	52	tk775-4233	53	tk775-4245-25 CS	45	tk775-5023-45 CS	63
tk775-4222-25 CS	52	tk775-4233 C	53	tk775-4245-45	45	tk775-5024	63
tk775-4222-45	52	tk775-4233 CS	53	tk775-4245-45 C	45	tk775-5024 C	63
tk775-4222-45 C	52	tk775-4233-25	53	tk775-4245-45 CS	45	tk775-5024 CS	63
tk775-4222-45 CS	52	tk775-4233-25 C	53	tk775-4246	53	tk775-5024-25	63
tk775-4224	53	tk775-4233-25 CS	53	tk775-4246 C	53	tk775-5024-25 C	63
tk775-4224 C	53	tk775-4233-45	53	tk775-4246 CS	53	tk775-5024-25 CS	63
tk775-4224 CS	53	tk775-4233-45 C	53	tk775-4246-25	53	tk775-5024-45	63
tk775-4224-25	53	tk775-4233-45 CS	53	tk775-4246-25 C	53	tk775-5024-45 C	63
tk775-4224-25 C	53	tk775-4234	53	tk775-4246-25 CS	53	tk775-5024-45 CS	63
tk775-4224-25 CS	53	tk775-4234 C	53	tk775-4246-45	53	tk775-5025	59
tk775-4224-45	53	tk775-4234 CS	53	tk775-4246-45 C	53	tk775-5025 C	59
tk775-4224-45 C	53	tk775-4234-25	53	tk775-4246-45 CS	53	tk775-5025 CS	59
tk775-4224-45 CS	53	tk775-4234-25 C	53	tk775-4249	50	tk775-5025-25	59
tk775-4225	49	tk775-4234-25 CS	53	tk775-4249 C	50	tk775-5025-25 C	59
tk775-4225 C	49	tk775-4234-45	53	tk775-4249 CS	50	tk775-5025-25 CS	59
tk775-4225 CS	49	tk775-4234-45 C	53	tk775-4249-25	50	tk775-5025-45	59
tk775-4225-25	49	tk775-4234-45 CS	53	tk775-4249-25 C	50	tk775-5025-45 C	59
tk775-4225-25 C	49	tk775-4235	50	tk775-4249-25 CS	50	tk775-5025-45 CS	59
tk775-4225-25 CS	49	tk775-4235 C	50	tk775-4249-45	50	tk775-5026	64
tk775-4225-45	49	tk775-4235 CS	50	tk775-4249-45 C	50	tk775-5026 C	64
tk775-4225-45 C	49	tk775-4235-25	50	tk775-4249-45 CS	50	tk775-5026 CS	64
tk775-4225-45 CS	49	tk775-4235-25 CS	50	tk775-4253	54	tk775-5026-25	64
tk775-4226	54	tk775-4235-25 CS	50	tk775-4253 C	54	tk775-5026-25 C	64
tk775-4226 C	54	tk775-4235-45	50	tk775-4253 CS	54	tk775-5026-25 CS	64
tk775-4226 CS	54	tk775-4235-45 C	50	tk775-4253-25	54	tk775-5026-45	64
tk775-4226-25	54	tk775-4235-45 CS	50	tk775-4253-25 C	54	tk775-5026-45 C	64
tk775-4226-25 C	54	tk775-4236	50	tk775-4253-25 CS	54	tk775-5026-45 CS	64
tk775-4226-25 CS	54	tk775-4236 C	50	tk775-4253-45	54	tk775-5027	62
tk775-4226-45	54	tk775-4236 CS	50	tk775-4253-45 C	54	tk775-5027 C	62
tk775-4226-45 C	54	tk775-4236-25	50	tk775-4253-45 CS	54	tk775-5027 CS	62
tk775-4226-45 CS	54	tk775-4236-25 C	50	tk775-4303	36	tk775-5027-25	62
tk775-4228	52	tk775-4236-25 CS	50	tk775-4304	36	tk775-5027-25 C	62
tk775-4228 C	52	tk775-4236-45	50	tk775-5021	62	tk775-5027-25 CS	62
tk775-4228 CS	52	tk775-4236-45 C	50	tk775-5021 C	62	tk775-5027-45	62
tk775-4228-25	52	tk775-4236-45 CS	50	tk775-5021 CS	62	tk775-5027-45 C	62
tk775-4228-25 C	52	tk775-4243	47	tk775-5021-25	62	tk775-5027-45 CS	62
tk775-4228-25 CS	52	tk775-4243 C	47	tk775-5021-25 C	62	tk775-5028	62
tk775-4228-45	52	tk775-4243 CS	47	tk775-5021-25 CS	62	tk775-5028 C	62
tk775-4228-45 C	52	tk775-4243-25	47	tk775-5021-45	62	tk775-5028 CS	62

Nummernverzeichnis
Numerical Index
Index numérique
Indice numerico
Indice dei numeri d'articolo

Art. No.	Page	Art. No.	Page	Art. No.	Page	Art. No.	Page
tk 775-5028-25	62	tk 775-5038-45 CS	64	tk 775-5048-25 C	60	tk 775-5056	58
tk 775-5028-25 C	62	tk 775-5041	64	tk 775-5048-25 CS	60	tk 775-5056 C	58
tk 775-5028-25 CS	62	tk 775-5041 C	64	tk 775-5048-45	60	tk 775-5056 CS	58
tk 775-5028-45	62	tk 775-5041 CS	64	tk 775-5048-45 C	60	tk 775-5056-25	58
tk 775-5028-45 C	62	tk 775-5041-25	64	tk 775-5048-45 CS	60	tk 775-5056-25 C	58
tk 775-5028-45 CS	62	tk 775-5041-25 C	64	tk 775-5049	60	tk 775-5056-25 CS	58
tk 775-5029	63	tk 775-5041-25 CS	64	tk 775-5049 C	60	tk 775-5056-45	58
tk 775-5029 C	63	tk 775-5041-45	64	tk 775-5049 CS	60	tk 775-5056-45 C	58
tk 775-5029 CS	63	tk 775-5041-45 C	64	tk 775-5049-25	60	tk 775-5056-45 CS	58
tk 775-5029-25	63	tk 775-5041-45 CS	64	tk 775-5049-25 C	60	tk 775-5058	58
tk 775-5029-25 C	63	tk 775-5043	57	tk 775-5049-25 CS	60	tk 775-5058 C	58
tk 775-5029-25 CS	63	tk 775-5043 C	57	tk 775-5049-45	60	tk 775-5058 CS	58
tk 775-5029-45	63	tk 775-5043 CS	57	tk 775-5049-45 C	60	tk 775-5058-25	58
tk 775-5029-45 C	63	tk 775-5043-25	57	tk 775-5049-45 CS	60	tk 775-5058-25 C	58
tk 775-5029-45 CS	63	tk 775-5043-25 C	57	tk 775-5050	55	tk 775-5058-25 CS	58
tk 775-5032	60	tk 775-5043-25 CS	57	tk 775-5050 C	55	tk 775-5058-45	58
tk 775-5032 C	60	tk 775-5043-45	57	tk 775-5050 CS	55	tk 775-5058-45 C	58
tk 775-5032 CS	60	tk 775-5043-45 C	57	tk 775-5050-25	55	tk 775-5058-45 CS	58
tk 775-5032-25	60	tk 775-5043-45 CS	57	tk 775-5050-25 C	55	tk 775-5064	62
tk 775-5032-25 C	60	tk 775-5044	63	tk 775-5050-25 CS	55	tk 775-5064 C	62
tk 775-5032-25 CS	60	tk 775-5044 C	63	tk 775-5050-45	55	tk 775-5064 CS	62
tk 775-5032-45	60	tk 775-5044 CS	63	tk 775-5050-45 C	55	tk 775-5064-25	62
tk 775-5032-45 C	60	tk 775-5044-25	63	tk 775-5050-45 CS	55	tk 775-5064-25 C	62
tk 775-5032-45 CS	60	tk 775-5044-25 C	63	tk 775-5052	55	tk 775-5064-25 CS	62
tk 775-5034	63	tk 775-5044-25 CS	63	tk 775-5052 C	55	tk 775-5064-45	62
tk 775-5034 C	63	tk 775-5044-45	63	tk 775-5052 CS	55	tk 775-5064-45 C	62
tk 775-5034 CS	63	tk 775-5044-45 C	63	tk 775-5052-25	55	tk 775-5064-45 CS	62
tk 775-5034-25	63	tk 775-5044-45 CS	63	tk 775-5052-25 C	55	tk 775-5065	61
tk 775-5034-25 C	63	tk 775-5045	55	tk 775-5052-25 CS	55	tk 775-5065 C	61
tk 775-5034-25 CS	63	tk 775-5045 C	55	tk 775-5052-45	55	tk 775-5065 CS	61
tk 775-5034-45	63	tk 775-5045 CS	55	tk 775-5052-45 C	55	tk 775-5065-25	61
tk 775-5034-45 C	63	tk 775-5045-25	55	tk 775-5052-45 CS	55	tk 775-5065-25 C	61
tk 775-5034-45 CS	63	tk 775-5045-25 C	55	tk 775-5053	55	tk 775-5065-25 CS	61
tk 775-5035	60	tk 775-5045-25 CS	55	tk 775-5053 C	55	tk 775-5065-45	61
tk 775-5035 C	60	tk 775-5045-45	55	tk 775-5053 CS	55	tk 775-5065-45 C	61
tk 775-5035 CS	60	tk 775-5045-45 C	55	tk 775-5053-25	55	tk 775-5065-45 CS	61
tk 775-5035-25	60	tk 775-5045-45 CS	55	tk 775-5053-25 C	55	tk 775-5066	55
tk 775-5035-25 C	60	tk 775-5046	63	tk 775-5053-25 CS	55	tk 775-5066 C	55
tk 775-5035-25 CS	60	tk 775-5046 C	63	tk 775-5053-45	55	tk 775-5066 CS	55
tk 775-5035-45	60	tk 775-5046 CS	63	tk 775-5053-45 C	55	tk 775-5066-25	55
tk 775-5035-45 C	60	tk 775-5046-25	63	tk 775-5053-45 CS	55	tk 775-5066-25 C	55
tk 775-5035-45 CS	60	tk 775-5046-25 C	63	tk 775-5054	55	tk 775-5066-25 CS	55
tk 775-5036	60	tk 775-5046-25 CS	63	tk 775-5054 C	55	tk 775-5066-45	55
tk 775-5036 C	60	tk 775-5046-45	63	tk 775-5054 CS	55	tk 775-5066-45 C	55
tk 775-5036 CS	60	tk 775-5046-45 C	63	tk 775-5054-25	55	tk 775-5066-45 CS	55
tk 775-5036-25	60	tk 775-5046-45 CS	63	tk 775-5054-25 C	55	tk 775-5067	58
tk 775-5036-25 C	60	tk 775-5047	60	tk 775-5054-25 CS	55	tk 775-5067 C	58
tk 775-5036-25 CS	60	tk 775-5047 C	60	tk 775-5054-45	55	tk 775-5067 CS	58
tk 775-5036-45	60	tk 775-5047 CS	60	tk 775-5054-45 C	55	tk 775-5067-25	58
tk 775-5036-45 C	60	tk 775-5047-25	60	tk 775-5054-45 CS	55	tk 775-5067-25 C	58
tk 775-5036-45 CS	60	tk 775-5047-25 C	60	tk 775-5055	59	tk 775-5067-25 CS	58
tk 775-5038	64	tk 775-5047-25 CS	60	tk 775-5055 C	59	tk 775-5067-45	58
tk 775-5038 C	64	tk 775-5047-45	60	tk 775-5055 CS	59	tk 775-5067-45 C	58
tk 775-5038 CS	64	tk 775-5047-45 C	60	tk 775-5055-25	59	tk 775-5067-45 CS	58
tk 775-5038-25	64	tk 775-5047-45 CS	60	tk 775-5055-25 C	59	tk 775-5068	59
tk 775-5038-25 C	64	tk 775-5048	60	tk 775-5055-25 CS	59	tk 775-5068 C	59
tk 775-5038-25 CS	64	tk 775-5048 C	60	tk 775-5055-45	59	tk 775-5068 CS	59
tk 775-5038-45	64	tk 775-5048 CS	60	tk 775-5055-45 C	59	tk 775-5068-25	59
tk 775-5038-45 C	64	tk 775-5048-25	60	tk 775-5055-45 CS	59	tk 775-5068-25 C	59

Nummernverzeichnis
Numerical Index

Index numérique
Indice numerico
Indice dei numeri d'articolo

Art. No.	Page	Art. No.	Page	Art. No.	Page	Art. No.	Page
tk775-5068-25 CS	59	tk775-5081 C	59	tk775-5090-45	59	tk783-102-45	39
tk775-5068-45	59	tk775-5081 CS	59	tk775-5090-45 C	59	tk783-104	39
tk775-5068-45 C	59	tk775-5081-25	59	tk775-5090-45 CS	59	tk783-104-25	39
tk775-5068-45 CS	59	tk775-5081-25 C	59	tk775-5093	57	tk783-104-45	39
tk775-5069	62	tk775-5081-25 CS	59	tk775-5093 C	57	tk783-106	39
tk775-5069 C	62	tk775-5081-45	59	tk775-5093 CS	57	tk783-106-25	39
tk775-5069 CS	62	tk775-5081-45 C	59	tk775-5093-25	57	tk783-106-45	39
tk775-5069-25	62	tk775-5081-45 CS	59	tk775-5093-25 C	57	tk783-107	39
tk775-5069-25 C	62	tk775-5083	56	tk775-5093-25 CS	57	tk783-107-25	39
tk775-5069-25 CS	62	tk775-5083 C	56	tk775-5093-45	57	tk783-107-45	39
tk775-5069-45	62	tk775-5083 CS	56	tk775-5093-45 C	57	tk783-120	39
tk775-5069-45 C	62	tk775-5083-25	56	tk775-5093-45 CS	57	tk783-120-25	39
tk775-5069-45 CS	62	tk775-5083-25 C	56	tk775-5094	58	tk783-120-45	39
tk775-5073	61	tk775-5083-25 CS	56	tk775-5094 C	58	tk783-123	39
tk775-5073 C	61	tk775-5083-45	56	tk775-5094 CS	58	tk783-123-25	39
tk775-5073 CS	61	tk775-5083-45 C	56	tk775-5094-25	58	tk783-123-45	39
tk775-5073-25	61	tk775-5083-45 CS	56	tk775-5094-25 C	58	tk783-124	39
tk775-5073-25 C	61	tk775-5084	56	tk775-5094-25 CS	58	tk783-124-25	39
tk775-5073-25 CS	61	tk775-5084 C	56	tk775-5094-45	58	tk783-124-45	39
tk775-5073-45	61	tk775-5084 CS	56	tk775-5094-45 C	58	tk783-125	39
tk775-5073-45 C	61	tk775-5084-25	56	tk775-5094-45 CS	58	tk783-125-25	39
tk775-5073-45 CS	61	tk775-5084-25 C	56	tk775-5096	56	tk783-125-45	39
tk775-5074	59	tk775-5084-25 CS	56	tk775-5096 C	56	tk783-127	40
tk775-5074 C	59	tk775-5084-45	56	tk775-5096 CS	56	tk783-127-25	40
tk775-5074 CS	59	tk775-5084-45 C	56	tk775-5096-25	56	tk783-127-45	40
tk775-5074-25	59	tk775-5084-45 CS	56	tk775-5096-25 C	56	tk783-128	39
tk775-5074-25 C	59	tk775-5087	56	tk775-5096-25 CS	56	tk783-128-25	39
tk775-5074-25 CS	59	tk775-5087 C	56	tk775-5096-45	56	tk783-128-45	39
tk775-5074-45	59	tk775-5087 CS	56	tk775-5096-45 C	56	tk783-129	41
tk775-5074-45 C	59	tk775-5087-25	56	tk775-5096-45 CS	56	tk783-129-25	41
tk775-5074-45 CS	59	tk775-5087-25 C	56	tk775-5097	56	tk783-129-45	41
tk775-5076	59	tk775-5087-25 CS	56	tk775-5097 C	56	tk783-130	41
tk775-5076 C	59	tk775-5087-45	56	tk775-5097 CS	56	tk783-130-25	41
tk775-5076 CS	59	tk775-5087-45 C	56	tk775-5097-25	56	tk783-130-45	41
tk775-5076-25	59	tk775-5087-45 CS	56	tk775-5097-25 C	56	tk783-132	41
tk775-5076-25 C	59	tk775-5088	62	tk775-5097-25 CS	56	tk783-132-25	41
tk775-5076-25 CS	59	tk775-5088 C	62	tk775-5097-45	56	tk783-132-45	41
tk775-5076-45	59	tk775-5088 CS	62	tk775-5097-45 C	56	tk783-141	41
tk775-5076-45 C	59	tk775-5088-25	62	tk775-5097-45 CS	56	tk783-141-25	41
tk775-5076-45 CS	59	tk775-5088-25 C	62	tk775-5099	60	tk783-141-45	41
tk775-5078	61	tk775-5088-25 CS	62	tk775-5099 C	60	tk783-142	41
tk775-5078 C	61	tk775-5088-45	62	tk775-5099 CS	60	tk783-142-25	41
tk775-5078 CS	61	tk775-5088-45 C	62	tk775-5099-25	60	tk783-142-45	41
tk775-5078-25	61	tk775-5088-45 CS	62	tk775-5099-25 C	60	tk783-143	41
tk775-5078-25 C	61	tk775-5089	61	tk775-5099-25 CS	60	tk783-143-25	41
tk775-5078-25 CS	61	tk775-5089 C	61	tk775-5099-45	60	tk783-143-45	41
tk775-5078-45	61	tk775-5089 CS	61	tk775-5099-45 C	60	tk783-145	40
tk775-5078-45 C	61	tk775-5089-25	61	tk775-5099-45 CS	60	tk783-145-25	40
tk775-5078-45 CS	61	tk775-5089-25 C	61	tk775-5253	64	tk783-145-45	40
tk775-5079	59	tk775-5089-25 CS	61	tk775-5253 C	64	tk783-150	41
tk775-5079 C	59	tk775-5089-45	61	tk775-5253 CS	64	tk783-150-25	41
tk775-5079 CS	59	tk775-5089-45 C	61	tk775-5253-25	64	tk783-150-45	41
tk775-5079-25	59	tk775-5089-45 CS	61	tk775-5253-25 C	64	tk783-151	40
tk775-5079-25 C	59	tk775-5090	59	tk775-5253-25 CS	64	tk783-151-25	40
tk775-5079-25 CS	59	tk775-5090 C	59	tk775-5253-45	64	tk783-151-45	40
tk775-5079-45	59	tk775-5090 CS	59	tk775-5253-45 C	64	tk783-152	40
tk775-5079-45 C	59	tk775-5090-25	59	tk775-5253-45 CS	64	tk783-152-25	40
tk775-5079-45 CS	59	tk775-5090-25 C	59	tk783-102	39	tk783-152-45	40
tk775-5081	59	tk775-5090-25 CS	59	tk783-102-25	39	tk783-154	40

Nummernverzeichnis
Numerical Index

Index numérique
Indice numerico
Indice dei numeri d'articolo

Art. No.	Page	Art. No.	Page	Art. No.	Page	Art. No.	Page
tk 783-154-25	40	tk 783-254	40	tk 783-641-45	41	tk 791-176	91
tk 783-154-45	40	tk 783-254-25	40	tk 783-642	41	tk 791-180	89
tk 783-155	40	tk 783-254-45	40	tk 783-642-25	41	tk 791-185	89
tk 783-155-25	40	tk 783-255	40	tk 783-642-45	41	tk 791-187	89
tk 783-155-45	40	tk 783-255-25	40	tk 783-643	41	tk 791-189	89
tk 783-156	41	tk 783-255-45	40	tk 783-643-25	41	tk 795-4910	32
tk 783-156-25	41	tk 783-256	41	tk 783-643-45	41	tk 87015-20	92
tk 783-156-45	41	tk 783-256-25	41	tk 783-645	40	tk 87200-1F-SI	92
tk 783-157	40	tk 783-256-45	41	tk 783-645-25	40	tk 87280-2F-BK	93
tk 783-157-25	40	tk 783-257	40	tk 783-645-45	40	tk 87280-2F-BL	93
tk 783-157-45	40	tk 783-257-25	40	tk 783-650	41	tk 87280-2F-GR	93
tk 783-158	40	tk 783-257-45	40	tk 783-650-25	41	tk 87280-2F-RE	93
tk 783-158-25	40	tk 783-258	40	tk 783-650-45	41	tk 87280-2F-SI	93
tk 783-158-45	40	tk 783-258-25	40	tk 783-651	40	tk 87280-2F-YE	93
tk 783-159	40	tk 783-258-45	40	tk 783-651-25	40	tk 87290-2F-BK	93
tk 783-159-25	40	tk 783-259	40	tk 783-651-45	40	tk 87290-2F-BL	93
tk 783-159-45	40	tk 783-259-25	40	tk 783-652	40	tk 87290-2F-GR	93
tk 783-202	39	tk 783-259-45	40	tk 783-652-25	40	tk 87290-2F-RE	93
tk 783-202-25	39	tk 783-602	39	tk 783-652-45	40	tk 87290-2F-SI	93
tk 783-202-45	39	tk 783-602-25	39	tk 783-654	40	tk 87290-2F-YE	93
tk 783-204	39	tk 783-602-45	39	tk 783-654-25	40	tk 87295-00	92
tk 783-204-25	39	tk 783-604	39	tk 783-654-45	40	tk 95000-00	94
tk 783-204-45	39	tk 783-604-25	39	tk 783-655	40	tk 95000-50	94
tk 783-206	39	tk 783-604-45	39	tk 783-655-25	40	tk 95000-51	94
tk 783-206-25	39	tk 783-606	39	tk 783-655-45	40	tk 95000-52	94
tk 783-206-45	39	tk 783-606-25	39	tk 783-656	41	tk 95010-00	94
tk 783-207	39	tk 783-606-45	39	tk 783-656-25	41	tk 95011-00	94
tk 783-207-25	39	tk 783-607	39	tk 783-656-45	41	tk 95011-02	94
tk 783-207-45	39	tk 783-607-25	39	tk 783-657	40	tk 95012-00	94
tk 783-225	39	tk 783-607-45	39	tk 783-657-25	40	tk 95100-00	94
tk 783-225-25	39	tk 783-620	39	tk 783-657-45	40		
tk 783-225-45	39	tk 783-620-25	39	tk 783-658	40		
tk 783-227	40	tk 783-620-45	39	tk 783-658-25	40		
tk 783-227-25	40	tk 783-623	39	tk 783-658-45	40		
tk 783-227-45	40	tk 783-623-25	39	tk 783-659	40		
tk 783-228	39	tk 783-623-45	39	tk 783-659-25	40		
tk 783-228-25	39	tk 783-624	39	tk 783-659-45	40		
tk 783-228-45	39	tk 783-624-25	39	tk 783-710	38		
tk 783-229	41	tk 783-624-45	39	tk 783-711	38		
tk 783-229-25	41	tk 783-625	39	tk 783-720	38		
tk 783-229-45	41	tk 783-625-25	39	tk 783-721	38		
tk 783-230	41	tk 783-625-45	39	tk 783-730	38		
tk 783-230-25	41	tk 783-627	40	tk 783-731	38		
tk 783-230-45	41	tk 783-627-25	40	tk 783-740	38		
tk 783-232	41	tk 783-627-45	40	tk 783-741	38		
tk 783-232-25	41	tk 783-628	39	tk 783-750	38		
tk 783-232-45	41	tk 783-628-25	39	tk 783-751	38		
tk 783-245	40	tk 783-628-45	39	tk 791-150	90		
tk 783-245-25	40	tk 783-629	41	tk 791-151	90		
tk 783-245-45	40	tk 783-629-25	41	tk 791-152	90		
tk 783-250	41	tk 783-629-45	41	tk 791-153	90		
tk 783-250-25	41	tk 783-630	41	tk 791-154	90		
tk 783-250-45	41	tk 783-630-25	41	tk 791-155	90		
tk 783-251	40	tk 783-630-45	41	tk 791-156	90		
tk 783-251-25	40	tk 783-632	41	tk 791-157	90		
tk 783-251-45	40	tk 783-632-25	41	tk 791-161	91		
tk 783-252	40	tk 783-632-45	41	tk 791-170	91		
tk 783-252-25	40	tk 783-641	41	tk 791-174	91		
tk 783-252-45	40	tk 783-641-25	41	tk 791-175	91		

Wichtige Hinweise

Dieser Katalog bleibt Eigentum der Firma TEKNO-MEDICAL Optik-Chirurgie GmbH, auch wenn dafür eine Schutzgebühr bezahlt wurde. Er kann von uns jederzeit zurückgefordert werden, wenn er gegen unsere Interessen und nicht zum Vertrieb und Einkauf von TEKNO Produkten verwendet wird. Auch behalten wir uns in solch einem Falle weitergehende Maßnahmen vor.

Der Nachdruck oder Kopieren dieses Kataloges – im Gesamten oder auch nur auszugsweise – ist ohne unsere schriftliche Genehmigung verboten. Modelländerungen vorbehalten. Gedruckt in der Bundesrepublik Deutschland

Important notice

This catalogue remains property of TEKNO-MEDICAL Optik-Chirurgie GmbH even if we have asked for a lending fee. We can at any time recall the catalogue, in case that it has been not used according to our interests, i.e. sale or purchase of TEKNO products. We preserve the right for further steps in that case.

Reproduction or copying of this catalogue in whole or in parts is forbidden without our written permission. Patterns are subject to change. Printed in Germany

Indications importantes

Ce catalogue reste la propriété de TEKNO-MEDICAL Optik-Chirurgie GmbH, même si nous avons demandé le paiement d'une taxe de protection. Nous pouvons demander le retour du catalogue dans le cas où celui-ci n'est pas utilisé conformément à nos intérêts, pour la vente ou l'achat de nos produits. Dans ce cas nous nous réservons le droits de mener des actions juridiques.

La reproduction ou la copie totale ou partielle de ce catalogue est interdite sans notre accord écrit. Sous réserve des modifications techniques. Imprimé en Allemagne

Avisos importantes

Este catálogo es propiedad de TEKNO-MEDICAL Optik-Chirurgie GmbH, aún en el caso de haber abonado por él una tasa de colaboración. Podemos solicitar la devolución del catálogo en caso de que no sea utilizado para la compra o venta de nuestros productos. En este caso nos reservamos el derecho de tomar medidas jurídicas.

La reproducción o copia total o parcial de este catálogo esta prohibido sin nuestro consentimiento escrito. Salvo modificaciones técnicas. Impreso en la República Federal de Alemania

Avvertenze importanti

Questo catalogo rimane proprietà della TEKNO-MEDICAL Optik-Chirurgie GmbH, anche se è stato rilasciato gratuitamente contro pagamento. Possiamo in ogni momento richiederlo indietro, in caso non stato usato in accordo con i nostri interessi (acquisto e vendita dei prodotti TEKNO-Medical). Ci riserviamo in questo caso il diritto di prendere ulteriori provvedimenti.

La copia o la riproduzione di questo catalogo in parte o nella sua totalità è vietata senza il nostro permesso scritto. Ci riserviamo la facoltà di cambiamenti nei modelli. Stampato in Germania



TEKNO-MEDICAL Optik-Chirurgie GmbH

Sattlerstrasse 11 · 78532 Tuttlingen, Germany
Telefon +49 (74 61) 1701-0 · Fax +49 (74 61) 1701-50
mail@tekno-medical.com · www.tekno-medical.com

© 12.2019 - TEKNO-MEDICAL Optik-Chirurgie GmbH
TEKNO is a registered trademark of TEKNO-MEDICAL Optik-Chirurgie GmbH