

**Anexa 30 Dispozitiv fizioterapeutic pentru electroterapie, laseroterapie, magnetoterapie și ultrasunet, Model: PhysioGo700I, Astar,**

**Nr. de inregistrare AMDM: DM000663228**

Specificarea tehnică deplină solicitată, Standarde de referință	Specificarea tehnică deplină oferita, Standarde de referință
<p>Dispozitiv fizioterapeutic pentru electroterapie, laseroterapie, magnetoterapie și ultrasunet Cod 400180</p> <p>Descriere: Dispozitiv fizioterapeutic multifuncțional destinat procedurilor de electroterapie, electroforeză (ionoforeză), laseroterapie, magnetoterapie și ultrasunet, dotat cu protocoale presetate și personalizabile.</p> <p>Parametru Specificație Electroterapie: Electroterapie: "Parametrii electrici disponibili (minim): Curenți galvanici Curenți diadinamici Curenți interferențiali Curenți faradici sau neofaradici Curenți Trabert (Ultra Reiz) TENS (Stimulare electrică nervoasă transcutanată) Stimulare Kotz (curenți de medie frecvență modulați) Electroforeză (ionoforeză)"</p> <p>Laser: Clasa dispozitivului cu laser 3B Laser roșu obligatoriu Laser infraroșu obligatoriu</p> <p>Magnet: Cîmpuri magnetice cu forme de undă: sinusoidală, dreptunghiulară, triunghiulară Magnetoterapie cu impulsuri obligatoriu</p> <p>Ultrasunet: Frecvența de lucru, diapazon minim 1-3 MHz Moduri de operare continuu și pulsatoriu Funcționalități: Protocoale de lucru presetate obligatoriu Protocoale de lucru personalizate obligatoriu Cronometru obligatoriu Alimentare 230 V, 50 Hz ± 10%</p> <p>Accesorii incluse: "Set de electrozi adulți pentru electroterapie ≥ 1 set (1 set = 1 pereche), să se indice codul produsului" "Set de electrozi adulți, pentru electroforeză, cu bureți absorbanti, ≥ 1 set (1 set = 1 pereche), să se indice codul produsului" Sonda roșu ≥ 1 buc, să se indice codul produsului</p> <p>Sonda infraroșu ≥ 1 buc, să se indice codul produsului Sonda ultrasunet ~ 1cm<sup>2</sup> ≥ 1 buc, să se indice codul produsului Sonda ultrasunet ~ 4cm<sup>2</sup> ≥ 1 buc, să se indice codul produsului Aplicatoare pentru magnetoterapie ≥ 2 buc, să se indice codul produsului</p>	<p>Dispozitiv fizioterapeutic pentru electroterapie, laseroterapie, magnetoterapie și ultrasunet Cod 400180</p> <p>Descriere: Dispozitiv fizioterapeutic multifuncțional destinat procedurilor de electroterapie, electroforeză (ionoforeză), laseroterapie, magnetoterapie și ultrasunet, dotat cu protocoale presetate și personalizabile. -broșura, pag.1</p> <p>Parametru Specificație Electroterapie: <b>Electroterapie:</b> Parametrii electrici disponibili (minim): Curenți galvanici – broșura, pag.1 Curenți diadinamici- broșura, pag.1 Curenți interferențiali – broșura, pag.1 Curenți neofaradici – broșura, pag.1 Curenți Trabert (Ultra Reiz) – broșura, pag.1 TENS (Stimulare electrică nervoasă transcutanată) – broșura, pag.1 Stimulare Kotz (curenți de medie frecvență modulați) – broșura, pag.1 Electroforeză (ionoforeză) – manual pag. 7</p> <p><b>Laser:</b> Clasa dispozitivului cu laser: 3B- broșura, pag.3 Laser roșu - broșura, pag.2 Laser infraroșu - broșura, pag.2</p> <p><b>Magnet:</b> Cîmpuri magnetice cu forme de undă: sinusoidală, dreptunghiulară, triunghiulară - broșura, pag.2 Magnetoterapie continua si cu impulsuri - broșura, pag.2</p> <p><b>Ultrasunet:</b> Frecvența de lucru, diapazon 1-3,5 MHz - broșura, pag.3 Moduri de operare: continuu și pulsatoriu - manual pag. 7</p> <p><b>Funcționalități:</b> Protocoale de lucru presetate – da, broșura, pag.2 Protocoale de lucru personalizate -da, broșura, pag.3 Cronometru - broșura, pag.3,4 Alimentare 220/230 V, 50/60 Hz- broșura, pag.4</p> <p><b>Accesorii incluse:</b> Set de electrozi pentru electroterapie si electroforeza (adulți): 2 seturi-(4 electrozi cu marimea de 6x6 cm) – manual, pag 49 1 set -(2 electrozi cu marimea de 7.5x9 cm) – manual, pag 49</p> <p>Sondă laser roșu:1 bucată, cod:A-AL-AST-80RDV3- manual, pag 50 Sondă laser infraroșu:- 1 bucată, cod:A-AL-AST-400IRV3 - manual, pag 50 Sondă ultrasunet (~1 cm<sup>2</sup>):1 bucată, cod: A-AS-AST-GS1WH - manual, pag 50 Sondă ultrasunet (~4 cm<sup>2</sup>):1 bucată,cod: A-AS-AST-GS4WH manual, pag 50 Aplicatoare pentru magnetoterapie: 1 set format din 2 bucati bucati, CPE1+ CPE2, cod: A-AG-AST-CPE1WH+ A-AG-AST-CPE2WH- manual, pag 50</p>

Ochelari de protectie $\geq 2$ buc, să se indice codul produsului Gel pentru ultraunet $\geq 1$ L, să se indice codul produsului Set de accesorii standard - obligatoriu	Ochelari de protectie -2 bucati, manual pag.50 Gel pentru ultraunet -1litru (2 butelii/500g), manual pag. 49 Set de accesorii standard- da, manual pag.49
--	---



# PhysioGo 7011

Biostimulation laser therapy  
 Combination therapy  
 Electrotherapy  
 Magnetotherapy  
 Ultrasound therapy



## Features

product code	A-UC-AST-PHG7011
color display with touch panel	7"
independent treatment channels	3
intensity regulation in the patient circuit for both channels simultaneously or separately	✓
electrode test	✓
manual mode	✓
disease entities selected by name or medical field	✓
preset treatment programs database	✓
preset treatment sequences database	✓
user-defined programs database	✓
user sequence database	✓
favorite programs	✓
possibility of program names and user sequences edition	✓
encyclopedia describing the treatment methodology	✓
statistics of performed treatment procedures	✓
buzzer sound volume regulation	✓
battery	✓

## Electrotherapy

operation in CC (current stabilization) or CV (voltage stabilization) modes	✓
full galvanic isolation between channels in each mode	✓
Currents and methods	
interferential isoplanar	✓
interferential dynamic	✓
interferential single channel AMF	✓
TENS symmetric	✓
TENS asymmetric	✓
TENS alternating	✓
TENS burst	✓
TENS for spastic paralysis therapy	✓
Kotz' current (Russian stimulation)	✓
tonolysis	✓
diadynamic (MF, DF, CP, CP-ISO, LP)	✓
pulsed rectangular	✓
pulsed triangular	✓
pulsed UR according to Trabert (2 - 5)	✓
pulsed according to Leduc (1 - 9)	✓
pulsed neofaradic (1 - 19)	✓
unipolar sine surge	✓
galvanic	✓
microcurrents	✓

## Ultrasound therapy

waterproof ultrasound heads	✓
continuous / pulse emission	✓
ultrasound head contact control (effective treatment time measured)	✓
head sensitivity calibration according to the needs	✓

## Combined therapy

operation in CC (current stabilization) or CV (voltage stabilization) modes	✓
Currents and methods	✓
interferential single channel AMF	✓
TENS symmetric	✓
TENS asymmetric	✓
TENS alternating	✓
TENS burst	✓
Kotz' current (Russian stimulation)	✓

## Laser therapy

operation with applicators: scanning laser, cluster laser and point probes	✓
emission mode: continuous and pulse	✓
adjustment of laser radiation power	✓
duty factor	✓
automatic laser radiation power test	✓
automatic calculation of time relative to treatment parameters - dose, power, duty factor, treatment area	✓
three modes of treatment field irradiation in scanning laser applicators	✓
dedicated modes for cooperation with optical fiber applicators	✓
optical fiber applicators for laserpuncture and ENT applications	✓
pilot beam indicating the application site	✓

## Magnetotherapy

continuous and pulse emission	✓
field shape: sine, triangle, rectangle, half-sinus, half-triangle, half-rectangle	✓
optional operation with one or two plate CPE applicators	✓
convenient application of applicators with straps and velcro belts	✓

## Preset treatment programs

built-in treatment programs, including:	420
built-in treatment programs for electrotherapy	69
built-in treatment programs for ultrasound therapy	58
built-in treatment programs for combined therapy	77
IR point probe programs	39
R point probe programs	18

## Preset treatment sequences

built-in treatment sequences for electrotherapy	38
user-defined sequences	10

programs with Nogier frequency	8
programs with Voll frequency	30
cluster laser applicator programs	54
program sequences for scanning laser applicators	26
built-in treatment programs for magnetotherapy	41
user configurable programs	400
favorite programs	✓

## Electrotherapy technical parameters

max. current intensity in the patient circuit (CC mode)	
galvanic	40 mA
diadynamic, impulse	60 mA
interferential, Kotz' current	100 mA
unipolar sine surge	100 mA
TENS	140 mA
tonolysis	100 mA
microcurrents	1000 uA
max. voltage amplitude in the patient circuit (CV mode)	140 V
treatment timer	30 s - 60 minutes

## Laser therapy technical parameters

laser device class	3B
treatment timer	1 s - 100 minutes

## Laser therapy parameters - scanning laser applicator

scanning laser applicator wavelength	808 & 660 nm
maximum power of the scanning laser applicator	450 & 100 mW
power regulation	50%, 100%
pulse mode frequency	1 - 5000 Hz

## Ultrasound therapy technical parameters

operating frequency	1 & 3,5 MHz
effective radiation area	1 cm <sup>2</sup> , 4 cm <sup>2</sup>
maximum ultrasound wave intensity	2/3 W/cm <sup>2</sup>
frequency in pulse mode	16 Hz, 48 Hz, 100 Hz
duty factor in pulse mode	5 - 75%, step 5%
treatment timer	30 s - 30 minutes

## Laser therapy parameters - biostimulation laser point probes

red light laser point probes wavelength	660 nm
maximum power of the red light point probes	80 mW
infrared laser point probes wavelength	808 nm
maximum power of the infrared point probes	400 mW
power regulation	25%, 50%, 75%, 100%
pulse mode frequency	1 - 5000 Hz
duty factor in pulse mode	10 - 90%, pulse 50 us

## Laser therapy parameters - cluster laser applicator

cluster laser applicator wavelength	4x 808 nm & 5x 660 nm
maximum power of the cluster laser applicator	4x 400 mW & 5x 40 mW
power regulation	50%, 100%
pulse mode frequency	1 - 5000 Hz

## Magnetotherapy technical parameters

---

maximum magnetic field induction	10 mT
operating frequency	2 - 120 Hz
interval mode parameters	pulse 1 s / break 0,5 - 8 s
treatment timer	30 s - 30 minutes

## General technical parameters

---

dimensions	34 x 28 x 11-16 cm
cluster laser applicator CL 1800 R 5x40 mW and IR 4x400 mW	6 kg
battery type	Li-Ion
battery capacity	2250 mAh
power supply, power consumption	230 V, 50/60 Hz, 75 W, 90 VA



PhysioGo 700I / 701I –  
User Manual

CE  
0197



## Contents

<b>1.</b>	<b>INTRODUCTION .....</b>	<b>5</b>
1.1	MANUFACTURER .....	5
<b>2.</b>	<b>INTENDED USE .....</b>	<b>6</b>
<b>3.</b>	<b>DEVICE INSTALLATION AND START-UP .....</b>	<b>8</b>
3.1	UNIT INSTALLATION .....	8
3.1.1	<i>Mounting of accessory holders .....</i>	<i>8</i>
3.1.2	<i>Connection of accessories – General notices.....</i>	<i>8</i>
3.1.3	<i>Connection of patient’s cables and application of electrodes.....</i>	<i>8</i>
3.1.4	<i>Connection of magnetic field applicator .....</i>	<i>9</i>
3.1.5	<i>Connection of laser applicator .....</i>	<i>10</i>
3.1.6	<i>Connection of ultrasound head.....</i>	<i>12</i>
3.1.7	<i>Connection in combined therapy .....</i>	<i>12</i>
3.1.8	<i>Patient’s stop switch connection.....</i>	<i>13</i>
3.1.9	<i>Connection of DOOR remote connector .....</i>	<i>13</i>
3.1.10	<i>First operation.....</i>	<i>13</i>
3.1.11	<i>Laser therapy access code.....</i>	<i>14</i>
3.2	SETUP MODE.....	14
3.2.1	<i>Basic information .....</i>	<i>14</i>
3.2.2	<i>Language .....</i>	<i>14</i>
3.2.3	<i>Global settings .....</i>	<i>15</i>
3.2.3.1	<i>Date and time.....</i>	<i>15</i>
3.2.3.2	<i>Sounds.....</i>	<i>15</i>
3.2.3.3	<i>Volume .....</i>	<i>15</i>
3.2.3.4	<i>Display .....</i>	<i>15</i>
3.2.4	<i>Functional settings.....</i>	<i>15</i>
3.2.4.1	<i>Channel operation mode selection .....</i>	<i>15</i>
3.2.4.2	<i>Program groups / medical fields.....</i>	<i>16</i>
3.2.4.3	<i>US units .....</i>	<i>16</i>
3.2.4.4	<i>US head sensitivity .....</i>	<i>16</i>
3.2.4.5	<i>US head bad contact signaling.....</i>	<i>17</i>
3.2.4.6	<i>Induction units.....</i>	<i>17</i>
3.2.4.7	<i>Battery – model 701l .....</i>	<i>17</i>
3.2.5	<i>Service.....</i>	<i>17</i>
3.2.5.1	<i>Electrodes test.....</i>	<i>17</i>
3.2.5.2	<i>US head calibration .....</i>	<i>18</i>
3.2.5.3	<i>Miscellaneous.....</i>	<i>18</i>
3.2.5.4	<i>Laser applicators output power test .....</i>	<i>18</i>
3.2.6	<i>Statistics.....</i>	<i>18</i>
3.2.6.1	<i>Info .....</i>	<i>18</i>
3.2.6.2	<i>Unit statistics .....</i>	<i>19</i>
3.2.6.3	<i>Accessories statistics .....</i>	<i>19</i>
3.3	TRANSPORT POSITION – THE STAND WITH SCANNING APPLICATOR.....	19
<b>4.</b>	<b>UNIT OPERATION.....</b>	<b>20</b>
4.1	PATIENT PREPARATION AND TREATMENT PERFORMANCE .....	20
4.1.1	<i>Electrotherapy.....</i>	<i>20</i>
4.1.2	<i>Ultrasound therapy.....</i>	<i>21</i>
4.1.3	<i>Combined therapy.....</i>	<i>22</i>
4.1.4	<i>Laser therapy .....</i>	<i>22</i>
4.1.5	<i>Magnetotherapy.....</i>	<i>23</i>
4.2	SCREEN CONFIGURATION .....	24
4.3	GENERAL CONFIGURATION .....	25
4.3.1	<i>Treatment channel configuration .....</i>	<i>25</i>
4.3.2	<i>Channel selection tabs .....</i>	<i>26</i>
4.3.3	<i>Limitations .....</i>	<i>27</i>
4.4	DISPLAY DESCRIPTION .....	27
4.4.1	<i>Electrotherapy.....</i>	<i>28</i>
4.4.2	<i>Combined therapy.....</i>	<i>29</i>
4.4.3	<i>Laser therapy .....</i>	<i>30</i>
4.4.4	<i>Magnetotherapy.....</i>	<i>31</i>

4.4.5	<i>Ultrasound therapy</i> .....	31
4.5	OPERATION WITH PRESET TREATMENT PROGRAMS AND SEQUENCES .....	32
4.5.1	<i>Voll and Nogier programs</i> .....	35
4.6	FAVOURITE PROGRAMS.....	35
4.7	MANUAL MODE OPERATION .....	36
4.8	USER PROGRAMS .....	37
4.9	USER SEQUENCES .....	38
4.10	I/T CURVE .....	40
<b>5.</b>	<b>INDICATIONS AND CONTRAINDICATIONS.....</b>	<b>42</b>
5.1	INDICATIONS .....	42
5.1.1	<i>Interferential and AMF currents</i> .....	42
5.1.2	<i>Kotz' current – Russian stimulation</i> .....	42
5.1.3	<i>TENS and SP-TENS current</i> .....	42
5.1.4	<i>Diadynamic currents</i> .....	43
5.1.5	<i>Ultra Reiz current</i> .....	43
5.1.6	<i>Rectangular impulses</i> .....	44
5.1.7	<i>Triangular impulses</i> .....	44
5.1.8	<i>Tonolysis</i> .....	44
5.1.9	<i>Microcurrents</i> .....	44
5.1.10	<i>USS – Unipolar Sine Surge</i> .....	44
5.1.11	<i>Galvanic current</i> .....	45
5.1.12	<i>Ultrasound therapy</i> .....	45
5.1.13	<i>Combined therapy</i> .....	45
5.1.14	<i>Laser therapy</i> .....	45
5.1.15	<i>Magnetotherapy</i> .....	46
5.2	CONTRAINDICATIONS FOR ULTRASOUND THERAPY .....	47
5.3	CONTRAINDICATIONS FOR ELECTROTHERAPY .....	47
5.4	CONTRAINDICATIONS FOR COMBINED THERAPY .....	47
5.5	CONTRAINDICATIONS FOR LASER THERAPY .....	47
5.6	CONTRAINDICATIONS FOR MAGNETOTHERAPY.....	48
<b>6.</b>	<b>ACCESSORIES .....</b>	<b>49</b>
6.1	STANDARD ACCESSORIES .....	49
6.2	OPTIONAL ACCESSORIES.....	50

### Table of figures

Figure 3.1.	Electrotherapy sockets .....	8
Figure 3.2.	Connection of electrodes .....	9
Figure 3.3.	Magnetotherapy socket .....	9
Figure 3.4.	Connected magnetic field applicators – CPE type .....	10
Figure 3.5.	Laser therapy sockets.....	11
Figure 3.6.	Handwheels – scanner and arm of the stand .....	11
Figure 3.7.	Wheel with brake .....	11
Figure 3.8.	Ultrasound head socket.....	12
Figure 3.9.	Output circuits for combined therapy .....	12
Figure 3.10.	Patient's stop switch socket .....	13
Figure 3.11.	DOOR remote connector socket.....	13
Figure 3.12.	Screen view – date and time edition .....	15
Figure 4.1.	Field description .....	24
Figure 4.2.	A sample view of therapy selection in channel 2 .....	25
Figure 4.3.	Location of channel selection tabs .....	26
Figure 4.4.	Screenshot sample view for dual circuit electrotherapy A+B.....	28
Figure 4.5.	Screenshot sample view for single circuit electrotherapy A and B.....	29
Figure 4.6.	Screenshot sample view for electrotherapy sequences .....	29
Figure 4.7.	Screenshot sample view for combined therapy .....	29
Figure 4.8.	Screenshot sample view for laser therapy.....	30
Figure 4.9.	Screenshot sample view for magnetotherapy.....	31
Figure 4.10.	Screenshot sample view for ultrasound therapy.....	31
Figure 4.11.	Information screen sample view .....	32

## 1. Introduction

---

**Read this Guide carefully before starting the unit operation!  
Follow the recommendations presented in this Guide!**

**PhysioGo 700I / 701I unit should be installed by the seller.  
The recipient has the right to insist on the product operation training.  
The unit may only be operated by qualified personnel or under supervision of such personnel!  
WARNING: The device is intended for adult patients only. It is not intended for use in a home  
healthcare environment.**

Description of symbols used in this manual:



Read appropriate passage of this user guide, warnings or important information. Failure to observe warnings can lead to injuries.



Important notices and information.



Following texts marked with this symbol facilitates device operation.

**NOTE:**

The outlook of screenshots shown in this manual may slightly differ from their actual outlook during device operation. These differences may concern size and type of fonts and size of symbols. There are no differences in the content of shown information.

**Warning: No modification of this equipment is allowed!**

### 1.1 Manufacturer

**ASTAR Sp. z o.o.  
ul. Świt 33  
43-382 Bielsko-Biała, Poland  
www.astar.eu**

## 2. Intended use

Multifunctional unit PhysioGo 700I / 701I is an active, non-invasive therapeutic device, intended for carrying out treatment procedures using:

- bipolar (bidirectional) and unipolar (unidirectional) low frequency currents,
- bipolar (bidirectional) medium frequency currents and unipolar (unidirectional) medium frequency currents modulated by low frequency waveforms,
- low frequency magnetic field,
- laser radiation within the visible (for wave length 660 nm) and invisible range (for wave length 808 nm),
- ultrasound therapy and phonophoresis,
- combination method of current and ultrasounds.

Model 700I	<b>Non battery unit</b>
Model 701I	<b>Battery unit</b>

The unit is equipped with three fully independent treatment channels. The list of available therapies in particular channels is shown in the table below.

Channel	Therapy
1	Single circuit electrotherapy – A
	Dual circuit electrotherapy – A+B
2	Single circuit electrotherapy – B
	Combined therapy – ultrasound therapy and electrotherapy
	Laser therapy
	Magnetotherapy
3	Ultrasound therapy

Detailed information about available configurations is presented further in this manual.

The unit possesses the base of preset treatment procedures along with therapeutic encyclopedia, which significantly increases comfort of operation.

There is also a possibility to create own user-defined:

- programs – for all therapies,
- sequences – for electrotherapy.

With regard to magnetotherapy, the unit may be used with coupled plate applicators CPE type in single or dual configuration. The treatment procedure is carried out locally, the magnetic field is focused only on the part of the body, which will be subjected to therapy. In contrast to the classical method of magnetic field application with the use of solenoid applicators, such a solution substantially reduces the impact of magnetic field on the other parts of the patient's body and the unit's environment, including the operating personnel.

As regards to laser radiation, the unit may be operated with point, cluster and scanning laser applicators. Due to the available maximum radiation power output at the level of 450 mW for wave length 808 nm and 100 mW for

660 nm, the PhysioGo unit is classified as a small power output laser device. In physiotherapy such lasers are designated as "cold", "soft" or biostimulating.



**The unit is a laser therapy device class 3B.**

In the range of ultrasound therapy, PhysioGo unit may cooperate with the following types of ultrasound heads:

- dedicated to standard ultrasound therapy with the effective radiation area 4 cm<sup>2</sup>, which generates the ultrasound wave with 1 MHz or 3,5 MHz frequency,
- dedicated to standard ultrasound therapy with the effective radiation area 1 cm<sup>2</sup>, which generates the ultrasound wave with 1 MHz or 3,5 MHz frequency.

The unit may perform treatments by:

- interferential currents – dynamic and isoplanar,
- one-channel sine wave current (AMF),
- Kotz' – Russian stimulation,
- TENS, BURST and formed in packages to spastic paralysis SP-TENS currents,
- tonolysis – to spastic paralysis,
- ionophoresis and galvanization of constant current (in the continuous and interrupted mode),
- triangular or rectangular pulses (in continuous and interrupted mode),
- Träbert (Ultra Reiz), Leduc' and neofaradic (in continuous and interrupted mode),
- diadynamic according to Bernard – MF, DF, CP, CP-ISO, LP currents (in continuous and interrupted mode),
- USS – Unipolar Sine Surge current,
- microcurrents,
- low frequency magnetic field in continuous and pulse mode,
- laser radiation in continuous and pulse mode,
- ultrasound, phonophoresis in continuous and pulse mode,
- combined method of electrotherapy and ultrasound therapy,
- qualitative and quantitative electrodiagnostics of the nervous-muscle system.

For more details, see "**Indications and contraindications**".

Due to the versatility and the optional availability of a battery, the unit is perfectly suited for use:

- in sports medicine in case of training camps,
- wherever there are problems with power supply quality.

## 3. Device installation and start-up

### 3.1 Unit installation



The first installation should be performed by a qualified manufacturer's or distributor's representative!

After removing the unit from the carton, check if the complete unit has been delivered. In case of any inconsistencies contact the distributor or manufacturer.



After removing the unit from transportation packaging wait approximately two hours before proceeding to next installation steps. This is aimed at adaptation of the unit to conditions in operation room.

The unit shall be placed on a table, trolley or in a cupboard near mains socket with power input 230V and 50/60Hz. Due to manufacturing under safety class I the unit can be connected only to a socket with protective earth pin. It is recommended to place the unit at such a height that it would enable convenient operation from the front panel. The light shall enable easy readout of display indicators, however the unit shall not be exposed to direct sunlight.



#### 3.1.1 Mounting of accessory holders

Mount the holders according to the information and illustrations given in chapter 4.3 of *PhysioGo Technical Description* manual.

#### 3.1.2 Connection of accessories – General notices

It should be noted that some of the connection sockets are multifunctional and different types of accessories may be connected in. All connectors are protected against pulling out of the sockets. It is recommended to secure the plug by tightening protection ring.

#### 3.1.3 Connection of patient's cables and application of electrodes

Electrotherapy cables should be connected to electrotherapy socket according to figure 3.1. Electrotherapy sockets are marked with symbols:  YA and  YB.

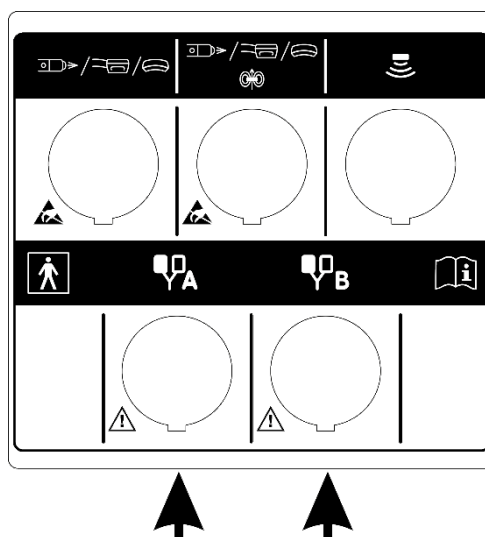

Figure 3.1. Electrotherapy sockets

Patient cables are terminated with banana type 4 mm or 2 mm plugs – two are red and the other two are black. Channels are marked with appropriate symbols. Electrodes should be connected to those plugs.



Figure 3.2. Connection of electrodes

After switching the unit on, red plugs are connected to positive pole, and black plugs are connected to negative pole. Electrode connection polarity matters in case of treatments with galvanic currents as well as unipolar currents of low and medium frequency.

As a standard accessory, the unit is equipped with elastomer-carbon electrodes. Parameters of such electrodes facilitate performing treatment procedures within a full range of available values of output signals amplitudes. It is recommended to operate with the unipolar currents using metal – tin or aluminum electrodes, as they wear out much slower than the electrodes made from other materials.

As optional accessories you can purchase self-adhesive electrodes in different dimensions. This type of electrodes is suitable for use with bipolar currents, especially TENS currents. **They shall not be used for therapy with unipolar currents!** Selection of the electrodes type to a particular treatment should be based on doctor's or physiotherapist's knowledge and experience.

### 3.1.4 Connection of magnetic field applicator

CPE type magnetic field applicator should be connected to the socket marked with symbol: .

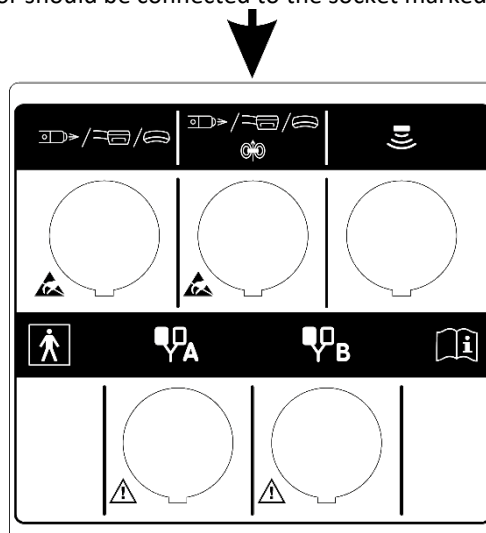

Figure 3.3. Magnetotherapy socket

Into the unit's socket, connect the applicator marked as CPE1. CPE2 applicator connect to CPE1 as it is shown in Figure 3.4.





**CPE applicators are not identical to CPEP applicators for PhysioMG magnetotherapy devices. They cannot be used interchangeably.**



Figure 3.4. Connected magnetic field applicators – CPE type

### 3.1.5 Connection of laser applicator

Laser applicators should be connected to laser therapy sockets according to figure 3.5. Meaning of laser applicator symbols is shown in the table below.

Symbol	Laser applicator type
	Red light point probe, type 40RDV2
	Red light point probe, type 80RDV2
	Red light point probe, type 80RDV3
	Infrared light point probe, type 200IRV2
	Infrared light point probe, type 400IRV2
	Infrared light point probe, type 400IRV3
	Scanning laser applicator, type SKW2-400 / SK2-400
	Scanning laser applicator, type SKW2-450 / SK2-450
	Cluster laser applicator, type CL1800WH / CL1800

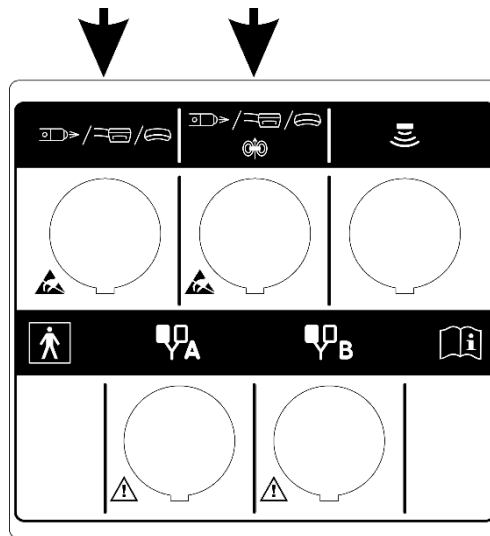

Figure 3.5. Laser therapy sockets



**Operating notes for operation with the scanning laser applicator mounted on a stand:**

- The stand with a unit and applicators shall be placed near mains socket with power input 230V and 50/60Hz, so that the change of stand position is not limited by the mains cable.
- When adjustment of scanner right position is difficult it is recommended to loosen or turn (depend on need) handwheel locking the arm of the stand or handwheel locking the laser scanner (both handwheels are presented in Figure 3.6).

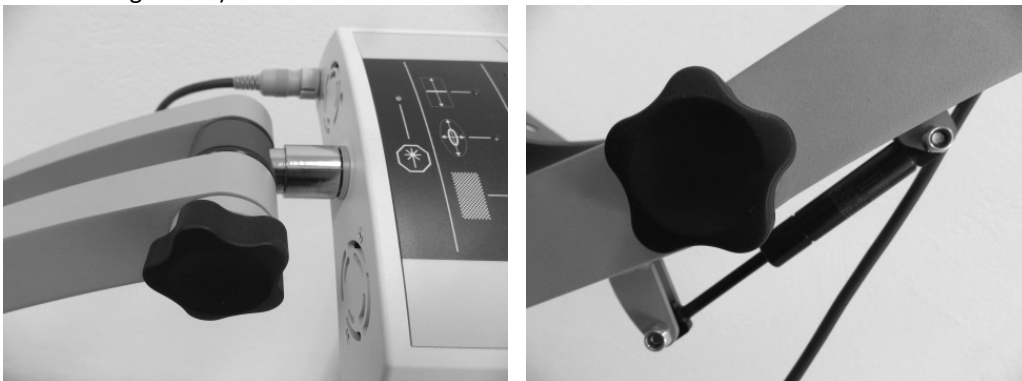

Figure 3.6. Handwheels – scanner and arm of the stand

- To protect the stand from unintentional change of its position it is recommended to lock wheel brakes – brake must be pressed to the floor. To release the brake, lift it up (wheel with brake is shown in Figure 3.7).



Figure 3.7. Wheel with brake

- To disassemble the controller from the shelf it is recommended to unscrew the bolts mounted to the shelf.
- To disassemble the scanning applicator, with one hand pull the mounting protection ring and using the other one release the scanner from the mounting socket.
- Other interconnecting cables shall be located to enable free change of position of the stand and scanning position adjustment.

Connection between scanning applicator and controller should be done with cable run inside the stand. It must be connected to the socket on the rear casing panel of the scanner applicator and laser therapy socket located on the unit.

### 3.1.6 Connection of ultrasound head

Connect the ultrasound head into the socket marked as .

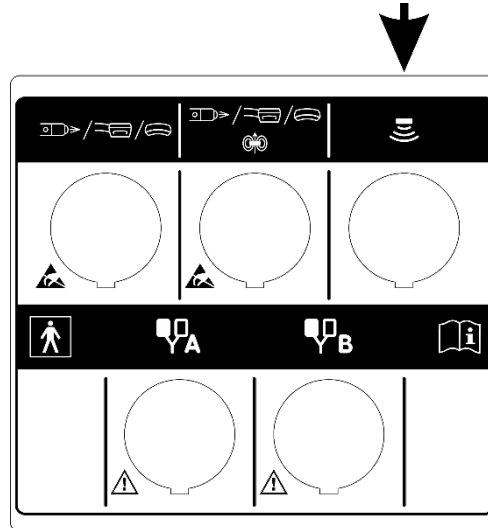

Figure 3.8. Ultrasound head socket

### 3.1.7 Connection in combined therapy

To perform a combined therapy treatment please use the ultrasound head and electrotherapy patient's cable connected to socket B. After switching the mains supply on, the ultrasound head is connected to a negative pole. While a red plug in channel B is connected to a positive pole.



**A black plug in channel B in combined therapy is inactive and electrodes should not be connected in.**

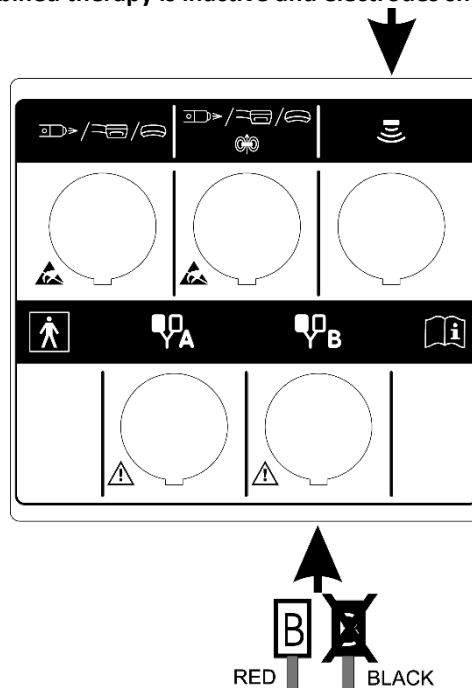

Figure 3.9. Output circuits for combined therapy

### 3.1.8 Patient's stop switch connection

Patient's stop switch should be connected into the socket marked as STOP.

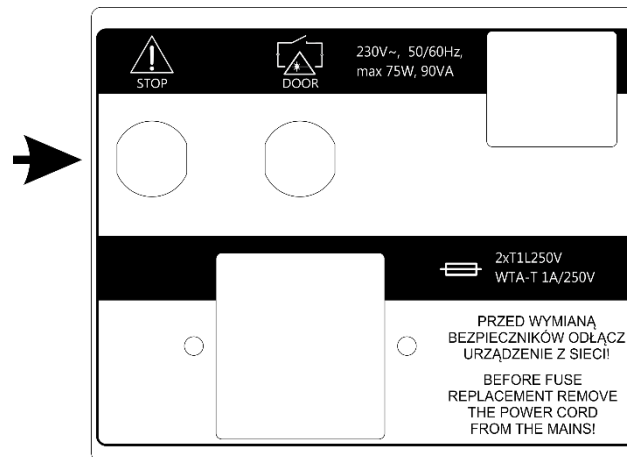

Figure 3.10. Patient's stop switch socket

### 3.1.9 Connection of DOOR remote connector

DOOR remote connector socket is located on the rear panel of the unit. In order to perform laser treatment procedures, insert the plug marked DOOR into the socket.

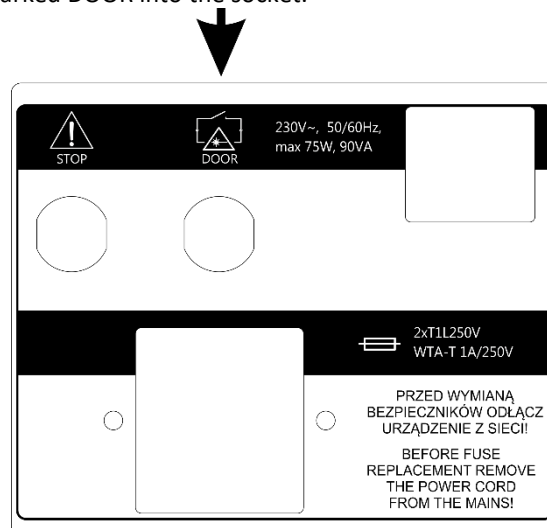



Figure 3.11. DOOR remote connector socket

### 3.1.10 First operation

Connect the unit to mains supply with delivered detachable mains cable. Switch the mains supply on. Then press the STANDBY key  to start the operation. After switching the mains supply on proper work of all blocks are tested.

In the case of battery operation, please hold on for at least 3 seconds the STANDBY key . Extension of the holding time prevents unintentional activation during transport.



**If after switching on mains supply the display is illegible and no light indicator is illuminated, check whether mains fuse or mains cable operate correctly. Care shall be given to apply fuses with rating given on the name plate. If fuse and cables are working properly, contact the authorized service.**

If the self-test results in appearing on the display the information about unit or connected applicator defect along with the error code, turn the unit off and contact with an authorized service representative.

Due to safety reasons the unit was equipped with software and hardware lock of laser applicators operation. The operation is possible only after correct entry of unique access code and inserting the remote interlock connector (marked as DOOR) into DOOR socket, located on back panel of the enclosure (provided as standard accessory).



### 3.1.11 Laser therapy access code

The code which allows for laser applicator operation has the shape of: **PHGL**

Entering an incorrect code prevents the execution of laser treatment procedures and laser applicator power measurement tests.



## 3.2 Setup mode

### 3.2.1 Basic information

Keyboard components designed for the unit operation are called "**keys**".

The area on the screen, where after its pressing a specific unit reaction is followed, is called "**button**".

The area on the screen that has the possibility to select or deselect any item, is called "**selection field**".

To enter <b>Setup</b> mode, press	
To leave <b>Setup</b> mode, press	
To go back one level, press	



Setup mode is available only if the treatment is not performed. Some setting options depend on the connected accessories. In the absence of some accessories, the options will not be available.

### 3.2.2 Language

With the PhysioGo unit information on the display may be presented in different language versions. The user is free to select language options.

To set the language version, press the **Language** button in the list of setup options, then press the desired version. Language version change is immediate.

### 3.2.3 Global settings

#### 3.2.3.1 Date and time

In this section there is a possibility to adjust date and time. To change these settings, press the button **Edit**. Using arrows, set the required value. Confirm settings using **Set** button or leave the edition mode by pressing **Cancel**.

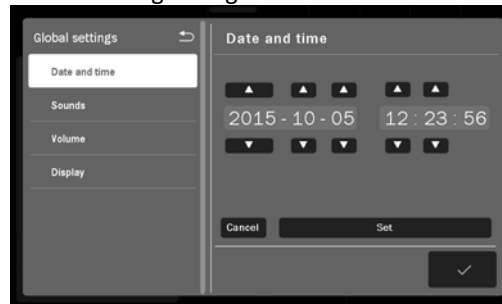

Figure 3.12. Screen view – date and time edition

#### 3.2.3.2 Sounds



The user may configure settings of acoustic signals, which occur during unit operation. Description of available configuration options:

- Keys sound
- Sound during treatment
- End of treatment sound
- Warning sounds
- Initial sound

In order to set the appropriate option, select or clear the selection field by its pressing.



#### 3.2.3.3 Volume

The user may adjust sound volume level. To perform this action:

- press the volume bar at desired place, or
- use buttons  on the screen, or
- use keys 

#### 3.2.3.4 Display

The user may adjust display brightness level. To perform this action:

- press the value bar at desired place, or
- use buttons  on the screen, or
- use keys 

### 3.2.4 Functional settings

#### 3.2.4.1 Channel operation mode selection

This function allows the user to set preferred style of unit operation.

Option	Explanation
Manual mode – automatically	After therapy selection, the unit is set in manual mode operation.
Program mode – automatically	After therapy selection, the unit is set in program mode operation.
Mode selection pop-up	After therapy selection, the unit displays a window with a list of operation mode selection options.

In order to set the appropriate option, select or clear the selection field by its pressing.

### 3.2.4.2 Program groups / medical fields

This function allows the user to set filters of available program mode options according to the preferred program groups or medical fields. In order to set the appropriate option, select or clear the selection field by its pressing.

For program groups, the following options are available:

- Preset programs
- Preset sequences – only for electrotherapy
- User programs
- User sequences – only for electrotherapy
- I/t curve – only for electrotherapy, channel A
- Voll acupuncture programs – only for laser point probes
- Nogier acupuncture programs – only for laser point probes

For medical fields, instead of the preset treatment programs and sequences the following options classified by medical nomenclature are available:

- Orthopedics
- Sports medicine
- Aesthetic medicine
- Rheumatology
- Neurology
- Urology
- Dermatology
- Angiology

The classification of preset treatment programs and sequences into the above mentioned categories do not limit their applications in other fields, according to the knowledge and experience of doctors and physiotherapists.

### 3.2.4.3 US units

This function allows for selection of indication units for ultrasound therapy and combined therapy:

- Power – watts [W]
- Power density – Watt per square centimeter [W/cm<sup>2</sup>]

In order to set the appropriate option, select or clear the selection field by its pressing.

### 3.2.4.4 US head sensitivity

**For advanced users only!**

It is possible to modify sensitivity of ultrasound heads in terms of no contact detection. According to treatment specifics, the sensitivity can be improved or reduced beyond default settings.

To change it you need to:

Step	Description
1.	Enter the setup mode. Select the <b>Functional settings</b> tab, then select the <b>US head sensitivity</b> .
2.	Select the ultrasound head type.
3.	Set a new sensitivity value.

Main features of sensitivity settings are listed below.

Sensitivity settings	Advantages	Disadvantages
Default	<b>Default manufacturer settings</b>	
High	<ul style="list-style-type: none"> <li>forced use of precise treatment technique, i.e. for training purposes</li> <li>protection of the ultrasound head against too fast usage</li> </ul>	<ul style="list-style-type: none"> <li>improved sensitivity on load's changes</li> <li>treatment timer stops more frequently</li> </ul>
Low	<ul style="list-style-type: none"> <li>reduced sensitivity on load's changes</li> <li>facilitated treatment performing on small parts of the body</li> <li>facilitated treatment performing on areas including bones, e.g. hands</li> <li>facilitated phonophoresis treatment performing</li> <li>treatment timer does not stop frequently</li> </ul>	<ul style="list-style-type: none"> <li><b>rapid usage of ultrasound head – possible overheat</b></li> <li><b>reduced comfort of patient's sensations – possible increase of heat feeling in the tissue</b></li> </ul>

### 3.2.4.5 US head bad contact signaling

This function allows you to set the time after which in case of US head weak contact the treatment will be interrupted.

Option	Explanation
Default (after 5 sec.)	The treatment will be interrupted after five seconds when the US head will lose the acceptable level of contact quality with the patient's body.
Delayed (after 10 sec.)	The treatment will be interrupted after ten seconds when the US head will lose the acceptable level of contact quality with the patient's body.

In order to set the appropriate option, select or clear the selection field by its pressing.

### 3.2.4.6 Induction units

PhysioGo unit has a possibility to select magnetic induction units. Available options:

- mT – militesla,
- Gs – Gauss.

In order to set the appropriate option, select or clear the selection field by its pressing.

### 3.2.4.7 Battery – model 7011

This function allows the user to set the battery charging mode.

Option	Explanation
Charge battery up to 80%	Reducing the battery power level extends its lifetime at the expense of shorter working hours in case of mains power failure.
Charge battery up to 100%	Maximum battery working hours. Keep in mind that full battery charging shorten its life.

## 3.2.5 Service

### 3.2.5.1 Electrodes test

This function allows the user to quickly check the usage status of electrodes applied in electrotherapy treatments. It can also be successfully used to assess the continuity of patient's cables.

In order to exercise the option, follow the instructions shown on the display. Detailed description of the function is described in the *PhysioGo – Technical description* manual.

### 3.2.5.2 US head calibration

This function allows the user to change the ultrasound head parameters in case of frequent contact quality problems caused by the frequency changes of ultrasound transducers characteristics.

In order to exercise the option, follow the instructions shown on the display. Detailed description of the function is described in the *PhysioGo – Technical description* manual.

### 3.2.5.3 Miscellaneous

In order to exercise the option, follow the instructions shown on the display.

### 3.2.5.4 Laser applicators output power test



This function allows the user to check if the output power of laser radiation emitted by laser applicators is correct.



**Laser output power test for a given applicator is only possible if it is not previously selected in a laser therapy channel tab.**

The applicator selection is performed by:



- pressing on the screen the selected field with its symbol, or
- a double press on the screen clear field with its symbol, or
- check box indication and pressing a key  on the keyboard.



**Laser output power measurement of point probes and scanning applicators is performed automatically, the results are displayed on the screen. Laser output power measurement of the cluster laser applicator is possible by the use of external radiation sensor.**

During this procedure it is recommended to follow the instructions shown on the display.

To measure output laser power of the laser applicator:

Step	Description
1.	Enter the setup mode. Select <b>Service</b> tab, then select <b>Laser applicators output power test</b> .
2.	Select the channel. Connected applicator is identified in the <b>Accessory</b> field.
3.	Press <b>Run the power measurement</b> button.
4.	Enter the access code: <b>PHGL</b> . Confirm the code by pressing key or button 
5.	An instruction window depending on the type of tested applicator will appear on the screen. Follow the steps according to the instructions.
6.	Verify the measured value.
7.	To complete the procedure, press the key or button 

If measurement power is different more than  $\pm 20\%$  from nominal power it is recommended to repeat the measurement. The cause of incorrect indication of emitted output power may be:

- fault of the laser applicator,
- heavily soiled laser diodes or optical elements.



**In case, when results of five consecutive measurements are incorrect, contact the authorized service.**

## 3.2.6 Statistics

### 3.2.6.1 Info

Provides information about the version of the unit, software, interface and software build date.





### 3.2.6.2 Unit statistics

Provides information about the number of treatment procedures performed. Statistics can be deleted. If you want to delete statistics, press **Delete programs counters** button.

### 3.2.6.3 Accessories statistics

Provides information about the connected accessories.

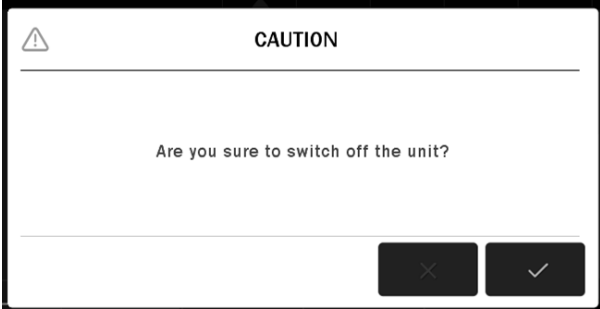
## 3.3 Transport position – the stand with scanning applicator

Step	Description
1.	Proceed with the treatment to the end or stop it by pressing the key 
2.	Put the equipment back.
3.	Click the UNIT ON / OFF (STANDBY) button on the front panel  . A message will appear on the display:
4.	
5.	Press  to shut down the system correctly.
6.	Switch the mains rocker off.
7.	Disconnect the mains cable and all applicators except the scanner from the device.
8.	Then unlock the brakes and transport the stand.
9.	Transport the stand.
10.	After arranging the stand in the destination place, lock the brakes.
11.	Connect the mains cable and applicators to the device.



## 4. Unit operation

The unit may operate in one of two modes:

- program mode,
- manual mode.



Notes – unit operation:

- In the program mode you can use preset procedures of treatment programs, treatment sequences as well as user-defined programs and sequences.
- In the program mode you cannot edit the preset programs parameters. However, they can be easily "copied" to the manual mode. In order to do it, press the button  .
- There is a possibility to repeat the completed treatment. In order to do it, press  on the keyboard or screen.

### 4.1 Patient preparation and treatment performance

To perform safe and effective treatment procedure:

- make sure if there are no contraindications to perform the treatment,
- the patient should be placed in a comfortable position while providing relaxation of tissues in the treatment area, the patient should be in lying position in case of treatment performed near the head,
- sitting or reclining position should be applied to patients with respiratory disorders or breathing difficulties,
- inform the patient about the possible feelings occurring during treatment procedure.



**The treatment effectiveness depends on the choice of parameters to the current patient's condition. The patient's condition changes over time. Its observation and assessment should take place before, during and after therapy. Such an action is necessary for changing the parameters in order to adapt them to the actual condition of the patient.**

It is recommended to keep the records of treatment, including the parameters of the therapy, the area of treatment, treatment technique, dose and symptoms after therapy. If the treatment does not generate the intended effects, change of treatment parameters should be taken into consideration. It is necessary to continuously update knowledge and follow literary activities in the scope of therapy.

When performing therapy, it is recommended to follow the guidelines given in the following section.

#### 4.1.1 Electrotherapy

- Before electrotherapy it is necessary to check the correct operation of the device and check the technical condition of cables and electrodes using a tester or the built-in device function – see chapter 3.2.5.1.
- Use only disinfected and in good condition electrodes.
- Improper selection of electrodes can cause skin irritation and burns.
- In case of direct current and unidirectional pulse currents of long pulse duration it is necessary to use tin electrodes.
- It is necessary to use properly moistened pads for electrodes, they may be made of viscose or fine mesh gauze to "keep" water properly. For unidirectional currents it is necessary to use properly moistened pads and of adequate thickness, however water should not drip from them.
- The water should be warm so as not to cause vasoconstriction in the area of performed treatment, you should use casual tap water.
- Apply the gel (e.g. aloe Vera) coupling the electrodes with the patient's body if there are no viscose or gauze pads.
- Properly attach the electrodes with viscose pads to the patient's body, e.g. by Velcro belts, elastic bandage or sand bags.
- In the place of the arrangement of the electrodes it is necessary to estimate the continuity of the skin and exteroceptive sensation.

- In order to decrease the resistance of skin you can clean it with alcohol or water with soap, after wiping leave the skin moist. Small skin damages should be secured with medical or cosmetic petroleum jelly.
- During the first therapy it is necessary to use rather lower doses of current than the recommended ones. Intensity (sensory threshold level or motor threshold) depending on the goal of therapy, it is necessary to increase in accordance with the patient's sensations and maintaining comfort during treatment.
- In case of reporting burning it is necessary to stop the treatment and examine the skin.
- The electrodes should be used in accordance with the indications of the manufacturer and should be replaced periodically, depending on the degree of wear. Loss of electrical properties by the electrodes causes the risk of burning the patient.

#### 4.1.2 Ultrasound therapy

- Before the treatment it is necessary to check the efficiency of functioning of the equipment and to control the cables and ultrasound head.
- It is necessary to explain to the patient the method of treatment and sensations during the treatment (always painless).
- It is necessary to clean the skin (or soap or alcohol 70%) in the place of application. If skin is very hairy in the place of treatment, it is necessary to shave it gently, cover the remaining parts of the body in order to avoid undercooling.
- The position of the therapist should facilitate free access to the equipment in such a way that the ultrasound head should remain for the whole time of treatment in contact with the skin of the patient. Proper pressure is necessary in order to ensure firm contact between the skin and the head which enables maximized transmission of ultrasound energy.
- It is necessary to use the medium conducting the ultrasounds, preferably gel.
- Coupling medium should be applied on the surface of skin, make continuous movements in the form of overlapping or longitudinal circles, the head shall not be removed from skin, in case of pain or burning it is necessary to stop therapy and change parameters.
- It is necessary to localize the tissue affected by the disease, determine its type, depth, which determines the choice of frequency of ultrasounds (up to 6 cm frequency 1 MHz, up to 1 cm frequency 3,5 MHz), surrounding tissues, tissues repair phase (acute conditions – only mechanical operation of ultrasounds, in chronic conditions mainly thermal effect), chose the method of application (direct, indirect), determine proper exit position: without pain, relaxation position, treated tissues should be moved as close to the surface of skin as possible.
- In direct therapy the head is moved in a continuous way, by exercising pressure, parallel to the skin, by applying steady, rhythmical motion patterns at average speed of 4cm/s. Too fast motions cause too low accumulation of ultrasound energy, too slow motions cause overheating of tissues in case of using higher intensities of ultrasounds.
- Choice of the method of moving the head depends on the shape of treated surface. In case of treating surfaces with irregular shape, motion pattern may appear as overlapping circles. This method requires from the therapist to make circular motions of small diameter, the size of ultrasound head should be such that the subsequent circular sliding motion overlaps the half of the previous motion.
- In case of treating larger, flat surfaces it is necessary to carry out longitudinal movements. This method requires from the therapist carrying out sliding movement with the adequate rhythm and carrying out side movements of length equal to half of the ultrasound head's diameter. As far as possible it is recommended to slightly press the head to the skin surface as this increases the penetration of ultrasounds deep into the tissues.
- Even during treatment of relatively small areas, such as trigger points, elements of scars or tendons it is necessary to make even very small but continuous movements with the head (often determined as semi-stationary techniques).
- Ultrasounds in water bath are used if part of the body subjected to therapy is of irregular shape or there is a spot sensitivity enabling direct contact with ultrasound head. Most often it is used in therapy of palms, forearms, feet and ankles. Part of the body subjected to therapy should be immersed in degassed water with temperature pleasant for the patient. Waterproof head must be placed at the distance of 1-2 cm and move parallel to the treated surface. Intensity must be increased by 30-50%, to obtain a dose like in direct therapy.
- Output power must be switched on if the head is in direct contact with the skin and at the same time it is in motion. Such a procedure allows to avoid damages to the converter and prevent skin injuries, which

may occur if a sufficient amount of energy is taken back to the head. Control system which monitors the contact of the head reduces the output power, if the head's contact is inadequate.

#### 4.1.3 Combined therapy

- Combined therapy consists in simultaneous effect of ultrasounds and pulsed current of low or medium frequency on the tissues, by employing specialized devices generating ultrasounds and currents.
- Influence of ultrasounds increases permeability of the skin for the current, owing to which it is allowed to use smaller doses of amperage. Combination of activity of ultrasounds and currents produces bigger therapeutic effects than in case of their separate application.
- In combination therapy it is possible to precisely localize the place of application with a very small dose of current as the ultrasounds increase the sensitivity of nerve fibers.
- Ultrasounds prevent or clearly decrease the effect of habituation which is negative from the therapeutic point of view, therefore the electric stimulus is more efficient and may be applied in long term without adverse effects.
- Combined therapy is of huge importance both in diagnostics (searching for trigger points, hyperacusis zones and Head's zones) and in treatment.
- In combined therapy ultrasounds are combined with bidirectional pulsed currents (TENS, HVS, average frequency) in order to limit the occurrence of electrochemical reactions and ensure proper depth of penetration.
- Choice of frequency of ultrasounds depends on the localization of trigger point. Frequency 0.8 – 1MHz is used for treatment of myofascial trigger points and localized in connective tissue, whereas frequency 3,5 MHz in treatment of surface points in skin.
- The power density of ultrasounds used in combination therapy amounts to 0.5 to 1.5 W/cm<sup>2</sup>.
  - The power density of 0.5 W/cm<sup>2</sup> is employed in the area of face and neck, it is recommended in case of active trigger points and significant painful conditions.
  - The power density of 0.5 to 1.0 W/cm<sup>2</sup> is employed in the paraspinal area, it is recommended in case of active trigger points and painful conditions of medium intensity and in slim patients.
  - The power density of 1.0 to 1.5 W/cm<sup>2</sup> is recommended in painful conditions of low intensity, on limbs, in the area of hips and buttocks in stout patients.
- Most often impulse emission of ultrasounds is applied, with duty factor of 20-75%.
- Current parameters in diagnostics of trigger points:
  - traditional, symmetric TENS – frequency 100Hz, pulse time 0.1ms, intensity above sensory threshold,
  - dipole interference, AMF – frequency 100Hz, intensity above sensory threshold.
 Semi-stable technique, treatment time from several seconds to 2 minutes per one point.
- In combined therapy an active electrode is the ultrasound head, placed above the pain location. Possibilities of placing a passive electrode:
  - outside the area where the treatment is carried out,
  - above the nerve supplying the pain area,
  - above the spot of referenced pain,
  - within a given dermatome, where pain area is located.
- In local therapy the parameters of ultrasounds and current are adapted to the actual condition of tissues.

#### 4.1.4 Laser therapy

- Prior to treatment it is necessary to explain to each patient the applicable safety rules during laser therapy treatments. Prior to the treatment, the patient must wear properly matched protective goggles.
- Before the treatment it is necessary to check the efficiency of functioning of the equipment and to control the laser applicators and the measurement of the output laser power according to 3.2.5.4
- Dose of radiation must be adapted to the goals of therapy. Therapeutic dose is described as energy density and is expressed in J/cm<sup>2</sup>.
- Technical parameters of the equipment, that is the wave length and surface of an applicator, have direct impact on the dose of radiation.
- Methods of application (point applicator – contact, cluster applicator – contact, contactless), scanning (contactless) is adapted depending on the size of application area and the goal of therapy.

- It is necessary to follow the recommendations provided below when choosing energy density:
  - at the beginning of treatment series and in acute conditions it is necessary to use smaller doses up to  $4 \text{ J/cm}^2$  – it is always necessary to observe the reaction of the patient's organism,
  - in chronic conditions – higher doses, above  $4 \text{ J/cm}^2$ .
- In therapy it is allowed to use the following application techniques:
  - single point or several points within a given area (e.g. painful points or acupuncture points, wound along the edges or within a small distance from the wound, within a knuckle);
  - grid method and scanning (large surfaces).
- In each technique it is necessary to ensure that the radiation beam is at right angle on the tissue.

#### 4.1.5 Magnetotherapy

- Prior to treatment it is necessary to check the presence of magnetic field by means of magnet (hand with magnet inserted within the applicator).
- Other types of therapy carried out at the same time does not constitute a counter-indication to use the therapy of low-frequency magnetic field.
- Treatments may be carried out through clothes, plaster, bandages.
- It is necessary to inform the patient that during treatment they will not sense anything.
- It is necessary to control the feeling of the patient, especially during treatments in the area of the head.
- It is necessary to properly fix the magnetic field applicator to the body of the patient, e.g. by means of Velcro belts or flexible bands.
- In order to avoid possible exacerbation of conditions the treatments must be started with a small dose, i.e. first treatment around 40%, second 70%, third 100% of the prescribed dose.
- First 5-15 treatments should be carried out on a daily basis, whereas subsequent treatments 2-3 times per week.

## 4.2 Screen configuration

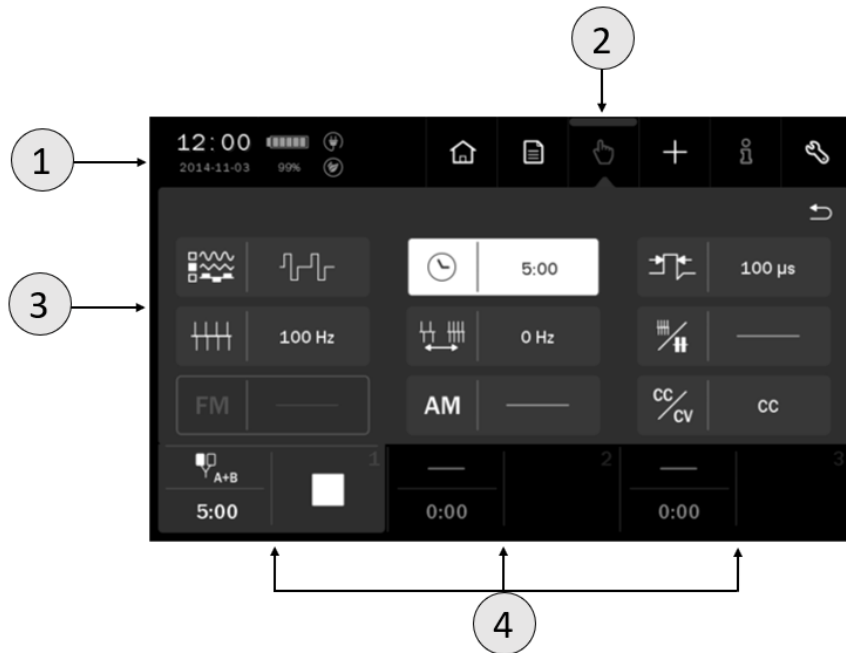

Figure 4.1. Field description

Symbol	Display	Description
		Date and time
		Quality level battery charging symbols
1	Status tab	80% Battery Percentage of charging level
		Eco battery mode – charging up to 80%
		Mains cable connected
		Therapy selection menu
		Program mode
		Manual mode
2	Main menu	User-defined treatment programs and sequences edition mode
		Information mode
		Setup mode
3	Edition field	This field shows: <ul style="list-style-type: none"> <li>• available therapies</li> <li>• treatment parameters in manual mode</li> <li>• list of preset treatment programs and sequences</li> <li>• list of user-defined treatment programs and sequences</li> <li>• settings</li> </ul>
4	Channel selection tabs	Details are described in chapter 4.3.2



**Note:** If the edition / main menu field is grayed out, it means that it is inactive.

## 4.3 General configuration

### 4.3.1 Treatment channel configuration

Channel	Therapy	
1	<p>Single circuit electrotherapy – A</p> <hr/> <p>Dual circuit electrotherapy – A+B</p>	
2	<p>Single circuit electrotherapy – B</p> <hr/> <p>Combined therapy – ultrasound therapy and electrotherapy</p> <hr/> <p>Laser therapy</p> <hr/> <p>Magnetotherapy</p>	
3	Ultrasound therapy	

Characteristics of therapy selection windows based on channel 2:

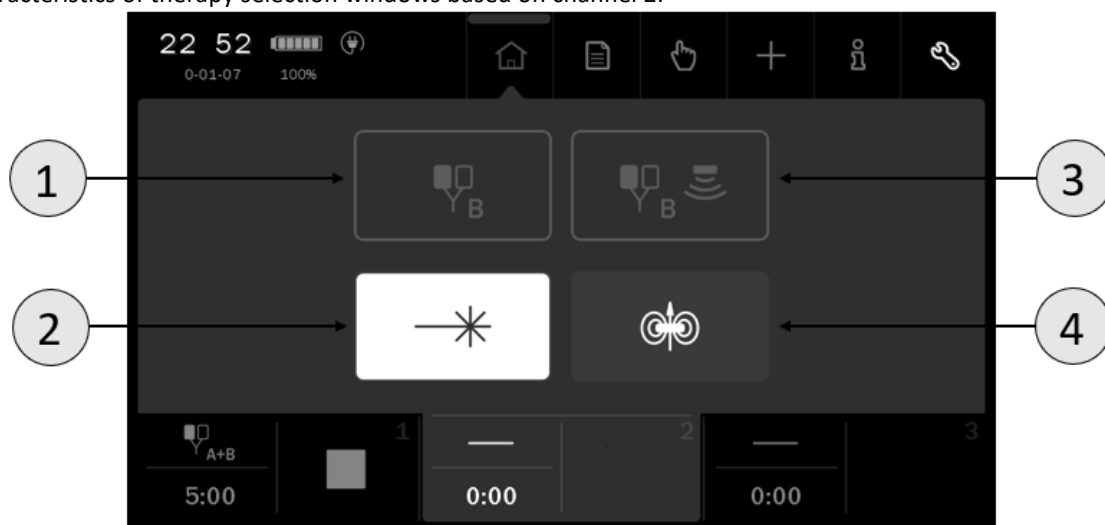

Figure 4.2. A sample view of therapy selection in channel 2

Symbol	Display
1	Unavailable therapy
2	Selected therapy
3	Unavailable therapy
4	Available therapy



Therapy availability depends on the type of connected accessories (applicators, ultrasound heads) and their condition (undamaged). Accessories are specified in *PhysioGo – Technical description* manual.

### 4.3.2 Channel selection tabs

The screen displays three channel selection tabs. They presents:

- selected therapy symbol,
- treatment time,
- information related to the particular channel operating status.

The color of the tab is identical to the background color of the edition field. In the background, other operating tabs are black.

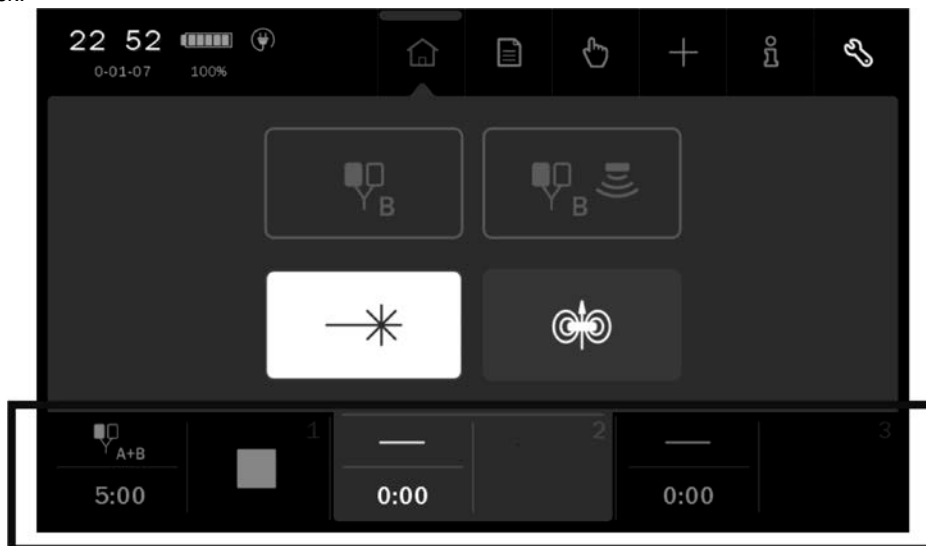







Figure 4.3. Location of channel selection tabs

The table below explains the meaning of the symbols presented in tabs:

Symbol	Treatment channel	Description
	1	Selected single circuit electrotherapy – socket A
	1	Selected dual circuit electrotherapy – socket A and B
	2	Selected single circuit electrotherapy – socket B
	2	Selected combined therapy
	2	Selected laser therapy – laser point probes
	2	Selected laser therapy – scanning laser applicator
	2	Selected laser therapy – cluster laser applicator
	2	Selected low frequency magnetotherapy

Symbol	Treatment channel	Description
	3	Selected ultrasound therapy
	Any	Ongoing treatment
	Any	Treatment interrupted
	Any	Ready to start amplitude adjustment or pause
	Any	Channel error (yellow symbol)



### 4.3.3 Limitations

The list of limitations in the unit operation:

Condition	Limitations
Treatment channel 1 Set electrotherapy mode A+B	In channel 2 it is possible to set only ultrasound therapy till the end of performed treatment in channel 1 and escaping from edition mode.
Treatment channel 2, selected electrotherapy B or combined therapy	In channel 1 there is a possibility of setting only electrotherapy A
Treatment channel 2, selected combined therapy	Treatment channel 3 – ultrasound therapy not available.
Treatment channel 3, selected ultrasound therapy	Treatment channel 2 – combined therapy not available.
I/t curve	I/t curve available only in channel 1 for electrotherapy A.

## 4.4 Display description

Display	Description	
Output signals of circuits and amplitude settings identifiers	<b>A</b>	Electrotherapy circuit – socket A
	<b>B</b>	Electrotherapy circuit – socket B
	<b>U</b>	Ultrasound circuit
	<b>ΣE P</b>	Laser circuit
	<b>M</b>	Low frequency magnetic field circuit
Information field	Amplitude settings: <ul style="list-style-type: none"> <li>• current and voltage for electrotherapy circuits</li> <li>• power density / power for ultrasound head</li> <li>• induction of low frequency magnetic field applicator</li> <li>• output energy and power emitted by laser applicator</li> </ul>	
	 <p>Quality of the ultrasound head contact. The more lit columns, the better the contact.</p>	

Display	Description
	<p>CV mode – the voltage value and the estimated intensity of current flow, where:</p> <ul style="list-style-type: none"> <li>• one column – current &lt; 10 mA</li> <li>• two columns – current in the range of 10÷20 mA</li> <li>• three columns – current in the range of 20÷30 mA</li> <li>• four columns – current in the range of 30÷40 mA</li> <li>• five columns – current &gt; 40 mA</li> </ul>
	Laser radiation emission.
Time indication	<p>Presentation of the treatment elapsing time.</p> <p>Moreover, for electrotherapy sequences, indication of the sequence step. The indicator of currently executing step is blinking.</p>

A sample views of treatment displays are presented in the following subchapters.

#### 4.4.1 Electrotherapy

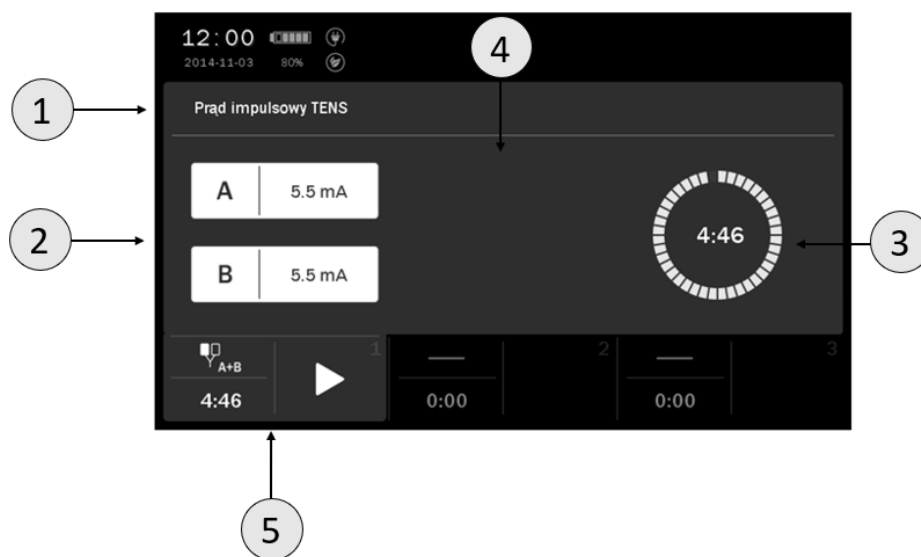

Figure 4.4. Screenshot sample view for dual circuit electrotherapy A+B

Symbol	Description
1	Current name / Program name
2	Output circuits amplitude identifiers
3	Indication of the treatment elapsing time
4	Information field
5	Tab field – channel 1

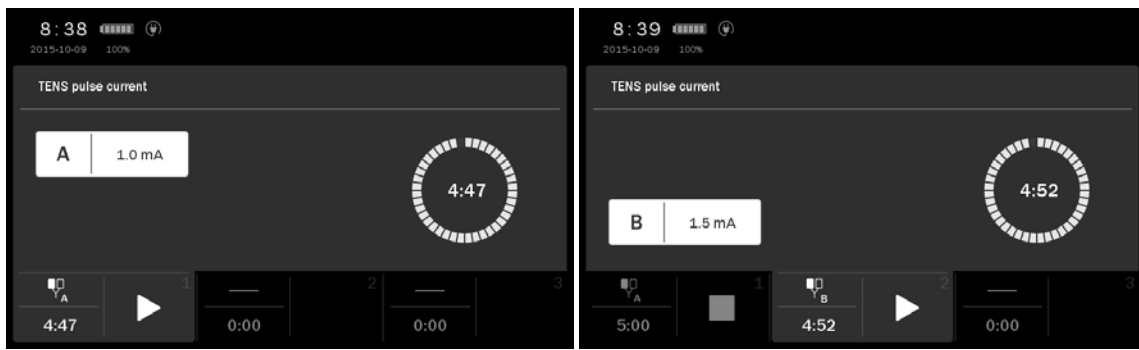

Figure 4.5. Screenshot sample view for single circuit electrotherapy A and B

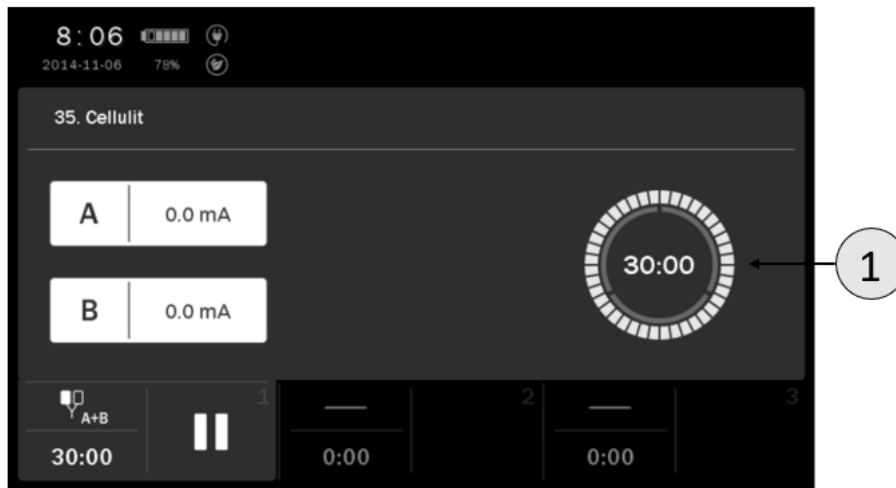

Figure 4.6. Screenshot sample view for electrotherapy sequences

Symbol	Description
1	Indication of the treatment elapsing time and sequence step

#### 4.4.2 Combined therapy

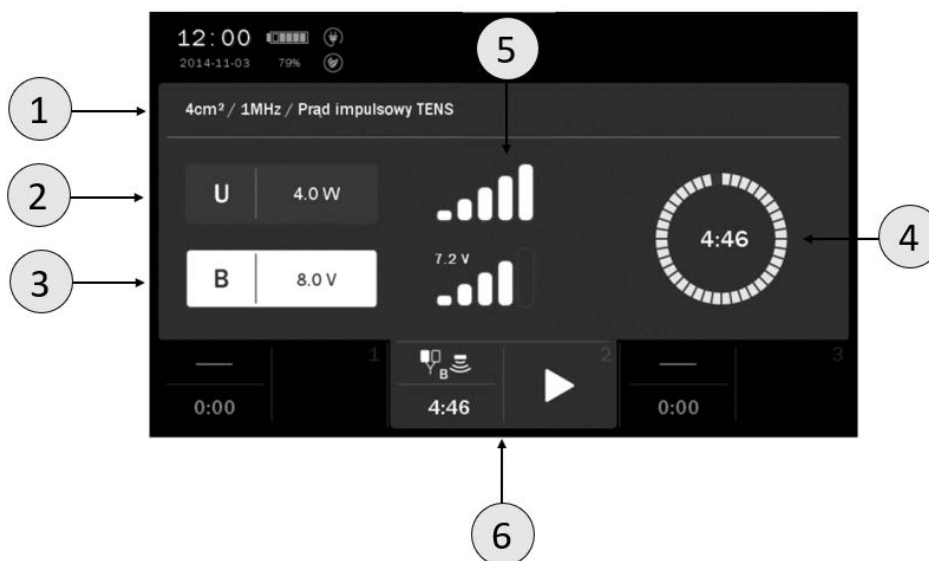

Figure 4.7. Screenshot sample view for combined therapy

Symbol	Description
1	US head parameters and current name / Program name
2	US power density / power value and quality of the US head contact
3	Current circuit and amplitude identifier
4	Presentation of the treatment elapsing time
5	Information field
6	Tab field – channel 2

#### 4.4.3 Laser therapy

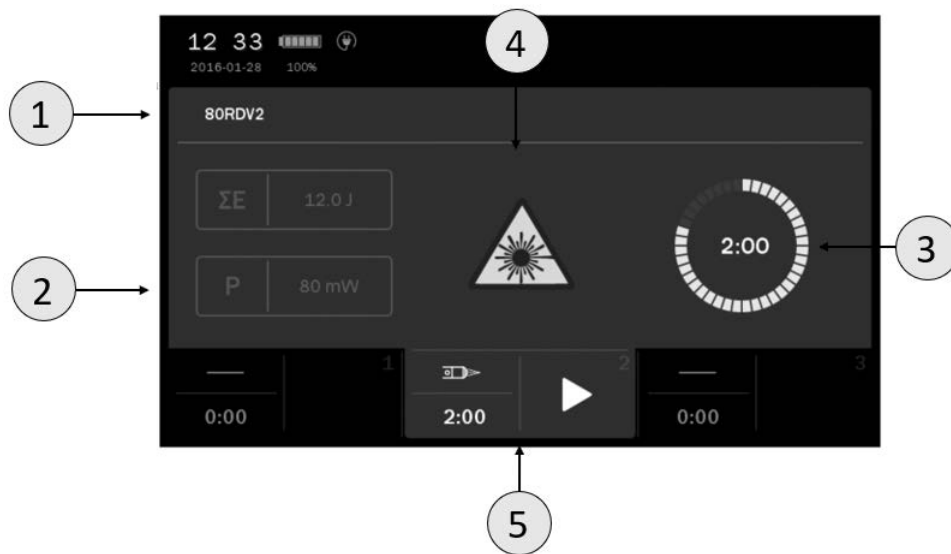

Figure 4.8. Screenshot sample view for laser therapy

Symbol	Description
1	Applicator identification / Program name
2	Output power
3	Presentation of the treatment elapsing time
4	Information field
5	Tab field – channel 2

### 4.4.4 Magnetotherapy

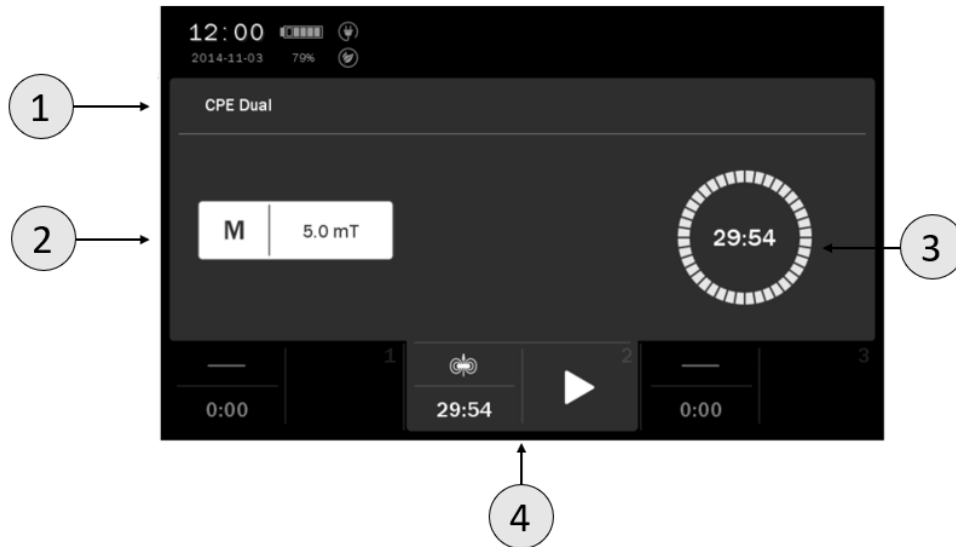

Figure 4.9. Screenshot sample view for magnetotherapy

Symbol	Description
1	Applicator identification / Program name
2	Magnetic induction
3	Presentation of the treatment elapsing time
4	Tab field – channel 2

### 4.4.5 Ultrasound therapy

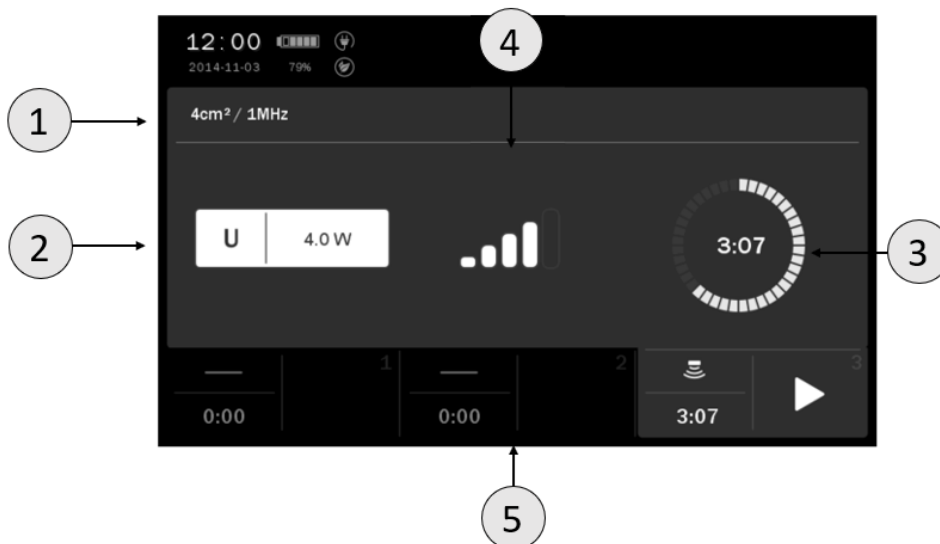

Figure 4.10. Screenshot sample view for ultrasound therapy

Symbol	Description
1	Area and frequency / Program name
2	Power / power density
3	Presentation of the treatment elapsing time
4	Information field
5	Tab field – channel 3

## 4.5 Operation with preset treatment programs and sequences

The simplest method of unit's operation is to use its preset programs or treatment sequences. The unit includes a database containing several dozens of most frequently met disorders together with suggested treatment types and parameters. In this mode, the operation is reduced to selection of disease entity from the list.



**The values of the preset treatment programs parameters are based on the available literature data and they are determined as average values. Parameters should be treated exclusively as indications. Sole responsibility for application of preset treatment programs bears the User.**



Symbol definition and parameter range are specified in the *PhysioGo – Technical description* manual.

Pressing the button  after program / sequence selection results in appearing information which contains:

- technique description of electrodes, ultrasound heads, magnetic field applicators placement and conducting laser irradiation,
- illustrations with highlighted points or areas of the body covered by the treatment,
- suggested number of procedures, the frequency of repetition,
- impact on the patient,
- notes,
- treatment parameters.

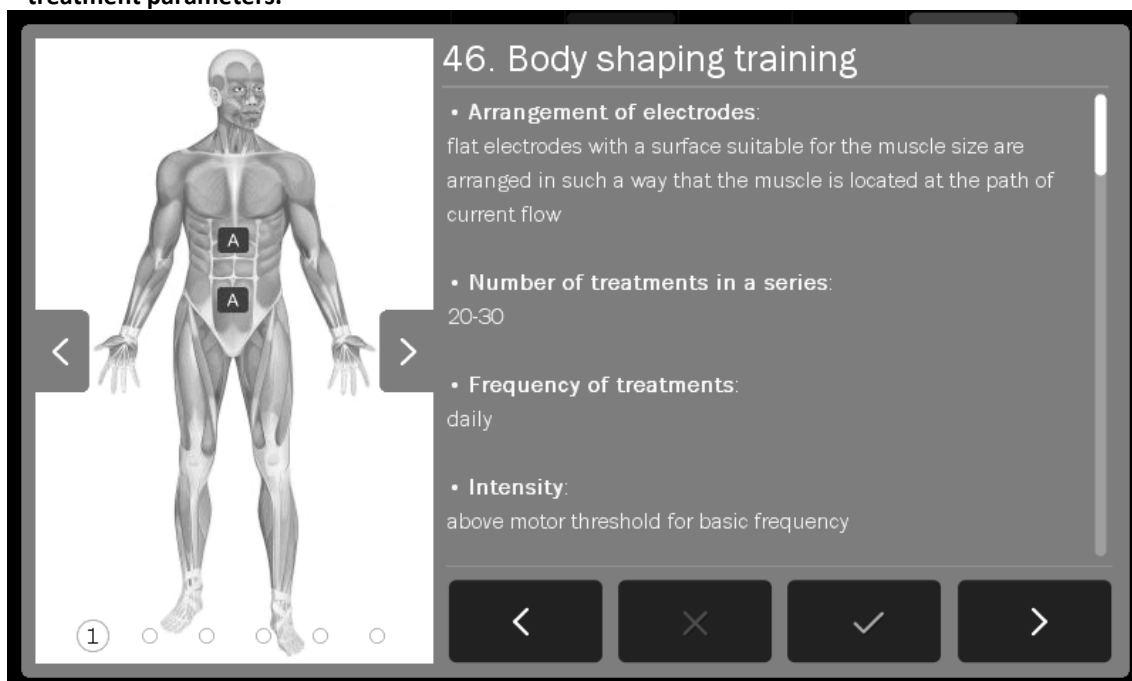

Figure 4.11. Information screen sample view

**Information mode navigation:**

Symbol	Explanation
	Approval of the program / sequence and return to the list (the current position)
	Back to the list of preset programs / sequences on a position from which there was an encyclopedia entry
	Go to the next program / sequence
	Go to the previous program / sequence
	Model of the human body – go to the previous / next illustration for the program / sequence



Use keys or a bar located on the right side of the display to scroll the information.

If it is necessary to interrupt the treatment procedure (pause), press STOP key. To resume the treatment procedure it is recommended to follow the instructions shown on the display.





Schematic procedures for different therapies are presented below. In continuous operation, it is recommended to start the treatment procedure from step 3 of each of the schemes.

**Schematic procedure for electrotherapy treatments:**







Step	Description
1.	Connect patient's cables.
2.	Switch on the unit.
3.	Select the tab 1 or 2 depending on needs or availability. Select the therapy
4.	Press the field <b>Program modes</b>
5.	Select the option <b>Preset programs</b> or <b>Preset sequences</b> from <b>Program modes</b> menu. Confirm by the key  or once again press the selected field.
6.	Select the program / sequence from the list.
7.	Prepare the patient for the treatment according to indications in point 4.1
8.	Press the key
9.	Using the keys   choose the circuit, using the keys   set the current or voltage amplitude.

**Schematic procedure for combined therapy treatments:**

















Step	Description
1.	Connect the patient's cable. Connect an appropriate ultrasound head for combined therapy.
2.	Switch on the unit.
3.	Select the tab no 2. Select the combined therapy
4.	Press the field <b>Program modes</b>
5.	Select the option <b>Preset programs</b> from <b>Program modes</b> menu. Confirm by the key  or once again press the selected field.
6.	Select the program from the list.

Step	Description
7.	Prepare the patient for the treatment according to indications in point 4.1
8.	Press the key 
9.	Using the keys   select the circuit, using the keys   set the amplitude of current or voltage, or optionally adjust the power / power density of the ultrasound head.

#### Schematic procedure for ultrasound therapy treatments:

Step	Description
1.	Connect the ultrasound head GS 4cm <sup>2</sup> or 1cm <sup>2</sup> .
2.	Switch on the unit.
3.	Select the tab no 3. Select ultrasound therapy 
4.	Press the field  <b>Program modes</b>
5.	Select the option <b>Preset programs</b> from <b>Program modes</b> menu. Confirm by the key  or once again press the selected field.
6.	Select the program from the list.
7.	Prepare the patient for the treatment according to indications in point 4.1
8.	Press the key 
9.	Using the keys   optionally adjust the power / power density of the ultrasound head.

#### Schematic procedure for laser therapy treatments:

Step	Description																		
1.	Connect an appropriate laser applicator.																		
2.	Switch on the unit.																		
3.	Choose the treatment channel 2. Select laser therapy 																		
4.	Enter the access code: <b>PHGL</b> . Confirm by the key or button  , select the applicator.																		
5.	Press the field  <b>Program modes</b>																		
6.	Select the option <b>Preset programs</b> from <b>Program modes</b> menu. Confirm by the key  or once again press the selected field.																		
7.	Select the program from the list.																		
8.	Prepare the patient for the treatment according to indications in point 4.1																		
	Press the key 																		
	<table border="1" style="width: 100%; border-collapse: collapse;"> <thead> <tr> <th style="width: 33%;"></th> <th style="width: 33%;"></th> <th style="width: 33%;"></th> </tr> <tr> <th>scanning applicator</th> <th>cluster applicator</th> <th>point applicator</th> </tr> </thead> <tbody> <tr> <td>9.</td> <td>Set the shape and size of the treatment area as well as default scanner distance.</td> <td>Set the treatment area.</td> <td>Set the treatment area.</td> </tr> <tr> <td></td> <td>Press the key </td> <td>Press the key </td> <td>Press the key </td> </tr> <tr> <td></td> <td>Press the key </td> <td>Press the button on the applicator.</td> <td>Press the button on the probe.</td> </tr> </tbody> </table>				scanning applicator	cluster applicator	point applicator	9.	Set the shape and size of the treatment area as well as default scanner distance.	Set the treatment area.	Set the treatment area.		Press the key 	Press the key 	Press the key 		Press the key 	Press the button on the applicator.	Press the button on the probe.
scanning applicator	cluster applicator	point applicator																	
9.	Set the shape and size of the treatment area as well as default scanner distance.	Set the treatment area.	Set the treatment area.																
	Press the key 	Press the key 	Press the key 																
	Press the key 	Press the button on the applicator.	Press the button on the probe.																







**Start of laser emission is signaled acoustically. Laser radiation starts after two seconds after pressing the button on the probe.**



#### NOTE:

Using the methods of control, adjustment or performance of procedures other than those specified herein may result in exposure to hazardous laser radiation.

**Schematic procedure for magnetotherapy treatments:**

Step	Description
1.	Connect the magnetic field applicator.
2.	Switch on the unit.
3.	Choose the treatment channel 2. Select magnetotherapy 
4.	Press the field  <b>Program modes</b>
5.	Select the option <b>Preset programs</b> from <b>Program modes</b> menu. Confirm by the key  or once again press the selected field.
6.	Select the program from the list.
7.	Prepare the patient for the treatment according to indications in point 4.1
8.	Press the key 
9.	Using the keys   optionally adjust the induction value.







**4.5.1 Voll and Nogier programs**

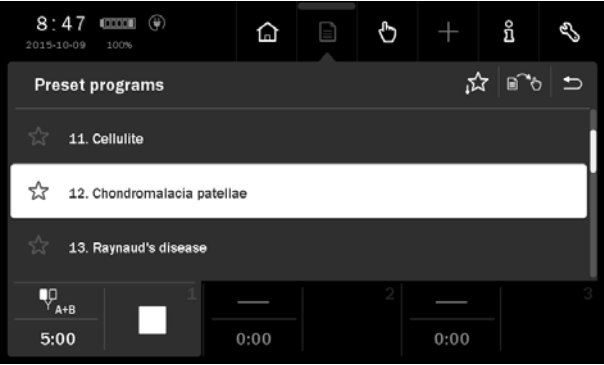

A specific group of preset treatment programs are positions dedicated to biostimulation laser point acupuncture according to Voll and Nogier, the so-called Voll and Nogier frequencies. These programs are only available for low lever laser point applicators. To select the program, proceed exactly as when choosing a preset treatment program.

**4.6 Favourite programs**

The function offers quick access to frequently used **preset programs and sequences** without browsing the entire list. Function is available for all therapies.

To add or remove the program from the favourite list, follow the instructions:

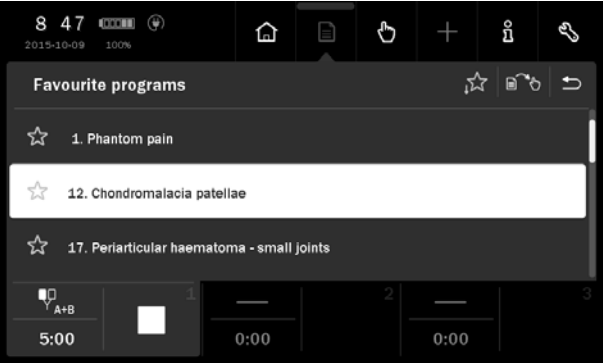
Step	Description		
1.	Prepare the unit to work with preset treatment programs and sequences (see section 4.5). Select program / sequence.		
2.			
	<table border="1" style="width: 100%; text-align: center;"> <tr> <td style="width: 50%;"><b>add</b></td> <td style="width: 50%;"><b>remove</b></td> </tr> </table>	<b>add</b>	<b>remove</b>
<b>add</b>	<b>remove</b>		
3.	<table border="1" style="width: 100%;"> <tr> <td style="width: 50%;">           Press the symbol  next to the name of the program / sequence. Symbol color changes to yellow and the program / sequence is inserted on the favourite list.         </td> <td style="width: 50%;">           Press the symbol  next to the name of the program / sequence. Symbol color changes to blue and the program / sequence is deleted from the favourite list.         </td> </tr> </table>	Press the symbol  next to the name of the program / sequence. Symbol color changes to yellow and the program / sequence is inserted on the favourite list.	Press the symbol  next to the name of the program / sequence. Symbol color changes to blue and the program / sequence is deleted from the favourite list.
Press the symbol  next to the name of the program / sequence. Symbol color changes to yellow and the program / sequence is inserted on the favourite list.	Press the symbol  next to the name of the program / sequence. Symbol color changes to blue and the program / sequence is deleted from the favourite list.		

Step	Description
4.	 <p>You can also remove the item from the favourite list, if you press the symbol </p>

To enter the favourite list, press the symbol .

If no item from the preset treatment program or sequences list is selected as a "favourite", then after entering the option, the list will be empty.













#### NOTE:

**Favourite** option is not available when you set the view of preset treatment programs or sequences by medical fields. See point 3.2.4.2

## 4.7 Manual mode operation



Symbol definition and parameter range are specified in the *PhysioGo – Technical description manual*.

Step	Description
1.	Switch on the unit.
2.	Choose the treatment channel 1, 2 or 3.
3.	Select the therapy according to the point 4.3. For laser therapy enter the code <b>PHGL</b> , confirm and select the applicator.
4.	Press the field  <b>Manual mode</b>
5.	In the case of electrotherapy and combined therapy select the current type.
6.	Using the keys   select the parameter for edition, using the keys   set its value.
7.	Prepare the patient for the treatment according to indications in point 4.1.
8.	Press the key 
9.	For electrotherapy, using the keys   choose the circuit, using the keys   set the current or voltage amplitude.
10.	If it is necessary, during treatment procedure, using the keys   set the amplitude.





If it is necessary to interrupt the treatment procedure (pause), press the key . To resume the treatment procedure it is recommended to follow the instructions shown on the display.

## 4.8 User programs





The User has the possibility to save in to the device memory own sets of treatment parameters in the form of programs.

### Saving of user program:





Step	Description
1.	Prepare the unit to work in manual mode (steps 1 – 5 see section 4.7).
2.	Set the program parameters.
3.	Press the button  from main menu.
4.	Select the item number under which the program will be saved. Confirm your choice with the key 
5.	Enter the program name. Press the key or button 

The user-defined programs are selected in the same way as preset treatment programs. In **Program modes** menu select the option **User programs**.



### Edition of user program:

Step	Description
1.	Prepare the unit to work in the program mode (see section 4.5).
2.	Select the option <b>User programs</b> from <b>Program modes</b> menu. Confirm by the key  or once again press the selected field.
3.	Select the program for edition.
4.	Press the button  from main menu.
5.	Select the action – <b>Edit</b> .
6.	Correct the parameters.
7.	Press the button  from main menu.
8.	Select the item number under which the program will be saved. Confirm your choice with the key 
9.	Enter or edit the program name. Press the key or button 

### Removal of user program:

Step	Description
1.	Prepare the unit to work in the program mode (see section 4.5).
2.	Select the option <b>User programs</b> from <b>Program modes</b> menu. Confirm by the key  or once again press the selected field.
3.	Select the program which will be deleted.
4.	Press the button  from main menu.
5.	Select the action – <b>Remove</b> .
6.	Confirm by pressing  or resign using 



**User program parameter view:**

Step	Description
1.	Prepare the unit to work in the program mode (see section 4.5).
2.	Select the option <b>User programs</b> from <b>Program modes</b> menu. Confirm by the key ✓ or once again press the selected field.
3.	Select the program which parameters will be checked.
4.	Press button 
5.	Press the key ✕ or button  to return to the user-defined treatment program list.

## 4.9 User sequences

The unit is equipped with an advanced editor which allows you to create electrotherapy treatment sequences. A single sequence may consist of up to four stages. The sequence may be created from previously saved user-defined programs.

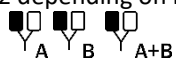
The user sequences are selected in the same way as preset treatment programs. In **Program modes** menu select the option **User sequences**.

Step	Description				
1.	Switch on the unit.				
2.	Select the tab 1 or 2 depending on needs or availability. Select the therapy 				
3.	Press the field  <b>Program modes</b>				
4.	Select the option <b>User sequences</b> from <b>Program modes</b> menu. Confirm by the button ✓ or once again press the selected field.				
5.	Select the sequence from the list.				
6.	Prepare the patient for the treatment according to indications in point 4.1				
7.	Press the key  . Select the amplitude control mode.				
	<table border="1"> <thead> <tr> <th>Automatic mode</th> <th>Semi-automatic mode</th> </tr> </thead> <tbody> <tr> <td>The sequence is performed continuously. Between the steps, the current or voltage amplitude is reduced to a safe level. Therefore, there is a need for its upregulation in order to ensure the proper feelings of the patient.</td> <td>Between the steps, the sequence is stopped – pause mode. The amplitude is reduced to zero. In order to continue the sequence performing, set the amplitude again in order to ensure the proper feelings of the patient.</td> </tr> </tbody> </table>	Automatic mode	Semi-automatic mode	The sequence is performed continuously. Between the steps, the current or voltage amplitude is reduced to a safe level. Therefore, there is a need for its upregulation in order to ensure the proper feelings of the patient.	Between the steps, the sequence is stopped – pause mode. The amplitude is reduced to zero. In order to continue the sequence performing, set the amplitude again in order to ensure the proper feelings of the patient.
Automatic mode	Semi-automatic mode				
The sequence is performed continuously. Between the steps, the current or voltage amplitude is reduced to a safe level. Therefore, there is a need for its upregulation in order to ensure the proper feelings of the patient.	Between the steps, the sequence is stopped – pause mode. The amplitude is reduced to zero. In order to continue the sequence performing, set the amplitude again in order to ensure the proper feelings of the patient.				

8.

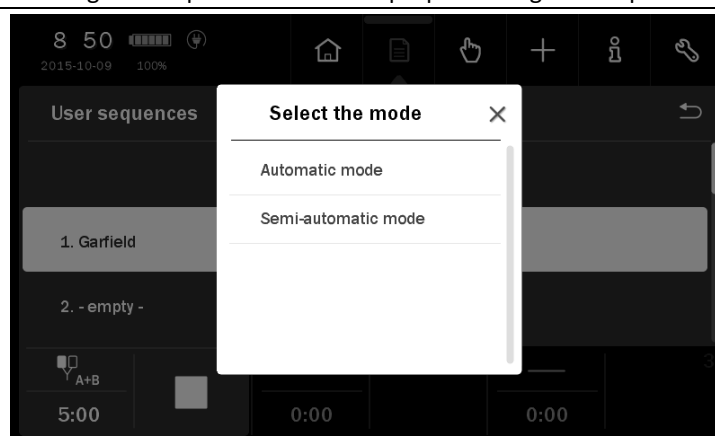

9. If it is necessary, during treatment procedure, using the keys   set the amplitude.



If it is necessary to interrupt the treatment procedure (pause), press the key . To resume the treatment procedure it is recommended to follow the instructions shown on the display.

#### Creation of user sequence:

Step	Description
1.	Prepare the unit to work in the program mode (see section 4.5).
2.	Select the option <b>User sequences</b> from <b>Program modes</b> menu. Confirm by the button  or once again press the selected field.
3.	Press the button  from main menu. This opens the user's sequence editor. Select the item to be saved. Press
4.	From the list of user programs, select the program and press . Repeat the action for additional items. The sequence may consist of up to 4 programs.
5.	Use the sequence edition tools described below to make changes in the created sequence.
6.	Press the button  to save the sequence. Enter the name. Then press
7.	Press the button  to escape from the sequence editor.

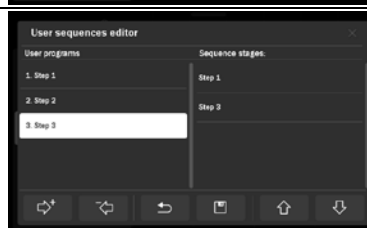
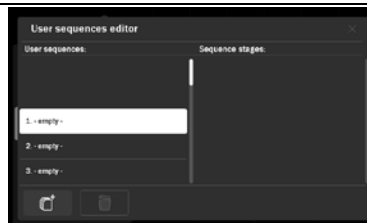

#### User sequence edition:

Step	Description
1.	Prepare the unit to work in the program mode (see section 4.5).
2.	Select the option <b>User sequences</b> from <b>Program modes</b> menu. Confirm by the button  or once again press the selected field.
3.	Press the button  from main menu. This opens the user's sequence editor.
4.	Select the sequence. Press
5.	Use the tools described below.
6.	Press the button  to save the sequence. Enter or modified the name. Then press

#### Sequence edition tools:











Button	Explanation
	<ol style="list-style-type: none"> <li>Select the user-defined program – left side of the edition screen.</li> <li>Press , selected item will be added as a new step of the sequence.</li> </ol>
	<ol style="list-style-type: none"> <li>Select the sequence step – right side of the edition screen.</li> <li>Press . Step will be deleted.</li> </ol>
	<ol style="list-style-type: none"> <li>Select the sequence step – right side of the edition screen.</li> <li>Press . Step will be moved up one level.</li> </ol>
	<ol style="list-style-type: none"> <li>Select the sequence step – right side of the edition screen.</li> <li>Press . Step will be moved down one level.</li> </ol>







**Removal of user sequences:**

Step	Description
1.	Prepare the unit to work in the program mode (see section 4.5).
2.	Select the option <b>User sequences</b> from <b>Program modes</b> menu. Confirm by the button ✓ or once again press the selected field.
3.	Press the button + from main menu.
4.	Select the sequence. Press 
5.	Confirm by pressing ✓ or resign using ✗

**4.10 I/t curve**

It is recommended to use the results obtained by determining I/t curve to create treatment programs that will be executed exclusively with the PhysioGo units with electrotherapy function.

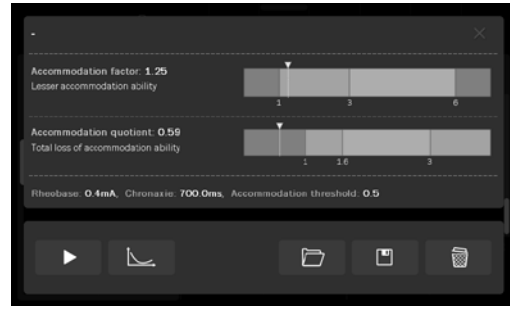

Step	Description	
1.	Switch on the unit.	
2.	Choose the tab 1, mode  Confirm by the button ✓ or once again press the selected field.	
3.	If the unit is in manual mode, press 	
4.	Using the keys   or by touch set the position of I/t curve. Confirm by the key ✓ or once again press the selected field.	
5.	Prepare the patient for the treatment according to indications in point 4.1. It is recommended to use the point electrode (cathode, black plug) as an active electrode.	
6.	Press  (key or field). The unit is in stimulation mode.	
7.	Using the keys   or buttons + —, increase the output current for the pulse duration of 1000 ms until reaching value, at which minimum muscle contraction is observed. The current value is automatically applied to the chart. The pulses appear at 2 seconds intervals.	
8.	Using the key  or button  , move one position to the right to the value under 700 ms pulse duration. Again set the current at such a value at which minimum muscle contraction occurs, then mark it on the diagram (setting starts with value measured for the previous pulse width, you can reduce the current and start your observation from zero value of the output current). Repeat the procedure for all rectangular and triangular pulse time values.	

Step	Description
9.	<p>Upon completion of stimulation, press the key  or button , the unit will automatically display:</p> <ul style="list-style-type: none"> <li>• rheobase, chronaxie, accommodation threshold value,</li> <li>• accommodation factor value along with commentary and visual evaluation on the scale,</li> <li>• quotient accommodation value with commentary and visual evaluation on the scale.</li> </ul>
10.	<p>Press  to see again the graph. Press  to save the curve. Enter the name and press </p>
11.	<p>Press the key  to escape from the I/t curve mode.</p>



It may happen that the muscle reaction is not observed for triangular pulses of 1000 ms and 700 ms pulse duration. Then you should interrupt the procedure and start it again from 500 ms pulse duration. For the time values of 1000 ms and 700 ms should be set 0 mA value. In this case, parameters are determined on the base of signal amplitude for 400 ms and 200 ms pulse duration.

There is a possibility to view the saved results of I/t curves. In order to open the list of saved I/t curves press  Then select the item to be loaded by pressing its name.

You can also delete the saved results of I/t curves. In order to delete the entry, press  Then select the entry to delete it by pressing its name and confirm the deletion by pressing the key / button .

## 5. Indications and contraindications

### 5.1 Indications

#### 5.1.1 Interferential and AMF currents

**biological impact:** interferential and AMF currents affect mainly tissues located deeper inside human body showing different biological impact based on the range of basic frequency:

- f 5÷50 Hz – stimulation of muscles
- f 40÷90 Hz – improvement of local circulation, acceleration of resorption
- f 50÷150 Hz – relief of pain and relaxation of muscles
- f 90÷150 Hz – relief of pain
- f 100÷150 Hz – normalization of vegetative system functions

**therapeutic application:**

- pains in ankylosing spondylitis
- discopathy
- degenerative joint diseases
- pains in rheumatoid arthritis and spondylitis
- neuralgias and compression syndromes
- periartritic inflammation
- vascular syndromes
- post-traumatic conditions after leg injuries
- syndromes with increased muscular tone
- vegetative disorders
- oedemas, subcutaneous and intramuscular extravasations

#### 5.1.2 Kotz' current – Russian stimulation

**biological impact:** contraction of skeleton muscles

**therapeutic application:**

- muscle atrophy of immobilization
- muscle re-education
- modeling of silhouette
- lipolysis
- cellulite

#### 5.1.3 TENS and SP-TENS current

**biological impact:** pain relief, improvement of blood circulation, stimulation of muscles, stimulation of nerve fibres with varying effect depending on frequency range, pulse width and modulation type:

- $t_{imp}$  50÷100  $\mu$ s, f 50÷150 Hz – inhibition of pain conduction
- $t_{imp}$  100÷300  $\mu$ s, f 1÷10 Hz – stimulation of endorphins synthesis, facilitation of pulse transmission along afferent fibres, stimulation in electroacupuncture
- $t_{imp}$  200÷300  $\mu$ s, f 5÷50 Hz – stimulation of neuromotoric units
- BURST – strong analgesic effect
- SP-TENS – for spastic paralysis of the nervous muscle system

**therapeutic application:**

- discopathy
- degenerative joint diseases
- arthralgias and pain syndromes of rheumatoid arthritis and spondylitis
- neuralgias and compression syndromes
- periarthritic inflammation
- zoster
- post-surgical pain
- other pain syndromes except for tumor related pain
- partial damage of afferent nerve fibres (facilitation of impulse transmission)
- atrophy of immobilization or partial denervation
- acceleration of bone consolidation
- wound healing

#### 5.1.4 Diadynamic currents

**biological impact:**

- pain relief
- improvement of peripheral circulation
- normalization of vegetative system functions
- muscle relaxation
- acceleration of resorption

**therapeutic application:**

- pains in ankylosing spondylitis
- discopathy
- degenerative joint diseases
- neuralgias and compression syndromes
- periarthritic inflammation
- vascular syndromes
- post-traumatic conditions after leg injuries
- syndromes with increased muscle tone
- vegetative disorders
- chilblains
- oedemas, subcutaneous and intramuscular extravasations
- emphysema, subcutaneous emphysema

#### 5.1.5 Ultra Reiz current

**biological impact:**

- decrease in muscle tone
- pain relief
- improvement of peripheral circulation

**therapeutic application:**

- degenerative joint diseases
- neuralgias
- peripheral circulation disorders
- spinal cord pain syndromes
- radicular pains (sciatic neuralgia)
- post-traumatic states

### 5.1.6 Rectangular impulses

**biological impact:** muscle and nerve stimulation

**therapeutic application:**

- electrostimulation of nerves
- electrostimulation of healthy or slightly denervated skeleton muscles
- electro diagnostics, plotting the I/t curve

### 5.1.7 Triangular impulses

**biological impact:** muscle and nerve stimulation

**therapeutic application:**

- electrostimulation of smooth muscular coat, e.g. electro-stimulation in case of post-surgical atonia of bladder and intestines, treatment of spastic and atonic constipation
- electrostimulation of denervated skeleton muscles
- electro diagnostics, plotting the I/t curve

### 5.1.8 Tonolysis

**biological impact:**

- restoration of physiologic equilibrium of muscles
- activation of the system of stretch reflex inhibiting organ by stimulating Golgi's organ
- activation of new synaptic junctions

**therapeutic application:**

- stimulation of spastically paralyzed muscles with damaged central nervous system

### 5.1.9 Microcurrents

**biological impact:**

- restoring the electric equilibrium of cells and tissues
- improving blood circulation in capillaries
- supporting cells and tissues recovery process
- acceleration of lactic acid and pain substances decomposition and elimination

**therapeutic application:**

- acute / chronic pain of known etiology
- extremities osteoarthritis / spine joint disease
- difficult bone consolidation
- wounds which are difficult to heal
- traumas of periarticular soft tissues
- decubitus ulcers
- ulceration
- face medical aesthetics

### 5.1.10 USS – Unipolar Sine Surge

**biological impact:**

- pain relief
- increasing muscle strength
- circulation improvement

**therapeutic application:**

- acute / chronic pain of known etiology
- drug administration (iontophoresis)
- circulation disorder
- oedemas
- hematomas
- muscle strength training

### 5.1.11 Galvanic current

**biological impact:**

- dilatation of peripheral vessels
- ion movement within tissues

**therapeutic application:**

- drug administration (iontophoresis)
- circulation disorder
- diagnostics of internal inflammatory focuses (galvano-palpation)

### 5.1.12 Ultrasound therapy

**biological impact:**

- increase in cell membranes permeability
- improvement of tissue respiration and stimulation of cellular metabolism
- changes in tissue colloid structure and their hydration
- changes in tissue ion systems
- change of tissue reading in alkaline direction

**therapeutic application:**

- analgesic effect:
  - cervical arthritic spondylosis pains
  - rachialgias, chest and loins section
  - sciatic neuralgia pains
  - painful shoulder syndrome
  - tennis elbow
  - phantom limb pains
- reduction of muscle tone
- degenerative joint diseases
- neuralgias
- lockjaw
- scars
- shin ulceration
- medicine application (phonophoresis)

### 5.1.13 Combined therapy

As for the electrotherapy and ultrasound therapy treatments.

### 5.1.14 Laser therapy

- difficult healing wounds and ulcerations
- post-surgical wounds, post-amputation wounds
- skin necrosis
- skin damages

- ulcerations of shanks, trophic ulcerations
- burns
- frostbites
- decubitus ulcers
- scars without fibrosis
- wrinkles
- cellulite
- striae
- simple acne
- simplex herpes
- afts
- psoriasis
- chronic arthritis conditions
- painful shoulder syndrome
- enthesopathies
- carpal tunnel syndrome
- bursitis, tendovaginitis, fascitis
- subcutaneous haemorrhages (ecchymosis), contusions
- difficult, prolonged union of fractured bones
- joint injuries
- sprains, dislocations
- torticollis
- sudeck's syndrome (stage I and II)
- ankylosing spondylitis
- rheumatoid arthritis
- spondyloarthrosis
- coxarthrosis
- gonarthrosis
- muscle overload syndromes
- neuralgias of peripheral nerves
- neuralgias after zoster
- diabetic neuropathy

#### **5.1.15 Magnetotherapy**

- delayed union of fractured bone
- pseudoarthrosis
- osteoporosis
- degenerative joint disease
- rheumatoid arthritis
- ulcerations and trophic shank changes
- bacterial infection of skin and soft tissues
- keloids
- condition after cerebral stroke
- hemicrania and vasomotor headaches
- functional disorders of cranial and peripheral nerves
- multiple sclerosis
- cornea infection diseases
- optic atrophy
- arterial hypertension
- ischaemic heart disease
- heart arrhythmia
- hypersensitive large intestine
- chronic pancreatitis



## 5.2 Contraindications for ultrasound therapy

- tumor and status after tumor resection
- gestation (abdomen and lower part of the spine area)
- tuberculosis
- haemorrhagic condition
- circulatory failure and arrhythmia
- severe general status of system and cachexy
- growth of bones
- neuralgias of inexplicable origin
- acute inflammatory process and fever
- diabetes
- thrombophlebitis
- patients with implanted electronic devices (e.g. cardiac pacemakers)
- peripheral circulation disorders
- neuropathies
- intervertebral disc prolapsed
- status after resection of neural arch
- in the case of implants and endoprostheses special precautions must be taken



## 5.3 Contraindications for electrotherapy

- patients with implanted electronic devices (e.g. cardiac pacemakers) – procedures on torso and thorax, especially dangerous frequencies 10 – 60 Hz
- patients with implanted implants (e.g. internal prostheses, bone screws) should consult a physician prior to treatment
- acute infections and inflammatory processes
- thrombophlebitis
- risk of an embolism
- diseases with the possibility of hemorrhages
- pregnancy (abdomen and lower part of the spine area)
- sensory disturbances
- pain of unknown etiology
- active tumor in the treatment area
- active tuberculosis
- diseases with pyrexia
- superficial metal implants – special attention required
- peripheral artery occlusive disease, II b- IV (Fontaine)
- cutaneous changes at electrode application places
- cases, when the skin cannot be moisten



## 5.4 Contraindications for combined therapy

As for the electrotherapy and ultrasound therapy.



## 5.5 Contraindications for laser therapy

- malignancy
- areas treated with radiotherapy
- active tuberculosis
- bleeding tendency
- feverish conditions
- diseases with elevated body temperature

- pregnancy (epigastric region)
- arrhythmia and circulatory insufficiency/circulatory failure
- hypersensitivity to light
- unstable diabetes
- implanted cardiac pacemaker (heart area)
- (generalized) bacterial diseases
- epilepsy
- fibrocystic breast changes
- endocrine hyperfunction
- infectious diseases
- severe conditions of obliterating arteritis
- chronic poisoning
- chronic nephritis
- high blood pressure and long-lasting hypertension

It is not recommended to carry out treatments in the patients with neurological disorders, synkineses, trembling and convulsions. It is not recommended to perform the irradiation of eye socket and eyeball area due to possibility of the eye damage.



## 5.6 Contraindications for magnetotherapy

- gestation
- neoplastic disease
- active tuberculosis
- juvenile diabetes
- thyrotoxicosis
- bleeding from alimentary system
- severe infections
- presence of electronic implants (e.g. cardiac pacemaker)

## 6. Accessories

### 6.1 Standard accessories

No.	Name	REF	Quantity
1.	PhysioGo 700I / 701I controller	A-UC-AST-PHG700I A-UC-AST-PHG701I	1
2.	Mains cable	-	1
3.	Patient's cable: a) Channel A b) Channel B	a) A-AE-AST-KPET2M_A or A-AE-AST-KPWPR2M_A b) A-AE-AST-KPET2M_B or A-AE-AST-KPWPR2M_B	2
4.	Electrodes 6x6 cm	A-AE-AST-EL6060R or A-AE-AST-EL6060RV2	4
5.	Electrodes 7,5x9 cm	A-AE-AST-EL7590R or A-AE-AST-EL7590RV2	2
6.	Viscose covers for 6x6 cm electrodes	A-AE-AST-PW8X8	8
7.	Viscose covers for 7,5x9 cm electrodes	A-AE-AST-PW10X10	4
8.	Elastic Velcro strap 100x10 cm or 100x9 cm	A-AE-SPM-PR100X10 or A-AE-AST-PR100X9CA	2
9.	Elastic Velcro strap 40x10 cm or 40x9 cm	A-AE-SPM-PR40X10 or A-AE-AST-PR40X9CA	2
10.	DOOR blocking plug	A-AL-AST-ZLDOOR	1
11.	Ultrasound therapy gel 500 g	-	1
12.	Spare fuses – time lag T1L250, 1 A, 250 V	-	2
13.	Touch screen pen	-	1
14.	LCD touch screen cloth	-	1
15.	Masking covers without cutout	-	2
16.	Masking covers with cutout	-	2
17.	User Manual and Technical description	-	1+1
18.	Laser warning label	-	1
19.	Laser information label	-	1
20.	Electrical safety test report	-	1

## 6.2 Optional accessories

Applicators and trolleys	
Name	REF
Ultrasound therapy head GSW-4/1 type	A-AS-AST-GS4WH
Ultrasound therapy head GSW-1/1 type	A-AS-AST-GS1WH
Ultrasound head holder	A-AS-AST-SMSPUCH
Scanning laser applicator type SKW2-450 with a stand	A-AL-AST-SK450V2WH
Scanning laser applicator type SKW2-400 with a stand	A-AL-AST-SK400V2WH
Cluster laser applicator – type CL1800WH	A-AL-AST-CL1800WH
Point laser probe – type 80RDV3	A-AL-AST-80RDV3
Point laser probe – type 400IRV3	A-AL-AST-400IRV3
Cluster applicator holder	A-AL-AST-CLHOLD
Laser probe holder	A-AL-UCH-LAS-C
Fiber optical applicators:	
a) Straight	a) A-AL-AST-ASP6MMV2
b) Angled	b) A-AL-AST-ASK6MMV2
c) Angled for laser acupuncture	c) A-AL-ASTASK6MML2V2
d) Fiber holder	d) A-AL-AST-GA6MMV2
Cluster laser applicator stand	A-AL-AST-CLSTH1
Magnetic field applicator CPE type:	
a) CPE1	a) A-AG-AST-CPE1WH
b) CPE2	b) A-AG-AST-CPE2WH
in single or dual configuration with covers	
Trolley:	
a) Versa	a) A-AM-AST-VSA
b) Versa X	b) A-AM-AST-VSX
<b>Other</b>	
<b>Name</b>	
Protective goggles	Sand bags 21x14 cm, 21 x 28 cm
Point electrodes 6, 10, 15, 20 mm	Magnet
Self-adhesive electrodes	Bag for the unit and accessories
Crocodile clips	Patient's stop switch
Phillips screwdriver	