

**BeneHeart D30/BeneHeart D20A**

**BeneHeart D20/BeneHeart D20C**

**Defibrillator/Monitor**

**Operator's Manual**





© Copyright 2023 Shenzhen Mindray Bio-Medical Electronics Co., Ltd. All rights reserved.

Release time: January 2023

Revision: 2.0

# Intellectual Property Statement

SHENZHEN MINDRAY BIO-MEDICAL ELECTRONICS CO., LTD. (hereinafter called Mindray) owns the intellectual property rights to this Mindray product and this manual. This manual may refer to information protected by copyrights or patents and does not convey any license under the patent rights of Mindray, nor the rights of others.

Mindray intends to maintain the contents of this manual as confidential information. Disclosure of the information in this manual in any manner whatsoever without the written permission of Mindray is strictly forbidden.

Release, amendment, reproduction, distribution, rental, adaption and translation of this manual in any manner whatsoever without the written permission of Mindray is strictly forbidden.

**mindray** and **BeneHeart** are the registered trademarks or trademarks owned by Mindray in China and other countries. All other trademarks that appear in this manual are used only for editorial purposes without the intention of improperly using them. They are the property of their respective owners.

## Responsibility on the Manufacturer Party

Contents of this manual are subject to changes without prior notice.

All information contained in this manual is believed to be correct. Mindray shall not be liable for errors contained herein nor for incidental or consequential damages in connection with the furnishing, performance, or use of this manual.

Mindray is responsible for the effects on safety, reliability and performance of this product, only if:

- all installation operations, expansions, changes, modifications and repairs of this product are conducted by Mindray authorized personnel;
- the electrical installation of the relevant room complies with the applicable national and local requirements;
- the product is used in accordance with the instructions for use.

---

---

### WARNING

---

- **This equipment must be operated by persons who have been trained in its operation. The operator should be trained in basic life support, advanced cardiac life support or other emergency medical response.**
  - **It is important for the hospital or organization that employs this equipment to carry out a reasonable service/maintenance plan. Neglect of this may result in machine breakdown or personal injury.**
- 
-

# Warranty

THIS WARRANTY IS EXCLUSIVE AND IS IN LIEU OF ALL OTHER WARRANTIES, EXPRESSED OR IMPLIED, INCLUDING WARRANTIES OF MERCHANTABILITY OR FITNESS FOR ANY PARTICULAR PURPOSE.

## Exemptions

Mindray's obligation or liability under this warranty does not include any transportation or other charges or liability for direct, indirect or consequential damages or delay resulting from the improper use or application of the product or the use of parts or accessories not approved by Mindray or repairs by people other than Mindray authorized personnel.

This warranty shall not extend to

- Malfunction or damage caused by improper use or man-made failure.
- Malfunction or damage caused by unstable or out-of-range power input.
- Malfunction or damage caused by force majeure such as fire and earthquake.
- Malfunction or damage caused by improper operation or repair by unqualified or unauthorized service people.
- Malfunction of the instrument or part whose serial number is not legible enough.
- Others not caused by instrument or part itself.

## Company Contact

Manufacturer:	Shenzhen Mindray Bio-Medical Electronics Co., Ltd.
Address	Mindray Building, Keji 12th Road South, High-tech Industrial Park, Nanshan, Shenzhen 518057, P.R.China
Website	<a href="http://www.mindray.com">www.mindray.com</a>
E-mail Address:	<a href="mailto:service@mindray.com">service@mindray.com</a>
Tel:	+86 755 81888998
Fax:	+86 755 26582680
EC-Representative:	Shanghai International Holding Corp. GmbH (Europe)
Address:	Eiffestraße 80, 20537 Hamburg, Germany
Tel:	0049-40-2513175
Fax:	0049-40-255726
Summary of Safety and Clinical Performance (SSCP):	<a href="https://www.mindray.com/etc.clientlibs/xpace/clientlibs/clientlib-site/resources/plugins/web/viewer.html?file=/content/dam/xpace/en/site/mdr-sscp/d6-cpr-sensor-mdr/KF-0656-4-0018-Summary-of-safety%20and-clinical-performance.pdf">https://www.mindray.com/etc.clientlibs/xpace/clientlibs/clientlib-site/resources/plugins/web/viewer.html?file=/content/dam/xpace/en/site/mdr-sscp/d6-cpr-sensor-mdr/KF-0656-4-0018-Summary-of-safety%20and-clinical-performance.pdf</a>

# Notification of Adverse Events

As a health care provider, you may report the occurrence of certain events to SHENZHEN MINDRAY BIO-MEDICAL ELECTRONICS CO., LTD., and possibly to the competent authority of the Member state in which the user and / or patient is established.

These events, include device-related death and serious injury or illness. In addition, as part of our Quality Assurance Program, SHENZHEN MINDRAY BIO-MEDICAL ELECTRONICS CO., LTD. requests to be notified of device failures or malfunctions. This information is required to ensure that SHENZHEN MINDRAY BIO-MEDICAL ELECTRONICS CO., LTD. provides only the highest quality products.

## Preface

### Manual Purpose

This manual contains the instructions necessary to operate the product safely and in accordance with its function and intended use. Observance of this manual is a prerequisite for proper product performance and correct operation and ensures patient and operator safety.

This manual is based on the maximum configuration and therefore some contents may not apply to your product. If you have any question, please contact us.

This manual is an integral part of the product. It should always be kept close to the equipment so that it can be obtained conveniently when needed.

### Intended Audience

This manual is geared for clinical professionals who are expected to have a working knowledge of medical procedures, practices and terminology as required for monitoring of critically ill patients.

### Illustrations

All illustrations in this manual serve as examples only. They may not necessarily reflect the setup or data displayed on the equipment.

### Conventions

- *Italic text* is used in this manual to quote the referenced manuals, chapters, sections and formulas.
- **Bold text** is used to indicate the screen texts and names of hard keys.
- → is used to indicate operational procedures.

# Contents

## **Part I: General Information**

<b>1 Safety</b> .....	<b>1 - 1</b>
1.1 Safety Information .....	1 - 1
1.1.1 Dangers .....	1 - 1
1.1.2 Warnings .....	1 - 2
1.1.3 Cautions .....	1 - 3
1.1.4 Notes .....	1 - 3
1.2 Equipment Symbols .....	1 - 3
<b>2 Equipment Overview</b> .....	<b>2 - 1</b>
2.1 Intended Use .....	2 - 1
2.1.1 Intended Purpose Statement .....	2 - 1
2.1.2 Indication for Use .....	2 - 1
2.1.3 Intended Users .....	2 - 1
2.1.4 Intended Patient Population .....	2 - 1
2.1.5 Intended Medical Conditions .....	2 - 1
2.1.6 Contra-indications .....	2 - 2
2.1.7 Side-effects .....	2 - 2
2.1.8 Clinical Benefit .....	2 - 2
2.2 Applied Parts .....	2 - 2
2.3 Operating Modes .....	2 - 3
2.4 Main Unit and Connectors .....	2 - 4
2.4.1 Front View .....	2 - 4
2.4.2 Left View .....	2 - 5
2.4.3 Right View .....	2 - 6
2.4.4 Rear View .....	2 - 6
<b>3 Equipment Preparation</b> .....	<b>3 - 1</b>
3.1 Equipment Preparation Introduction .....	3 - 1
3.2 Equipment Preparation Safety Information .....	3 - 1
3.3 Equipment Installation .....	3 - 1
3.3.1 Unpacking and Checking .....	3 - 2
3.3.2 Environmental Requirements .....	3 - 2
3.4 Connecting the Power Supply .....	3 - 2
3.4.1 Connecting the AC Power Supply .....	3 - 2
3.4.2 Connecting the DC Power Supply .....	3 - 2
3.4.3 Installing the Battery .....	3 - 3
3.5 Turning on the Equipment .....	3 - 3
3.6 Main Screen Display .....	3 - 3
3.6.1 On-screen Symbols .....	3 - 4
3.6.2 Menus .....	3 - 5
3.6.3 Quick Keys .....	3 - 6
3.7 General Operations .....	3 - 6
3.7.1 Using the Touchscreen .....	3 - 6

3.7.2 Using the Navigation Knob .....	3 - 7
3.7.3 Using the On-Screen Keyboard .....	3 - 7
3.8 Setting Up the Equipment .....	3 - 7
3.8.1 Setting the Date and Time .....	3 - 7
3.8.2 Adjusting the Screen Brightness .....	3 - 8
3.8.3 Adjusting the Volume .....	3 - 8
3.8.4 Setting the High Contrast Display .....	3 - 8
3.8.5 Software Licenses .....	3 - 8
3.9 Editing the Current Patient Information .....	3 - 9
3.10 Recording Voices .....	3 - 9
3.11 Taking Rescue Records .....	3 - 9
3.12 Turning Off the Equipment .....	3 - 10

## **Part II: Therapy Functions**

<b>4 Therapy Preparation .....</b>	<b>4 - 1</b>
4.1 Choosing the Therapy Accessories .....	4 - 1
4.2 Connecting the Therapy Cable .....	4 - 1
4.3 Connecting the Multifunction Electrode Pads .....	4 - 2
4.4 Connecting the External Paddles .....	4 - 2
4.4.1 Connecting the Adult External Paddles .....	4 - 3
4.4.2 Connecting the Pediatric External Paddles .....	4 - 3
4.4.3 Placing the External Paddles .....	4 - 4
4.5 Connecting the Internal Paddles .....	4 - 5
4.6 Connecting the CPR Sensor .....	4 - 5
4.7 Preparing the Patient for Electrode Application .....	4 - 6
4.8 Checking the Patient Contact Indicator .....	4 - 6
<b>5 AED .....</b>	<b>5 - 1</b>
5.1 AED Introduction .....	5 - 1
5.2 AED Safety Information .....	5 - 1
5.3 Accessing the AED Mode .....	5 - 2
5.4 AED Window Display .....	5 - 2
5.5 AED Procedure .....	5 - 3
5.6 Changing AED Settings .....	5 - 5
5.7 AED Voice Prompts .....	5 - 5
<b>6 Manual Defibrillation .....</b>	<b>6 - 1</b>
6.1 Manual Defibrillation Introduction .....	6 - 1
6.2 Manual Defibrillation Safety Information .....	6 - 1
6.3 Accessing the Manual Defib Mode .....	6 - 2
6.4 Manual Defib Window Display .....	6 - 2
6.5 External Defibrillation Procedure .....	6 - 3
6.5.1 Smart Analysis during External Defibrillation .....	6 - 3
6.5.2 Using the Electrode Pads for External Defibrillation .....	6 - 3
6.5.3 Using the External Paddles for External Defibrillation .....	6 - 5



6.6 Internal Defibrillation Procedure .....	6 - 6
6.7 Synchronized Cardioversion .....	6 - 7
6.7.1 Enabling Synchronized Cardioversion .....	6 - 8
6.7.2 Synchronized Cardioversion Procedure .....	6 - 8
6.7.3 Remote Synchronized Cardioversion .....	6 - 9
6.7.4 Delivering Additional Synchronized Shocks .....	6 - 9
6.7.5 Exiting Synchronized Cardioversion .....	6 - 10
6.8 Changing Manual Defibrillation Settings .....	6 - 10
<b>7 CPR Assistance .....</b>	<b>7 - 1</b>
7.1 CPR Assistance Introduction .....	7 - 1
7.2 CPR Assistance Safety Information .....	7 - 1
7.3 Accessing the CPR Status .....	7 - 1
7.4 Rhythm Analysis during CPR .....	7 - 1
7.5 CPR Metronome .....	7 - 2
7.6 CPR Filter .....	7 - 2
7.6.1 Displaying Filtered ECG Waveform .....	7 - 2
7.6.2 Viewing Filtered ECG Waveform .....	7 - 2
7.7 CPR Feedbacks .....	7 - 3
7.7.1 Displaying Compression Bar Graph and Numerics .....	7 - 4
7.7.2 Viewing Compression Bar Graph and Numerics .....	7 - 4
7.8 CPR Quality (CQI) Monitoring .....	7 - 5
7.8.1 CQI Monitoring Limitations .....	7 - 5
7.8.2 Displaying CQI Trends and Numerics .....	7 - 5
7.8.3 Viewing CQI Trends and Numerics .....	7 - 6
7.9 Viewing Rescue Debriefing .....	7 - 6
7.10 Uploading CPR Data .....	7 - 6
7.11 Changing CPR Settings .....	7 - 7
7.12 CPR Voice Prompts .....	7 - 7
<b>8 Noninvasive Pacing .....</b>	<b>8 - 1</b>
8.1 Pacing Introduction .....	8 - 1
8.2 Pacing Safety Information .....	8 - 1
8.3 Accessing the Pacer Mode .....	8 - 2
8.4 Pacer Window Display .....	8 - 2
8.5 Choosing the Pacer Mode Setting .....	8 - 2
8.5.1 Demand Mode Pacing Procedure .....	8 - 3
8.5.2 Fixed Mode Pacing Procedure .....	8 - 4
8.6 Changing Pacing Settings .....	8 - 4
 <b>Part III: Monitoring Functions</b>	
<b>9 Monitoring Preparation .....</b>	<b>9 - 1</b>
9.1 Starting Monitoring a Patient .....	9 - 1
9.2 Defining the Monitoring Display .....	9 - 1
9.2.1 Choosing the Screen .....	9 - 1
9.2.2 Setting the Switch for a Parameter .....	9 - 1

9.2.3 Defining the Normal Screen Display .....	9 - 2
9.2.4 Defining the Big Numerics Screen .....	9 - 2
9.2.5 Displaying the Parameter List .....	9 - 2
9.2.6 Changing Measurement Colors .....	9 - 2
9.3 Freezing Parameter Waveforms .....	9 - 2
9.3.1 Freezing Waveforms .....	9 - 2
9.3.2 Viewing Frozen Waveforms .....	9 - 2
9.3.3 Unfreezing Waveforms .....	9 - 3
9.3.4 Printing Frozen Waveforms .....	9 - 3
9.4 Stopping Monitoring a Parameter .....	9 - 3
<b>10 Alarms .....</b>	<b>10 - 1</b>
10.1 Alarm Introduction .....	10 - 1
10.1.1 Alarm Categories .....	10 - 1
10.1.2 Alarm Priorities .....	10 - 1
10.1.3 Alarm Indications .....	10 - 1
10.1.4 Alarm Status Symbols .....	10 - 2
10.2 Alarm Safety Information .....	10 - 2
10.3 Viewing the Alarms .....	10 - 3
10.4 Changing Alarm Settings .....	10 - 3
10.4.1 Initiating Auto Alarm Limits .....	10 - 3
10.4.2 Setting Parameter Alarm Properties .....	10 - 4
10.4.3 Restoring the Default Alarm Settings .....	10 - 5
10.4.4 Setting Alarm Tone Properties .....	10 - 5
10.4.5 Setting the Alarm Delay Time .....	10 - 5
10.4.6 Setting the Switch of SpO <sub>2</sub> Desat Alarm Off .....	10 - 6
10.4.7 Setting the Switch of Apnea Alarm Off .....	10 - 6
10.4.8 Setting the Length of Printed Waveforms .....	10 - 6
10.5 Pausing Alarms .....	10 - 6
10.5.1 Defining the Alarm Pause Function .....	10 - 6
10.5.2 Password Protected Alarm Pause Settings .....	10 - 7
10.6 Switching Off All Alarms .....	10 - 7
10.7 Pausing Alarm Sounds .....	10 - 7
10.7.1 Defining the Alarm Sound Pause Function .....	10 - 7
10.7.2 Password Protected Alarm Sound Pause Settings .....	10 - 7
10.8 Switching Off Alarm Sounds .....	10 - 8
10.9 Resetting Alarms .....	10 - 8
10.9.1 Resetting Physiological Alarms .....	10 - 8
10.9.2 Resetting Technical Alarms .....	10 - 8
10.10 Latching Alarms .....	10 - 9
10.11 Testing Alarms .....	10 - 9
10.12 Actions When an Alarm Occurs .....	10 - 9
<b>11 Monitoring ECG .....</b>	<b>11 - 1</b>
11.1 ECG Introduction .....	11 - 1
11.2 ECG Safety Information .....	11 - 1
11.3 ECG Display .....	11 - 1

11.4 Preparing for ECG Monitoring .....	11 - 2
11.4.1 Preparing the Patient for Electrode Application .....	11 - 2
11.4.2 Applying ECG Electrodes .....	11 - 2
11.4.3 Electrode Color Coding .....	11 - 3
11.4.4 ECG Electrode Placement .....	11 - 3
11.4.5 Choosing the ECG Lead Type .....	11 - 5
11.4.6 Checking Paced Status .....	11 - 5
11.4.7 Setting the Switch of Pacer Rejection .....	11 - 5
11.5 Changing ECG Settings .....	11 - 6
11.5.1 Setting the ECG Alarm Properties .....	11 - 6
11.5.2 Setting the Analysis Mode .....	11 - 6
11.5.3 Changing ECG Waveform Settings .....	11 - 6
11.5.4 Setting the Switch of Smart Lead .....	11 - 8
11.5.5 Adjusting the QRS Volume .....	11 - 8
11.6 Monitoring Arrhythmia .....	11 - 8
11.6.1 Arrhythmia Safety Information .....	11 - 8
11.6.2 Arrhythmia Events .....	11 - 8
11.6.3 Displaying Arrhythmia Information .....	11 - 10
11.6.4 Changing Arrhythmia Settings .....	11 - 10
11.6.5 Deactivated Arrhythmia Alarms .....	11 - 12
11.7 ST Segment Monitoring .....	11 - 14
11.7.1 ST Safety Information .....	11 - 14
11.7.2 Enabling ST Monitoring .....	11 - 14
11.7.3 Displaying ST Numerics .....	11 - 14
11.7.4 Displaying ST Segments .....	11 - 15
11.7.5 Entering the ST View Window .....	11 - 15
11.7.6 Saving the Current ST as Baseline .....	11 - 16
11.7.7 Entering the ST Graphic Window .....	11 - 16
11.7.8 Changing ST Settings .....	11 - 17
11.7.9 Setting Positions of ST Point, ISO Point and J Point .....	11 - 17
11.8 QT/QTc Interval Monitoring .....	11 - 18
11.8.1 QT/QTc Monitoring Limitations .....	11 - 18
11.8.2 Enabling QT/QTc Monitoring .....	11 - 19
11.8.3 Displaying QT/QTc Numerics .....	11 - 19
11.8.4 Entering the QT View Window .....	11 - 19
11.8.5 Saving the Current QTc as Baseline .....	11 - 20
11.8.6 Changing QT Settings .....	11 - 20
11.9 ECG Relearning .....	11 - 21
11.9.1 Initiating Auto ECG Relearning .....	11 - 21
11.9.2 Manually Initiating an ECG Relearning .....	11 - 21
11.10 Calibrating ECG .....	11 - 21
11.11 ECG Troubleshooting .....	11 - 21
<b>12 Resting 12-Lead ECG Analysis .....</b>	<b>12 - 1</b>
12.1 Resting 12-Lead ECG Analysis Introduction .....	12 - 1
12.2 Preparing for 12-Lead ECG Measurement .....	12 - 1
12.3 Entering the 12-Lead ECG Window .....	12 - 1
12.4 Capturing 12-Lead ECG .....	12 - 2

12.5 Changing 12-Lead ECG Settings .....	12 - 2
12.5.1 Checking the Patient Information .....	12 - 2
12.5.2 Setting the 12-Lead ECG Waveforms .....	12 - 2
12.5.3 Setting the 12-Lead ECG Report .....	12 - 3
12.6 Initiating 12-Lead ECG Measurement .....	12 - 4
12.6.1 Auto Measurement .....	12 - 4
12.6.2 Manual Measurement .....	12 - 5
12.6.3 Rhythm Measurement .....	12 - 5
12.6.4 Actions When Lead Off Occurs .....	12 - 5
12.7 12-Lead ECG Analysis Report .....	12 - 5
12.7.1 Viewing the 12-Lead ECG Analysis Report .....	12 - 6
12.7.2 Reviewing the 12-Lead ECG Analysis Report .....	12 - 6
12.7.3 Transmitting the 12-Lead ECG Analysis Report .....	12 - 6
12.7.4 Printing the 12-Lead ECG Analysis Report .....	12 - 6
12.7.5 Comparing 12-Lead ECG Analysis Reports .....	12 - 7
12.8 Exiting the 12-Lead ECG Window .....	12 - 7
<b>13 Monitoring Respiration (Resp) .....</b>	<b>13 - 1</b>
13.1 Resp Introduction .....	13 - 1
13.2 Resp Safety Information .....	13 - 1
13.3 Resp Display .....	13 - 1
13.4 Preparing for Resp Monitoring .....	13 - 2
13.4.1 Preparing the Patient for Electrode Application .....	13 - 2
13.4.2 Placing the Electrodes .....	13 - 2
13.5 Changing Resp Settings .....	13 - 3
13.5.1 Setting the Resp Alarm Properties .....	13 - 3
13.5.2 Setting the RR Source .....	13 - 3
13.5.3 Choosing the Respiration Lead .....	13 - 3
13.5.4 Setting the Resp Waveform Size .....	13 - 3
13.5.5 Setting the Resp Waveform Speed .....	13 - 3
13.5.6 Initiating Auto Detection for Resp Waveform Threshold .....	13 - 4
13.5.7 Manually Adjusting the Resp Waveform Threshold .....	13 - 4
13.6 Resp Troubleshooting .....	13 - 4
<b>14 Monitoring Pulse Oxygen Saturation (SpO<sub>2</sub>) .....</b>	<b>14 - 1</b>
14.1 SpO <sub>2</sub> Introduction .....	14 - 1
14.2 SpO <sub>2</sub> Safety Information .....	14 - 1
14.3 SpO <sub>2</sub> Measurement Limitations .....	14 - 2
14.4 SpO <sub>2</sub> Display .....	14 - 3
14.5 Preparing for SpO <sub>2</sub> Monitoring .....	14 - 4
14.6 Changing SpO <sub>2</sub> Settings .....	14 - 4
14.6.1 Changing the SpO <sub>2</sub> Alarm Properties .....	14 - 4
14.6.2 Monitoring SpO <sub>2</sub> and NIBP Simultaneously .....	14 - 4
14.6.3 Nellcor Sat-Seconds Alarm Management .....	14 - 4
14.6.4 Setting the SpO <sub>2</sub> Sat-Seconds (for Nellcor SpO <sub>2</sub> ) .....	14 - 5
14.6.5 Setting SpO <sub>2</sub> Sensitivity (for Masimo SpO <sub>2</sub> ) .....	14 - 5
14.6.6 Enabling FastSAT (for Masimo SpO <sub>2</sub> ) .....	14 - 6
14.6.7 Setting the Display of SIQ (for Masimo SpO <sub>2</sub> ) .....	14 - 6

14.6.8 Changing Averaging Time (for Masimo SpO <sub>2</sub> ) .....	14 - 6
14.6.9 Changing the Sensitivity (for Mindray SpO <sub>2</sub> ) .....	14 - 7
14.6.10 Setting the Display of PI .....	14 - 7
14.6.11 Changing the Pleth Waveform Speed .....	14 - 7
14.7 Changing PR Settings .....	14 - 7
14.7.1 Changing the PR Alarm Properties .....	14 - 7
14.7.2 Changing the QRS Volume .....	14 - 7
14.7.3 Setting the PR Source .....	14 - 8
14.7.4 Setting the Display of PR .....	14 - 8
14.8 SpO <sub>2</sub> Troubleshooting .....	14 - 8
14.9 Nellcor Information .....	14 - 9
14.10 Masimo Information .....	14 - 9
14.11 Masimo End-User License Agreement .....	14 - 9
<b>15 Monitoring Noninvasive Blood Pressure (NIBP) .....</b>	<b>15 - 1</b>
15.1 NIBP Introduction .....	15 - 1
15.2 NIBP Safety Information .....	15 - 1
15.3 NIBP Measurement Limitations .....	15 - 2
15.4 Measurement Modes .....	15 - 2
15.5 NIBP Display .....	15 - 2
15.6 Preparing for NIBP Measurements .....	15 - 3
15.6.1 Preparing the Patient for NIBP Measurements .....	15 - 3
15.6.2 Placing the NIBP Cuff .....	15 - 3
15.7 Starting and Stopping NIBP Measurements .....	15 - 4
15.8 Changing NIBP Settings .....	15 - 4
15.8.1 Setting the NIBP Alarm Properties .....	15 - 4
15.8.2 Setting the Initial Cuff Inflation Pressure .....	15 - 4
15.8.3 Setting the NIBP Interval .....	15 - 4
15.8.4 Selecting NIBP Start Mode .....	15 - 5
15.8.5 Setting the Switch of NIBP End Tone .....	15 - 5
15.8.6 Setting NIBP Sequence .....	15 - 5
15.8.7 Setting the NIBP Display Format .....	15 - 5
15.8.8 Setting the Display of NIBP Alarm Limits .....	15 - 5
15.8.9 Setting the Display of PR .....	15 - 5
15.8.10 Correcting the NIBP Measurements .....	15 - 5
15.9 Assisting Venous Puncture .....	15 - 6
15.10 NIBP Maintenance .....	15 - 6
15.11 NIBP Troubleshooting .....	15 - 6
<b>16 Monitoring Carbon Dioxide (CO<sub>2</sub>) .....</b>	<b>16 - 1</b>
16.1 CO <sub>2</sub> Introduction .....	16 - 1
16.2 CO <sub>2</sub> Safety Information .....	16 - 1
16.3 CO <sub>2</sub> Measurement Limitations .....	16 - 1
16.4 CO <sub>2</sub> Display .....	16 - 2
16.5 Measuring Sidestream CO <sub>2</sub> .....	16 - 2
16.5.1 Preparing to Sidestream CO <sub>2</sub> Measurement .....	16 - 2
16.5.2 Zeroing the Sidestream CO <sub>2</sub> Module .....	16 - 4

16.6 Changing CO <sub>2</sub> Settings .....	16 - 4
16.6.1 Changing the CO <sub>2</sub> Alarm Properties .....	16 - 4
16.6.2 Setting the CO <sub>2</sub> Waveforms .....	16 - 4
16.6.3 Setting the RR Source .....	16 - 4
16.6.4 Entering the Standby Mode .....	16 - 4
16.6.5 Setting the Time before Auto Standby .....	16 - 5
16.6.6 Setting Humidity Compensation .....	16 - 5
16.6.7 Setting the Gas Compensation .....	16 - 5
16.6.8 Changing Barometric Pressure .....	16 - 5
16.7 Performing the Leakage Test .....	16 - 6
16.8 CO <sub>2</sub> Calibration .....	16 - 6
16.9 CO <sub>2</sub> Troubleshooting .....	16 - 6

## **Part IV: System Functions and Others**

<b>17 Clinical Assistive Applications .....</b>	<b>17 - 1</b>
17.1 Rescue Training .....	17 - 1
17.2 Glasgow Coma Scale (GCS) .....	17 - 1
17.2.1 Entering the GCS Window .....	17 - 2
17.2.2 Setting the GCS Scoring Type .....	17 - 2
17.2.3 Performing GCS Scoring .....	17 - 2
17.2.4 Reviewing GCS Trends .....	17 - 3
17.3 Early Warning Score (EWS) .....	17 - 3
17.3.1 Entering the EWS Window .....	17 - 3
17.3.2 Performing EWS Scoring .....	17 - 4
17.3.3 Reviewing EWS Trends .....	17 - 4
17.4 HEART Score .....	17 - 4
17.4.1 Entering the HEART Score Window .....	17 - 4
17.4.2 Performing HEART Scoring .....	17 - 5
17.4.3 Reviewing HEART Score Trends .....	17 - 5
17.5 Traumatic Brain Injury (TBI) Assessment .....	17 - 5
17.5.1 Entering the TBI Assessment Window .....	17 - 6
17.5.2 Setting the TBI Trends Interval .....	17 - 6
17.5.3 Performing GCS Scoring .....	17 - 6
17.5.4 Viewing TBI Warnings .....	17 - 6
17.5.5 Reviewing TBI Events .....	17 - 7
17.5.6 Exiting the TBI Assessment Window .....	17 - 7
<b>18 Review .....</b>	<b>18 - 1</b>
18.1 Review Introduction .....	18 - 1
18.2 Entering the Review Window .....	18 - 1
18.3 Review Window Display .....	18 - 1
18.4 General Operations in the Review Window .....	18 - 2
18.4.1 Viewing Trend Data .....	18 - 2
18.4.2 Locating Events .....	18 - 2
18.5 Reviewing Tabular Trends .....	18 - 2
18.6 Reviewing Graphics Trends .....	18 - 3
18.7 Reviewing Events .....	18 - 3

18.7.1 Viewing the Event List .....	18 - 3
18.7.2 Viewing Event Details .....	18 - 4
18.7.3 Viewing Arrhythmia Analysis .....	18 - 4
18.8 Reviewing Full Disclosure .....	18 - 5
18.8.1 Selecting Compressed Waveforms .....	18 - 5
18.8.2 Viewing Details of Compressed Waveforms .....	18 - 5
18.9 Reviewing 12-Lead ECG Analysis .....	18 - 5
18.10 Printing Trend Data .....	18 - 6
<b>19 Printing .....</b>	<b>19 - 1</b>
19.1 Recorder .....	19 - 1
19.2 List of Reports .....	19 - 1
19.3 Loading Paper .....	19 - 2
19.4 Printing the Summary Report .....	19 - 2
19.5 Starting the Printing .....	19 - 3
19.5.1 Manually Starting the Printing .....	19 - 3
19.5.2 Automatically Starting the Printing .....	19 - 3
19.6 Stopping the Printing .....	19 - 3
19.6.1 Manually Stopping the Printing .....	19 - 3
19.6.2 Automatically Stopping the Printing .....	19 - 3
19.6.3 Clearing Printing Tasks .....	19 - 3
19.6.4 Checking Printing Related Flags .....	19 - 3
19.7 Setting Reports .....	19 - 4
19.7.1 Setting Realtime Reports .....	19 - 4
19.7.2 Enabling Auto Printing When an Alarm Occurs .....	19 - 4
19.8 Removing Paper Jam .....	19 - 4
<b>20 Discharged Patient Management .....</b>	<b>20 - 1</b>
20.1 Generating Patient Data .....	20 - 1
20.2 Accessing the Discharged Patient Mode .....	20 - 1
20.3 Deleting Discharged Patient Data .....	20 - 1
20.4 Searching Discharged Patient Information .....	20 - 1
20.5 Reviewing Discharged Patient Data .....	20 - 1
20.6 Exporting Patient Data .....	20 - 1
<b>21 Data Communication .....</b>	<b>21 - 1</b>
21.1 Data Communication Introduction .....	21 - 1
21.2 Data Communication Safety Information .....	21 - 1
21.3 Connecting the Wired Network .....	21 - 1
21.4 Connecting the Wireless Network .....	21 - 2
21.5 Connecting the CMS .....	21 - 2
21.6 Connecting the eGateway .....	21 - 2
21.7 Transmitting Data through HL7 Protocol .....	21 - 2
21.8 Transmitting Data through FTP Protocol .....	21 - 3
21.9 Connecting the NTP Server .....	21 - 3
21.10 Connecting the Rescue Debriefing Statistical System .....	21 - 3

<b>22 Configuration Management .....</b>	<b>22 - 1</b>
22.1 Configuration Management Introduction .....	22 - 1
22.2 Accessing the Configuration Mode .....	22 - 1
22.3 Modifying Configuration Management Password .....	22 - 1
22.4 Exporting Configurations .....	22 - 1
22.5 Importing Configurations .....	22 - 1
22.6 Printing Configurations .....	22 - 2
22.7 Changing Configurations .....	22 - 2
22.7.1 General Setup Menu .....	22 - 2
22.7.2 Therapy Setup Menu .....	22 - 3
22.7.3 Alarm Setup Menu .....	22 - 6
22.7.4 Parameter Setup Menu .....	22 - 8
22.7.5 12-Lead Setup Menu .....	22 - 19
22.7.6 TBI Warning Setup Menu .....	22 - 20
22.7.7 Record Setup Menu .....	22 - 20
22.7.8 Patient Management Setup Menu .....	22 - 21
22.7.9 Network Setup .....	22 - 22
22.7.10 Test Setup Menu .....	22 - 25
<b>23 Battery .....</b>	<b>23 - 1</b>
23.1 Battery Introduction .....	23 - 1
23.2 Battery Safety Information .....	23 - 1
23.3 Replacing the Battery .....	23 - 1
23.4 Battery Indications .....	23 - 2
23.4.1 Battery Indicator .....	23 - 2
23.4.2 Battery Symbols .....	23 - 2
23.4.3 Battery Power Indicator .....	23 - 3
23.4.4 No Battery Alarm .....	23 - 3
23.4.5 Low Battery Alarm .....	23 - 3
23.4.6 Battery Aged Alarm .....	23 - 3
23.4.7 Battery Error Alarm .....	23 - 3
23.5 Charging the Battery .....	23 - 3
23.6 Conditioning the Battery .....	23 - 3
23.7 Checking Battery Performance .....	23 - 4
23.8 Storing Batteries .....	23 - 4
23.9 Recycling Batteries .....	23 - 5
<b>24 Care and Cleaning .....</b>	<b>24 - 1</b>
24.1 Care and Cleaning Introduction .....	24 - 1
24.2 Care and Cleaning Safety Information .....	24 - 1
24.3 Cleaning and Disinfecting the Equipment .....	24 - 1
24.3.1 Cleaning the Main Unit .....	24 - 1
24.3.2 Cleaning the Thermal Print Head .....	24 - 2
24.3.3 Disinfecting the Equipment .....	24 - 2
24.4 Cleaning and Disinfecting the Accessories .....	24 - 4
24.4.1 Cleaning the Accessories .....	24 - 4
24.4.2 Disinfecting the Accessories .....	24 - 5



24.5 Sterilization .....	24 - 6
24.6 Impact of Improper Cleaning .....	24 - 6
<b>25 Maintenance .....</b>	<b>25 - 1</b>
25.1 Maintenance Introduction .....	25 - 1
25.2 Maintenance Safety Information .....	25 - 1
25.3 Checking Software Information .....	25 - 1
25.4 Routine Maintenance .....	25 - 2
25.4.1 Auto Test .....	25 - 2
25.4.2 User Test .....	25 - 3
25.4.3 Checking the Test Results .....	25 - 4
25.4.4 Transmitting the Test Reports .....	25 - 5
25.5 Function Checks .....	25 - 5
25.5.1 Recorder Check .....	25 - 5
25.5.2 ECG Cable Test .....	25 - 5
25.5.3 Manual Defibrillation Test .....	25 - 5
25.5.4 Pacing Test .....	25 - 7
25.6 Preventive Maintenance .....	25 - 7
25.6.1 User Maintenance Settings .....	25 - 7
25.6.2 Module Performance Tests .....	25 - 8
25.6.3 Electrical Safety Tests .....	25 - 8
<b>A Specifications .....</b>	<b>A - 1</b>
A.1 Safety Specifications .....	A - 1
A.1.1 Safety Classifications .....	A - 1
A.1.2 Environmental Specifications .....	A - 1
A.2 Power Supply Specifications .....	A - 2
A.2.1 External Power Supply Specifications .....	A - 2
A.2.2 Battery Specifications .....	A - 2
A.2.3 Charger Station Specifications .....	A - 3
A.3 Physical Specifications .....	A - 4
A.4 Hardware Specifications .....	A - 4
A.4.1 Display Screen .....	A - 4
A.4.2 Recorder .....	A - 4
A.4.3 LEDs .....	A - 4
A.4.4 Audio Indicators .....	A - 4
A.4.5 External Connectors .....	A - 4
A.4.6 Signal Outputs .....	A - 5
A.5 Data Storage .....	A - 5
A.6 Communication Specifications .....	A - 6
A.6.1 Wi-Fi Specifications (Wlink as Station) .....	A - 6
A.6.2 Cellular Specifications .....	A - 7
A.6.3 Bluetooth Specifications .....	A - 8
A.6.4 NFC Specifications .....	A - 8
A.7 Therapy Specifications .....	A - 8
A.7.1 Defibrillation Specifications .....	A - 8
A.7.2 CPR Compression Specifications .....	A - 10
A.7.3 Pacer Specifications .....	A - 10

A.8 Monitor Specifications .....	A - 11
A.8.1 ECG Specifications (from ECG Accessories) .....	A - 11
A.8.2 ECG Specifications (from Therapy Accessories) .....	A - 13
A.8.3 Resp Specifications .....	A - 14
A.8.4 SpO <sub>2</sub> Specifications .....	A - 15
A.8.5 PR Specifications .....	A - 16
A.8.6 NIBP Specifications .....	A - 17
A.8.7 CO <sub>2</sub> Specifications .....	A - 18
<b>B EMC and Radio Regulatory Compliance .....</b>	<b>B - 1</b>
B.1 EMC .....	B - 1
B.2 Radio Regulatory Compliance .....	B - 4
<b>C Mindray Shockable Rhythm Analysis Algorithm .....</b>	<b>C - 1</b>
C.1 Rhythm Recognition and Annotation Methodology .....	C - 1
C.1.1 Database for Evaluation of Mindray Algorithm Performance .....	C - 1
C.1.2 Rhythm Categories .....	C - 1
C.2 Mindray Shockable Rhythm Analysis Algorithm Performance .....	C - 2
<b>D Alarm Messages .....</b>	<b>D - 1</b>
D.1 Physiological Alarm Messages .....	D - 1
D.1.1 General Physiological Alarm Messages .....	D - 1
D.1.2 Arrhythmia Alarm Messages .....	D - 1
D.1.3 ST Physiological Alarm Messages .....	D - 1
D.1.4 Resp Physiological Alarm Messages .....	D - 2
D.1.5 SpO <sub>2</sub> Physiological Alarm Messages .....	D - 2
D.1.6 PR Physiological Alarm Messages .....	D - 2
D.1.7 NIBP Physiological Alarm Messages .....	D - 2
D.2 Technical Alarm Messages .....	D - 2
D.2.1 General Technical Alarm Messages .....	D - 3
D.2.2 ECG Technical Alarm Messages .....	D - 3
D.2.3 Resp Technical Alarm Messages .....	D - 3
D.2.4 SpO <sub>2</sub> Technical Alarm Messages .....	D - 4
D.2.5 NIBP Technical Alarm Messages .....	D - 4
D.2.6 CO <sub>2</sub> Technical Alarm Messages .....	D - 5
D.2.7 Pacing Technical Alarm Messages .....	D - 6
D.2.8 CPR Sensor Technical Alarm Messages .....	D - 7
D.2.9 Power Supply Technical Alarm Messages .....	D - 7
D.2.10 Recorder Technical Alarm Messages .....	D - 7
D.2.11 Networking Technical Alarm Messages .....	D - 8
D.2.12 Special Technical Alarm Messages .....	D - 8
D.2.13 Other System Technical Alarm Messages .....	D - 9
<b>E Defibrillator Shift Checklist .....</b>	<b>E - 1</b>
<b>F Accessories .....</b>	<b>F - 1</b>
F.1 ECG Accessories .....	F - 1
F.1.1 ECG Electrodes .....	F - 1
F.1.2 12-Pin Separable Trunk Cables .....	F - 2
F.1.3 12-Pin Integrative Trunk Cables .....	F - 2
F.1.4 3-lead ECG Leadwires .....	F - 2

F.1.5 5-lead ECG Leadwires .....	F - 3
F.1.6 12-lead ECG Leadwires .....	F - 3
F.2 SpO <sub>2</sub> Accessories .....	F - 3
F.2.1 Extension Cables .....	F - 4
F.2.2 Mindray SpO <sub>2</sub> Sensors .....	F - 4
F.2.3 Nellcor SpO <sub>2</sub> Sensors .....	F - 4
F.2.4 Masimo SpO <sub>2</sub> Sensors .....	F - 5
F.3 NIBP Accessories .....	F - 5
F.3.1 NIBP Hoses .....	F - 5
F.3.2 Cuffs .....	F - 5
F.4 CO <sub>2</sub> Accessories .....	F - 7
F.5 Therapy Accessories .....	F - 7
F.6 Other Accessories .....	F - 8
<b>G Electrical Safety Inspection .....</b>	<b>G - 1</b>
G.1 Power Cord Plug .....	G - 1
G.2 Device Enclosure and Accessories .....	G - 1
G.2.1 Visual Inspection .....	G - 1
G.2.2 Contextual Inspection .....	G - 1
G.3 Device Labeling .....	G - 2
G.4 Protective Earth Resistance .....	G - 2
G.5 Earth Leakage Test .....	G - 2
G.6 Patient Leakage Current .....	G - 2
G.7 Mains on Applied Part Leakage .....	G - 3
G.8 Patient Auxiliary Current .....	G - 3
<b>H Abbreviations .....</b>	<b>H - 1</b>
<b>I Declaration of Conformity .....</b>	<b>I - 1</b>

**This page intentionally left blank.**

## 1 Safety

---

---

### 1.1 Safety Information

---

---

#### **DANGER**

- Indicates an imminent hazard that, if not avoided, will result in death or serious injury.
- 
- 

#### **WARNING**

- Indicates a potential hazard or unsafe practice that, if not avoided, could result in death or serious injury.
- 
- 

#### **CAUTION**

- Indicates a potential hazard or unsafe practice that, if not avoided, could result in minor personal injury or product/property damage.
- 
- 

#### **NOTE**

- Provides application tips or other useful information to ensure that you get the most from your product.
- 
- 

### 1.1.1 Dangers

---

---

#### **DANGER**

- The equipment delivers up to 360 J of electrical energy. Unless properly used by following the prompts provided by the equipment, this electrical energy may cause serious injury or death. Do not attempt to operate this equipment unless thoroughly familiar with the operations and functions of all controls, indicators, connectors, and accessories.
  - To avoid explosion hazard, do not use the equipment in the presence of oxygen-rich atmospheres, flammable anesthetics, or other flammable agents (such as gasoline). Keep the equipment and the operating environment dry and clean.
  - Defibrillation current can cause operator or bystander severe injury or even death. Keep distance from the patient or metal devices connected to the patient during defibrillation.
- 
-

## 1.1.2 Warnings

---

---

### WARNING

---

- Only use parts and accessories specified in this manual. Follow the instructions for use and adhere to all warnings and cautions.
  - This equipment is used for single patient at a time.
  - The equipment is not intended to be used within the Magnetic Resonance (MR) environment.
  - Do not disassemble the equipment. It contains no operator serviceable components and dangerous high voltages may be present. Contact authorized service personnel for repair.
  - Before connecting the equipment to the external power supply, check that the voltage and frequency ratings are the same as those indicated on the equipment's label or in this manual.
  - Before each use, the operator must check the equipment condition to ensure that the equipment is ready for operation.
  - To avoid risk of electric shock, the equipment must only be connected to mains power with protective earth. If a protective earth conductor is not provided, operate it on battery power, if possible.
  - Do not use the multiple portable socket outlets (MPSO) or AC mains extension cords. Insure that the sum of the individual ground leakage currents does not exceed the allowable limits.
  - Before putting the system into operation, the operator must verify that the equipment, connecting cables and accessories are in correct working order and operating condition.
  - Do not exclusively rely on audible alarms for patient monitoring. Adjusting alarm volume to a low level or turning off alarm sound may result in patient hazards. Customize alarm settings according to patient situations and keep patients under close surveillance.
  - Physiological data and alarm messages provided by the equipment should not be used as the sole basis for diagnosis or therapy decisions. They must be used in conjunction with clinical signs and symptoms. Misinterpreting measured values or other parameters may result in patient hazards.
  - Do not place the equipment or accessories in any position that might cause it to fall on the patient.
  - Do not start or operate the equipment unless the setup was verified to be correct.
  - Place and secure cables and tubings carefully to prevent from stumbling, entanglement and patient strangulation.
  - The software equipment copyright is solely owned by Mindray. No organization or individual shall resort to modifying, copying, or exchanging it or to any other infringement on it in any form or by any means without due permission.
  - Disconnect the non defibrillation-proof devices from the patient during defibrillation.
  - Make sure the synchronous input system is applied to this equipment and the input signal is correct if necessary.
  - Do not defibrillate a patient who lies on the wet or metal ground.
  - Do not perform any functional check if the equipment is connected with a patient. Otherwise the patient might be shocked.
  - Always keep the patients under close surveillance when delivering the therapy. If there is a delay in delivering a shock, the rhythm that has been analyzed as shockable may be converted to a non-shockable rhythm, which may result in an incorrect shock delivery.
  - For the treatment of patients with implantable pacemakers, place electrode pads or paddles away from internal pacemaker generator if possible to help prevent damage to the pacemaker.
  - Do not touch device connectors, recorder print head, battery connector or other live equipment if in contact with the patient. Otherwise patient injury may result.
  - Do not touch the patient and live parts simultaneously.
  - If the accuracy of any value displayed on the equipment, CMS, or printed on a graph strip or report is questionable, determine the patient's vital signs by alternative means. Verify that all equipment is working correctly.
- 
-

### 1.1.3 Cautions

#### CAUTION









- Ensure that the equipment is supplied with continuous electric power during work. Sudden power failure may cause data loss.
- Magnetic and electrical fields are capable of interfering with the proper performance of the equipment. For this reason make sure that all external devices operated in the vicinity of the equipment comply with the relevant EMC requirements. Mobile phone, X-ray equipment or MRI devices are a possible source of interference as they may emit higher levels of electromagnetic radiation.
- Always install or carry the equipment properly to avoid damage caused by drop, impact, strong vibration or other mechanical force.
- Dry the equipment immediately in case of rain or water spray.
- Some settings are password protected and can only be changed by authorized personnel. Contact your department manager or biomedical engineering department for the passwords used at your facility.
- At the end of its service life, the equipment, as well as its accessories, must be disposed of in compliance with the guidelines regulating the disposal of such products. If you have any questions concerning disposal of the equipment, please contact us.
- Never charge and deliver shock frequently in non-clinical situations. Otherwise equipment damage could occur.
- Observance of this manual is a prerequisite for proper product performance and correct operation and ensures patient and operator safety.



























### 1.1.4 Notes

#### NOTE

- The equipment use a mains plug as isolation means to the mains power. Do not locate the equipment in a place difficult to operate the mains plug.
- In normal use, the operator is expected to be in front of the equipment.
- The software was developed in compliance with IEC62304.
- This manual includes information related to all features of the equipment. Some features may not be available on your equipment.
- Keep this manual in the vicinity of the equipment so that it can be obtained conveniently when needed.

## 1.2 Equipment Symbols

	Refer to instruction manual/booklet		General warning sign
	Dangerous voltage		Shock button
	Manufacturer		Date of manufacture
	Alternating current		Direct current

	Power indicator		Status indicator
	Battery indicator		Computer network
	DEFIBRILLATION-PROOF TYPE CF APPLIED PART		DEFIBRILLATION-PROOF TYPE BF APPLIED PART
	Equipotentiality	<b>IP55</b>	Dust-protected; Protected against water jets
	Unlocking		Stand-by
	USB connector		Stop USB
<b>MD</b>	Medical Device		Input/output
	Gas inlet		Gas outlet
	Stacking limit by number		Keep dry
	This way up		Fragile; handle with care
	Humidity limitations		Atmospheric pressure limitations
	Temperature limitations		Non-ionizing electromagnetic radiation
<b>SN</b>	Serial number		No pushing
	Plastic identification symbol		General symbol for recovery/recyclable
	Graphical record	<b>EC REP</b>	Authorised representative in the European Community
	<p>The product bears CE mark indicating its conformity with the provisions of the REGULATION (EU) 2017/745 on medical devices and fulfills the general safety and performance requirements of Annex I of this regulation.</p> <p>Note: The product complies with the Council Directive 2011/65/EU.</p>		





The following definition of the WEEE label applies to EU member states only.

This symbol indicates that this product should not be treated as household waste. By ensuring that this product is disposed of correctly, you will help prevent bringing potential negative consequences to the environment and human health. For more detailed information with regard to returning and recycling this product, please consult the distributor from whom you purchased it.

\* For system products, this label may be attached to the main unit only.

**This page intentionally left blank.**

# 2 Equipment Overview

---

## 2.1 Intended Use

### 2.1.1 Intended Purpose Statement

The equipment is intended for external defibrillation, internal defibrillation, synchronized cardioversion and semi-automated defibrillation (AED). It can also be used for non-invasive external pacing, CPR feedback as well as ECG, Resp, SpO<sub>2</sub>, PR, NIBP and CO<sub>2</sub> monitoring.

### 2.1.2 Indication for Use

- External Defibrillation/AED/Internal Defibrillation  
External defibrillation, AED and internal defibrillation modes are intended for patients with ventricular fibrillation, pulseless ventricular tachycardia and ventricular flutter.
- Synchronized Cardioversion  
Synchronized cardioversion is intended for the treatment of Atrial Fibrillation and Atrial Flutter.
- Non-invasive External Pacing  
Non-invasive external pacing is intended for the treatment of bradycardia and asystole.
- CPR Feedback  
CPR feedback is intended for patients with cardiac arrest.
- Monitoring  
Monitoring is intended for ECG resting analysis, as well as the monitoring of ECG, Resp, SpO<sub>2</sub>, PR, NIBP and CO<sub>2</sub> parameters.

### 2.1.3 Intended Users

The equipment must be operated by qualified medical personnel trained in the operation of the equipment and qualified by training in basic life support, advanced cardiac life support or defibrillation.

### 2.1.4 Intended Patient Population

- AED  
The AED mode is contraindicated in the treatment when the patient is showing any of the following:
  - ◆ Consciousness
  - ◆ Breathing
  - ◆ Detectable pulse or other signs of circulation
- Manual Defibrillation Mode  
Manual defibrillation is intended for the initial treatment of ventricular fibrillation and ventricular tachycardia in patients that are pulseless and unconscious. Synchronized cardioversion is intended for termination of atrial fibrillation.
- Noninvasive Pacing Mode  
Noninvasive pacing therapy is intended for patients with symptomatic bradycardia.
- Monitoring Mode  
All the parameters can be monitored on single adult, pediatric and neonatal patients.

### 2.1.5 Intended Medical Conditions

The equipment is for use in hospital and pre-hospital institutions.

## 2.1.6 Contra-indications

### ■ AED

The AED mode is contraindicated in the treatment when the patient is showing any of the following:

- ◆ Consciousness
- ◆ Breathing
- ◆ Detectable pulse or other signs of circulation

### ■ Manual Defibrillation

Manual defibrillation is contraindicated in the treatment when the patient is showing any of the following:

- ◆ Consciousness
- ◆ Breathing
- ◆ Detectable pulse or other signs of circulation

## 2.1.7 Side-effects

Through clinical data from literature and clinical data from post-market surveillance activity of declared Defibrillator/Monitors in question, there is no side-effects identified.

After search the literature of similar device, the results of SOTA evaluation shown that undesirable effects may include myocardial damage.

## 2.1.8 Clinical Benefit

### ■ AED/External Defibrillation/Synchronized Cardioversion/Internal Defibrillation/Non-invasive External Pacing

These functions can directly improve patient survival, relieve symptoms and improve patient quality of life.

### ■ CPR Feedback

CPR feedback could standardize the chest compression procedure based on the measurement range of compression depth and compression rate, and improve the CPR quality.

### ■ Monitoring

The monitoring of ECG, Resp, SpO<sub>2</sub>, NIBP and CO<sub>2</sub> parameters can well confirm patient's physiological parameters through an accurate measurement, which could find some disease in advance and benefit the patients' health.

## 2.2 Applied Parts

The applied parts of the equipment are:

- ECG electrodes and leadwires
- SpO<sub>2</sub> sensor
- NIBP cuff
- CO<sub>2</sub> sampling line/nasal sampling cannula and airway adapter
- Multifunction electrode pads
- External defibrillation paddles
- Internal defibrillation paddles
- CPR sensor

---

---

### WARNING

---

- **When the equipment is placed at a an ambient temperate above 55°C, the surface temperature of applied parts should be limit to below 58°C.**
- 
-

## 2.3 Operating Modes

The equipment provides various operating modes. The following table lists all modes and related information:

Function Type	Mode Name	Description	More Information
Clinical function, performed by the clinicians.	AED mode	This mode is used to perform the semi-automated external defibrillation.	See 5 <i>AED</i> .
	Manual Defib mode	This mode is used to perform asynchronous defibrillation and synchronized cardioversion.	See 6 <i>Manual Defibrillation</i> .
	Pacer mode	This mode is used to perform fixed and demand pacing therapy.	See 8 <i>Noninvasive Pacing</i> .
	Monitor mode	This mode is used to monitor multiple physiological parameters.	See 9 <i>Monitoring Preparation</i> to 16 <i>Monitoring Carbon Dioxide (CO<sub>2</sub>)</i> .
Non-clinical function *, performed by the clinicians and service personnel.	Discharged Patient mode	This mode is used to manage discharged patients.	See 20 <i>Discharged Patient Management</i> .
	Configuration Management mode	This mode is used to change the equipment configurations.	See 22 <i>Configuration Management</i> .
	Test mode	This mode is used to perform user tests.	See 25.4.2 <i>User Test</i> .
	Maintenance mode	This mode is used for the preventive maintenance of the equipment.	See 25.6.1 <i>User Maintenance Settings</i> .
	Training mode	This mode is used for rescue training and standalone learning.	See 17.1 <i>Rescue Training</i> .
*After performing operations related to the non-clinical functions and exiting the corresponding mode, the equipment automatically restarts.			

## 2.4 Main Unit and Connectors

Different configurations can be configured for this equipment. In the following sections, the equipment configured without the paddle tray is taken as an example to describe front, left and right views. Equipments with different configurations are used to describe back view.

### 2.4.1 Front View

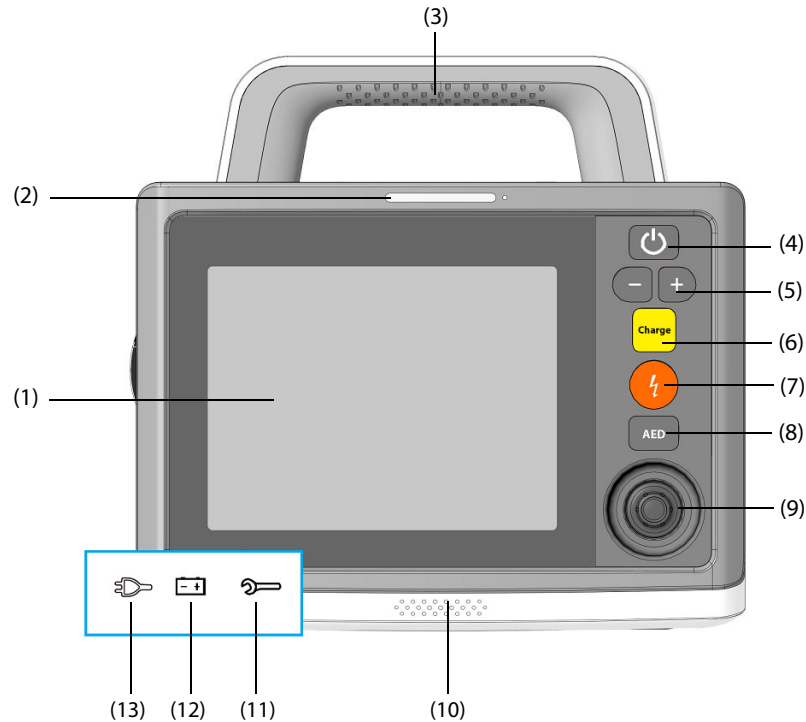

- (1) Display screen
- (2) Alarm lamp: flashes in different color and frequency to match the alarm level.
- (3) Handle
- (4) Power switch
  - ◆ When powered on, press it to turn on the equipment.
  - ◆ When turned on, press and hold it for 3 seconds to turn off the equipment.
- (5) Energy Selection buttons
  - ◆ When turned on, press it to enter the Manual Defib mode.
  - ◆ In the Manual Defib mode, press it to select the desired energy level.
- (6) Charge button
  - ◆ When turned on, press it to enter the Manual Defib mode.
  - ◆ In the Manual Defib mode, press it to charge the equipment to the desired energy level.
- (7) Shock button
  - ◆ When turned on, press it to enter the Manual Defib mode.
  - ◆ In the AED or Manual Defib mode, press it to deliver a shock to the patient. It flashes when the equipment is charged and ready.
- (8) AED button: accesses the AED mode when the equipment is turned on.
- (9) Navigation knob: provides the screen-related operations.
- (10) Speaker
- (11) Status indicator

- Steady green:
    - ◆ external power supply is connected, and the equipment operates properly.
    - ◆ only battery is connected for power supply, the equipment is turned on and operates properly.
  - Flashing green:
    - ◆ only battery is connected for power supply, the equipment is turned off and operates properly.
  - Flashing red
    - ◆ auto test fails, or a failure is detected on the equipment.
    - ◆ DC power supply connected is overcurrent or overvoltage.
    - ◆ only battery is connected for power supply, and the battery has a low power or battery fails.
    - ◆ only external power supply is connected for power supply, and **No Battery** is set to **Status Indicator On**.
  - Off: external power supply and battery are not connected.
- (12) Battery indicator
- ◆ Yellow: the battery is being charged.
  - ◆ Green: the battery is fully charged or the equipment operates on battery power.
  - ◆ Off: battery is not installed or battery fails.
- (13) Power indicator
- ◆ Illuminated: the external power supply is connected.
  - ◆ Off: the external power supply is not connected.

## 2.4.2 Left View

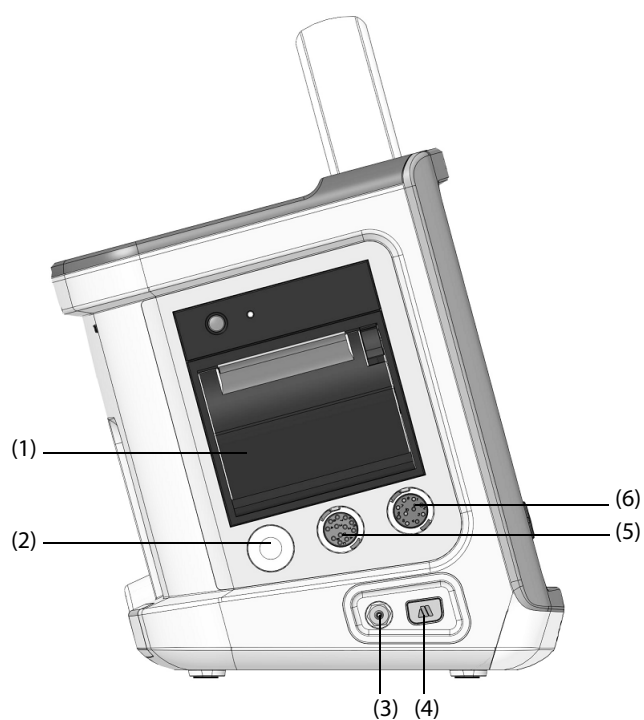

- |                         |                                       |
|-------------------------|---------------------------------------|
| (1) Recorder            | (2) NIBP cuff connector               |
| (3) Gas outlet          | (4) CO <sub>2</sub> connector         |
| (5) ECG cable connector | (6) SpO <sub>2</sub> sensor connector |

### 2.4.3 Right View

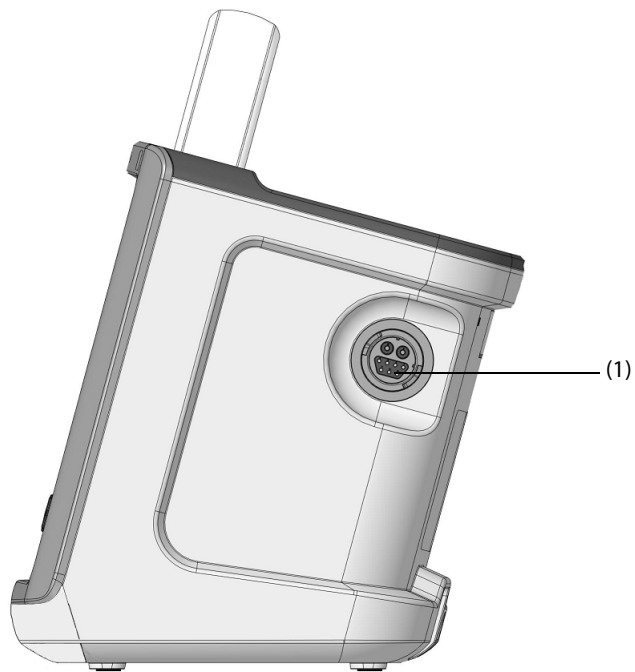

- (1) Therapy port: connects the therapy cable.

### 2.4.4 Rear View

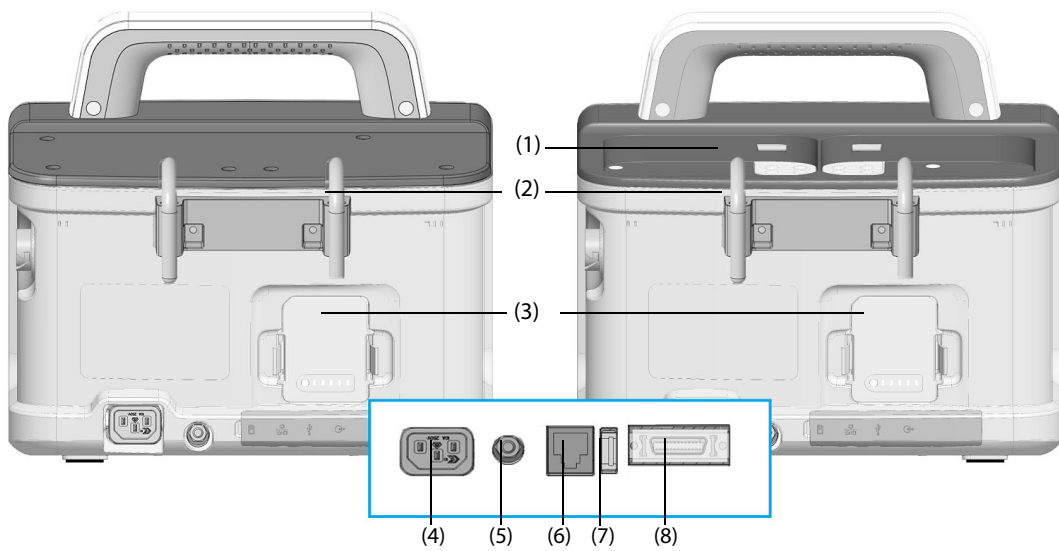

Equipment without the paddle tray

Equipment with the paddle tray



- (1) Paddle tray: places external paddles.
- (2) Hook: holds the cables.
- (3) Battery
- (4) Power input: connects an external power supply.
- (5) Equipotential grounding terminal:  
When the equipment and other devices are to be used together, their equipotential grounding terminals should be connected together to eliminate the potential difference between them.
- (6) Network connector: is a standard RJ45 connector.
- (7) USB connector: connects the USB drive.
- (8) Multifunctional connector: connects a CPR sensor, or a cable for analog output or synchronized cardioversion.

**This page intentionally left blank.**

# 3 Equipment Preparation

---

## 3.1 Equipment Preparation Introduction

Before putting the equipment in use, you should be thoroughly familiar with operations, and get your equipment well prepared and configured.

## 3.2 Equipment Preparation Safety Information

---

### WARNING

---

- Use only installation accessories specified by Mindray.
  - Connect only approved devices to this equipment. Devices connected to the equipment must meet the requirements of the applicable IEC standards (e.g. IEC 60950 safety standards for information technology equipment and IEC 60601-1 safety standards for medical electrical equipment). The system configuration must meet the requirements of the IEC 60601-1 medical electrical systems standard. Any personnel who connect devices to the equipment's signal input/output port are responsible for providing evidence that the safety certification of the devices has been performed in accordance to the IEC 60601-1. If you have any questions, please contact Mindray.
  - The equipment and accessories connected to the equipment are suitable for use within the patient environment. For other devices and accessories connected to the equipment, consult corresponding manufacturers for the suitability within the patient environment.
  - If it is not evident from the equipment specifications whether a particular combination with other devices is hazardous, for example, due to summation of leakage currents, please consult the manufacturer or an expert in the field. A determination must be made that the proposed combination will not negatively affect the devices themselves or the patient's safety.
- 

### CAUTION

---

- The equipment should be installed by authorized Mindray personnel.
  - When disposing of the packaging material, be sure to observe the applicable waste control regulations and keep it out of children's reach.
  - Before use, verify whether the packages are intact, especially the packages of single use accessories. In case of any damage, do not apply it to patients.
  - Make sure that the equipment operating environment meets the specific requirements. Otherwise unexpected consequences, e.g. damage to the equipment, could result.
- 

### NOTE

---

- Put the equipment in a location where you can easily view and operate the equipment.
  - Save the packing case and packaging material as they can be used if the equipment must be reshipped.
- 

## 3.3 Equipment Installation

The equipment can be installed in various ways as required.

- Placed on the table
- Installed on the rescue stretchers by hooks
- Installed on the ambulance by a simple mounting

### 3.3.1 Unpacking and Checking

Before unpacking, examine the packing case carefully for signs of damage. If any damage is detected, contact the carrier or us.

If the packing case is intact, open the package and remove the equipment and accessories carefully. Check all materials against the packing list and check for any mechanical damage. Contact us in case of any problem.

### 3.3.2 Environmental Requirements

The operating environment of the equipment must meet the requirements specified in this manual.

The environment where the equipment is used shall be reasonably free from noises, vibration, dust, corrosive, flammable and explosive substances. If the equipment is installed in a cabinet, sufficient space in front and behind shall be left for convenient operation, maintenance and repair. Moreover, to maintain good ventilation, the equipment shall be at least 2 inches (5cm) away from around the cabinet.

When the equipment is moved from one place to another, condensation may occur as a result of temperature or humidity difference. In this case, never start the system before the condensation disappears.

## 3.4 Connecting the Power Supply

The equipment provides various types of power supply.

---

---

### WARNING

---

- **Always use the accompanying power cord delivered with the equipment.**
  - **Before connecting the equipment to the power supply, check that the voltage and frequency ratings are the same as those indicated beside the power input of the equipment.**
  - **Use the battery if the integrity of the protective earth conductor or the protective earthing system in the installation is in doubt.**
- 
- 

### 3.4.1 Connecting the AC Power Supply

The equipment can operate on the AC power supply.

To connect the equipment to the AC power supply, follow this procedure:

1. Connect one end of the power cord to the AC power input of the equipment.
2. Connect the other end of the power cord with a AC power outlet. Check that the power indicator is illuminated.

### 3.4.2 Connecting the DC Power Supply

When connected to a DC/AC inverter, the equipment can operate on the DC power supply.

To connect the equipment to the DC power supply, follow this procedure:

1. Connect one end of the DC/AC inverter to the AC power input of the equipment.
2. Connect the other end of the DC/AC inverter to the DC power outlet. Check that the power indicator is illuminated.

If the DC power supply connected is overcurrent or overvoltage, the equipment provides the status indicator flashing in red and periodically gives a beep.

---

---

### CAUTION

---

- **Use only the specified DC/AC inverter.**
  - **When connected with the transport dock, it is specified as a part of the equipment. Use only the specified DC/AC inverter.**
-

### 3.4.3 Installing the Battery

The equipment can operate on the battery power when an external power supply is not available. For details on installing the battery, see 23.3 Replacing the Battery.

## 3.5 Turning on the Equipment

Before turning on the equipment, perform the following inspections:

1. Check the equipment for any mechanical damage. Make sure that all external cables, plug-ins and accessories are properly connected.
2. Connect the equipment to the external power supply. Make sure the battery power is sufficient if the equipment is powered by the battery.

Press the power switch to turn on the equipment. After the start-up screen is displayed, the equipment gives a beep, and meanwhile, the alarm lamp illuminates in red, and then turns yellow, and finally turns off.

If the AED mode or Manual Defib mode is the default startup mode, the alarm system is off when the alarm lamp turns off. If the Monitor mode is the default startup mode, the alarm system is activated when the alarm lamp turns off. The setting of **Default Startup Mode** can be changed in the Configuration mode only. For more information, see 22.7.1 General Setup Menu.

### CAUTION

- Do not use the equipment on a patient if you suspect it is not working properly, or if it is mechanically damaged. Contact the service personnel or Mindray.
- Check that visual and auditory alarm signals are presented correctly when the equipment is turned on.

## 3.6 Main Screen Display



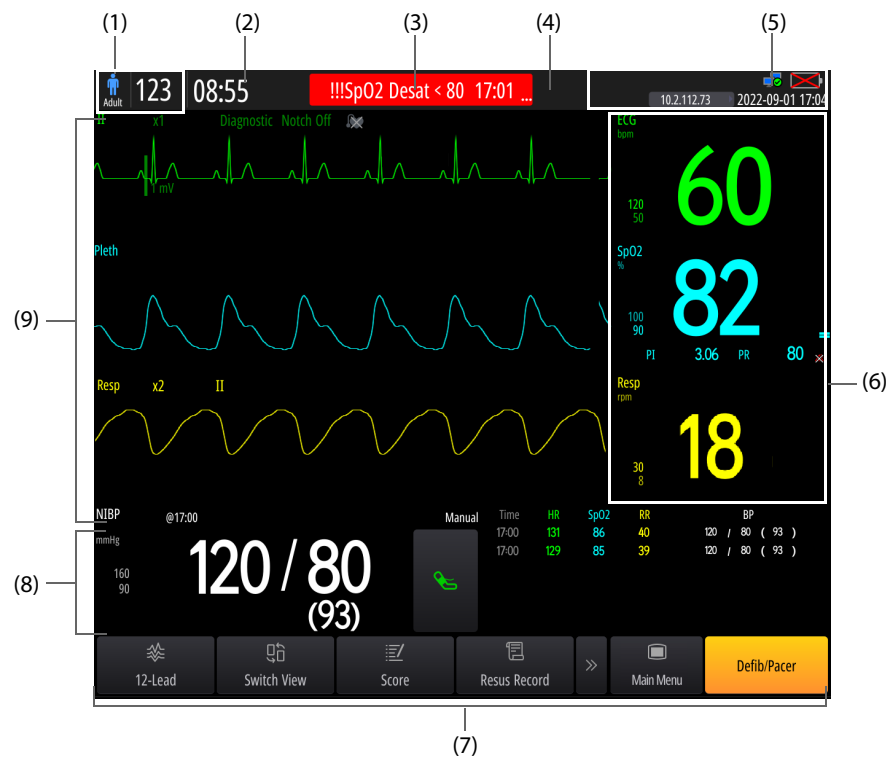













The following figure shows the main screen display.



- (1) Patient information area: displays patient name/bed number (configurable) and patient category. The display of **Patient Name** and **Bed No.** can be configured in the Configuration mode only. For more information, see 22.7.8 *Patient Management Setup Menu*.
- (2) Runtime area: displays the operating time since equipment is turned on.
- (3) Alarm information area: displays the physiological alarms, technical alarm messages and prompt messages.
- (4) Alarm status area: displays the alarm status symbol. For more information, see 10.1.4 *Alarm Status Symbols*.
- (5) System information area: displays the network status, battery status, voice recording symbol, IP address of the connected CMS and system time. For more information, see 3.6.1 *On-screen Symbols*.
- (6) Parameter numerics area: displays parameter values, units, alarm limits, and alarm status. This area also displays the parameter list. Selecting a parameter numeric area enters corresponding parameter menu. Selecting the parameter list enters the **Tabular Trends** review page.
- (7) Quick key area: provides a quick access to general operations. The locations of **Main Menu** and **Defib/Pacer** quick keys are unchangeable.
- (8) Parameter waveform area/Parameter numerics area:
  - ◆ Parameter waveform area: displays parameter waveforms and parameter alarms. Select a waveform enters the corresponding parameter menu.
  - ◆ Parameter numerics area: displays parameter values, units, alarm limits, and alarm status. This area also displays the parameter list. Selecting a parameter numeric area enters corresponding parameter menu. Selecting the parameter list enters the **Tabular Trends** review page.
- (9) Parameter waveform area: displays parameter waveforms and parameter alarms. Select a waveform enters the corresponding parameter menu.

### 3.6.1 On-screen Symbols

The following table lists the on-screen symbols displayed in the system information area:

Symbol	Description	Symbol	Description
	Adult, male (with a blue background)		Adult, unspecified gender (with a white background)
	Pediatric, male (with a blue background)		Pediatric, unspecified gender (with a white background)
	Neonate, male (with a blue background)		Neonate, unspecified gender (with a white background)
	Adult, female (with a pink background)		Pediatric, female (with a pink background)
	Neonate, female (with a pink background)		The alarm system is reset.
	All the alarms are paused.		Audible alarm tones are paused.
	Individual physiological alarms are turned off or the equipment is in the alarm off status.		Audible alarm tones are turned off
	The battery works correctly. The green portion represents the remaining charge.		The battery is being charged.

Symbol	Description	Symbol	Description
	The battery has low power and needs to be charged.		The battery has critically low charge and needs to be charged immediately. Otherwise, the equipment will soon automatically shut down.
	No battery is installed.		The voice recording function is enabled.
	The touchscreen is locked.		The locked touchscreen is removed.
	Wired network is connected.		Wired network is not connected.
	Wireless network is connected. The solid part indicates network signal strength.		Wireless network is not connected.
	4G cellular network is connected. The solid part indicates network signal strength.		4G cellular network is not connected.
	5G cellular network is connected. The solid part indicates network signal strength.		5G cellular network is not connected.

### 3.6.2 Menus

All menus of the equipment have similar style and structure. The following figure shows the ECG setup menu:











- (1) Menu heading: summarizes functions of the current menu.
- (2) Submenu tabs: provides a access to a submenu.
- (3) Operation key: performs the corresponding operation.
- (4) Exit key: closes the current menu.
- (5) Main body area: displays the current menu items and options.
- (6) Switch:
  - ◆ Green: the item is switched on.
  - ◆ Gray: the item is switched off.

### 3.6.3 Quick Keys

Quick keys are located at the bottom of the screen. The quick key on the main screen provides a quick access to general operations for the equipment. The quick key below a window provides a quick access to relevant functions.

The following table lists all available quick keys of the main screen.

Symbol	Label	Description	Symbol	Label	Description
	Main Menu	Opens the main menu.	/	Defib/Pacer	Opens the <b>Manual Defib</b> window.
	12-Lead	Opens the 12-lead ECG window.		Switch View	Switches the display of the main screen.
	Score	Opens the Scoring window.		Resus Record	Opens the <b>Resus Record</b> window.
	TBI	Opens the TBI Assessment window.		Freeze	Freezes waveforms.
	/	Displays more quick keys.			

## 3.7 General Operations

Everything you need to operate the equipment is on the display screen. Screen elements include parameter numerics area, parameter waveform areas, quick keys, system information area, alarm information area and menus.

### 3.7.1 Using the Touchscreen

#### 3.7.1.1 Gestures for Quick Operation

You can use the following gestures to take a quick operation.

- Tapping the screen
  - ◆ To select an item from menus or lists, tap on the item with your finger.
  - ◆ To select a quick key, tap on the key with your finger.
  - ◆ To enter a parameter menu, tap corresponding parameter numeric area or waveform area.
- Swiping across the screen with a single finger:
  - ◆ To scroll through a list and a menu, swipe up and down.
- Swiping across the screen with two fingers:
  - ◆ To switch between the screens, swipe left or right across the screen.

#### 3.7.1.2 Locking the Touchscreen

To avoid misuse, you can temporarily disable the touchscreen. To do so, choose either of the following ways:

- No operation is taken within 5 minutes. The setting of **Screen Lock Duration** can be changed in the Configuration mode only. For more information, see 22.7.1 *General Setup Menu*.
- Select the **Main Menu** quick key → from the **Common** column select **Screen Lock**.
- Press and hold the **Main Menu** quick key to display , swipe the slider up as instructed.



 on the **Main Menu** quick key indicates that the touchscreen is disabled.

To unlock the touchscreen, select anywhere on the screen to display  and swipe the slider up as instructed.

---

## CAUTION

---

- **Check that the touchscreen is not damaged or broken. If there is any sign of damage, stop using the equipment and contact the service personnel.**
  - **If the touchscreen is loose, stop using the equipment and contact the service personnel.**
- 







### 3.7.2 Using the Navigation Knob

To avoid touchscreen failure in delaying the patient rescue, a navigation knob is also provided for operating the equipment. You can use the navigation knob to complete the following operations:

- Displaying a submenu
  - ◆ Rotate the Navigation knob to move the cursor on the desired item of the main menu, and then press the Navigation knob.
- Inputting information
  1. Rotate the Navigation knob to move the cursor on the desired textbox of a menu, and then press the Navigation knob.
  2. Rotate the Navigation knob to move the cursor on the desired character to be inputted, and then press the Navigation knob.
- Changing settings: changing the patient category is taken as an example below.
  1. Rotate the Navigation knob to move the cursor on the patient category symbol in the patient information area, and then press the Navigation knob.
  2. Rotate the Navigation knob to move the cursor on **Patient Category**, and then press the Navigation knob.
  3. Rotate the Navigation knob until you find the desired item, and then press the Navigation knob to confirm the selection.

### 3.7.3 Using the On-Screen Keyboard

The on-screen keyboard is also provided for inputting the information:

- Select one character after another for the entry.
- Select  to show or  to hide the password entry.
- Select  to delete the previous character or select  to clear the entire entry.
- Select  to switch between uppercase and letters.
- Select  to confirm the entry and close the on-screen keyboard.

## 3.8 Setting Up the Equipment

### 3.8.1 Setting the Date and Time

Before putting the equipment into use for the first time, you should set the time zone and system time in accordance with your local time.

To set the system date and time, follow this procedure:

1. Access **System Time** in either of the following ways:
  - ◆ Select the **Main Menu** quick key → from the **System** column select **Time**.
  - ◆ Select the system information area of the main screen.
2. Set the system date.
  - ◆ **Date Format:** sets the system date format.
  - ◆ **Date:** sets the system date.

3. Set the system time.
  - ◆ **24-Hour Time** switch: if the 12-hour mode is needed, switch it off.
  - ◆ **Time**: sets the system time.
4. Set the **Daylight Savings Time** switch. If the daylight savings time is needed, switch it on.

You can also set the system date and time in the Configuration mode. For more information, see 22.7.1 *General Setup Menu*.

If your equipment is connected to a central monitoring system (CMS) or NTP server, the date and time are automatically taken from the CMS or NTP server. In this case, you cannot change the date and time from your equipment. For more information about the connection, see 21.5 *Connecting the CMS* and 21.9 *Connecting the NTP Server*.

If the system time is changed in the Configuration mode, the equipment will restart. If the system time is changed in other cases, the equipment will generate a operation-related event to remind you. For more information, see 18.7 *Reviewing Events*.

---

## CAUTION

---

- **Changing the date and time affects the storage of trends and events and may result in loss of data.**
- 

### 3.8.2 Adjusting the Screen Brightness

To adjust the screen brightness, follow this procedure:

1. Access **Display** in either of the following ways:
  - ◆ Select the **Main Menu** quick key → from the **Display** column select **Screen Setup** → select the **Display** tab.
  - ◆ Select the **Main Menu** quick key → from the **Display** column select **Brightness**.
2. Set the screen brightness.

---

## NOTE

---

- **If Brightness is set to Auto, the screen brightness automatically changes according to the ambient light level.**
- 

### 3.8.3 Adjusting the Volume

To adjust the system volume, follow this procedure:

1. Select the **Main Menu** quick key → from the **Common** column select the **Volume** tab.
2. Respectively set **Alarm Volume**, **QRS Volume** and **Key Volume**.

### 3.8.4 Setting the High Contrast Display

The equipment provides the high contrast for a better view in a high light ambient.

To enable the high contrast display, select the **Main Menu** quick key and select **High Contrast** from the **Common** column.

To disable the high contrast display, select the **Main Menu** quick key and select **Full Color** from the **Common** column.

The high contract display remains when you change the operating mode. However, the setting of the high contrast display will not be saved after the equipment is turned off.

### 3.8.5 Software Licenses

A software license is required for running the following functions:

- Noninvasive Pacing
- CPR Quality Index (CQI)

- Glasgow Coma Scale (GCS)
- Early Warning Score (EWS)
- HEART Score (HEART)
- Traumatic Brain Injury (TBI) Assessment
- Numeric Data HL7 Output
- Waveform HL7 Output
- Rescue Training

To install the licenses, contact the service personnel.

## 3.9 Editing the Current Patient Information

The current patient name/bed number (configurable) and patient category are displayed in the patient information area of the main screen.

To edit the current patient information, follow this procedure:

1. Select the patient information to enter the **Patient Demographics** window.
2. Edit patient information if needed.

If the equipment is connected to the CMS, the current patient name, bed number, patient ID, department, height, weight, admit date or physician information can also be changed on the CMS.

## 3.10 Recording Voices

The equipment provides the voice recording function during all the procedures of the patient therapy and monitoring. The voice recording function is disabled by default. The switch setting of **Voice Recording** can be changed in the Configuration mode only. For more information, see *22.7.1 General Setup Menu*.

 indicates that the voice recording function is enabled. It is displayed in the system information area of the main screen.

## 3.11 Taking Rescue Records

The equipment automatically records the startup time, defibrillation event, and pacing operations after it is turned on. For further analysis and treatment, you can also manually take records for medications and measures that affect the patient's condition.

In the Monitor mode, you can manually take records for vital signs, medicines and measures. To do so, follow this procedure:

1. Select the **Resus Record** quick key.
2. Select the name for medicine used or measure taken, for example **Bandaged**.
3. Select **Vital Sign Record** to record the current waveforms and parameter values.
4. Select **Save**.

In the AED mode and Manual Defib mode, you can manually take records for medicines and measures only. Selecting the quick key below corresponding therapy window can take records. The display of these quick keys can be defined in the Configuration mode only. For more information, see *22.7.2.5 Quick Keys Setup Tab*.

Selecting **Review** enters the Event review page. For more information, see *18.7 Reviewing Events*.

Selecting **Record** starts printing the rescue record report. For more information, see *19 Printing*.

### NOTE

- **In the Pacer mode, the equipment automatically takes records for the pacing related operation. These operations cannot be manually recorded.**

## 3.12 Turning Off the Equipment

Before turning off the equipment, perform the following checks:

1. Ensure that the patient treatment and monitoring have been completed.
2. Disconnect all the cables and sensors from the patient.
3. If needed, save or clear the patient data.

To turn off the equipment, press and hold the power switch for 3 seconds.

Turning off the equipment does not disconnect the equipment from the power supply. To completely disconnect the power supply, unplug the power cord.

---

### CAUTION

- **Press and hold the power switch for 10s to forcibly shut down the equipment if it could not be shut down normally. This may cause loss of patient data.**

---

### NOTE

- **To prevent the changes from losing in case of sudden power failure, the equipment saves the settings in real time. In case of a temporary power failure, if the power is restored within 60s, the equipment will resume with all active settings unchanged; if the power is interrupted for more than 120s, the equipment behaves the same as it is normally turned off; if the power is restored within 60s to 120s, the equipment will resume with all active settings unchanged, or behaves the same as it is normally turned off.**
-

## 4 Therapy Preparation

### 4.1 Choosing the Therapy Accessories

Before the therapy, you should choose proper accessories according to the patient condition.

The following table lists available accessories for each operating mode:

Operating Mode	Function	Available Accessories
AED	AED	Multifunction electrode pads
	CPR assistance	<ul style="list-style-type: none"><li>• Multifunction electrode pads</li><li>• CPR sensor</li></ul>
Manual Defib	Manual defibrillation	<ul style="list-style-type: none"><li>• Multifunction electrode pads</li><li>• External paddles</li><li>• Internal paddles</li></ul>
	CPR assistance	<ul style="list-style-type: none"><li>• Multifunction electrode pads</li><li>• CPR sensor</li><li>• SpO<sub>2</sub> sensor</li></ul>
	Synchronized cardioversion	<ul style="list-style-type: none"><li>• Multifunction electrode pads</li><li>• External paddles</li><li>• Multifunction electrode pads and ECG electrodes</li><li>• External paddles and ECG electrodes</li><li>• Internal paddles and ECG electrodes</li></ul>
Pacer	Noninvasive pacing	Multifunction electrode pads and ECG electrodes

### 4.2 Connecting the Therapy Cable

To connect the therapy cable, follow this procedure:

1. Align the arrow indicated on the cable plug with that on the therapy port of the equipment.
2. Connect the therapy cable to the therapy port, push it until you hear a click.

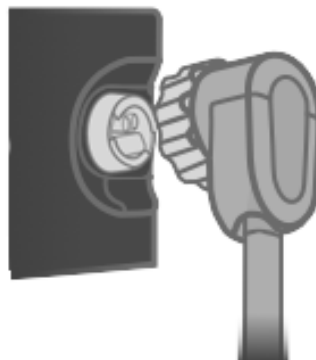

To remove the therapy cable from the equipment, rotate the cable plug clockwise to remove it.

## 4.3 Connecting the Multifunction Electrode Pads

To connect the electrode pads, follow this procedure:

1. Connect the therapy cable. For more information, see 4.2 *Connecting the Therapy Cable*.
2. Push the therapy cable and pads connector together until you hear a click.



3. If a defibrillation test is needed, connect the test load to the therapy cable.

## 4.4 Connecting the External Paddles

The following figure shows the adult external paddles.

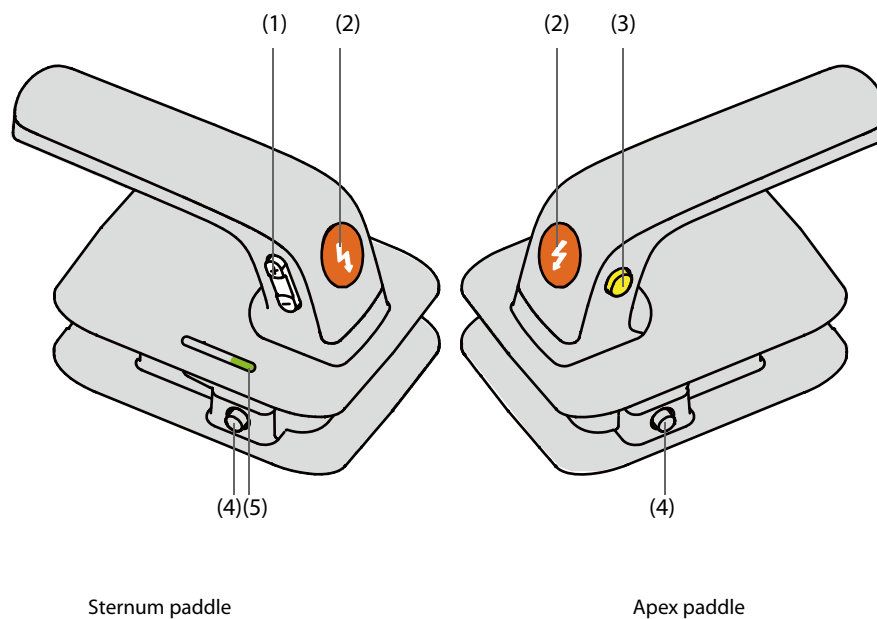

- Sternum paddle
- Apex paddle
- (1) Energy Selection button
  - (2) Shock button
  - (3) Charge button
  - (4) Latch button
  - (5) Patient contact indicator: indicates the contact status between the patient and external paddles. The patient contact indication in the Manual Defib window has a same function. For more information, see 4.8 *Checking the Patient Contact Indicator*.

- ◆ Green: indicates the patient contact is good, the impedance is suitable for the defibrillation.
- ◆ Orange: indicates the patient contact is not good, the impedance is slightly higher for the defibrillation.
- ◆ Red: indicates the patient contact is very poor, or there is a short circuit between external paddles. The impedance is completely not suitable for the defibrillation.
- ◆ Off: indicates the therapy cable falls off, paddles are placed in the paddle tray, or the equipment is not in the Manual Defib mode.

#### 4.4.1 Connecting the Adult External Paddles

To connect the adult external paddles, follow this procedure:

1. Connect the therapy cable. For more information, see 4.2 *Connecting the Therapy Cable*.
2. Hold the paddle handles, and remove the paddle set from the paddle tray.

#### 4.4.2 Connecting the Pediatric External Paddles

The external paddles provide both adult paddle electrodes and pediatric paddle electrodes included inside.

To connect the pediatric external paddles, follow this procedure:

1. Connect the therapy cable. For more information, see 4.2 *Connecting the Therapy Cable*.
2. Press the latch buttons on the external paddles.

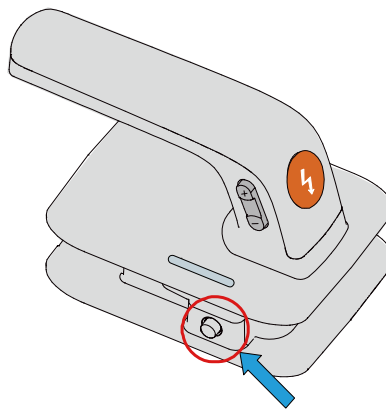

3. Pull forward the adult paddle electrodes to remove them.

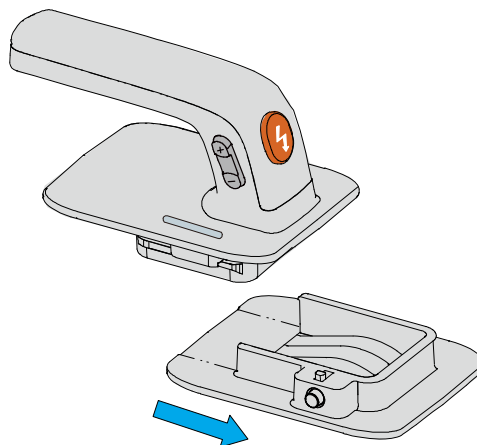

### 4.4.3 Placing the External Paddles

If external paddles are not in use, you should place them in the paddles tray. To do so, follow this procedure:

1. If pediatric paddle electrodes have been used, you should place them back inside the adult external paddles.

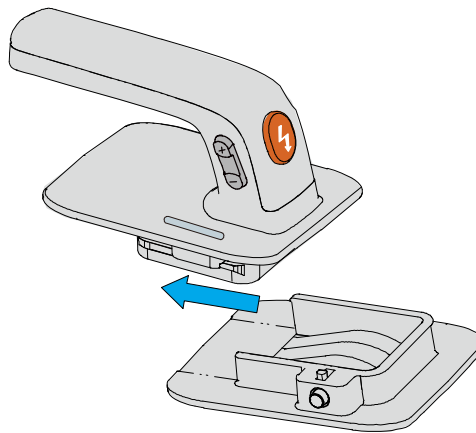

2. Hold handles of sternum and apex paddles with hands, and then align them with metal parts of the paddles tray.

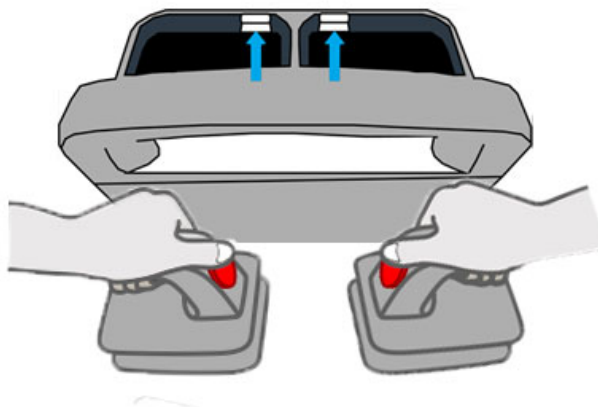

3. Press down on the external paddles until you hear a click.

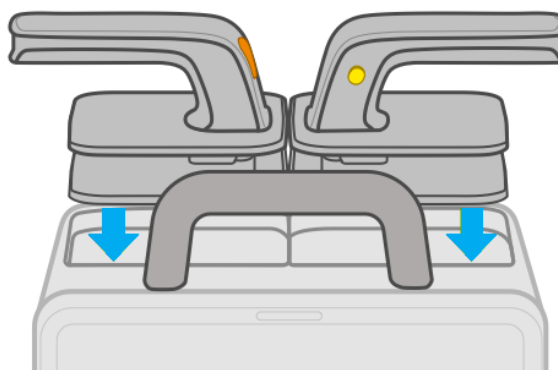



To remove external paddles from the paddles tray, push forward on both handles with force and lift them out.

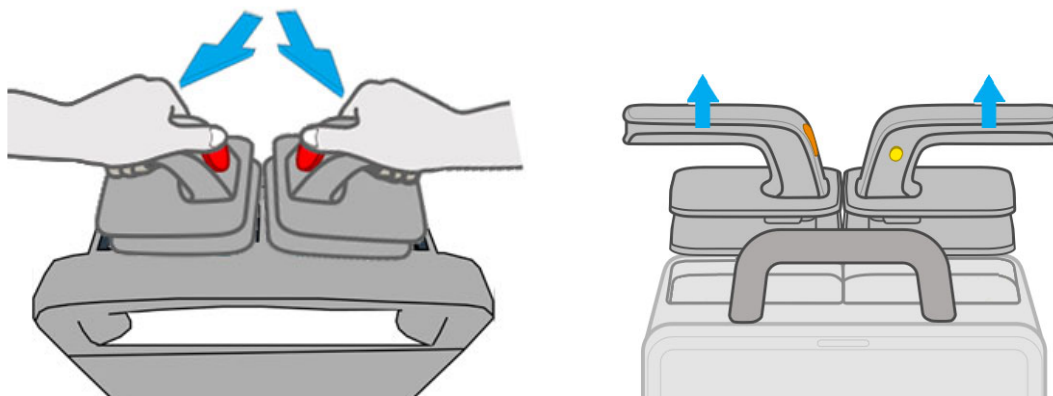

## 4.5 Connecting the Internal Paddles

Two types of internal paddles are available, including paddles without button and paddles with a button. Please check the type of transport dock before use.

The following figure shows the internal paddles.

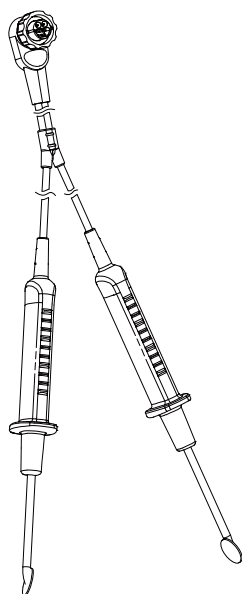

Paddles without button

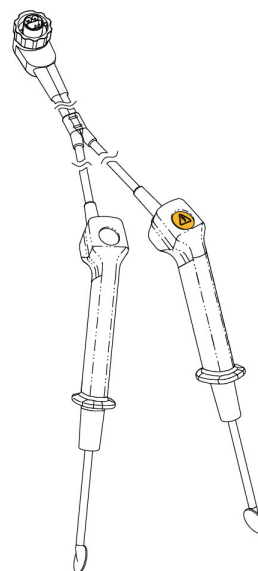

Paddles with a button

To connect the internal paddles, connect the therapy cable to the therapy port of the equipment. For more information, see 4.2 *Connecting the Therapy Cable*.

## 4.6 Connecting the CPR Sensor

If connected with the CPR sensor, the equipment can provide CPR feedbacks, charge the CPR sensor configured with a battery, and upload the latest 1-hour data from the CPR sensor.

The CPR sensor is intended to provide real-time CPR feedback for patients at least 8 years old or above 25kg weight. For more information, see *CPR Sensor Operator's Manual*.

To connect the CPR sensor, follow this procedure:

1. Hold one end of the CPR sensor cable with the Mindray logo facing up, and plug it into the CPR sensor connector.
2. Fasten the CPR sensor cable with the cable retainer.
3. Try to pull the CPR sensor cable to make sure that the cable is securely connected.

4. Plug the other end of the sensor cable into the multifunctional connector at the rear of the equipment.

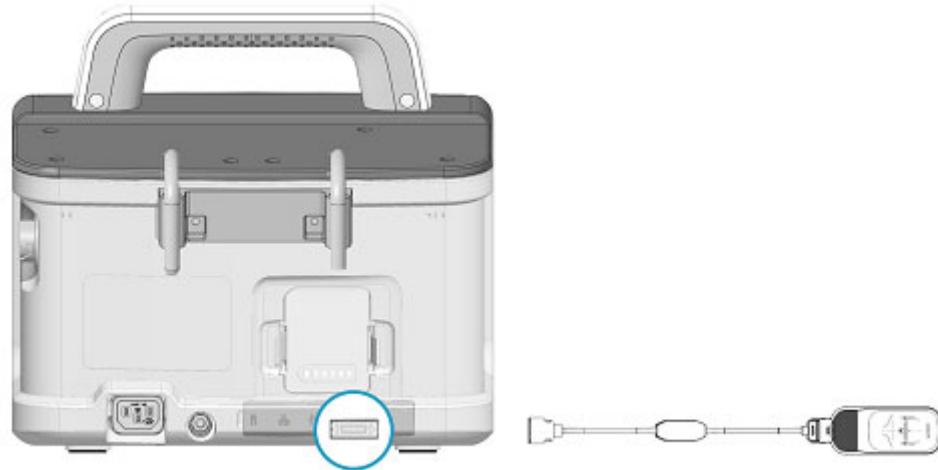

## 4.7 Preparing the Patient for Electrode Application

Proper skin preparation is necessary to ensure good signal quality at the electrode sites, as the skin is a poor conductor of electricity.

To properly prepare the skin, choose flat areas and then follow this procedure:



1. Remove the clothing from the patient's chest.
2. Ensure the patient's skin is clean and dry.
3. Dry the patient's chest and shave excessive hair if necessary.

## 4.8 Checking the Patient Contact Indicator

In the AED mode and Manual Defib mode, the patient contact indicator is used to indicate the contact status between the patient and electrode pads or between the patient and external paddles.

The displays of patient contact indicator and impedance value are disabled by default. The switch settings of **Contact Impedance Indicator** and **Contact Impedance Value** can be changed in the Configuration mode only. For more information, see 22.7.2.1 *Manual Defib Setup Tab*.

The following table lists the contact status of the patient contact indicator and the corresponding actions:

Patient Contact Indicator	Description	Corrective Actions
 Green	indicates the patient contact is good, the impedance is suitable for the defibrillation.	None
 Orange	indicates the patient contact is not good, the impedance is slightly higher for the defibrillation.	Firmly attach the electrode pads or external paddles to the patient, or adjust the placements of electrode pads or external paddles until the indicator illuminates in green. If the indicator still illuminates in orange, it also can be used for the defibrillation. However, the expected effects may not be achieved in this condition.
 Red	indicates the patient contact is very poor, or there is a short circuit between electrode pads or between external paddles. The impedance is completely not suitable for the defibrillation.	Firmly attach the electrode pads or external paddles to the patient, or adjust the placements of electrode pads or external paddles until the indicator illuminates in green or orange.

Patient Contact Indicator	Description	Corrective Actions
 Off	indicates the therapy cable falls off, paddles are placed in the paddle tray, the equipment is not in the AED, or Manual Defib mode.	Check that the therapy cable is properly connected to the equipment.

---

## NOTE

- **It is recommended to perform the defibrillation on a patient when the patient contact indicator illuminates in green. If the patient contact indicator illuminates in orange, it also can be used for the defibrillation. However, the expected effects may not be achieved in this condition.**
-

**This page intentionally left blank.**

# 5 AED

---

---

## 5.1 AED Introduction

In the AED mode, the equipment immediately analyzes the patient's heart rhythm after the electrode pads are applied.

- If a shockable rhythm is detected, you need to press the flashing Shock button on the equipment.
- If non-shockable rhythm is detected, the equipment enters the CPR status by default.

If the equipment enters the CPR status or electrode pads malfunction occurs, the equipment automatically stops analyzing the patient's heart rhythm.

The equipment also provides the CPR assistance in chest compressions. For more information, see *7 CPR Assistance*.

## 5.2 AED Safety Information

---

---

### DANGER

---

- **Defibrillation current can cause operator or bystander severe injury or even death. Do not touch the patient or any metal objects (including bed or gurney) connected to the patient during defibrillation.**
  - **Avoid contact between parts of the patient's body such as exposed skin of head or limbs, conductive fluids such as gel, blood, or saline, and metal objects such as a bed frame or a stretcher which may provide unwanted pathways for the defibrillating current.**
  - **During defibrillation, do not allow electrode pads to contact each other or to contact with ECG electrodes, lead wires, dressings, etc. Contact with metal objects may divert current away from the heart, which result in electrical arcing and patient skin burns.**
- 
- 

### WARNING

---

- **Motion artifact may delay analysis or affect the ECG signal resulting in an inappropriate shock or no shock advised message. Do not touch the patient during ECG rhythm analysis or charging in the AED mode.**
  - **Air pockets between the patient skin and electrode pads can cause electrical arcing and patient skin burns during defibrillation. To avoid poor adherence and air pockets, make sure electrode pads are completely adhered to the patient skin.**
  - **Do not use dried-out electrode pads.**
- 
- 

### CAUTION

---

- **Improper handling (such as bending or breaking) of electrode pads during storage or before use can damage the electrode pads. Discard the electrode pads if they become damaged.**
  - **For patients with implantable pacemaker, the sensitivity and specificity of AED algorithm may be impaired.**
- 
- 

### NOTE

---

- **Successful resuscitation is dependent on many variables specific to the patient's physiological state and the circumstances surrounding the patient event. Failure to have a successful patient outcome is not a reliable indicator of equipment performance. The presence or absence of a muscular response to the transfer of energy during electrical therapy is not a reliable indicator of energy delivery or equipment performance.**
- 
-

## 5.3 Accessing the AED Mode

To access the AED mode, choose any of the following ways:

- Press the **AED** button on the equipment.
- If **Default Startup Mode** is set to **AED**, the equipment automatically enters the AED mode after turned on. The setting of **Default Startup Mode** can be changed in the Configuration mode only. For more information, see *22.7.1 General Setup Menu*.
- Select the **Defib/Pacer** quick key → select the **AED** tab.
- In the Manual Defib window, select the **AED** tab.
- In the **Pacer** window, select the **AED** tab.

In the AED mode, the **AED** window is displayed, the first waveform displayed is ECG signals acquired through electrode pads, all parameters are monitored. Alarms are turned off.

## 5.4 AED Window Display

The following figure shows the **AED** window.

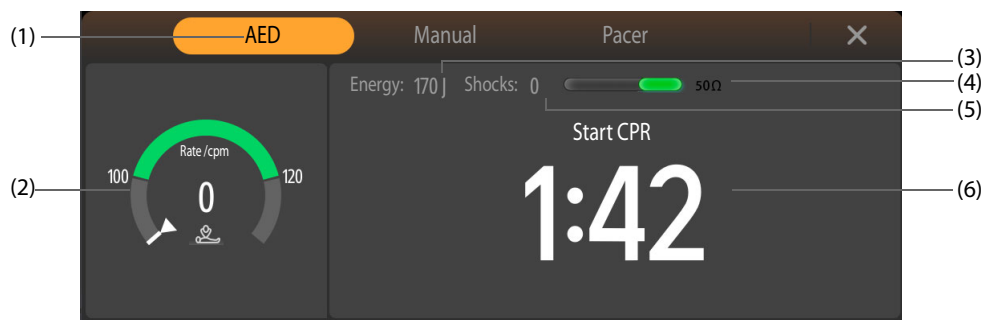

- (1) Operating mode
- (2) Connection prompt/CPR dashboard:
  - ◆ Connection prompt: if the therapy cable is not connect, a prompt is displayed.
  - ◆ CPR dashboard: provides instructions in chest compressions, including compression rate, interruption time and relevant CPR prompts.
- (3) Selected energy
- (4) Patient contact indicator and impedance value (configurable): indicates the contact status between the patient and electrode pads. For more information, see *4.8 Checking the Patient Contact Indicator*.
- (5) Shock counter
- (6) Therapy message: instructs the therapy operations.

## 5.5 AED Procedure

For a quick and immediate rescue, the equipment provides the rhythm analysis during CPR. This reduces the time you stopping CPR for the ECG rhythm analysis. For more information, see 7.4 *Rhythm Analysis during CPR*.

To perform the AED rescue, follow this procedure:

1. Access the patient and make sure the patient is suitable for AED.
2. Connect the therapy cable to the equipment, and then connect the therapy cable and electrode pads. For information, see 4.2 *Connecting the Therapy Cable* and 4.3 *Connecting the Multifunction Electrode Pads*.
3. Prepare the patient skin. For more information, see 4.7 *Preparing the Patient for Electrode Application*.
4. Apply the electrode pads to the patient as indicated on the pads package.
  - For adult patients, use the anterior-lateral placement:
    - ◆ Place the red (sternum) pad on the patient's upper right torso, lateral to the sternum and below the clavicle.
    - ◆ Place the blue (apex) pad to the patient's left nipple in the midaxillary line, with the center of the electrode in the midaxillary line.

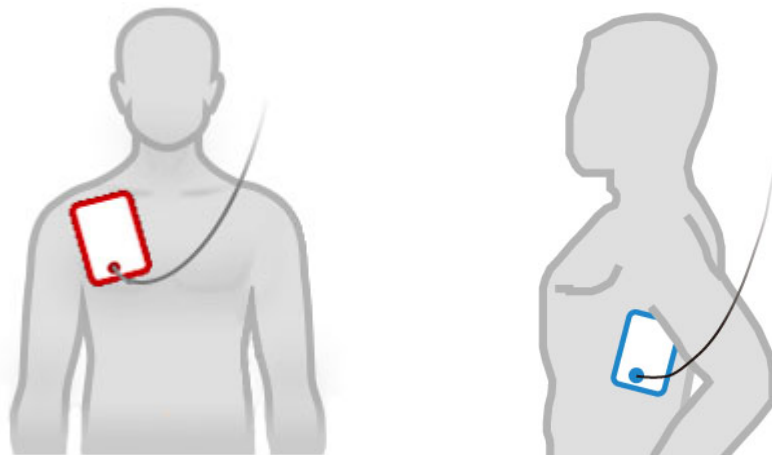

- For pediatric patients, use the anterior-posterior placement:
  - ◆ Place the blue (apex) pad in the center of the patient's chest between the nipples.
  - ◆ Place the red (sternum) pad in the center of the patient's back.

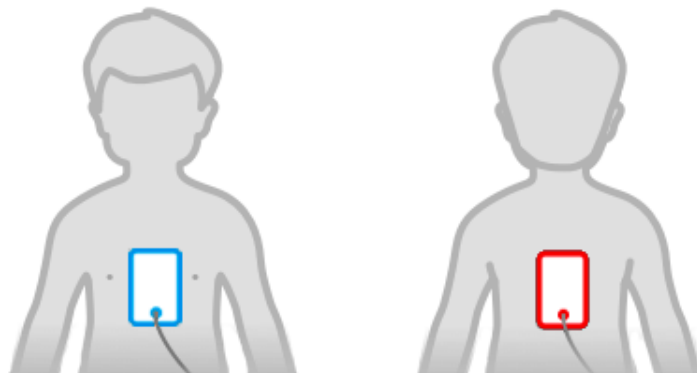

5. Check the patient category symbol in the patient information area. If needed, select the patient category symbol and change the setting of **Patient Category**.
6. The default energy level is automatically changed according to the patient category setting.
  - ◆ For the adult patients, the recommended energy level for the first shock is 200 J.
  - ◆ For the pediatric patients, the recommended energy level for the first shock is 50 J.
7. Do not touch the patient, wait for the heart rhythm analysis.
  - ◆ If a shockable rhythm is detected, the equipment prompts "**Shock Advised!**". Then perform step 8.
  - ◆ If non-shockable rhythm is detected, the equipment prompts "**No Shock Advised!**" and enters the CPR status by default. Then perform step 10.

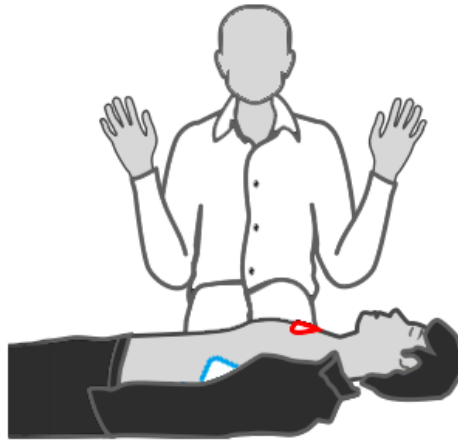

8. Do not touch the patient, wait for the equipment charging to the default energy level.
  - ◆ If the heart rhythm is detected unchanged and suitable for a shock, the equipment automatically charges to the default energy level. The equipment gives a charging tone, the flashing Shock button and prompts **“Do Not Touch Patient! Press Shock Button”**. Then perform step 9.
  - ◆ If the heart rhythm is detected changed and not suitable for a shock, the equipment automatically disarms itself. Then perform step 7.
9. Deliver a shock.
  - ◆ Press the flashing Shock button on the equipment within the configured time, then the equipment will deliver a shock of the default energy level. Then perform step 10.
  - ◆ If the heart rhythm is found changed and not suitable for a shock, the equipment automatically disarms itself. Then perform step 7.
10. Perform CPR.
  - ◆ If the CPR time expires, perform operations as instructed by rhythm analysis during CPR. The equipment automatically resumes the analysis at the completion of the pause period.
  - ◆ If the patient is conscious and breathing normally, wait for emergency medical services to arrive.

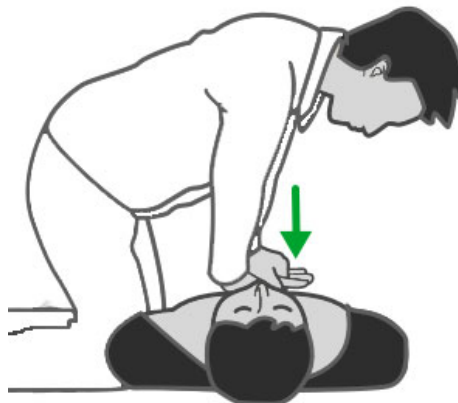
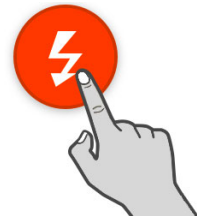

When **Shock Series** is set to greater than one, the equipment resumes the heart rhythm analysis after the shock is delivered to determine whether the shock was successful, and then continues to deliver the following shocks at the default energy level. **Time to Auto Disarm, Shock Series** and default energy levels can be changed in the Configuration mode only. For more information, see 24.7.2.2 *AED Setup Tab*.



## NOTE

- **Anterior - lateral placement for adult patients, and anterior-posterior placement for pediatric patients are recommended placements for defibrillation with electrode pads.**
- **For defibrillation of pediatric patients, pediatric electrode pads should be used.**
- **If pediatric electrode pads are not available, the adult electrode pads may be used instead, and set Patient Category to Ped.**
- **The Shock button must be pressed to deliver a shock. The equipment will not automatically deliver a shock.**
- **Impedance is the resistance found between electrode pads or external paddles. To deliver an effective discharge of energy, the impedance must be overcome. The degree of impedance varies with the patient. It is affected by other factors, such as the presence of chest hair, moisture, and lotions or powders on the patient skin. If the message "Impedance Too High, Shock Not Delivered" is displayed, make sure that the patient's skin has been dried and that any chest hair has been clipped. If the message persists, replace the electrode pads or the pads cable with a new one.**

## 5.6 Changing AED Settings

AED settings can be changed in the Configuration mode only. For more information, see 22.7.2.2 *AED Setup Tab*.

## 5.7 AED Voice Prompts

The following table lists voice prompts that may occur in the AED mode.

Voice Prompt	Description
Connect pads cable.	No therapy cable connected or pads connection failure.
Apply pads.	The patient is detected not attached with electrode pads.
Analyzing now, do not touch the patient.	Repeats until the heart rhythm analysis is completed. This prompt will be interrupted when the equipment is ready to shock.
Shock advised!	Prompts a shockable rhythm has been detected.
No shock advised.	Prompts non-shockable rhythm has been detected.
Do not touch the patient. Press the Shock button.	Prompts the equipment is fully charged and ready to deliver the shock.
Shock delivered.	Prompts the shock is delivered.
Charge removed.	The equipment detects a rhythm change and cancels the shock.
Breathe	Prompts to give breath to the patient.
Start CPR immediately.	Prompts to start CPR immediately.
Stop CPR.	Prompts to stop CPR.
Motion detected. Do not touch or move the patient.	The equipment detects ECG noise artifacts, stop moving or touching the patient.
Noise detected. Make sure pads are firmly attached.	The equipment detects ECG noise artifacts, better pads contact on the patient's skin is required.
Give chest compressions immediately.	Prompts to provide compressions on the patient.

**This page intentionally left blank.**

# 6 Manual Defibrillation

---

## 6.1 Manual Defibrillation Introduction

In the Manual Defib mode, you should assess the patient's heart rhythm, and decide to perform the manual defibrillation according to the patient condition. The Manual Defib mode also provides the synchronized cardioversion function. Prompts provided guide you throughout the defibrillation process.

The equipment also provides the CPR assistance in chest compressions. For more information, see *7 CPR Assistance*.

## 6.2 Manual Defibrillation Safety Information

---

### DANGER

---

- **Defibrillation current can cause operator or bystander severe injury or even death. Do not touch the patient or any metal objects (including bed or gurney) connected to the patient during defibrillation.**
  - **Avoid contact between parts of the patient's body such as exposed skin of head or limbs, conductive fluids such as gel, blood, or saline, and metal objects such as a bed frame or a stretcher which may provide unwanted pathways for the defibrillating current.**
  - **During defibrillation, do not allow electrode pads and paddles to contact each other or to contact with ECG electrodes, lead wires, dressings, etc. Contact with metal objects may divert current away from the heart, which result in electrical arcing and patient skin burns.**
  - **During manual defibrillation, make sure your hands are dry and free from conductive gel to avoid shock hazard.**
- 
- 

### WARNING

---

- **During synchronized cardioversion, if monitoring patient's ECG through external paddles, artifact introduced by paddle movement may resemble an R-wave and trigger a defibrillation shock.**
  - **Do not use conductive liquid. Use only conductive gel specified by the equipment manufacturer.**
  - **If external paddles are used for defibrillation, apply the external paddles tightly and evenly to the patient's chest to ensure good skin contact.**
  - **Clinicians must select an appropriate energy level for defibrillation of pediatric patients.**
- 
- 

### CAUTION

---

- **Accessing the Manual Defib mode can be configured as password protected. Make sure you know and remember the password. Otherwise the manual defibrillation therapy cannot be delivered.**
  - **Clear the conductive gel from the external paddles at the completion of the therapy to prevent the paddles from being corroded.**
  - **Prior to using the equipment, disconnect the patient from all equipment that is not defibrillation-protected.**
  - **Never charge and deliver shock frequently in non-clinical situations. Otherwise equipment damage could occur.**
- 
- 

### NOTE

---

- **Impedance is the resistance found between electrode pads or external paddles. To deliver an effective discharge of energy, the impedance must be overcome. The degree of impedance varies with the patient. It is also affected by other factors, such as the presence of chest hair, moisture, and lotions or powders on the patient skin. If the message "Impedance Too High, Shock Not Delivered" is**

displayed, make sure that the patient's skin has been dried and that any chest hair has been clipped. If the message persists, replace the electrode pads, external paddles or the therapy cable with a new one.

- Alarms are switched off automatically and the message "Alarm Off" is displayed when the equipment enters the Manual Defib mode. Alarms remain off until toggled on by pressing the Alarm Pause button, the Sync mode, the Monitor mode or Pacer mode is entered.
- Defibrillation is always performed through paddles or electrode pads. However, you can also use ECG electrode as an alternate ECG source to monitor ECG during defibrillation. If the ECG electrodes are connected, any available lead may be displayed.
- Successful resuscitation is dependent on many variables specific to the patient's physiological state and the circumstances surrounding the patient event. Failure to have a successful patient outcome is not a reliable indicator of equipment performance. The presence or absence of a muscular response to the transfer of energy during electrical therapy is not a reliable indicator of energy delivery or equipment performance.

## 6.3 Accessing the Manual Defib Mode

To access the Manual Defib mode, choose any of the following ways:

- Select the **Defib/Pacer** quick key.
- Press any of Energy Selection, Charge and Shock buttons on the equipment.
- If **Default Startup Mode** is set to **Manual Defib**, the equipment automatically enters the Manual Defib mode after turned on. The setting of **Default Startup Mode** can be changed in the Configuration mode only. For more information, see 22.7.1 *General Setup Menu*.
- In the **AED** window, select the **Manual** tab.
- In the **Pacer** window, select the **Manual** tab.

Accessing the Manual Defib mode can be configured as password protected. The setting of **Therapy Access** can be changed in the Configuration mode only. For more information, see 22.7.2.1 *Manual Defib Setup Tab*.

In the Manual Defib mode, the Manual Defib window is displayed, the first waveform displayed is ECG signals acquired through electrode pads or paddles, all parameters are monitored. Alarms are turned off.

## 6.4 Manual Defib Window Display

The following figure shows the Manual Defib window.

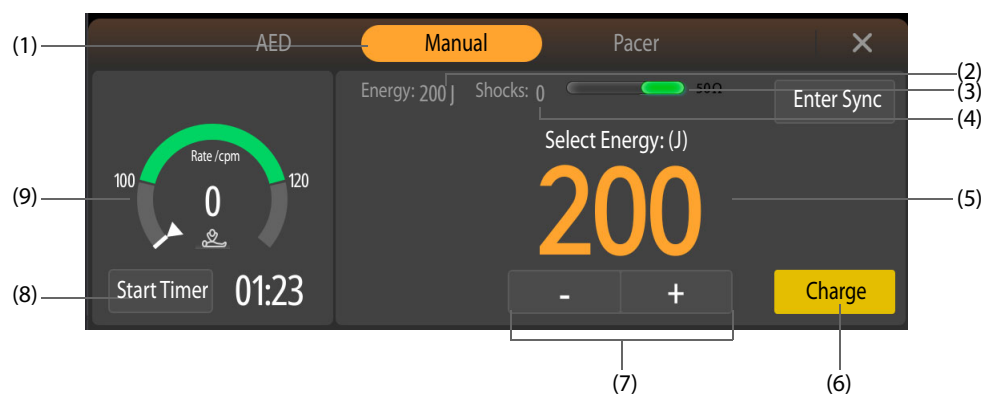

- (1) Operating mode
- (2) Selected energy
- (3) Patient contact indicator and impedance value (configurable): indicates the contact status between the patient and electrode pads or between the patient and external paddles. For more information, see 4.8 *Checking the Patient Contact Indicator*.
- (4) Shock counter
- (5) Therapy message: instructs the therapy operations.

- (7) Energy Selection key: selects the desired energy level.
- (8) CPR timer: starts or stops CPR countdown.
- (9) Connection prompt/CPR dashboard:
  - ◆ Connection prompt: if the therapy cable is not connect, a prompt is displayed.
  - ◆ CPR dashboard: provides instructions in chest compressions, including CPR timer, compression rate and interruption time.

## 6.5 External Defibrillation Procedure

### 6.5.1 Smart Analysis during External Defibrillation

Smart analysis is disabled by default during the manual defibrillation process. The switch setting of **Smart Analysis** can be changed in the Configuration mode only. For more information, see *22.7.2.1 Manual Defib Setup Tab*.

Smart analysis detects the patient connection, analyzes the patient’s heart rhythm, gives advices on charging the equipment and delivering a shock. You can perform operations following the prompts and pictures illustrated on the screen. When the message **“ECG signal is interfered”** is displayed, there is signal interference or motion artifact. In this case, you should check the connection between electrode pads/external paddles and the patient.

Smart analysis stops during charging. After charging is completed, smart analysis restarts when you confirm a shock is still needed and press the Shock button.

### 6.5.2 Using the Electrode Pads for External Defibrillation

To perform the external defibrillation, follow this procedure:

1. Access the patient and make sure the patient is suitable for the external defibrillation.
2. Connect the therapy cable to the equipment, and then connect the therapy cable and electrode pads. For information, see *4.2 Connecting the Therapy Cable* and *4.3 Connecting the Multifunction Electrode Pads*.
3. Prepare the patient skin. For more information, see *4.7 Preparing the Patient for Electrode Application*.
4. Apply the electrode pads to the patient as indicated on the pads package.
  - For adult patients, use the anterior-lateral placement:
    - ◆ Place the red (sternum) pad on the patient’s upper right torso, lateral to the sternum and below the clavicle.
    - ◆ Place the blue (apex) pad to the patient’s left nipple in the midaxillary line, with the center of the electrode in the midaxillary line.

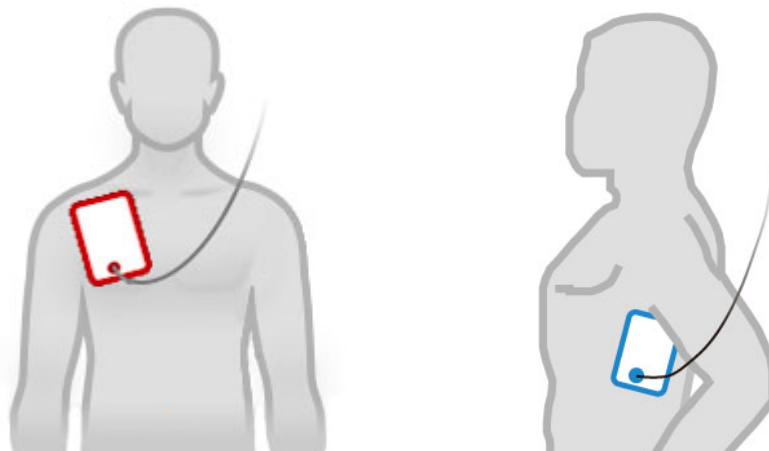

- For pediatric patients, use the anterior-posterior placement:
  - ◆ Place the blue (apex) pad in the center of the patient's chest between the nipples.
  - ◆ Place the red (sternum) pad in the center of the patient's back.

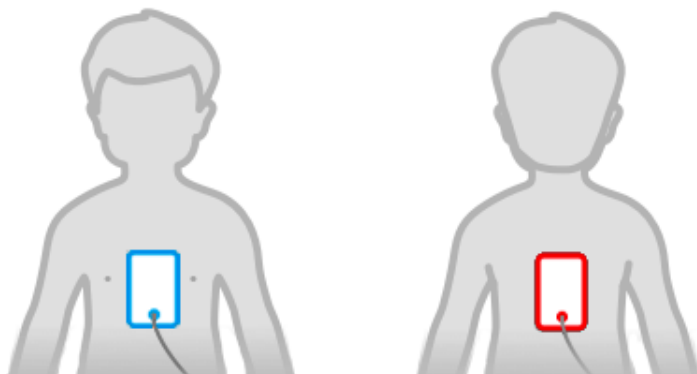

5. Check the patient category symbol in the patient information area. If needed, select the patient category symbol and change the setting of **Patient Category**.
6. The default energy level is automatically changed according to the patient category setting.
  - ◆ For the adult patients, the recommended energy level for the first shock is 200 J.
  - ◆ For the pediatric patients, the recommended energy level for the first shock is 50 J.
7. Select the energy level in either of the following ways:
  - ◆ Press the Energy Selection button on the equipment.
  - ◆ Select the Energy Selection key in the Manual Defib window. Selecting and holding it provides a quick selection.
8. Press the **Charge** button on the equipment.
9. Wait for the equipment charging to the desired energy level. The equipment gives a charging tone and changing progress bar.
  - ◆ If the selected energy level is not suitable for the patient, perform step 7 and the equipment automatically disarms itself.
  - ◆ If the heart rhythm is found changed and not suitable for a shock, you can select **Disarm** to stop the charging.
10. Press the flashing Shock button on the equipment to deliver a shock. If you do not press the Shock button within the configured time, the equipment automatically disarms itself.
11. Perform CPR. If needed, select **Start Timer** to enable CPR countdown.

When **Energy Series** is switched on, the equipment delivers a shock at the default energy level. After 3 shocks, the equipment delivers the following shocks at the default energy level of **Energy 3**. The switch setting of **Energy Series** and default energy levels can be changed in the Configuration mode only. For more information, see 24.7.2.1 *Manual Defib Setup Tab*.

## NOTE

- **Anterior - lateral placement for adult patients, and anterior-posterior placement for pediatric patients are recommended placements for defibrillation with electrode pads.**
- **For defibrillation of pediatric patients, you can use the default energy level, or adjust the energy level in accordance with the local medical protocols.**
- **For defibrillation of pediatric patients, pediatric electrode pads should be used.**
- **If pediatric electrode pads are not available, the adult electrode pads may be used instead, and set Patient Category to Ped.**
- **For defibrillation of neonatal patients, set the energy level according to the patient's clinical condition. The energy level for neonatal patient should be lower than the default setting.**

### 6.5.3 Using the External Paddles for External Defibrillation

To perform the external defibrillation, follow this procedure:

1. Access the patient and make sure the patient is suitable for the external defibrillation.
2. Connect the therapy cable to the equipment, and then connect the therapy cable and external paddles. For information, see 4.2 *Connecting the Therapy Cable* and 4.4 *Connecting the External Paddles*.
3. Prepare the patient skin. For more information, see 4.7 *Preparing the Patient for Electrode Application*.
4. Apply electrode gel on the paddle electrodes.
5. Apply the external paddles to the patient by using the anterior-lateral placement.
  - ◆ Place the sternum paddle on the patient's upper right torso, lateral to the sternum and below the clavicle.
  - ◆ Place the apex paddle to the patient's left nipple in the midaxillary line, with the center of the electrode in the midaxillary line.

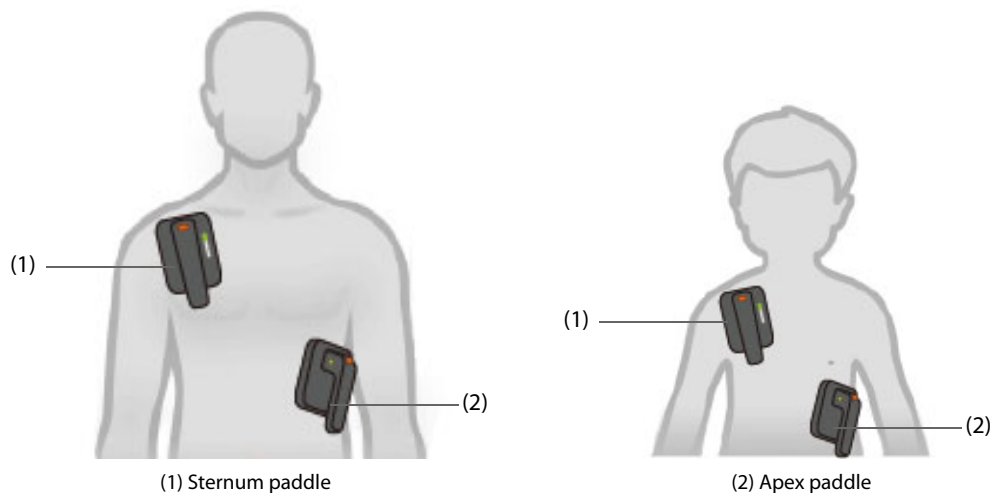

6. Check the patient category symbol in the patient information area. If needed, select the patient category symbol and change the setting of **Patient Category**.
7. The default energy level is automatically changed according to the patient category setting.
  - ◆ For the adult patients, the recommended energy level for the first shock is 200 J.
  - ◆ For the pediatric patients, the recommended energy level for the first shock is 50 J.
8. Select the energy level in any of the following ways:
  - ◆ Press the Energy Selection button on the equipment.
  - ◆ Press the Energy Selection button on the Apex paddle.
  - ◆ Select the Energy Selection key in the Manual Defib window. Selecting and holding it provides a quick selection.
9. Charge the equipment in any of the following ways:
  - ◆ Press the Energy Selection button on the Apex paddle.
  - ◆ Press the **Charge** button on the equipment.
  - ◆ Select **Charge** in the Manual Defib window.
10. Wait for the equipment charging to the desired energy level. The equipment gives a charging tone and changing progress bar.
  - ◆ If the selected energy level is not suitable for the patient, perform step 8 and the equipment automatically disarms itself.
  - ◆ If the heart rhythm is found changed and not suitable for a shock, you can select **Disarm** to stop the charging.

11. Simultaneously press the Shock buttons both on the external paddles. If you do not press the Shock buttons within the configured time, the equipment automatically disarms itself.

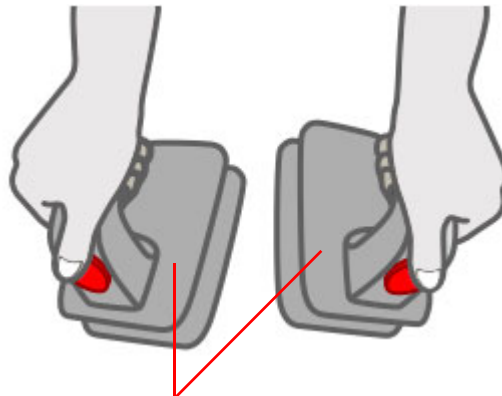

**Do not touch this surface and the part below!**

12. Perform CPR. If needed, select **Start Timer** to enable CPR countdown.

When **Energy Series** is switched on, the equipment delivers a shock at the default energy level. After 3 shocks, the equipment delivers the following shocks at the default energy level of **Energy 3**. The switch setting of **Energy Series** and default energy levels can be changed in the Configuration mode only. For more information, see 24.7.2.1 *Manual Defib Setup Tab*.

---

## WARNING

---

- Hold only the insulating parts of the paddle handles to avoid shock hazard during charging or shock delivery.
- 

## NOTE

---

- Anterior - lateral placement is the only placement for defibrillation with external paddles.
  - When external paddles are used, the Shock button on the front panel is disabled.
  - For defibrillation of pediatric patients, you can use the default energy level, or adjust the energy level in accordance with the local medical protocols.
  - For defibrillation of neonatal patients, set the energy level according to the patient's clinical condition. The energy level for neonatal patient should be lower than the default setting.
- 

## 6.6 Internal Defibrillation Procedure

To perform the internal defibrillation, follow this procedure:

1. Access the patient and make sure the patient is suitable for the internal defibrillation.
2. Connect the therapy cable of internal paddles to the equipment. For information, see 4.2 *Connecting the Therapy Cable*.
3. Press the Energy Selection button on the equipment to select the energy.
4. Place the conductive surface of paddle electrodes against the patient's right atrium and left ventricle.
5. Charge the equipment in either of the following ways:
  - ◆ Press the **Charge** button on the equipment.
  - ◆ Select **Charge** in the Manual Defib window.



6. Deliver a shock to the patient.
  - ◆ For paddles without button, press the Shock button on the equipment.

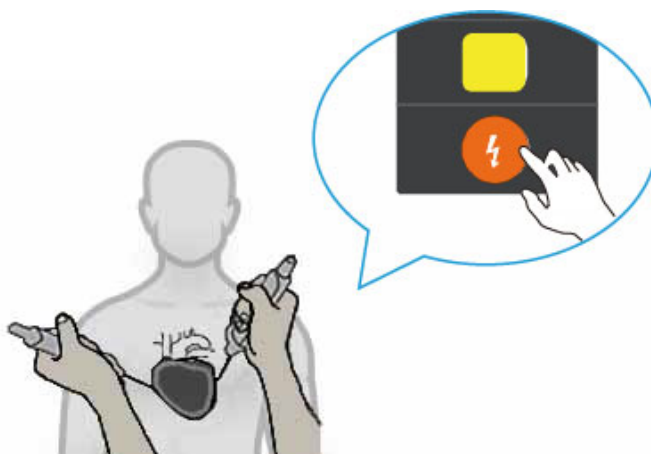

- ◆ For paddles with a button, press the Shock button on the right paddle handle.



## NOTE

- **To avoid possible cardiac damage from higher energies, the energy selection for internal defibrillation is limited to 50J.**
- **Clean and sterilize the internal paddles after each use. Otherwise, severe infection may result.**

## 6.7 Synchronized Cardioversion

Certain arrhythmias, such as atrial fibrillation, require synchronizing the defibrillation discharge with the ECG R-wave to avoid the induction of ventricular fibrillation. When the Shock button (or buttons, if using paddles) is pressed and held, the equipment discharges with the next detected R-wave.

With synchronized cardioversion enabled, you are recommended to use ECG electrodes for ECG monitoring, use electrode pads, external paddles or internal paddles for the shock delivery. You can also only use the electrode pads or external paddles for both ECG monitoring and shock delivery.

If a remote patient monitor, such as a bedside patient monitor, is connected, the equipment provides the remote synchronized cardioversion.

## CAUTION

- **Using internal paddles for synchronized cardioversion requires that the patient's ECG be acquired through a standard ECG cable. The patient's ECG acquired through the internal paddles may be unreliable for synchronized cardioversion due to excessive noise or artifact causing inappropriate R-wave detection.**

## 6.7.1 Enabling Synchronized Cardioversion

To enable synchronized cardioversion, follow this procedure:

1. Access the Manual Defib mode. For more information, see 6.3 *Accessing the Manual Defib Mode*.
2. Choose the corresponding way based on the switch setting of **Remote Sync**. **Remote Sync** is switched off by default. This setting can be changed in the Configuration mode only. For more information, see 22.7.2.1 *Manual Defib Setup Tab*.
  - ◆ If switched off, select **Enter Sync** → **Yes**.
  - ◆ If switched on, select **Enter Sync** → **Yes** → **Local**.

With synchronized cardioversion enabled, the alarm system is automatically turned on, **SYNC** marker appears in the manual Defibrillation information area and a marker appears above each R-wave.

The following figures shows the Manual Defib window with synchronized cardioversion enabled.

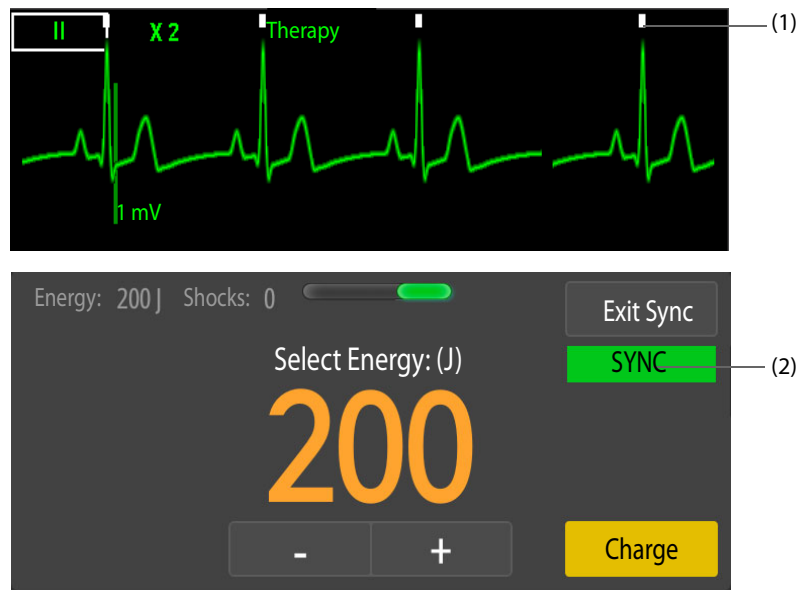

(1) R-wave marker

(2) SYNC marker

## 6.7.2 Synchronized Cardioversion Procedure

Synchronized cardioversion procedure in this section, ECG electrodes are used for ECG monitoring, external paddles are used for the shock delivery.

To perform synchronized cardioversion, follow this procedure:

1. Access the patient and make sure the patient is suitable for synchronized cardioversion.
2. Connect the therapy cable to the equipment, and then connect the therapy cable and external paddles. For information, see 4.2 *Connecting the Therapy Cable* and 4.4 *Connecting the External Paddles*. For details on connecting other accessories for the shock delivery, see corresponding description in 4 *Therapy Preparation*.
3. Prepare the patient skin. For more information, see 4.7 *Preparing the Patient for Electrode Application*.
4. Apply the ECG electrodes to the patient. For more information, see 11.4.2 *Applying ECG Electrodes*.
5. Enable synchronized cardioversion. For more information, see 6.7.1 *Enabling Synchronized Cardioversion*.
6. Select a lead. The selected lead should have a clear signal and a large QRS complex.
7. Check that a white R-wave marker appears above each R-wave. If the R-wave markers do not appear or do not coincide with the R-waves, for example above the T-waves, select another lead.
8. Press the Energy Selection button on the Apex to select the energy level. For details on selecting the energy level with other accessories, see corresponding description in 6.5.2 *Using the Electrode Pads for External Defibrillation* and 6.6 *Internal Defibrillation Procedure*.

9. Press the Charge button the Apex paddle. For details on charging the equipment with other accessories, see corresponding description in 6.5.2 *Using the Electrode Pads for External Defibrillation* and 6.6 *Internal Defibrillation Procedure*.
10. Simultaneously press the Shock buttons on both the external paddles. For details on delivering a shock with other accessories, see corresponding description in 6.5.2 *Using the Electrode Pads for External Defibrillation* and 6.6 *Internal Defibrillation Procedure*.
11. Press and hold the Shock buttons on both the external paddles until the shock is delivered.

## NOTE

- **During synchronized cardioversion, the shock will be delivered when the equipment detects the next R-wave. If electrode electrodes or internal paddles without button are used, you should press and hold the Shock button on the equipment until the shock is delivered. If external paddles are used, you should press and hold the Shock buttons on both the external paddles until the shock is delivered. If internal paddles with a button are used, you should press and hold the Shock button on the right paddle handle until the shock is delivered.**

### 6.7.3 Remote Synchronized Cardioversion

To enable the remote synchronized cardioversion, you need to switch on **Remote Sync**. **Remote Sync** is switched off by default. This setting can be changed in the Configuration mode only. For more information, see 22.7.2.1 *Manual Defib Setup Tab*.

To perform the remote synchronized cardioversion, follow this procedure:

1. Connect the one end of the synchronous defibrillation input cable to the multifunctional connector of a bedside monitor.
2. Connect the other end of the synchronous defibrillation input to the multifunctional connector of the equipment.
3. In the Manual Defib window, select **Enter Sync** and then **Remote** to access remote synchronized cardioversion. The prompt "**Remote Sync**" is highlighted in a yellow box and displayed in the window.
4. Confirm a square wave blinks with each R wave detected on the remote monitor, which indicates a synchronized pulse is received on the equipment.

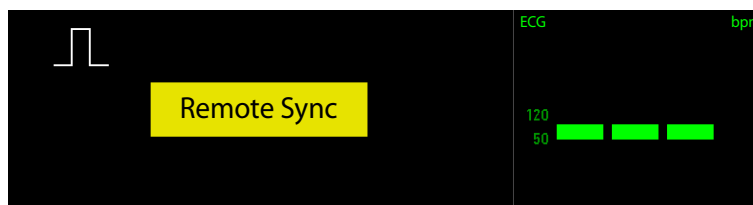

5. Perform synchronized cardioversion. For more information, see 6.7.2 *Synchronized Cardioversion Procedure*.

## NOTE

- **During remote synchronized cardioversion, the local equipment does not display the ECG waveform. To view the patient's ECG, check the remote monitor.**
- **When you use a remote monitor as the ECG source, a biomedical technician must verify that the remote monitor and the equipment combination will deliver a synchronized shock within 60 ms after the peak of the next R-wave is generated.**

### 6.7.4 Delivering Additional Synchronized Shocks

To deliver additional synchronized shocks, choose the corresponding way based on the switch setting of **Sync After Shock**.

- If switched on, repeat steps 6 to 11 as described in 6.7.1 *Enabling Synchronized Cardioversion*.
- If switched off, enable synchronized cardioversion again, repeat steps 5 to 11 as described in 6.7.1 *Enabling Synchronized Cardioversion*.

**Sync After Shock** is switched off by default. This setting can be changed in the Configuration mode only. For more information, see 22.7.2.1 *Manual Defib Setup Tab*.

## 6.7.5 Exiting Synchronized Cardioversion

To exit synchronized cardioversion, choose the corresponding way based on the switch setting of **Sync After Shock**.

- If switched on, select **Exit Sync**.
- If switched off, the equipment automatically exits synchronized cardioversion after a shock is delivered.

**Sync After Shock** is switched off by default. This setting can be changed in the Configuration mode only. For more information, see *22.7.2.1 Manual Defib Setup Tab*.

## 6.8 Changing Manual Defibrillation Settings

Manual Defibrillation settings can be changed in the Configuration mode only. For more information, see *22.7.2.1 Manual Defib Setup Tab*.

# 7 CPR Assistance

---

## 7.1 CPR Assistance Introduction

When performing CPR, the equipment can provide the CPR assistance in chest compressions.

## 7.2 CPR Assistance Safety Information

---

### WARNING

---

- Perform CPR on a patient on firm ground if possible. When you perform CPR on a patient lying on a mattress, a backboard must be used to limit the amount of compressed depth which is absorbed by the mattress. Depending on characteristics of the mattress, backboard and patient, the compensation depth does not guarantee that the patient chest is compressed by 50 mm.
  - When the patient is breathing with high frequency or in the treatment of high-frequency ventilation, the CPR assistance disturbed by the thoracic movements may provide inaccurate feedback. You should count compressions by yourself and not rely on the compression rate provided by the CPR assistance in such conditions.
  - The CPR assistance is not intended for use in a moving environment, such as an ambulance. If used during patient transport, the CPR assistance may provide inaccurate feedback. If CPR is indicated in a moving environment, do not rely on feedback provided by the CPR assistance in such conditions.
- 

### NOTE

---

- The CPR sensor is not available in the markets of UK, Germany and France.
- 

## 7.3 Accessing the CPR Status

The equipment automatically accesses the CPR status in the following conditions:

- In the AED mode, a non-shockable rhythm is detected with a prompt **“No Shock Advised!”**.
- In the AED mode, a shock is delivered and heart rhythm analysis is paused.
- In the Manual Defib mode, shake and compress the CPR sensor.

CPR status continues for 2 minutes by default. The setting of **CPR Time** can be changed in the Configuration mode only. For more information, see 22.7.2.1 *Manual Defib Setup Tab* and 22.7.2.2 *AED Setup Tab*.

## 7.4 Rhythm Analysis during CPR

In the AED mode, the equipment immediately analyzes the patient’s heart rhythm after the CPR time expires.

- If analyzed as a shockable rhythm with a prompt **“Shock Advised!”**, you need to press the flashing Shock button on the equipment.
- If analyzed as a non-shockable rhythm with a prompt **“No Shock Advised!”**, you need to continue performing CPR.
- If analyzed as an indeterminate rhythm with a prompt **“Do Not Touch Patient! Analyzing...”**, you need to wait for the analysis without any operations.

## 7.5 CPR Metronome

With CPR metronome enabled, the equipment guides you with metronome sounds to perform chest compression and ventilation at AHA/ERC recommended rate. The default compression/ventilation rate is 30:2.

CPR metronome is enabled by default. The settings of **CPR Metronome** and compression/ventilation rate can be changed in the Configuration mode only. For more information, see 22.7.2.4 *CPR Setup Tab* and 22.7.2.2 *AED Setup Tab*.

---

### WARNING

---

- **The CPR metronome sounds do not indicate information regarding the patient's condition. Because patient status can change in a short time, the patient should be assessed at all times. Do not perform CPR on a patient who is responsive or is breathing normally.**
- 

### NOTE

---

- **The settings of CPR metronome are affected by the settings of Voice Prompts and Voice Volume in the AED Setup menu.**
- 

## 7.6 CPR Filter

Performing CPR introduces CPR artifact into the ECG signal. With CPR filter enabled, the equipment automatically starts filtering CPR artifact and gives a close approximation of the patient's underlying ECG rhythm when detecting the CPR compressions.

CPR filter is enabled by default. The switch setting of **CPR Filter** can be changed in the Configuration mode only. For more information, see 22.7.2.4 *CPR Setup Tab*.

You should connect the electrode pads or CPR sensor for CPR filter. For more information, see 4.6 *Connecting the CPR Sensor*, corresponding description of electrode pads connection in 5.5 *AED Procedure* and 6.5.2 *Using the Electrode Pads for External Defibrillation*.

The CPR filter automatically stops working in the following conditions:

- The AED mode or Manual Defib mode is exited.
- Patient impedance is invalid.
- The ECG electrodes fall off.

### 7.6.1 Displaying Filtered ECG Waveform

To display the filtered ECG waveform, follow this procedure:

1. Access the CPR status. For more information, see 7.3 *Accessing the CPR Status*.
2. Select the **Main Menu** quick key → from the **Display** column select **Screen Setup**.
3. Select the **Tile Layout** tab.
4. Select the desired parameter waveform area, and then select **CPR** → **CPR Filter**.

### 7.6.2 Viewing Filtered ECG Waveform

When performing CPR, the original ECG waveform with CPR artifact is displayed in the first line, the filtered ECG waveform is displayed in the configured area with the label "**Filt.**". When viewing the filtered ECG waveform, the CPR filter switch, the filtered ECG lead and gain cannot be changed. However, you can change the settings of original ECG lead (only in the Manual Defib mode) and gain.

The equipment automatically starts filtering the CPR artifact when detecting the CPR compressions.

When the patient is connected with both electrode pads and CPR sensor, the filtered waveform is displayed as follows:

- In the AED mode, the filtered waveform is acquired through electrode pads.
- In the Manual Defib mode, if the ECG lead is set to **Pads**, the filtered waveform is acquired through electrode pads.

- In the Manual Defib mode, if the ECG lead is set to monitoring lead (for example, I, II, III), the filtered waveform is acquired through the CPR sensor.

The following figure shows the original and filtered ECG waveforms in the AED mode.

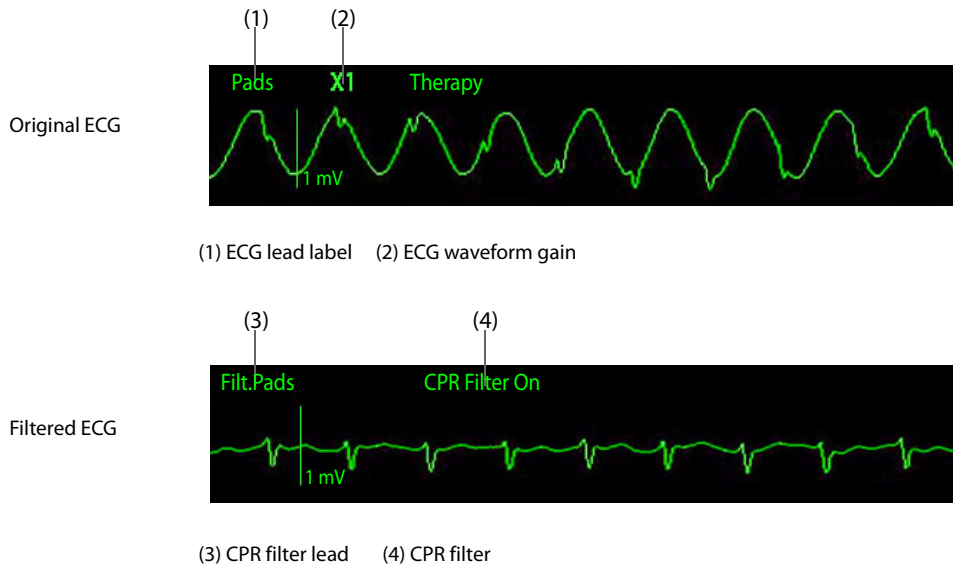

---

## CAUTION

- **The CPR filter works only when you perform CPR using electrode pads or the CPR sensor.**
- **CPR compressions introduce CPR artifact into the ECG signal. The CPR filter relies on the correlation between CPR compressions and CPR artifacts from the ECG signal. The filtered ECG waveform should be used as a reference for the real waveform. Because the CPR filter will not remove all CPR artifact in some conditions. For example, in the case of asystole or low amplitude pulseless electrical activity (PEA), the residual artifact after filtered looks like fine ventricular fibrillation. You should always follow the standard procedure of stopping CPR to verify the patient's ECG rhythm before making treatment decisions.**

---

## NOTE

- **There is a slight delay between the original and filtered ECG waveforms.**
- 

## 7.7 CPR Feedbacks

When CPR compressions are detected, the equipment provides real-time CPR feedback.

- For electrode pads: the compression rate and interruption time are provided.
- For the CPR sensor: the compression rate, interruption time, compression bar graph, compression depth and CCF (CPR compression fraction) are provided.

You should connect the electrode pads or CPR sensor for CPR feedbacks. For more information, see [4.6 Connecting the CPR Sensor](#), corresponding description of electrode pads connection in [5.5 AED Procedure](#) and [6.5.2 Using the Electrode Pads for External Defibrillation](#).

## 7.7.1 Displaying Compression Bar Graph and Numerics

When performing CPR, the compression rate is displayed in the therapy window. When stopping CPR, the interruption time is displayed in the therapy window.

When performing CPR with a CPR sensor, besides compression rate and interruption time, you can display compression bar graph and numerics in the parameter waveform area and numeric area. To do so, follow this procedure:

1. Access the CPR status. For more information, see *7.3 Accessing the CPR Status*.
2. Select the **Main Menu** quick key → from the **Display** column select **Screen Setup**.
3. Select the **Tile Layout** tab.
4. Select the desired parameter waveform area, and then select **CPR** → **CPR Sensor**.

## 7.7.2 Viewing Compression Bar Graph and Numerics

The following figure shows the feedbacks when performing CPR with the CPR sensor.

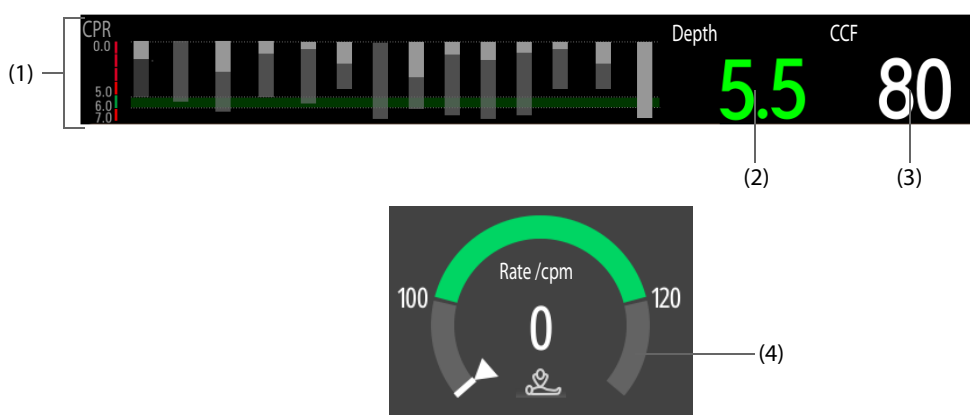

- (1) Compression bar graph: indicates compression depth scale, depth and recoil for each compression, prompt messages.
  - ◆ Compression depth scale: indicates a proper depth range with a green background.
  - ◆ Compression depth and recoil: each bar length indicates a compression depth, the white portion represents the recoil.
  - ◆ Prompt message: gives instructions for the current poor compression.
- (2) Compression depth: indicates the current compression depth.
  - ◆ Green: indicates that the compression depth is good.
  - ◆ Red: indicates that the compression depth is poor.
- (3) CCF: indicates the percentage of compression time within CPR duration.
- (4) CPR dashboard: indicates the current compression rate.

When connected both electrode pads and CPR sensor, the compressions rate is obtained from the CPR sensor. When stopping CPR, the interruption time is displayed.

  - ◆ Green: indicates that the compression rate is good.
  - ◆ Red: indicates that the compression rate is poor.



## 7.8 CPR Quality (CQI) Monitoring

The equipment configured with the Mindray SpO<sub>2</sub> module provides the CPR quality indicator (CQI).

When performing CPR with a SpO<sub>2</sub> sensor, CQI is obtained and computed based on pulse signals from the SpO<sub>2</sub> sensor and compressions. CQI values form a CQI trend.

CQI monitoring is intended for evaluating the CPR effect for adult patients.

You should connect a SpO<sub>2</sub> sensor for CQI monitoring. For more information, see corresponding description about the SpO<sub>2</sub> sensor connection in *14.5 Preparing for SpO<sub>2</sub> Monitoring*.

---

### WARNING

---

- **CQI monitoring is not intended for pediatric and neonatal patients.**
  - **CQI results should not be used as the sole basis for diagnosis or therapy decisions. It is not intended to replace the competent judgment of a clinician. CQI monitoring must be used in conjunction with the patient's medical history, the cause of heart attack, as well as the clinical judgment.**
- 

---

### NOTE

---

- **A license is required for CQI monitoring.**
- 

### 7.8.1 CQI Monitoring Limitations

CQI monitoring is contraindicated for the patients not suitable for SpO<sub>2</sub> monitoring. It should be used with caution for patients suffering from the following conditions:

- Fingertip defect
- Dyes in the measurement site, such as methylene blue, indigo carmine, nail polish, and etc
- Arterial blood flow too low to be measured due to vasoconstriction drug or Raynaud's phenomenon, and etc
- Severe anemia
- High carboxyhemoglobin (COHb) and methemoglobin (MetHb) level

---

### CAUTION

---

- **Use recommended SpO<sub>2</sub> sensor and apply it to a proper site.**
  - **Avoid moving the measurement site.**
  - **Apply the SpO<sub>2</sub> sensor properly. If the SpO<sub>2</sub> sensor is improperly applied or a wrong SpO<sub>2</sub> sensor is used, erroneous CQI could result. For more information, see *14.3 SpO<sub>2</sub> Measurement Limitations*.**
- 

### 7.8.2 Displaying CQI Trends and Numerics

When performing CPR, the compression rate is displayed in the therapy window. When stopping CPR, the interruption time is displayed in the therapy window. Besides compression rate and interruption time, you can display CQI trends and numerics in the parameter waveform area and numeric area. To do so, follow this procedure:

1. Access the CPR status. For more information, see *7.3 Accessing the CPR Status*.
2. Select the **Main Menu** quick key → from the **Display** column select **Screen Setup**.
3. Select the **Tile Layout** tab.
4. Select the desired parameter waveform area, and then select **CPR** → **CQI**.

### 7.8.3 Viewing CQI Trends and Numerics

The following figure shows CQI trends and numerics when monitoring CQI.

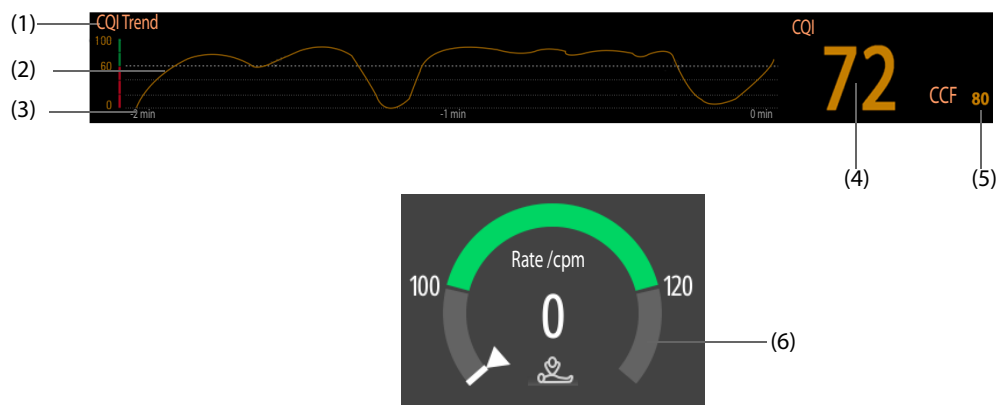

- (1) CQI scale:
  - ◆ > 60: indicates that the patient's peripheral circulation and CPR quality are good.
  - ◆ ≤ 60: indicates that the patient's peripheral circulation and CPR quality are not good.
- (2) CQI trend: indicates the change of CQI value.
- (3) CQI trend length: indicates the period of time to the current time. The equipment displays up to 30 minutes of CQI trend.
- (4) CQI value: indicates the CPR quality. The greater the CQI value, the better the patient's peripheral circulation and CPR quality.
  - ◆ Green: indicates that the patient's peripheral circulation and CPR quality are good.
  - ◆ Yellow: indicates that the patient's peripheral circulation and CPR quality are normal.
  - ◆ Red: indicates that the patient's peripheral circulation and CPR quality are not good.
- (5) CCF: indicates the percentage of compression time within CPR duration.
- (6) CPR dashboard: indicates the current compression rate.

When connected both electrode pads and CPR sensor, the compressions rate is obtained from the CPR sensor. When stopping CPR, the interruption time is displayed.

  - ◆ Green: indicates that the compression rate is good.
  - ◆ Red: indicates that the compression rate is poor.

## 7.9 Viewing Rescue Debriefing

Real-time data can be stored during the rescue. The equipment provides rescue debriefing for analysis and statistics of the latest rescue after startup.

To view rescue debriefing, select **Rescue Debriefing** below the therapy window.

When the equipment is turned off, a rescue debriefing event is automatically generated. You can view all rescue debriefing events saved after the equipment restarts. For more information, see *18.7 Reviewing Events*.

If connected to the rescue debriefing statistical system, the equipment automatically uploads rescue debriefing included in the auto test report. For more information, see *21.10 Connecting the Rescue Debriefing Statistical System*.

## 7.10 Uploading CPR Data

If you use the CPR sensor independently, you can connect it to the equipment, and upload the latest one-hour data to the equipment. You can also review CPR events uploaded from the CPR sensor on the equipment. For more information, see *18.7 Reviewing Events*.

## 7.11 Changing CPR Settings

CPR settings can be changed in the Configuration mode only. For more information, see 22.7.2.4 *CPR Setup Tab*.

## 7.12 CPR Voice Prompts

The following table lists voice prompts that may occur when you perform CPR.

Voice Prompt	Description
Compress deeper	When you perform CPR using electrode pads or a CPR sensor, it prompts to adjust the compression strength.
Compress shallower	
Compress faster	When you perform CPR using a CPR sensor, it prompts to adjust the compression rate.
Compress slower	
Incomplete recoil	When you perform CPR using a CPR sensor, it prompts to use more effort and release all pressure when moving hands up.

**This page intentionally left blank.**

# 8 Noninvasive Pacing

## 8.1 Pacing Introduction

The Pacer mode offers non-invasive transcutaneous pacing therapy. In the Pacer mode, ECG signals are acquired through ECG electrodes and pace pulses are delivered through electrode pads. The electrode pads cannot be simultaneously used for monitoring ECG rhythm and delivering pace pulses.

Pace pulses can be delivered to the patient. A white pace marker appears on the ECG waveform each time a pace pulse is delivered to the patient. If pacing in demand mode, white R-wave marker also appears on the ECG waveform until capture occurs.

In demand mode pacing, the pacemaker delivers a pulse only when it is needed. The demand pacemaker searches for intrinsic cardiac activity. If a beat is not detected or sensed within a designated interval, a pace pulse will be delivered. If an intrinsic beat is detected, the demand pacemaker resets the timer and continues the search for intrinsic cardiac activity.

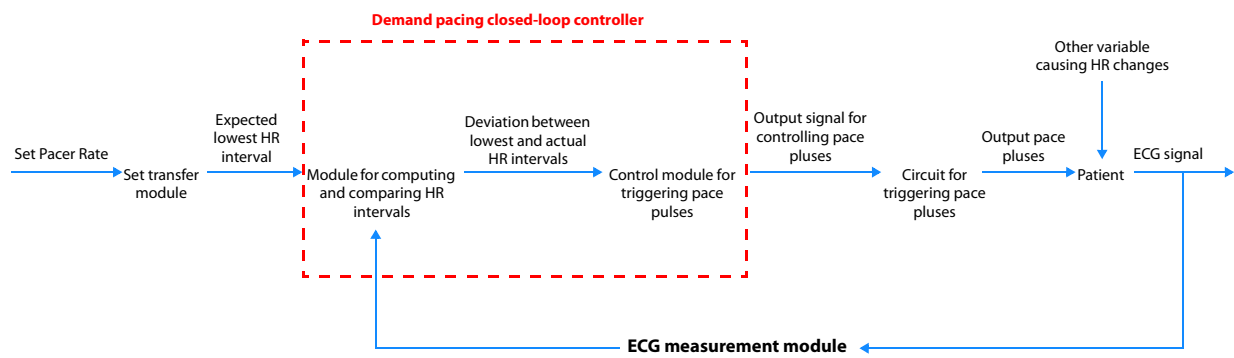

Demand pacing closed-loop controller system

## 8.2 Pacing Safety Information

### WARNING

- Heart rate and related alarms may be unreliable during pacing, you should always keep the patient under close surveillance. The indicated heart rate or related alarms cannot be used as the sole basis for the patient's perfusion status.
- Monitoring ECG alone is sometimes not enough to verify that the patient's heart is providing cardiac output. The patient's response to pacing shall be verified by signs of improved cardiac output, such as a palpable pulse rate the same as the rate which pace pulses are being delivered, a rise in blood pressure, or improved skin color.
- To avoid a possible shock hazard, be careful to apply the electrode pads on the patient during pacing.
- If you are using the pacing function with battery power and the alarm "Low Battery" is displayed, connect the equipment to external power supply or install a fully charged battery.

### CAUTION

- Accessing the Pacer mode can be configured as password protected. Make sure you know and remember the password. Otherwise the pacing therapy cannot be delivered.
- For treatment of the patient with an implanted devices, such as permanent pacemaker or cardioverter-defibrillator, consult a physician and the instructions for use delivered with the device.

- Prolonged noninvasive pacing may cause patient skin irritation and burns. Periodically inspect the underlying skin and change ECG electrodes and electrode pads.

---

## NOTE

- If pacing is interrupted for any reason, you must select Start Pacing to resume pacing.
  - In the Pacer mode, you cannot change the patient's internal paced status from the ECG menu.
  - In the case that electrode pads poorly contact the patient, the alarm "Pacer Stopped Abnormally" and "Pads Off" may be displayed.
  - Electrode pads are not an available choice for the source of ECG waveform in the Pacer mode.
  - In the Pacer mode, arrhythmia analysis is supported and available arrhythmia alarms are asystole, ventricular fibrillation and ventricular tachycardia.
  - The monitoring or pacing function may be unstable in the presence of ESU or other electronic devices.
- 

## 8.3 Accessing the Pacer Mode

To access the Pacer mode, choose any of the following ways:

- Select the **Defib/Pacer** quick key → select the **Pacer** tab.
- In the **AED** window, select the **Pacer** tab.
- In the Manual Defib window, select the **Pacer** tab.

In the Pacer mode, the **Pacer** window is displayed, all parameters except Resp are monitored. Alarms are automatically turned on.

## 8.4 Pacer Window Display

The following figure shows the **Pacer** window.

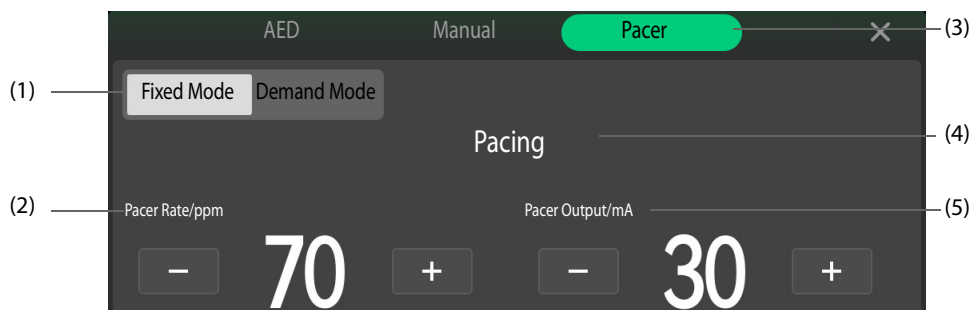

- |                    |                    |
|--------------------|--------------------|
| (1) Pacer mode     | (2) Pacer rate     |
| (3) Operating mode | (4) Prompt message |
| (5) Pacer output   |                    |

## 8.5 Choosing the Pacer Mode Setting

Two pacer mode settings are available: demand pacing and fixed mode pacing.

- For demand pacing, the pacer only delivers pace pulses when the patient's heart rate is lower than the selected pacer rate.
- For fixed pacing, the pacer delivers pace pulses at the selected rate.

You can change the pacing mode setting during the pacing. Changing the pacing mode setting does not stop the pacing, the equipment continues to deliver pacing pulses at selected pacer rate and pacer output.

## NOTE

- Use the demand mode pacing whenever possible. Only use the fixed mode pacing when there are interferes causing R-wave unreliable or no available ECG electrodes.

### 8.5.1 Demand Mode Pacing Procedure

To perform demand mode pacing, follow this procedure:

1. Access the patient and make sure the patient is suitable for the demand mode pacing.
2. Connect the therapy cable to the equipment, and then connect the therapy cable and electrode pads. For information, see 4.2 *Connecting the Therapy Cable* and 4.3 *Connecting the Multifunction Electrode Pads*.
3. Prepare the patient skin. For more information, see 4.7 *Preparing the Patient for Electrode Application*.
4. Apply the ECG electrodes to the patient. For more information, see 11.4.2 *Applying ECG Electrodes*.
5. Access the Pacer mode, and select **Demand Mode** in the **Pacer** window.
6. Select a lead with an easily detectable R-wave.
7. Check that a white R-wave marker appears above each R-wave. If the R-wave markers do not appear or do not coincide with the R-waves, for example above the T-waves, select another lead.
8. If needed, change settings of **Pacer Rate** and **Pacer Output**.
9. Select **Start Pacing** to start pacing. The prompt “**Pacing**” is displayed.
10. Check that white pacing markers appear on the ECG waveform.



(1) R-wave marker

(2) Pacing marker

11. Adjust the pacer output until cardiac capture occurs (capture is indicated by the appearance of a QRS complex after each pace marker), and then decrease the output to the lowest level that still maintains capture.
12. Select and hold **4:1** to temporarily pause pacing.
13. Use the patient’s femoral artery, right brachial or radial artery for palpating pulse, make sure the presence of a peripheral pulse. Releasing **4:1** can resume pacing.
14. Select **Stop Pacing** to stop pacing.

If you stop pacing, selecting **Start Pacing** can resume pacing.

## CAUTION

- Routinely assess the patient’s cardiac output.

## NOTE

- Pacing will not start if there is a problem with the pads cable connection, pad patient connection, or ECG monitoring electrodes connection. If any situation occurs, a message will appear in the pacer information area to alert you that a lead is disconnected or that the electrode pads have a poor connection.

## 8.5.2 Fixed Mode Pacing Procedure

To perform fixed mode pacing, follow this procedure:

1. Access the patient and make sure the patient is suitable for the fixed mode pacing.
2. Connect the therapy cable to the equipment, and then connect the therapy cable and electrode pads. For information, see 4.2 *Connecting the Therapy Cable* and 4.3 *Connecting the Multifunction Electrode Pads*.
3. Prepare the patient skin. For more information, see 4.7 *Preparing the Patient for Electrode Application*.
4. Apply the ECG electrodes to the patient. For more information, see 11.4.2 *Applying ECG Electrodes*.
5. Access the Pacer mode, and select **Fixed Mode** in the **Pacer** window.
6. Select a lead.
7. Change settings of **Pacer Rate** and **Pacer Output**.
8. Select **Start Pacing** to start pacing. The prompt “**Pacing**” is displayed.
9. Check that white pacing markers appear on the ECG waveform.



(1) Pacing marker

10. Adjust the pacer output until cardiac capture occurs (capture is indicated by the appearance of a QRS complex after each pace marker), and then decrease the output to the lowest level that still maintains capture.
11. Select and hold **4:1** to temporarily pause pacing.
12. Use the patient's femoral artery, right brachial or radial artery for palpating pulse, make sure the presence of a peripheral pulse. Releasing **4:1** can resume pacing.
13. Select **Stop Pacing** to stop pacing.

If you stop pacing, selecting **Start Pacing** can resume pacing.

### NOTE

- For fixed mode pacing, R-wave markers do not appear on the paced beats.

## 8.6 Changing Pacing Settings

Pacing settings can only be changed in the Configuration mode only. For more information, see 22.7.2.3 *Pacer Setup Tab*.



## 9 Monitoring Preparation

---

### 9.1 Starting Monitoring a Patient

After turning on the equipment, follow this procedure to monitor a patient:

1. Access the Monitor mode in either of the following ways:
  - ◆ If **Default Startup Mode** is set to **Monitor**, the equipment automatically enters the Monitor mode after turned on. The setting of **Default Startup Mode** can be changed in the Configuration mode only. For more information, see 22.7.1 *General Setup Menu*.
  - ◆ In any therapy window, select .
2. Edit the current patient information.
3. Check patient settings, alarm limits, patient category, paced status and so on, are appropriate for your patient.
4. Change parameter settings if needed.
5. Perform desired measurements. For more information, see corresponding chapter of parameter measurements.

### 9.2 Defining the Monitoring Display

#### 9.2.1 Choosing the Screen

To choose a screen, follow this procedure:

1. Access the screen option in either of the following ways:
  - ◆ Select the **Switch View** quick key.
  - ◆ Select the **Main Menu** quick key → from the **Display** column select **Screen Setup**.
2. Select the desired screen.
  - ◆ **Normal Screen**: is most frequently used for patient monitoring.
  - ◆ **Big Numerics**: displays parameter numerics in big font size.

#### 9.2.2 Setting the Switch for a Parameter

You can manually switch on or off a parameter. If a parameter is switched off, the equipment stops data acquisition and alarming for this measurement.

To set the switch for a parameter, follow this procedure:

1. Select the **Main Menu** quick key → from the **Display** column select **Screen Setup**.
2. Select the **Parameters On/Off** tab.
3. Set the switch of a desired parameter.

#### NOTE

- **When a parameter is manually switched off, you cannot monitor this parameter even if related accessories are connected.**
-

### 9.2.3 Defining the Normal Screen Display

You can configure the parameter numerics, waveforms, and their sequence displayed on the normal screen.

To define the normal screen display, follow this procedure:

1. Select the **Main Menu** quick key → from the **Display** column select **Screen Setup**.
2. Select the **Tile Layout** tab.
3. Select a parameter numeric area or waveform area, and then select the desired item from the popup list. The parameters and waveforms unselected will not be displayed.

#### NOTE

- 
- **ECG waveform and numerics are always displayed on the first line of the parameter waveform area and numeric area.**
- 

### 9.2.4 Defining the Big Numerics Screen

To define the big numerics screen display, follow this procedure:

1. Select the **Main Menu** quick key → from the **Display** column select **Screen Setup**.
2. Select the **Big Numerics** tab
3. Select a parameter numeric area or waveform area, and then select the desired item from the popup list.

### 9.2.5 Displaying the Parameter List

You can display trends of HR, SpO<sub>2</sub>, RR, and NIBP in the parameter numeric area.

To display the parameter list, follow this procedure:

1. Select the **Main Menu** quick key → from the **Display** column select **Screen Setup**.
2. Select the **Tile Layout** tab.
3. Select the desired parameter numeric area, and then select **Parameter List** from the popup list.

### 9.2.6 Changing Measurement Colors

You can set the color of measurement values and waveforms for each parameter. The settings can be changed in the Configuration mode only. For more information, see 22.7.4.1 *General Setup Tab*.

## 9.3 Freezing Parameter Waveforms

In the Monitor mode, you can freeze the currently displayed waveforms on the screen so that you understand the patient condition. Besides this, you can also select any frozen waveform for printing.

### 9.3.1 Freezing Waveforms

To freeze waveforms, select the **Freeze** quick key in the Monitor mode. All displayed waveforms stop refreshing and scrolling after you select the **Freeze** quick key. All parameter numerics are refreshing.

### 9.3.2 Viewing Frozen Waveforms

To view the frozen waveforms, select < or > in the **Freeze** window.

At the lower right corner of the bottommost waveform displays the frozen time. "0.0s" is set to the frozen time. With the waveforms scrolling, the freeze time changes at an interval of a second. For example, -2 s means the two seconds before the frozen time. This change will be applied for all waveforms on the screen.

#### NOTE

- 
- **You can view the frozen waveforms of up to 120 seconds.**
-

### **9.3.3 Unfreezing Waveforms**

To unfreeze the frozen waveforms, select  in the **Freeze** window.

### **9.3.4 Printing Frozen Waveforms**

To print the frozen waveforms, select  in the **Freeze** window.

## **9.4 Stopping Monitoring a Parameter**

To stop monitoring a parameter, follow this procedure:

1. Remove corresponding sensors from the patient.
2. Disconnect the sensor from the patient cable.
3. Disconnect the patient cable from the parameter connector.
4. If you are using the disposable sensor, discard it.

**This page intentionally left blank.**

# 10 Alarms

## 10.1 Alarm Introduction

### 10.1.1 Alarm Categories

The equipment provides two types of alarms: physiological alarms and technical alarms.

- Physiological alarms are triggered by patient measurement exceeding the parameter limits, or by an abnormal patient conditions.
- Technical alarms are triggered by an electrical, mechanical, or other equipment failure, or by failure of sensors or components. Technical alarm conditions may also be caused when an algorithm cannot classify or interpret the available data.
  - ◆ System technical alarms: provides technical alarm related to the main control system, patient monitoring and pacing.
  - ◆ Special technical alarms: provides technical alarms when a critical fault is occurred. These alarms require a special attention and need to be immediately resolved. For more information, see *D.2.12 Special Technical Alarm Messages*.

Apart from the physiological and technical alarms, the equipment can also prompt some messages telling the system status or patient status.

### 10.1.2 Alarm Priorities

By severity, the alarms are classified into the following priority levels:

- High priority alarm: indicates a life threatening situation or a severe device malfunction. High priority alarms require an immediate response.
- Medium priority alarm: indicates abnormal vital signs or a device malfunction. Medium priority alarms require a prompt response.
- Low priority alarm: indicates a discomfort condition, a device malfunction, or an improper operation. Low priority alarms require you to be aware of this condition.
- Prompt message: provides additional information on the patient or the equipment.

### 10.1.3 Alarm Indications

When an alarm occurs, the equipment indicates it to you through visual or audible alarm indications.

The following table lists the detailed indications.

Alarm Indication		High Priority Alarm	Medium Priority Alarm	Low Priority Alarm	Prompt Message
Alarm lamp		Red, flashing frequency of 1.4 to 2.8 Hz, duty ratio of 20 to 60%	Yellow, flashing frequency of 0.4 to 0.8 Hz, duty ratio of 20 to 60%	Yellow, no flashing, duty ratio of 100%	None
Audible tone pattern	Special alarm sound	Repeat pattern of high-pitched single beep	None	None	None
	ISO	Repeat pattern of triple + double + triple + double beeps	Repeat pattern of triple beeps	Repeat pattern of single beep	None
	ISO2	Repeat pattern of triple + double + triple + double beeps	Repeat pattern of triple beeps	Repeat pattern of single beep	None
Alarm message		White text inside a red box	Black text inside a yellow box	Black text inside a yellow box	White text

Alarm Indication	High Priority Alarm	Medium Priority Alarm	Low Priority Alarm	Prompt Message
Alarm priority	!!!	!!	!	None
Parameter numeric	White text inside a flashing red box	Black text inside a flashing yellow box	Black text inside a flashing yellow box	None

## NOTE

- When multiple alarms of different priority levels occur simultaneously, the equipment selects the alarm of the highest priority to light the alarm lamp and issue the alarm tone.
- When multiple alarms of different priority levels occur simultaneously and should be displayed in the same area, the equipment only displays the messages of the highest priority alarm.
- When multiple physiological alarms of different priority levels occur simultaneously and should be displayed in the same area, the equipment displays the high priority alarm, while the medium and low priority alarms are displayed circularly.
- When multiple alarms of the same priority levels occur simultaneously, alarm messages are displayed circularly.
- Lethal arrhythmia alarms, apnea, and SpO<sub>2</sub> Desat are exclusive high priority alarms. When these alarms occur, the equipment only displays messages of exclusive alarms. Other high priority alarms will not be displayed. When multiple exclusive alarms occur simultaneously, alarm messages are displayed circularly.

### 10.1.4 Alarm Status Symbols

Except the alarm indications described in *10.1.3 Alarm Indications*, the following symbols in the alarm status area indicate the alarm status:



Alarm pause: indicates that all the alarms are paused.



Alarm off: indicates that individual measurement alarms are turned off or the system is in the alarm off status.



Audio pause: indicates that audible alarm tones are paused.



Audio off: indicates that audible alarm tones are turned off.



Alarm reset: indicates that the alarm system is reset.

## 10.2 Alarm Safety Information

### WARNING

- A potential hazard can exist if different alarm presets and default configuration settings are used for the same or similar equipment in the same care area, for example an intensive care unit or cardiac operating room.
- The equipments in the care area may each have different alarm settings to suit different patients. Before starting monitoring, check that the alarm settings are appropriate for the patient. Always make sure that necessary alarm limits are active and set according to the patient's clinical condition.
- Setting alarm limits to extreme values may cause the alarm system to become ineffective. For example, high oxygen levels may predispose a premature infant to retrolental fibroplasia. Setting the SpO<sub>2</sub> high alarm limit to 100% is equivalent to switching the alarm off the SpO<sub>2</sub> alarm.

- **When the alarm sound is switched off, the equipment gives no alarm tones even if a new alarm occurs. Be careful about whether to switch off the alarm sound or not. When the alarms are off or while alarm audio is paused either temporarily or indefinitely, observe the patient frequently.**
- **When monitoring patients that are not continuously attended by a clinical operator, properly configure the alarm system and adjust alarm settings as per the patient's condition.**
- **Do not exclusively rely on audible alarms for patient monitoring. Adjusting alarm volume to a low level or turning off alarm sound may result in patient hazards. Always make sure that the audio alarm volume level is adequate in your care environment. Always keep the patient under close surveillance.**

## NOTE

- **In case of a temporary power failure, the equipment will save the alarms triggered before the power failure. The information of saved alarms is unchanged saved after the power failure.**

## 10.3 Viewing the Alarms

The alarm information area with “...” indicate there are more than one alarms at the same time. You can view the alarms from the alarm list. To do so, follow this procedure:

1. Select the alarm information area to enter the **Alarms** window.
2. Select the desired alarm category tab.
3. Select the desired alarm from the alarm list. The alarm messages followed by “**Detail**” include help messages or pictures to help you identify the problem.

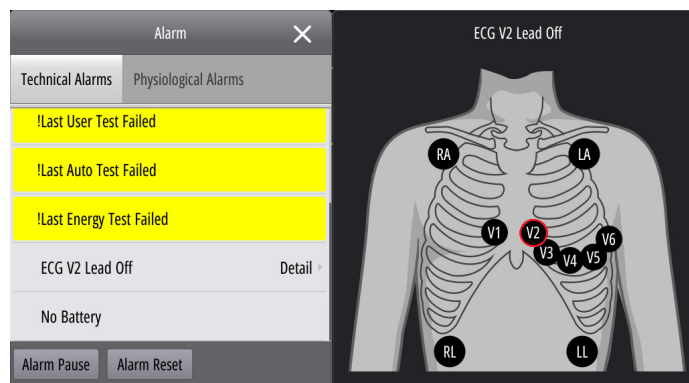

## 10.4 Changing Alarm Settings

### 10.4.1 Initiating Auto Alarm Limits

The equipment provides the auto alarm limits function to automatically adjust alarm limits according to the patient's vital signs. When the auto limits function is enabled, the equipment calculates safe auto limits based on the latest measured values. To get accurate auto alarm limits, you need to collect a set of measured vital signs as a baseline.

To initiate auto alarm limits, follow this procedure:

1. Select the **Main Menu** quick key → from the Alarm column select **Limits**.
2. Select **Auto Limits** at the bottom.
3. Select **OK**.

Then the equipment will automatically calculate alarm limits based on the latest measured values. Before applying these automatically created alarm limits, confirm if they are appropriate for your patient from the Alarm Limits setup menu. If not, you can adjust them manually. These alarm limits will remain unchanged until you select auto limits again or adjust them manually.

The equipment calculates auto limits based on the following rules:

Module	Parameter	Patient Category	Lower Limit	Upper Limit	Auto Limit Range
ECG	HR/PR (bpm)	Adult	$HR \times 0.8$ or 40 (whichever is greater)	$HR \times 1.25$ or 240 (whichever is smaller)	35 to 240
		Pediatric	$HR \times 0.8$ or 40 (whichever is greater)	$HR \times 1.25$ or 240 (whichever is smaller)	35 to 240
		Neonate	$(HR - 30)$ or 90 (whichever is greater)	$(HR + 40)$ or 200 (whichever is smaller)	55 to 225
Resp	RR (rpm)	Adult	$RR \times 0.5$ or 6 (whichever is greater)	$(RR \times 1.5)$ or 30 (whichever is smaller)	6 to 55
		Pediatric	$RR \times 0.5$ or 6 (whichever is greater)	$(RR \times 1.5)$ or 30 (whichever is smaller)	6 to 55
		Neonate	$(RR - 10)$ or 30 (whichever is greater)	$(RR + 25)$ or 85 (whichever is smaller)	10 to 90
SpO2	SpO2 (%)	All	Same as the default alarm limit	Same as the default alarm limit	Same as the measurement range
NIBP	NIBP-S (mmHg)	Adult	$(SYS \times 0.68 + 10)$	$(SYS \times 0.86 + 38)$	45 to 270
		Pediatric	$(SYS \times 0.68 + 10)$	$(SYS \times 0.86 + 38)$	45 to 185
		Neonate	$(SYS - 15)$ or 45 (whichever is greater)	$(SYS + 15)$ or 105 (whichever is smaller)	35 to 115
	NIBP-D (mmHg)	Adult	$(Dia \times 0.68 + 6)$	$(Dia \times 0.86 + 32)$	25 to 225
		Pediatric	$(Dia \times 0.68 + 6)$	$(Dia \times 0.86 + 32)$	25 to 150
		Neonate	$(Dia - 15)$ or 20 (whichever is greater)	$(Dia + 15)$ or 80 (whichever is smaller)	20 to 90
	NIBP-M (mmHg)	Adult	$(Mean \times 0.68 + 8)$	$(Mean \times 0.86 + 35)$	30 to 245
		Pediatric	$(Mean \times 0.68 + 8)$	$(Mean \times 0.86 + 35)$	30 to 180
		Neonate	$(Mean - 15)$ or 35 (whichever is greater)	$(Mean + 15)$ or 95 (whichever is smaller)	25 to 105
CO2	EtCO2 (mmHg)	All	0 to 32: remains the same	0 to 32: remains the same	Same as the measurement range
			33 to 35: 29	33 to 35: 41	
			36 to 45: $(EtCO_2 - 6)$	36 to 45: $(EtCO_2 + 6)$	
	FICO2	All	None	Same as the default alarm limit	Same as the measurement range
awRR (rpm)	Adult	Pediatric	awRR $\times 0.5$ or 6 (whichever is greater)	awRR $\times 1.5$ or 30 (whichever is smaller)	6 to 55
					6 to 55
					10 to 90

## 10.4.2 Setting Parameter Alarm Properties

To set parameter alarm properties, follow this procedure:

1. Select the **Main Menu** quick key → from the **Alarm** column select **Limits**.
2. Select a parameter tab and set alarm properties as desired.

You can also change the alarm properties of individual parameter from corresponding parameter menu.



### 10.4.3 Restoring the Default Alarm Settings

To reset all alarm settings to the defaults, follow this procedure:

1. Select the **Main Menu** quick key → from the **Alarm** column select **Limits**.
2. Select **Defaults** at the bottom.

### 10.4.4 Setting Alarm Tone Properties

#### 10.4.4.1 Changing the Alarm Volume

To change the alarm volume, follow this procedure:

1. Select the **Main Menu** quick key → from the **Alarm** column select **Setup**.
2. Set **Alarm Volume**. The optional alarm volume is between X to 10, in which X is the minimum volume, depending on the setting of minimum alarm volume, and 10 is the maximum volume.
3. Set **High Alarm Volume**.
4. Set **Reminder Volume**.

#### NOTE

- When Alarm Volume is set to 0, the alarm sound is turned off and  is displayed in the alarm status area.
- You cannot set the volume of high priority alarms if Alarm Volume is set to 0.

#### 10.4.4.2 Password Protected Audio Alarm Settings

The following alarm settings are password protected:

- Minimum alarm volume
- Alarm sound pattern
- Alarm interval
- Alarm sound escalation switch and delay

These settings can be changed in the Configuration mode only. For more information, see 22.7.3 Alarm Setup Menu.

#### 10.4.4.3 Enabling Special Alarm Sound

To enable special alarm sound, set **Alarm Sound** to **ISO2**. The switch setting of **Alarm Sound** can be changed in the Configuration mode only. For more information, see 22.7.3 Alarm Setup Menu.

When any of the following alarms is triggered, the equipment gives special alarm sound to indicate that the patient may be in a critical condition.

- Lethal arrhythmias, including Asystole, V-Fib/V-Tach, V-Tach, Vent Brady, Extreme Tachy, and Extreme Brady
- SpO2 Desat
- Apnea

### 10.4.5 Setting the Alarm Delay Time

For continuously measured parameters, you can set the alarm delay time. If the alarm condition is resolved within the delay time, the equipment does not present the alarm. The setting of **Alarm Delay** can be changed in the Configuration mode only. For more information, see 22.7.3 Alarm Setup Menu.

The setting of **Alarm Delay** is not applied to the apnea alarms and the ST alarms. You can set **Apnea Delay** and **ST Alarm Delay** separately. The setting of **ST Alarm Delay** can be changed in the Configuration mode only. For more information, see 22.7.3 Alarm Setup Menu.

To set the apnea delay time, follow this procedure:

1. Select the **Main Menu** quick key → from the **Alarm** column select **Setup**.

2. Select **Apnea Delay** to set the apnea delay time.

---

---

## WARNING

---

- **The alarm delay time can be set to a maximum of 15 seconds. Changing this setting to an inappropriate level could result in a hazard to the patient.**
- 
- 

### 10.4.6 Setting the Switch of SpO<sub>2</sub> Desat Alarm Off

You can choose whether switching off the SpO<sub>2</sub> Desat alarm is permissible or not. The setting of **SPO2 Desat Alarm Off** can be changed in the Configuration mode only. For more information, see 22.7.3 *Alarm Setup Menu*.

---

---

## WARNING

---

- **If you switch off the SpO2 Desat alarm, the equipment will not alarm when the patient's SpO<sub>2</sub> is extremely low. This may result in a hazard to the patient. Always keep the patient under close surveillance.**
- 
- 

### 10.4.7 Setting the Switch of Apnea Alarm Off

You can choose whether switching off the apnea alarm is permissible or not. The setting of **Apnea Alarm Off** can be changed in the Configuration mode only. For more information, see 22.7.3 *Alarm Setup Menu*.

---

---

## WARNING

---

- **If you switch off the apnea alarm, the equipment will not issue the apnea alarm in case that apnea happens. This may result in a hazard to the patient. Keep the patient under close surveillance.**
- 
- 

### 10.4.8 Setting the Length of Printed Waveforms

You can define the length of printed waveforms when an alarm is triggered. To do so, follow this procedure:

1. Select the **Main Menu** quick key → from the **Alarm** column select **Setup**.
2. Set **Printing Duration On Alarm**.

## 10.5 Pausing Alarms

### 10.5.1 Defining the Alarm Pause Function

If the pause function is designated as pausing alarms, selecting **Alarm Pause** from the alarm list can temporarily disable alarm indications. The setting of **Pause** can be changed in the Configuration mode only. For more information, see 22.7.3 *Alarm Setup Menu*.

When alarms are paused, the following rules are followed:

- No physiological alarm will be presented.
- Except special technical alarms, sounds of other technical alarms are paused, but alarm lamps and alarm messages remain presented.
- The remaining alarm pause time is displayed in the alarm information area.
-  is displayed in the alarm status area.

When the alarm pause time expires, the alarm paused status is automatically deactivated. You can also cancel the alarm paused status by selecting **Alarm Pause** from the alarm list.

---

---

## WARNING

---

- **Pausing alarms may result in a hazard to the patient.**
- 
-

## 10.5.2 Password Protected Alarm Pause Settings

The following alarm pause settings are password protected.

- Alarm pause time
- Priorities of paused alarms

These settings can be changed in the Configuration mode only. For more information, see *22.7.3 Alarm Setup Menu*.

### NOTE

- **Prolonging alarm pause time does not affect the setting of alarm pause time.**

## 10.6 Switching Off All Alarms

If the pause function is designated as pausing alarms, and **Pause Time** is set to **Permanent**, selecting **Alarm Pause** from the alarm list can permanently switch off all alarms. The settings of **Pause** and **Pause Time** can be changed in the Configuration mode only. For more information, see *22.7.3 Alarm Setup Menu*.

When alarms are switched off, the following rules are followed:

- Physiological alarms are switched off. The alarm lamp does not flash and alarm sound is not issued.
- Except special technical alarms, sounds of other technical alarms are switched off, but alarm lamp flashes and alarm messages remain presented.
- The message **"Alarm Off"** with red background is displayed in the alarm information area.
-  is displayed in the alarm status area.

To exit the alarm off status, select **Alarm Pause** from the alarm list again.

### WARNING

- **Switching off alarms may result in a hazard to the patient.**

## 10.7 Pausing Alarm Sounds

### 10.7.1 Defining the Alarm Sound Pause Function

If the pause function is defined as **Audio Pause**, selecting **Audio Pause** from the alarm list can pause alarm tones. When alarm tones are paused, the following rules are followed:

- The sounds of all physiological alarms are switched off.
- Except special technical alarms, sounds of other technical alarms are switched off.
- The remaining audio pause time is displayed in the alarm information area.
-  is displayed in the alarm status area.

When the audio pause time expires, the audio paused status is automatically deactivated. You can also cancel the audio paused status by selecting **Audio Pause** from the alarm list.

### WARNING

- **Pausing alarm sounds may result in a hazard to the patient.**

### 10.7.2 Password Protected Alarm Sound Pause Settings

The following alarm sound pause settings are password protected.

- Alarm tone pause time
- Priorities of paused alarms

These settings can be changed in the Configuration mode only. For more information, see 22.7.3 Alarm Setup Menu.

## 10.8 Switching Off Alarm Sounds

If the pause function is defined as **Audio Pause**, and **Pause Time** is set to **Permanent**, selecting **Audio Pause** can permanently switch off all alarm sounds. The settings of **Pause** and **Pause Time** can be changed in the Configuration mode only. For more information, see 22.7.3 Alarm Setup Menu.

When alarm sounds are switched off, the following rules are followed:

- The sounds of all physiological alarms are switched off.
- Except special technical alarms, sounds of other technical alarms are switched off.
- The message “**Alarm Off**” with a red background is displayed in the alarm information area.
-  is displayed in the alarm symbol area.

To exit the audio off status, select **Audio Pause** from the alarm list again.

---

---

### WARNING

---

- **Switching off alarm sounds may result in a hazard to the patient.**
- 
- 

## 10.9 Resetting Alarms

Selecting the **Alarm Reset** from the alarm list can reset the alarm system. When the alarm system is reset, the  is displayed in the alarm status area.

### NOTE

---

- **If a new alarm is triggered after the alarm system is reset,  will disappear, indications of the alarm lamp, alarm tone and alarm messages will be reactivated.**
- 

### 10.9.1 Resetting Physiological Alarms

Physiological alarms give different alarm indications when the alarm system is reset:

- The alarm sound is silenced.
- A √ appears before the alarm message.
- The background color of a parameter numeric corresponds with the alarm priority, but the parameter numeric does not flash.

### 10.9.2 Resetting Technical Alarms

Technical alarms give different alarm indication when the alarm system is reset:

- Some technical alarms are cleared. The equipment gives no alarm indications.
- Some technical alarms are changed to the prompt messages.
- Except special technical alarms, other technical alarm is silenced and a √ appears before the alarm message.

For details about the indications of technical alarms when the alarm system is reset, see *D.2 Technical Alarm Messages*.

## 10.10 Latching Alarms

The latching setting for physiological alarms defines how alarm indications behave if you do not reset the alarms.

- If you do not “latch” physiological alarms, their alarm indications disappear when the alarm condition is eliminated.
- If you “latch” physiological alarms, all visual and audible alarm indications remain until you reset the alarms. For latched alarms the time when the alarm is last triggered is displayed behind the alarm message.

You can separately latch visual indications or simultaneously latch the visual and the audible indications.

- When visual indications are latched, visual indications, including alarm lamp, alarm message and its background remain when the alarm condition is eliminated and the time when the alarm last triggered is displayed behind the alarm message.
- When audible indications are latched, the equipment issues alarm sounds when the alarm condition is eliminated.

The alarm latch settings can be changed in the Configuration mode only. For more information, see *22.7.3 Alarm Setup Menu*.

### NOTE

- 
- **Changing alarm priority may affect the latching status of corresponding alarm. Determine if you need to reset the alarm latching status if you changed the alarm priority.**
  - **When the alarm system is reset, latched physiological alarms are cleared.**
- 

## 10.11 Testing Alarms

The equipment automatically performs an auto test at startup. Check that an alarm tone is heard, the alarm lamp illuminates in red, and then turns yellow, and finally turns off. This indicates that the visible and audible alarm indications function correctly.

## 10.12 Actions When an Alarm Occurs

When an alarm occurs, observe the following steps and take proper actions:

1. Check the patient’s condition.
2. Confirm the alarming parameter or alarm category.
3. Identify the source of the alarm.
4. Take proper action to eliminate the alarm condition.
5. Make sure the alarm condition is corrected.

For more information, see *D Alarm Messages*.

**This page intentionally left blank.**

# 11 Monitoring ECG

## 11.1 ECG Introduction

The electrocardiogram (ECG) measures and records the electrical activity of the heart. The equipment provides ECG monitoring through ECG electrodes (3-lead, 5-lead, 12-lead), electrode pads or external paddles, also provide arrhythmia analysis, ST-segment analysis, and QT/QTc measurements.

ECG monitoring is intended for adult, pediatric, and neonatal patients.

## 11.2 ECG Safety Information

### WARNING

- ECG monitoring provided by this equipment is not intended for direct cardiac application.
- Make sure the conductive parts of electrodes and associated connectors, including the neutral electrode, do not contact any other conductive parts including earth.
- Use defibrillation-proof ECG cables during defibrillation.
- Do not touch the patient or metal devices connected to the patient during defibrillation.
- To reduce the hazard of burns during high-frequency surgical procedure, ensure that cables and transducers connected to the equipment never come into contact with the electrosurgery unit (ESU).
- To reduce the hazard of burns during use of high-frequency surgical unit (ESU), the ECG electrodes should not be located between the surgical site and the ESU return electrode.

### CAUTION

- Periodically inspect the electrode application site to ensure skin integrity. If the skin quality changes, replace the electrodes or change the application site.
- Interference from ungrounded instrument near the patient and electrosurgery interference can induce noise and artifact into the waveforms.
- If selected lead cannot provide valid ECG signals, a dash line is shown in the ECG waveform area.

## 11.3 ECG Display

The following figures show the ECG waveform and numeric areas.

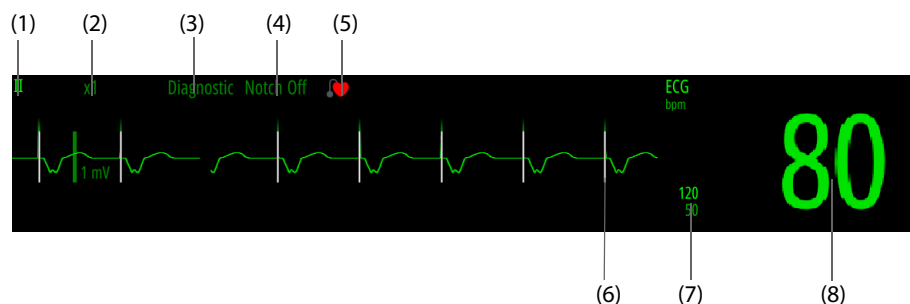

(1) ECG lead label

(2) ECG waveform gain

(3) ECG filter mode

(4) Notch filter status

(5) Paced status: If **Paced** is set to **Yes**,  is displayed. If **Paced** is set to **No**,  is displayed.

(6) Pace pulse mark: If **Paced** is set to **Yes**, the pace pulse markers “|” are displayed corresponding to detected pace pulse on each ECG waveform.

(7) HR alarm limits

(8) HR value

## NOTE

---

- **The ECG numeric area and waveform area are configured to be different for different lead type and ECG settings.**
- 

## 11.4 Preparing for ECG Monitoring

You can use ECG electrodes, electrode pads or external paddles for ECG monitoring. This section only describes ECG monitoring by using the ECG electrodes. For details about preparations for electrode pads and external paddles, see *4 Therapy Preparation*.

## NOTE

---

- **The external paddles are not recommended for ECG monitoring.**
- 

### 11.4.1 Preparing the Patient for Electrode Application

Proper skin preparation is necessary to ensure good signal quality at the electrode sites, as the skin is a poor conductor of electricity.

To properly prepare the skin, follow this procedure:

1. Shave hair from skin at chosen electrode sites.
2. Gently rub skin surface at sites to remove dead skin cells.
3. Thoroughly cleanse the site with a mild soap and water solution.
4. Dry the skin completely before applying electrodes.

---

## CAUTION

---

- **Proper skin preparation is necessary for good signal quality at the electrode site, as the skin is a poor conductor of electricity.**
- 

### 11.4.2 Applying ECG Electrodes

To connect ECG electrodes, follow this procedure:

1. Check that electrode packages are intact and the ECG electrodes are not expiry. Make sure the electrode gel is moist. If you are using snap leadwires, attach the ECG electrodes to the leadwires before placing electrodes on the patient.
2. Place the ECG electrodes on the prepared sites. Make sure that all electrodes have good skin contact.
3. Connect the leadwires to the patient cable if not already connected.
4. Plug the patient cable into the ECG connector.

## NOTE

---

- **Store the electrodes at room temperature.**
  - **Only open the electrode package immediately prior to use.**
  - **Never mix patient electrode types or brands. This may lead to problem due to impedance mismatch.**
  - **When applying the electrodes, avoid bony area, obvious layers of fat, and major muscles. Muscle movement can result in electrical interference. Applying electrodes on major muscles, for example on muscles of the thorax, may lead to erroneous arrhythmia alarms due to excessive muscle movement.**
-



### 11.4.3 Electrode Color Coding

The following table lists the color coding of electrodes for both AHA and IEC standards:

Lead	IEC		AHA	
	Label	Color	Label	Color
Right arm	R	Red	RA	White
Left arm	L	Yellow	LA	Black
Right leg (neutral)	N	Black	RL	Green
Left leg	F	Green	LL	Red
Chest 1	C1	White/Red	V1	Brown/Red
Chest 2	C2	White/Yellow	V2	Brown/Yellow
Chest 3	C3	White/Green	V3	Brown/Green
Chest 4	C4	White/Brown	V4	Brown/Blue
Chest 5	C5	White/Black	V5	Brown/Orange
Chest 6	C6	White/Violet	V6	Brown/Violet

### 11.4.4 ECG Electrode Placement

In this section, electrode placement is illustrated using the AHA naming convention.

#### 11.4.4.1 3-Lead Electrode Placement

3-lead electrode placement is as follows:

- RA: just below the clavicle and near the right shoulder.
- LA: just below the clavicle and near the left shoulder.
- LL: below the lower left edge of the rib cage.

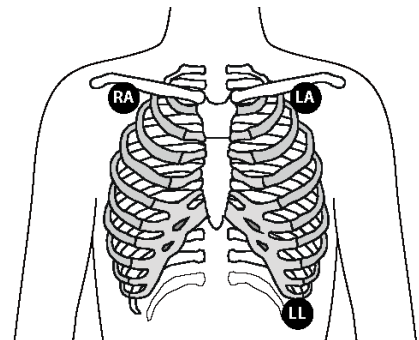

#### 11.4.4.2 5-Lead Electrode Placement

5-lead electrode placement is as follows:

- RA: just below the clavicle and near the right shoulder.
- LA: just below the clavicle and near the left shoulder.
- RL: below the lower right edge of the rib cage.
- LL: below the lower left edge of the rib cage.
- V: any of V1 to V6 on the chest.

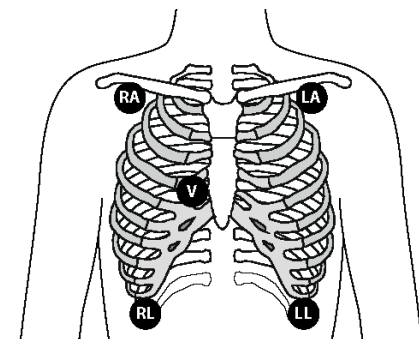

### 11.4.4.3 Chest Electrode Placement

The chest electrode can be placed at the following positions:

- V1: on the fourth intercostal space at the right border of sternal.
- V2: on the fourth intercostal space at the left border of sternal.
- V3: midway between V2 and V4.
- V4: on the fifth intercostal space on the left midclavicular line.
- V5: on the left anterior axillary line at the same horizontal level as V4.
- V6: on the left midaxillary line at the same horizontal level as V4 and V5.

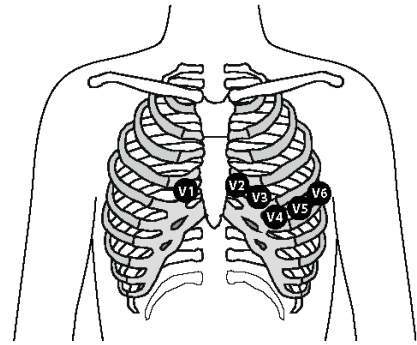

#### NOTE

- For the 5-lead electrode placement, place the precordial electrode according to the physician's preference.

### 11.4.4.4 12-Lead Electrode Placement

12-lead ECG monitoring uses 10 electrodes, which are placed on the patient's four limbs and chest.

The picture at the right side shows the placement of limb electrodes. However, you can place the limb electrodes anywhere along the limbs.

- RA: above the right wrist, inside the right arm, and below the elbow.
- LA: above the left wrist, inside the left arm, and below the elbow.
- RL: above the right ankle, inside the right leg, and below the knee.
- LL: above the left ankle, inside the left leg, and below the knee.

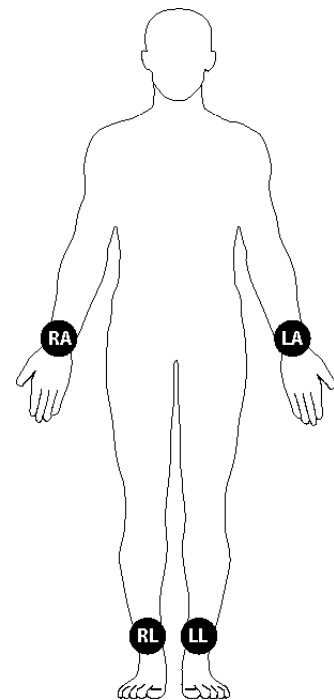

The chest electrodes can be placed according to the physician's preference. For details about the placement of chest electrodes, see 11.4.4.3 *Chest Electrode Placement*.

### 11.4.4.5 Lead Placement for Surgical Patients

The surgical site should be taken into consideration when placing electrodes on a surgical patient. For example, for open-chest surgery, the chest electrodes can be placed on the lateral chest or back. To reduce artifacts and interference from electrosurgical units, you can place the limb electrodes close to the shoulders and lower abdomen and the chest electrodes on the left side of the mid-chest. Do not place the electrodes on the upper arm. Otherwise, the ECG waveform will be very small.

#### WARNING



- To reduce the hazard of burns during use of electrosurgical units (ESU), the ECG electrodes should not be located between the surgical site and the ESU return electrode.
- Never entangle the ESU cable and the ECG cable together.
- If the ESU is used, do not place ECG electrodes near the grounding plate of the ESU. Otherwise interference on ECG signals may occur.

## 11.4.5 Choosing the ECG Lead Type

To choose ECG lead type, follow this procedure:

1. Select the ECG numeric area or waveform area to enter the **ECG** menu.
2. Select the **Setup** tab.
3. Set **Lead Set** according to the lead type you are going to use. The default lead type is **Auto**. In this case, the equipment automatically detects the lead type.

## 11.4.6 Checking Paced Status

You should check the patient's paced status before monitoring ECG.  is displayed when **Paced** is set to **Yes**. The pace pulse markers “|” are shown on each ECG waveform when the patient has a paced signal. If **Paced** is set to **No** or if the patient's paced status is not selected,  will be shown in the ECG waveform area.

To change the paced status, follow this procedure:

1. Select the ECG numeric area or waveform area to enter the **ECG** menu.
2. Select the **Pacer** tab.
3. Set **Paced**.

If you did not set the paced status, the equipment issues a prompt tone when pace pulse is detected. At the same time,  flashes and the message “**Please check if the patient has a pacemaker.**” appears in the ECG waveform area. Check and set the patient's paced status.

---

### WARNING

---

- **When monitoring a patient implanted with a pacemaker, be sure to select correct paced status. Otherwise, the pace pulses may be counted in the case of cardiac arrest or some arrhythmias. Do not completely rely on the heart rate reading or the heart rate alarms. Always keep paced patients under close surveillance.**
  - **For paced patients, set Paced to Yes. Otherwise the monitor could mistake a pace pulse for a QRS complex and fail to generate alarm when the ECG signal is too weak. On ventricular paced patients, episodes of ventricular tachycardia may not always be detected. Do not rely entirely upon the system's automated arrhythmia detection algorithm.**
  - **False low heart rate or false asystole alarms may result with certain pacemakers because of pacemaker artifacts, such as electrical overshoot of the pacemaker overlapping the true QRS complexes.**
  - **Do not rely entirely on heart rate meter alarms when monitoring patients with pacemakers. Always keep these patients under close surveillance.**
  - **For non-paced patients, you must set Paced to No.**
- 

## 11.4.7 Setting the Switch of Pacer Rejection

The pace pulse rejection function is disabled by default. To set the pacer rejection switch, follow this procedure:

1. Select the ECG numeric area or waveform area to enter the **ECG** menu.
2. Select the **Pacer** tab.
3. Set the switch of **Pacer Reject**.

---

### NOTE

---

- **When pace pulses are detected, the pace pulse marks “|” are shown on the ECG waveforms. Pacer Rejection setting has no impact on the display of pace pulse marks “|”.**
  - **You can switch on pacer rejection only when Paced is set to Yes. If Paced is set to No, the setting of Pacer Reject is disabled.**
-

## 11.5 Changing ECG Settings

### 11.5.1 Setting the ECG Alarm Properties

To set ECG alarm properties, follow this procedure:

1. Select the ECG numeric area or waveform area to enter the **ECG** menu.
2. Select the **Alarm** tab.
3. Set alarm properties as desired.

### 11.5.2 Setting the Analysis Mode

Multiple leads analysis enhances detection sensitivity and reduces false alarms. However, when most leads are noisy or with low amplitude, choosing the optimal lead as calculation lead and single lead analysis is recommended.

To set the ECG analysis mode, follow this procedure:

1. Select the ECG numeric area or waveform area to enter the **ECG** menu.
2. Select the **Setup** tab.
3. Set the **Analysis Mode**.
  - ◆ **Multiple Leads:** four leads (ECG1 to ECG 4) are used as calculation leads.
  - ◆ **Single Lead:** one lead (ECG1) is used as calculation lead.

#### NOTE

---

- It is difficult for the equipment to differentiate an aberrantly conducted beat from a ventricular beat. An aberrantly conducted beat may be misclassified as a ventricular beat. In this case, choose the lead with a narrow R-wave for ECG1 and select Single Lead.
  - When a 3-lead ECG cable is used, the equipment always uses single lead as calculation lead and the Analysis Mode option is not available.
- 

### 11.5.3 Changing ECG Waveform Settings

#### 11.5.3.1 Selecting the Displayed ECG Leads

To select the leads of displayed ECG waveforms, follow this procedure:

1. Select the ECG numeric area or waveform area to enter the **ECG** menu.
2. Select the **Setup** tab.
3. Select **ECG** to set the lead of each ECG waveform.
4. If more than three ECG waveforms are displayed, select the **More Leads** tab, and then select **ECG** to set leads of other ECG waveforms.

The waveform of selected lead should have the following characteristics:

- The QRS complex is tall and narrow.
- The QRS complex is completely above or below the baseline. It should not be biphasic.
- The amplitudes of P waves and T waves are less than 0.2 mV.

#### CAUTION

---

- Ensure that you have selected the optimal leads with the best waveform amplitude and the highest signal-to-noise ratio. Selecting the optimal leads is important for detecting beats, classifying beats, and detecting ventricular fibrillation.
-

### 11.5.3.2 Setting the ECG Waveform Layout

To set the ECG waveform layout, follow this procedure:

1. Select the ECG numeric area or waveform area to enter the **ECG** menu.
2. Select the **Setup** tab.
3. Set **Waveform Layout**.
  - ◆ **Standard**: the waveform sequence is I, II, III, aVR, aVL, aVF, V1, V2, V3, V4, V5, V6.
  - ◆ **Cabrera**: the waveform sequence is aVL, I, -aVR, II, aVF, III, V1, V2, V3, V4, V5, V6.

### 11.5.3.3 Changing ECG Waveform Size

If the ECG waveform is too small or clipped, you can change its size by selecting an appropriate **Gain** setting. To do so, follow this procedure:

1. Select the ECG numeric area or waveform area to enter the **ECG** menu.
2. Select the **Setup** tab.
3. Select **ECG Gain** to set the size of each ECG waveform.
4. If more than three ECG waveforms are displayed, select the **More Leads** tab, and then select **ECG Gain** to change the sizes of other ECG waveforms. If you select **Auto**, the equipment automatically adjusts the size of the ECG waveforms.

### 11.5.3.4 Changing ECG Waveform Speed

To change ECG waveform speed, follow this procedure:

1. Select the ECG numeric area or waveform area to enter the **ECG** menu.
2. Select the **Setup** tab.
3. Set **Speed**.

### 11.5.3.5 Setting the ECG Filter

To set the ECG waveform filter mode, follow this procedure:

1. Select the ECG numeric area or waveform area to enter the **ECG** menu.
2. Select the **Setup** tab.
3. Set **Filter**.
  - ◆ **Diagnostic**: is used when ECG waveform of diagnostic quality is required.
  - ◆ **Monitor**: is used in ECG monitoring.
  - ◆ **Therapy**: is used if ECG signals are distorted by high or low frequency noise. In the operating room, setting **Filter** to **Therapy** can reduce ESU interference. However, during normal ECG monitoring, selecting **Therapy** may suppress certain features or details of the QRS complexes.
  - ◆ **ST**: is recommended for ST monitoring.

### 11.5.3.6 Setting the Switch of Notch Filter

The notch filter removes the line frequency interference. To switch on or off the notch filter, follow this procedure:

1. Select the ECG numeric area or waveform area to enter the **ECG** menu.
2. Select the **Setup** tab.
3. Set the switch of **Notch Filter**.

#### NOTE

- **Notch Filter can only be switched on or off when Filter is set to Diagnostic. In other filter modes, the Notch Filter is always switched on.**

## 11.5.4 Setting the Switch of Smart Lead

The equipment provides the smart lead off function. When the lead of the first ECG wave is detached but another lead is available, the equipment automatically switches to the available lead to recalculate heart rate, and to analyze and detect arrhythmias. When you reconnect the detached leads, the equipment automatically switches back to the original lead.

To set the switch of the smart lead off function, follow this procedure:

1. Select the ECG numeric area or waveform area to enter the **ECG** menu.
2. Select the **Setup** tab.
3. Set the switch of **Smart Lead**.

## 11.5.5 Adjusting the QRS Volume

To adjust the QRS volume, follow this procedure:

1. Select the ECG numeric area or waveform area to enter the **ECG** menu.
2. Select the **Setup** tab.
3. Set **QRS Volume**.

When valid SpO<sub>2</sub> measurements are available, the equipment adjusts the pitch of QRS tone based on the SpO<sub>2</sub> value.

## 11.6 Monitoring Arrhythmia

Arrhythmia monitoring is intended for adult, pediatric, and neonatal patients.

### 11.6.1 Arrhythmia Safety Information

---

---

#### WARNING

- **Heart rate reading may be affected by cardiac arrhythmias. Do not rely entirely on heart rate alarms when monitoring patients with arrhythmia. Always keep these patients under close surveillance.**
  - **The arrhythmia analysis program may incorrectly identify the presence or absence of an arrhythmia. Therefore, a physician must analyze the arrhythmia information with other clinical findings.**
  - **Atrial fibrillation (A-Fib) detection function is not intended for pediatric and neonatal patients.**
- 
- 

#### CAUTION

- **Since the arrhythmia detection algorithm sensitivity and specificity are less than 100%, sometimes there may be some false arrhythmias detected and also some true arrhythmia events may not be detected. This is especially true when the signal is noisy.**
  - **The ECG size affects arrhythmia detection and heart rate calculation sensitivity.**
  - **If QRS amplitude is low, the equipment might not be able to calculate heart rate and false asystole calls may occur.**
  - **During the learning phase of the algorithm, arrhythmia detection may not be available. So you should closely monitor patient condition during and for several minutes after the learning phase to allow the algorithm to reach optimal detection performance.**
- 

### 11.6.2 Arrhythmia Events

This section lists all arrhythmia events and their criteria.

### 11.6.2.1 Lethal Arrhythmia Events

Arrhythmia Message	Description
Asystole	No QRS complex detected within the set time interval in the absence of ventricular fibrillation or chaotic signal.
V-Fib/V-Tach	A fibrillatory wave for 6 consecutive seconds. A dominant rhythm of adjacent PVCs and the ventricular rate is greater than the V-tach rate limit.
V-Tach	The number of consecutive PVCs is greater than or equal to the V-Tach PVCs limit, and the ventricular rate is greater than or equal to the V-Tach rate limit.
Vent Brady	The number of consecutive PVCs is greater than or equal to V Brady PVC limit and the ventricular rate is less than the V Brady Rate limit.
Extreme Tachy	The heart rate is greater than the extreme tachycardia limit.
Extreme Brady	The heart rate is less than the extreme bradycardia limit.

### 11.6.2.2 Nonlethal Arrhythmia Events

Arrhythmia Message	Description
R on T	R on T PVC is detected.
Run PVCs	More than two consecutive PVCs, but lower than the V-Brady PVCs limit, and the ventricular rate is lower than the V-Tach rate limit.
Couplet	A Pair of PVCs detected in between normal beats.
Multiform PVC	Multiform PVCs detected in Multif. PVC's Window (which is adjustable).
PVC	One PVC detected in between normal beats.
Bigeminy*	A dominant rhythm of N, V, N, V, N, V.
Trigeminy*	A dominant rhythm of N, N, V, N, V, N, V.
Tachy	The heart rate is greater than the tachycardia limit.
Brady	The heart rate is lower than the bradycardia limit.
Pacer Not Capture	No QRS complex detected for 300 ms following a pace pulse (for paced patients only).
Pacer Not Pacing	No pace pulse detected for 1.75 x average R-to-R intervals following a QRS complex (for paced patients only).
Missed Beat	At least 3 consecutive Ns, and The current RR interval is greater than 1.5 x previous RR interval, and The next RR interval is lower than 1.5 x average RR interval, and HR lower than 100 and the current RR interval is greater than 1.75 x average RR interval , or HR is greater than or equal to 100 and the current RR interval is greater than 1000 ms.
Nonsus V-Tach	The number of consecutive PVCs is lower than the V-Tach PVCs limit but greater than 2, and the ventricular rate is greater than or equal to the V-Tach Rate limit.
Vent Rhythm	The number of consecutive PVCs is greater than or equal to the V-Brady PVCs limit, and ventricular rate is greater than or equal to the V-Brady Rate limit but lower than V-Tach Rate limit.
Pause	No QRS complex is detected within the set time threshold of pause.
Irr Rhythm	Consistently irregular rhythm (N, irregular RR interval change is greater than 12.5%)
A-Fib	P wave is absent and normal beat RR intervals are irregular.
PVCs/min	PVCs/min exceeds high limit.
Pauses/min	Pauses/min exceeds high limit.
Irr Rhythm End	Irregular rhythm no longer detected within the irregular rhythm end delay time.

Arrhythmia Message	Description
A-Fib End	Atrial fibrillation no longer detected within the Afib end delay time.
SVT	The number of consecutive SVCs is greater than or equal to the SVT SVCs limit, and the supraventricular HR is greater than or equal to the SVT HR limit.
SVCs/min	SVCs/min exceeds the high limit.
*: N refers to normal beat; V refers to ventricular beat.	

### 11.6.3 Displaying Arrhythmia Information

You can display the arrhythmia information in the numeric area. To do so, follow this procedure:

1. Select the **Main Menu** quick key → from the **Display** column select **Screen Setup**.
2. Select the **Tile Layout** tab.
3. Select the desired parameter numeric area, and then select **ECG** → **Arrhythmia**.

### 11.6.4 Changing Arrhythmia Settings

#### 11.6.4.1 Changing Arrhythmia Alarm Settings

To set the arrhythmia alarm properties, follow this procedure:

1. Select the ECG numeric area or waveform area to enter the **ECG** menu.
2. Select the **Arrhythmia** tab → select the **Alarm** tab.
3. Set alarm properties as desired.

#### NOTE

- **The priority of lethal arrhythmia alarms is always high. It cannot be changed.**

#### 11.6.4.2 Changing Arrhythmia Alarm Threshold Settings

You can change threshold settings for some arrhythmia alarms. When an arrhythmia exceeds its threshold, an alarm will be triggered. To do so, follow this procedure:

1. Select the ECG numeric area or waveform area to enter the **ECG** menu.
2. Select the **Arrhythmia** tab → the **Threshold** tab.
3. Set the threshold of desired arrhythmia alarms.

#### NOTE

- **The asystole delay time relates to ECG relearning. When heart rate is less than 30 bpm, it is recommended to set Asystole Delay to 10 seconds.**

#### 11.6.4.3 Arrhythmia Threshold Range

Arrhythmia	Threshold Range
Brady(HR Low)	16 bpm to 120 bpm
Tachy(HR High)	60 bpm to 295 bpm
Extreme Tachy	65 bpm to 300 bpm
Extreme Brady	15bpm to 115 bpm
Asystole Delay	3 sec to 10 sec
Multif PVCs Window	3 beats to 31 beats



Arrhythmia	Threshold Range
V-Tach Rate	100 bpm to 200 bpm
V-Tach PVCs	3 beats to 99 beats
V-Brady Rate	15 bpm to 60 bpm
V-Brady PVCs	3 beats to 99 beats
Pause Threshold	1.5sec, 2.0sec, 2.5sec, 3.0sec
PVCs/min	1 to 100
Pauses/min	1 to 15
SVT SVCs	3 beats to 99 beats
SVT HR	100 bpm to 300 bpm
SVCs/min	1 to 100
AF/Irr Rhy End Time	0 min, 1 min, 2 min, 3 min, 4 min, 5 min, 10 min, 15 min, 30 min

#### 11.6.4.4 Setting Thresholds for PVC-Related Alarms

The equipment detects PVC-related alarms basing on the current PVC rate and the number of consecutive PVCs.

To set the required thresholds for PVC-related alarms, follow this procedure:

1. Select the ECG numeric area or waveform area to enter the **ECG** menu.
2. Select the **Arrhythmia** tab → select the **More Threshold** tab.
3. Adjust **V-Tach PVCs**, **V-Tach Rate**, **V-Brady PVCs**, **V-Brady Rate** to set the threshold of desired PVC-related alarms.

The following figure illustrates the conditions under which PVC alarms will be generated if **V-Tach PVCs** is set to 6, **V-Tach Rate** is set to 130, **V-Brady PVCs** is set to 5, and **V-Brady Rate** is set to 40.

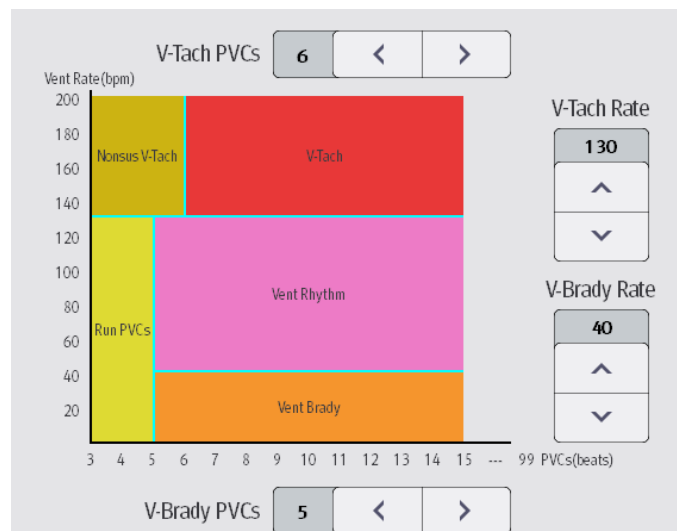

- If the number of consecutive PVCs is greater than or equal to the V-Tach PVCs limit (6), and the ventricular rate (Vent Rate) is greater than or equal to the V-Tach Rate limit (130), a V-Tach alarm is generated.
- If the number of consecutive PVCs is lower than the V-Tach PVCs limit (6) but greater than 2, and the ventricular rate is greater than or equal to the V-Tach Rate limit (130), a Nonsus V-Tach alarm is generated.
- If the number of consecutive PVCs is greater than or equal to the V-Brady PVCs limit (5), and the ventricular rate is lower than the V-Tach Rate limit (130) but greater than or equal to the V-Brady Rate limit (40), a Vent Rhythm alarm is generated.
- If the number of consecutive PVCs is lower than the V-Brady PVCs limit (5) but greater than 2, and the ventricular rate is lower than the V-Tach Rate limit (130), a Run PVCs alarm is generated.

- If the number of consecutive PVCs is greater than or equal to the V-Brady PVCs limit (5), and the ventricular rate is lower than the V Brady Rate limit (40), a Vent Brady alarm is generated.

## 11.6.5 Deactivated Arrhythmia Alarms

The equipment generally issues an alarm once an arrhythmia condition is detected. However, the equipment can be configured to deactivate some arrhythmia alarms and disable alarm lamp and alarm tone for a designated period of time when certain arrhythmia alarms are detected. For more information, see *11.6.5.1 Arrhythmia Alarm Chains* and *11.6.5.2 Arrhythmia Shielding Period*.

### 11.6.5.1 Arrhythmia Alarm Chains

If multiple arrhythmia conditions occur simultaneously, announcing all detected alarm conditions may be confusing. This may result in serious conditions being overlooked. So arrhythmia alarms are prioritized through alarm chains.

There are five arrhythmia alarm chains: one high priority chain and four medium priority chains, including PVC chain, beats detection chain, supraventricular chain, and A-Fib chain.

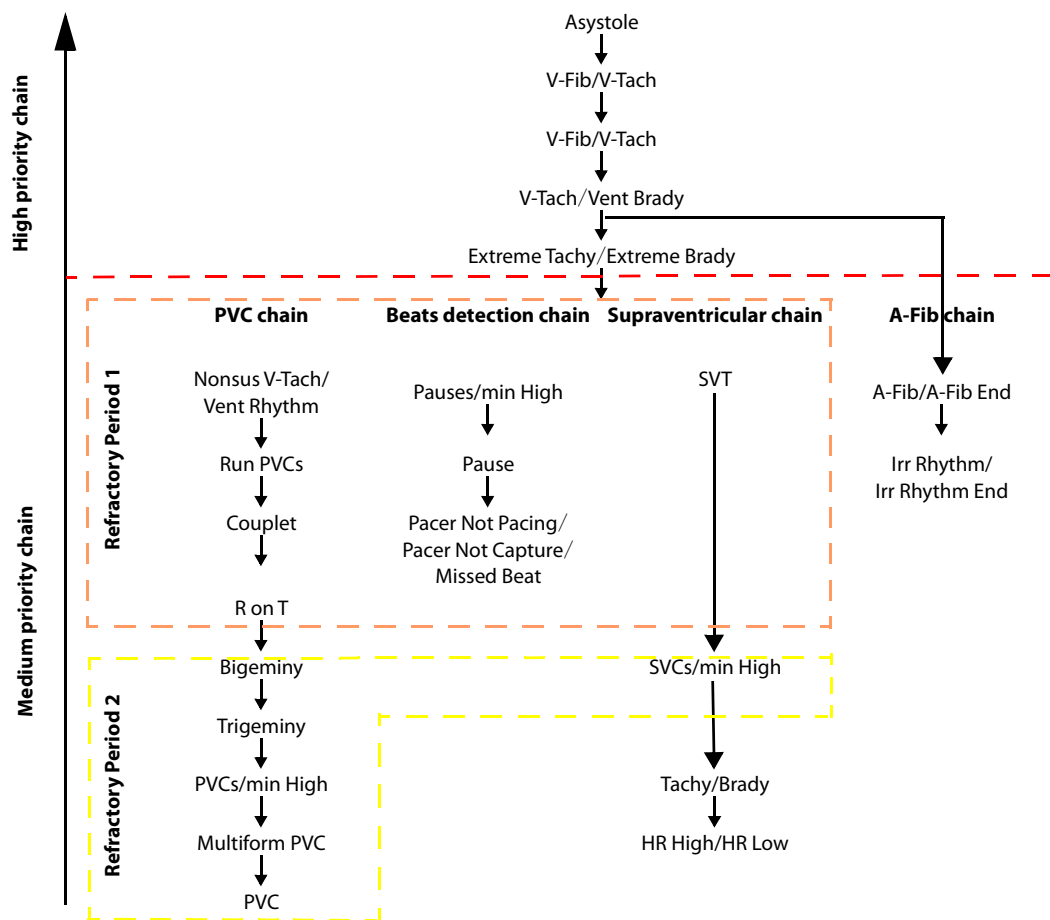

### 11.6.5.2 Arrhythmia Shielding Period

The arrhythmia algorithm can disable alarm lamp and alarm tone for designated period of time when certain arrhythmia alarms are detected. This period is called arrhythmia shielding period. The setting of **Arrhy Shield Time** can be changed in the Configuration mode only. For more information, see *22.7.3 Alarm Setup Menu*.

## NOTE

- **The arrhythmia shielding period has no impact on HR High, HR Low, Tachy, Brady, A-Fib End, Irr Rhythm End.**
- **The arrhythmia shielding period is only applicable to the alarms in the medium priority chains and atrial fibrillation chain. For the alarms in the high priority chain, alarm tone and alarm lamp are presented as soon as the alarm condition is detected.**

### 11.6.5.3 Arrhythmia Alarm Shielding Rules

The following table explains how audible and visual alarm indicate during the arrhythmia shielding period.

Previous Alarm	Current Alarm	Alarm Indication
Alarm in high priority chain	Alarm in high priority chain	Alarm lamp and alarm tone
	Alarm in medium priority chain	During the shielding period, alarm lamp and alarm tone are disabled. When the shielding period is reached, alarm lamp and alarm tone are reactivated.
Alarm in medium priority chain	Alarm in high priority chain	Alarm lamp and alarm tone
	Alarm in the same medium priority chain, but with higher priority	Alarm lamp and alarm tone
	The same alarm reoccurs	During the shielding period, alarm lamp and alarm tone are disabled. When the shielding period is reached, alarm lamp and alarm tone are reactivated.
	Alarm in the same medium priority chain, but with lower priority	During the shielding period, alarm lamp and alarm tone are disabled. When the shielding period is reached, alarm lamp and alarm tone are reactivated.
	Alarm in other medium priority chain	Alarm lamp and alarm tone

### 11.6.5.4 Setting Arrhythmia Refractory Periods

For some arrhythmias in the medium priority chain, an arrhythmia and arrhythmias with lower priority in the same alarm chain can be deactivated in a designated period of time. This period is called refractory period. When an arrhythmia is detected, the refractory period automatically starts. During the refractory period, the same alarm condition does not trigger an alarm. If the condition of an arrhythmia with lower priority in the same alarm chain appears, the equipment does not generate an alarm either.

To set arrhythmia refractory periods, follow this procedure:

1. Select the ECG numeric area or waveform area to enter the **ECG** menu.
2. Select the **Arrhythmia** tab → select the **Threshold** tab.
3. Set **Refractory Period 1** and **Refractory Period 2**.

The default refractory period 1 is 3 minutes. The default refractory period 2 is 10 minutes. To disable a refractory period, set it to **Off**.

For details on applying arrhythmias to **Refractory Period 1** and **Refractory Period 2**, see the figure of arrhythmia alarm chain in *11.6.5.1 Arrhythmia Alarm Chains*.

## NOTE

- **Refractory periods are only applicable to arrhythmias in the medium priority chains.**
- **Refractory periods have no impact on Tachy, Brady, HR High, HR Low, A-Fib/A-Fib End, Irr Rhythm/Irr Rhythm End.**

## 11.7 ST Segment Monitoring

ST monitoring is intended for adult, pediatric and neonatal patients.

### 11.7.1 ST Safety Information

---

---

#### WARNING

---

- **ST values may be affected by such factors as some drugs or metabolic and conduction disturbances.**
  - **ST deviation is often calculated at a fixed offset from the J point. Changes in heart rate may affect ST.**
  - **The ST deviation measurement algorithm has been tested for accuracy. The significance of ST segment changes needs to be determined by a physician.**
  - **The equipment provides ST deviation level change information. The clinical significance of the ST level change information should be determined by a physician.**
- 
- 

### 11.7.2 Enabling ST Monitoring

ST monitoring is disabled by default. Before starting ST monitoring, you should enable the ST function. To do so, follow this procedure:

1. Select the ECG numeric area or waveform area to enter the **ECG** menu.
2. Select the **ST** tab → select the **Setup** tab.
3. Switch on **ST Analysis**.

ST monitoring may be inaccurate or impossible in the following situations:

- A lead not noisy is impossible to be obtained.
- An irregular baseline is caused by arrhythmias, such as atrial fib or flutter.
- The patient is continuously ventricularly paced.
- The patient has left bundle branch block.

In these cases, you may consider disabling off ST monitoring.

### 11.7.3 Displaying ST Numerics

To display ST numerics, follow this procedure:

1. Select the **Main Menu** quick key → from the **Display** column select **Screen Setup**.
2. Select the **Tile Layout** tab.
3. Select the desired parameter numeric area, and then select **ECG** → **ST**.

The display of ST numeric area is different according to the lead type:

- When you are using the 3-lead ECG cable, the ST numeric area is not displayed. A ST value displays in the ECG numeric area.
- When you are using the 5-lead ECG cable, 7 ST values displayed in the ST numeric area are ST-I, ST-II, ST-III, ST-aVR, ST-aVL, ST-aVF, ST-V.
- When you are using the 12-lead ECG cable, 12 ST values displayed in the ST numeric area are ST-I, ST-II, ST-III, ST-aVR, ST-aVL, ST-aVF, ST-V1, ST-V2, ST-V3, ST-V4, ST-V5, ST-V6.

The following figure shows the ST numeric area when 5-lead ECG cable is used.

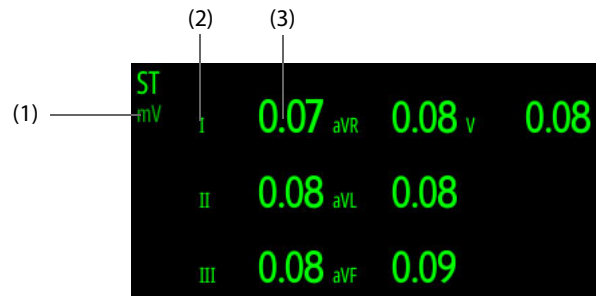

(1) ST alarm off symbol

(2) Lead labels

(3) ST numerics: a positive value indicates ST segment elevation, and a negative value indicates ST segment depression.

### 11.7.4 Displaying ST Segments

You can display ST segments in the parameter waveform area. To do so, follow this procedure:

1. Select the **Main Menu** quick key → from the **Display** column select **Screen Setup**.
2. Select the **Tile Layout** tab.
3. Select the desired parameter waveform area, and then select **ECG** → **ST**.

The current and baseline ST segments are displayed in the parameter waveform area. The current and baseline ST values are also displayed. In the following figure, the current ST segment and value are in green, while the baseline ST segment and value are in white.

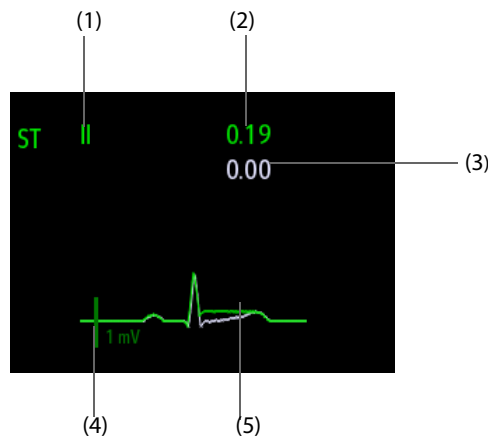

(1) ST lead

(2) Current ST value

(3) Baseline ST value

(4) 1 mV scale

(5) Current ST segment (green) and baseline ST segment (white)

### 11.7.5 Entering the ST View Window

ST View shows a complete QRS segment for each ST lead. The color of current ST segments and ST values is consistent with the color of ECG waveforms, normally green. The color of baseline segments and ST values is white.

To enter the **ST View** window, follow this procedure:

1. Select the ECG numeric area, ECG waveform area or ST numeric area to enter the **ECG** menu.
2. Select the **ST** tab.
3. Select **ST View** at the bottom

## 11.7.6 Saving the Current ST as Baseline

ST deviation is typically monitored as a relative change from a baseline value. Set a ST baseline when ST values become stable. If you did not set the ST baseline, the equipment automatically saves the baseline when valid ST values appear for 5 minutes. To set the ST baseline, follow this procedure:

In the **ST View** window, select **Set Baseline** to set the current ST segments and values as the baseline.

In the **ST View** window, you can also perform the following operations:

- Select **Display Baseline** or **Hide Baseline** to set the display of ST baseline.
- Select **Display Marker** or **Hide Marker** to set the display of positions of ISO point, J point and ST point.

### CAUTION

- **Updating ST baseline affects ST alarms.**

## 11.7.7 Entering the ST Graphic Window

To enter the **ST Graphic** window, follow this procedure:

1. Select the ECG numeric area, ECG waveform area or ST numeric area to enter the **ECG** menu.
2. Select the **ST** tab.
3. Select **ST Graphic** at the bottom.

The following figure shows the **ST Graphic** window when **ST Alarm Mode** is set to **Absolute**. The height of the bar indicates the ST value of corresponding ST lead. The color of the bar indicates ST alarm status: green indicates that corresponding ST value is within alarm limits; cyan, yellow and red indicate that the ST value exceeds the alarm limits. The color matches ST alarm priority.

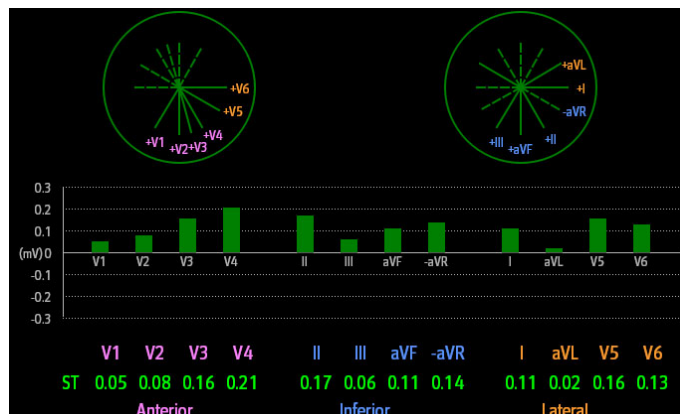

The following figure shows the **ST Graphic** window when **ST Alarm Mode** is set to **Relative**. The height of grey bar indicates the baseline ST value and the green bar (cyan, yellow or red if an alarm occurs) indicates  $\Delta$ ST.

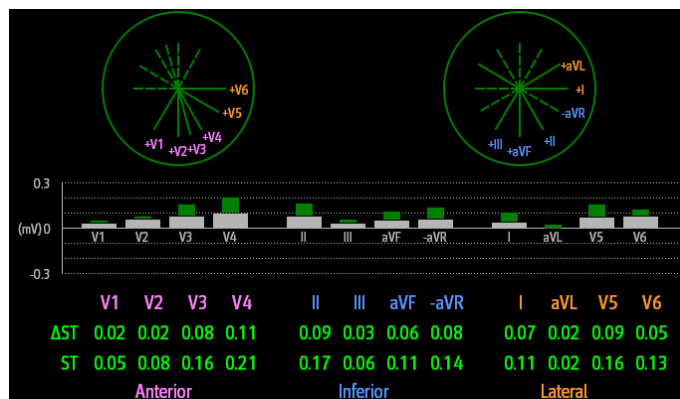

## 11.7.8 Changing ST Settings

### 11.7.8.1 Setting ST Alarm Properties

To set ST alarm properties, follow this procedure:

1. Select the ECG numeric area, ECG waveform area or ST numeric area to enter the **ECG** menu.
2. Select the **ST** tab → select the **Alarm** tab.
3. Set **ST Alarm Mode**.
  - ◆ **Absolute**: separately sets the alarm properties for each ST alarm.
  - ◆ **Relative**: sets the alarm properties for **ST Single** and **ST Dual** alarms.
4. Set ST alarm properties.

### 11.7.8.2 Changing Leads for ST Display

The equipment automatically selects the three most deviated leads for ST display. You can also manually select the leads. To do so, follow this procedure:

1. Select the ECG numeric area, ECG waveform area or ST numeric area to enter the **ECG** menu.
2. Select the **ST** tab → select the **Setup** tab.
3. Select **ST Segment**, and set the desired lead.

### 11.7.9 Setting Positions of ST Point, ISO Point and J Point

The following figure shows the positions of ST point, isoelectric (ISO) point and J point:

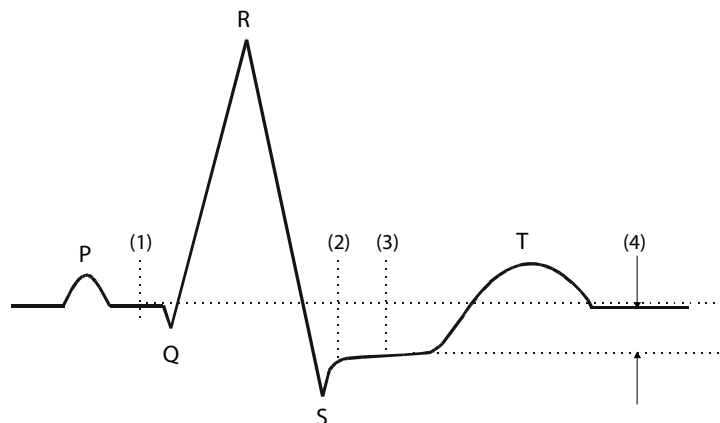

- (1) ISO point: is located between the end of the P-wave and the onset of the QRS complex. The ISO point provides the baseline for ST deviation measurement.
- (2) J point: is located at the end of the QRS complex. The distance between the J point and ST point is fixed. So it helps correctly position the ST point.
- (3) ST point: is located at the midpoint of the ST segment.
- (4) ST deviation (ST elevation or depression): is the potential difference between the ISO point and the ST point.

#### 11.7.9.1 Setting the Position of ST Point

Make sure that the position of the ST point is correctly set for the patient. Incorrect setting of ST point may result in artifactual ST deviation. Adjust the ST point before starting monitoring, or if the patient's heart rate or ECG morphology changes dramatically.

To set the position of ST point, follow this procedure:

1. Select the ECG numeric area, ECG waveform area or ST numeric area to enter the **ECG** menu.
2. Select the **ST** tab → select the **Adjust** tab.

3. Set **ST Point**. The ST point is positioned a fixed distance from the J point. When **J+60/80ms** is selected, the ST point is positioned either 80 ms (HR≤120 bpm) or 60 ms (HR>120 bpm) from the J point.

### 11.7.9.2 Initiating Auto Adjustment for Positions of ISO Point and J Point

The setting of **Auto Adjust** defines the method of adjusting the ISO point and J point. The auto adjustment function is enabled by default. In this case, positions of ISO point and J point are automatically adjusted accordingly.

To initiate the auto adjustment for positions of ISO point and J point, follow this procedure:

1. Select the ECG numeric area, ECG waveform area or ST numeric area to enter the **ECG** menu.
2. Select the **ST** tab→ select the **Adjust** tab.
3. Switch on **Auto Adjust**.

### 11.7.9.3 Manually Adjusting Positions of ISO Point and J Point

If **Auto Adjust** is switched off, you need to manually adjust the positions of ISO point and J point. To do so, follow this procedure:

1. Select the ECG numeric area, ECG waveform area or ST numeric area to enter the **ECG** menu.
2. Select the **ST** tab→ select the **Adjust** tab.
3. Switch off **Auto Adjust**.
4. Select the arrows at the right sides of **ISO** and **J** to manually adjust the positions:
  - ◆ Put the ISO point in the middle of the flattest part between the P and Q waves.
  - ◆ Put the J point at the end of the QRS complex and the beginning of the ST segment.

## 11.8 QT/QTc Interval Monitoring

The QT interval is from the beginning of the Q wave to the end of the T wave. QTc is the HR corrected QT interval. Monitoring QT interval helps detect the long QT syndrome.

QT/QTc interval monitoring is intended for adult, pediatric and neonatal patients.

### 11.8.1 QT/QTc Monitoring Limitations

QT/QTc monitoring may be inaccurate or impossible in the following situations:

- R-wave amplitude is too small.
- Frequent ventricular ectopic beats are presented.
- RR intervals are not stable.
- The P-wave tending to encroach on the end of the previous T-wave is caused by a high heart rate.
- The T-wave is very flat or is not well defined
- The end of the T-wave is difficult to define because of the presence of U-waves
- QTc measurements are not stable.
- Any of noise, asystole, ventricular fibrillation, atrial fibrillation, or ECG lead off is presented.

For these cases you should select a lead with good T-wave amplitude and no visible flutter activity, and without a predominant U-wave or P-wave.

Some conditions such as left or right bundle branch block or hypertrophy can lead to a widened QRS complex. If a long QTc is observed you should verify it to ensure that it is not caused by QRS widening.

Because normal beats followed by ventricular beats are not included in the analysis, no QT measurement will be generated in the presence of a bigeminy rhythm.

If the heart rate is extremely high (over 150 bpm for adults and over 180 bpm for pediatrics and neonates), QT will not be measured. When the heart rate changes, it can take several minutes for the QT interval to stabilize. For reliable QTc calculation it is important to avoid measurements when the heart rate is changing.



## 11.8.2 Enabling QT/QTc Monitoring

The QT monitoring function is disabled by default. Before starting QT monitoring, you should enable the QT function. To do so, follow this procedure:

1. Select the ECG numeric area or waveform area to enter the **ECG** menu.
2. Select the **QT** tab → select the **Setup** tab.
3. Switch on **QT Analysis**.

## 11.8.3 Displaying QT/QTc Numerics

To display QT/QTc numerics, follow this procedure:

1. Select the **Main Menu** quick key → from the **Display** column select **Screen Setup**.
2. Select the **Tile Layout** tab.
3. Select the desired parameter numeric area, and then select **ECG** → **QT/QTc**.

### NOTE

- **QTc values are calculated based on the QT-HR, not the ECG HR. For more information, see 11.8.4 Entering the QT View Window.**

The following figure shows the QT numeric area.

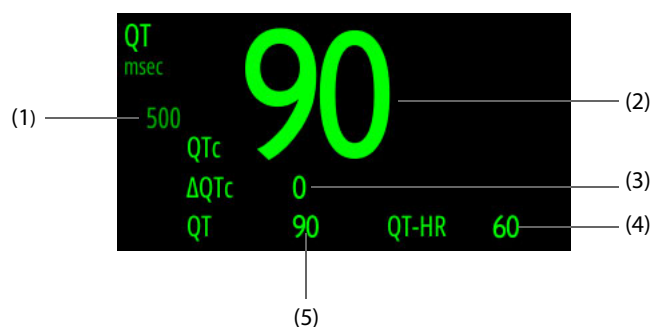

- |   |               |
|---|---------------|
| (1) QTc alarm limit   | (2) QTc value |
| (3) ΔQTc value (the difference between the current and baseline QTc values) |               |
| (4) QT-HR value   | (5) QT value  |

### NOTE

- **The display of the QT numeric area differs as related settings change.**

## 11.8.4 Entering the QT View Window

QT View shows the current and baseline QT parameter values and waveforms. To enter the **QT View** window, follow this procedure:

1. Select the QT numeric area, ECG numeric area, or ECG waveform area to enter the **ECG** menu.
2. Select the **QT** tab.
3. Select **QT View** at the bottom.

The following figure shows the **QT View** window.



- The current waveform is shown in the upper half in green.
- The baseline waveform is shown below in white.
- The start of QRS complex and the end of the T wave are marked with a vertical line.
- In some conditions, no QT measurement can be calculated. Then the cause of failed QT measurement is shown at the bottom of the QT numerics area and the message "**Cannot Analyze QT**" is shown in the alarm information area.

Select the left or right arrow to switch leads. Corresponding waveform will be highlighted.

### 11.8.5 Saving the Current QTc as Baseline

In order to quantify changes in the QTc value, you can set a QTc baseline. If no baseline has been set for this patient within the first five minutes after getting valid QT values, the equipment will automatically set a baseline. To set the current values as baseline, follow this procedure:

In the **QT View** window, select **Set Baseline** and then select **OK** to calculate  $\Delta$ QTc as the baseline.

If you set a new baseline the previous baseline will be discarded.

In the **QT View** window, you can select **Display Baseline** or **Hide Baseline** to set the display of baseline waveform.

---

#### CAUTION

---

- **Updating QTc baseline affects  $\Delta$ QTc value and alarm.**
- 

### 11.8.6 Changing QT Settings

#### 11.8.6.1 Setting QT Alarm Properties

To set QT alarm properties, follow this procedure:

1. Select the QT numeric area to enter the **QT** menu.
2. Set QTc and  $\Delta$ QTc alarm properties.

#### 11.8.6.2 Selecting Leads for QT Calculation

You can select one lead or all leads for QT calculation. To do so, follow this procedure:

1. Select the QT numeric area to enter the **QT** menu.
2. Select the **Setup** tab.
3. Set **QT Leads**. All is selected by default. This means all leads are used for QT calculation.

## 11.9 ECG Relearning

Changes in ECG template could result in incorrect arrhythmia alarms and/or inaccurate heart rate. ECG relearning allows the equipment to learn new ECG template so as to correct arrhythmia alarms and HR value. Once learning is complete, the dominant QRS complex is stored as a reference template. The reference template is used as a normal morphology of that patient and it is compared with incoming beats to identify possible arrhythmias.

### 11.9.1 Initiating Auto ECG Relearning

Auto arrhythmia relearning happens in the following situation:

- The ECG lead type or lead label is changed.
- ECG leads are off and are not reconnected within 60 seconds.
- The patient's paced status is changed.

### 11.9.2 Manually Initiating an ECG Relearning

If you suspect that abnormal arrhythmia alarms are presented, you may need to manually initiate an ECG relearning. To do so, follow this procedure:

1. Select the ECG numeric area or waveform area to enter the **ECG** menu.
2. Select **Relearn** at the bottom.

---

#### CAUTION

---

- **Take care to initiate ECG relearning only during periods of predominantly normal rhythm and when ECG signal is relatively noise-free. If ECG learning takes place during arrhythmia, the ectopics may be incorrectly learned as normal QRS complex. This may result in missed detection of subsequent events of arrhythmia.**
- 

## 11.10 Calibrating ECG

The ECG signal may be inaccurate due to hardware or software problems. As a result, the ECG waveform amplitude becomes greater or smaller. In that case, you need to calibrate the ECG module. To do so, follow this procedure:

1. Select the ECG numeric area or waveform area to enter the **ECG** menu.
2. Select the **Setup** tab.
3. Set **Calibrate** at the bottom.

## 11.11 ECG Troubleshooting

This section lists the problems that might occur. If you encounter problems when using the equipment or accessories, check the table below before requesting for services. If the problem persists after you have taken corrective actions, contact your service personnel.

#### NOTE

---

- **For the physiological and technical alarm messages, see *D Alarm Messages*.**
- 

Problem	Corrective Actions
No ECG numeric area and waveform area displayed on the main screen	<ol style="list-style-type: none"><li>1. Check that ECG is set to display in the <b>Screen Setup</b> menu. For more information, see 9.2.3 <i>Defining the Normal Screen Display</i>.</li><li>2. Check that if the ECG parameter switch is enabled. If not, enable the ECG measurement. For more information, see 9.2.2 <i>Setting the Switch for a Parameter</i>.</li><li>3. Check that the cable connections of ECG electrode and leadwires are tight. Replace the ECG electrode or leadwires if needed.</li></ol>

Problem	Corrective Actions
Noisy ECG traces	<ol style="list-style-type: none"> <li>1. Check that electrodes are not detached or dry. Replace with fresh and moist electrodes if necessary.</li> <li>2. Check that leadwires are not defective. Replace leadwires if necessary.</li> <li>3. Check that patient cable or leadwires are routed too close to other electrical devices. Move the patient cable or leadwires away from electrical devices.</li> </ol>
Excessive electrosurgical Interference	Use ESU-proof ECG cables. For more information, see <i>F.1 ECG Accessories</i> .
Muscle noise	<p>Inadequate skin preparation, tremors, tense subject, or poor electrode placement.</p> <ol style="list-style-type: none"> <li>1. Perform skin preparation again and re-place the electrodes. For more information, see <i>11.4.1 Preparing the Patient for Electrode Application</i> and <i>11.4.2 Applying ECG Electrodes</i>.</li> <li>2. Apply fresh, moist electrodes. Avoid muscular areas.</li> </ol>
Intermittent signal	<ol style="list-style-type: none"> <li>1. Check that cables are properly connected.</li> <li>2. Check that electrodes are not detached or dry. Perform skin preparation again as described in <i>11.4.1 Preparing the Patient for Electrode Application</i> and apply fresh and moist electrodes.</li> <li>3. Check that the patient cable or leadwires are not damaged. Change them if necessary.</li> </ol>
Excessive alarms: heart rate, lead fault	<ol style="list-style-type: none"> <li>1. Check that electrodes are not dry. Perform skin preparation again and re-place the electrodes. For more information, see <i>11.4.1 Preparing the Patient for Electrode Application</i> and <i>11.4.2 Applying ECG Electrodes</i>.</li> <li>2. Check for excessive patient movement or muscle tremor. Reposition the electrodes. Replace with fresh and moist electrodes if necessary.</li> </ol>
Low amplitude ECG signal	<ol style="list-style-type: none"> <li>1. Check that the ECG gain is not set too low. Adjust the gain as required. For more information, see <i>11.5.3.3 Changing ECG Waveform Size</i>.</li> <li>2. Perform skin preparation again and re-place the electrodes. For more information, see <i>11.4.1 Preparing the Patient for Electrode Application</i> and <i>11.4.2 Applying ECG Electrodes</i>.</li> <li>3. Check electrode application sites. Avoid bone or muscular area.</li> <li>4. Check that electrodes are not dry or used for a prolonged time. Replace with fresh and moist electrodes if necessary.</li> </ol>
No ECG waveform	<ol style="list-style-type: none"> <li>1. Check that the ECG gain is not set too low. Adjust the gain as required. For more information, see <i>11.5.3.3 Changing ECG Waveform Size</i>.</li> <li>2. Check that the leadwires and patient cables are properly connected.</li> <li>3. Check that the patient cable or leadwires are not damaged. Change them if necessary.</li> </ol>
Base Line wander	<ol style="list-style-type: none"> <li>1. Check for excessive patient movement or muscle tremor. Secure leadwires and cable.</li> <li>2. Check that electrodes are not detached or dry and replace with fresh and moist electrodes if necessary. For more information, see <i>11.4.1 Preparing the Patient for Electrode Application</i> and <i>11.4.2 Applying ECG Electrodes</i>.</li> <li>3. Check for ECG filter setting. Set ECG Filter mode to <b>Monitor</b> to reduce baseline wander on the display.</li> </ol>

# 12 Resting 12-Lead ECG Analysis

## 12.1 Resting 12-Lead ECG Analysis Introduction

12-lead ECG monitoring provides a simultaneous acquisition of 12-lead information for patients. If the equipment is configured with Glasgow 12-lead ECG analysis algorithm, a post diagnosis and analysis can be also provided. Resting 12-lead ECG analysis is used to identify and diagnose patients with cardiac disorders and is useful in the early detection and prompt treatment of patients with acute ST-elevation myocardial infarction (STEMI).

The resting 12-lead ECG analysis is intended for adult, pediatric, and neonatal patients.

For more information about the Glasgow algorithm, see *12-Lead ECG Interpretive Program Physician's Guide*.

---

---

### WARNING

---

- **Resting 12-lead ECG analysis provided by this equipment is not intended for direct cardiac application.**
- 
- 

## 12.2 Preparing for 12-Lead ECG Measurement

To properly prepare for 12-lead ECG analysis, follow this procedure:

1. Prepare the patient skin. For more information, see *11.4.1 Preparing the Patient for Electrode Application*.
2. Apply ECG electrodes to the patient.
  - ◆ For adult patients, connect the patient cable and apply ECG electrodes. For more information, see *11.4.2 Applying ECG Electrodes*, *11.4.4.3 Chest Electrode Placement* and *11.4.4.4 12-Lead Electrode Placement*.
  - ◆ For patients under 16 years old, connect the patient cable and apply limb electrodes. For more information, see *11.4.2 Applying ECG Electrodes* and *11.4.4.4 12-Lead Electrode Placement*. Chest electrodes should be placed at V4R, V1, V2, V4, V5, V6, and V3 electrode should be placed at the position of V4R as shown below.

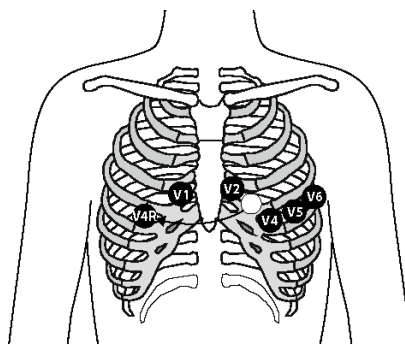

3. Once the electrodes are applied, instruct the patient in the following positions:
  - ◆ Arms and legs flat
  - ◆ Relaxing and comfortably lying
  - ◆ Remain still without talking
  - ◆ Breathing normally without chewing or clenching teeth.

## 12.3 Entering the 12-Lead ECG Window

To enter the 12-lead ECG window, select the **12-Lead** quick key.

## 12.4 Capturing 12-Lead ECG

To capture 12-lead ECG, select **Screenshot** below the 12-Lead ECG window. Screenshot function is defined to capture the screen by default. The settings of **Screenshot** can be changed in the Configuration mode only. For more information, see 22.7.5 *12-Lead Setup Menu*.

When the screenshot preview window is displayed, you can perform the following operations.

- **Send**: transmits a screenshot and generates an event.
- **Central Station**: transmits a screenshot to the desired CMS. If **Custom** is selected, you need to manually input the IP address of the desired CMS. For details on connecting the CMS, see 21.5 *Connecting the CMS*.
- **FTP**: transmits a screenshot to the desired FTP server. If **Custom** is selected, you need to manually input the IP address of the desired FTP server. For details on connecting the FTP server, see 21.8 *Transmitting Data through FTP Protocol*.

For details on reviewing events, see 18.7 *Reviewing Events*.

## 12.5 Changing 12-Lead ECG Settings

### 12.5.1 Checking the Patient Information

Some patient information may directly affect the 12-lead ECG analysis. Complete and correct patient information is helpful for accurate diagnosis and treatment of the patient.

To check the patient information, follow this procedure:

1. Select anywhere on the 12-lead ECG waveforms.
2. Check the inputted patient information is complete and correct.
3. If necessary, input or edit patient information. Settings of **Patient ID**, **Patient Name**, **Age** and **Gender** are relevant to those in the **Patient Management** menu.
4. Select **Save**.

#### NOTE

- For patients under 16 years old, it is recommended to set **V3 Placement** to **V4R** and place chest electrodes at **V4R, V1, V2, V4, V5, V6**. This is a normal practice for a patient of this age.

### 12.5.2 Setting the 12-Lead ECG Waveforms

To set the 12-lead ECG waveforms, follow this procedure:

1. Select anywhere on the 12-lead ECG waveforms.
2. Select the **Setup** tab, and change settings as desired.
3. Select  to save changes.

Except **Muscle Artifact Filter**, **Displayed Rhythm Lead**, **Tachy** and **Brady**, other settings are relevant to those in the **ECG** menu.

The following table lists related options, defaults and description.

Menu Item	Default	Description
Displayed Rhythm Lead	II	Sets the rhythm lead to be displayed in the first line.
Speed	25 mm/s	Sets the ECG waveform speed.
ECG Gain	x1	Sets the ECG waveform size.
Rhythm Format	One Lead	Sets the number of rhythm leads measured.

Menu Item	Default	Description
Muscle Artifact Filter	Off	Muscle artifact filter attenuates noise in the waveform by restricting the included frequencies. The muscle artifact filter is a low-pass filter. Signals exceeding the set frequency are filtered out. <ul style="list-style-type: none"> <li>• <b>35 Hz:</b> only signals at 35 Hz or less are displayed.</li> <li>• <b>20 Hz:</b> only signals at 20 Hz or less are displayed.</li> <li>• <b>Off:</b> signals at 350 Hz or less are displayed.</li> </ul>
Baseline Drift Removal	On	The baseline drift removal suppresses most baseline drift interference and also is able to preserve the fidelity of the ST-segment level.
Tachy	100 bpm	Sets tachycardia threshold. This setting is only effective for patients over 180 days.
Brady	50 bpm	Sets bradycardia threshold. This setting is only effective for patients over 2191 days.
Waveform Layout	Standard	Sets the ECG waveform layout. <ul style="list-style-type: none"> <li>• <b>Standard:</b> the waveform sequence is I, II, III, aVR, aVL, aVF, V1, V2, V3, V4, V5, V6.</li> <li>• <b>Cabrera:</b> the waveform sequence is aVL, I, -aVR, II, aVF, III, V1, V2, V3, V4, V5, V6.</li> </ul>

## NOTE

- **The baseline drift removal introduces about 1 second delay. It is recommended to switch on Baseline Drift Removal unless the delay is unacceptable.**

### 12.5.3 Setting the 12-Lead ECG Report

To set the 12-lead ECG report, follow this procedure:

1. Select anywhere on the 12-lead ECG waveforms.
2. Select the **Report** tab, and change settings as desired.
3. Select  to save changes.

The following table lists related options, defaults and description.

Menu Item	Default	Description
Median Complex	Off	Sets whether median complex information is included in the 12-lead ECG analysis report. Median complex displays a median complex waveform for each lead of 10 seconds in 3x4 format
Measurement Matrix	Off	Sets whether measurement matrix information is included in the 12-lead ECG analysis report. Measurement matrix provides 32 measurements for each lead, including Pon (ms), Pdur (ms), QRSon (ms), QRSdur (ms), Qdur (ms), Rdur (ms), Sdur (ms), R'dur (ms), S'dur (ms), P+dur (ms), QRSdef (ms), P+amp (μV), P-amp (μV), QRSp2p (μV), Qamp (μV), Ramp (μV), Samp (μV), R'amp (μV), S'amp (μV), STamp (μV), 2/8STT (μV), 3/8STT (μV), T+amp (μV), T-amp (μV), QRSarea (μV*ms), Rnotch, DWconf (%), STslope (deg), Ton (ms), Tdur (ms), T+dur (ms), QTint (ms).
Measurements	On	Sets whether measurement results are included in the 12-lead ECG analysis report. Measurement results include Heart Rate, PR Interval, QRS Duration, QT/QTc Interval, P/QRS/T Axes, RV5/SV1 and RV5+SV1.
Interpretation	On	Sets whether diagnosis is included in the 12-lead ECG analysis report.

Menu Item	Default	Description
Interpretation Summary	On	Sets whether interpretation summary is included in the 12-lead ECG analysis report. Interpretation summary is included in the report only when you switch on both <b>Interpretation</b> and <b>Interpretation Summary</b> .
RV5/SV1	On	Sets whether RV5/SV1 information is included in the 12-lead ECG analysis report. RV5/SV1 information is included in the report only when you switch on both <b>Measurements</b> and <b>RV5/SV1</b> .
Amplitude	10 mm/mV	Sets the ECG waveform amplitude printed out.
Speed	25 mm/s	Sets the printing speed of ECG waveform.
12-Lead Format	3x4	Sets the waveform format of 12-lead ECG analysis report. Take <b>3x4+1</b> as an example, ECG waveforms are displayed in 3 lines and 4 columns followed by a rhythm lead waveform.
Rhythm Lead 1	II	<ul style="list-style-type: none"> <li>• Sets the rhythm lead if <b>12-Lead Format</b> is set to <b>3x4+1</b>.</li> <li>• Sets the rhythm lead for manual and rhythm measurements.</li> </ul>
Rhythm Lead 2	V2	
Rhythm Lead 3	V5	
Format Sequence	Sequential	Sets the printing method of ECG waveforms. <ul style="list-style-type: none"> <li>• <b>Simultaneous</b>: simultaneously prints out ECG waveforms.</li> <li>• <b>Sequential</b>: sequentially prints ECG waveforms displayed in 3 lines and 4 columns with 2.5 seconds of ECG data for each column.</li> </ul>

## 12.6 Initiating 12-Lead ECG Measurement

Resting 12-lead ECG analysis provides three measurements, including auto measurement, manual measurement and rhythm measurement.

### 12.6.1 Auto Measurement

The auto measurement automatically acquires and analyzes 10 seconds of ECG data.

To initiate an auto measurement, follow this procedure:

1. Change settings relevant to the auto measurement. For more information, see *12.5 Changing 12-Lead ECG Settings*.
2. Select **Analyze** below the 12-Lead ECG window, and wait for auto diagnostic results.
  - ◆ If any connection problem occurs, you should take corrective actions. For more information, see *12.6.4 Actions When Lead Off Occurs*.
  - ◆ If patient information is incomplete, **Patient Demographics** menu is displayed. After you select **Don't remind next time**, **Patient Demographics** menu will not be displayed for next measurements. The switch setting of **Patient Info. Input Prompt** can be changed in the Configuration mode only. For more information, see *22.7.5 12-Lead Setup Menu*.
3. After acquiring 10 seconds of ECG data, the 12-lead ECG analysis report is automatically printed out. You can set whether to acquire 10 seconds of 12-lead ECG before initiating the auto measurement. The switch setting **Pre-acquisition** can be changed in Configuration mode only. For more information, see *22.7.5 12-Lead Setup Menu*.

During the measurement, you can select **Stop** below the 12-Lead ECG window to interrupt it at any time.

Auto extended measurement is disabled by default. If enabled, a rhythm measurement automatically starts when any of critical values "Extreme Tachycardia", "Extreme Bradycardia" or "Significant Arrhythmia" is detected at the completion of the auto measurement. The switch setting of **Extended Record** can be changed in the Configuration mode only. For more information, see *22.7.5 12-Lead Setup Menu*.

#### NOTE

- **Check that patient information is correct before initiating 12-lead ECG auto measurement.**



## 12.6.2 Manual Measurement

The manual measurement continuously acquires the real-time ECG waveforms of selected rhythm leads. The manual measurement provides only printed report without measurement and diagnostic results. You cannot save or transmit the report.

To initiate a manual measurement, follow this procedure:

1. Change settings relevant to the manual measurement. For more information, see *12.5 Changing 12-Lead ECG Settings*.
2. Select **Manual**. If any connection problem occurs, you should take corrective actions. For more information, see *12.6.4 Actions When Lead Off Occurs*.
3. Select **Stop** below the 12-Lead ECG window. The measurement stops and 12-lead ECG waveforms are automatically printed out.

## 12.6.3 Rhythm Measurement

The rhythm measurement acquires and prints out 60 seconds of ECG data for the rhythm lead. The rhythm measurement provides only printed report without measurement and diagnostic results. You cannot save or transmit the report.

To initiate a rhythm measurement, follow this procedure:

1. Change settings relevant to the rhythm measurement. For more information, see *12.5 Changing 12-Lead ECG Settings*.
2. Select **Rhythm**. A countdown for waveform acquisition is displayed. If any connection problem occurs, you should take corrective actions. For more information, see *12.6.4 Actions When Lead Off Occurs*.
3. After acquiring 60 seconds of ECG data, the measurement stops and the rhythm waveforms are automatically printed out.

During the measurement, you can select **Stop** below the 12-Lead ECG window to interrupt it at any time.

## 12.6.4 Actions When Lead Off Occurs

If electrodes are detached, or any of leadwires is poorly connected with the electrode, or the patient cable detaches from the equipment, **Check ECG lead connection** window will be displayed. In this case, you should check all electrodes are firmly attached to the patient, leadwires are properly connected with electrodes, and the patient cable is tightly connected to the equipment.

- When any of limb electrodes is detached, the message **“XX (RA/R, LA/L, RL/N, LL/F) lead off, please reconnect it”** is displayed. You should clear the connection failure as instructed, and then restart the measurement.
- When any of chest electrodes is detached, the message **“XX (V1 to V6/C1 to C6) lead off, please reconnect it.”** is displayed. You can select **Ignore** to continue the measurement, or clear the connection failure as instructed and then restart the measurement.

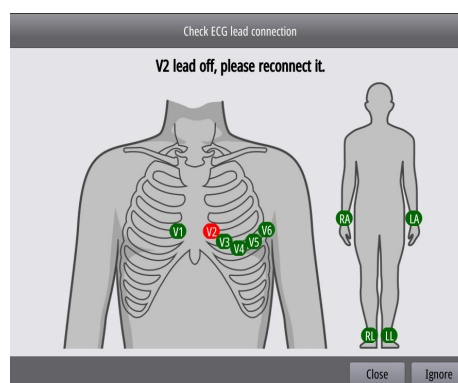

## 12.7 12-Lead ECG Analysis Report

At the completion of the 12-lead ECG auto measurement, the **12-lead ECG** window is automatically displayed. At the same time, a 12-lead ECG analysis report is automatically saved and a 12-lead ECG analysis event is then generated.

## 12.7.1 Viewing the 12-Lead ECG Analysis Report

The following figure shows the 12-lead ECG analysis report.

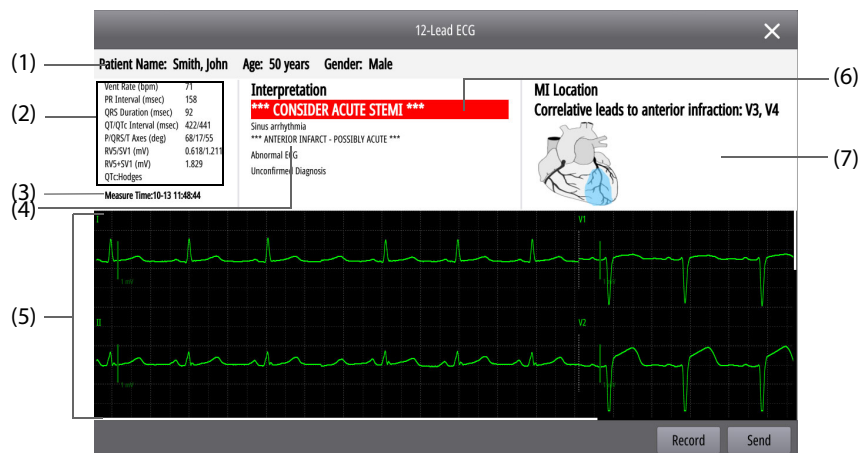

- (1) Patient information: includes patient name, age, gender.
- (2) Measurements: includes Heart Rate, PR Interval, QRS Duration, QT/QTc Interval, P/QRS/T Axes and QTc Formula.
- (3) Analysis time
- (4) Diagnostic results
- (5) 12-lead ECG waveforms
- (6) Critical Values: includes "Consider Acute STEMI", "Acute MI/Ischemia", "Extreme Tachycardia", "Extreme Bradycardia", "Significant Arrhythmia".
- (7) Myocardial infraction (MI) location diagram: graphically indicates the MI location, including inferior infarct, lateral infarct, anterior septal infarct, anterior infarct, septal infarct, anterior lateral infarct, and extensive infarct.

## 12.7.2 Reviewing the 12-Lead ECG Analysis Report

To review the 12-lead ECG analysis report, select **Review** below the 12-Lead ECG window. For more information, see 18.9 *Reviewing 12-Lead ECG Analysis*.

## 12.7.3 Transmitting the 12-Lead ECG Analysis Report

You can transmit a 12-lead ECG analysis report to the CMS or FTP server. To do so, select **Send** in the **12-lead ECG** window at the completion of the 12-lead ECG auto measurement and make settings as follows:

- **Central Station:** transmits the 12-lead ECG analysis report to the desired CMS. If **Custom** is selected, you need to manually input the IP address of the desired CMS. For details on connecting the CMS, see 21.5 *Connecting the CMS*.
- **FTP:** transmits the 12-lead ECG analysis report to the desired FTP server. If **Custom** is selected, you need to manually input the IP address of the desired FTP server. For details on connecting the FTP server, see 21.8 *Transmitting Data through FTP Protocol*.

The format of 12-lead ECG analysis report transmitted to the CMS is XML by default. The setting of **ECG Report** can be changed in the Configuration mode only. For more information, see 22.7.5 *12-Lead Setup Menu*.

## 12.7.4 Printing the 12-Lead ECG Analysis Report

After you select **Analyze** in the auto measurement mode, the 12-lead ECG analysis report is automatically printed out. The switch setting of **Auto Record** can be changed in the Configuration mode only. For more information, see 22.7.5 *12-Lead Setup Menu*.

At the completion of the 12-lead ECG auto measurement, you can select **Record** in the **12-lead ECG** window to manually print out the 12-lead ECG analysis report.

## 12.7.5 Comparing 12-Lead ECG Analysis Reports

If multiple 12-lead ECG analysis reports are saved, you can choose two reports from them for a comparison. To do so, follow this procedure:

1. Select **Comparison** below the 12-Lead ECG window.
2. Select a desired report from the historical report area, and select **Set Reference** to set it as a reference report.
3. Select the other report to be compared from the historical report area.
4. Select **Speed** and **Gain** to set the display of waveforms comparison.
5. Select the **Median Complex Comparison** tab to view median complex comparison.

The following figure shows waveforms comparison between 12-lead ECG analysis reports.

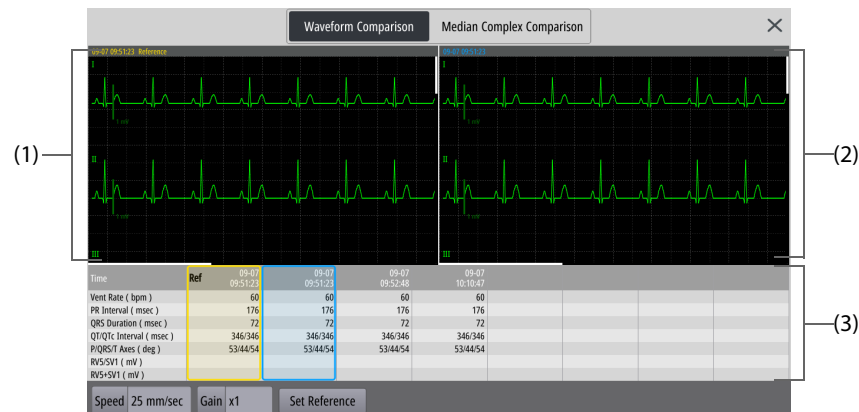

- (1) Reference waveform area: displays 12-lead ECG waveforms of a reference report. The reference report is indicated with **"Reference"** and measurement time of yellow text in the upper left corner.
- (2) Comparison waveform area: displays 12-lead ECG waveforms of a report to be compared. The measurement time of the report is displayed in blue text.
- (3) Historical report area: displays measurement time and results for all saved report. The reference report is indicated with **"Ref"** in a yellow box, and the comparison report is indicated with a blue box.

## 12.8 Exiting the 12-Lead ECG Window

To exit the 12-Lead ECG window, select **Exit 12-Lead** below the 12-Lead ECG window.

**This page intentionally left blank.**

# 13 Monitoring Respiration (Resp)

## 13.1 Resp Introduction

Impedance respiration is measured across the thorax. When the patient is breathing or ventilated, the volume of air changes in the lungs, resulting in impedance changes between the electrodes. Respiration rate (RR) is calculated from these impedance changes, and a respiration waveform appears on the screen.

Respiration monitoring is intended for adult, pediatric and neonatal patients.

## 13.2 Resp Safety Information

### WARNING

- When monitoring the patient's respiration, do not use ESU-proof ECG cables.
- If you do not set the detection level for the respiration correctly in manual detection mode, it may not be possible for the equipment to detect apnea. If you set the detection level too low, the equipment is more likely to detect cardiac activity, and to falsely interpret cardiac activity as respiratory activity in the case of apnea.
- The respiration measurement does not recognize the cause of apneas. It only indicates an alarm if no breath is detected when a pre-adjusted time has elapsed since the last detected breath. Therefore, it cannot be used for diagnostic purpose.
- If operating under conditions according to the EMC Standard IEC 60601-1-2 (Radiated Immunity 3V/m), field strengths above 3V/m may cause erroneous measurements at various frequencies. Therefore, it is recommended to avoid the use of electrically radiating equipment in close proximity to the respiration measurement unit.
- The impedance respiration measurement may cause rate changes in Minute Ventilation Rate Responsive Pacemakers. Set the pacemaker rate responsive mode off or disable the impedance respiration measurement on the equipment.
- When using the electrosurgery unit, ensure proper contact of the ESU return electrode to the patient to avoid burns at measurement sites. Also ensure that the ESU return electrode is near the operating area.

### CAUTION

- Respiration monitoring is not for use on the patients who are very active, as this will cause false alarms.

## 13.3 Resp Display

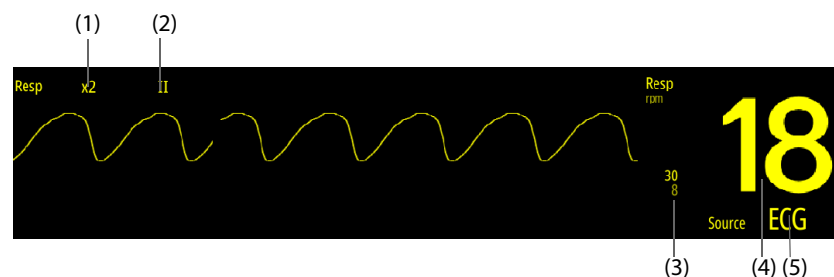

(1) Resp waveform gain

(2) Resp lead label

(3) Alarm limits

(4) Respiration rate (RR)

(5) RR source

## NOTE

- If ESU-proof ECG cables are used, the Resp waveform area will display the message “Check Leads”. Replace the ECG cable if necessary.

## 13.4 Preparing for Resp Monitoring

### 13.4.1 Preparing the Patient for Electrode Application

Before starting resp monitoring, you should properly prepare the skin. For more information, see 11.4.1 *Preparing the Patient for Electrode Application*.

### 13.4.2 Placing the Electrodes

As the Respiration measurement adopts the standard ECG electrode placement, you can use different ECG cables. Since the respiration signal is measured between two ECG electrodes, if a standard ECG electrode placement is applied, the two electrodes should be RA and LA of ECG Lead I, or RA and LL of ECG Lead II.

For more information, see 11.4.4 *ECG Electrode Placement*.

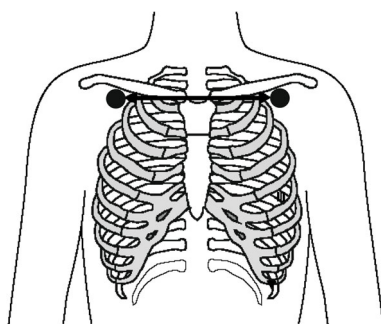

Lead I

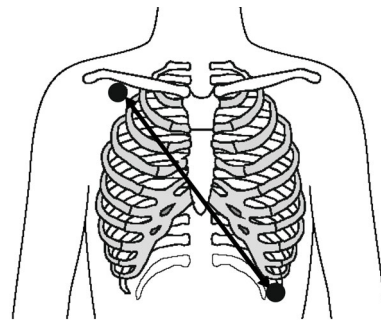

Lead II

## CAUTION

- To reduce cardiovascular artifact, apply the respiration electrodes so that the liver area and the ventricles of the heart are not in the line between the respiratory electrodes. This is especially important for neonatal patients.
- To optimize the respiration waveform, place the RA and LA electrodes horizontally when monitoring respiration with ECG Lead I; place the RA and LL electrodes diagonally when monitoring respiration with ECG Lead II.
- To optimize respiratory waveforms for patients breathing mainly abdominally, apply the LL electrode on the left abdomen at the point of maximum abdominal expansion.
- For patients expand chests laterally (normally neonatal patients), to avoid negative intrathoracic pressure and optimize respiratory waveforms, respectively apply the electrodes in the right midaxillary and the left lateral chest areas at the maximum point of the breathing movement.
- Periodically inspect the electrode application site to ensure skin quality. If the skin quality changes, replace the electrodes or change the application site.

## NOTE

- Store the electrodes at room temperature. Open the electrode package immediately prior to use.
- Check that the electrode packages are intact and not expired. Make sure the electrode gel is moist.

## 13.5 Changing Resp Settings

### 13.5.1 Setting the Resp Alarm Properties

To set the Resp alarm properties, follow this procedure:

1. Select the Resp numeric area or waveform area to enter the **Resp** menu.
2. Select the **Alarm** tab.
3. Set alarm properties as desired.

#### NOTE

- 
- You can switch off the apnea alarm only when Apnea Alarm Off is enabled. For more information, see [10.4.7 Setting the Switch of Apnea Alarm Off](#).
- 

### 13.5.2 Setting the RR Source

To set the RR source, follow this procedure:

1. Select the Resp numeric area or waveform area to enter the **Resp** menu.
2. Select the **Setup** tab.
3. Set **RR Source**.

When **RR Source** is set to **Auto**, the RR source is automatically selected according to the priority. The priority of **RR Source** is first **CO2**, and then **ECG**. When the current RR source is not available, **RR Source** is automatically switched to **Auto**.

### 13.5.3 Choosing the Respiration Lead

To set the respiration lead, follow this procedure:

1. Select the Resp numeric area or waveform area to enter the **Resp** menu.
2. Select the **Setup** tab.
3. Set **Resp Lead**.

If you cannot get optimal Resp waveform or you suspect the Resp value after choosing the Resp lead, you may need to optimize the electrode placement.

### 13.5.4 Setting the Resp Waveform Size

To set the Resp waveform size, follow this procedure:

1. Select the Resp numeric area or waveform area to enter the **Resp** menu.
2. Select the **Setup** tab.
3. Set **Gain**.

### 13.5.5 Setting the Resp Waveform Speed

To set the Resp waveform speed, follow this procedure:

1. Select the Resp numeric area or waveform area to enter the **Resp** menu.
2. Select the **Setup** tab.
3. Set **Speed**.

## 13.5.6 Initiating Auto Detection for Resp Waveform Threshold

You can imitate the auto detection for the Resp waveform detection level, or threshold. To do so, follow this procedure:

1. Select the Resp numeric area or waveform area to enter the **Resp** menu.
2. Select the **Setup** tab.
3. Switch on **Auto Threshold Detection**.



After **Auto Threshold Detection** is switched on, if ECG is switched off when you are monitoring respiration, the equipment cannot compare ECG and RR to detect cardiovascular artifact. To avoid cardiovascular artifact being interpreted as respiration, the respiration threshold is automatically set higher.

## 13.5.7 Manually Adjusting the Resp Waveform Threshold

It is recommended to manually adjust the resp waveform threshold in the following situations:

- The patient has intermittent mandatory ventilation.
- The patient's respiration is weak.
- The patient's RR is close to HR.

To manually adjust the Resp waveform threshold to the desired level, follow this procedure:

1. Select the Resp numeric area or waveform area to enter the **Resp** menu.
2. Select the **Threshold** tab.
3. Switch off **Auto Threshold Detection**.
4. Select  or  below **Upper Line** and **Lower Line** to define the Resp waveform threshold.

Once you set the Resp waveform threshold, it will not automatically adapt to different respiration depths. Always remember change the detection level if the depth of breathing changes.

When manually adjusting the resp waveform threshold, cardiovascular artifact can be mistakenly interpreted as respiration in certain situations. This results in higher respiration rate or undetected apnea. If you suspect the RR reading, adjust the Resp waveform threshold to raise the detection level. If you cannot adjust threshold because the Resp waveform is too small, consider optimize the electrode placement.

## 13.6 Resp Troubleshooting

If you encounter the problems when using the equipment or accessories, check the table by referring *D Alarm Messages* before requesting for services. If the problem persists, contact your service personnel.



# 14 Monitoring Pulse Oxygen Saturation (SpO<sub>2</sub>)

---

## 14.1 SpO<sub>2</sub> Introduction

Pulse Oxygen Saturation (SpO<sub>2</sub>) monitoring is a non-invasive technique used to measure the amount of oxygenated haemoglobin and pulse rate by measuring the absorption of selected wavelengths of light. The light generated in the emitter side of the probe is partly absorbed when it passes through the monitored tissue. The amount of transmitted light is detected in the detector side of the probe. When the pulsative part of the light signal is examined, the amount of light absorbed by the haemoglobin is measured and the pulse oxygen saturation can be calculated. The equipment is calibrated to display functional oxygen saturation.

SpO<sub>2</sub> monitoring is intended for adult, pediatric and neonatal patients.

The following types of SpO<sub>2</sub> can be configured:

- Mindray SpO<sub>2</sub>: the connector is blue and no logo is on the equipment.
- Nellcor SpO<sub>2</sub>: the connector is grey and the logo of Nellcor is on the equipment.
- Masimo SpO<sub>2</sub>: the connector is purple and the logo of Masimo SET is on the equipment.

### NOTE

---

- **The SpO<sub>2</sub> extension cable should be compatible with the SpO<sub>2</sub> connectors. For example, you can only connect the Mindray SpO<sub>2</sub> extension cable to the Mindray SpO<sub>2</sub> connectors.**
  - **Measurement accuracy verification: The SpO<sub>2</sub> accuracy has been verified in human experiments by comparing with arterial blood sample reference measured with a CO-oximeter. Pulse oximeter measurements are statistically distributed and about two-thirds of the measurements are expected to come within the specified accuracy range compared to CO-oximeter measurements.**
  - **A functional tester or SpO<sub>2</sub> simulator can be used to determine the pulse rate accuracy.**
  - **A functional tester or SpO<sub>2</sub> simulator cannot be used to assess the SpO<sub>2</sub> accuracy.**
- 

## 14.2 SpO<sub>2</sub> Safety Information

---

### WARNING

---

- **If the patient has a trend of deoxygenation, analyze the blood samples with a laboratory CO-oximeter to completely understand the patient's condition.**
- **Do not use the equipment or SpO<sub>2</sub> sensors during MRI scanning or in an MRI environment. Induced current could potentially causes burns. The equipment may affect the MRI image, and the MRI device may affect the accuracy of the SpO<sub>2</sub> measurements.**
- **Prolonged continuous monitoring may increase the risk of undesirable changes in skin characteristics, such as irritation, reddening, blistering or burns. Inspect the sensor site every two hours and move the sensor if the skin quality changes. Change the application site every four hours. For neonates, or patients with poor peripheral blood circulation or sensitive skin, inspect the sensor site more frequently.**
- **Setting alarm limits to extreme values may cause the alarm system to become ineffective. For example, high oxygen levels may predispose a premature infant to retrolental fibroplasia. Setting the SpO<sub>2</sub> high alarm limit to 100% is equivalent to switching off the SpO<sub>2</sub> alarm.**
- **Do not place the equipment or accessories in any position that might cause it to fall on the patient.**
- **Do not start or operate the equipment unless the setup was verified to be correct.**
- **Do not loop the patient cabling into a tight coil or wrap around the equipment, as this can damage the patient cabling.**
- **If the sensor is too tight because the application site is too large or becomes too large due to edema, excessive pressure for prolonged periods may result in venous congestion distal from the application site, leading to interstitial edema and tissue ischemia.**

- When patients are undergoing photodynamic therapy they may be sensitive to light sources. Pulse oximetry may be used only under careful clinical supervision for short time periods to minimize interference with photodynamic therapy.
- SpO<sub>2</sub> is empirically calibrated in healthy adult volunteers with normal levels of carboxyhemoglobin (COHb) and methemoglobin (MetHb).
- To protect from electric shock, always remove the sensor and completely disconnect the pulse oximeter before bathing the patient.
- The pulse oximeter function of the equipment should not be used for apnea monitoring.
- The pulse oximeter function of the equipment should not be used for arrhythmia analysis.

---

## CAUTION

- Change the application site or replace the sensor and/or patient cable when a persistent “SpO<sub>2</sub> Low Signal Quality” message is displayed on the equipment. These messages may indicate that patient monitoring time is exhausted on the patient cable or sensor.
- Replace the cable or sensor when a “SpO<sub>2</sub> Sensor Off”, “SpO<sub>2</sub> No Sensor”, or “SpO<sub>2</sub> Low Signal Quality” message is consistently displayed while monitoring consecutive patients after completing troubleshooting steps listed in this manual.
- Variation in measurements may be profound and may be affected by sampling technique as well as the patient’s physiological conditions. Any results exhibiting inconsistency with the patient’s clinical status should be repeated and/or supplemented with additional test data. Blood samples should be analyzed by laboratory instruments prior to clinical decision making to completely understand the patient’s condition.
- Do not place the pulse oximeter where the controls can be changed by the patient.
- If using pulse oximetry during full body irradiation, keep the sensor out of the radiation field. If the sensor is exposed to the radiation, the reading might be inaccurate or the device might read zero for the duration of the active irradiation period.

---

## NOTE

- Additional information specific to the Masimo sensors compatible with the equipment, including information about parameter/measurement performance during motion and low perfusion, may be found in the sensor’s directions for use (DFU).
- Masimo cables and sensors are provided with X-Cal™ technology to minimize the risk of inaccurate readings and unanticipated loss of patient monitoring. Refer to the Cable or Sensor DFU for the specified duration of the patient monitoring time.

## 14.3 SpO<sub>2</sub> Measurement Limitations

The following factors may influence the accuracy of SpO<sub>2</sub> measurement:

- Patient physiological characteristics:
  - ◆ Cardiac arrest
  - ◆ Hypotension
  - ◆ Darkly pigmented skin
  - ◆ Shock
  - ◆ Severe vasoconstriction
  - ◆ Hypothermia
  - ◆ Severe anemia
  - ◆ Ventricular septal defects (VSDs)
  - ◆ Venous pulsations
  - ◆ Poor perfusion
  - ◆ Dysfunctional hemoglobin, such as carboxyhemoglobin (COHb) and methemoglobin (MetHb)
  - ◆ Elevated levels of bilirubin

- ◆ Vasospastic disease, such as Raynaud’s, and peripheral vascular disease
- ◆ Hemoglobinopathies and synthesis disorders such as thalassemias, Hb s, Hb c, sickle cell, etc.
- ◆ Hypocapnic or hypercapnic conditions
- ◆ Birthmark(s), tattoos, skin discolorations, moisture on skin, deformed or abnormal fingers. etc.
- Interfering substances:
  - ◆ Intravascular dyes (such as indocyanine green, methylene blue, indigo carmine, etc.)
  - ◆ Dyes in the measure site, such as nail polish.
- Environmental conditions:
  - ◆ Excessive ambient light
  - ◆ Electrosurgery equipment
  - ◆ Defibrillation (may cause inaccurate reading for a short amount of time)
  - ◆ Excessive patient/sensor motion
  - ◆ Electromagnetic field
  - ◆ Arterial catheters and intra-aortic balloon
- Others
  - ◆ Inappropriate positioning of the SpO<sub>2</sub> sensor, or use of incorrect SpO<sub>2</sub> sensor
  - ◆ Cuff or arterial blood pressure measurement device on the same limb as the SpO<sub>2</sub> sensor.

## 14.4 SpO<sub>2</sub> Display

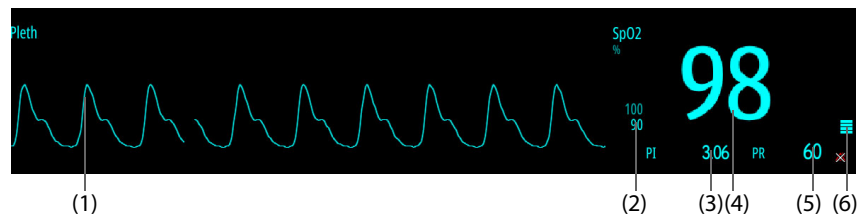

- (1) Pleth waveform (Pleth): indicates the blood pulsation at the measurement site. The waveform is not normalized.
- (2) Alarm limits
- (3) Perfusion index (PI) (for Mindray SpO<sub>2</sub> and Masimo SpO<sub>2</sub>): indicates the percentage of pulsate signal to non pulsate signal. PI is an indicator of the pulsate strength. You can also use it to assess the SpO<sub>2</sub> signal strength.
  - ◆ Above 1 is optimal.
  - ◆ Between 0.3 and 1 is acceptable.
  - ◆ Below 0.3 indicates low perfusion. Reposition the SpO<sub>2</sub> sensor or find a better site. If low perfusion persists, choose another method to measure oxygen saturation if possible.
- (4) Oxygen saturation of arterial blood (SpO<sub>2</sub>): indicates the percentage of oxygenated hemoglobin relative to total hemoglobin.
- (5) Pulse rate: indicates the number of pulsations per minute.
- (6) Perfusion indicator: the pulsatile portion of the measured signal caused by arterial pulsation. The higher the bar, the better the perfusion quality.

### NOTE

- **PI is only available for Mindray SpO<sub>2</sub> and Masimo SpO<sub>2</sub>.**

## 14.5 Preparing for SpO<sub>2</sub> Monitoring

To prepare to monitor SpO<sub>2</sub>, follow this procedure:

1. Select an appropriate sensor according to the module type, application site, patient category and weight.
2. Clean the contact surface of the reusable sensor.
3. Clean the measurement site, such as nail polish.
4. Apply the sensor to the patient according to the instruction for use of the sensor.
5. Select an appropriate extension cable according to the connector type and plug the cable into the SpO<sub>2</sub> connector.
6. Connect the sensor to the extension cable.

---

### CAUTION

---

- **Select proper SpO<sub>2</sub> sensor according to application site. Applying sensor too tight may severely obstruct circulation and lead inaccurate measurements. Loose application may result in measurement site exposing to ambient light.**
  - **Avoid placing the SpO<sub>2</sub> sensor on the same extremity with an NIBP cuff, arterial catheter, or intravascular line.**
  - **When monitoring SpO<sub>2</sub> at high ambient temperature, to avoid burns at the application site that is not well perfused, pay attention to prolonged SpO<sub>2</sub> sensor application.**
- 

## 14.6 Changing SpO<sub>2</sub> Settings

### 14.6.1 Changing the SpO<sub>2</sub> Alarm Properties

To change the SpO<sub>2</sub> alarm properties, follow this procedure:

1. Select the SpO<sub>2</sub> numeric area or waveform area to enter the **SpO<sub>2</sub>** menu.
2. Select the **Alarm** tab.
3. Set alarm properties as desired.

---

### NOTE

---

- **You can switch off the SpO<sub>2</sub> Desat alarm only when SpO<sub>2</sub> Desat Alarm Off is enabled. For more information, see section 22.7.3 Alarm Setup Menu.**
- 

### 14.6.2 Monitoring SpO<sub>2</sub> and NIBP Simultaneously

When monitoring SpO<sub>2</sub> and NIBP on the same limb simultaneously, you can switch on **NIBP Simul** to lock the SpO<sub>2</sub> alarm status until the NIBP measurement ends. If you switch off **NIBP Simul**, low perfusion caused by NIBP measurement may lead to inaccurate SpO<sub>2</sub> readings and therefore cause false physiological alarms.

To set the **NIBP Simul**, follow this procedure:

1. Select the SpO<sub>2</sub> numeric area or waveform area to enter the **SpO<sub>2</sub>** menu.
2. Select the **Alarm** tab.
3. Set **NIBP Simul**.

### 14.6.3 Nellcor Sat-Seconds Alarm Management

With traditional alarm management, high and low alarm limits are set for monitoring oxygen saturation. During monitoring, once an alarm limit is violated, an audible alarm immediately sounds. When the patient SpO<sub>2</sub> fluctuates near an alarm limit, the alarm sounds each time the limit is violated. Such frequent alarms can be distracting. Nellcor's Sat-Seconds alarm management technique is used to reduce these nuisance alarms.

The Sat-Seconds feature is available with the Nellcor SpO<sub>2</sub> to decrease the likelihood of false alarms caused by motion artifacts. With Sat-Seconds alarm management, high and low alarm limits are set in the same way as

those with traditional alarm management. A Sat-Seconds limit is also set. The Sat-Seconds limit controls the amount of time that SpO<sub>2</sub> saturation may be outside the set limits before an alarm sounds.

The method of calculation is as follows: the percentage points of the SpO<sub>2</sub> saturation falling outside the alarm limit is multiplied by the number of seconds remaining outside the limit. This can be stated as the equation:

$$\text{Sat-Seconds} = \text{Points} \times \text{Seconds}$$

Only when the Sat-Seconds limit is reached, the equipment gives a Sat-Seconds alarm. For example, the figure below demonstrates the alarm response time with a Sat-Seconds limit set at 50 and a low SpO<sub>2</sub> limit set at 90%. In this example, the patient SpO<sub>2</sub> drops to 88% (2 points) and remains there for 2 seconds. Then it drops to 86% (4 points) for 3 seconds, and then to 84% (6 points) for 6 seconds. The resulting Sat-Seconds are:

% SpO <sub>2</sub>	Seconds	Sat-Seconds
2x	2=	4
4x	3=	12
6x	6=	36
Total Sat-Seconds=		52

After approximately 10.9 seconds, a Sat-Second alarm would sound, because the limit of 50 Sat-Seconds would have been exceeded.

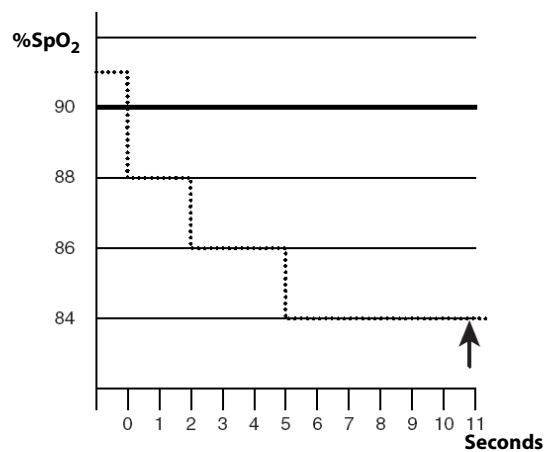

Saturation levels may fluctuate rather than remaining steady for a period of several seconds. Often, the patient SpO<sub>2</sub> may fluctuate above and below an alarm limit, re-entering the non-alarm range several times. During such fluctuation, the equipment integrates the number of SpO<sub>2</sub> points, both positive and negative, until either the Sat-Seconds limit is reached, or the patient SpO<sub>2</sub> re-enters the non-alarm range and remains there.

#### NOTE

- The alarm “SpO<sub>2</sub> Too Low “or “SpO<sub>2</sub> Too High” is displayed in the case that SpO<sub>2</sub> value violates the alarm limits for 3 times within one minute even if the setting of Sat-Seconds is not reached.

### 14.6.4 Setting the SpO<sub>2</sub> Sat-Seconds (for Nellcor SpO<sub>2</sub>)

To set the Sat-Seconds, follow this procedure:

1. Select the SpO<sub>2</sub> numeric area or waveform area to enter the **SpO2** menu.
2. Select the **Alarm** tab.
3. Set **Sat-Seconds**.

### 14.6.5 Setting SpO<sub>2</sub> Sensitivity (for Masimo SpO<sub>2</sub>)

For Masimo SpO<sub>2</sub>, set **Sensitivity** as per signal quality and patient motion.

Normal sensitivity is the recommended for patients who are experiencing some compromise in blood flow or perfusion. It is advisable for care areas where patients are observed frequently, such as the intensive care unit (ICU).

Adaptive Probe Off Detection (APOD) sensitivity is the recommended sensitivity mode where there is a high probability of the sensor becoming detached. It is also the suggested mode for care areas where patients are not visually monitored continuously. This mode delivers enhanced protection against erroneous pulse rate and arterial oxygen saturation readings when a sensor becomes inadvertently detached from a patient due to excessive movement.

Maximum sensitivity is recommended for use on patients with weak signals (e.g. high ambient noise and/or patients with very low perfusion) and for use during procedures or when clinician and patient contact is continuous such as in higher acuity settings.

To set SpO<sub>2</sub> sensitivity, follow this procedure:

1. Select the SpO<sub>2</sub> numeric area or waveform area to enter the **SpO2** menu.
2. Select the **Setup** tab.
3. Set **Sensitivity**.

---

## CAUTION

- **When using the Maximum Sensitivity setting, performance of “Sensor Off” detection may be compromised. If the equipment and the sensor becomes detached from the patient, the potential for false readings may occur due to environmental noise such as light, and vibration.**
- 

### 14.6.6 Enabling FastSAT (for Masimo SpO<sub>2</sub>)

FastSAT enables rapid tracking of arterial oxygen saturation changes as may be required in urgent situations. When FastSAT is enabled, the averaging algorithm evaluates all the SpO<sub>2</sub> values and provides an averaged SpO<sub>2</sub> value that is a better representation of the patient’s current oxygen saturation status.

The reliability of FastSAT is dependent on the setting for the averaging time and the input signal. FastSAT is disabled by default. To enable FastSAT, follow this procedure:

1. Select the SpO<sub>2</sub> numeric area or waveform area to enter the **SpO2** menu.
2. Select the **Setup** tab.
3. Switch on **Fast SAT**.

### 14.6.7 Setting the Display of SIQ (for Masimo SpO<sub>2</sub>)

The signal quality indicator (SIQ) is displayed below the Pleth waveform. The SIQ is conveyed by vertical bars. The height of the bar provides an assessment of the confidence in the displayed SpO<sub>2</sub> value. The SpO<sub>2</sub> SIQ can also be used to identify the occurrence of a patient’s pulse.

The following figure shows the SpO<sub>2</sub> SIQ.

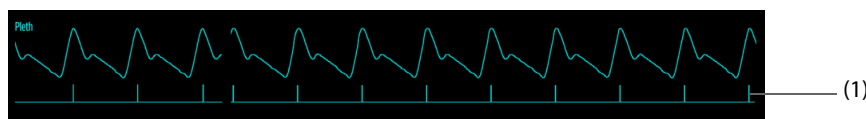

(1) Signal quality indicator (SIQ)

To set the display of SpO<sub>2</sub> SIQ, follow this procedure:

1. Select the SpO<sub>2</sub> numeric area or waveform area to enter the **SpO2** menu.
2. Select the **Setup** tab.
3. Set the switch of **Display SIQ**.

### 14.6.8 Changing Averaging Time (for Masimo SpO<sub>2</sub>)

The SpO<sub>2</sub> value displayed on the screen is the average of data collected within a specific time. The shorter the averaging time is, the quicker the equipment responds to changes in the patient’s oxygen saturation level. Contrarily, the longer the averaging time is, the slower the equipment responds to changes in the patient’s oxygen saturation level, but the SpO<sub>2</sub> measurement is more stable. For critically ill patients, selecting a shorter averaging time will help with understanding the patient’s state.

To set the averaging time, follow this procedure:

1. Select the SpO<sub>2</sub> numeric area or waveform area to enter the **SpO2** menu.
2. Select the **Setup** tab.
3. Set **Averaging**.

### 14.6.9 Changing the Sensitivity (for Mindray SpO<sub>2</sub>)

The SpO<sub>2</sub> value displayed on the screen is the average of data collected within a specific time. The shorter the averaging time is, the quicker the equipment responds to changes in the patient's oxygen saturation level. Contrarily, the longer the averaging time is, the slower the equipment responds to changes in the patient's oxygen saturation level, but the SpO<sub>2</sub> measurement is more stable. For critically ill patients, selecting shorter averaging time will help understanding the patient's state.

To set the averaging time, follow this procedure:

1. Select the SpO<sub>2</sub> numeric area or waveform area to enter the **SpO2** menu.
2. Select the **Setup** tab.
3. Set **Sensitivity**.

### 14.6.10 Setting the Display of PI

You can set whether to display PI in the SpO<sub>2</sub> parameter area. To do so, follow this procedure:

1. Select the SpO<sub>2</sub> numeric area or waveform area to enter the **SpO2** menu.
2. Select the **Setup** tab.
3. Set the switch of **Display PI**.

### 14.6.11 Changing the Pleth Waveform Speed

To set the sweep speed of Pleth waveform, follow this procedure:

1. Select the SpO<sub>2</sub> numeric area or waveform area to enter the **SpO2** menu.
2. Select the **Setup** tab.
3. Set **Speed**.

## 14.7 Changing PR Settings

### 14.7.1 Changing the PR Alarm Properties

To change the PR alarm properties, follow this procedure:

1. Select the SpO<sub>2</sub> numeric area or waveform area to enter the **SpO2** menu.
2. Select the **PR** tab → select the **Alarm** tab.
3. Set alarm properties as desired.

### 14.7.2 Changing the QRS Volume

If **Alarm Source** is set to **PR**, the QRS tone is derived from PR measurements. To set the QRS volume, follow this procedure:

1. Select the SpO<sub>2</sub> numeric area or waveform area to enter the **SpO2** menu.
2. Select the **PR** tab → select the **Setup** tab.
3. Set **QRS Volume**.

If the SpO<sub>2</sub> value is effective, the equipment also adjusts the QRS tone (pitch tone) according to the SpO<sub>2</sub> value.

### 14.7.3 Setting the PR Source

The current pulse source is displayed in the PR numeric area. PR from the current source is monitored as system pulse and generates alarms when you select PR as alarm source.

To set the PR source of pulse rate, follow this procedure:

1. Select the SpO<sub>2</sub> numeric area or waveform area to enter the **SpO2** menu.
2. Select the **PR** tab → select the **Setup** tab.
3. Set **PR Source**.

The **PR Source** list displays the currently available PR sources from top to bottom by priority. When **PR Source** is set to **Auto**, the first option is automatically selected as the PR source. If the current PR source is not available, **PR Source** is automatically switched to **Auto**.

### 14.7.4 Setting the Display of PR

You can set whether to display the PR value in the SpO<sub>2</sub> parameter area. To do so, follow this procedure:

1. Select the SpO<sub>2</sub> numeric area or waveform area to enter the **SpO2** menu.
2. Select the **PR** tab → select the **Setup** tab.
3. Set the switch of **Display PR**.

## 14.8 SpO<sub>2</sub> Troubleshooting

This section lists the problems that might occur. If you encounter the problems when using the equipment or accessories, check the table below before requesting for services. If the problem persists, contact your service personnel.

### NOTE

- For the physiological and technical alarm messages, see *D Alarm Messages*.

Problem	Solution
No SpO <sub>2</sub> numeric area or waveform area displayed on the main screen	<ol style="list-style-type: none"><li>1. Check that the SpO<sub>2</sub> is set to display in the <b>Screen Setup</b> menu. For more information, see <i>9.2.3 Defining the Normal Screen Display</i>.</li><li>2. Check that if the SpO<sub>2</sub> parameter switch is enabled. If not, enable the SpO<sub>2</sub> measurement. For more information, see <i>9.2.2 Setting the Switch for a Parameter</i>.</li><li>3. Check that the cable connections of SpO<sub>2</sub> sensor and the extension cable are tight. Replace the SpO<sub>2</sub> sensor or the extension cable if needed.</li></ol>
Dashes "--" displayed in place of numerics.	<ol style="list-style-type: none"><li>1. Check that the cable connections of SpO<sub>2</sub> sensor and the extension cable are tight. Replace the SpO<sub>2</sub> sensor or the extension cable if needed.</li><li>2. Reconnect the SpO<sub>2</sub> sensor if the alarm "<b>SpO2 Sensor Off</b>" is displayed.</li><li>3. Check the PI value. If the PI value is too low, adjust the SpO<sub>2</sub> sensor, or apply the sensor to the site with better perfusion.</li><li>4. Move the sensor to the place with weaker light, or cover the sensor with shade cloth if the alarm "<b>SpO2 Sensor Off</b>" is displayed.</li></ol>
Low amplitude SpO <sub>2</sub> signal	<ol style="list-style-type: none"><li>1. The SpO<sub>2</sub> sensor and NIBP cuff are placed on the same limb. Change a monitoring site if necessary.</li><li>2. Check the PI value. If the PI value is too low. Adjust the SpO<sub>2</sub> sensor, or apply the sensor to the site with better perfusion.</li><li>3. Check the sensor and its application site.</li></ol>
SpO <sub>2</sub> value is inaccurate	<ol style="list-style-type: none"><li>1. Check the patient's vital signs.</li><li>2. Check for conditions that may cause inaccurate SpO<sub>2</sub> readings. For more information, see <i>14.3 SpO<sub>2</sub> Measurement Limitations</i>.</li><li>3. Check the equipment or the SpO<sub>2</sub> module properly function.</li></ol>



## 14.9 Nellcor Information



### ■ Nellcor Patents

This device may be covered by one or more of the following US patents and foreign equivalents: 5,485,847, 5,676,141, 5,743,263, 6,035,223, 6,226,539, 6,411,833, 6,463,310, 6,591,123, 6,708,049, 7,016,715, 7,039,538, 7,120,479, 7,120,480, 7,142,142, 7,162,288, 7,190,985, 7,194,293, 7,209,774, 7,212,847, 7,400,919.

### ■ No Implied License

Possession or purchase of this device does not convey any express or implied license to use the device with unauthorized replacement parts which would, alone, or in combination with this device, fall within the scope of one or more of the patents relating to this device.

## 14.10 Masimo Information



### Masimo Patents

This posting serves as notice under 35 U.S.C. §287(a) for Masimo patents: <http://www.masimo.com/patents.htm>.

### No Implied License

Possession or purchase of this device does not convey any express or implied license to use the device with unauthorized sensors or cables which would, alone, or in combination with this device, fall within the scope of one or more of the patents relating to this device.

## 14.11 Masimo End-User License Agreement

THIS DOCUMENT IS A LEGAL AGREEMENT BETWEEN YOU ("PURCHASER") AND SHENZHEN MINDRAY. IF YOU DO NOT AGREE TO THE TERMS OF THIS AGREEMENT, PROMPTLY RETURN THE ENTIRE PACKAGE, INCLUDING ALL ACCESSORIES, IN THEIR ORIGINAL PACKAGE, WITH YOUR SALES RECEIPT TO SHENZHEN MINDRAY FOR A FULL REFUND.

1. **Grant of License.** In consideration of payment of the license fee, which is part of the price paid for this product, Shenzhen Mindray grants to Purchaser a nonexclusive, nontransferable license, without right to sublicense, to use the copy of the incorporated software/firmware, and documentation in connection with Purchaser's use of the Masimo Products for their labeled purpose. Shenzhen Mindray reserves all rights not expressly granted to Purchaser.
2. **Ownership of Software/Firmware.** Title to, ownership of, and all rights and interests in, any Masimo software and/or firmware and the documentation, and all copies thereof, remain at all times vested in Masimo Corporation, licensor to Shenzhen Mindray, and they do not pass to Purchaser.
3. **Assignment.** Purchaser shall not assign or transfer this License, in whole or in part, by operation of law or otherwise, without Shenzhen Mindray's prior written consent; any attempt without such consent, to assign any rights, duties or obligations arising hereunder shall be void.
4. **Copy Restrictions.** The software/firmware, mask works, circuit board layouts, and accompanying written materials are copyrighted. Unauthorized copying of the software, including software that has been modified, merged, or included with other software, or other written materials is expressly forbidden. You may be held legally responsible for any copyright infringement that is cause or incurred by your failure to abide by the terms of this license. Nothing in this license provides any rights beyond those provided by 17 U.S.C. §117.
5. **Use Restriction.** As the Purchaser, you may physically transfer the products from one location to another provided that the software/firmware is not copied. You may not electronically transfer the software/firmware from the products to any other device. You may not disclose, publish, translate, release distribute copies of, modify, adapt, translate, reverse engineer, decompile, disassemble, or create derivative works based on the Masimo Product, the software/firmware, or the written materials without the prior written consent of Masimo. Masimo Sensors that are designated for single use are licensed under Masimo patents for use on a single patient only, and are not sold. There is no license, implied or otherwise, that would allow use of single use Masimo Sensors beyond their intended single use. After use of single use Masimo Sensors, there is no further license granted by Masimo to use the sensors and they must be discarded.

6. Transfer Restrictions. The software/firmware is licensed to the Purchaser, and may not be transferred to anyone, except other end-users, without the prior written consent of Shenzhen Mindray. In no event may you transfer, assign, rent, lease, sell, or otherwise dispose of the software/firmware or the products on a temporary basis.
7. Beneficiary. Masimo Corporation is a Beneficiary of this Agreement and has the right to enforce its provisions.

U.S. Government Rights: If you are acquiring software (including the related documentation) on behalf of any part of the United States Government, the following provisions apply: the software is deemed to be "commercial software" and "commercial computer software documentation," respectively pursuant to DFAR Section 227.7202 FAR 12.212, as applicable. Any use, modification, reproduction, release, performance, display or disclosure of the software (including the related documentation) by the U.S. Government or any of its agencies shall be governed solely by the terms of this Agreement and shall be prohibited except to the extent expressly permitted by the terms of this agreement.

# 15 Monitoring Noninvasive Blood Pressure (NIBP)

---

## 15.1 NIBP Introduction

The equipment uses the oscillometric method for measuring the non-invasive blood pressure (NIBP). NIBP measurement is based on the principle that pulsatile blood flow through an artery creates oscillations of the arterial wall. The oscillometric method measures the mean pressure and determines the systolic and diastolic pressures.

NIBP monitoring is intended for adult, pediatric, and neonatal patients.

### NOTE

---

- **Blood pressure measurements determined with this device are equivalent to those obtained by a trained observer using the cuff/stethoscope auscultatory method or an intra-arterial blood pressure measurement device, within the limits prescribed by the American National Standard: manual, electronic, or automated sphygmomanometers.**
  - **NIBP measurement can be performed during electro-surgery and discharge of defibrillator.**
- 

## 15.2 NIBP Safety Information

---

### WARNING

---

- **Be sure to select the correct patient category setting for your patient before NIBP measurement. Do not apply the higher adult settings for pediatric or neonatal patients. Otherwise, it may present a safety hazard.**
  - **Do not perform NIBP measurements on patients with sickle-cell disease.**
  - **To avoid further injury, do not apply the NIBP cuff on the limb with a wound.**
  - **Use clinical judgment to determine whether to perform frequent unattended blood pressure measurements on patients with severe blood clotting disorders because of the risk of hematoma in the limb fitted with the cuff.**
  - **To avoid the risk of patient injury, do not apply the NIBP cuff on a limb that has an intravenous infusion or catheter in place. Apply the cuff on another limb if possible.**
  - **Do not apply cuff on the arm on the side of a mastectomy or lymph node clearance.**
  - **Continuous cuff pressure due to connection tubing kinking may cause blood flow interference, and resulting in harmful injury to the patient.**
  - **NIBP reading can be affected by the measurement site, the position of the patient, exercise, or the patient's physiologic condition. If you doubt the NIBP measurements, determine the patient's vital signs by alternative means, and then verify that the monitor is working correctly.**
  - **Taking NIBP measurements exert pressure on the patient's tissue. This can cause skin purpura, ischemia, and neuropathy. Periodically check the cuff site and the limb distal to the cuff for normal color, warmth and sensitivity. If there is a sign of skin change or poor distal circulation, move the cuff to another limb or stop NIBP measurements. Check more frequently when using the STAT mode or using the auto mode at short intervals. Auto NIBP measurements with one and two minute intervals are not recommended for extended periods of time.**
  - **NIBP diagnostic significance must be decided by the physician.**
- 

### CAUTION

---

- **Using IABP may cause NIBP, including PR, measurements inaccurate or failed.**
  - **Accuracy of NIBP measurement depends on using a cuff of proper size. It is essential to measure limb circumference and choose a cuff with proper size.**
-

## 15.3 NIBP Measurement Limitations

NIBP measurement may be inaccurate or impossible in the following situations:

- The patient is connected to a heart lung machine.
- Regular arterial pressure pulses are hard to detect.
- The patient has cardiac arrhythmias.
- The patient's blood pressure changes dramatically.
- The patient has poor circulation due to severe shock or hypothermia.
- NIBP cuff is applied on an limb with edematous extremity.
- The NIBP cuff is compressed by excessive movement such as shivering, seizures, or convulsions.
- The patient's blood pressure is out of measurement range.

### NOTE

- **The effectiveness of the sphygmomanometer has not been established in pregnant, including pre-eclamptic patients.**

## 15.4 Measurement Modes

The available NIBP measurement modes are listed as follows:

- Manual mode: measurement is taken on demand.
- Auto mode: repeated measurements are taken at set interval.
- STAT mode: continually rapid series of measurements are taken over a five-minute period.
- Sequence mode: continually automatic measurement are taken at set durations and intervals.

## 15.5 NIBP Display

The NIBP display shows only numerics.

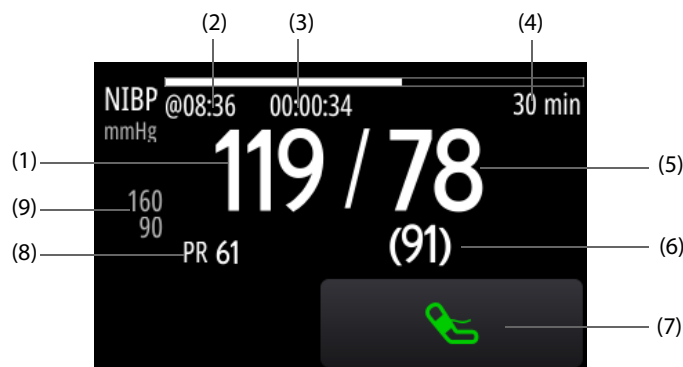

- (1) Systolic pressure
- (2) The last NIBP measurement time
- (3) Time to the next measurement (for Auto mode and Sequence mode)
- (4) Measurement mode: for Auto NIBP, interval is displayed; for Sequence mode, the current phase and interval are displayed
- (5) Diastolic pressure
- (6) Mean pressure (displayed after measurement completed) or cuff pressure (displayed during the measurement)
- (7) NIBP quick key: starts or stops NIBP measurements.
- (8) Pulse Rate
- (9) Diastolic pressure alarm limits

---

## NOTE

- If NIBP measurement fails, “XX” is displayed; if NIBP measurement is not taken, “--” is displayed.
  - Outlined NIBP numerics indicate that the measurement exceeds the NIBP timeout. So these NIBP values are not recommended for reference. The setting of NIBP Timeout can be changed in the Configuration mode only. For more information, see 22.7.4.8 NIBP Setup Tab.
- 

## 15.6 Preparing for NIBP Measurements

### 15.6.1 Preparing the Patient for NIBP Measurements

In normal use, perform NIBP measurement on a patient who is in the following position:

- Comfortably seated
- Legs uncrossed
- Feet flat on the floor
- Back, arm and feet supported

---

## NOTE

- It is recommended that the patient calms down and relaxes as much as possible before performing the measurement and that the patient do not talk during the measurement.
  - It is recommended to have the patient sit quietly for several minutes before taking the measurement.
  - Other factors that have been shown to result in an overestimation of blood pressure are labored breathing, full bladder, pain etc.
- 

### 15.6.2 Placing the NIBP Cuff

To place the NIBP cuff, follow this procedure:

1. Check that the patient category setting is correct. If not, select the patient category symbol and change the setting of **Patient Category**.
2. Connect the air tubing to the NIBP connector.
3. Determine the patient’s limb circumference.
4. Select an appropriate cuff by referring to the limb circumference marked on the cuff. The width of the cuff should be 40% (50% for neonates) of the limb circumference, or 2/3 of the length of the upper arm or the thigh. The inflatable part of the cuff should be long enough to encircle at least 50% to 80% of the limb.
5. Apply the cuff to the patient’s upper arm or leg and make sure the  $\Phi$  marking on the cuff matches the artery location. The cuff should fit snugly, but with enough room for two fingers to be placed between the cuff and the patient’s arm (on adults), and loosely on neonates with little or no air present within the cuff. Excessive tightness may cause discoloration and ischemia of the limb distal. Make sure that the cuff index line falls within the range markings on the cuff.
6. Make sure that the middle of the cuff is at the level of the heart. Otherwise correct the measurement by referring the measurement correction formula. For more information, see 15.8.10 *Correcting the NIBP Measurements*.
7. Connect the cuff to the air tubing. Check that the air tubing are not kinked or compressed, and air can pass unrestrictedly through the tubing.

---





## CAUTION

- Using a cuff of wrong size, or a cuff with twisted bladder and kinked air tubing, can cause inaccurate measurements.
- Do not touch or apply external pressure against the cuff and air tubing during NIBP measurement. This may cause inaccurate blood pressure values.

- Use care when placing the cuff on an extremity used for monitoring other patient parameters.

## 15.7 Starting and Stopping NIBP Measurements

NIBP measurements can be started and stopped by selecting  or through the **NIBP** menu.

Task		By Quick Key	From NIBP menu
Start NIBP measurements	A manual measurement	Select  .	Select <b>Start NIBP</b> .
	Auto measurements	Set the NIBP interval → select  .	Select the <b>Setup</b> tab → set <b>Interval</b> → select <b>Start NIBP</b> .
	Sequence measurements	Set the NIBP sequence → select  .	Select the <b>Sequence</b> tab → set the NIBP sequence → select <b>Start NIBP</b> .
	STAT measurements	/	Select <b>STAT</b> .
Stop NIBP measurements	Current measurement	Select  .	Select <b>Stop NIBP</b> .
	STAT measurements	Select  .	<ul style="list-style-type: none"> <li>• Select <b>Stop NIBP</b>.</li> <li>• Select <b>NIBP Stop All</b>.</li> </ul>
	All measurements (auto and sequence measurements)	/	Select <b>NIBP Stop All</b> .

## 15.8 Changing NIBP Settings

### 15.8.1 Setting the NIBP Alarm Properties

To set the NIBP alarm properties, follow this procedure:

1. Select the NIBP numeric area to enter the **NIBP** menu.
2. Select the **Alarm** tab.
3. Set alarm properties as desired.

### 15.8.2 Setting the Initial Cuff Inflation Pressure

To set the initial cuff inflation pressure, follow this procedure:

1. Select the NIBP numeric area to enter the **NIBP** menu.
2. Select **Initial Pressure**, and then select the appropriate setting.

#### NOTE

- For known hypertensive patients, you need to set initial cuff pressure to a higher value to reduce the measurement time.

### 15.8.3 Setting the NIBP Interval

For auto NIBP measurement, you need to set the interval between NIBP measurements. To set the NIBP interval, follow this procedure:

1. Select the NIBP numeric area to enter the **NIBP** menu.
2. Set **Interval**.

## 15.8.4 Selecting NIBP Start Mode

Start mode defines how NIBP auto mode works. To set the start mode, follow this procedure:

1. Select the NIBP numeric area to enter the **NIBP** menu.
2. Set **Start Mode**.
  - ◆ **Clock**: after the first measurement, the equipment automatically synchronizes NIBP automatic measurements with the real time clock. For example, if Interval is set to **20 min**, and you start NIBP auto measurement at 14: 03, the next measurement will be taken at 14: 20, and then at 14:40, 15:00, and so on.
  - ◆ **Interval**: after the first measurement, the equipment automatically repeats measurements at set interval. For example, if **Interval** is set to **20 min**, and you start NIBP auto measurement at 14:03, the next measurement will be taken at 14:23, and then at 14:43, 15:03, and so on.

## 15.8.5 Setting the Switch of NIBP End Tone

The equipment can issue a reminder tone at the completion of NIBP measurement. To set the switch of NIBP end tone , follow this procedure:

1. Select the NIBP numeric area to enter the **NIBP** menu.
2. Set the switch of **NIBP End Tone**.

## 15.8.6 Setting NIBP Sequence

The NIBP sequence measurement includes a maximum of five phases. You can individually set the duration and interval of each phase.

To set NIBP sequence, follow this procedure:

1. Select the NIBP numeric area to enter the **NIBP** menu.
2. Select the **Sequence** tab.
3. Set **Duration** and **Interval** of each phase.

## 15.8.7 Setting the NIBP Display Format

To set the NIBP display format, follow this procedure:

1. Select the NIBP numeric area to enter the **NIBP** menu.
2. Set **Display Format**.

## 15.8.8 Setting the Display of NIBP Alarm Limits

You can set whether to display the alarm limits of diastolic NIBP and mean NIBP. To do so, follow this procedure:

1. Select the NIBP numeric area to enter the **NIBP** menu.
2. Set the switch of **Display Alarm Limits**.

## 15.8.9 Setting the Display of PR

You can set whether to display the PR value in the NIBP parameter area. To do so, follow this procedure:

1. Select the NIBP numeric area to enter the **NIBP** menu.
2. Set the switch of **Display PR**.

## 15.8.10 Correcting the NIBP Measurements

The middle of the cuff should be at the level of right atrium. If the limb is not at the heart level, you need to correct the measurement:

- Add 0.75 mmHg (0.10 kPa) to the displayed value for each centimeter higher.
- Deduct 0.75 mmHg (0.10 kPa) to the displayed value for each centimeter lower.

## 15.9 Assisting Venous Puncture

You can use the NIBP cuff to cause sub-diastolic pressure to block the venous blood vessel and therefore help venous puncture. To assist venous puncture, follow this procedure:

1. Select the NIBP numeric area to enter the **NIBP** menu.
2. Set **Venipuncture Pressure**.
3. Select **Venipuncture** at the bottom.
4. Puncture vein and draw blood sample.
5. Select  to deflate the cuff. If you do not deflate the cuff, the cuff automatically deflates after a period of time (170 seconds for adult and pediatric patients, 85 seconds for neonatal patients).

During venous puncture, pay attention to the cuff pressure and the remaining time displayed in the NIBP numeric area.

## 15.10 NIBP Maintenance

NIBP maintenance includes NIBP leakage test and NIBP accuracy test. It should be performed once every year or when you doubt the NIBP measurements. NIBP maintenance should be performed by Mindray-qualified service personnel only.

## 15.11 NIBP Troubleshooting

If you encounter the problems when using the equipment or accessories, check the table by referring *D Alarm Messages* before requesting for services. If the problem persists, contact your service personnel.



# 16 Monitoring Carbon Dioxide (CO<sub>2</sub>)

---

## 16.1 CO<sub>2</sub> Introduction

CO<sub>2</sub> monitoring is a continuous, non-invasive technique for determining the concentration of CO<sub>2</sub> in the patient's airway by measuring the absorption of infrared (IR) light of specific wavelengths. CO<sub>2</sub> has its own absorption characteristic and the amount of light passing the gas probe depends on the concentration of the measured CO<sub>2</sub>. When a specific band of IR light passes through respiratory gas samples, some of IR light will be absorbed by the CO<sub>2</sub> molecules. The amount of IR light transmitted after it has been passed through the respiratory gas sample is measured with a photodetector. From the amount of IR light measured, the concentration of CO<sub>2</sub> is calculated.

CO<sub>2</sub> monitoring is intended for adult, pediatric and neonatal patients.

## 16.2 CO<sub>2</sub> Safety Information

---

### WARNING

---

- **Route all tubing away from the patient's throat to avoid strangulation.**
- 

### CAUTION

---

- **Remove the airway sample line from the patient's airway while nebulized medications are being delivered.**
  - **EtCO<sub>2</sub> values measured from the CO<sub>2</sub> module may differ from those of from the blood gas analysis.**
- 

### NOTE

---

- **The CO<sub>2</sub> module automatically suppresses physiological alarms until breathing waves have been detected. Make sure that a patient is properly connected when monitoring with the CO<sub>2</sub> module.**
- 

## 16.3 CO<sub>2</sub> Measurement Limitations

The following factors may influence the measurement accuracy:

- Leaks or internal venting of sampled gas
- Mechanical shock
- Cyclic pressure up to 10 kPa (100 cmH<sub>2</sub>O)
- Other sources of interference, if any

Measurement accuracy of the sidestream CO<sub>2</sub> module may be affected by the breath rate and inspiration/expiration (I/E) ratio. For more information, see *A.8.7 CO<sub>2</sub> Specifications*.

## 16.4 CO<sub>2</sub> Display

The CO<sub>2</sub> numeric and waveform areas provide FiCO<sub>2</sub> measurement, EtCO<sub>2</sub> measurement, awRR measurement, and a CO<sub>2</sub> waveform.

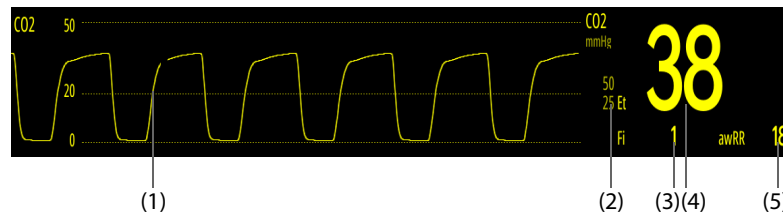

- (1) CO<sub>2</sub> waveform
- (2) CO<sub>2</sub> alarm limits
- (3) Fraction of inspired CO<sub>2</sub> (FiCO<sub>2</sub>): the lowest CO<sub>2</sub> value measured during inspiration.
- (4) End tidal CO<sub>2</sub> value (EtCO<sub>2</sub>): the highest CO<sub>2</sub> value measured during expiration.
- (5) Airway respiration rate (awRR)

## 16.5 Measuring Sidestream CO<sub>2</sub>

### 16.5.1 Preparing to Sidestream CO<sub>2</sub> Measurement

To prepare the CO<sub>2</sub> module for measurement, follow this procedure:

1. Select an appropriate sampling line according to the patient category.
2. Connect the sampling line to the CO<sub>2</sub> adapter installed on the equipment.

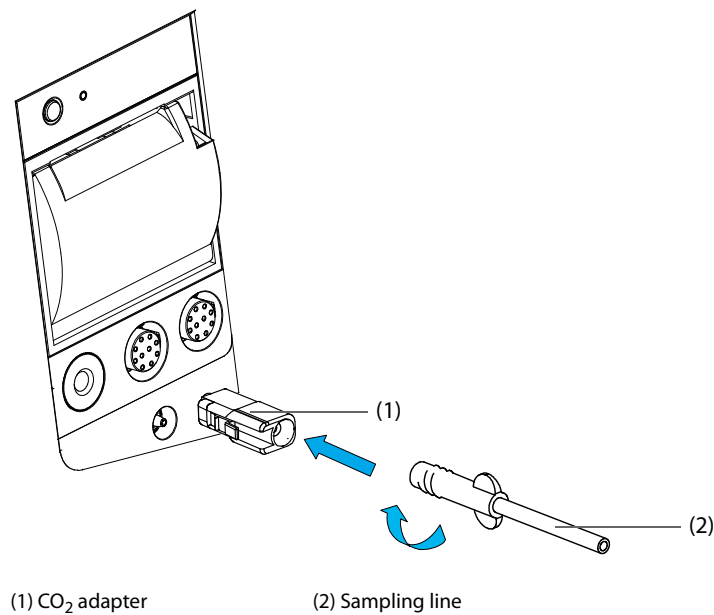

3. Connect the other end of the gas sample line to the patient.
  - ◆ For intubated patients requiring an airway adapter, install the airway adapter between the patient circuit and the ventilator Y-piece.

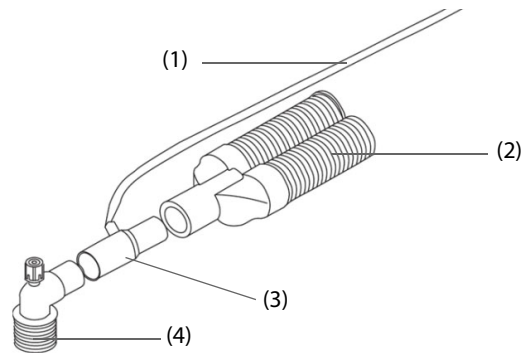

- |                    |                               |
|--------------------|-------------------------------|
| (1) Sample line    | (2) Connect to the ventilator |
| (3) Airway adapter | (4) Connect to the patient    |

- ◆ For non-intubated patients, place the nasal cannula onto the patient.



4. Connect the gas outlet to the scavenging system using an exhaust tube.

After the equipment is turned on, the CO<sub>2</sub> module enters the measure mode by default and prompts "CO<sub>2</sub> Starting". CO<sub>2</sub> measurements can be performed after the start-up is completed.

---

### CAUTION

- Do not apply adult or pediatric sampling line to the neonate patient. Otherwise, patient injury could result.
- Connect the gas outlet to the scavenging system when measuring CO<sub>2</sub> using the sidestream CO<sub>2</sub> module.

---

### NOTE

- To extend the lifetime of the sampling line and CO<sub>2</sub> module, set the operating mode to Standby mode when CO<sub>2</sub> monitoring is not required.
  - If not necessary, do not disconnect the CO<sub>2</sub> adapter from the equipment after the first installation. This reduces the risk of the CO<sub>2</sub> adapter becoming lost or damaged.
  - When sample gas of 37 °C, sample flowrate of 50 ml/min, room temperature of 23 °C, 100% RH, the sampling line with a general type should be replaced once at most every 8 hours, and the sampling line with a humidified type should be replaced once at most every 72 hours.
-

## 16.5.2 Zeroing the Sidestream CO<sub>2</sub> Module

The sidestream CO<sub>2</sub> module performs a zero calibration automatically when needed. Once the zero calibration is started, the CO<sub>2</sub> module stops measuring and a prompt **“Zeroing”** is displayed in the CO<sub>2</sub> numeric area.

After the zero calibration is completed, the CO<sub>2</sub> module reacquires the CO<sub>2</sub> readings. During the reacquisition period, **“Zero Recovering”** is displayed in the CO<sub>2</sub> numeric area. Valid data will reappear 30 seconds after the zero calibration is started. You can hide the display of the prompt **“Zero Recovering”**, but values displayed during the reacquisition period may not be accurate.

The automatic zero calibration will not start in the following conditions:

- Physiological alarms related to CO<sub>2</sub> are active.
- An apnea alarm is active.
- No breath has been detected for over 30 seconds.

You can also perform the zero calibration manually. For more information, see *25.6.1 User Maintenance Settings*.

### NOTE

---

- **The CO<sub>2</sub> module temporally stops measuring during zeroing.**
- 

## 16.6 Changing CO<sub>2</sub> Settings

### 16.6.1 Changing the CO<sub>2</sub> Alarm Properties

To change the CO<sub>2</sub> alarm properties, follow this procedure:

1. Select the CO<sub>2</sub> numeric area or waveform area to enter the **CO2** menu.
2. Select the **Alarm** tab.
3. Set alarm properties as desired.

### 16.6.2 Setting the CO<sub>2</sub> Waveforms

To set the CO<sub>2</sub> waveforms, follow this procedure:

1. Select the CO<sub>2</sub> numeric area or waveform area to enter the **CO2** menu.
2. Select the **Setup** tab.
3. Separately set **Waveform Type, Speed, Scale, Scale**.

### 16.6.3 Setting the RR Source

To set the respiration rate (RR) source, follow this procedure:

1. Select the CO<sub>2</sub> numeric area or waveform area to enter the **CO2** menu.
2. Select the **Setup** tab.
3. Set **RR Source**.

When the current RR source does not have valid measurement, the system will automatically switch **RR Source** to **Auto**.

### 16.6.4 Entering the Standby Mode

You can set the CO<sub>2</sub> module to one of the following modes according to the module status:

- Select **Measure** mode when you use the CO<sub>2</sub> module for monitoring.
- Select **Standby** mode when you do not use the CO<sub>2</sub> module to prolong the service life of the CO<sub>2</sub> module.

The default operating mode is **Measure**. If you do not use the CO<sub>2</sub> module, you can put the CO<sub>2</sub> module into the standby mode. This can prolong the service life of the CO<sub>2</sub> module. To do so, follow this procedure:

1. Select the CO<sub>2</sub> numeric area or waveform area to enter the **CO2** menu.
2. Select the **Setup** tab.
3. Set **Operating Mode** to **Standby**.

### 16.6.5 Setting the Time before Auto Standby

You can configure the CO<sub>2</sub> module to automatically enter the standby mode after a configured period of time if no respiration is detected since the last detected respiration. To set the time before auto standby, follow this procedure:

1. Select the CO<sub>2</sub> numeric area or waveform area to enter the **CO2** menu.
2. Select the **Setup** tab.
3. Set **Auto Standby**.

### 16.6.6 Setting Humidity Compensation

The presence of humidity in breathing circuit may raise the CO<sub>2</sub> reading. For the sidestream CO<sub>2</sub> module, you can switch on or off humidity compensation to correct the CO<sub>2</sub> reading according to actual condition.

- Body Temperature and Pressure Saturated Gas (BTPS), or wet gas
- Ambient Temperature and Pressure Dry (ATPD), or dry gas

The CO<sub>2</sub> partial pressure is calculated as follows:

- ATPD:  $P_{CO_2}(mmHg) = CO_2(vol\%) \times P_{amb} / 100$
- BTPS (sidestream):  $P_{CO_2}(mmHg) = CO_2(vol\%) \times (P_{amb} - 47) / 100$

Where,  $P_{CO_2}(mmHg)$  = partial pressure,  $vol\%$  = CO<sub>2</sub> concentration,  $P_{amb}$  = ambient pressure, and unit is mmHg.

To set the humidity compensation, follow this procedure:

1. Select the CO<sub>2</sub> numeric area or waveform area to enter the **CO2** menu.
2. Select the **Setup** tab.
3. Set **BTPS Compensation**.
  - ◆ Switch on for BTPS.
  - ◆ Switch off for ATPD.

### 16.6.7 Setting the Gas Compensation

The presence of interfering gas affects the CO<sub>2</sub> measurement. To get the best possible measuring result, it is needed to set the gas compensation. The configured concentration of the interfering gas should be in accordance with its actual proportion.

---

---

#### WARNING

---

- **Make sure to use the appropriate compensations. Inappropriate compensations may cause inaccurate measurement values and result in misdiagnosis.**
- 
- 

To set the gas compensation, follow this procedure:

1. Select the CO<sub>2</sub> numeric area or waveform area to enter the **CO2** menu.
2. Select the **Setup** tab.
3. Set the compensation according to the actual condition.

### 16.6.8 Changing Barometric Pressure

The sidestream CO<sub>2</sub> module has the function of automatic barometric pressure compensation (the system automatically measures the barometric pressure to which the equipment is exposed).

## 16.7 Performing the Leakage Test

When measuring CO<sub>2</sub> using the sidestream CO<sub>2</sub> module, leakage test is required every time before the CO<sub>2</sub> measurement. To perform the CO<sub>2</sub> leakage test, follow this procedure:

1. Connect the measuring accessories.
2. Wait until the startup finishes. Completely block the gas inlet on the sidestream CO<sub>2</sub> module. Then the alarm message "**CO2 Airway Occluded**" is displayed.
3. Block the gas inlet for another one minute.
4. Select the CO<sub>2</sub> numeric area or waveform area to enter the **CO2** menu.
5. Select the **Maintenance** tab.
6. Check that the current flow rate is less than 10ml/min.
7. If the flow rate is equal to 10ml/min or greater, there is a leak. Perform the leakage test again. If the problem persists, contact your service personnel.

## 16.8 CO<sub>2</sub> Calibration

For the sidestream CO<sub>2</sub> module, a calibration is needed every year or when the measured values have a great deviation. For details about the calibration, contact the service personnel.

---

### CAUTION

---

- **Connect the gas outlet to the scavenging system when calibrating the CO<sub>2</sub> module.**
- 

## 16.9 CO<sub>2</sub> Troubleshooting

This section lists the problems that might occur. If you encounter the problems when using the equipment or accessories, check the table below before requesting for services. If the problem persists, contact your service personnel.

---

### NOTE

---

- **For the physiological and technical alarm messages, see *D Alarm Messages*.**
- 

Problem	Solution
EtCO <sub>2</sub> measurements too low	<ol style="list-style-type: none"><li>1. Ventilate the room if the environmental CO<sub>2</sub> concentration is too high.</li><li>2. Check the sample line and connectors for leakage.</li><li>3. Check the patient status.</li></ol>

# 17 Clinical Assistive Applications

---

## 17.1 Rescue Training

The equipment provides rescue training for rescue procedures and CPR trainings.

Based on training scenario, you can choose either a standalone training by using the equipment only, or a online training by connecting the equipment and rescue training system.

To access the Training mode, select the **Main Menu** quick key and select **Training mode** from the **Mode** column.

For details about rescue training, see *BeneHeart Series Rescue Training Operator's Manual*.

---

### WARNING

- **Patient therapy and monitoring automatically end when you access the Training mode. The equipment restarts after you exist the Training mode.**

---

### NOTE

- **A license is required for rescue training.**
- 

## 17.2 Glasgow Coma Scale (GCS)

The Glasgow Coma Scale (GCS) was described in 1974 by Graham Teasdale and Bryan Jennett as a way to determine the patient's level of consciousness with an acute brain injury. The GCS score is the sum of the score in each of three components: eye opening (E), verbal response (V), and motor response (M).

The available GCS scoring types are listed as follows:

- GCS score: is applicable to patients above two years old.
- Pediatric Glasgow Coma Scale (P-GCS) score: is applicable to patients of two years old or younger.

GCS is intended for adults, pediatric and neonatal patients.

---

### CAUTION

- **GCS is intended as an adjunct in patient assessment and must be used in conjunction with observation of clinical signs and symptoms.**
- **GCS is not applied to patients that are sedated, muscularly relaxed, with artificial airway, drunk, or in status epilepsies.**
- **GCS is not applied to deaf people and patients having language barrier or with mental disorder.**
- **When applied to children under five years old or elder people who are slow, the GCS score might be low.**

---

### NOTE

- **A license is required for GCS.**
-

## 17.2.1 Entering the GCS Window

To enter the GCS window, select the **Score** quick key.

The following figure shows the GCS window when P-GCS score is applied.

(1) Subscore

(2) Confirmation time

(3) Total score

(4) Risk level: the level of risk increases from top down. The current level is indicated with a black box.

## 17.2.2 Setting the GCS Scoring Type

According to the settings of **Patient Category** and **Age** in the **Patient Management** menu, the equipment automatically switches the GCS scoring type.

- If **Patient Category** is set to **Adult**, **Score Type** is switched to **GCS Score**.
- If **Patient Category** is set to **Ped**, **Age** is unspecified or set to be greater than two years old, **Score Type** is switched to **GCS Score**.
- If **Patient Category** is set to **Ped**, **Age** is set to two years old or younger, **Score Type** is switched to **P-GCS Score**.
- If **Patient Category** is set to **Neo**, **Score Type** is switched to **P-GCS**.

To manually change the GCS scoring type, set **Score Type** to the desired item in the GCS window.

### NOTE

- **Manually setting Score Type has no impact on settings of Patient Category and Age in the Patient Management menu.**

## 17.2.3 Performing GCS Scoring

To perform GCS scoring, follow this procedure:

1. Respectively select an item representing the patient's status from the **Eye Opening**, **Verbal Response** and **Motor Response** columns.
2. Select **Confirm** to accept the total score.
3. If you want to discard the current score, select **Reset**.

The following table lists the GCS score criteria.

Risk Level	Score Range	Background Color	Description
Mild	13 to 15	White	Normal or mild brain injury
Moderate	9 to 12	Yellow	Moderate or severe brain injury
Severe	3 to 8	Red	Patient dead or vegetative state



## 17.2.4 Reviewing GCS Trends

To review GCS trends, select **Image Review** in the GCS window. A tabular trend with all measured data, any calculated scores and subscores is displayed. For more information, see *18.5 Reviewing Tabular Trends*.

## 17.3 Early Warning Score (EWS)

The Early Warning Score (EWS) helps to recognize the early sign of deterioration in patients based on vital signs and clinical observations. Depending on the score calculated, appropriate recommendations are given.

The available scoring types are listed as follows:

- Modified Early Warning Score (MEWS)
- National Early Warning Score (NEWS)
- National Early Warning Score 2 (NEWS2)

### WARNING

- **EWS should not be used as the sole basis for diagnosis or therapy decisions. It is not intended to replace the competent judgment of a clinician. The EWS scores and recommended actions must be used in conjunction with observation of clinical signs and symptoms.**
- **MEWS and NEWS are not applicable to pregnant woman, COPD (Chronic Obstructive Pulmonary Disease) patients and patients under 16 years old. NEWS2 is not applicable to pregnant woman and patients under 16 years old.**

### NOTE

- **A license is required for EWS.**

### 17.3.1 Entering the EWS Window

To enter the EWS window, select the **Score** quick key and then select the EWS scoring type tab.

The following figure shows the EWS window when the NEWS2 is applied.



- (1) Subscore area: displays subscores and measured data for each scoring item. indicates that the value is manually entered.
- (2) Score calculating time
- (3) Total score
- (4) Risk level: the level of risk increases from top down. The current level is indicated with a white box.

## 17.3.2 Performing EWS Scoring

To perform scoring, follow this procedure:

1. If the previous scoring is not confirmed, select **Confirm** to save the score. You can also select **Reset** to clear the score and refresh values of currently monitored parameters and relevant subscores.
2. Set **Score Type**. If NEWS2 is applied, you should set **SpO2 Scale**.
  - ◆ **Scale 1:** is applicable to patient without hypercapnic respiratory failure.
  - ◆ **Scale 2:** is applicable to patient with a prescribed oxygen saturation requirement of 88 to 92%. For example, patients with hypercapnic respiratory failure.
3. All measured values are automatically displayed and refreshed. You can manually enter the value.  indicates that the value is manually entered.
4. Select **Calculate** to get the total score.
5. Select **Confirm** to accept the total score. Selecting **Cancel** discards the score.

### NOTE

- **The decision to use the SpO2 Scale 2 should be made by a competent clinical decision maker and should be recorded in the patient's clinical notes.**
- **EWS total score can be calculated only when all required measured items have been measured or entered.**

## 17.3.3 Reviewing EWS Trends

To review EWS trends, select **Image Review** in the EWS window. A tabular trend with all measured data, any confirmed score and score type is displayed. For more information, see *18.5 Reviewing Tabular Trends*.

## 17.4 HEART Score

The HEART score was described in 2008 by Six AJ and Brackus BE as a way to evaluate the risk for a cardiac event. The HEART score is the sum of the score in each of five components: medical history, ECG, age, risk factors, and troponin. The HEART score effectively assesses patients with chest pain, identifies low-risk patients for early safe discharge, and identifies potentially high-risk patients for early intervention.

HEART score is intended for adults only.

### NOTE

- **A license is required for HEART score.**

### 17.4.1 Entering the HEART Score Window

To enter the HEART window, select the **Score** quick key and then select the **HEART** tab.

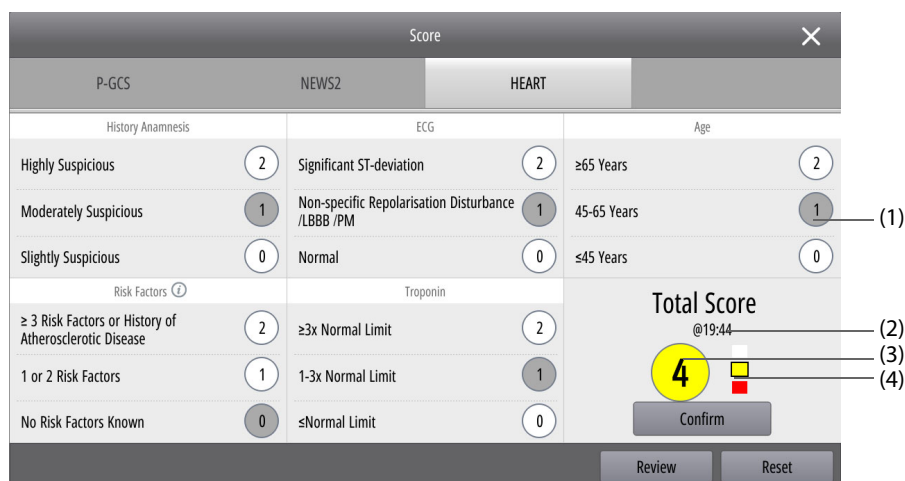

Score			
P-GCS	NEWS2	HEART	
History Anamnesis		ECG	Age
Highly Suspicious	2	Significant ST-deviation	2
Moderately Suspicious	1	Non-specific Repolarisation Disturbance /LBBB /PM	1
Slightly Suspicious	0	Normal	0
Risk Factors		Troponin	
≥ 3 Risk Factors or History of Atherosclerotic Disease	2	≥3x Normal Limit	2
1 or 2 Risk Factors	1	1-3x Normal Limit	1
No Risk Factors Known	0	≤Normal Limit	0
		<b>Total Score</b> @19:44 <b>4</b> Confirm	
		Review Reset	

(1) Subscore

(2) Confirmation time

(3) Total score

(4) Risk level: the level of risk increases from top down. The current level is indicated with a black box.

## 17.4.2 Performing HEART Scoring

To perform HEART scoring, follow this procedure:

1. Respectively select an item representing the patient's status from the History Anamnesis, ECG, Age, Risk Factors and **Troponin** columns.
2. Select **Confirm** to accept the total score.
3. If you want to discard the current score, select **Reset**.

The following table lists the HEART score criteria.

Risk Level	Score Range	Background Color	Description
Mild	0 to 3	White	Discharge can be an option.
Moderate	4 to 6	Yellow	Clinical observation and further investigations are needed.
Severe	7 to 10	Red	Immediate invasive treatment is needed.

## 17.4.3 Reviewing HEART Score Trends

To review HEART score trends, select **Image Review** in the HEART Score window. A tabular trend with all measured data and any calculated scores is displayed. For more information, see *18.5 Reviewing Tabular Trends*.

## 17.5 Traumatic Brain Injury (TBI) Assessment

The Brain Trauma Foundation (BTF) released the Guidelines for the Management of Severe Traumatic Brain Injury in 2016. It provided recommendations to SpO<sub>2</sub>, SBP, and EtCO<sub>2</sub> limits for the pre-hospital management of patients with traumatic brain injury (TBI), also pointed out that a lower GCS score may be predictive for severe TBI.

For patients in coma (for example, drunk, intubated or sedated), GCS is not so accurate. Combined with GCS and vital signs monitoring, the traumatic brain injury (TBI) assessment displays GCS and parameter trends, gives warnings when potential TBI is detected.

The TBI assessment provides an evaluation for the patient recovery from severe trauma (GCS score  $\leq$  8) or cardiac arrest to ensure good prognosis.

TBI assessment is intended for adults, pediatric, and neonatal patients.

### NOTE

- **A license is required for TBI assessment.**

## 17.5.1 Entering the TBI Assessment Window

To enter the TBI Assessment window, select the **TBI** quick key.

The following figure show the TBI Assessment window.

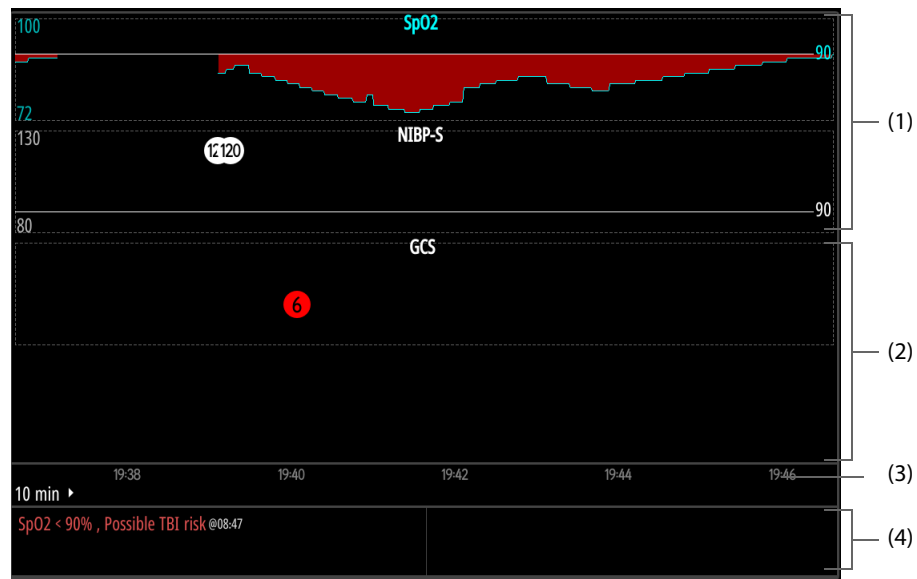

- (1) TBI parameter trends area: displays trends of SpO<sub>2</sub>, EtCO<sub>2</sub> and systolic blood pressure (SBP). The SBP value below the limit is indicated with a red background.
- (2) GCS score trends area: displays all confirmed GCS scores and subscores.
- (3) Time scale
- (4) TBI warning area: displays TBI warnings.

## 17.5.2 Setting the TBI Trends Interval

To set the trends interval, select the time interval in the TBI Assessment window.

## 17.5.3 Performing GCS Scoring

To perform GCS scoring, select **GCS Score** below the TBI Assessment window. For more information, see *17.2.3 Performing GCS Scoring*.

## 17.5.4 Viewing TBI Warnings

TBI warnings are given in the following conditions:

- GCS total score is  $\leq 8$ .
- **Patient Category** is set to **Neo**, SBP value is below 60 mmHg.
- **Patient Category** is set to **Ped**, **Age** is unspecified or set to be greater than 10 years old, SBP value is below 90 mmHg.
- **Patient Category** is set to **Ped**, **Age** is set to be 1 to 10 years old, SBP value is below  $(70 + 2 \times \text{Age})$  mmHg.
- **Patient Category** is set to **Neo**, **Age** is set to be 12 moths old or younger, SBP value is below 70 mmHg.
- **Patient Category** is set to **Adult**, SBP value is below the limit. Limits for TBI warning can be changed in Configuration mode only. For more information, see *22.7.6 TBI Warning Setup Menu*.
- The SpO<sub>2</sub> and EtCO<sub>2</sub> values are below the limits. The TBI threshold can be changed in Configuration mode only. For more information, see *22.7.6 TBI Warning Setup Menu*.

### **17.5.5 Reviewing TBI Events**

When a TBI warning is given, a TBI event is automatically generated. To review TBI events, select TBI warning area or select **Image Review** below the TBI Assessment window. For more information, see *18.7 Reviewing Events*.

### **17.5.6 Exiting the TBI Assessment Window**

To exit the TBI Assessment window, select **Exit** below the TBI Assessment window.

**This page intentionally left blank.**

# 18 Review

## 18.1 Review Introduction

The **Review** window provides various types of trend data: graphic, tabular, event, full disclosures, helping you to evaluate the development of a patient's condition.

## 18.2 Entering the Review Window

To enter the **Review** window, select the **Main Menu** quick key and select the desired tab from the **Review** column.

## 18.3 Review Window Display

Each review page of the **Review** window has a similar structure. The following figure shows the **Graphic Trends** review page.

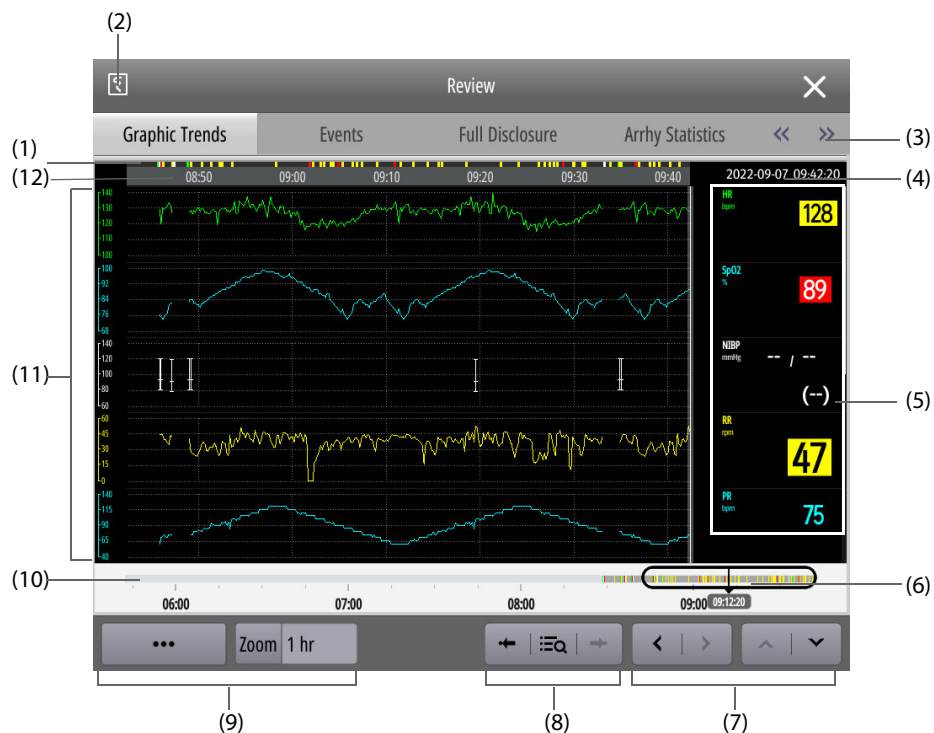

- (1) Window time scale: indicates the time within the time of **Zoom** set in the current window. The time with a color indicates an event occurred at this time.
- (2) Recorder key: prints the trend data through the recorder.
- (3) Review tab: goes to the corresponding review page. Selecting <<< or >>> can display more tabs.
- (4) Cursor time: the date and time specified by the cursor. If an event has occurred at this time, the alarm of the highest priority is displayed at the top.
- (5) Numeric area: displays numerics at the cursor time.
- (6) Slider: indicates the position of current window time in the entire time length. The slider size is dependent on the time of **Zoom** set in the current window. Moving the slider can locate the trend data at a specified time and accordingly refresh data in the current window.
- (7) Page key: turns the pages if the trend data is displayed more than one page.

- (8) Event-related quick key: views and locates the event.
- (9) Settings item: sets the display of the current window. **...** indicates available items are more than one. Selecting **...** can display more settings items.
- (10) Trend scale: indicates the time scale for all trends.
  - ◆ Dark grey portion represents time length for reviewable trend data.
  - ◆ Light grey portion represents time length for unavailable trend data.
- (11) Waveform area: displays trend curves.
- (12) Cursor

## 18.4 General Operations in the Review Window

This section describes general operations for all review pages.

### 18.4.1 Viewing Trend Data

To view trend data, choose any of the following ways:

- Move the cursor to view trend data within the time of **Zoom**.
- Swipe left or right across the current review page to view trend within the time of **Zoom**.
- Moving the slider to view the reviewable trend data.
- Scroll up and down the current review page to view trend data more than one page.
- Select **<** or **>** to view trend data more than one page.
- Select **⤴** or **⤵** to view trend data more than one page.

### 18.4.2 Locating Events

To view events, choose any of the following ways:

- Select **⏪** or **⏩** to view the previous or next event.
- Select **☰** and select the desired event from the event list.

## 18.5 Reviewing Tabular Trends

The **Tabular Trends** review page displays trend data in a tabular form.

To review tabular trends, follow this procedure:

1. Enter the **Tabular Trends** review page in any of the following ways:
  - ◆ Select the **Main Menu** quick key **→** from the **Review** column select **Tabular Trends**.
  - ◆ Select the parameter list from the parameter numerics area.
  - ◆ Select **Review** in any scoring window.
2. Select **...** **→ Trend Group**, define the content of displayed trend data.
3. Select **Interval**, define the interval of displayed trend data. A longer interval may be more informative or applications, where the patient's status typically changes more gradually. Short interval is especially suited for applications, where the clinical situation may change very quickly.
  - ◆ **5 sec, 30 sec**: displays a maximum of 4 hours of tabular trends at a specified time.
  - ◆ **1 min to 3 hrs**: displays a maximum of 120 hours of tabular trends at a specified time.
  - ◆ **NIBP**: displays the tabular trends when NIBP measurements are acquired.
  - ◆ **EWS, GCS, HEART**: displays total scores and parameter measurements acquired at the scoring time.



## 18.6 Reviewing Graphics Trends

The **Graphic Trends** review page displays trend data in a graphic form.

To review graphics trends, follow this procedure:

1. Select the **Main Menu** quick key → from the **Review** column select **Graphic Trends**.
2. Select **...** → **Trend Group**, define the content of displayed trend data.
3. Select **...** → **Trends**, set the number of displayed waveforms.
4. Select **Zoom**, define the interval of displayed trend data.
  - ◆ **8 min**: displays a maximum of one hour of tabular trends at a specified time.
  - ◆ **30 min to 4 hrs**: displays a maximum of 4 hours of tabular trends at a specified time.
  - ◆ **8 hrs, 12 hrs, 24 hrs, 48 hrs**: displays a maximum of 120 hours of tabular trends at a specified time.

## 18.7 Reviewing Events

The equipment stores events in real time, including alarm events, manual events and operational events. Operational event are generated by performing the therapy (such as AED, manual defibrillation, CPR compressions and pacing), rescue debriefing or TBI assessment, taking a screenshot, or operating the system.

### NOTE

---

- **A total loss of power has no impact on the events stored.**
  - **Alarms are saved as events and will be maintained if the equipment is powered down. The time of equipment power down is not recorded as an event and cannot be reviewed.**
  - **Earlier events will be overwritten by later ones if the capacity is reached.**
- 

### 18.7.1 Viewing the Event List

The **Events** review page displays all events in a list. Events are displayed in descending chronological order. The most recent event is displayed at the top.

The event type is indicated with a different color at the left of each event.

- Red: high priority alarm event
- Yellow: medium priority alarm event, low priority alarm event
- White: system event, TBI event, rescue statistical event
- Green: manual event, therapy event, screenshot event

To view the event list, follow this procedure:

1. Enter the **Events** review page in any of the following ways:
  - ◆ Select the **Main Menu** quick key → from the **Review** column select **Events**.
  - ◆ Select **Review** in any specified window (for example, **Resus Record** window or 12-lead ECG window).
2. Select , define the date and time of displayed events.
3. Select **Filter**, select a desired event type from the pop-up list.
4. If only arrhythmia events with alarms off are needed, select **...** and select **Show Disabled Arrhythmia Alarms**.

## 18.7.2 Viewing Event Details

When an event occurs, you can view all related parameter numerics at the event time and three event-related waveforms within 16 seconds before and after the event. For screenshot events, you can view picture details.

To view detailed waveforms and parameter numerics, follow this procedure:

1. Enter the Event List review page.
2. Select the desired event. A event with a white box indicates it is selected.
3. Select **Detail**.
4. Set the switch of **Beat Anno**. If switched on, white beat labels are displayed on the first ECG waveform, which indicate heart beats classification and explain suspected, missed, or false arrhythmia. Heart beats are classified as follows:
  - ◆ N: Normal
  - ◆ V: Ventricular ectopic
  - ◆ S: Supraventricular premature
  - ◆ P: Paced
  - ◆ L: Learning
  - ◆ ?: Insufficient information to classify beats
  - ◆ I: Inoperative (for example, Lead Off)
  - ◆ M: Missed beat
5. Select **...**, respectively set **Speed** and **ECG Gain**.

Selecting **Event List** can return to view the event list.

---

### CAUTION

- **Ensure that you have selected the optimal leads with the best waveform amplitude and the highest signal-to-noise ratio. Selecting the optimal leads is important for detecting beats, classifying beats, and detecting ventricular fibrillation.**

---

### NOTE

- **The switch setting for Beat Anno: on the Events review page is relevant to that on the Full Disclosure review page.**

## 18.7.3 Viewing Arrhythmia Analysis

The **Arrhy Statistics** review page displays all arrhythmia events occurred within the recent 24 hours, the alarm priority, total times, duration, starting time and end time for each event, compressed waveforms and details at the event time. The event duration and alarm priority are indicated with different colors.

To view arrhythmia analysis, follow this procedure:

1. Select the **Main Menu** quick key → from the **Review** column select **Arrhy Statistics**.
2. If needed, select **...** and select the desired arrhythmia events.
  - ◆ **Show Disabled Arrhythmia Alarms:** only arrhythmia events with alarms off are displayed.
  - ◆ **High Quality Arrhythmia Alarms Only:** arrhythmia events with obvious noise and insignificant characteristics.
3. Select the desired arrhythmia event from the list at the left, view compressed waveforms at the event time.
4. Select **Back** to the arrhythmia event list.



Selecting anywhere on compressed waveforms for an arrhythmia event can view event details.

## 18.8 Reviewing Full Disclosure

The **Full Disclosure** review page displays compressed waveforms, full waveforms and numerics.

### 18.8.1 Selecting Compressed Waveforms

Before reviewing compressed waveforms, you need to select waveforms to be stored and displayed. To do so, follow this procedure:



1. Select the **Main Menu** quick key → from the **Review** column select **Full Disclosure**.
2. Select **Setup** → select the **Storage** tab, and set the desired waveforms to be stored.
3. Select the **Display(Maximum: 3)** tab, and set the desired waveforms to be displayed.
4. Select  to exit the **Select Waveform** menu.
5. Select , respectively set **Scale** and **Duration**.

#### NOTE

- **The more waveforms are selected for storage, the shorter waveform storage time becomes. If you select too many waveforms, the claimed maximum time of full disclosure may not be reached due to storage limit. Please exert caution when selecting waveforms.**

### 18.8.2 Viewing Details of Compressed Waveforms

To view details of compressed waveforms, follow this procedure:

1. Enter the **Full Disclosure** review page.
2. Select the desired compressed waveforms.
3. Select **Detail**.
4. Change the settings of compressed waveforms.
5. Set the switch of **Beat Anno**: For more information about heart beats classifications, see *18.7.2 Viewing Event Details*.
6. Select , respectively set **Speed** and **ECG Gain**.
7. Select  → select **Save As Event** to save the desired event.

Selecting **Overview** can return to select compressed waveforms.

## 18.9 Reviewing 12-Lead ECG Analysis

At the completion of the 12-lead ECG auto measurement, a 12-lead ECG analysis event is automatically saved generated. For more information, see *12 Resting 12-Lead ECG Analysis*.

The **12-lead ECG** review page displays the patient information, 12-lead ECG waveforms, measurement and diagnosis results. If the patient's date of birth or gender is not inputted, you can select the patient information or  to complete it.

To review a 12-lead ECG analysis event, follow this procedure:

1. Enter the **12-lead ECG** review page in either of the following ways:
  - ◆ Select the **Main Menu** quick key → from the **Review** column select **Tabular Trends**.
  - ◆ Select **Review** below the 12-Lead ECG window.
2. Change the display of 12-lead ECG waveforms.
  - ◆ **Speed**: sets the waveform speed.
  - ◆ **Gain**: sets the waveform size.
  - ◆ **Layout**: sets the waveform layout.
3. Select **Median Complex**. A short vertical bar appears above each waveform, marking the start and end position of P-wave and QRS-wave and the end position of T-wave.

Selecting **Waveform** can return to view 12-lead ECG waveforms.

## 18.10 Printing Trend Data

To print trend data, select  from the desired review page. For screenshot events, the printing for event details is not available.

# 19 Printing

---

## 19.1 Recorder

The equipment is configured with a build-in recorder.

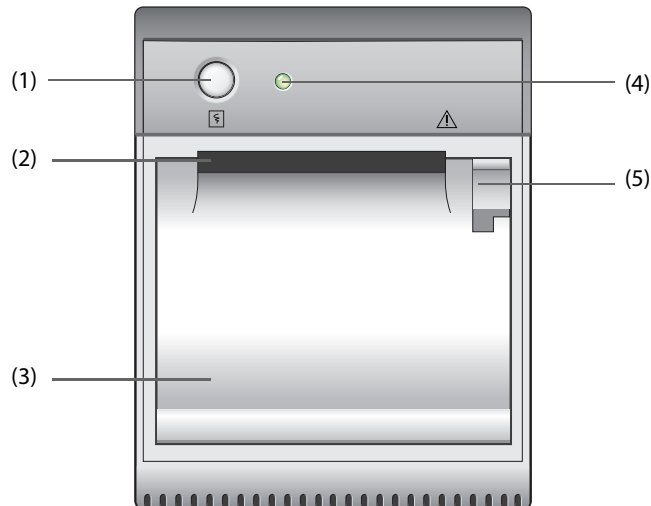

- (1) Recorder button: starts or stops printing a realtime report.
- (2) Paper outlet
- (3) Recorder door
- (4) Recorder indicator
  - ◆ On: when the recorder works correctly.
  - ◆ Off: when the equipment is switched off.
  - ◆ Flashes: if an error occurred to the recorder.
- (5) Latch: pull it backward to open the recorder door.

## 19.2 List of Reports

The equipment can print out the following reports through the recorder:

- Realtime report
  - ◆ Real-time waveform report
  - ◆ ST realtime report
  - ◆ QT realtime report
  - ◆ Event real-time report, including charging event, shock event and 12-lead analysis event
- Physiological alarm report
- Frozen waveform report
- Review reports
  - ◆ Tabular trends review report
  - ◆ Graphic trends review report
  - ◆ Physiological event review report
  - ◆ Full disclosure review report

- ◆ 12-lead analysis review report
- Rescue record report
- Summary report
- Auto test report
- System configuration report

For details about alarms printing, see *10 Alarms*.

For details about specific function printing, see corresponding chapters of this manual.

## 19.3 Loading Paper

To load paper, follow this procedure:

1. Use the latch at the upper right of the recorder door to pull the door open.
2. Insert a new roll into the compartment as shown below. Feed the paper through and pull some paper out from the top of the roller.

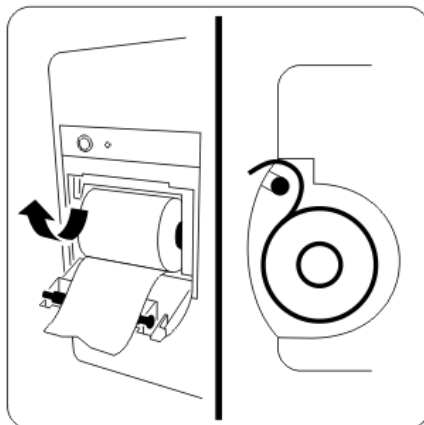

3. Close the recorder door.

---

### CAUTION

---

- **Use only specified thermal paper. Otherwise, it may cause damage to the recorder's printhead, the recorder may be unable to print, or poor print quality may result.**
  - **Never pull the recorder paper with force when a recording is in process. Otherwise, it may cause damage to the recorder.**
  - **Do not leave the recorder door open unless you reload paper or remove troubles.**
- 

## 19.4 Printing the Summary Report

The summary report provides you an overview of operations on the equipment after it is turned on. The summary report will not be saved after the equipment is turned off.

The summary report includes the startup time, total number of shocks, pacing time, operating time from the startup to printing, all occurred events and corresponding HR values, a comment column.



To print the summary report, select the **Main Menu** quick key and select **Event Summary** from the **Other** column.

## 19.5 Starting the Printing

Printing can be started manually or automatically.

### 19.5.1 Manually Starting the Printing

To manually start a recording, choose either of the following ways:

- Press the Recorder button  on the recorder.
- Select  in the current menu or window.

### 19.5.2 Automatically Starting the Printing

In the following conditions, you can set the recorder to automatically start the printing:

- A parameter alarm is triggered. For more information, see *19.7.2 Enabling Auto Printing When an Alarm Occurs*.
- An event is triggered, such as a charge event or shock event. The settings of **Auto Record** can be changed in the Configuration mode only. For more information, see *22.7.7 Record Setup Menu*.
- An auto test is performed. The switch setting of **Auto Test Report** can be changed in the Configuration mode only. For more information, see *22.7.7 Record Setup Menu*.

## 19.6 Stopping the Printing

Printing can be stopped manually or automatically.

### 19.6.1 Manually Stopping the Printing

To manually stop the printing, press the Recorder button  on the recorder.

You can also manually stop the printing by clearing all printing tasks. For more information, see *19.6.3 Clearing Printing Tasks*.

### 19.6.2 Automatically Stopping the Printing

Printing automatically stops in the following conditions:

- The printing is completed.
- The recorder runs out of paper.
- The recorder fails to work due to technical faults.
- The operating mode is changed.

### 19.6.3 Clearing Printing Tasks

To clear printing tasks, follow this procedure:

1. Select the **Main Menu** quick key → from the **Common** column select **Record Setup**.
2. Select **Clear All Record Tasks**. This clears all queued printing tasks and stops the current printing.

### 19.6.4 Checking Printing Related Flags

You can find the following flags on the printing reports:

- For automatically stopped printings, there are two columns of asterisks **\*\*** at the end of the report.
- For manually or abnormally stopped printings, there is one column of asterisks **\*\*** at the end of the report.

## 19.7 Setting Reports

### 19.7.1 Setting Realtime Reports

You can set realtime reports, the recorder prints the reports according to the settings.

To set realtime reports, follow this procedure:

1. Select the **Main Menu** quick key → from the **Other** column select **Record Setup**.
2. Respectively select the desired waveform. Selecting **Off** can switch off a waveform. The recorder can print out a maximum of 3 waveforms.
3. Set **Recording Duration**.
  - ◆ **8 sec**: prints waveforms of 8 seconds before and after the current time.
  - ◆ **16 sec**: prints waveforms of 16 seconds before and after the current time.
  - ◆ **32 sec**: prints waveforms of 32 seconds before and after the current time.
  - ◆ **Continuous**: starts the printing from the current time until it is manually stopped.
4. Set **Recorder Paper Speed**.
5. Set the switch of **Gridlines**.
  - ◆ If switched on, printed waveforms are displayed with gridlines.
  - ◆ If switched off, printed waveforms are displayed without gridlines.

### 19.7.2 Enabling Auto Printing When an Alarm Occurs

When a parameter alarm is triggered, the printing can be automatically initiated. To do so, follow this procedure:

1. Select the numerics area or waveform area of the desired parameter.
2. Select the **Alarm** tab.
3. Switch on **Alarm Outputs**.

## 19.8 Removing Paper Jam

If the recorder works incorrectly or produces unusual sounds, check if there is a paper jam first. If a paper jam is detected, follow this procedure to remove it:

1. Open the recorder door.
2. Take out the paper and tear off the draped part.
3. Reload the paper and close the recorder door.



# 20 Discharged Patient Management

---

## 20.1 Generating Patient Data

Once turned on with a patient connected, the equipment automatically generates a patient ID and starts to record clinical data for this ID. If turned off, the equipment automatically discharges the patient, and the patient becomes a discharged patient.

### NOTE

- **Earlier stored data will be overwritten by later ones if the equipment capacity is reached.**
- 

## 20.2 Accessing the Discharged Patient Mode

In the Discharged Patient mode, you can manage discharged patients.

To access the Discharged Patient mode, select the **Main Menu** quick key and select **Discharged Patients** from the **System** column.

---

### WARNING

- **Patient therapy and monitoring automatically end when you access the Discharged Patient mode. The equipment automatically restarts and takes effects changes after the Discharged Patient mode.**
- 

## 20.3 Deleting Discharged Patient Data

You can delete the archived patient and corresponding patient data. To do so, select the desired patient from the **Discharged Patients** screen and select **Delete**.

## 20.4 Searching Discharged Patient Information

You can search discharged patient information from the equipment. To do so, follow this procedure:

1. Access the Discharged Patient mode.
2. Input query criteria.
3. Select **Search**.

Selecting  can refresh the discharged patient list.

## 20.5 Reviewing Discharged Patient Data

You can review trends of discharged patients. To do so, select the desired patient in the Discharged Patient mode, and then select **Detail**. For more information, see *18 Review*.

Selecting  in the **Review** window for a discharged patient can view the patient information.

## 20.6 Exporting Patient Data

You can use a USB drive to export the patient data, which can be viewed on BeneVision Central Monitoring System Viewer. For more information, see *BeneVision Central Monitoring System Viewer Operator's Manual*.

Patient data that can be saved and exported includes equipment information, configurations, patient information (configurable, patient category setting included), trend data (HR value included), event data (changes for pacer rate, pacer output and pacer pulse included), full disclosures (ECG waveforms and pace pulses included) and voice recordings.

For the patient's privacy protection, the patient information is not exported by default. The switch setting of **Include Patient Demographics When Exporting Patient Data** can be changed in the Configuration mode only. For more information, see *22.7.8 Patient Management Setup Menu*.

To export patient data, follow this procedure:

1. Connect the USB drive to the USB 2.0 connector of the equipment.
2. Access the Discharged Patient mode.
3. Select the desired patient.
4. Select **Export Patient Data**.

## **NOTE**

---

- **Do not remove the USB drive from the equipment before data is completely exported.**
-

# 21 Data Communication

---

## 21.1 Data Communication Introduction

The equipment can communicate with the CMS, eGateway, rescue debriefing statistical system and other equipments through wired or wireless networks. You can also transmit data from the equipment to a third-party system through FTP protocol or HL7 protocol.

## 21.2 Data Communication Safety Information

---

### CAUTION

---

- **Wireless network design, deployment, debugging, and maintenance should be executed by Mindray service personnel or authorized technicians.**
  - **Always deploy the wireless network according to local wireless regulations.**
  - **Using 5 GHz frequency band is recommended whenever possible. There are more interference sources in 2.4 GHz frequency band.**
  - **Private APs and wireless routers are not allowed. These devices may cause radio interference and result in monitor and CMS data loss.**
  - **To ensure network security and stability, data communication must be performed within a closed network or within a virtually isolated hospital network. The hospital is responsible for ensuring the security of the virtually isolated network.**
  - **WPA2-PSK and WPA2-Enterprise verification and encryption should be used if possible. Otherwise, the equipment may not be able to work or patient information may be leaked. WPA2-Enterprise and a long password are recommended.**
  - **Keep network authentication information, for example password, from being accessed by unauthorized users.**
  - **Do not connect non-medical devices to the equipment network.**
  - **If wireless network signal is poor, there may be a risk of CMS data loss.**
  - **Maximum number of monitors connected to a single AP is 3. Too many monitors connected to the same AP may result in network disconnection.**
  - **RF interference may result in wireless network disconnection.**
  - **Disconnecting from the network may result in CMS data loss and function failure. Check the patient in case of network disconnection and reconnect the network as soon as possible.**
  - **Ensure that the monitor IP address setting is correct. Changing the network settings may result in network disconnection. Contact your service personnel if you have any problems on setting the IP address.**
- 

## 21.3 Connecting the Wired Network

To connect the wired network, follow this procedure:

1. Connect one end of the network cable to the network port of the equipment.
2. Connect the other end of the network cable to the network port of PC installed the desired communication system.
3. Change settings of the wired network. The wired network settings can be changed in the Configuration mode only. For more information, see *22.7.9.1 Network Type Tab* and *22.7.9.2 LAN1 IP Tab*.

## 21.4 Connecting the Wireless Network

When the network is reconnected after a disconnection, or the equipment restarts, the last connected wireless network is automatically connected. If connecting the last connected wireless network fails, the equipment automatically connects other wireless networks by the sequence they were added.

A maximum of 5 wireless networks can be added for the equipment. The wireless network settings can be changed in the Configuration mode only. For more information, see 22.7.9.1 *Network Type Tab* and 22.7.9.3 *WLAN Tab*.

You can manually switch the wireless network by selecting  in the system information area, and then select the desired wireless network.

## 21.5 Connecting the CMS

The equipment can be connected to the CMS through wired or wireless networks. When connected to the CMS, the equipment provides the following functions.

- The equipment transmits data to the CMS, including equipment information, configurations, patient information, waveforms, parameter values, alarms, trend data, 12-lead ECG analysis data, rescue record, auto test reports and user test reports.
- The data mentioned above can be viewed from the CMS.
- Patient information, alarm settings, and alarm status can be synchronized between the equipment and the CMS.
- In case of a recovery from network disconnection, the equipment transmits the off-line data to the CMS.

When the network is reconnected after a disconnection, or the equipment restarts, the last connected CMS is automatically connected. You can also manually connect the equipment to the CMS. To do so, follow this procedure:

1. Access the **Select CMS** menu by either of the following ways:
  - ◆ Select the IP address in the system information area.
  - ◆ Select the **Main Menu** quick key → from the **Other** column select **CentralStation Connection**.
2. Select the desired CMS. If **Custom** is selected, you need to manually input the IP address of the desired CMS, and then select **Connect** to test the connection.

You can also connect the equipment to the CMS through a 4G router.

For details about operations on the CMS, see *BeneVision Monitoring System Operator's Manual*.

### NOTE

- 
- **You can select CMS only when Select CMS is switched on. For more information, see 22.7.9.5 *Central Station Setup Tab*.**
- 

## 21.6 Connecting the eGateway

The equipment can be connected to the eGateway through wired or wireless networks, which can implement interactions between the equipment and other equipments. When connected to the eGateway, the equipment provides the following functions:

- The equipment transmits data to the eGateway, including parameter values, waveforms, alarm settings, and events.
- The equipment system time automatically synchronizes with that on the eGateway.

The settings for the eGateway connection can be changed in the Configuration mode. For more information, see 22.7.9.6 *Device Discover Tab*.

## 21.7 Transmitting Data through HL7 Protocol

The equipment can transmit the realtime data, waveforms and alarms to the hospital servers through HL7 protocol. The settings for HL7 protocol can be changed in the Configuration mode. For more information, see 22.7.9.9 *HL7 Setup Tab*.

## **21.8 Transmitting Data through FTP Protocol**

The equipment can transmit the 12-lead ECG analysis report to the hospital servers through FTP protocol. The settings for FTP protocol can be changed in the Configuration mode. For more information, see *22.7.9.10 FTP Setup Tab*.

## **21.9 Connecting the NTP Server**

The equipment can be connected to the NTP server through wired or wireless networks. When connected to the NTP server, the equipment system time automatically synchronizes with that on the NTP server. The settings for the NTP server connection can be changed in the Configuration mode. For more information, see *22.7.9.11 Time Synchronization Setup Tab*.

## **21.10 Connecting the Rescue Debriefing Statistical System**

The equipment can be connected to the rescue debriefing statistical system through wired or wireless networks. When connected to the rescue debriefing statistical system, the equipment automatically uploads real-time rescue data for further analysis and statistics.

For details about rescue debriefing, see *Rescue Debriefing Statistical System Operator's Manual*.

**This page intentionally left blank.**

# 22 Configuration Management

---

## 22.1 Configuration Management Introduction

The configuration management enables you to customize your equipment to best meet your needs.

After you change the configurations, the equipment automatically restarts and new configuration settings take effect immediately.

---

### WARNING

---

- **Accessing the Configuration mode is password protected. Patient therapy and monitoring automatically end when you access the Configuration mode.**
  - **The configurations must be changed by authorized personnel only.**
  - **Never connect the equipment with the patient when accessing the configuration management.**
- 

## 22.2 Accessing the Configuration Mode

To access the Configuration mode, follow this procedure:

1. Select the **Main Menu** quick key → from the **System** column select **Configuration**.
2. Select the corresponding configuration menu.
  - ◆ Enter the required password and select **Confirm** to enter the Configuration Management menu.
  - ◆ Select **Read Only** in the Configuration View menu.

In the Configuration View menu, you can select **General Setup** to change the system time, other settings can not be changed and only for view.

## 22.3 Modifying Configuration Management Password

The factory default password for entering the Configuration Management menu is 315666. You can modify this password. To do so, follow this procedure:

1. Access the Configuration Management menu.
2. Select **Modify Password**.
3. Respectively enter the old and new passwords.
4. Select **Confirm**.

## 22.4 Exporting Configurations

The configurations can be exported through a USB drive. To do so, follow this procedure:

1. Connect the USB drive to the USB 2.0 connector of the equipment.
2. Access the Configuration Management menu.
3. Select **Export Configuration**.

## 22.5 Importing Configurations

It is not necessary to configure each equipment separately when installing several equipments with identical configurations. A USB drive can be used to import configurations from one equipment to another. To do so, follow this procedure:

1. Prepare a USB drive with desired configurations.
2. Connect the USB drive to the USB 2.0 connector of the target equipment.

3. Access the Configuration Management menu.
4. Select **Import Configuration**.

## 22.6 Printing Configurations

The configurations can be printed out through a recorder. To do so, follow this procedure:

1. Access the Configuration Management menu.
2. Select **Record**.

## 22.7 Changing Configurations

The configurations changed in clinical mode are affected if the equipment restarts. The configurations changed in the Configuration mode remain even if the equipment restarts.

To change configurations, follow this procedure:

1. Access the Configuration Management menu.
2. Select the desired setup menu, and change the settings.
3. If factory defaults are needed, selecting **Restore Factory Default** can restore all the current settings.

### NOTE

- **Restoring factory defaults have no impact on the item marked with "\*" in the following tables.**
- **The alarm limits are effective for all patient categories if not specified.**

### 22.7.1 General Setup Menu

Menu Item	Options/Range	Default	Description
<b>Device Location</b>			
Device Name*/ Facility*/ Department*/Room No*/Bed No.*	0 to 15 characters	/	If the equipment is connected to the CMS, <b>Bed No.</b> and <b>Department</b> can also be changed on the CMS.
<b>Time Setup</b>			
Date	2000-1-1 to 2099-12-31	/	Sets the system date.
Time	00:00 to 23:59	/	Sets the system time.
Date Format	yyyy-mm-dd, mm-dd-yyyy, dd-mm-yyyy	yyyy-mm-dd	Sets the system date format.
24-Hour Time	On, Off	On	Sets whether to enable the 24-hour mode.
Time Zone	/	/	Sets the system time zone.
Daylight Savings Time*	On, Off	Off	Sets whether to enable the daylight saving time.
Auto Daylight Savings Time*	On, Off	Off	Sets whether to automatically enable the daylight saving time.
<b>Other Setup</b>			
Language	/	/	Sets the system language for voice and text prompts.
<b>Basic Setup</b>			
Default Startup Mode	Monitor, Manual, AED	Monitor	Set the default mode after turning on the equipment
Voice Recording	On, Off	Off	Sets whether to enable the voice recording function.



Menu Item	Options/Range	Default	Description
Screen Lock Duration	Off, 1 min, 2 min, 5 min, 10 min	5 min	Sets the duration that the touchscreen is automatically locked.

## 22.7.2 Therapy Setup Menu

All configurations in this section can be changed in the Configuration mode only.

### 22.7.2.1 Manual Defib Setup Tab

Menu Item	Options/Range	Default	Description
<b>General Setup</b>			
Therapy Access	Direct, Confirmed, Password	Direct	<p>Sets the way you access the Manual Defib mode and Pacer mode.</p> <ul style="list-style-type: none"> <li>• <b>Direct:</b> you can directly access the Manual Defib mode and Pacer mode.</li> <li>• <b>Confirmed:</b> a dialog box pops up for the confirmation when you access the Manual Defib mode and Pacer mode.</li> <li>• <b>Password:</b> a dialog box pops up requiring the password when you access the Manual Defib mode and Pacer mode.</li> </ul>
Set Password	4 digits	1234	This option is available only when <b>Therapy Access</b> is set to <b>Password</b> .
Time to Auto Disarm	30 s, 60 s, 90 s, 120 s	60 s	Sets the time the equipment automatically removes the stored energy internally.
Sync After Shock	On, Off	Off	Sets whether the equipment remains in synchronized cardioversion after a delivered shock.
Remote Sync	On, Off	Off	Sets whether to enable the remote synchronized cardioversion.
Charge Tone Vol	High, Med, Low	Med	<p>Sets the tone volume during the charge, and when the charge is completed.</p> <p>This setting is also effective in the AED mode.</p>
Contact Impedance Indicator	On, Off	Off	Sets whether to display the contact impedance indicator.
Contact Impedance Value	On, Off	Off	Sets whether to display the contact impedance value.
Smart Analysis	On, Off	Off	Sets whether to enable the smart analysis during external defibrillation.
Energy Delivered Output	On, Off	Off	Sets whether the energy level of a delivered shock is displayed in the event printing.
CPR after Shock	On, Off	Off	Sets whether the equipment remains in CPR status after a delivered shock.
CPR Time	30 s, 60 s, 90 s, 120 s, 150 s, 180 s	120 s	Sets the duration for the CPR administration.
<b>Energy Setup</b>			

Menu Item	Options/Range	Default	Description
Energy Series	On, Off	Off	Sets whether the equipment delivers the shock of the default energy level. <ul style="list-style-type: none"> <li><b>On:</b> the default energy levels of <b>Energy 1</b>, <b>Energy 2</b> and <b>Energy 3</b> are available. When delivering the shock to the patient, the equipment delivers the shock of the default energy level. After three shocks, the equipment delivers the following shocks of <b>Energy 3</b> default energy level.</li> <li><b>Off:</b> the default energy levels of <b>Default Energy for Adult</b> and <b>Default Energy for Pediatric</b> are available.</li> </ul>
Energy 1 (Adult)	100 J, 120 J, 150 J, 170 J, 200 J, 300 J, 360 J	200 J	Sets the defibrillation energy level for the first shock on the adult patient.
Energy 2 (Adult)	Energy 1 (Adult) to 360J	300 J	Energy 1 ≤ configurable value ≤ Energy 3
Energy 3 (Adult)	Energy 2 (Adult) to 360J	360 J	Energy 2 ≤ configurable value
Energy 1 (Ped)	10 J, 15 J, 20 J, 25 J, 30 J, 50 J, 70 J, 100 J, 120 J, 150 J, 170 J, 200 J	100 J	Sets the defibrillation energy level for the first shock on the pediatric patient.
Energy 2 (Ped)	Energy 1 (Ped) to 200 J	100 J	Energy 1 ≤ configurable value ≤ Energy 3
Energy 3 (Ped)	Energy 2 (Ped) to 200 J	200 J	Energy 2 ≤ configurable value
Default Energy for Adult	100 J, 120 J, 150 J, 170 J, 200 J, 300 J, 360 J	200 J	Sets the energy level for the manual defibrillation.
Default Energy for Pediatric	10 J, 15 J, 20 J, 25 J, 30 J, 50 J, 70 J, 100 J, 120 J, 150 J, 170 J, 200 J	100 J	
Default Energy for Adult (SYNC)	100 J, 120 J, 150 J, 170 J, 200 J, 300 J, 360 J	120 J	Sets the energy level for the synchronous defibrillation.
Default Energy for Pediatric (SYNC)	10 J, 15 J, 20 J, 25 J, 30 J, 50 J, 70 J, 100 J, 120 J, 150 J, 170 J, 200 J	25 J	
Internal Default	2 J, 5 J, 10 J, 20 J, 25 J, 30 J, 50 J	10 J	Sets the energy level for the internal defibrillation.

### 22.7.2.2 AED Setup Tab

Menu Item	Options/Range	Default	Description
<b>General Setup</b>			
Time to Auto Disarm	30s, 60s, 90s, 120s	30s	Sets the time the equipment automatically removes the stored energy internally.
Initial CPR Time	Off, 30 s, 60 s, 90 s, 120 s, 150 s, 180 s	Off	Sets the initial CPR time after accessing the AED mode.
CPR Mode (Adult)	30:2, 15:2, Compression only	30:2	Sets the rate of compression and ventilation.
CPR Mode (Ped)		15:2	
CPR Time	30 s, 60 s, 90 s, 120 s, 150 s, 180 s	120 s	Sets the duration for the CPR administration.

Menu Item	Options/Range	Default	Description
NSA Action	Monitor, CPR	CPR	Sets the status equipment will access after “ <b>No Shock Advised!</b> ” is given. <ul style="list-style-type: none"> <li>• <b>CPR</b>: the equipment enters the CPR status.</li> <li>• <b>Monitor</b>: if a potential shockable rhythm is detected, the equipment continues to monitor ECG and automatically resumes the rhythm analysis.</li> </ul>
Voice Prompts	On, Off	On	Sets whether voice prompts are provided in the AED mode.
Voice Volume	High, Med, Low	High	Sets the volume level for voice prompts in the AED mode.
Voice Prompt Interval	Off, 30s, 60s, 90s, 120s, 150s, 180s	30s	Sets the interval for voice prompts in the AED mode.
<b>Energy Setup</b>			
Shock Series	1, 2, 3	1	Sets the number of shocks. If it is set to greater than one, the equipment resumes analyzing the patient’s rhythm after the shock is delivered to determine if the shock was successful. Prompts for shock counter are provided to guide you delivering additional shocks.
Energy 1 (Adult)	100 J, 120 J, 150 J, 170 J, 200 J, 300 J, 360 J	200 J	Sets the defibrillation energy level for the first shock on the adult patient.
Energy 2 (Adult)	Energy 1 (Adult) to 360J	300 J	Energy 1 ≤ configurable value ≤ Energy 3
Energy 3 (Adult)	Energy 2 (Adult) to 360J	360 J	Energy 2 ≤ configurable value
Energy 1 (Ped)	10 J, 15 J, 20 J, 25 J, 30 J, 50 J, 70 J, 100 J, 120 J, 150 J, 170 J, 200 J	100 J	Sets the defibrillation energy level for the first shock on the pediatric patient.
Energy 2 (Ped)	Energy 1 (Ped) to 200 J	100 J	Energy 1 ≤ configurable value ≤ Energy 3
Energy 3 (Ped)	Energy 2 (Ped) to 200 J	200 J	Energy 2 ≤ configurable value

### 22.7.2.3 Pacer Setup Tab

Menu Item	Options/Range	Default	Description
Pacer Rate (ppm)	30 to 210 ppm	70 ppm	Sets the delivered rate of paced pulses.
Pacer Output (mA)	0 to 200 mA	30 mA	Sets the paced pulses duration.
Pacer Output Step	1 mA, 2 mA, 5 mA	5 mA	Sets the step of paced pulses duration.
Default Pacer Mode	Demand Mode, Fixed Mode	Demand Mode	Sets the pacer mode when accessing the Pacer mode.
Pacer Pulse	20 ms, 40 ms	20 ms	Sets the pacer output setting at which pace pulses are delivered.

### 22.7.2.4 CPR Setup Tab

Menu Item	Options/Range	Default	Description
CPR Metronome (AED)	On, Off	On	Sets whether the compression are performed at the setting of <b>CPR Mode</b> in the AED mode.

Menu Item	Options/Range	Default	Description
CPR Metronome (Manual)	On, Off	Off	Sets whether the compression are performed at the setting of <b>CPR Mode</b> in the Manual Defib mode.
CPR Prompts (AED)	On, Off	On	Sets whether voice prompts are provided when using the CPR assistance in the AED mode.
CPR Prompts (Manual)	On, Off	Off	Sets whether voice prompts are provided when using the CPR assistance in the Manual Defib mode.
CPR Filter	On, Off	On	Sets whether to enable the CPR filter when performing CPR.

### 22.7.2.5 Quick Keys Setup Tab

Menu Item	Options/Range	Default	Description
Location1	Adrenalin, Amiodarone, Lidocaine, Atropine, Adenosine, Dopamine, Aminophylline, Naloxone, Oxygen Inhalation, Ventilation, Tracheal Intubation, Neck Support, Stop Bleeding, Bandaged, Immobilized	Adrenalin	Select the desired location, and the select the event name for quick key. An event cannot be displayed in more than one locations.
Location2		Amiodarone	
Location3		Lidocaine	
Location4		Oxygen Inhalation	
Location5		Ventilation	

### 22.7.3 Alarm Setup Menu

Menu Item	Options/Range	Default	Description
<b>Audio Setup</b>			
Minimum Alarm Volume	0 to 10	2	Sets the lowest level for alarm volume
Alarm Sound	ISO, ISO2	ISO	Sets the alarm tone pattern to distinguish the heart beat tone, pulse tone, and keystroke tone by frequency.
High Alarm Interval	3 to 15 s	3 sec	Sets the interval between alarm tones.
Med Alarm Interval	3 to 30 s	8 sec	
Low Alarm Interval	16 to 30 s	20 sec	
Auto Increase Volume	Off, 1 Step, 2 Steps	2 Steps	<ul style="list-style-type: none"> <li>• <b>2 Steps:</b> if an alarm is not reset within the designated delay time after the alarm occurs, the alarm volume automatically increases by two levels.</li> <li>• <b>1 Step:</b> if an alarm is not reset within the designated delay time after the alarm occurs, the alarm volume automatically increases by one level.</li> <li>• <b>Off:</b> if an alarm is not reset within the designated delay time after the alarm occurs, the volume of the alarm tone does not change.</li> </ul>
Increase Volume Delay	10 sec, 20 sec, 30 sec	20 sec	Sets the delay time of alarm volume escalation
<b>Latching Setup</b>			
Visible	Off, Lethal, Lethal/High, Lethal/High/Med, Lethal/High/Med/Low	Off	Sets alarm latching rules: <b>Off:</b> you can separately set latching rules for alarms of different priorities.

Menu Item	Options/Range	Default	Description
Lethal Audible Latching	On, Off	Off	Latching audible alarm signal simultaneously latches visual signal. Selecting alarms of lower priority simultaneously latches higher priority alarms.
High Audible Latching	On, Off	Off	
Med Audible Latching	On, Off	Off	
Low Audible Latching	On, Off	Off	
<b>Pause/Reset Setup</b>			
Pause	Alarm Pause, Audio Pause	Alarm Pause	Sets the pause function. <ul style="list-style-type: none"> <li>• <b>Alarm Pause:</b> pauses alarms.</li> <li>• <b>Audio Pause:</b> pauses alarm tones.</li> </ul>
Pause Time	1 min, 2 min, 3 min, Permanent	2 min	Sets the interval for alarm pause.
Pause Priority	All, Med & Low, Disable	All	Sets alarms of what priority can be paused. <ul style="list-style-type: none"> <li>• <b>All:</b> selecting <b>Alarm Pause</b> from the alarm list pauses all alarms.</li> <li>• <b>Med &amp; Low:</b> selecting <b>Alarm Pause</b> from the alarm list pauses alarms of medium and low priorities. The high priority alarms will not be paused.</li> <li>• <b>Disable:</b> <b>Alarm Pause</b> in the alarm list is disabled.</li> </ul>
Alarm Light	On When Reset, Off When Reset	On When Reset	<ul style="list-style-type: none"> <li>• <b>On When Reset:</b> when the alarm system is reset, the alarm tones of the current alarms are switched off, but the alarm lamp remains flashing.</li> <li>• <b>Off When Reset:</b> when the alarm system is reset, both the alarm tone and alarm lamp of the current alarms are switched off.</li> </ul>
Alarm Reset Reminder	On, Re-alarm, Off	On	Selects the reminder tone rule when the alarm volume is set to zero, or the alarm is reset or switched off. <ul style="list-style-type: none"> <li>• <b>On:</b> the equipment issues reminder tones at a designated interval.</li> <li>• <b>Re-alarm:</b> if the alarm condition persists, the alarms marked with “√” will be regenerated after the designated reminder tone interval.</li> <li>• <b>Off:</b> the equipment does not issue reminder tones at a designated interval. The alarms marked with “√” will be silenced.</li> </ul>
Alarm Off Reminder	On, Off	On	Sets whether the equipment prompts when the alarm is switched off.
Reminder Interval	1 min, 2 min, 3 min, 5 min, 10 min	5 min	Sets the interval for reminder tones.
<b>Setup</b>			
ECG Lead Off	High, Med, Low	Low	Sets the alarm priority of “ <b>ECG Lead Off</b> ”.
SpO2 Sensor Off	High, Med, Low	Low	Sets the alarm priority of “ <b>SpO2 Sensor Off</b> ”.
CMS/eGW Disconnected	High, Med, Low	Low	Sets the alarm priority of “ <b>CMS/eGW Disconnected</b> ”.
Alarm Delay	1 to 15 sec, Off	12 sec	<ul style="list-style-type: none"> <li>• 1 to 15 s: for continuously measured parameters, the equipment does not present the alarm if the alarm condition is resolved within the delay time.</li> <li>• <b>Off:</b> an alarm is always presented.</li> </ul> <p>The setting of <b>Alarm Delay</b> is not applied to the apnea alarms and the ST alarms.</p>

Menu Item	Options/Range	Default	Description
ST Alarm Delay	30 s, 45 s, 1 min, 1.5 min, 2 min, 3 min	30 sec	The equipment does not present the ST alarm if the alarm condition is resolved within the delay time.
SPO2 Desat Alarm Off	Enable, Disable	Disable	Sets whether the SpO <sub>2</sub> Desat alarm can be switched off. <ul style="list-style-type: none"> <li>• <b>Disable:</b> the SpO<sub>2</sub> Desat alarm cannot be switched off.</li> <li>• <b>Enable:</b> the SpO<sub>2</sub> Desat alarm can be switched off.</li> </ul>
Apnea Alarm Off	Enable, Disable	Disable	Sets whether the apnea alarm can be switched off. <ul style="list-style-type: none"> <li>• <b>Disable:</b> the apnea alarm cannot be switched off.</li> <li>• <b>Enable:</b> the apnea alarm can be switched off.</li> </ul>
Arrhy Shield Time	0 to 5 min	2 min	Alarm light and alarm tone will be disabled for designated period of time when certain arrhythmia alarms are detected. <b>0:</b> disables this function.
No Battery	Status Indicator On, Status Indicator Off	Status Indicator On	Sets how the status indicator behaves if no battery is installed.
CMS/eGW Disconnected Alarm	On, Off	Off	Sets whether an alarm is issued when the equipment is disconnected from the CMS or Gateway. <b>Off:</b> the alarm "Offline" is not presented when the equipment is disconnected from the CMS or eGateway.

## NOTE

- The alarm volume escalation function is not applied to the latched alarms.

## 22.7.4 Parameter Setup Menu

### 22.7.4.1 General Setup Tab

Menu Item	Options/Range	Default	Description
<b>Parameter Color Setup</b>			
ECG	Green, Yellow, Cyan, White, Red, Blue, Purple, Orange	Green	Sets the colors for parameter waveforms and numerics.
Resp		Yellow	
SpO2		Cyan	
NIBP		White	
CO2		Yellow	
<b>Unit Setup</b>			
ST Unit	mV, mm	mV	Sets the measurement unit for each parameter.
CO2 Unit	mmHg, kPa,%	mmHg	
Pressure Unit	mmHg, kPa	mmHg	
<b>Parameters On/Off Setup</b>			
SpO2/Resp/NIBP/CO2	On, Off	On	Sets whether to enable monitoring for a parameter.

### 22.7.4.2 ECG Setup Menu

Menu Item		Options/Range		Default	Description
<b>Alarm Setup</b>					
HR/PR	Alarm Switch	On, Off		On	Sets whether to switch on HR and PR alarms.
	Alarm Priority	High, Med		Med	Sets the alarm priority of HR and PR.
	Alarm Output	On, Off		Off	Sets whether the parameter is automatically printed when HR and PR alarms are triggered.
HR/PR High (bpm)		Adult	HR/PR ≤ 40 bpm: (low limit + 2 bpm) to 40 bpm  HR/PR > 40 bpm: (low limit + 5 bpm) to 295 bpm	120	Sets the alarm limits for HR and PR. HR/PR ≤ 40 bpm: step is 1 bpm. HR/PR > 40 bpm: step is 5 bpm.
		Ped		160	
		Neo		200	
HR/PR Low (bpm)		Adult	HR/PR ≤ 40 bpm: 16 bpm to (high limit - 2 bpm)  HR/PR > 40 bpm: 40 bpm to (high limit - 5 bpm)	50	
		Ped		75	
		Neo		100	
<b>ECG Lead and Gain Setup</b>					
ECG1		3-Lead: I, II, III		II	Available options are defined by the current setting of <b>Lead Set</b> .
		5-Lead: I, II, III, aVL, aVR, aVF, V			
		12-Lead: I, II, III, aVL, aVR, aVF, V1			
ECG1 Gain		x0.125, x0.25, x0.5, x1, x2, x4, Auto		x1	Sets the ECG waveform size.
<b>Setup</b>					
Alarm Source		Both, PR, HR, Auto		Auto	Sets the source for QRS tone.
Speed		6.25 mm/sec, 12.5 mm/sec, 25 mm/sec, 50 mm/sec		25 mm/s	Sets the ECG waveform speed.
Filter		ST, Diagnostic, Monitor, Therapy		Monitor	Sets the ECG waveform filter mode.
Lead Set		Auto, 3-Lead, 5-Lead, 12-Lead		Auto	Sets the ECG lead type. This setting affects the default waveform sequence of ECG lead.
Waveform Layout		Standard, Cabrera		Standard	Sets the ECG waveform layout.
Smart Lead		On, Off		On	Sets whether the equipment automatically switches to the available lead when the lead of the first ECG waveform is detached.
QRS Volume		0 to 10		2	This setting is same as the <b>QRS Volume</b> setting in the <b>SpO2 Setup</b> menu.

Menu Item	Options/Range	Default	Description
QTc Formula	Hodges, Bazett, Fridericia, Framingham	Hodges	<p>Sets the QTc formula used to correct the QT interval for heart rate.</p> <ul style="list-style-type: none"> <li>• <b>Hodges:</b>  <math>QTc = QT + 1.75 \times (\text{HeartRate} - 60)</math></li> <li>• <b>Bazett:</b>  <math>QTc = QT \times \left( \frac{\text{HeartRate}}{60} \right)^{\frac{1}{2}}</math></li> <li>• <b>Fridericia:</b>  <math>QTc = QT \times \left( \frac{\text{HeartRate}}{60} \right)^{\frac{1}{3}}</math></li> <li>• <b>Framingham:</b>  <math>QTc = QT + 154 \times \left( 1 - \frac{60}{\text{HeartRate}} \right)</math></li> </ul>
ECG Standard	AHA, IEC	AHA	Sets the ECG standard according to the leadwires you are using.
Notch Frequency	50 Hz, 60 Hz	50 Hz	The notch filter removes the line frequency interference. Sets notch filter frequency according to the power line frequency of your country.

### 22.7.4.3 Arrhythmia Setup Tab

Alarm Setup			
Menu Item	Alarm Switch	Alarm Priority	Alarm Output
Asystole	On	High, not configurable	Off
V-Fib/V-Tach	On	High, not configurable	Off
V-Tach	On	High, not configurable	Off
Vent Brady	On	High, not configurable	Off
Extreme Tachy	On	High, not configurable	Off
Extreme Brady	On	High, not configurable	Off
R on T	Off	Med	Off
Run PVCs	Off	Low	Off
Couplet	Off	Prompt	Off
Multiform PVC	Off	Med	Off
PVC	Off	Prompt	Off
Bigeminy	Off	Med	Off
Trigeminy	Off	Med	Off
Tachy	Off	Med	Off
Brady	Off	Med	Off
Pacer Not Capture	Off	Prompt	Off
Pacer Not Pacing	Off	Prompt	Off
Missed Beat	Off	Prompt	Off
Nonsus V-Tach	Off	Med	Off
Vent Rhythm	Off	Med	Off



Pause	Off	Low	Off
Irr Rhythm	Off	Prompt	Off
A-Fib	Off	Prompt	Off
PVCs/min	Off	Med	Off
Pauses/min	Off	Med	Off
SVT	Off	Med	Off
SVCs/min	Off	Med	Off
<b>Threshold Setup</b>			
<b>Menu Item</b>	<b>Options/Range</b>		<b>Default</b>
Asystole Delay	Adult	3 sec to 10 sec	5 sec
	Ped		5 sec
	Neo		3 sec
Extreme Tachy	Adult	65 bpm to 300 bpm	160 bpm
	Ped		180 bpm
	Neo		220 bpm
Tachy	Adult	60 bpm to 295 bpm	120 bpm
	Ped		160 bpm
	Neo		200 bpm
Brady	Adult	16 bpm to 120 bpm	50 bpm
	Ped		75 bpm
	Neo		100 bpm
Extreme Brady	Adult	15bpm to 115 bpm	35 bpm
	Ped		50 bpm
	Neo		80 bpm
Multif PVCs Window	3 beats to 31 beats		15 beats
PVCs/min	Adult	1 to 100	10
	Ped		10
	Neo		5
Pauses/min	1 to 15		8
Pause Threshold	Adult	1.5sec, 2.0sec, 2.5sec, 3.0sec	2.0 sec
	Ped		2.0 sec
	Neo		1.5 sec
AF/Irr Rhy End Time	0, 1 min, 2 min, 3 min, 4 min, 5 min, 10 min, 15 min, 30 min		2 min
SVT HR	Adult	100 bpm to 300 bpm	180 bpm
	Ped		200 bpm
	Neo		210 bpm
SVT SVCs	3 beats to 99 beats		5 beats
SVCs/min	1 bpm to 100 bpm		10 bpm

V-Tach Rate	Adult	100 bpm to 200 bpm	130 bpm
	Ped		130 bpm
	Neo		150 bpm
V-Brady Rate	Adult	15 bpm to 60 bpm	40 bpm
	Ped		40 bpm
	Neo		60 bpm
V-Tach PVCs	Adult	3 beats to 99 beats	6 beats
	Ped		6 beats
	Neo		5 beats
V-Brady PVCs	Adult	3 beats to 99 beats	5 beats
	Ped		5 beats
	Neo		3 beats

#### 22.7.4.4 ST Setup Tab

Menu Item		Options/Range	Default	Description
<b>Alarm Setup</b>				
ST-XX*	Alarm Switch	On, Off	Off	Sets whether to switch on ST alarm.
	Alarm Priority	High, Med	Med	Sets the ST alarm priority.
	Alarm Output	On, Off	Off	Sets whether the parameter is automatically printed when ST alarm is triggered.
ST High (mV)	ST alarm mode: Absolute (low limit + 0.2 mV) to 2.0 mV ST alarm mode: Relative 0 mV to 2.0 mV	0.2	Sets the ST alarm limits. Step is 0.05 mV.	
ST Low (mV)	ST alarm mode: Absolute -2.0 mV to (high limit - 0.2 mV) ST alarm mode: Relative -2.0 mV to 0 mV	-0.2		
*: ST-XX represents ST-I, ST-II, ST-III, ST-aVR, ST-aVL, ST-aVF, ST-V1, ST-V2, ST-V3, ST-V4, ST-V5, ST-V6, ST-Va, ST-Vb.				
<b>Setup</b>				
ST Analysis	On, Off	Off	Sets whether to enable the ST measurement.	
ST Alarm Mode	Absolute, Relative	Absolute	Set the ST alarm mode.	
Auto Adjust	On, Off	On	Sets whether to automatically adjust the location of ST point.	
ST Point	J+40 ms, J+60 ms, J+80, ms, J+60/80 ms	J+60 msec	Sets the distance fixed from the ST point to the J point.	

### 22.7.4.5 QT Setup Tab

Menu Item		Options/Range		Default	Description
<b>Alarm Setup</b>					
QTc	Alarm Switch	On, Off		Off	Sets whether to switch on QTc alarm.
	Alarm Priority	High, Med		Med	Sets the QTc alarm priority.
	Alarm Output	On, Off		Off	Sets whether the parameter is automatically printed when QTc alarm is triggered.
ΔQTc	Alarm Switch	On, Off		Off	Sets whether to switch on ΔQTc alarm.
	Alarm Priority	High, Med		Med	Sets the ΔQTc alarm priority.
	Alarm Output	On, Off		Off	Sets whether the parameter is automatically printed when ΔQTc alarm is triggered.
QTc High (ms)	Adult	200 to 800		500	Sets the QTc baseline.
	Ped			480	
	Neo			460	
ΔQTc High (ms)	30 to 200		60	Sets the ΔQTc baseline.	
<b>Setup</b>					
QT Analysis	On, Off		Off	Sets whether to enable the QT measurement.	

### 22.7.4.6 Resp Setup Tab

Menu Item		Options/Range		Default	Description
<b>Alarm Setup</b>					
RR	Alarm Switch	On, Off		On	Sets whether to switch on RR alarm.
	Alarm Priority	High, Med, Low		Med	Sets the RR alarm priority.
	Alarm Output	On, Off		Off	Sets whether the parameter is automatically printed when RR alarm is triggered.
Apnea	Alarm Switch	On, Off		On	Sets whether to switch on the apnea alarm.
	Alarm Priority	Unconfigurable		High	Sets the apnea alarm priority.
	Alarm Output	On, Off		Off	Sets whether the parameter is automatically printed when the apnea alarm is triggered.

Menu Item	Options/Range		Default	Description
RR High (rpm)	Adult	RR≤20: (low limit + 2) to 20 RR>20: (low limit + 5) to 100	30	Sets the RR alarm limits. RR≤20: step is 1. RR>20: step is 5.
	Ped		30	
	Neo	RR≤20: (low limit + 2) to 20 RR>20: (low limit + 5) to 150	100	
RR Low (rpm)	Adult	RR≤20: 0 to (high limit - 2) RR>20:	8	
	Ped		8	
	Neo	20 to (high limit - 5)	30	
<b>Setup</b>				
Apnea Delay	10 s, 15s, 20s, 25s, 30s, 35s, 40s		20 sec	Sets whether the equipment does not present the alarm if the alarm condition is resolved within the delay time.
Resp Lead	Adult	I, II, Auto	Auto	Sets whether to use one lead or all leads for Resp monitoring.
	Ped		Auto	
	Neo		II	
Gain	x0.25, x0.5, x1, x2, x4, x5, Auto		x2	Sets the Resp waveform size.
Speed	3 mm/sec, 6.25 mm/sec, 12.5 mm/sec, 25 mm/sec, 50 mm/sec		6.25 mm/sec	Sets the Resp waveform speed.

#### 22.7.4.7 SpO<sub>2</sub> Setup Tab

Menu Item	Options/Range		Default	Description
<b>Alarm Setup</b>				
SpO <sub>2</sub>	Alarm Switch	On, Off	On	Sets whether to switch on SpO <sub>2</sub> alarm.
	Alarm Priority	High, Med	Med	Sets the SpO <sub>2</sub> alarm priority.
	Alarm Output	On, Off	Off	Sets whether the parameter is automatically printed when SpO <sub>2</sub> alarm is triggered.
SpO <sub>2</sub> Desat	Unconfigurable		High	Sets the SpO <sub>2</sub> Desat alarm priority.
SpO <sub>2</sub> High (%)	Adult	(low limit + 2) to 100	100	Sets the SpO <sub>2</sub> alarm limits. Step is 1%.
	Ped		100	
	Neo		95	
SpO <sub>2</sub> Low (%)	Adult	Mindray/Masimo SpO <sub>2</sub> : (Desat+1) to (high limit - 2) Nellcor SpO <sub>2</sub> : (Desat+1) or 20 (whichever is greater) to (high limit - 2)	90	
	Ped		90	
	Neo		85	
SpO <sub>2</sub> Desat (%)	0 to (low limit - 1)		80	Sets the SpO <sub>2</sub> Desat alarm limits. Step is 1%.

Menu Item	Options/Range	Default	Description
<b>Setup</b>			
Speed	6.25 mm/s, 12.5 mm/s, 25 mm/s, 50 mm/s	25 mm/sec	Sets the SpO <sub>2</sub> waveform speed.
Display PR	On, Off	On	Sets whether to display the PR value in the SpO <sub>2</sub> numeric area.
Sensitivity (for Mindray SpO <sub>2</sub> and Masimo SpO <sub>2</sub> )	Mindray SpO <sub>2</sub> : High, Med, Low	Med	Sets the responding speed to changes in the SpO <sub>2</sub> values.
	Masimo SpO <sub>2</sub> : High, Normal, APOD	Normal	
NIBP Simul	On, Off	Off	When monitoring SpO <sub>2</sub> and NIBP on the same limb simultaneously, sets whether to lock the SpO <sub>2</sub> alarm status until the NIBP measurement ends.
Sat-Seconds (for Nellcor SpO <sub>2</sub> )	0s, 10s, 25s, 50s, 100s	0s	Sets the SpO <sub>2</sub> Sat-Seconds.
Average Time (for Masimo SpO <sub>2</sub> )	2-4s, 4-6s, 8s, 10s, 12s, 14s, 16s	8s	Sets the averaging time for the SpO <sub>2</sub> measurement.
Fast SAT (for Masimo SpO <sub>2</sub> )	On, Off	Off	Sets whether to enable FastSAT function.
Display SIQ (for Masimo SpO <sub>2</sub> )	On, Off	Off	Sets whether to enable the SIQ display.
Display PI	On, Off	On	Sets whether to enable the PI display.
SpO <sub>2</sub> Tone	Mode 1, Mode 2	Mode 1	Sets the SpO <sub>2</sub> tone mode.

#### 22.7.4.8 NIBP Setup Tab

Menu Item	Options/Range	Default	Description	
<b>Alarm Setup</b>				
NIBP-S	Alarm Switch	On, Off	On	Sets whether to switch on NIBP-S alarm.
	Alarm Priority	High, Med	Med	Sets the NIBP-S alarm priority.
	Alarm Output	On, Off	Off	Sets whether the parameter is automatically printed when NIBP-S alarm is triggered.
NIBP-M	Alarm Switch	On, Off	On	Sets whether to switch on NIBP-M alarm.
	Alarm Priority	High, Med	Med	Sets the NIBP-M alarm priority.
	Alarm Output	On, Off	Off	Sets whether the parameter is automatically printed when NIBP-M alarm is triggered.
NIBP-D	Alarm Switch	On, Off	On	Sets whether to switch on NIBP-D alarm.
	Alarm Priority	High, Med	Med	Sets the NIBP-D alarm priority.
	Alarm Output	On, Off	Off	Sets whether the parameter is automatically printed when NIBP-D alarm is triggered.

Menu Item		Options/Range		Default	Description
NIBP-S Extreme	Alarm Switch	On, Off		On	Sets whether to switch on NIBP-S Extreme alarm.
	Alarm Priority	High, Med		High	Sets the NIBP-S Extreme alarm priority.
	Alarm Output	On, Off		Off	Sets whether the parameter is automatically printed when NIBP-S Extreme alarm is triggered.
NIBP-M Extreme	Alarm Switch	On, Off		On	Sets whether to switch on NIBP-M Extreme alarm.
	Alarm Priority	High, Med		High	Sets the NIBP-M Extreme alarm priority.
	Alarm Output	On, Off		Off	Sets whether the parameter is automatically printed when NIBP-M Extreme alarm is triggered.
NIBP-D Extreme	Alarm Switch	On, Off		On	Sets whether to switch on NIBP-D Extreme alarm.
	Alarm Priority	High, Med		High	Sets the NIBP-D Extreme alarm priority.
	Alarm Output	On, Off		Off	Sets whether the parameter is automatically printed when NIBP-D Extreme alarm is triggered.
NIBP-S High (mmHg)		Adult	(Low+5) to 290	160	Sets the NIBP-S alarm limits. NIBP ≤ 50: step is 1 mmHg. NIBP > 50: step is 5 mmHg.
		Ped	(Low+5) to 240	120	
		Neo	(Low+5) to 140	90	
NIBP-S Low (mmHg)		Adult	25 to (High-5)	90	
		Ped		70	
		Neo		40	
NIBP-M High (mmHg)		Adult	(Low+5) to 260	110	Sets the NIBP-M alarm limits. NIBP ≤ 50: step is 1 mmHg. NIBP > 50: step is 5 mmHg.
		Ped	(Low+5) to 215	90	
		Neo	(Low+5) to 125	70	
NIBP-M Low (mmHg)		Adult	15 to (High-5)	60	
		Ped		50	
		Neo		25	
NIBP-D High (mmHg)		Adult	(Low+5) to 250	90	Sets the NIBP-D alarm limits. NIBP ≤ 50: step is 1 mmHg. NIBP > 50: step is 5 mmHg.
		Ped	(Low+5) to 200	70	
		Neo	(Low+5) to 115	60	
NIBP-D Low (mmHg)		Adult	10 to (High-5)	50	
		Ped		40	
		Neo		20	

Menu Item	Options/Range		Default	Description
NIBP-S Extreme High (mmHg)	Adult	high limit to 290	175	Sets the NIBP-S Extreme alarm limits. NIBP ≤ 50: step is 1 mmHg. NIBP > 50: step is 5 mmHg.
	Ped	high limit to 240	130	
	Neo	high limit to 140	95	
NIBP-S Extreme Low (mmHg)	Adult	25 to low limit	75	
	Ped		60	
	Neo		35	
NIBP-M Extreme High (mmHg)	Adult	high limit to 260	125	Sets the NIBP-M Extreme alarm limits. NIBP ≤ 50: step is 1 mmHg. NIBP > 50: step is 5 mmHg.
	Ped	high limit to 215	100	
	Neo	high limit to 125	75	
NIBP-M Extreme Low (mmHg)	Adult	15 to low limit	45	
	Ped		40	
	Neo		20	
NIBP-D Extreme High (mmHg)	Adult	high limit to 250	105	Sets the NIBP-D Extreme alarm limits. NIBP ≤ 50: step is 1 mmHg. NIBP > 50: step is 5 mmHg.
	Ped	high limit to 200	80	
	Neo	high limit to 115	65	
NIBP-D Extreme Low (mmHg)	Adult	10 to low limit	35	
	Ped		30	
	Neo		15	
<b>Setup</b>				
Initial Pressure (mmHg)	Adult	80 to 280	160	Sets the initial cuff inflation pressure.
	Ped	80 to 210	140	
	Neo	60 to 140	90	
Venipuncture Pressure (mmHg)	Auto, 20 to 120		Auto	Sets the venipuncture pressure.
Interval	Manual, Sequence, 1 min, 2 min, 2.5 min, 3 min, 5 min, 10 min, 15 min, 20 min, 30 min, 1 h, 1.5 h, 2 h, 3 h, 4 h, 8 h		15 min	Sets the interval between NIBP measurements.
Start Mode	Interval, Clock		Clock	Sets the start mode defining the NIBP auto mode.
NIBP End Tone	On, Off		Off	Sets whether the equipment issues a reminder tone at the completion of NIBP measurement.
Display Format	Sys/Dia(Mean), (Mean)Sys/Dia, Mean		Sys/Dia(Mean)	Sets the NIBP display format
Display Alarm Limits	On, Off		Off	Sets whether to display the alarm limits of diastolic NIBP and mean NIBP.
Display PR	On, Off		Off	Sets whether to display the PR value in the NIBP numeric area.
NIBP Timeout	5 min, 10 min, 15 min, 30 min, 45 min, 1 hr		15 min	Sets the timeout for the NIBP measurements.

## 22.7.4.9 CO<sub>2</sub> Setup Tab

Menu Item		Options/Range		Default	Description
<b>Alarm Setup</b>					
EtCO <sub>2</sub>	Alarm Switch	On, Off		On	Sets whether to switch on EtCO <sub>2</sub> alarm.
	Alarm Priority	High, Med		Med	Sets the EtCO <sub>2</sub> alarm priority.
	Alarm Output	On, Off		Off	Sets whether the parameter is automatically printed when EtCO <sub>2</sub> alarm is triggered.
FiCO <sub>2</sub>	Alarm Switch	On, Off		On	Sets whether to switch on FiCO <sub>2</sub> alarm.
	Alarm Priority	High, Med		High	Sets the FiCO <sub>2</sub> alarm priority.
	Alarm Output	On, Off		Off	Sets whether the parameter is automatically printed when the FiCO <sub>2</sub> alarm is triggered.
EtCO <sub>2</sub> High (mmHg)	Adult	(Low+2) to 99		50	Sets the CO <sub>2</sub> alarm limits. Step: 1 mmHg
	Ped			50	
	Neo			45	
EtCO <sub>2</sub> Low (mmHg)	Adult	1 to (High-2)		25	
	Ped			25	
	Neo			25	
FiCO <sub>2</sub> High (mmHg)	Adult	1 to 99		4	
	Ped			4	
	Neo			4	
<b>Setup</b>					
Speed	3 mm/sec, 6.25 mm/sec, 12.5 mm/sec, 25 mm/sec, 50 mm/sec			6.25 mm/sec	Sets the CO <sub>2</sub> waveform speed.
Waveform Type	Draw, Fill			Draw	Set the CO <sub>2</sub> waveform type.
CO <sub>2</sub> Scale (mmHg)	15, 20, 25, 40, 50, 60, 80			50	Sets the scale for CO <sub>2</sub> waveform.
<b>Sidestream CO<sub>2</sub> Setup (available only when connected with sidestream CO<sub>2</sub> accessories)</b>					
Auto Standby	Off, 15 min, 30 min, 60 min			60 min	Sets the CO <sub>2</sub> module to automatically enter the standby mode after a configured period of time if no respiration is detected since the last detected respiration
BTPS Compensation	On, Off			Off	Sets whether to enable humidity compensation.
O <sub>2</sub> Compensation	0% to 100%			21%	Sets the concentration for each gas.
N <sub>2</sub> O Compensation	0% to 100%			0%	
AG Compensation	0% to 24%			0%	



## 22.7.5 12-Lead Setup Menu

Menu Item	Options/Range	Default	Description
<b>Setup</b>			
Tachy (bpm)	80 to 130	100	Sets the tachycardia threshold. This setting is only effective for patients over 180 days.
Brady (bpm)	40 to 60	50	Sets the bradycardia threshold. This setting is only effective for patients over 2191 days.
QTc Formula	Hodges, Bazett, Fridericia, Framingham	Hodges	Sets the QTc formula used to correct the QT interval for heart rate. <ul style="list-style-type: none"> <li><b>Hodges:</b>  <math display="block">QTc = QT + 1.75 \times (\text{HeartRate} - 60)</math> </li> <li><b>Bazett:</b>  <math display="block">QTc = QT \times \left( \frac{\text{HeartRate}}{60} \right)^{\frac{1}{2}}</math> </li> <li><b>Fridericia:</b>  <math display="block">QTc = QT \times \left( \frac{\text{HeartRate}}{60} \right)^{\frac{1}{3}}</math> </li> <li><b>Framingham:</b>  <math display="block">QTc = QT + 154 \times \left( 1 - \frac{60}{\text{HeartRate}} \right)</math> </li> </ul>
Pre-acquisition	On, Off	Off	Sets whether the equipment acquires 10 seconds of ECG data before starting the auto measurement. <ul style="list-style-type: none"> <li><b>On:</b> if more than 10 seconds of ECG data has been acquired, the equipment immediately starts printing after you select <b>Analyze</b>.</li> <li><b>Off:</b> the equipment start printing after you select <b>Analyze</b> and 10 seconds of ECG data is acquired.</li> </ul>
Muscle Artifact Filter	Off, 35 Hz, 20 Hz	35 Hz	Muscle artifact filter attenuates noise in the waveform by restricting the included frequencies. The muscle artifact filter is a low-pass filter. Signals exceeding the set frequency are filtered out.
Disagnosis Quality	150 Hz, 350 Hz	350 Hz	This option is available only when <b>Muscle Artifact Filter</b> is set to <b>Off</b> . Sets the upper limit of frequency response to ECG waveforms. Signals higher than the limit are filtered out.
Extended Record	On, Off	Off	Sets whether a rhythm measurement is automatically started if critical values "Extreme Tachycardia", "Extreme Bradycardia", or "Significant Arrhythmia" are detected at the completion of auto measurement.
Patient Info. Input Prompt	On, Off	On	Sets whether the <b>Patient Demographics</b> menu automatically appears after you starting the auto measurement.
Screenshot	Screen Snapshot, Waveform Snapshot	Screen Snapshot	Sets the capture content after you select <b>Screenshot</b> . <ul style="list-style-type: none"> <li><b>Screen Snapshot:</b> captures the current screen.</li> <li><b>Waveform Snapshot:</b> captures 5 seconds of 12-ECG waveforms acquired before and after you select <b>Screenshot</b>.</li> </ul>
<b>Record Setup</b>			
Auto Record	On, Off	On	Sets whether the equipment immediately starts printing after you select <b>Analyze</b> in the auto measurement.

Menu Item	Options/Range	Default	Description
Median Complex	On, Off	Off	Sets whether median complex information is included in the 12-lead ECG analysis report.
Measurement Matrix	On, Off	Off	Sets whether measurement matrix information is included in the 12-lead ECG analysis report.
Measurements	On, Off	On	Sets whether measurement results are included in the 12-lead ECG analysis report.
Interpretation	On, Off	On	Sets whether diagnosis is included in the 12-lead ECG analysis report.
Interpretation Summary	On, Off	On	Sets whether interpretation summary is included in the 12-lead ECG analysis report. Interpretation summary is included in the report only when you switch on both <b>Interpretation</b> and <b>Interpretation Summary</b> .
RV5/SV1	On, Off	On	Sets whether RV5/SV1 information is included in the 12-lead ECG analysis report. RV5/SV1 information is included in the report only when you switch on both <b>Measurements</b> and <b>RV5/SV1</b> .
Amplitude	5 mm/mV, 10 mm/mV, 20 mm/mV	10 mm/mV	Sets the ECG waveform amplitude printed out.
Speed	25 mm/s, 50 mm/s,	25 mm/s	Sets the printing speed of ECG waveform.
12-Lead Format	3×4, 3×4+2	3×4	Sets the waveform format of 12-lead ECG analysis report.
Rhythm Lead 1	I, II, III, aVR, aVL, aVF, V1, V2, V3, V4, V5, V6	II	<ul style="list-style-type: none"> <li>• Sets the rhythm lead if <b>12-Lead Format</b> is set to <b>3×4+1</b>.</li> <li>• Sets the rhythm lead for a rhythm measurement.</li> </ul>
Rhythm Lead 2		V2	
Rhythm Lead 3		V5	
Format Sequence	Simultaneous, Sequential	Sequential	Sets the printing method of ECG waveforms.

### 22.7.6 TBI Warning Setup Menu

Menu Item	Options/Range	Default	Description
SpO2 Low Limit(%)	0 to 100	90	Sets the TBI warning limits for each parameter.
NIBP-S Low Limit (mmHg)	25 to 290	90	
EtCO2 Low Limit (mmHg)	1 to 44	35	
EtCO2 High Limit (mmHg)	36 to 99	45	

### 22.7.7 Record Setup Menu

Menu Item	Options/Range	Default	Description
<b>General Setup</b>			
Waveform Format	Standard, Compact, Simplified	Standard	Sets the display format of printed waveforms.
Recording Duration	8 sec, 16sec, 32sec, Continuous	8 sec	Sets the duration of real-time printing.
Printing Duration On Alarm	10 sec, 20 sec, 30 sec	20 sec	Sets the length of printed waveforms when an alarm is triggered

Menu Item	Options/Range	Default	Description
Recorder Paper Speed	6.25 mm/s, 12.5 mm/s, 25mm/s, 50mm/s	25mm/s	Sets the printing speed.
Gridlines	On, Off	On	Sets whether the printed waveforms printed are displayed with gridlines.
<b>Auto Record</b>			
Charge Event	On, Off	Off	Sets whether the event is automatically printed when the charge event is triggered.
Shock Event	On, Off	On	Sets whether the event is automatically printed when the shock event is triggered.
Auto Test Report	On, Off, Only if Failed	Off	<p>Sets whether the auto test report is automatically printed when the auto test is completed.</p> <ul style="list-style-type: none"> <li>• <b>On:</b> the auto test report is automatically printed when the auto test is completed.</li> <li>• <b>Off:</b> the auto test report is not printed when the auto test is completed.</li> <li>• <b>Only if Failed:</b> the auto test report is automatically printed when the auto test is completed and the auto test fails.</li> </ul>

## 22.7.8 Patient Management Setup Menu

Menu Item	Options/Range	Default	Description
<b>General Setup</b>			
Default Patient Category	Adult, Ped, Neo	Adult	Sets the default patient category.
Load the Latest Patient Category	Yes, No	No	Sets whether the patient category of he latest patient is applied to the current patient.
Patient Information Display	Bed No., Patient Name	Bed No.	Sets the patient information type displayed in the patient information area.
<b>Field Setup</b>			
Patient ID/Age (Gestational Age: Neo)	Selected, Unselected	Selected	Sets the item displayed in the <b>Patient Management</b> window.
Room No/Visit Number/ Middle Name/Race	Selected, Unselected	Unselected	
<b>Unit Setup</b>			
Height Unit	cm, inch	cm	Sets the default height unit for the patient.
Weight Unit	kg, lb	kg	Sets the default weight unit for the patient.
<b>Export</b>			
Include Patient Demographics When Exporting Patient Data	Yes, No	No	Sets whether patient information is included when exporting the patient data.

## 22.7.9 Network Setup

All configurations in this section can be changed in the Configuration mode only.

### 22.7.9.1 Network Type Tab

Menu Item	Options/Range	Default	Description
Network Type	Auto, LAN1 IP, WLAN, Mobile Network	Auto	Sets the network type. <b>Auto:</b> the equipment automatically identifies your network type.

### 22.7.9.2 LAN1 IP Tab

Menu Item	Options/Range	Default	Description
Obtain IP Address Automatically*	Selected, Unselected	Selected	Sets whether the equipment automatically gets the IP address.
Use the Following Address*	IP Address	0 to 255	<b>IP Address, Subnet Mask and Gateway</b> are required.
	Subnet Mask		
	Gateway		
Obtain DNS address automatically*	Selected, Unselected	Selected	Sets whether the equipment automatically gets the DNS address.
Using the Following DNS Address*	Preferred DNS Server	0 to 255	IP addresses of <b>Preferred DNS Server</b> and <b>Alternate DNS Server</b> are required.
	Alternate DNS Server		

### 22.7.9.3 WLAN Tab

Menu Item	Options/Range	Default	Description
Add WLAN	/	/	Adds wireless network and set the network in the pop-up dialog box.
Network Test	/	/	Tests whether the wireless network is properly connected.
<b>WLAN</b>			
Name	0 to 12 characters	/	Sets the name of the wireless network.
SSID	0 to 32 characters	/	/
Security	/	WEP OFF	Sets the security method.
Password	0 to 63 characters	/	Sets the password for entering the wireless network.
<b>WLAN IP</b>			
Obtain IP Address Automatically*	Selected, Unselected	Selected	Sets whether the equipment automatically gets the IP address.
Use the Following Address*	IP Address	0 to 255	<b>IP Address, Subnet Mask and Gateway</b> are required.
	Subnet Mask		
	Gateway		
Obtain DNS address automatically*	Selected, Unselected	Selected	Sets whether the equipment automatically gets the DNS address.

Menu Item		Options/Range	Default	Description
Using the Following DNS Address*	Preferred DNS Server	0 to 255	0. 0. 0. 0	IP addresses of <b>Preferred DNS Server</b> and <b>Alternate DNS Server</b> are required.
	Alternate DNS Server			
<b>WLAN Setup</b>				
WLAN Band		Auto, 5 GHz, 2.4 GHz	Auto	<b>Auto:</b> the equipment automatically identifies the WLAN band.
2.4G Channel		1, 2, 3, 4, 5, 6, 7, 8, 9, 10, 11, 12, 13, All	All	Sets 2.4G channels.
5G Channel		36, 40, 44, 48, 149, 153, 157, 161, 165, All	All	Sets 5G channels.
<b>Certificate Management</b>				
Local		/	/	<b>Delete:</b> deletes the selected certifications.
USB Drive		/	/	Selects certifications you want to import from the USB drive, and then select <b>Import</b> to import the desired certifications.

#### 22.7.9.4 Mobile Network Setup Tab

Menu Item		Options/Range	Default	Description
SIM Card		Card 1, Card 2	Card 1	Selects the desired SIM card.
APN Name (SIM Card 1)/APN Name (SIM Card 2)		0 to 30 characters	/	Sets the name, user name or password of desired SIM card.
APN User Name (SIM Card 1)/APN User Name (SIM Card 2)				
APN Password (SIM Card 1)/APN Password (SIM Card 2)				

#### 22.7.9.5 Central Station Setup Tab

Menu Item		Options/Range	Default	Description
Select CMS*		On, Off	On	Sets whether to display available CMS.
Bedside monitors auto connect to CMS*		On, Off	On	Sets whether the CMS is automatically connected after turned on.
Add Central Station		/	/	Sets the name, department and server address of desired CMS.
Network Test		/	/	Tests whether the desired CMS is properly connected.

### 22.7.9.6 Device Discover Tab

Multicast helps device discovery between the equipments, or between the equipment and CMS. Equipments in the same multicast group can be mutually discovered.

Menu Item	Default Setting	Description
Multicast TTL	1	Sets the live time and IP address of multicast group.
Multicast Address	225.0.0.8	
Master Server Address	/	Sets the IP address of the master server.
Connected Status	/	Displays the connection status of the master server.

### 22.7.9.7 QoS Tab

Menu Item	Default Setting	Description
QoS Level For Realtime Monitoring	0	Sets the service quality of network connection for real-time monitoring, for example parameter measurements and waveforms, alarms, and so on
QoS Level For Others	0	Sets the service quality of network connection for non-real-time monitoring, for example history data, printing, and as on.

### 22.7.9.8 Information Security Tab

Menu Item	Options/Range	Default	Description
Broadcast Patient Demographics	On, Off	On	<ul style="list-style-type: none"> <li><b>On:</b> when viewing other patients, device location and patient information of remote devices are displayed in the remote device list.</li> <li><b>Off:</b> patient information does not display in the remote device list.</li> </ul>

### 22.7.9.9 HL7 Setup Tab

Menu Item	Options/Range	Default	Description
<b>Data + Waveforms Setup</b>			
Server Address	0 to 63 characters	/	Sets the desired HL7 server.
Destination IP	0 to 255	0.0.0.0	
Port	0 to 65535	0	
Send Data	On, Off	Off	Sets whether monitoring parameters are automatically sent to the HL7 server.
Data Interval	1 sec, 30 sec, 5min, 30min, 1h	1 sec	Sets the interval for sending data to the HL7 server.
Send Waveforms	On, Off	Off	Sets whether waveforms are automatically sent to the HL7 server.
<b>Alarm Setup</b>			
Server Address	0 to 63 characters	/	Sets the desired HL7 server.
Destination IP	0 to 255	0.0.0.0	
Port	0 to 65535	0	
Send Alarms	On, Off	Off	Sets whether alarms are automatically sent to the HL7 server.

Menu Item	Options/Range	Default	Description
<b>Compatibility</b>			
HL7 Protocol Version	/	HL7 Protocol Version 1.0	Sets the version of the HL7 protocol.

### 22.7.9.10 FTP Setup Tab

Menu Item	Options/Range	Default	Description
Name	0 to 12 characters	/	Sets the desired FTP server.
Server Address	0 to 64 characters	/	
Port	0 to 65535	0	
Username	0 to 30 characters	/	
Password	0 to 30 characters	/	
ECG Report	XML, PDF	XML	Sets the default report format transferred to the FTP server.

### 22.7.9.11 Time Synchronization Setup Tab

Menu Item	Options/Range	Default	Description
Start NTP Time Sync	On, Off	Off	Sets whether the equipment system time synchronizes with that on the NTP server.
Interval	10 sec, 30 sec, 1 min, 5 min, 30 min, 1 hr, 2 hrs, 6 hrs, 12 hrs, 24 hrs	1 hr	Sets the interval for time synchronization.
Time Server Address	0 to 64 characters	/	Sets the name of the desired NTP server.
Time Server	0 to 255	0.0.0.0	Sets the IP address of the desired NTP server.
Connected Status	Connected, Disconnected	/	Displays the connection status of the desired NTP server.
Network Test	/	/	Tests whether the desired NTP server is properly connected.

### 22.7.10 Test Setup Menu

Menu Item	Options/Range	Default	Description
<b>General Setup</b>			
User Test Prompt	On, Off	Off	Sets whether the equipment reminds to perform the user test if the recommended test time is reached.
Auto Test Time	24 h: 00 to 23 12 h: 12AM to 11PM	3:00	Sets the initiated time for auto test performed every day.
Auto Test Energy	10 J, 20 J, 30 J, 50 J, 70 J, 100 J	10 J	Sets the energy level delivered by the auto test.
<b>Report Custom</b>			

Menu Item	Options/Range	Default	Description
Pacer Function/Energy Delivery/Monitor Module/Mainboard/Recorder/Controls/Audio/Display/Status Indicator/Contact Indicator	On, Off	Off	Sets the item displayed on test summaries.
Battery/Defib Function/External Paddles (for equipment configured with paddle tray)/Energy Accuracy	On, Off	On	



# 23 Battery

---

## 23.1 Battery Introduction

When the external power supply is not available, the equipment is designed to operate on the battery power. In case of a sudden power failure, the equipment automatically operates on the battery power without interrupting therapy and monitoring. Therefore, it is recommended that the equipment is always connected with a fully charged battery.

## 23.2 Battery Safety Information

---

### WARNING

---

- **Keep batteries out of children's reach.**
  - **Use only specified battery. Use of a different battery may present a risk of fire or explosion.**
  - **Keep the batteries in their original package until you are ready to use them.**
  - **Do not expose batteries to liquid.**
  - **Do not crush, drop or puncture the battery. Mechanical abuse can lead to internal damage and internal short circuits. If a battery has been dropped or banged against a hard surface, whether damage is externally visible or not, remove the battery from use and dispose of it properly.**
  - **If the battery shows signs of damage or signs of leakage, replace it immediately.**
  - **The battery should be charged in this equipment or the specified charger station.**
  - **Extremely high ambient temperature may cause battery overheat protection, resulting in equipment shutdown.**
  - **Do not open batteries, heat batteries above 60 °C, incinerate batteries, or short battery terminals. They may ignite, explode, leak or heat up, causing personal injury.**
- 

### NOTE

---

- **Always connect the equipment to external power supply whenever it is possible.**
  - **Always install a fully charged battery in the equipment.**
- 

## 23.3 Replacing the Battery

Replace one battery configured with a battery compartment is taken as an example below. If the battery is not configured with a battery compartment, compartment related operations can be ignored in the following steps.

To replace the battery, follow this procedure.

1. Move the latch upward to unlock the battery compartment.

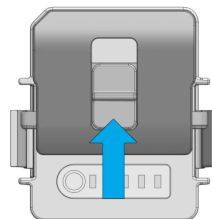

2. Squeeze latches on both sides of the battery, and take the battery out.

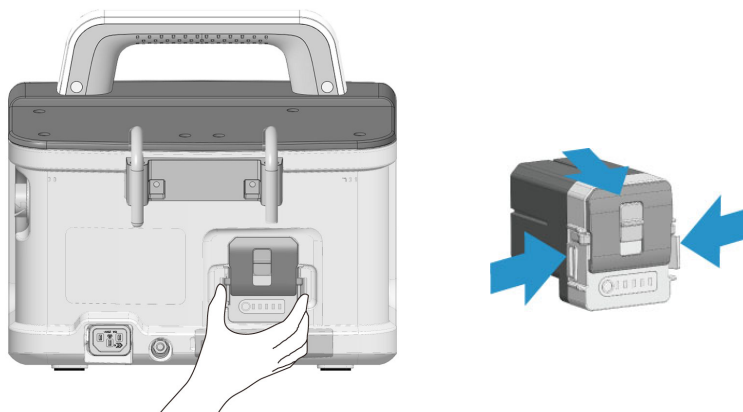

3. Align a new battery with the battery compartment, and push it until you hear it clicks into the place.

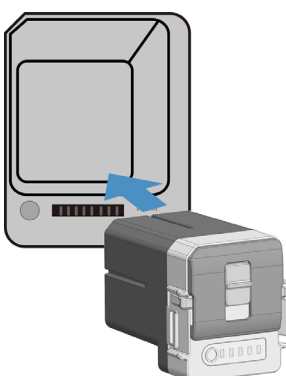

4. Move the latch downward to lock the battery compartment.

## 23.4 Battery Indications

The battery indicator, battery power indicator, on-screen battery symbol, and related alarm messages indicate the battery status.

### NOTE

- **After long term use, the power capacity indicated by the battery symbol may be different from the actual capacity. Always observe the alarm information displayed on the screen.**





### 23.4.1 Battery Indicator

The battery indicator on the front panel indicates the following status:

- Yellow: the battery is being charged.
- Green: the battery is fully charged the equipment operates on battery power.
- Off: no battery is installed or battery fails.

### 23.4.2 Battery Symbols

The on-screen battery symbols indicates the following status:

-  indicates that the battery operates properly. The green portion represents the remaining charge. Each bar represents 20% of battery capacity.
-  indicates that the battery power is low and needs to be charged.
-  indicates that the battery is almost depleted and needs to be charged immediately. Otherwise, the equipment will soon automatically shut down.
-  indicates that the battery is being charged.

-  indicates that no battery is installed or the battery fails.

### 23.4.3 Battery Power Indicator

The battery power indicator  is on the outside of the battery. The battery power indicator consists of five LEDs, each LED represents 20% of battery capacity. Pressing the button beside LED can display the remaining battery power.

### 23.4.4 No Battery Alarm

When the equipment is powered by the external power supply only, the status indicator flashes in red and the alarm **"No Battery"** is displayed.

You can disable the display of this prompt. The setting of **No Battery** can be changed in the Configuration mode only. For more information, see [22.7.3 Alarm Setup Menu](#).

### 23.4.5 Low Battery Alarm

When the equipment is powered by the battery only and the capacity is less than 60%, the prompt **"The battery capacity is less than 60%"** is displayed.

When the equipment is powered by the battery only and the battery has a low power, the status indicator flashes in red and the prompt **"The battery capacity is less than 60%"** is displayed. If the equipment is in any clinical mode with alarms paused or off, alarm lights and alarm tones are provided. If the equipment is turned off, a beep is periodically provided. In this case, you should immediately connect the equipment to external power supply.

When the equipment is powered by the battery only and the battery is almost depleted, **"Battery depleted! System will shut down immediately. Connect to the external power supply."** is displayed in a message box. If the equipment is in any of Monitor, Manual Defib and Pacer modes, alarm lights and alarm tones are provided. In this case, you should immediately connect the equipment to external power supply. This message box persists until you connect the equipment to the external power supply. If no action is taken, the equipment will automatically shut down in 3 minutes.

#### NOTE

- **The alarm "Low Battery" means that the battery is beginning to weaken, you should immediately connect the equipment to the external power supply. After this alarm is triggered, at least 20 minutes of monitoring and 6 shocks at 360J can be performed.**

### 23.4.6 Battery Aged Alarm

If runtime of the installed battery is significantly shorter than the specification, the alarm **"Battery aged, replace the battery."** is displayed. In this case, replace with a new battery or contact your service personnel.

### 23.4.7 Battery Error Alarm

If the installed battery has a failure, the alarm **"Battery Error"** is displayed. In this case, replace with a new battery or contact your service personnel.

## 23.5 Charging the Battery

The battery is automatically charged when connected to the external power supply, regardless of the equipment is turned on or off. The charging will be slower with the equipment turned on.

## 23.6 Conditioning the Battery

The performance of batteries deteriorates over time. To extend the battery service life, you should condition the batteries at least every 6 months (every 3 months is recommended).

If the battery is not conditioned for a prolonged time, its charge indication may not be accurate and you may wrongly evaluate the remaining battery runtime.

To condition a battery:

1. Disconnect the equipment from the patient and stop all performances.
2. Allow the battery to be charged uninterruptedly till it is fully charged.
3. Allow the equipment to operate on the battery until the battery is completely depleted and the equipment automatically shuts down.
4. Fully charge the battery again for use or charge it to 40% to 60% for storage.

#### NOTE

---

- **Do not use the equipment during battery conditioning.**
  - **Do not interrupt battery conditioning.**
- 

## 23.7 Checking Battery Performance

The performance of a rechargeable battery deteriorates over time. To extend the battery service life, it is recommended to check the battery performance every three months or if you doubt that the battery may fail.

See steps 1 to 3 of *23.5 Charging the Battery* to check battery performance. The operating time of the batteries reflects their performance directly. If the operating time of a battery is noticeably shorter than that stated in the specifications, the battery may reach its service life or malfunction. If the battery performance meets the requirement, fully charge the battery again for use or charge it to 40% to 60% for storage.

#### NOTE

---

- **Life expectancy of a battery depends on how frequent and how long it is used. When properly used, the lithium-ion battery has a useful life of approximately two years. If improperly used, its life expectancy can be shorten. It is recommended to replace the battery every two years.**
  - **To optimize the battery performance, a fully discharged (or near fully discharged) battery should be charged as soon as possible.**
  - **Battery operating time depends on the equipment configuration and operation. For example, measuring NIBP repeatedly will shorten the battery operating time.**
- 

## 23.8 Storing Batteries

When storing batteries, make sure that the battery terminals do not come into contact with metal objects. If batteries are not installed in the equipment, and stored for an extended period of time, they should be placed in a cool place with a partial charge of 40% to 60% capacity (3 LEDs of battery power indicator illuminated).

Condition the stored batteries every three months. For more information, see *23.5 Charging the Battery*.

#### NOTE

---

- **Remove the battery from the equipment if the equipment is not used for a prolonged time (for example, several weeks). Otherwise the battery may overdischarge.**
  - **Storing batteries at high temperature for an extended period of time will significantly shorten their life expectancy.**
  - **The battery storage temperature is between -20°C (-4°F) and 60°C (140°F). Storing batteries in a cool place can slow the aging process. Ideally the batteries should be stored at 15 °C.**
-

## 23.9 Recycling Batteries

Discard a battery in the following situations:

- The battery has visual signs of damage.
- The battery fails.
- The battery is aged and its runtime is significantly less than the specification.
- The battery service life is reached.

Properly dispose of batteries according to local regulations.

**This page intentionally left blank.**

# 24 Care and Cleaning

---

## 24.1 Care and Cleaning Introduction

This chapter only describes cleaning and disinfection of the equipment and certain accessories. For the cleaning and disinfection of other reusable accessories, see the corresponding instructions for use.

## 24.2 Care and Cleaning Safety Information

---

### WARNING

---

- Use only cleaners, disinfectants and methods specified in this chapter. Using unapproved substances or methods may damage the equipment and void the warranty.
  - Do not mix disinfecting solutions, as hazardous gases may result.
  - Mindray is not liable for the efficacy of the specified cleaners, disinfectants, or methods as a means for controlling infection. Refer to your hospital for infection controlling.
  - Be sure to power off the equipment and disconnect all power cables from the outlets before cleaning the equipment.
  - The responsible hospital or institution shall carry out all cleaning and disinfection procedures specified in this chapter.
- 

### CAUTION

---

- Never immerse any part of the equipment or accessories in liquids or allow liquid to enter the interior.
  - Any contact of cleaners or disinfectants with connectors or metal parts may cause corrosion.
  - Do not pour or spray any liquid directly on the equipment or accessories or permit fluid to seep into connections or openings.
  - If you spill liquid on the equipment or accessories, disconnect the power supply, dry the equipment, and contact your service personnel.
  - Never use abrasive materials (such as steel wool or silver polish), or erosive cleaners (such as acetone or acetone-based cleaners).
  - Dilute and use the cleaners or disinfectants according to the manufacturer's instructions.
  - Check the equipment after cleaning and disinfecting. If there is any sign of damage, remove it from use.
- 

## 24.3 Cleaning and Disinfecting the Equipment

### 24.3.1 Cleaning the Main Unit

Clean your equipment on a regular basis. Before cleaning the equipment, consult your hospital's regulations for cleaning the equipment.

To clean the equipment, follow this procedure:

1. Dampen a soft lint-free cloth with water or ethanol (70%).
2. Wring excess liquid from the cloth.
3. Wipe the display screen of the equipment
4. Wipe the external surface of the equipment with the damp cloth, avoiding the connectors and metal parts.
5. Dry the surface with a clean cloth. Allow the equipment air dry in a ventilated and cool place.

---

**CAUTION**

---

- **During the cleaning procedure, disable the touch function by turning off the equipment or locking the touchscreen.**
- 

### 24.3.2 Cleaning the Thermal Print Head

Dirty print head deteriorates printing quality. Check the printout to ensure the printing is legible and dark. Light printing may indicate a dirty print head.

To clean the thermal print head, follow this procedure:

1. Take measures against the static electricity, such as the wrist strap.
2. Open the recorder door and remove the recorder paper.
3. Gently wipe the print head with cotton swabs dampened with ethanol to remove the dust and foreign particles.
4. Wipe off excess moisture with dry cotton swabs.
5. Allow the print head air dry.
6. Reload the recorder paper and close the recorder door.

---

**CAUTION**

---

- **Do not use anything that may destroy the thermal element.**
  - **Do not add unnecessary force to the thermal head.**
  - **The thermal print head gets hot when printing. Do not clean the print head immediately after printing.**
- 

### 24.3.3 Disinfecting the Equipment

Disinfect the equipment as required in your hospital's servicing schedule. Cleaning the equipment before disinfecting is recommended. Always dilute and use disinfectants according to the manufacturer's instructions. The following table lists approved disinfectants:

Product Name	Product Type	Manufacturer
Alpet® D2 Surface Sanitizing Wipes	Wipes	BEST SANITIZERS INC™.
CIDEX® OPA	Liquid	Gilag GmbH International Advanced Sterilization products
Clorox Dispatch® Hospital Cleaner Disinfectant Towels with Bleach	Wipes	Clorox professional products company
Clorox Healthcare® Bleach Germicidal Wipes	Wipes	Clorox professional products company
Clorox Healthcare® Hydrogen Peroxide Cleaner Disinfectant Wipes	Wipes	Clorox professional products company
Diversey Oxivir® TB Wipes	Wipes	Diversey Inc
Metrex CaviCide1™	Liquid, spray	METERX® RESEARCH
Metrex CaviWipes™	Wipes	METERX® RESEARCH
PDI Sani-Cloth® AF3 Germicidal Disposable Wipe	Wipes	PDI Inc.
PDI Sani-Cloth® Bleach Germicidal Disposable Wipe	Wipes	PDI Inc.



Product Name	Product Type	Manufacturer
PDI Sani-Cloth® HB Germicidal Disposable Wipe	Wipes	PDI Inc.
PDI Sani-Cloth® Plus Germicidal Disposable Cloth	Wipes	PDI Inc.
PDI Super Sani-Cloth® Germicidal Disposable Wipe	Wipes	PDI Inc.
Virex® II 256 (1:256)	Liquid	Diversey Inc
Virex® TB	Liquid, spray	Diversey Inc
JIAN ZHI SU Disinfectant Tablets	Tablet	Beijing ChangJiangMai Medical Science Technology Co. Ltd
JIAN ZHI SU Surface Disinfectant Spray	Liquid, spray	Beijing ChangJiangMai Medical Science Technology Co. Ltd
JIAN ZHI SU Disinfectant, Double-chain Quaternary Ammonium	Liquid	Beijing ChangJiangMai Medical Science Technology Co. Ltd
DIAN'ERKANG Surface Wipes	Wipes	Shanghai Likang Disinfectant Hi-Tech Co., Ltd
DIAN'ERKANG Surface Disinfectant	Liquid	Shanghai Likang Disinfectant Hi-Tech Co., Ltd
DIAN'ERKANG Disinfectant Spray	Liquid, spray	Shanghai Likang Disinfectant Hi-Tech Co., Ltd
Clinell® Universal Wipes	Wipes	GAMA Healthcare Ltd
Clinell® Sporicidal Wipes	Wipes	GAMA Healthcare Ltd
Tristel Duo™	Liquid, foam	Tristel solutions Limited
Tristel Jet	Liquid, spray	Tristel solutions Limited
Tristel Fuse For Surfaces, 196ppm	Liquid	Tristel solutions Limited
Surfanios Premium, 0.25%	Liquid	ANIOS LABORATORIES
Surfa 'safe	Liquid, spray	ANIOS LABORATORIES
Wip' Anios premium	Wipes	ANIOS LABORATORIES
Aniosurf ND premium, 0.25%	Liquid	ANIOS LABORATORIES
Mikrobac® Tissues	Wipes	BODE Chemie GmbH
Cleanisept® Wipes	Wipes	Dr. Schumacher GmbH
mikrozid® PAA Wipes	Wipes	Schülke & Mayr GmbH
mikrozid® Sensitive Wipes	Wipes	Schülke & Mayr GmbH
Ecolab Incidin® OxyWipe S	Wipes	Ecolab Deutschland GmbH
Glutaraldehyde, 2%	Liquid	/
Ethanol, 70%	Liquid	/

Product Name	Product Type	Manufacturer
Isopropanol, 70%	Liquid	/
Sodium hypochlorite bleach, 0.5%	Liquid	/
Hydrogen peroxide, 3%	Liquid	/
Rely+On™ Virkon® High Level surface Disinfectant, 1%	Powder	Antec International Ltd
1-Propanol, 50%	Liquid	/
Descosept® forte	Liquid	Dr. Schumacher GmbH
Descosept® AF	Liquid	Dr. Schumacher GmbH
Dismozon® plus, 0.4%	Powder	BODE Chemie GmbH
mikrozid® AF Wipes	Wipes	Schülke & Mayr GmbH
Terralin® Liquid	Liquid	Schülke & Mayr GmbH
Perform® Classic Concentrate OXY, 0.5%	Powder	Schülke & Mayr GmbH

## NOTE

- **It is recommended to immediately wipe off disinfectants residue from the equipment after the disinfection. Otherwise enclosure cracks may result.**

## 24.4 Cleaning and Disinfecting the Accessories

For the NIBP air hose and SpO<sub>2</sub> cable, you should clean and disinfect them using the cleaners and disinfectants and methods listed in this section. For other accessories, you should consult the instructions delivered with the accessories.

### CAUTION

- **Fluids entering the NIBP air hose can damage the equipment. When cleaning or disinfecting the NIBP air hose, prevent liquid from entering the hose.**
- **Periodically inspect the NIBP air hose and connector for signs of wear or deterioration after cleaning or disinfecting the NIBP air hose. Replace the NIBP air hose if you detect a leak. Dispose of damaged NIBP air hose according to local laws for disposal of hospital waste.**
- **Never immerse or soak the accessories in any liquid.**
- **Never clean or disinfect the connectors and metal parts.**
- **Use only Mindray approved cleaners and disinfectants and methods listed in this section to clean or disinfect the accessories. Warranty does not cover damage caused by unapproved substances or methods.**
- **To avoid long term damage, the accessories should be disinfected only when necessary as determined by your hospital's policy.**

### 24.4.1 Cleaning the Accessories

You should clean the NIBP air hose and SpO<sub>2</sub> cable on a regular basis. Before cleaning the accessories, consult your hospital's regulations for cleaning the accessories.

To clean the accessories, follow this procedure:

1. Clean the accessories with a soft cloth moistened with water or ethanol (70%).
2. Wipe off all the cleaner residue with a dry cloth.
3. Allow the accessories to air dry.

## 24.4.2 Disinfecting the Accessories

It is recommended that the NIBP air hose and SpO<sub>2</sub> cable should be disinfected only when necessary as determined by your hospital's policy. Cleaning the accessories before disinfecting is recommended.

### 24.4.2.1 Disinfectants for the NIBP Air Hose

The following table lists approved disinfectants for the NIBP air hoses:

Product Name	Product Type	Manufacturer
Alpet® D2 Surface Sanitizing Wipes	Wipes	BEST SANITIZERS INC™.
CIDEX® OPA	Liquid	Gilag GmbH International Advanced Sterilization products
Clorox Dispatch® Hospital Cleaner Disinfectant Towels with Bleach	Wipes	Clorox professional products company
Metrex CaviCide1™	Liquid, spray	METERX® RESEARCH
Metrex CaviWipes™	Wipes	METERX® RESEARCH
PDI Sani-Cloth® AF3 Germicidal Disposable Wipe	Wipes	PDI Inc.
PDI Sani-Cloth® Plus Germicidal Disposable Wipe	Wipes	PDI Inc.
PDI Super Sani-Cloth® Germicidal Disposable Wipe	Wipes	PDI Inc.
Virex® TB	Liquid, spray	Diversey Inc
Clinell® Universal Wipes	Wipes	GAMA Healthcare Ltd
Surfa 'safe	Liquid, spray	ANIOS LABORATORIES
Aniosurf ND premium, 0.25%	Liquid	ANIOS LABORATORIES
mikrozid® Tissues	Wipes	Schülke & Mayr GmbH
Glutaraldehyde, 2%	Liquid	/
Ethanol, 70%	Liquid	/
Isopropanol, 70%	Liquid	/
Rely+On™ Virkon® High Level surface Disinfectant, 1%	Powder	Antec International Ltd
1-Propanol, 50%	Liquid	/

### 24.4.2.2 Disinfectants for the SpO<sub>2</sub> Cable

The following table lists approved disinfectants for the SpO<sub>2</sub> cables:

Product Name	Product Type	Manufacturer
CIDEX® OPA	Liquid	Gilag GmbH International Advanced Sterilization products
Clorox Dispatch® Hospital Cleaner Disinfectant Towels with Bleach	Wipes	Clorox professional products company

Product Name	Product Type	Manufacturer
Clorox Healthcare® Bleach Germicidal Wipes	Wipes	Clorox professional products company
Clorox Healthcare® Hydrogen Peroxide Cleaner Disinfectant Wipes	Wipes	Clorox professional products company
Diversey Oxivir® TB Wipes	Wipes	Diversey Inc
PDI Super Sani-Cloth® Germicidal Disposable Wipe	Wipes	PDI Inc.
Virex® TB	Liquid, spray	Diversey Inc
Glutaraldehyde, 2%	Liquid	/
Ethanol, 70%	Liquid	/
Isopropanol, 70%	Liquid	/
Sodium hypochlorite bleach, 0.5%	Liquid	/
Hydrogen peroxide, 3%	Liquid	/
Rely+On™ Virkon® High Level surface Disinfectant, 1%	Powder	Antec International Ltd
1-Propanol, 50%	Liquid	/

## 24.5 Sterilization

Do not sterilize the equipment, accessories, or supplies unless otherwise specified in the instructions for use delivered with the accessories and supplies.

## 24.6 Impact of Improper Cleaning

Using cleaners other than those recommended may have the following impacts:

- Product discoloration
- Metal part corrosion
- Brittle and breaking wires, connectors, and equipment housing
- Reduced cable and leadwire life
- Overall system performance degradation
- Equipment malfunction or failure

# 25 Maintenance

---

## 25.1 Maintenance Introduction

The equipment must be maintained to be ready for immediate use. To ensure proper performance of the equipment, you should strictly perform the maintenance in this chapter. After the equipment has been used for 12 months, or whenever the equipment is repaired or upgraded, a thorough inspection should be performed to ensure the reliability.

Make sure to clean and disinfect the equipment before any test and maintenance.

In case of any damage or abnormality, remove the equipment from use. Contact the hospital's biomedical engineers or your service personnel immediately.

## 25.2 Maintenance Safety Information

---

### WARNING

---

- **Stop using the equipment for any signs of visible damages. If damaged, contact your service personnel.**
  - **Follow the maintenance and testing schedule or local regulations to perform testing and maintenance. Not implementing the maintenance schedule may cause equipment failure and possible health hazards.**
  - **No modification of this equipment is allowed.**
  - **This equipment contains no user serviceable parts.**
  - **Do not open the equipment housings. The safety checks or maintenance involving any disassembly of the equipment should be performed by professional servicing personnel. Otherwise, undue equipment failure and possible health hazards could result.**
  - **Do not touch any connected electrode pads or external paddles with hands during auto test and user test. Otherwise, electric shock could result.**
  - **The service personnel must be properly qualified and thoroughly familiar with the operation of the equipment.**
- 

### CAUTION

---

- **The equipment and accessories shall not be served or maintained while in use with a patient.**
  - **If a problem occurs to the equipment, contact the service personnel.**
  - **At the end of its service life, the equipment, as well as its accessories, must be disposed of in compliance with the guidelines regulating the disposal of such products. If you have any questions concerning disposal of the equipment, please contact Mindray.**
- 

### NOTE

---

- **If needed, contact the manufacture for circuit diagrams, component part lists, descriptions, calibration instructions, or other information concerning the repair of the equipment.**
- 

## 25.3 Checking Software Information

You may be asked for information on the equipment software.

To view the system software information, select the **Main Menu** quick key, and select **Version** from the **System** column.

You can view more equipment information in the User Maintenance mode. For more information, see *25.6.1 User Maintenance Settings*.

## 25.4 Routine Maintenance

The routine maintenance should be periodically performed in conjunction with the assurance program of the hospital where the equipment is used.

The following table lists recommended maintenance items and frequencies:

Maintenance Item	Recommend Frequency	Test Item
Shift check	Every shift (at least every day), after use.	For more information, consult your institution or see <i>E Defibrillator Shift Checklist</i> .
Auto test	Automatically, whenever the equipment is turned on.	Performs tests of the main control board, therapy module, monitor module, batteries.
	Every day, 3:00 am by default	Performs tests of the main control board, therapy module, monitor module, batteries, 1 J internal discharge, 10 J internal discharge/external discharge <sup>1</sup> (configurable in the Configuration mode, see 22.7.10 <i>Test Setup Menu</i> ).
	Every week	Performs tests of the main control board, therapy module, monitor module, batteries, 1 J internal discharge, 10 J internal discharge/external discharge <sup>1</sup> (configurable in the Configuration mode, see 22.7.10 <i>Test Setup Menu</i> ), 200 J and 360 J internal discharges.
User test	Every week	Performs tests of the main control board, therapy module, monitor module, battery, 1 J internal discharge, 200 J internal discharge/external discharge <sup>1</sup> , 360 J internal discharge/external discharge <sup>1</sup> , external paddles connection (for equipment configured with paddle tray), all buttons on the front panel <sup>2</sup> , audio <sup>2</sup> , display <sup>2</sup> , patient contact indicator <sup>2</sup> and status indicator <sup>2</sup> .
<sup>1</sup> If the pads cable is connected with 50 Ω test load or external paddles are placed in the paddle tray, an external discharge is performed. Otherwise, an internal discharge is performed. <sup>2</sup> Test items can be ignored during the user test, but you are recommended to perform these tests at least once a year.		

External paddles and pads cable are critical parts for defibrillation but damageable. It is recommended to inspect the appearance and performance of these parts every day and replace them every three years.

The ECG cables are critical parts for data acquisition and analysis but damageable. It is recommended to inspect the appearance and performance of the cable every day as described in *E Defibrillator Shift Checklist*.

### 25.4.1 Auto Test

The auto test checks the equipment performance and alerts if a problem exists. The equipment either connected with the external power supply or installed with a battery can carry out the auto test at the configured time even if it is turned off.

The auto test is initiated at 3:00 am every day by default. The setting of **Auto Test Time** can be changed in the Configuration mode. For more information, see 22.7.10 *Test Setup Menu*.

The equipment displays no information on the screen during the auto test. You can check the auto test result according to the following table:

From	Pass	Fail
Status indicator and alarms	<ul style="list-style-type: none"> <li>The status indicator illuminates in green.</li> <li>No alarms are displayed on the screen.</li> </ul>	<ul style="list-style-type: none"> <li>The status indicator flashes in red.</li> <li>A beep is periodically provided until the equipment is restarted.</li> <li>The alarm "<b>Last Auto Test Failed</b>" is displayed.</li> </ul>
Test summary	Test results are provided in a test summary. For details on checking the results, see 25.4.3 <i>Checking the Test Results</i> .	
CMS	If the equipment is connected to the CMS, the auto test report will be automatically transmitted to the CMS at the completion of the auto test. For details on connecting the CMS, see 21.5 <i>Connecting the CMS</i> .	

It is recommended to perform the user test if the auto test failed. For more information, see 25.4.2 *User Test*.

When the auto test is completed, an auto-test report is saved automatically. The setting of **Auto Test Report** can be changed in the Configuration mode. For more information, see 22.7.10 *Test Setup Menu*.

## NOTE

---

- **If the equipment is turned off, it can carry out the auto test only when it is either connected with the external power supply or installed with a battery.**
  - **The auto test simulates the discharge test through impedances in the paddle tray. The auto test passes only when external paddles properly contact the metal parts of the paddle tray.**
  - **Thoroughly clean the external paddles and properly place them in the paddle tray after each use. Otherwise, the auto test may fail or damaged external paddles may result.**
  - **The auto test reduces the battery power. If the equipment is not connected to the external power supply immediately, low battery may result.**
  - **Before the auto test, check that the equipment is connected to the external power supply or installed with a battery, and external paddles are properly placed in the paddle tray or the equipment is connected with the pads cable and 50  $\Omega$  test load. If the auto test passed but the pads cable is not connected with the 50  $\Omega$  test load, "Test load not connected with cable" is displayed on the auto test report. This means that the equipment only passes the internal discharge test, but not pass the external discharge test connected with the test load.**
- 

## 25.4.2 User Test

If the auto test fails, you should check the equipment connection and perform the user test to clear the faults.

Each time when the equipment is turned on, the time to user test is automatically checked. The equipment can be configured to prompt "**User Test Due**" to remind performing the user test. The switch setting of **User Test Prompt** can be changed in the Configuration mode only. For more information, see 22.7.10 *Test Setup Menu*.

---

---

## WARNING

- **If the equipment has been dropped or strongly impacted, you should immediately perform a user test to check the equipment performance.**
  - **Do not perform the user test when a patient is connected to the equipment.**
- 
- 

## NOTE

---

- **Before the user test or after each use, thoroughly clean the external paddles and properly place them in the paddle tray. The user test passes only when external paddles properly contact the metal parts of the paddle tray.**
  - **During the user test, charge and discharge items can automatically detect the type of the connected therapy cable and perform the corresponding test. If different types of therapy cables (pads cable or paddles cable) are required, you should separately connect the desired therapy cables and perform a separate user test.**
  - **If the impedance value indicated by patient contact indicator changes greatly, check that external paddles and metal parts of the paddle tray are clean.**
  - **Install at least one battery and properly place the external paddles in the paddle tray or connect the pads cable and 50  $\Omega$  test load. Otherwise the user test will fail.**
  - **The power switch is not tested during the buttons test. If you press and hold the power switch for more than 3 seconds, the equipment will be turned off.**
  - **The tested buttons illuminate in green during the buttons test.**
- 

### 25.4.2.1 Accessing the Test Mode

In the Test mode, patient therapy and monitoring automatically end.

To access the Test mode, follow this procedure:

1. Select the **Main Menu** quick key → from the **Common** column select **User Test**.
2. Select **Confirm**.

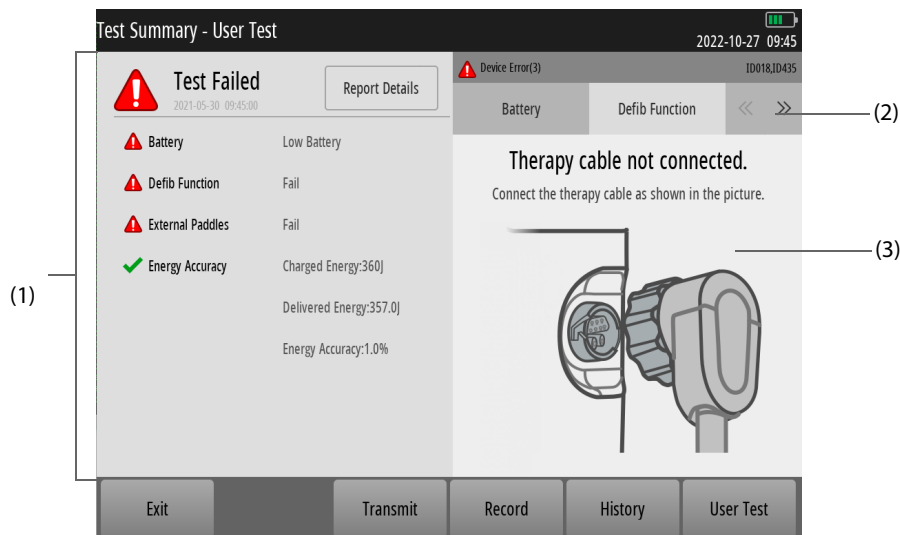

- (1) Last test summary: displays tests results of battery, external paddles (for equipment configured with paddle tray) and energy accuracy by default. The display of test items can be changed in the Configuration mode only. For more information, see 22.7.10 Test Setup Menu.
- (2) Test fault tab: displays the detailed fault item, and gives corrective instructions with text and picture. Selecting << or >> can display more tabs.
- (3) Fault clearing instructions

### 25.4.2.2 Starting the User Test

In the Test mode, select **User Test** to start a user test.

The test summary is displayed at the completion of test. Then you can select **Record** to print out the test result.

If any test item of **Battery**, **Defib Function**, **Pacer Function** and **Energy Delivery** fails, the status indicator flashes in red and the alarm “**Last User Test Failed**” is displayed when the equipment is restarted. If any test item of **Battery1**, **Battery2**, **Defib Function**, **Pacer Function** and **Energy Delivery** fails, the status indicator flashes in red and the alarm “**Last User Test Failed**” is displayed when the equipment is restarted.

### 25.4.3 Checking the Test Results

When the status indicator flashes in red, and the alarm “**Last Auto Test Failed**” or “**Last User Test Failed**” is displayed, the last test fails. In this case, you should access the Test mode to check the test result and clear the faults. For more information, see 25.4.2.1 Accessing the Test Mode.

#### 25.4.3.1 Viewing Last Test Result

When accessing the Test mode, the last test summary is displayed. If needed, you can select **Report Details** to view more details.

#### NOTE

- If the routine test item (external discharge) of the auto test, or the energy delivery test item (external discharge) of the user test is passed, the delivered energy and accuracy are displayed, but results are for your reference only.

#### 25.4.3.2 Clearing Last Test Faults

If the last test fails, you should clear the fault item and perform a successful user test. To do so, follow this procedure:

1. Access the Test mode. For more information, see 25.4.2.1 Accessing the Test Mode.
2. Select the desired fault tab under **Device Error**.
3. If needed, select << or >> to display more tabs.



4. Clear the faults following the displayed instructions.
5. Select **User Test** and perform the user test.

### 25.4.3.3 Viewing Historical Test Results

In the Test mode, select **History** to view historical test result. If needed, select one desired test for more test details.

To print out more than one test reports by the recorder at a time, you can select **Record**, then select the desired tests from the report list.

### 25.4.4 Transmitting the Test Reports

If connected to the CMS, the equipment automatically transmits the auto and user test reports to the CMS at the completion of test. For details on connecting the CMS, see *21.5 Connecting the CMS*.

## 25.5 Function Checks

The function checks enhance the auto test that helps the equipment to ensure the readiness. It is recommended to perform the function checks once a year. The function checks, except the recorder check, should be performed by Mindray-qualified service personnel only.

### 25.5.1 Recorder Check

To perform the recorder check, follow this procedure:

1. Access the Monitor mode. For more information, see *9.1 Starting Monitoring a Patient*.
2. Print out ECG waveforms. Check that the recorder works properly and the printout is legible and correct.
3. Simulate errors by removing the recorder paper or releasing the recorder latch. Check that messages are correctly displayed. The recorder can properly work after the faults are cleared.

### 25.5.2 ECG Cable Test

Test tool: ECG simulator

To perform the ECG cable test, follow this procedure:

1. Enter the 12-Lead ECG window. For more information, see *12.3 Entering the 12-Lead ECG Window*.
2. Connect the ECG cable to the equipment, and connect the electrodes to the simulator.
3. Turn on the simulator and select a normal ECG rhythm.
4. Wait for a few seconds. Check that the waveform is properly displayed and no lead-off alarms are displayed in the alarm information area.
5. Print out realtime 12-lead ECG waveforms. Check that the waveform for each lead is properly displayed on the printout.

### 25.5.3 Manual Defibrillation Test

Test tool: defibrillator/pacer analyzer

#### Charge/Discharge

To perform the charge/discharge test, follow this procedure:

1. Remove the batteries from the equipment, and connect it with the external power supply.
2. Access the Configuration mode. For more information, see *22.2 Accessing the Configuration Mode*.
3. Select **Record Setup** and switch on **Shock Event**.
4. After the equipment restarts, access the Manual Defib mode. For more information, see *6.3 Accessing the Manual Defib Mode*.
5. Connect the therapy cable to the therapy port of the equipment, and place the electrode pads or external paddles on the defibrillator/pacer analyzer.

6. Set the analyzer to Energy Measurement mode, and check that the energy value is 0 or blank.
7. Set the energy level to 1J on the equipment.
8. Charge or discharge the equipment, and check that the energies measured by the analyzer meet the following accuracy:

Selected Energy (J)	Measured Value (J)
1	0 to 3
100	90 to 110
360	324 to 396

9. Set the energy to 100J and 360J respectively, and repeat step 8.
10. Disconnect the equipment from the external power supply, and connect it with a fully charged battery.
11. Access the Manual Defib mode again.
12. Repeat steps 3 to 9, and check that the equipment automatically and correctly records the shock events.

### Energy Disarming

To perform the energy disarming test, follow this procedure:

1. Disconnect the equipment from the external power supply, and connect it with a fully charged battery.
2. Access the Manual Defib mode. For more information, see *6.3 Accessing the Manual Defib Mode*.
3. Connect the therapy cable to the therapy port of the equipment, and place the electrode pads or external paddles on the defibrillator/pacer analyzer.
4. Set the analyzer to Energy Measurement mode, and check that the energy value is 0 or blank.
5. Set the energy level to 360J on the equipment.
6. Charge the equipment, and check that the charging tone is issued during charging.
7. After charging is completed, select **Disarm** to discharge the energy internally.
8. Check that a prompt "**Charge Removed**" is displayed and the charging done tone stops. In this case, the value measured by the analyzer is 0J or blank.
9. Access the Configuration mode. For more information, see *22.2 Accessing the Configuration Mode*.
10. Select **Manual Defib Setup** and set **Time to Auto Disarm** to **60s**.
11. After the equipment restarts, set the analyzer to Energy Measurement mode, and check that the energy value is 0 or blank.
12. Set the energy level to 360J on the equipment.
13. Charge the equipment. After charging is completed, wait 60 seconds to check that the prompt "**Charge Removed**" is displayed and the energy measured by the analyzer is 0J or blank.

### Synchronized Cardioversion

To perform the synchronized cardioversion test, follow this procedure:

1. Connect the therapy cable to the therapy port of the equipment, and place the electrode pads or external paddles on the defibrillator/pacer analyzer.
2. Connect the ECG cable to the ECG connector of the equipment, and place the ECG electrodes on the defibrillator/pacer analyzer.
3. Set the analyzer to Time Measurement Mode and output normal sinus rhythms. For example, set amplitude to 1mV and HR to 60 bpm.
4. Access the Configuration mode. For more information, see *6.3 Accessing the Manual Defib Mode*.
5. Select **Manual Defib Setup** and set **Sync After Shock** to **On**.
6. After the equipment restarts, set the energy level to 10J.
7. Enable the synchronized cardioversion function on the equipment. For more information, see *6.7.1 Enabling Synchronized Cardioversion*.
8. Set ECG lead to **Pads** or **Paddles**, and charge the equipment.

9. After charging is completed, press and hold the Shock button to deliver a shock. Check that the following requirements are followed:
  - ◆ The equipment delivers a synchronized shock and the delivered energy measured by the analyzer is  $10\text{J}\pm 2\text{J}$ .
  - ◆ The delay time of synchronized cardioversion measured by the analyzer is less than 60ms.
  - ◆ The synchronized discharge marker appears above the R wave.
  - ◆ The prompts are correctly displayed during the test.
10. Set ECG lead to II, and charge the equipment. Repeat step 9.

## 25.5.4 Pacing Test

Test tool: defibrillator/pacer analyzer

To perform the pacing test, follow this procedure:

1. Disconnect the equipment from the external power supply, and connect it with a fully charged battery.
2. Access the Pacer mode. For more information, see *8.3 Accessing the Pacer Mode*.
3. Select **Fixed Mode**.
4. Connect the therapy cable to the therapy port of the equipment, and place the electrode pads on the defibrillator/pacer analyzer.
5. Set the analyzer to Pacing Measurement mode. Use test load of  $50\Omega$ .
6. Set **Pacer Rate** to **70 ppm** and **Pacer Output** to **30 mA** on the equipment.
7. Select **Start Pacing**. Check that the pacer rate measured by the analyzer is  $70\text{ ppm}\pm 1\text{ ppm}$  and the pacer output measured is  $30\text{ mA}\pm 5\text{ mA}$ .
8. Select **Stop Pacing**.
9. Set **Pacer Rate** to **170 ppm** and **Pacer Output** to **200 mA** on the equipment.
10. Select **Start Pacing**. Check that the pacer rate measured by the analyzer is  $170\text{ ppm}\pm 2\text{ ppm}$ , and the pacer output measured is  $200\text{ mA}\pm 10\text{ mA}$ .

## 25.6 Preventive Maintenance

The preventive maintenance should be performed every year by Mindray-qualified service personnel only.

### 25.6.1 User Maintenance Settings

The configuration management enables you to customize your equipment to best meet your needs.

To access the User Maintenance mode, select the **Main Menu** quick key → from the **System** column select **Maintenance** → enter the maintenance password → .

---

---

#### WARNING

---

- **Accessing the User Maintenance mode is password protected. Patient therapy and monitoring automatically end when you access the User Maintenance mode.**
  - **The user maintenance settings must be changed by authorized personnel only. If needed, contact your department manager or biomedical engineering department for the passwords used at your facility.**
- 
-

Tab	Menu Item	Description
CO2 Module	Zero Recovery For 30s	Sets the display of CO <sub>2</sub> readings after the zero calibration is completed. <ul style="list-style-type: none"> <li>• <b>On:</b> no values are displayed during the reacquisition period, only “<b>Zero Recovering</b>” is displayed in the CO<sub>2</sub> numeric area.</li> <li>• <b>Off:</b> values are displayed during the reacquisition period.</li> </ul>
	Zero	Manually zeros the CO <sub>2</sub> module.
Authorization Setup	Automatic Logout Time	If no operations are taken within the configured period, the equipment automatically exits the User Maintenance mode.
	Alarm Setup	Set the password-protected method for changing alarm settings, changing arrhythmia settings and viewing the patient review data. <ul style="list-style-type: none"> <li>• <b>No Password:</b> no password is required.</li> <li>• <b>Password:</b> a password is required. “alarm” is the default password.</li> </ul>
	Arrhythmia	
	Viewing Patient Review Data	
Modify Password	Modifies the password for changing alarm settings, changing arrhythmia settings and viewing the patient review data.	
Version	/	Views the system software version, module hardware and software versions, and firmware version.
Battery Information	/	Views the information of battery installed on the equipment.
Bluetooth	Enable	Sets whether the equipment can be found by other bluetooth devices.
	Auto Unpair On Disconnection	Sets the interval of unpairing between the equipment and bluetooth device after they are connected.
Other	Clear All Patient Data	Deletes all patient information and data from the equipment.
	Modify Password	Modifies the password for accessing the User Maintenance mode.

### 25.6.2 Module Performance Tests

The module performance tests include Resp, SpO<sub>2</sub>, NIBP and CO<sub>2</sub> tests. Module performance tests should be performed by Mindray-qualified service personnel only. For more information, see the relevant service manual.

### 25.6.3 Electrical Safety Tests

Electrical safety tests should be performed by Mindray-qualified service personnel only. For more information, see *G Electrical Safety Inspection*.

# A Specifications

---

## A.1 Safety Specifications

### A.1.1 Safety Classifications

The equipment is classified, according to IEC 60601-1:

Type of protection against electrical shock	Class I
Degree of protection against electrical shock	Type BF defibrillation proof for CO <sub>2</sub> monitoring and external defibrillation. Type CF defibrillation proof for ECG, SpO <sub>2</sub> , NIBP and internal defibrillation.
Degree of protection against harmful ingress of solid Degree of protection against harmful ingress of water	IP55
Degree of safety of application in the presence of flammable anesthetic mixture with air or with oxygen or nitrous oxide	The equipment is not suitable for use in the presence of a flammable anesthetic mixture with air or with oxygen or nitrous oxide
Mode of operation	Continuous
Degree of mobility	Portable

### A.1.2 Environmental Specifications

---

#### WARNING

---

- **When the temperature changes from the lowest storage temperature to the room temperature (non-condensing), it is recommended to use the equipment at least one hour later for proper operation.**
  - **The equipment may not meet the performance specifications if stored or used outside the specified temperature and humidity ranges. If the performance of the equipment is degraded due to aging or environmental conditions, contact your service personnel.**
  - **When the equipment and related products have differing environmental specifications, the effective range for the combined products is that range which is common to the specifications for all products.**
- 

#### NOTE

---

- **The environmental specification of unspecified modules are the same as those of the main unit.**
-

Main unit				
Item		Temperature	Relative humidity	Barometric
Operating condition	When configured with ECG and manual defibrillation, without batteries	-20°C to 55°C	5% to 95%, non-condensing	-382m to 4575m (57.0 kPa to 106.2kPa)
	When configured with all functions	0°C to 50°C		
Storage condition		-40°C to 75°C		
Shock				
Complies with requirements for medical devices of 6.3.4.2, EN1789 (10.1.3, IEC60601-1-12): Peak acceleration: 1000m/s <sup>2</sup> (102g) Duration: 6ms Pulse shape: half-sine Number of shocks: 3 shocks per direction per axis (18 shocks in total)				
Bump				
Complies with the requirements for road ambulances of 6.3.4.2, EN1789. Peak acceleration: 15g Pulse duration: 6ms Number of bumps: 1000 Direction: vertical, with the equipment in its normal operating position.				
Vibration				
Complies with requirements for medical devices of 6.3.4.2, EN1789 (10.1.3, IEC60601-1-12). 10 Hz to 100 Hz: 5.0 (m/s <sup>2</sup> )/Hz 100 Hz to 200 Hz: -7 dB/Octave 200 Hz to 2 000 Hz: 1.0 (m/s <sup>2</sup> )/Hz Duration: 30 minutes per direction per vertical axis (3 axes in total)				
Free fall				
1 fall on each surface (6 surfaces in total), at the height of 0.75 m				

## A.2 Power Supply Specifications

### A.2.1 External Power Supply Specifications

AC power input	
Input voltage	100 to 240 VAC (-15%, +10%)
Input current	1.8 to 0.8A
Frequency	50/60Hz (±3Hz)
DC power input (with DC/AC inverter)	
Input voltage	12 VDC (-15%, +25%)
Output voltage	230 VAC, 50Hz
Output power	150W

### A.2.2 Battery Specifications

Battery type	Rechargeable lithium-ion battery
Battery voltage	14.4V

Battery capacity	4500 mAh		
Maximum number of batteries configured	Only one battery can be connected.		
Battery charge time	Charged by the equipment connected to the external power supply	<ul style="list-style-type: none"> <li>• Less than 3 hours to 90% and less than 4 hours to 100% with equipment turned off.</li> <li>• Less than 5 hours to 90% and less than 6 hours to 100% with equipment turned on.</li> </ul>	
	Charged by the charger station	Less than 3 hours to 90% and less than 4 hours to 100%.	
Battery run time	Operating mode	One battery	Testing condition
	Monitor	≥6.5 h	<ul style="list-style-type: none"> <li>• New fully charged battery.</li> <li>• Ambient temperature of 20°C±5 °C.</li> <li>• The equipment is configured with 3-/5-lead ECG, manual defibrillation, screen brightness set to the lowest level without printing.</li> </ul>
		≥5.5 h	<ul style="list-style-type: none"> <li>• New fully charged battery.</li> <li>• Ambient temperature of 20°C±5 °C.</li> <li>• The equipment is configured with 3-/5-lead ECG, Resp, SpO2, NIBP measurements set at an interval of 15 minutes, manual defibrillation, screen brightness set to the factory default without printing.</li> </ul>
	Defibrillation	≥220 discharges of 360J	<ul style="list-style-type: none"> <li>• New fully charged battery.</li> <li>• Ambient temperature of 20°C±5 °C.</li> <li>• The equipment is configured with 3-/5-lead ECG, manual defibrillation, screen brightness set to the factory default without printing.</li> <li>• 3 discharges every minute.</li> </ul>
		≥300 discharges of 200J	
	Pacing	≥4.5 h	<ul style="list-style-type: none"> <li>• New fully charged battery.</li> <li>• Ambient temperature of 20°C±5 °C.</li> <li>• The equipment is configured with 3-/5-lead ECG, manual defibrillation, external pacing, screen brightness set to the factory default without printing.</li> <li>• 50 Ω load impedance, pacer rate at 80bpm, pacer output at 60mA, pacer pulse at 40ms.</li> </ul>
Low alarm presented	At least 20 minutes of monitoring and 6 discharges of 360J	<ul style="list-style-type: none"> <li>• Ambient temperature of 20°C±5 °C.</li> <li>• The equipment is configured with 3-/5-lead ECG, manual defibrillation, screen brightness set to the factory default without printing.</li> </ul>	
Battery fuel gauge	5 LEDs indicating the current battery charge level		

### A.2.3 Charger Station Specifications

Maximum number of batteries charged	Two batteries can be charged at the same time.
<b>AC power input</b>	
Input voltage	100 to 240 VAC (±10%)
Input current	1.8 to 0.8A
Frequency	50/60Hz (±3Hz)
<b>DC power input</b>	
Input voltage	12.4 to 30.3 VDC
Input current	15.5 to 6.5A

## A.3 Physical Specifications

Dimensions (W × D × H)	285 mm×170 mm×265 mm (including the handle, excluding external paddles)
Weight	4.2±0.3 kg (the equipment is configured with 3-/5-lead ECG, manual defibrillation and one battery)

## A.4 Hardware Specifications

### A.4.1 Display Screen

Screen type	Capacitive, multi-point color touchscreen
Screen size	8 inch
Resolution	1024×768 pixels
Viewed waveforms	5 at maximum
Wave viewing time	36s at maximum (ECG)

### A.4.2 Recorder

Method	High-resolution thermal dot array
Paper width	50 mm
Paper speed	6.25 mm/s, 12.5 mm/s, 25 mm/s, 50 mm/s. Error no more than ± 5%
Number of waveforms	3 at maximum
Grid lines	Printing can be configured with or without grid lines

### A.4.3 LEDs

Alarm lamp	1 (two color-coded: red and yellow)
Power-on LED	1 (green)
Battery LED	1 (two color-coded: yellow and green)
Status indicator	1 (two color-coded: red and green)

### A.4.4 Audio Indicators

Speaker	Gives alarm tones (45 to 85 dB), key tones, QRS tones Supports PITCH TONE and multi-level tone modulation Alarm tones comply with IEC60601-1-8.
Beep	Gives reminder tones
Audio signal	Alarm tone: ISO mode with frequency of 600 Hz QRS tone: short beep with frequency of 495 Hz Charge tone: long beep with frequency of 400 Hz to 533 Hz Charge done tone: double beeps with frequency of 440 Hz Key tone: short beep with frequency of 1000 Hz

### A.4.5 External Connectors

Power input	1, AC power input with equipotential grounding terminal, connects the external power supply.
-------------	--



Multifunctional connector	1, connects a CPR sensor, or a cable for analog output or synchronized cardioversion.
USB connector	1 USB 2.0, connects the USB drive.
Network connector	1 RJ45 connector, 100 Base-TX, IEEE 802.3, connects a standard network cable.

#### A.4.6 Signal Outputs

Multifunctional connector	
Standard	Meets the requirements of EN60601-1 for short-circuit protection and leakage current
ECG Analog Output (only from ECG accessories)	
Bandwidth (-3 dB; reference frequency: 10 Hz)	Diagnostic mode: 0.05 to 150 Hz Monitor mode: 0.5 to 40 Hz Therapy mode: 1 to 20 Hz ST mode: 0.05 to 40 Hz
Maximum QRS delay	25 ms (in diagnostic mode, and with Notch off)
Sensitivity	1 V/mV $\pm$ 5%
Pace enhancement	Signal amplitude: $V_{oh} \geq 2.5V$ Pulse width: 10ms $\pm$ 5% Signal rising and falling time: $\leq 100\mu s$
Synchronous input	
Input limit	$V_{ih} \geq 2.4v$ ; $V_{il} \leq 0.4v$
Input signal range	0 to 5V (TTL level)
Input impedance	$\geq 10 k\Omega$
Pulse width	$> 5 ms$
Alarm output	
Alarm delay time from the equipment to other remote equipment	<ul style="list-style-type: none"> <li>For pre-hospital network: the alarm delay time measured at the equipment signal output connector: <math>\leq 10 s</math></li> <li>For hospital network: the alarm delay time measured at the equipment signal output connector: <math>\leq 2s</math></li> </ul>
Alarm signal sound pressure level range	45 db(A) to 85 db(A) within a range of one meter

#### A.5 Data Storage

Internal storage	4 GB
Events	At least 1000 events for each patient.
Waveforms	At least 120 hours for one ECG waveform and pace pulses with the resolution no less than 1 second, or 60 hours for two ECG waveforms and pace pulses
Voice recording	At least 8 hours for each patient
Tabular trends	At least 200 hours trend data with the resolution no less than 1 minute.
Auto test reports	At least 1000 records
Data export	Data can be export to a PC through a USB drive

## A.6 Communication Specifications

### A.6.1 Wi-Fi Specifications (Wlink as Station)

Protocol	IEEE 802.11a/b/g/n
Modulation mode	BPSK, QPSK, 16QAM, 64QAM
Operating frequency	2412 MHz to 2472 MHz 5180 MHz to 5320 MHz, 5500 MHz to 5700 MHz, 5745 MHz to 5825 MHz
Wireless baud rate	IEEE 802.11a: 6 Mbps to 54 Mbps IEEE 802.11b: 1 Mbps to 11 Mbps IEEE 802.11g: 6 Mbps to 54 Mbps IEEE 802.11n: MCS0 to MCS7
Output power	<20 dBm (CE requirement: detection mode- RMS)
Operating mode	As station, access AP for data transmission
Data security	Standards: WPA-PSK, WPA2-PSK, WPA-Enterprise, WPA2-Enterprise EAP method: EAP-TLS, EAP-TTLS, PEAP-MSCHAPv2 Encryption: TKIP, AES
Distinct vision distance	The distinct vision distance between the equipment and the AP: $\geq 50$ m.
Alarm delay time of network disconnection	The message and alarm delay of network disconnection between the equipment and the CMS: $\leq 14$ s.
<b>Pre-hospital network performance</b>	
System capacity, interference immunity and network stability	Meets the following requirements: <ul style="list-style-type: none"> <li>The total delay of data transmission from the equipment to the CMS: <math>\leq 10</math> s.</li> <li>The delay for the equipment related settings configured at the CMS to be effective: <math>\leq 10</math> s.</li> <li>The data loss percentage of Wi-Fi communication over a 4-hour period: <math>\leq 0.5\%</math>.</li> </ul>
Test conditions	Meets the following conditions simultaneously: <ul style="list-style-type: none"> <li>One equipment supported by a single AP</li> <li>Each equipment can communicate with the CMS.</li> <li>The weakest strength of the AP signal where the equipment is located is not less than -65 dBm.</li> <li>The distance between the interfering devices and the equipment is greater than 20 cm. A Wi-Fi interference (no greater than -85 dBm) in the same channel and a Wi-Fi interference (no greater than -50 dBm) in an adjacent-channel are presented synchronously. The interfering devices include, but are not limited to, 2.4 G wireless devices, cellular mobile networks, interphones, cordless phones, and ESU equipment. The interfering devices do not include Wi-Fi devices.</li> </ul>
<b>Hospital network performance</b>	
System capacity, interference immunity and network stability	Meets the following requirements: <ul style="list-style-type: none"> <li>The total delay of data transmission from the equipment to the CMS <math>\leq 2</math>s.</li> <li>The delay for the equipment related settings configured at the CMS to be effective: <math>\leq 2</math> s.</li> <li>The equipment connected to the network roam for 30 times, the data loss percentage of Wi-Fi communication over a 24-hour period: <math>\leq 0.1\%</math>.</li> </ul>

Test conditions	<p>Meets the following conditions simultaneously:</p> <ul style="list-style-type: none"> <li>• Number of the equipments supported by a single AP: <math>\leq 3</math></li> <li>• Each equipment can communicate with the CMS.</li> <li>• The weakest strength of the AP signal where the equipment is located is not less than -65 dBm.</li> <li>• The distance between the interfering devices and the equipment is greater than 20 cm. A Wi-Fi interference (no greater than -85 dBm) in the same channel and a Wi-Fi interference (no greater than -50 dBm) in an adjacent-channel are presented synchronously. The interfering devices include, but are not limited to, 2.4 G wireless devices, cellular mobile networks, microwave ovens, interphones, cordless phones, and ESU equipment. The interfering devices do not include Wi-Fi devices.</li> </ul>
-----------------	--

---

## WARNING

---

- **Do perform all network functions of data communication within an enclosed network.**
- 

### A.6.2 Cellular Specifications

Network type	4G, 5G
Operating frequency	<ul style="list-style-type: none"> <li>■ 4G module (EU): <ul style="list-style-type: none"> <li>◆ LTE FDD: B1/B3/B7/B8/B20/B28A</li> <li>◆ LTE TDD: B38/B40/B41</li> <li>◆ WCDMA: B1/B8</li> <li>◆ GSM: B3/B8</li> </ul> </li> <li>■ 5G module: <ul style="list-style-type: none"> <li>◆ NR: n1/n2/n3/n5/n7/n8/n12/n20/n28/n38/n40/n41/n48/n66/n71/n77/n78/n79</li> <li>◆ LTE-FDD: B1/B2/B3/B4/B5/B7/B8/B9/B12/B13/B14/B17/B18/B19/B20/B25/B26/B28/B29/B30/B32/B66/B71</li> <li>◆ LTE-TDD: B34/B38/39/B40/B41/B42/B48</li> </ul> </li> </ul>
Standard/Modulation mode	LTE, 5G Sub-6GHz
Alarm delay time of network disconnection	The message and alarm delay of network disconnection between the equipment and CMS: $\leq 14$ s.
<b>Pre-hospital network performance</b>	
System capacity, interference immunity and network stability	<p>Meets the following requirements:</p> <ul style="list-style-type: none"> <li>• The total delay of data transmission from the equipment to the CMS: <math>\leq 10</math> s.</li> <li>• The data loss percentage of cellular communication over a 4-hour period: <math>\leq 0.5\%</math>.</li> </ul>
Test conditions	<p>Meets the following conditions simultaneously:</p> <ul style="list-style-type: none"> <li>• With a distance greater than 2m from each other, three equipments operate properly at the same time.</li> <li>• Each equipment can communicate with the CMS.</li> <li>• The weakest signal strength where the equipment is located is greater than -95 dBm.</li> <li>• The distance between the interfering devices and the equipment is greater than 20 cm. The interfering devices include, but are not limited to, 2.4 G wireless devices, cellular mobile networks, interphones, cordless phones.</li> </ul>

### A.6.3 Bluetooth Specifications

Protocol	Bluetooth low energy 5.0
Modulation mode	GFSK
Operating frequency	2402 MHz to 2480 MHz
Channel spacing	2 MHz
Wireless baud rate	2 Mbps, 1 Mbps, 125kbps
Output power	≤20 dBm
Data security	AES128

### A.6.4 NFC Specifications

Protocol	ISO/IEC 14443 A, ISO/IEC 14443 B
Operating frequency	13.56 MHz

## A.7 Therapy Specifications

### A.7.1 Defibrillation Specifications

Standards	Meet standards of IEC 60601-2-4
Defibrillation mode	Manual defib, synchronized cardioversion, AED
Defibrillation waveform	Biphasic truncated exponential (BTE) waveform, auto-compensation according to patient impedance
Defibrillation electrodes	External paddles set coming with pediatric paddles included, multifunction electrode pads and internal paddles
Controls and indicators on external paddles	Charge button, Shock buttons, Energy Selection buttons, charge done indicator and patient contact indicator
Controls and indicators on internal paddles	Shock button
Shockable rhythm analysis time	< 5 s
<b>Range of selected energy</b>	
External defibrillation	1, 2, 3, 4, 5, 6, 7, 8, 9, 10, 15, 20, 25, 30, 50, 70, 100, 120, 150, 170, 200, 300, 360 J
Internal defibrillation	1, 2, 3, 4, 5, 6, 7, 8, 9, 10, 15, 20, 25, 30, 50 J
<b>Patient impedance range</b>	
External defibrillation	25 to 300 Ω
Internal defibrillation	15 to 300 Ω
<b>Synchronized discharge delay</b>	
Local synchronized discharge delay	< 60ms (from the peak of R-wave)
Remote synchronized discharge delay	< 25ms (from the rise edge of synchronous signal)
<b>AED</b>	
Shock series	Energy level: 100 to 360J, configurable for adult; 10 to 200J, configurable for pediatric Shocks: 1, 2, 3, configurable; Meeting 2020 AHA/2021 ERC guidelines by default
AED ECG analysis performance	Refer to <i>C Mindray Shockable Rhythm Analysis Algorithm</i> .

**360 J defibrillation waveform into impedance of 25Ω, 50Ω, 75Ω, 100Ω, 125Ω, 150Ω, 175Ω**

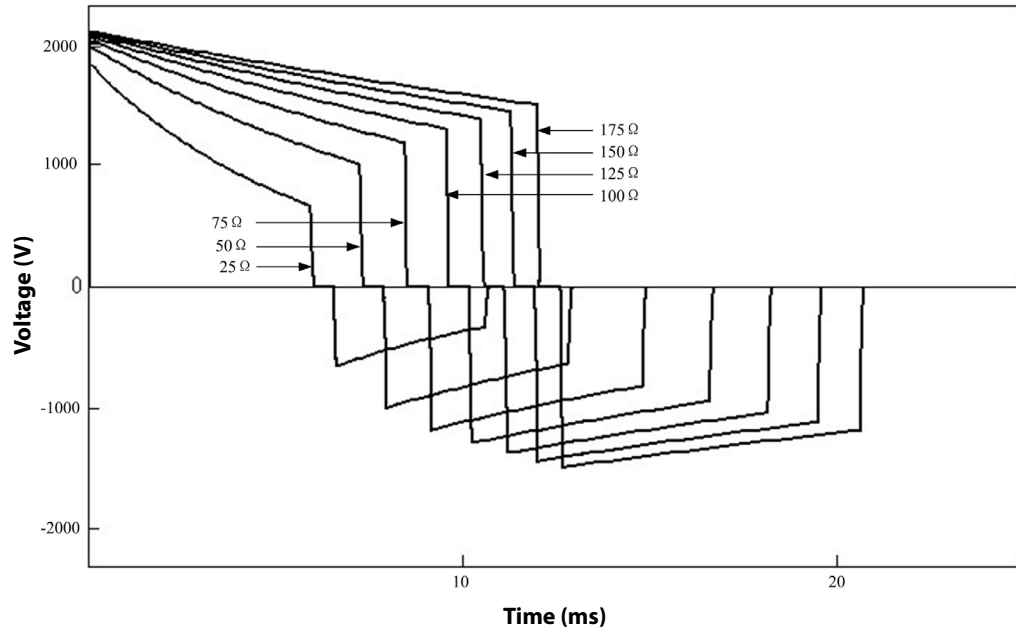

Selected energy	Impedance							Accuracy
	25Ω	50Ω	75Ω	100Ω	125Ω	150Ω	175Ω	
1 J	1	1	1	0.9	0.9	0.9	0.8	±10% or ±2J, whichever is greater
2 J	2	2	2	1.9	1.8	1.7	1.6	
3 J	2.9	3	2.9	2.8	2.7	2.6	2.4	
4 J	3.9	4	3.9	3.7	3.6	3.4	3.2	
5 J	4.9	5	4.9	4.7	4.5	4.3	4.1	
6 J	5.8	6	5.8	5.6	5.3	5.1	4.9	
7 J	6.8	7	6.8	6.6	6.3	6	5.7	
8 J	7.8	8	7.8	7.4	7.1	6.8	6.5	
9 J	8.8	9	8.8	8.4	8	7.7	7.3	
10 J	9.7	10	9.7	9.3	8.9	8.5	8.1	
15 J	15	15	15	14	13	13	12	
20 J	20	20	20	19	18	17	16	
25 J	24	25	24	23	22	21	20	
30 J	29	30	29	28	27	25	24	
50 J	49	50	49	47	45	43	41	
70 J	68	70	68	65	62	60	57	
100 J	97	100	97	93	89	85	81	
120 J	116	120	116	111	106	101	97	
150 J	146	150	146	140	134	128	122	
170 J	166	170	166	159	151	145	138	
200 J	195	200	195	187	178	170	163	
300 J	292	300	292	280	267	255	244	
360 J	351	360	350	336	321	306	293	

Power supply	Manual Defib						AED					
	Charge time*		From initial power on (from cold start) to charge done		From initial power on (from fast startup mode) to charge done		From initiation of rhythm analysis to charge done		From initial power on (from cold start) to charge done		From initial power on (from fast startup mode) to charge done	
	200J	360J	200J	360J	200J	360J	200J	360J	200J	360J	200J	360J
With a new fully charged battery	<3 s	<7 s	<11 s	<14 s	<6 s	<10 s	<10 s	<12 s	<21 s	<26 s	<13 s	<15 s
With a new fully charged battery, depleted by 15 discharges of 360 J	<4 s	<8 s	<12 s	<15 s	<7 s	<11 s	<11 s	<13 s	<23 s	<27 s	<14 s	<16 s
With an external power supply	<4 s	<7 s	<11 s	<14 s	<7 s	<10 s	<11 s	<12 s	<22 s	<24 s	<14 s	<15 s

\* The battery is charged at ambient temperature of 20 ±5 °C.

## NOTE

- The equipment startup time in the fast startup mode is less than 2s.

## A.7.2 CPR Compression Specifications

### Compressions from CPR Sensor

Compression rate	Measurement range: 40 to 160 cpm Accuracy: ±2 cpm
------------------	--

### Compressions from Electrode Pads

Compression rate	Measurement range: 60 to 200 cpm Accuracy: ±3 cpm
------------------	--

## A.7.3 Pacer Specifications

Standards	Meet standards of IEC 60601-2-4
Pacer mode	Demand, fixed
Output waveform	Monophasic square wave pulse pulse width 20 ms or 40 ms Accuracy: ±5%
Pacing rate	30ppm to 210ppm Accuracy: ±1.5% Resolution: 5 ppm
Pacing output	0mA to 200mA, Accuracy: ±5% or ±5mA, whichever is greater Resolution: 1mA, 2mA or 5mA
Refractory period	200 to 300 ms (depending on pacing rate)
4:1 pacing	Pacing pulse frequency reduced by factor of 4 when this function is activated.

## NOTE

- When pacing rate is changed from 30ppm to 210ppm, the response time to pacing (HR rising from 30bpm to 210bpm) is less than 20s.

## A.8 Monitor Specifications

### A.8.1 ECG Specifications (from ECG Accessories)

Standards	Meet standards of IEC 60601-2-27 and IEC 60601-2-25
Patient connection	3-lead ECG cable, 5-lead ECG cable or 12-lead ECG cable
ECG inputs	3-lead ECG: I, II, III 5-lead ECG: I, II, III, aVR, aVL, aVF, V 12-lead ECG: I, II, III, aVR, aVL, aVF, V1 to V6
ECG standard	AHA, IEC
Display sensitivity	1.25 mm/mV (×0.125), 2.5 mm/mV (×0.25), 5 mm/mV (×0.5), 10 mm/mV (×1), 20 mm/mV (×2), 40mm/mV (×4), Auto, less than ± 5% error
Sweep speed	6.25mm/s, 12.5 mm/s, 25 mm/s, 50 mm/s, less than ± 5% error
Bandwidth (-3dB)	Diagnostic mode: 0.05 to 150 Hz Monitor mode: 0.5 to 40 Hz Therapy mode: 1 to 20 Hz ST mode: 0.05 to 40 Hz High Freq Cut-off (for 12-lead ECG analysis): 350 Hz, 150Hz, 35Hz, 20Hz, selectable
Common mode rejection	Monitor, Therapy and ST modes: >105 dB (with notch filter on), >90 dB (with notch filter off) Diagnostic mode: >90 dB (with notch filter off) High Freq Cut-off (for 12-lead ECG analysis): >90 dB (with notch filter off)
Notch filter	50/60Hz, Monitor, Therapy and ST modes: notch filter turns on automatically. Diagnostic mode and High Freq Cut-off: notch filter is turned on manually. Rejection on power frequency interference: ≥20 dB
Differential input impedance	≥5 MΩ
ECG signal range	±8mV (peak-to-peak value)
Calibration signal	1mV (peak-to-peak value) ±5%
Electrode offset potential tolerance	±500mV
Lead-off detection current	Measuring electrode: ≤0.1 μA Drive electrode: ≤1 μA
Baseline recovery time	<2.5 s (after defibrillation)
Defibrillation protection	Enduring 5000V (360 J) charge without data loss or corruption Baseline recovery time: <2.5 s (after defibrillation) Polarization recovery time: <10 s Defibrillation energy absorption: ≤10% (100Ω load)
ESU protection	Cut mode: 300 W Coagulate mode: 100 W Recovery time: ≤10 s Noise rejection: 2mV In compliance with the requirements in clause 202.6.2.101 of IEC 60601-2-27
<b>Pace Pulse</b>	

Pace pulse markers	<p>Pace pulses meeting the following conditions are labelled with a PACE marker:</p> <p>Amplitude: <math>\pm 2</math> to <math>\pm 700</math> mV  Width: 0.1 to 2 ms  Rise time: 10 to 100 <math>\mu</math>s (no greater than 10% of pulse width)  No overshoot</p>
Pace pulse rejection	<p>When tested in accordance with the IEC 60601-2-27: 201.12.1.101.13, the heart rate meter rejects all pulses meeting the following conditions.</p> <p>Amplitude: <math>\pm 2</math> to <math>\pm 700</math> mV  Width: 0.1 to 2 ms  Rise time: 10 to 100 <math>\mu</math>s  Input slew rate: 2.2 V/s <math>\pm</math> 15% RTI  No overshoot</p>
<b>HR</b>	
Measurement range	<p>Adult: 15 to 300 bpm  Pediatric, neonate: 15 to 350 bpm</p>
Accuracy	$\pm 1\%$ or $\pm 1$ bpm, which ever is greater
Resolution	1 bpm
Heart rate averaging	<p>In compliance with the requirements in Clause 201.7.9.2.9.101 b) 3) of IEC 60601-2-27, the following method is used:</p> <p>If the last 3 consecutive RR intervals are greater than 1200 ms, the 4 most recent RR intervals are averaged to compute the HR. Otherwise, heart rate is computed by subtracting the maximum and minimum ones from the most recent 12 RR intervals and then averaging them.</p> <p>The HR value displayed on the screen is updated every second.</p>
Response time to heart rate change	<p>Meets the requirements of IEC 60601-2-27: Clause 201.7.9.2.9.101 b) 5).</p> <p>From 80 to 120 bpm: less than 11 s  From 80 to 40 bpm: less than 11 s</p>
Time to alarm for tachycardia	<p>Meets the requirements in Clause 201.7.9.2.9.101 b) 6) of IEC 60601-2-27.</p> <p>Waveform</p> <p>B1h - range: &lt;11 s  B1 - range: &lt;11 s  B1d - range: &lt;11 s  B2h - range: &lt;11 s  B2 - range: &lt;11 s  B2d - range: &lt;11 s</p>
Arrhythmia analysis classifications	<p>Asystole, V-Fib/V-Tach, V-Tach, Vent Brady, Extreme Tachy, Extreme Brady, Vent Rhythm, PVCs/min, Pauses/min, Couplet, Bigeminy, Trigeminy, R on T, Run PVCs, PVC, Brady, Tachy, Missed Beat, Pacer Not Pacing, Pacer Not Capture, Multiform PVC, Nonsus V-Tach, Pause, Irr Rhythm, A-Fib (only for adults), SVT, SVCs/min</p>
Tall T-wave rejection capability	<p>When the test is performed based on Clause 201.12.1.101.17 of IEC 60601-2-27, the heart rate meter will reject all 100 ms QRS complexes with less than 1.2 mV of amplitude, and T waves with T-wave interval of 180 ms and those with Q-T interval of 350 ms.</p>
Response to irregular rhythm	<p>In compliance with the requirements in Clause 201.7.9.2.9.101 b) 4) of IEC 60601-2-27, the heart rate after 20 seconds of stabilization is displayed as follows:</p> <p>Ventricular bigeminy (3a): <math>80 \pm 1</math> bpm  Slow alternating ventricular bigeminy (3b): <math>60 \pm 1</math> bpm  Rapid alternating ventricular bigeminy (3c): <math>120 \pm 1</math> bpm  Bidirectional systoles (3d): <math>90 \pm 2</math> bpm</p>
<b>ST Segment Analysis</b>	



Measurement range	-2.0 to 2.0 mV RTI
Accuracy	-0.8 to 0.8 mV: $\pm 0.02$ mV or $\pm 10\%$ , whichever is greater. Beyond this range: Not specified.
Resolution	0.01 mV
<b>QT/QTc Analysis</b>	
Measurement range	QT: 200 to 800 ms QTc: 200 to 800 ms QT-HR: 15 to 150 bpm for adult, 15 to 180 bpm for pediatric and neonate
Accuracy	QT: $\pm 30$ ms
Resolution	QT: 4 ms QTc: 1 ms
<b>12-lead ECG Interpretation</b>	
Sampling rate	1000 samples/s (A/D) 500 samples/s (ECG algorithm)
Amplitude quantization	24 bits
Measurements	Heart rate, PR interval, QRS duration, QT/QTc interval, P/QRS/T axis and diagnosis statement

### A.8.2 ECG Specifications (from Therapy Accessories)

Patient connection	Paddles or multifunction electrode pads
ECG inputs	Paddles or Pads
Display sensitivity	1.25 mm/mV ( $\times 0.125$ ), 2.5 mm/mV ( $\times 0.25$ ), 5 mm/mV ( $\times 0.5$ ), 10 mm/mV ( $\times 1$ ), 20 mm/mV ( $\times 2$ ), 40mm/mV ( $\times 4$ ), Auto, less than $\pm 5\%$ error
Sweep speed	6.25mm/s, 12.5 mm/s, 25 mm/s, 50 mm/s, less than $\pm 5\%$ error
Bandwidth (-3dB)	Therapy mode: 1 to 20 Hz $\begin{matrix} +0.4\text{dB} \\ -3.0\text{dB} \end{matrix}$
Common mode rejection	Therapy mode: $>105$ dB (with notch filter on)
Notch filter	Therapy mode: 50/60Hz, notch filter turns on automatically.
Differential input impedance	$\geq 5$ M $\Omega$
ECG signal range	$\pm 8$ mV (peak-to-peak value)
Calibration signal	1mV (peak-to-peak value) $\pm 5\%$
Electrode offset potential tolerance	$\pm 1$ V
Lead-off detection current	$\leq 0.1$ $\mu$ A
Baseline recovery time	$< 2.5$ s (after defibrillation)
Defibrillation protection	Enduring 5000V (360 J) charge without data loss or corruption Baseline recovery time: $< 2.5$ s (after defibrillation) Polarization recovery time: $< 10$ s Defibrillation energy absorption: $\leq 10\%$ (100 $\Omega$ load)
ESU protection	Cut mode: 300 W Coagulate mode: 100 W Recovery time: $\leq 10$ s In compliance with the requirements in clause 202.6.2.101 of IEC 60601-2-27
<b>Pace Pulse</b>	

Pace pulse markers	<p>Pace pulses meeting the following conditions are labelled with a PACE marker:</p> <p>Amplitude: <math>\pm 2</math> to <math>\pm 700</math> mV  Width: 0.1 to 2 ms  Rise time: 10 to 100 <math>\mu</math>s (no greater than 10% of pulse width)  No overshoot</p>
Pace pulse rejection	<p>When tested in accordance with the IEC 60601-2-27: 201.12.1.101.13, the heart rate meter rejects all pulses meeting the following conditions.</p> <p>Amplitude: <math>\pm 2</math> to <math>\pm 700</math> mV  Width: 0.1 to 2 ms  Rise time: 10 to 100 <math>\mu</math>s  No overshoot</p>
<b>HR</b>	
Measurement range	<p>Adult: 15 to 300 bpm  Pediatric: 15 to 350 bpm</p>
Accuracy	$\pm 1\%$ or $\pm 1$ bpm, which ever is greater
Resolution	1 bpm
Sensitivity	200 $\mu$ V
Heart rate averaging	<p>In compliance with the requirements in Clause 201.7.9.2.9.101 b) 3) of IEC 60601-2-27, the following method is used:</p> <p>If the last 3 consecutive RR intervals are greater than 1200 ms, the 4 most recent RR intervals are averaged to compute the HR. Otherwise, heart rate is computed by subtracting the maximum and minimum ones from the most recent 12 RR intervals and then averaging them.</p> <p>The HR value displayed on the screen is updated every second.</p>
Response time to heart rate change	<p>Meets the requirements of IEC 60601-2-27: Clause 201.7.9.2.9.101 b) 5).</p> <p>From 80 to 120 bpm: less than 11 s  From 80 to 40 bpm: less than 11 s</p>
Arrhythmia analysis classifications	Asystole, V-Fib/V-Tach, Pacer Not Pacing, Pacer Not Capture
Tall T-wave rejection capability	When the test is performed based on Clause 201.12.1.101.17 of IEC 60601-2-27, the heart rate meter will reject all 100 ms QRS complexes with less than 1.2 mV of amplitude, and T waves with T-wave interval of 180 ms and those with Q-T interval of 350 ms.

### A.8.3 Resp Specifications

Lead	Options are lead I, II and Auto.
Respiration excitation waveform	<300 $\mu$ A RMS, 62.8 kHz ( $\pm 10\%$ )
Minimum respiration impedance threshold	0.3 $\Omega$ with $\times 5$ gain
Baseline impedance range	200 to 2500 $\Omega$ , using an ECG cable with 1 k $\Omega$ resistor
Bandwidth	0.2 to 2.5 Hz (-3 dB)
Sweep speed	3 mm/s, 6.25 mm/s, 12.5 mm/s, 25 mm/s, <u>50 mm/s</u> , less than $\pm 5\%$ error
<b>Respiration Rate</b>	
Measurement range	0 to 200 rpm
Resolution	1 rpm
Accuracy	<p>121 to 200 rpm: <math>\pm 2</math> rpm  0 to 120 rpm: <math>\pm 1</math> rpm</p>

Apnea alarm time	10 s, 15 s, 20 s, 25 s, 30 s, 35 s, 40 s
------------------	--

## A.8.4 SpO<sub>2</sub> Specifications

### Mindray SpO<sub>2</sub> Module

Standard	Meet standards of ISO 80601-2-61		
Measurement range	0 to 100%		
Resolution	1%		
Response time	< 30 s (normal perfusion, no disturbance, SpO <sub>2</sub> value sudden changes from 70% to 100%)		
Accuracy*	70% to 100%:	±2%ABS (adult, pediatric)	
	70% to 100%:	±3%ABS (neonate)	
	0 to 69%:	not specified	
Refreshing rate	≤1 s		
<p>* One percent was added to the accuracies for neonatal sensors to account for accuracy variation due to properties of fetal hemoglobin. Studies were performed to validate the accuracy of Pulse Oximeter with neonatal SpO<sub>2</sub> sensors by contrast with a CO-Oximeter. Some neonates aged from 1 day to 30 days with a gestation age of 22 weeks to full term were involved in this study. The statistical analysis of data of this study shows the accuracy (Arms) is within the stated accuracy specification. Please see the following table.</p>			
Sensor type	Totally neonates	Data	Arms
518B	97 (51 male & 46 female)	200 pairs	2.38%
520N	122 (65 male & 57 female)	200 pairs	2.88%
The Pulse Oximeter with neonatal SpO <sub>2</sub> sensors was also validated on adult subjects.			
<b>PI</b>			
Measurement range	0.05 to 20%		
Resolution	0.05% to 9.99%:	0.01%	
	10.0% to 20.0%:	0.1%	
<b>CQI</b>			
Display range	0 to 100		
Resolution	1		
<b>Compression Rate</b>			
Display range	20 to 300 cpm		
Accuracy range	40 to 160 cpm		
Accuracy	±3 cpm		
Resolution	1 cpm		

### Masimo SpO<sub>2</sub> Module

Standard	Meet standards of ISO 80601-2-61
Measurement range	1% to 100%
Resolution	1%
Response time	≤20 s (normal perfusion, no disturbance, SpO <sub>2</sub> value sudden changes from 70% to 100%)

Accuracy <sup>1</sup>	70% to 100%: $\pm 2\%$ ABS (measured without motion in adult/pediatric mode) 70% to 100%: $\pm 3\%$ ABS (measured without motion in neonate mode) 70% to 100%: $\pm 3\%$ ABS (measured with motion) 1% to 69%: not specified
Refreshing rate	$\leq 1$ s
SpO <sub>2</sub> averaging time	2-4 s, 4-6 s, 8 s, 10 s, 12 s, 14 s, 16 s
Low perfusion conditions	Pulse amplitude: $>0.02\%$ Light penetration: $>5\%$
Low perfusion SpO <sub>2</sub> accuracy <sup>2</sup>	$\pm 2\%$
PI measurement range	0.02 to 20%
<p><sup>1</sup> The Masimo pulse oximeter with sensors have been validated for no motion accuracy in human blood studies on healthy adult volunteers in induced hypoxia studies in the range of 70% to 100% SpO<sub>2</sub> against a laboratory co-oximeter and ECG monitor. This variation equals plus or minus one standard deviation. Plus or minus one standard deviation encompasses 68% of the population. One percent was added to the accuracies for neonatal sensors to account for accuracy variation due to properties of fetal hemoglobin.</p> <p>The Masimo pulse oximeter with sensors has been validated for motion accuracy in human blood studies on healthy adult volunteers in induced hypoxia studies while performing rubbing and tapping motions at 2 to 4 Hz. At an amplitude of 1 to 2 cm and non-repetitive motion between 1 to 5 Hz. At an amplitude of 2 to 3 cm in induced hypoxia studies in the range of 70% to 100% SpO<sub>2</sub> against a laboratory co-oximeter and ECG monitor. This variation equals plus or minus one standard deviation. Plus or minus one standard deviation encompasses 68% of the population.</p> <p><sup>2</sup> The Masimo pulse oximeter has been validated for low perfusion accuracy in bench top testing against a Biotek Index 2 simulator and Masimo's simulator with signal strengths of greater than 0.02% and a % transmission of greater than 5% for saturations ranging from 70 to 100%. This variation equals plus or minus one standard deviation. Plus or minus one standard deviation encompasses 68% of the population.</p>	

### Nellcor SpO<sub>2</sub> Module

Standard	Meet standards of ISO 80601-2-61
Measurement range	0 to 100%
Resolution	1%
Response time	$\leq 30$ s (normal perfusion, no disturbance, SpO <sub>2</sub> value sudden change from 70% to 100%)
Accuracy	70% to 100%: $\pm 2\%$ ABS (adult, pediatric) 70% to 100%: $\pm 3\%$ ABS (neonate) 0 to 69%: not specified
Refreshing rate	$\leq 1$ s
When the SpO <sub>2</sub> sensor is applied for neonatal patients as indicated, the specified accuracy range is increased by $\pm 1\%$ , to compensate for the theoretical effect on oximeter measurements of fetal hemoglobin in neonatal blood.	

## A.8.5 PR Specifications

### PR from Mindray SpO<sub>2</sub> Module

Measurement range	20 to 300 bpm
Resolution	1 bpm
Response time	$< 30$ s (normal perfusion, no disturbance, PR value sudden changes from 25 to 220bpm)
Accuracy	$\pm 3$ bpm
Refreshing rate	$\leq 1$ s

### PR from Masimo SpO<sub>2</sub> Module

Measurement range	25 to 240 bpm
Resolution	1 bpm
Response time	≤20 s (with normal perfusion, no disturbance, and a PR value transition from 25 to 220 bpm)
Accuracy	±3 bpm (measured without motion) ±5 bpm (measured with motion)
Refreshing rate	≤1 s

### PR from Nellcor SpO<sub>2</sub> Module

Measurement range	20 to 300 bpm
Resolution	1 bpm
Response time	≤30 s (normal perfusion, no disturbance, PR value sudden change from 25 to 250 bpm)
Accuracy	20 to 250 bpm: ±3 bpm 251 to 300 bpm: not specified
Refreshing rate	≤1 s

## A.8.6 NIBP Specifications

Standards	Meet standard of IEC 80601-2-30			
Mode of operation	Manual, Auto, STAT, Sequence			
Auto mode repetition intervals	1 min, 2 min, 2.5 min, 3 min, 5 min, 10 min, 15 min, 20 min, 30 min, 1 h, 1.5 h, 2 h, 3 h, 4 h, 8 h			
STAT mode cycle time	5 min			
Maximum measurement time	Adult, pediatric:	180s		
	Neonate:	90s		
Measurement range	Measurement Item	Adult	Pediatric	Neonate
	Systolic (mmHg)	25 to 290	25 to 240	25 to 140
	Diastolic (mmHg)	10 to 250	10 to 200	10 to 115
	Mean (mmHg)	15 to 260	15 to 215	15 to 125
Measurement accuracy*	Max mean error: ±5 mmHg Max standard deviation: 8 mmHg			
Static pressure measurement range	0mmHg to 300mmHg			
Static pressure measurement accuracy	±3mmHg			
Resolution	1 mmHg			
Software overpressure protection	Adult:	297±3 mmHg		
	Pediatric:	297±3 mmHg		
	Neonate:	147±3 mmHg		
Initial cuff inflation pressure range	Adult:	80 to 280 mmHg		
	Pediatric:	80 to 210 mmHg		
	Neonate:	60 to 140 mmHg		

\*Measurement accuracy verification: In adult and pediatric modes, the blood pressure measurements measured with this device are in compliance with the Standard for Non-invasive sphygmomanometers (ISO 81060-2) in terms of mean error and standard deviation by comparing with intra-arterial or auscultatory measurements (depending on the configuration) in a typical patient population. For auscultatory reference, the 5th Korotkoff sound was used to determine the diastolic pressure.

In neonatal mode, the blood pressure measurements measured with this device are in compliance with the American National Standard for Non-invasive sphygmomanometers (ISO 81060-2) in terms of mean error and standard deviation by comparing with intra-arterial measurements (depending on the configuration) in a typical patient population.

<b>PR</b>	
Measurement range	30 to 300 bpm
Resolution	1 bpm
Accuracy	±3bpm or ±3%, whichever is greater

## A.8.7 CO<sub>2</sub> Specifications

Standard	Meet the standard of ISO 80601-2-55	
Measurement range	0 to 150 mmHg	
Accuracy <sup>1</sup>	Full accuracy mode: 0 to 40 mmHg: ±2 mmHg 41 to 76 mmHg: ±5% of reading 77 to 99 mmHg: ±10% of reading 100 to 150 mmHg: ±(3 mmHg+8% of reading)	
Accuracy drift	Meets the requirement for measurement accuracy within 6 hours.	
Resolution	1 mmHg	
Sample flowrate tolerance	±15% or ±15 ml/min, whichever is greater.	
Start-up time	20 s (typical), 90 s (maximum)	
Sample flowrate	50 ml/min	
Rise time	≤200 ms @ 50 ml/min (measured with a CO <sub>2</sub> adapter and sampling line) ≤250 ms @ 50 ml/min (measured with a standard sampling line) ≤280 ms @ 50 ml/min (measured with a long sampling line)	
Response time	≤5.0 s @ 50 ml/min (measured with a CO <sub>2</sub> adapter and sampling line) ≤5.0 s @ 50 ml/min (measured with a standard sampling line) ≤6.5 s @ 50 ml/min (measured with a long sampling line)	
Apnea time	10 s, 15 s, 20 s, 25 s, 30 s, 35 s, 40 s	
<b>awRR</b>		
awRR measurement range	0 to 150 rpm	
awRR accuracy	≤60 rpm: ±1 rpm 61 to 150 rpm: ±2 rpm	
awRR resolution	1 rpm	
<b>Effect of interference gases on CO<sub>2</sub> measurements</b>		
Gas	Concentration	Quantitative effect <sup>2</sup>

O <sub>2</sub>	≤100%	±1 mmHg
N <sub>2</sub> O	≤60%	
Hal	≤4%	
Sev	≤5%	
Iso	≤5%	
Enf	≤5%	
Des	≤15%	±2 mmHg
<p><sup>1</sup> Inaccuracy specifications are affected by the breath rate and I: E change. The EtCO<sub>2</sub> accuracy is within specification for breath rate ≤ 60rpm and I/E ratio ≤1:1, or breath rate ≤30rpm and I/E ratio ≤ 2:1.</p> <p><sup>2</sup> means an extra error should be added in case of gas interference when CO<sub>2</sub> measurements are performed between 0-40mmHg.</p>		

**This page intentionally left blank.**



# B EMC and Radio Regulatory Compliance

## B.1 EMC

The equipment meets the requirements of IEC 60601-1-2: 2014.

### WARNING

- Use of accessories, transducers and cables other than those specified or provided by the manufacturer of this device could result in increased electromagnetic emissions or decreased electromagnetic immunity of this device and result in improper operation.
- The non-ME EQUIPMENT (e.g. ITE) that is a part of an ME SYSTEM may be disrupted by the electromagnetic interference of nearby equipment. It may be necessary to take mitigation measures, such as re-orienting or relocating the non-ME EQUIPMENT or shielding the location.
- Use of this device adjacent to or stacked with other device should be avoided because it could result in improper operation. If such use is necessary, this device and the other device should be observed to verify that they are operating normally.
- Portable RF communications equipment (including peripherals such as antenna cables and external antennas) should be used no closer than 30 cm (12 inches) to any part of the this device, including cables specified by the manufacturer. Otherwise, degradation of the performance of this device could result.
- Other devices may affect this equipment even though they meet the requirements of CISPR.
- When the inputted signal is below the minimum amplitude provided in technical specifications, erroneous measurements could result.

### NOTE

- The equipment needs special precautions regarding EMC and needs to be installed and put into service according to the EMC information provided below.
- Portable and mobile RF communications equipment may affect this equipment.
- This equipment is intended for use in professional healthcare facility environment, or in home healthcare environment such as restaurants, cafes, shops, stores, markets, schools, churches, libraries, outdoors (streets, sidewalks, parks), domiciles (residences, homes, nursing homes), train stations, bus stations, airports, hotels, hostels, pensions, museums, theatres. If it is used in special environment, such as magnetic resonance imaging environment, the equipment may be disrupted by the operation of nearby equipment.

Guidance and Declaration - Electromagnetic Emissions		
The equipment is suitable for use in the electromagnetic environment specified below. The customer or the user of the equipment should assure that it is used in such an environment.		
Emission test	Compliance	Electromagnetic environment - guidance
RF emissions CISPR 11	Group 1	The equipment uses RF energy only for its internal function. Therefore, its RF emissions are very low and are not likely to cause any interference in nearby electronic equipment.
RF emissions CISPR 11	Class B	The equipment is suitable for use in all establishments, including domestic establishments and those directly connected to the public low-voltage power supply network that supplies buildings used for domestic purposes.
Harmonic emissions IEC 60601-1-2 EN 61000-3-2	Class A	
Voltage fluctuations/flicker emissions IEC 60601-1-2 EN 61000-3-3	Complies	

If the device is operated within the electromagnetic environment listed in Table **Guidance and Declaration - Electromagnetic Immunity**, the equipment will remain safe and provide the following essential performance: HR accuracy, Resp accuracy, SpO<sub>2</sub> accuracy, PR accuracy, NIBP accuracy, CO<sub>2</sub> accuracy, Pacing rate accuracy, Pacing output accuracy, energy accuracy, CPR function, alarm, data stored, user's interface function.

<b>Guidance and Declaration - Electromagnetic Immunity</b>			
The equipment is suitable for use in the electromagnetic environment specified below. The customer or the user of the equipment should assure that it is used in such an environment.			
<b>Immunity test</b>	<b>IEC 60601 test level</b>	<b>Compliance level</b>	<b>Electromagnetic environment - guidance</b>
Electrostatic discharge (ESD) IEC 61000-4-2	±8 kV contact ±15kV air	±8 kV contact ±15kV air	Floors should be wood, concrete or ceramic tile. If floors are covered with synthetic material, the relative humidity should be at least 30%.
Electrical fast transient/burst IEC 61000-4-4	±2 kV for power supply lines ±1 kV for input/output lines (length greater than 3 m)	±2 kV for power supply lines ±1 kV for input/output lines (length greater than 3 m)	Mains power quality should be that of a typical commercial or hospital environment.
Surge IEC 61000-4-5	±1 kV line(s) to line(s) ±2 kV line(s) to earth	±1 kV line(s) to line(s) ±2 kV line(s) to earth	
Voltage dips and Voltage interruptions IEC 61000-4-11	0% U <sub>T</sub> for 0,5 cycle  0% U <sub>T</sub> for 1 cycle and 70% U <sub>T</sub> for 25/30 cycles  0% U <sub>T</sub> for 250/300 cycle	0% U <sub>T</sub> for 0,5 cycle  0% U <sub>T</sub> for 1 cycle and 70% U <sub>T</sub> for 25/30 cycles  0% U <sub>T</sub> for 250/300 cycle	Mains power quality should be that of a typical commercial or hospital environment. If the user of our product requires continued operation during power mains interruptions, it is recommended that our product be powered from an uninterruptible power supply or a battery.
RATED power frequency magnetic fields IEC 61000-4-8	30 A/m	30 A/m	Power frequency magnetic fields should be at levels characteristic of a typical location in a typical commercial or hospital environment.
U <sub>T</sub> is the A.C. mains voltage prior to application of the test level.			

**Guidance and Declaration - Electromagnetic Immunity**

The equipment is suitable for use in the electromagnetic environment specified below. The customer or the user of the equipment should assure that it is used in such an environment.

Immunity test	IEC 60601 Test level	Compliance level	Electromagnetic environment - guidance
Conducted RF IEC 61000-4-6	3 Vrms 150k to 80 MHz	3 Vrms (V1)	Portable and mobile RF communications equipment should be used no closer to any part of the device, including cables, than the recommended separation distance calculated from the equation applicable to the frequency of the transmitter. Recommended separation distance:
	6 Vrms in ISM bands and amateur radio bands <sup>a</sup> between 0.15 MHz and 80 MHz	6 Vrms (V2)	
Radiated RF EM fields IEC 61000-4-3	3V/m 80 MHz to 2.7 GHz (IEC60601-2-27, IEC60601-2-25, IEC60601-2-49, IEC60601-2-34)	3 V/m (E1)	$d = \left[ \frac{3.5}{\sqrt{E1}} \right] \sqrt{P}$ 150k to 80 MHz  $d = \left[ \frac{3.5}{E1} \right] \sqrt{P}$ 80 MHz to 800 MHz  $d = \left[ \frac{7}{E1} \right] \sqrt{P}$ 800 MHz to 2.7 GHz  where P is the maximum output power rating of the transmitter in watts (W) according to the transmitter manufacturer and d is the recommended separation distance in meters (m) <sup>b</sup> . Field strengths from fixed RF transmitters, as determined by an electromagnetic site survey <sup>c</sup> , should be less than the compliance level in each frequency range <sup>d</sup> Interference may occur in the vicinity of equipment marked with the following symbol:
	10V/m 80 MHz to 2.7 GHz (IEC60601-2-4)	10 V/m	
	20V/m 80 MHz to 2.7GHz (IEC60601-2-4, IEC80601-2-30, ISO 80601-2-55, ISO 80601-2-56, ISO 80601-2-61)	20 V/m	
Proximity fields from RF wireless communications equipment IEC61000-4-3	27 V/m 380 to 390 MHz	27 V/m	
	28 V/m 430 to 470 MHz, 800 to 960 MHz, 1700 to 1990 MHz, 2400 to 2570 MHz	28 V/m	
	9 V/m 704 to 787 MHz, 5100 to 5800 MHz	9 V/m	

Note 1: At 80 MHz and 800 MHz, the higher frequency range applies.

Note 2: These guidelines may not apply in all situations. Electromagnetic propagation is affected by absorption and reflection from structures, objects and people.

<sup>a</sup> The ISM (industrial, scientific, and medical) bands between 150 kHz and 80 MHz are 6.765 MHz to 6.795 MHz; 13.553 MHz to 13.567 MHz; 26.957 MHz to 27.283 MHz; and 40.66 MHz to 40.70 MHz. The amateur radio bands between 0,15 MHz and 80 MHz are 1,8 MHz to 2,0 MHz, 3,5 MHz to 4,0 MHz, 5,3 MHz to 5,4 MHz, 7 MHz to 7,3 MHz, 10,1 MHz to 10,15 MHz, 14 MHz to 14,2 MHz, 18,07 MHz to 18,17 MHz, 21,0 MHz to 21,4 MHz, 24,89 MHz to 24,99 MHz, 28,0 MHz to 29,7 MHz and 50,0 MHz to 54,0 MHz.

<sup>b</sup> Compliance level in the ISM frequency bands between 150 kHz to 80 MHz and in the frequency range 80 MHz to 2.7 GHz are intended to decrease the likelihood that portable/ mobile communication equipment could cause interference if it is inadvertently brought into patient areas. For this reason, an additional factor of 10/3 is used in calculating the recommended separation distance for transmitters in these frequency ranges.

<sup>c</sup> Field strengths from fixed transmitters, such as base stations for radio (cellular/cordless) telephones and land mobile radios, amateur radio, AM and FM radio broadcast and TV broadcast cannot be predicted theoretically with accuracy. To assess the electromagnetic environment due to fixed RF transmitters, an electromagnetic site survey should be considered. If the measured field strength in the location in which the device is used exceeds the applicable RF compliance level above, the device should be observed to verify normal operation. If abnormal performance is observed, additional measures may be necessary, such as reorienting or relocating the device.

<sup>d</sup> Over the frequency ranges 150 kHz to 80 MHz, field strengths should be less than 3V/m.

<b>Recommended Separation Distances between Portable and Mobile RF, Communications Equipment and This Equipment</b>			
The equipment is intended for use in an electromagnetic environment in which radiated RF disturbance are controlled. The customer or the user of the equipment can help prevent electromagnetic interference by maintaining a minimum distance between portable and mobile RF communications equipment (transmitters) and the equipment as recommended below, according to the maximum output power of the communication equipment.			
<b>Rated Maximum Output power of Transmitter Watts (W)</b>	<b>Separation Distance According to Frequency of Transmitter (m)</b>		
	150 kHz to 80 MHz $d = \left[ \frac{3.5}{V1} \right] \sqrt{P}$	80 MHz to 800 MHz $d = \left[ \frac{3.5}{E1} \right] \sqrt{P}$	800 MHz to 2.7 GHz $d = \left[ \frac{7}{E1} \right] \sqrt{P}$
0.01	0.12	0.12	0.23
0.1	0.38	0.38	0.73
1	1.20	1.20	2.30
10	3.80	3.80	7.30
100	12.00	12.00	23.00
For transmitters at a maximum output power not listed above, the recommended separation distanced in meters (m) can be determined using the equation applicable to the frequency of the transmitter, where P is the maximum output power rating of the transmitter in watts (W) according to the transmitter manufacturer. Note 1: At 80 MHz and 800 MHz, the higher frequency range applies. Note 2: These guidelines may not apply in all situations. Electromagnetic propagation is affected by absorption and reflection from structures, objects and people.			

## B.2 Radio Regulatory Compliance



The device comply with the essential requirements and other relevant provisions of Directive 2014/53/EU.

---

### WARNING

---

- **Keep a distance of at least 20 cm away from the equipment when wireless function is in use.**
-

# C

## Mindray Shockable Rhythm Analysis Algorithm

---

The equipment configured with Mindray shockable rhythm analysis algorithm acquires and analyzes the patient's ECG signals to determine whether or not to give a defibrillation shock. If a shockable rhythm is detected, the algorithm recommends a defibrillation shock. If a nonshockable rhythm is detected, the algorithm recommends no shocks, avoiding unnecessary defibrillation shock to the patient.

Mindray shockable rhythm analysis algorithm is also applicable to paced patients. The algorithm identifies and filters pacing interference, which does not affect ECG rhythm analysis.

Mindray shockable rhythm analysis algorithm has been validated by using the database for evaluation of Mindray algorithm performance.

### C.1 Rhythm Recognition and Annotation Methodology

This section describes the recording method, rhythm source, rhythm selection criteria, annotation methods and criteria the database for evaluation of Mindray shockable rhythm analysis algorithm.

#### C.1.1 Database for Evaluation of Mindray Algorithm Performance

The database for evaluation of Mindray algorithm performance includes international standard database and Mindray clinical database for evaluating the ECG data. The ECG data for evaluation is selected according to AHA recommendations<sup>a</sup> with a 10-second wave length.

Database for evaluation of Mindray shockable rhythm analysis algorithm includes:

- MIT-BIH: The Massachusetts Institute of Technology–Beth Israel Hospital Arrhythmia Database (from Holter)
- AHA: The American Heart Association Database for Evaluation of Ventricular Arrhythmia Detectors (from Holter)
- VFDB: MIT-BIH Malignant Ventricular Arrhythmia Database (from Holter)
- CU: The Creighton University Sustained Ventricular Arrhythmia Database [the third edition] (from hospital monitor)
- NST: The Noise Stress Test Database (12 ECG records of 30 minutes each plus 3 records of noise only - supplied with the MIT–BIH database)
- Mindray clinical data (from Mindray monitors, defibrillator monitors and automated external defibrillators)

#### C.1.2 Rhythm Categories

Each rhythm category for evaluating the ECG data has been confirmed by the clinical experts.

- Shockable rhythms
  - ◆ Coarse ventricular fibrillation (VF): amplitude  $\geq 0.2\text{mV}$
  - ◆ Rapid ventricular tachycardia (VT):  $\text{HR} \geq 150\text{bpm}$ ,  $\text{QRS duration} \geq 120\text{ms}$
- Nonshockable rhythms
  - ◆ Normal sinus rhythm
  - ◆ Asystole: amplitude  $< 0.1\text{mV}$
  - ◆ Atrial fibrillation/flutter, supraventricular tachycardias, sinus bradycardia, idioventricular rhythms, heart block, premature ventricular contractions, etc
- Intermediate rhythms
  - ◆ Fine ventricular fibrillation:  $0.1\text{mV} < \text{amplitude} < 0.2\text{mV}$
  - ◆ Other VT: ventricular tachycardia that does not meet criteria for VT in the shockable rhythms category

## C.2 Mindray Shockable Rhythm Analysis Algorithm Performance

Test results on the performance of the equipment configured with Mindray shockable rhythm analysis algorithm meet IEC 60601-2-4 requirements<sup>b</sup> and AHA recommendations<sup>a</sup>.

Test results on IEC 60601-2-4 requirements are shown below.

Rhythm category	Requirement	Test result
Shockable (sensitivity): Coarse VF Rapid VT	>90% >75%	Met Met
Nonshockable (specificity)	>95%	Met
Positive predictive value	Report only	>98%
False positive rate	Report only	<2%

Test results on AHA recommendations are shown below.

Rhythm category	Minimum sample size (cases)	Performance goal	Sample size tested (cases)	Test result
Shockable (sensitivity): Coarse VF Rapid VT	200 50	>90% >75%	205 80	Met Met
Nonshockable (specificity): Normal sinus rhythm Asystole Other nonshockable rhythms	300 100 100 30	>99% >95% >95%	171 180 385	Met Met Met
Intermediate: Fine VF Other VT	25 25	Report only Report only	27 42	66.67% shockable 76.19% nonshockable

<sup>a</sup>. Kerber RE, et al, "Automatic External Defibrillators for Public Access Defibrillation: Recommendations for Specifying and Reporting Arrhythmia Analysis Algorithm Performance, Incorporating New Waveforms, and Enhancing Safety: A Statement for Health Professionals from the American Heart Association Task Force on Automatic External Defibrillation", Subcommittee on AED Safety and Efficacy. *Circulation*, 1997: Vol. 95: 1677-1682.

<sup>b</sup>. Clause 201.7.9.3.103 "Essential Performance data of the Rhythm Recognition Detector" and clause 201.107 "Requirements for Rhythm Recognition Detector," International Electrotechnical Association, IEC 60601-2-4, Medical Electrical Equipment – Part 2-4: Particular Requirements for the Basic Safety and Essential Performance of Cardiac Defibrillators: 2010.

# D Alarm Messages

## D.1 Physiological Alarm Messages

### D.1.1 General Physiological Alarm Messages

Alarm Messages	Default Priority	Cause and Solution
XX* High	Med	The measured value has risen above the high alarm limit or fallen below the low alarm limit. Check the patient's condition and check if the patient category and alarm limit settings are correct.
XX* Low	Med	
*XX represents a parameter label, such as HR, NIBP, RR, SpO <sub>2</sub> , PR, and so on.		

### D.1.2 Arrhythmia Alarm Messages

If any of arrhythmia alarms in the following table occurs, check the patient's condition and the connections of electrodes, leadwires and patient cable.

Alarm Message	Default Priority	Alarm Message	Default Priority
Asystole	High	Brady	Med
V-Fib/V-Tach	High	Pacer Not Pacing	Prompt
V-Tach	High	Pacer Not Capture	Prompt
Vent Brady	High	Missed Beat	Prompt
Extreme Tachy	High	Nonsus V-Tach	Med
Extreme Brady	High	Vent Rhythm	Med
R on T	Med	Pause	Low
Run PVCs	Low	Irr Rhythm	Prompt
Couplet	Prompt	A-Fib	Prompt
Multiform PVC	Med	PVCs/min	Med
PVC	Prompt	Pauses/min	Med
Bigeminy	Med	SVT	Med
Trigeminy	Med	SVCs/min High	Prompt
Tachy	Med		

### D.1.3 ST Physiological Alarm Messages

ST Alarm Mode	Alarm Messages	Default Priority	Cause and Solution
Absolute	ST-XX* High	Med	The ST value of respective ECG lead has risen above the high alarm limit or fallen below the low alarm limit. Check the patient's condition and check if the patient category and alarm limit settings are correct.
	ST-XX* Low	Med	

ST Alarm Mode	Alarm Messages	Default Priority	Cause and Solution
Relative	ST Single	Med	ST value of any ECG leads has risen above the high alarm limit or fallen below the low alarm limit. Check the patient's condition and check if the patient category and alarm limit settings are correct.
	ST Dual	Med	ST values of two or more ECG leads have risen above the high alarm limit or fallen below the low alarm limit. Check the patient's condition and check if the patient category and alarm limit settings are correct.
*XX represents the ECG lead label.			

#### D.1.4 Resp Physiological Alarm Messages

Alarm Message	Default Priority	Cause and Solution
Apnea	Adult/Pediatric: Med Neonate: High	The respiration signal was so weak that the equipment cannot perform respiration analysis. Check the patient's condition and patient connections.
Resp Artifact	High	The patient's heartbeat has interfered with his respiration. Check the patient's condition and the Resp connections.

#### D.1.5 SpO<sub>2</sub> Physiological Alarm Messages

Alarm Message	Default Priority	Cause and Solution
SpO <sub>2</sub> Low (XX hrs XX min XX sec)*	High	The SpO <sub>2</sub> value falls below the alarm limit. Check the patient's condition and check if the alarm limit settings are correct.
SpO <sub>2</sub> Desat (XX hrs XX min XX sec)*	High	The SpO <sub>2</sub> value falls below the desaturation alarm limit. The SpO <sub>2</sub> value falls below the desaturation alarm limit. Check the patient's condition and check if the alarm limit settings are correct.
*XX hrs XX min XX sec represents the period of time that the SpO <sub>2</sub> alarm lasts.		

#### D.1.6 PR Physiological Alarm Messages

Alarm Message	Default Priority	Cause and Solution
No Pulse	High	The pulse signal was so weak that the equipment cannot perform pulse analysis. Check the patient's condition, SpO <sub>2</sub> sensor and measurement site.

#### D.1.7 NIBP Physiological Alarm Messages

Alarm Message	Default Priority	Cause and Solution
NIBP-S Extremely High/ NIBP-D Extremely High/ NIBP-M Extremely High	High	The NIBP value is higher than the NIBP Extreme alarm high limit. Check the patient's condition and check if the alarm limit settings are correct.
NIBP-S Extremely Low/ NIBP-D Extremely Low/ NIBP-M Extremely Low	High	The NIBP value is lower than the NIBP Extreme alarm low limit. Check the patient's condition and check if the alarm limit settings are correct.

### D.2 Technical Alarm Messages

This section lists technical alarms, their default priorities, indications on alarm reset, and the actions that can be taken when an alarm occurs.



Technical alarms give different alarm indications when the alarm system is reset. In the following tables, the technical alarms are classified into three categories for easy clarification:

- A: technical alarms are cleared. The equipment gives no alarm indications.
- B: technical alarms are changed to the prompt messages.
- C: except special technical alarms, other alarms are silenced and a √ appears before the alarm message.

### D.2.1 General Technical Alarm Messages

Alarm Message	Default Priority	Indication on Alarm Reset	Cause and Solution
XX* Overrange	Low	C	The measured value is not within the measurement range. Contact your service personnel.
*XX represents a parameter label, such as HR, NIBP, RR, SpO <sub>2</sub> , PR, and so on.			

### D.2.2 ECG Technical Alarm Messages

Alarm Message	Default Priority	Indication on Alarm Reset	Cause and Solution
ECG Noisy	Low/Prompt	A	The ECG signal is noisy. Check for any possible sources of signal noise around the cable and electrode, and check the patient for excessive motion.
ECG Amplitude Too Small	Low	C	The ECG amplitude does not reach the detected threshold. Check for any possible source of interference around the cable and electrode.
ECG Lead Off (XX hrs XX min XX sec) <sup>1</sup>	Low	B	The electrode has become detached from the patient or the leadwire has become disconnected from the patient cable. Check the connections of electrodes, leadwires and patient cable.
ECG XX <sup>2</sup> Lead Off	Low	B	The electrode has become detached from the patient or the leadwire has become disconnected from the patient cable. Check the connections of electrodes, leadwires and patient cable.
Pads/Paddles Off	Low	B	The electrode pads or paddles have been detached from the patient, or the therapy cable is loose. Check the connections of the electrode pads and therapy cable, or paddles and therapy cable.
ECG Signal Invalid	Low	A	Patient skin impedance is too high. Check ECG electrode application.
ECG Learning	Prompt	/	ECG learning is manually or automatically triggered.
Cannot Analyze QT	Prompt	/	No QT measurements are calculated.
<sup>1</sup> XX hrs XX min XX sec represents the period of time that the alarm "ECG Lead Off" lasts.			
<sup>2</sup> XX represents the ECG lead label, such as RL, LL, V, and so on.			

### D.2.3 Resp Technical Alarm Messages

Alarm Message	Default Priority	Indication on Alarm Reset	Cause and Solution
Resp Interference	Prompt	/	The respiration circuit is disturbed. Check for any possible sources of signal noise.

Alarm Message	Default Priority	Indication on Alarm Reset	Cause and Solution
Electrode Poor Contact	Prompt	/	Check the electrode application. Reposition or replace the electrodes if necessary.

## D.2.4 SpO<sub>2</sub> Technical Alarm Messages

Alarm Message	Default Priority	Indication on Alarm Reset	Cause and Solution
SpO <sub>2</sub> Sensor Off	Low	B	The SpO <sub>2</sub> sensor has become detached from the patient or the equipment. Check the sensor connection. If the alarm persists, replace the sensor.
SpO <sub>2</sub> No Sensor	Low	A	The SpO <sub>2</sub> extension cable is detached from the equipment, or the SpO <sub>2</sub> sensor is detached from the SpO <sub>2</sub> extension cable. Check the SpO <sub>2</sub> cable and the sensor connection. If the alarm persists, replace the sensor.
SpO <sub>2</sub> Excess Light	Low	C	Ambient light is too strong. Move the sensor to a place with lower level of ambient light or cover the sensor to minimize the ambient light.
SpO <sub>2</sub> No Pulse	Low	C	The SpO <sub>2</sub> sensor failed to obtain pulse signal. Check the patient's condition and replace the sensor application site. If the alarm persists, replace the sensor.
SpO <sub>2</sub> Sensor Incompatible	Low	C	Incompatible or an unspecified SpO <sub>2</sub> sensor is used. Use specified sensors.
SpO <sub>2</sub> Low Signal Quality	Low	C	<ol style="list-style-type: none"> <li>1. Check the sensor and sensor position.</li> <li>2. Make sure the patient is not shivering or moving.</li> <li>3. The patient's pulse may be too low to be measured.</li> </ol>
SpO <sub>2</sub> Interference	Low	C	The SpO <sub>2</sub> signal has been interfered. Check for any possible sources of signal noise and check the patient for excessive motion.
SpO <sub>2</sub> Sensor Error	Low	C	Replace the sensor and measure again.
SpO <sub>2</sub> Searching Pulse	Prompt	/	SpO <sub>2</sub> is searching for pulse.
SpO <sub>2</sub> Low Perfusion	Prompt	/	<p>The SpO<sub>2</sub> sensor is not properly placed or the patient's perfusion index is too low.</p> <ol style="list-style-type: none"> <li>1. Check the sensor and sensor position.</li> <li>2. Reposition the sensor if necessary.</li> </ol>

## D.2.5 NIBP Technical Alarm Messages

Alarm Message	Default Priority	Indication on Alarm Reset	Cause and Solution
NIBP Cuff Loose	Low	A	There is a leak in the cuff or air tubing. Use a cuff of correct type based on the patient size. Apply the cuff and connect the air tubing as instructed in the manual.
NIBP Cuff or Airway Leak	Low	A	Check the NIBP cuff and air tubing for leakages.
NIBP Airway Error	Low	A	The air tubing may be occluded. Check the air tubing for an occlusion or kinking. If the alarm persists, contact your service personnel.

Alarm Message	Default Priority	Indication on Alarm Reset	Cause and Solution
NIBP Weak Signal	Low	A	The patient's pulse is weak or the cuff is loose. Check the patient's condition and replace the cuff application site.
NIBP Overrange	Low	A	The measured NIBP value exceeds the measurement range. Check the patient's condition.
NIBP Excessive Motion	Low	A	Check the patient's condition and reduce patient motion.
NIBP Cuff Overpressure	Low	A	The NIBP airway may be occluded. Check the airway and measure again. If the alarm persists, contact your service personnel.
NIBP Timeout	Low	A	The measurement time exceeds 120 seconds in the adult or pediatric mode, or exceeds 90 seconds in the neonatal mode, and the BP value cannot be obtained. Check the patient's condition and NIBP connections, or replace the cuff and measure again.
NIBP Cuff and Patient Mismatch	Low	A	The cuff type mismatches the patient category. Verify the patient category or replace the cuff if necessary. If patient category is correct, check that the tubing is not bent and the airway is not occluded.
NIBP Airway Leak	Low	A	Airway leakage is found during the NIBP leakage test. Check the NIBP cuff and air tubing for leakages.

## D.2.6 CO<sub>2</sub> Technical Alarm Messages

Alarm Message	Default Priority	Indication on Alarm Reset	Cause and Solution
CO <sub>2</sub> Module High Temp	Low	C	Ambient temperature is too high or there is a module failure. <ol style="list-style-type: none"> <li>1. Lower the operating temperature.</li> <li>2. Restart the equipment.</li> <li>3. If the alarm persists, the CO<sub>2</sub> module may fail, contact your service personnel.</li> </ol>
CO <sub>2</sub> Module Low Temp	Low	C	Ambient temperature is too low or there is a module failure. <ol style="list-style-type: none"> <li>1. Raise the operating temperature.</li> <li>2. Restart the equipment.</li> <li>3. If the alarm persists, the CO<sub>2</sub> module may fail, contact your service personnel.</li> </ol>
CO <sub>2</sub> Zero Failed	Low	C	Restart the equipment. If the alarm persists, contact your service personnel.
CO <sub>2</sub> High Airway Pressure	Low	C	<ol style="list-style-type: none"> <li>1. Check the airway pressure settings of the ventilator or anesthesia machine.</li> <li>2. Disconnect the equipment from the ventilator or anesthesia machine.</li> <li>3. Restart the equipment.</li> <li>4. If the alarm persists, contact your service personnel.</li> </ol>

Alarm Message	Default Priority	Indication on Alarm Reset	Cause and Solution
CO2 Low Airway Pressure	Low	C	<ol style="list-style-type: none"> <li>1. Check the airway pressure settings of the ventilator or anesthesia machine.</li> <li>2. Disconnect the equipment from the ventilator or anesthesia machine.</li> <li>3. Restart the equipment.</li> <li>4. If the alarm persists, contact your service personnel.</li> </ol>
High Barometric	Low	C	<p>The ambient pressure exceeds the operating pressure range or CO<sub>2</sub> module fails.</p> <ol style="list-style-type: none"> <li>1. Make sure that the ambient pressure meets the specifications, and check for sources that affect the ambient pressure.</li> <li>2. Restart the equipment.</li> <li>3. If the alarm persists, contact your service personnel.</li> </ol>
Low Barometric	Low	C	<p>The ambient pressure exceeds the operating pressure range or CO<sub>2</sub> module fails.</p> <ol style="list-style-type: none"> <li>1. Make sure that the ambient pressure meets the specifications, and check for sources that affect the ambient pressure.</li> <li>2. Restart the equipment.</li> <li>3. If the alarm persists, contact your service personnel.</li> </ol>
CO2 Airway Occluded	Low	C	<ol style="list-style-type: none"> <li>1. Check if the sampling line is kinked or occluded.</li> <li>2. Replace the sampling line.</li> <li>3. Restart the equipment.</li> <li>4. If the alarm persists, contact your service personnel.</li> </ol>
CO2 No Filterline	Low	A	Make sure that the sampling line is connected.
CO2 Calibration Required	Low	C	Perform a calibration.
CO2 Airway Error	Low	C	<ol style="list-style-type: none"> <li>1. Check if the sampling line is kinked or occluded.</li> <li>2. Replace the sampling line.</li> <li>3. Restart the equipment.</li> <li>4. If the alarm persists, contact your service personnel.</li> </ol>
CO2 Adapter Error	Low	A	Check, clean or replace the airway adapter. Perform a zero calibration.
CO2 No Sensor	Low	A	Make sure that the CO <sub>2</sub> transducer is connected.

## D.2.7 Pacing Technical Alarm Messages

Alarm Message	Default Priority	Indication on Alarm Reset	Cause and Solution
Pads Cable Off	High	C	Check the therapy cable connection.
Pads Off	High	C	Check the electrode pads connection.
ECG Lead Off	High	C	Check the connections of the ECG electrodes and leadwires.
Pacer Stopped Abnormally	High	C	Check that electrode pads well contact with patient's skin. Make sure electrode pads are properly applied, and then start pacing again.

## D.2.8 CPR Sensor Technical Alarm Messages

Alarm Message	Default Priority	Indication on Alarm Reset	Cause and Solution
CPR Sensor Err	High	C	There is a self-test error or communication problem with the CPR sensor. Contact your service personnel.
CPR Sensor Low Battery	Med	C	The battery power of the CPR sensor is low. Charge the battery by connect the CPR sensor to the equipment.
CPR Sensor Need Service	High	C	The compressions using the CPR sensor exceed the expected numbers. Contact your service personnel.
CPR Sensor Cable Fault	Low	C	An error occurred to the CPR sensor cable. Replace the CPR sensor cable.
Change CPR Sensor Battery	Low	C	The CPR sensor battery is aging. Contact your service personnel.
CPR Sensor Bat. Charge Err	Low	C	The CPR sensor cannot be charged. Contact your service personnel.

## D.2.9 Power Supply Technical Alarm Messages

Alarm Message	Default Priority	Indication on Alarm Reset	Cause and Solution
Power Board Comm Error	High	C	Restart the equipment. If the alarm persists, contact your service personnel.
Power Board Comm Error	High	C	An error occurred to the power board, or there is a problem with the communications between the power board and the main unit. Restart the equipment.
Power Board Selftest Err	High	C	An error occurred to the system power supply. Restart the equipment.
Power Board Volt Err	Low	C	
No Battery	Low	C	Battery is not installed. Install the battery.
Battery Error	High	C	The battery fails. Replace the battery.
Battery Aged	Low	C	The battery reaches its lifetime. Replace the battery.
Battery Charging Error	Med	C	The battery fails or charging circuit fails. Replace the battery. If the problem persists, contact your service personnel.
RT Clock Need Reset	High	C	Contact your service personnel.
RT Clock Not Exist	High	C	Contact your service personnel.
The battery capacity is less than 60%	Prompt	/	To avoid a low battery, connect the equipment to the external power supply.

## D.2.10 Recorder Technical Alarm Messages

Alarm Message	Default Priority	Indication on Alarm Reset	Cause and Solution
Recorder Init Error	Low	A	An error occurred during the recorder initialization. Restart the equipment. If the alarm persists, contact your service personnel.

Alarm Message	Default Priority	Indication on Alarm Reset	Cause and Solution
Recorder Comm Error	Low	A	Restart the equipment. If the alarm persists, contact your service personnel.
Recorder Head Hot: Please Wait	Low	C	The recorder has been working for too long time. Stop the recording and resume the recording till the print head cools down.
Recorder Initializing	Prompt	/	Wait until the recorder initialization is completed.
Recorder Out Of Paper	Prompt	/	The recorder paper is not loaded or the recorder door is not closed. Check the recorder, load the recorder paper or close the recorder door.
Recorder Busy	Prompt	/	The buffer queue for recording is full.

## D.2.11 Networking Technical Alarm Messages

Alarm Message	Default Priority	Indication on Alarm Reset	Cause and Solution
CMS/eGW Disconnected	Low	B	The equipment is disconnected from the CMS. Check the network connection.
WLAN IP Address Conflict	Low	C	Wireless network IP network conflicts. Check the network settings.
LAN1 IP Address Conflict	Low	C	Wired network LAN1 IP network conflicts. Check the network settings.
Fail To Get WLAN IP Address	Low	C	Unable to automatically obtain the wireless network IP address. Check the network settings.
Fail To Get LAN1 IP Address	Low	C	Unable to automatically obtain the wired network LAN1 IP address. Check the network settings.

## D.2.12 Special Technical Alarm Messages

The special technical alarms are not affected by the alarm status, that means alarm volume, alarm lamps and alarm messages are unchangeable. The special technical alarms can be cleared only when alarm conditions are eliminated.

Alarm Message	Default Priority	Indication on Alarm Reset	Cause and Solution
Low Battery	High	C	Connect the equipment to the external power supply and charge the battery.
Critically Low Battery	High	C	Immediately connect the equipment to the external power supply and charge the battery.
Therapy Module Comm Err	High	C	Restart the equipment. If the problem persists, contact your service personnel.
Therapy Equip Selftest Err	High	C	An error occurred during therapy module self test. Restart the equipment or replace the therapy module low voltage board.
Defib Malfunction	High	C	The defibrillation function fails or both the defibrillation and pacing functions fail. Restart the equipment. If the problem persists, contact your service personnel.
Pacer Malfunction	High	C	The pacing function fails. Restart the equipment. If the problem persists, contact your service personnel.

## D.2.13 Other System Technical Alarm Messages

Alarm message	Default priority	Indication on alarm reset	Cause and solution
Main Control Selftest Err	High	C	An error occurred to the main control voltage. Replace the main control board.
Disarming Failed	High	C	There is a problem with the therapy module disarming circuit. Replace the therapy module low voltage board and high voltage board.
Monitor Module Selftest Err	High	C	An error occurred during power-on self test of multi-parameter monitoring module. Replace the multi-parameter monitoring module.
Monitor Module Reset Err	High	C	The multi-parameter monitoring module resets abnormally. In this case, the multi-parameter monitoring module restores to default configuration. You can ignore this problem.
Monitor Module Voltage Err	Low	C	An error occurred to the voltage of the multi-parameter monitoring module. Replace the multi-parameter monitoring module.
Last User Test Failed	Low	C	Perform a successful user test.
Last Auto Test Failed	Low	C	Perform a successful user test again.
Last Energy Test Failed	Low	C	Check the equipment connection and perform a user test to clear the faults.
XX <sup>1</sup> Disconnected	High	A	Corresponding external device is disconnected. Check the connection between the equipment and the external device.
Storage Error	High	C	The storage card fails or files are damaged. Restart the equipment to format the storage card. If the alarm persists, contact your service personnel.
The patient data storage space is nearly full. Please delete some discharged patients.	Med	B	Delete unnecessary earlier historical patient.
Loading Default Config Failed	Low	A	The default configuration is not correctly loaded. The equipment will restore to the factory default configuration for the current patient category.
XX <sup>2</sup> Measurement has been closed	Prompt	/	The parameter module is disabled. Switch on the module if you want to use it. For more information, see 9.2.2 <i>Setting the Switch for a Parameter</i> .
The display setup for XX <sup>2</sup> is disabled.	Prompt	/	The parameter is not displayed on the screen. Select a desired area to display the parameter numerics and waveforms. For more information, see 9.2.3 <i>Defining the Normal Screen Display</i> .
Do not Charge/Discharge Frequently	Prompt	/	The equipment has been frequently charged and discharged in the Manual Defib mode.
User Test Due	Prompt	/	Time period to the last user test exceeds the recommended period. Perform a successful user test.
<p><sup>1</sup> XX represents the name of the external device.</p> <p><sup>2</sup> XX represents a parameter label, such as HR, NIBP, RR, SpO<sub>2</sub>, PR, and so on.</p>			

**This page intentionally left blank.**



# E Defibrillator Shift Checklist

Equipment Name: \_\_\_\_\_ Serial Number: \_\_\_\_\_ Department: \_\_\_\_\_

Item	Pass/Fail/ N/A	Corrective Actions/Remarks
<b>1. Equipment Appearance</b> ◆ Clean, no foreign substance, no crack		
<b>2. Cables/Connectors</b> ◆ Cables not frayed, connectors and pins not broken or loose ◆ Connectors engage securely		
<b>3. Batteries</b> ◆ Battery installed with at least 60% of battery capacity ◆ Fully charged spare battery available		
<b>4. Necessary Accessories (Electrode pads, paddles, ECG leadwires or recorder paper)</b> ◆ Present and sufficient ◆ Inspected to be used normally		
<b>5. Auto Test</b> ◆ Status indicator illuminates in green		
<b>6. Shock Test</b> ■ <b>If the external paddles are used:</b> 1. Connect the equipment with an external power supply, and the power indicator is illuminated. 2. Connect the paddles cable to the equipment, and place the external paddles in the paddle tray. 3. Press the Charge button on the external paddles, and charge the equipment to <b>50J</b> . 4. Press the Shock button on the external paddles. 5. The system prompts that the shock is delivered normally.		
■ <b>If the electrode pads are used:</b> 1. Connect the equipment with an external power supply, and the power indicator is illuminated. 2. Connect the pads cable to the equipment. 3. Perform the user test with a test load connected. 4. The system prompts that the Energy Delivery test is passed.		
<b>5. Monthly Check on Expiration Date</b> ◆ The electrode pads are not expired.		
<b>Checked by:</b> _____ <b>Date:</b> _____		

**This page intentionally left blank.**

# F Accessories

The accessory material that contacts the patients has undertaken the bio-compatibility test and is verified to be in compliance with ISO 10993-1.

## WARNING

- **Use accessories specified in this chapter. Using other accessories may cause damage to the equipment or not meet the claimed specifications.**
- **Single-use accessories are not designed to be reused. Reuse may cause a risk of contamination and affect the measurement accuracy.**

## CAUTION

- **The accessories may not meet the performance specifications if stored or used outside the specified temperature and humidity ranges. If accessory performance is degraded due to aging or environmental conditions, contact your service personnel.**
- **Check the accessories and their packages for any sign of damage. Do not use them if any damage is detected.**
- **Use the accessories before the expiry date if their expiry date is indicated.**
- **The disposable accessories shall be disposed of according to hospital's regulations.**

## F.1 ECG Accessories

### F.1.1 ECG Electrodes

Model	PN	Description	Applicable Patient
31499224	0010-10-12304	Electrode Kendall, 10 pcs/package	Adult
2245-50	9000-10-07469	Electrode 3M, 50 pcs/package	Pediatric
1050NPSMKittyCat	0681-00-0098-01	NEO Pre-wired Electrode radio Opaque	Neonate
1051NPSMKittyCat	0681-00-0098-02	NEO Pre-wired Electrode radio Translucent	Neonate
SF06	040-002711-00	Electrode, 5 pcs/package	Adult
SF07	040-002833-00	Electrode, Intco	Pediatric, Neonate
H124SG	900E-10-04880	Electrode, Kendall, 50 pcs/package	Neonate
EMG-SN10-20×20	040-003254-00	NEO Pre-wired Electrode radio Translucent, AHA	Neonate
EMG-SN10-20×20	040-003255-00	NEO Pre-wired Electrode radio Translucent, IEC	Neonate
EMG-SN09-20×28	040-003251-00	NEO Pre-wired Electrode radio Translucent, AHA	Neonate
EMG-SN09-20×28	040-003252-00	NEO Pre-wired Electrode radio Translucent, IEC	Neonate

## F.1.2 12-Pin Separable Trunk Cables

Model	PN	Description	Applicable Patient
EV6201	0010-30-42719	ECG cable, 12-pin, 3/5-lead, defibrillation-proof AHA/IEC	Adult, Pediatric
EV6202	0010-30-42720	ECG cable, 12-pin, 3-lead, defibrillation-proof, AHA/IEC	Neonate, Infant
EV6211	0010-30-42723	ECG cable, 12-pin, 3/5-lead, ESU-proof, AHA/IEC	Adult, Pediatric
EV6212	0010-30-42724	ECG cable, 12-pin, 3-lead, ESU-proof, AHA/IEC	Neonate, Infant
EV6222	040-000754-00	ECG cable, 12-pin, 3-lead, defibrillation-proof, DIN connector	Neonate
EV6203	0010-30-42721	ECG cable, 12-lead, defibrillation-proof, AHA	Adult
EV6204	0010-30-42722	ECG cable, 12-lead, defibrillation-proof, IEC	Adult

## F.1.3 12-Pin Integrative Trunk Cables

Model	PN	Description	Applicable Patient
EA6251B	040-000961-00	ECG cable, 12-pin, 5-lead, AHA, snap	Adult, Pediatric
EA6252B	040-000963-00	ECG cable, 12-pin, 5-lead, IEC, snap	Adult, Pediatric
EA6251A	040-000960-00	ECG cable, 12-pin, 5-lead, AHA, clip	Adult, Pediatric
EA6252A	040-000962-00	ECG cable, 12-pin, 5-lead, IEC, clip	Adult, Pediatric
EA6231B	040-000965-00	ECG cable, 12-pin, 3-lead, AHA, snap	Adult, Pediatric
EA6232B	040-000967-00	ECG cable, 12-pin, 3-lead, IEC, snap	Adult, Pediatric
EA6231A	040-000964-00	ECG cable, 12-pin, 3-lead, AHA, clip	Adult, Pediatric
EA6232A	040-000966-00	ECG cable, 12-pin, 3-lead, IEC, clip	Adult, Pediatric

## F.1.4 3-lead ECG Leadwires

Model	PN	Description	Length	Applicable Patient
EL6302A	0010-30-42725	ECG leadwires, 3-lead, IEC, clip	0.6 m	Adult, Pediatric
EL6301A	0010-30-42726	ECG leadwires, 3-lead, AHA, clip	0.6 m	Adult, Pediatric
EL6307A	0010-30-42898	ECG leadwires, 3-lead, AHA, clip	0.6 m	Pediatric
EL6308A	0010-30-42899	ECG leadwires, 3-lead, IEC, clip	0.6 m	Pediatric
EL6305A	0010-30-42896	ECG leadwires, 3-lead, AHA, clip, long	1 m	Neonate, Infant
EL6306A	0010-30-42897	ECG leadwires, 3-lead, IEC, clip, long	1 m	Neonate, Infant
EL6303A	0010-30-42731	ECG leadwires, 3-lead, AHA, clip, long	1 m	Adult, Pediatric
EL6304A	0010-30-42732	ECG leadwires, 3-lead, IEC, clip, long	1 m	Adult, Pediatric
EL6301B	0010-30-42734	ECG leadwires, 3-lead, AHA, snap, long	1 m	Adult, Pediatric
EL6302B	0010-30-42733	ECG leadwires, 3-lead, IEC, snap, long	1 m	Adult, Pediatric
EL6307B	0010-30-42900	ECG leadwires, 3-lead, AHA, snap	0.6 m	Pediatric

Model	PN	Description	Length	Applicable Patient
EL6308B	0010-30-42901	ECG leadwires, 3-lead, IEC, snap	0.6 m	Pediatric
EL6311B	040-000146-00	ECG leadwires, 3-lead, AHA, snap, long, disposable	1 m	Neonate, Infant
EL6312B	040-000147-00	ECG leadwires, 3-lead, IEC, snap, long, disposable	1 m	Neonate, Infant
EL6311A	040-000148-00	ECG leadwires, 3-lead, AHA, snap, long, disposable	1 m	Neonate, Infant
EL6312A	040-000149-00	ECG leadwires, 3-lead, IEC, snap, long, disposable	1 m	Neonate, Infant

### F.1.5 5-lead ECG Leadwires

Model	PN	Description	Length	Applicable Patient
EL6503A	0010-30-42729	ECG leadwires, 5-lead, AHA, clip, long	1m to 1.4m	Adult, Pediatric
EL6504A	0010-30-42730	ECG leadwires, 5-lead, IEC, clip, long	1m to 1.4m	Adult, Pediatric
EL6502A	0010-30-42728	ECG leadwires, 5-lead, IEC, clip	0.6m to 1m	Adult, Pediatric
EL6501A	0010-30-42727	ECG leadwires, 5-lead, AHA, clip	0.6m to 1m	Adult, Pediatric
EL6501B	0010-30-42735	ECG leadwires, 5-lead, AHA, snap	1m to 1.4m	Adult, Pediatric
EL6502B	0010-30-42736	ECG leadwires, 5-lead, IEC, snap	1m to 1.4m	Adult, Pediatric

### F.1.6 12-lead ECG Leadwires

Model	PN	Description	Length	Applicable Patient
EL6801A	0010-30-42902	ECG leadwires, 12-lead, limb lead, AHA, clip	0.78m to 0.98m	Adult, Pediatric
EL6803A	0010-30-42904	ECG leadwires, 12-lead, chest lead, AHA, clip	0.58m to 0.78m	Adult, Pediatric
EL6802A	0010-30-42903	ECG leadwires, 12-lead, limb lead, IEC, clip	0.78m to 0.98m	Adult, Pediatric
EL6804A	0010-30-42905	ECG leadwires, 12-lead, chest lead, IEC, clip	0.58m to 0.78m	Adult, Pediatric
EL6801B	0010-30-42906	ECG leadwires, 12-lead, limb lead, AHA, snap	0.78m to 0.98m	Adult, Pediatric
EL6803B	0010-30-42908	ECG leadwires, 12-lead, chest lead, AHA, snap	0.58m to 0.78m	Adult, Pediatric
EL6802B	0010-30-42907	ECG leadwires, 12-lead, limb lead, IEC, snap	0.78m to 0.98m	Adult, Pediatric
EL6804B	0010-30-42909	ECG leadwires, 12-lead, chest lead, IEC, snap	0.58m to 0.78m	Adult, Pediatric

## F.2 SpO<sub>2</sub> Accessories

Wavelength emitted by the sensors is between 600 nm and 1000 nm. The maximum photic output consumption of the sensor is less than 18 mW.

The information about the wavelength range and maximum photic output consumption can be especially useful to clinicians, for example, when photodynamic therapy is performed.

## F.2.1 Extension Cables

Model	Part No.	Description	Applicable Patient
562A	0010-20-42710	7-pin, Mindray	All
572A	0010-20-42712	8-pin, Nellcor	All
582A	040-000332-00	8-pin, Masimo	All
583A	040-005973-00	8-pin, Masimo (RD SET)	All

## F.2.2 Mindray SpO<sub>2</sub> Sensors

Model	PN	Description	Applicable Patient	Application Site
512F	512F-30-28263	Reusable SpO <sub>2</sub> sensor	Adult	Finger
512H	512H-30-79061	Reusable SpO <sub>2</sub> sensor	Pediatric	Finger
512E	512E-30-90390	Reusable SpO <sub>2</sub> sensor	Adult	Finger
512G	512G-30-90607	Reusable SpO <sub>2</sub> sensor	Pediatric	Finger
518B	518B-30-72107	Reusable SpO <sub>2</sub> sensor	Adult, Neonate	Foot
520A	009-005087-00	Disposable SpO <sub>2</sub> sensor	Adult	Finger
520P	009-005088-00	Disposable SpO <sub>2</sub> sensor	Pediatric	Finger
520I	009-005089-00	Disposable SpO <sub>2</sub> sensor	Infant	Toe
520N	009-005090-00	Disposable SpO <sub>2</sub> sensor	Neonate	Foot
521A	009-005091-00	Disposable SpO <sub>2</sub> sensor	Adult	Finger
521P	009-005092-00	Disposable SpO <sub>2</sub> sensor	Pediatric	Finger
521I	009-005093-00	Disposable SpO <sub>2</sub> sensor	Infant	Toe
521N	009-005094-00	Disposable SpO <sub>2</sub> sensor	Neonate	Foot
518C	040-000330-00	Reusable SpO <sub>2</sub> Sensor	Neonate	Foot
518C	115-004895-00	Disposable bandage, for 518C SpO <sub>2</sub> sensor	Neonate	Foot
513A	115-033848-00	Reusable SpO <sub>2</sub> sensor	Adult, Pediatric	Ear
512FLH	115-012807-00	Reusable SpO <sub>2</sub> sensor	Adult	Finger
518BLH	115-020887-00	Reusable SpO <sub>2</sub> sensor	Neonate	Foot
518BLH	115-050154-00	Reusable SpO <sub>2</sub> sensor	Neonate	Foot

## F.2.3 Nellcor SpO<sub>2</sub> Sensors

Model	PN	Description	Applicable Patient	Application Site
DS100A	9000-10-05161	Reusable SpO <sub>2</sub> sensor	Adult	Finger
OXI-P/I	9000-10-07308	Reusable SpO <sub>2</sub> sensor	Pediatric, infant	Finger
OXI-A/N	9000-10-07336	Reusable SpO <sub>2</sub> sensor	Adult, neonate	Finger, foot
MAXAI	0010-10-12202	Disposable SpO <sub>2</sub> sensor	Adult (>30 kg)	Finger
MAXPI	0010-10-12203	Disposable SpO <sub>2</sub> sensor	Pediatric (10 to 50kg)	Finger
MAXII	0010-10-12204	Disposable SpO <sub>2</sub> sensor	Infant (3 to 20kg)	Toe

Model	PN	Description	Applicable Patient	Application Site
MAXNI	0010-10-12205	Disposable SpO <sub>2</sub> sensor	Neonate (<3 kg), Adult (>40 kg)	Foot Finger

## F.2.4 Masimo SpO<sub>2</sub> Sensors

Model	PN	Description	Applicable Patient	Application Site
LNCS DCI	0010-10-42600	Reusable SpO <sub>2</sub> sensor	Adult (>30 kg)	Finger
LNCS DCIP	0010-10-42634	Reusable SpO <sub>2</sub> sensor	Pediatric (10 to 50kg)	Finger

## F.3 NIBP Accessories

### F.3.1 NIBP Hoses

Model	Part No.	Description	Applicable Patient
CM1903	6200-30-09688 115-012522-00	Reusable NIBP hose (3m)	All

### F.3.2 Cuffs

Model	Part No.	Description	Limb Circumference	Bladder Width	Applicable Patient
CM1200	115-002480-00	Reusable cuff	7 cm to 13 cm	3.8 cm	Small infant
CM1201	0010-30-12157	Reusable cuff	10 cm to 19 cm	7.2 cm	Infant
CM1202	0010-30-12158	Reusable cuff	18 cm to 26 cm	9.8 cm	Pediatric
CM1203	0010-30-12159	Reusable cuff	24 cm to 35 cm	13.1 cm	Adult
CM1204	0010-30-12160	Reusable cuff	33 cm to 47 cm	16.5 cm	Large adult
CM1205	0010-30-12161	Reusable cuff	46 cm to 66 cm	20.5 cm	Adult thigh
CM1300	040-000968-00	Reusable cuff, bladderless	7 cm to 13 cm	3.8 cm	Small infant
CM1301	040-000973-00	Reusable cuff, bladderless	10 cm to 19 cm	7.2 cm	Infant
CM1302	040-000978-00	Reusable cuff, bladderless	18 cm to 26 cm	9.8 cm	Pediatric
CM1303	040-000983-00	Reusable cuff, bladderless	24 cm to 35 cm	13.1 cm	Adult
CM1304	040-000988-00	Reusable cuff, bladderless	33 cm to 47 cm	16.5 cm	Large adult
CM1305	040-000993-00	Reusable cuff, bladderless	46 cm to 66 cm	20.5 cm	Adult thigh
CM1306	115-015930-00	Reusable cuff, bladderless	24 cm to 35 cm	13.1 cm	Adult
CM1307	115-015931-00	Reusable cuff, bladderless	33 cm to 47 cm	16.5 cm	Large adult

Model	Part No.	Description	Limb Circumference	Bladder Width	Applicable Patient
CM1501	001B-30-70697	Disposable NIBP cuff, 10 pcs/box	10 cm to 19 cm	7.2 cm	Infant
CM1502	001B-30-70698	Disposable NIBP cuff, 10 pcs/box	18 cm to 26 cm	9.8 cm	Pediatric
CM1503	001B-30-70699	Disposable NIBP cuff, 10 pcs/box	25 cm to 35 cm	13.1 cm	Adult
CM1504	001B-30-70700	Disposable NIBP cuff, 10 pcs/box	33 cm to 47 cm	16.5 cm	Adult
CM1505	001B-30-70701	Disposable NIBP cuff, 10 pcs/box	46 cm to 66 cm	20.5 cm	Adult thigh
CM1506	115-016969-00	Disposable NIBP cuff, 10 pcs/box	25 cm to 35 cm	13.1 cm	Adult
CM1507	115-016970-00	Disposable NIBP cuff, 10 pcs/box	33 cm to 47 cm	16.5 cm	Adult
CM1500A	125-000051-00	Disposable NIBP cuff, size 1, 20 pcs/box	3.1 cm to 5.7 cm	2.2 cm	Neonate
CM1500B	125-000052-00	Disposable NIBP cuff, size 2, 20 pcs/box	4.3 cm to 8.0 cm	2.9 cm	Neonate
CM1500C	125-000053-00	Disposable NIBP cuff, size 3, 20 pcs/box	5.8 cm to 10.9 cm	3.8 cm	Neonate
CM1500D	125-000054-00	Disposable NIBP cuff, size 4, 20 pcs/box	7.1 cm to 13.1 cm	4.8 cm	Neonate
CM1500E	125-000055-00	Disposable NIBP cuff, size 5, 20 pcs/box	8.0 cm to 15.0 cm	5.4 cm	Neonate
CM1500A	125-000046-00	Disposable NIBP cuff	3.1 cm to 5.7 cm	2.2 cm	Neonate
CM1500B	125-000047-00	Disposable NIBP cuff	4.3 cm to 8.0 cm	2.9 cm	Neonate
CM1500C	125-000048-00	Disposable NIBP cuff	5.8 cm to 10.9 cm	3.8 cm	Neonate
CM1500D	125-000049-00	Disposable NIBP cuff	7.1 cm to 13.1 cm	4.8 cm	Neonate
CM1500E	125-000050-00	Disposable NIBP cuff	8.0 cm to 15.0 cm	5.4 cm	Neonate
CM1501	001B-30-70682	Disposable NIBP cuff	10 cm to 19 cm	7.2 cm	Infant
CM1502	001B-30-70683	Disposable NIBP cuff	18 cm to 26 cm	9.8 cm	Pediatric
CM1503	001B-30-70684	Disposable NIBP cuff	25 cm to 35 cm	13.1 cm	Adult
CM1504	001B-30-70685	Disposable NIBP cuff	33 cm to 47 cm	16.5 cm	Adult
CM1505	001B-30-70686	Disposable NIBP cuff	46 cm to 66 cm	20.5 cm	Adult thigh
CM1506	115-015940-00	Disposable NIBP cuff	25 cm to 35 cm	13.1 cm	Adult



Model	Part No.	Description	Limb Circumference	Bladder Width	Applicable Patient
CM1507	115-015941-00	Disposable NIBP cuff	33 cm to 47 cm	16.5 cm	Adult

## F.4 CO<sub>2</sub> Accessories

Model	Part No.	Description	Applicable Patient
GA3501	045-003134-00	Reusable CO <sub>2</sub> adapter	/
MVIIHL	040-006160-00	Disposable airway sampling line, long, humidified	Neonatal, Infant
MVAIHL	040-006161-00	Disposable airway sampling line, long, humidified	Adult, Pediatric
MVAIL	040-006162-00	Disposable airway sampling line, humidified	Adult, Pediatric
MVIIIH	040-006163-00	Disposable airway sampling line, humidified	Neonatal, Infant
MVAIH	040-006164-00	Disposable airway sampling line, humidified	Adult, Pediatric
MVAI	040-006165-00	Disposable airway sampling line	Adult, Pediatric
MVPN	040-006166-00	Disposable nasal sampling line	Pediatric
MVAN	040-006167-00	Disposable nasal sampling line	Adult
MVANH	040-006168-00	Disposable nasal sampling line, humidified	Adult
MVA	040-006169-00	Disposable nasal sampling line	Adult
MVP	040-006170-00	Disposable nasal sampling line	Pediatric
MVPNOH	040-006171-00	Disposable nasal sampling line, humidified, plus O <sub>2</sub>	Pediatric
MVAOL	040-006172-00	Disposable nasal sampling line, long, plus O <sub>2</sub>	Adult
MVAO	040-006173-00	Disposable nasal sampling line, plus O <sub>2</sub>	Adult
MVANOH	040-006174-00	Disposable nasal sampling line, humidified, plus O <sub>2</sub>	Adult
MVINH	040-006175-00	Disposable nasal sampling line, humidified	Neonatal, Infant
MVPO	040-006176-00	Disposable nasal sampling line, plus O <sub>2</sub>	Pediatric
MVPOL	040-006177-00	Disposable nasal sampling line, long, plus O <sub>2</sub>	Pediatric

## F.5 Therapy Accessories

Model	Part No.	Description	Applicable Patient
MR6601	125-000130-00	Reusable external paddles (for hospital)	Adult, Pediatric
MR6501	115-018366-00	Reusable internal paddles, 1 inch without button	Neonate
	125-000166-00	Reusable internal paddles, 1 inch with button	
MR6502	115-018367-00	Reusable internal paddles, 2 inches without button	Pediatric
	125-000167-00	Reusable internal paddles, 2 inches with button	

Model	Part No.	Description	Applicable Patient
MR6503	115-018368-00	Reusable internal paddles, 3 inches without button	Adult
	125-000168-00	Reusable internal paddles, 3 inches with button	
MR60	0651-30-77007	Disposable multifunction electrode pads, 5 sets/package	Adult
MR61	0651-30-77008	Disposable multifunction electrode pads, 5 sets/package	Pediatric
MR62	115-035426-00	Disposable multifunction electrode pads, 5 sets/package	Adult
MR63	115-035427-00	Disposable multifunction electrode pads, 5 sets/package	Pediatric
MR6701	115-006578-00	Reusable pads cable with 50Ω test load	Adult, Pediatric
15-25	0000-10-10775	Reusable electrode gel	Adult, Pediatric
MR6311	125-000255-00	Reusable carrying case	All

## F.6 Other Accessories

Part No.	Description
115-084255-00	Simple mounting
0010-30-12471	DC/AC inverter
115-084253-00	Transport dock
0651-20-77122	Analog output cable
0651-20-77046	Synchronous defibrillation input cable
115-067930-00	Wi-Fi to 4G router kit
115-084254-00	Charger station
115-039575-00	Barcode reader
A30-000001---	Recorder paper, 50 mm×20 m
022-000550-00	Rechargeable lithium-ion battery
040-000413-00	Test load

# G Electrical Safety Inspection

The following electrical safety tests are recommended as part of a comprehensive preventive maintenance program. They are a proven means of detecting abnormalities that, if undetected, could prove dangerous to either the patient or the operator. Additional tests may be required according to local regulations.

All tests can be performed by using commercially available safety analyzer test equipment. These procedures assume the use of a 601PROXL International Safety Analyzer or equivalent safety analyzer. Other popular testers complying with IEC 60601-1 used in Europe, such as Fluke, Metron or Gerb, may require modifications to the procedure. Please follow the instructions of the analyzer manufacturer.

The electrical safety inspection should be periodically performed per year. The safety analyzer also proves to be an excellent troubleshooting tool to detect abnormalities of line voltage and grounding, as well as total current loads.

## G.1 Power Cord Plug

Test Item		Acceptance Criteria
The power plug	The power plug pins	No broken or bent pin. No discolored pins.
	The plug body	No physical damage to the plug body.
	The strain relief	No physical damage to the strain relief. No plug warmth for device in use.
	The power plug	No loose connections.
The power cord		No physical damage to the cord. No deterioration to the cord.
		For devices with detachable power cords, inspect the connection at the device.
		For devices with non-detachable power cords, inspect the strain relief at the device.

## G.2 Device Enclosure and Accessories

### G.2.1 Visual Inspection

Test Item	Acceptance Criteria
The enclosure and accessories	No physical damage to the enclosure and accessories.
	No physical damage to meters, switches, connectors, etc.
	No residue of fluid spillage (e.g., water, coffee, chemicals, etc.).
	No loose or missing parts (e.g., knobs, dials, terminals, etc.).

### G.2.2 Contextual Inspection

Test Item	Acceptance Criteria
The enclosure and accessories	No unusual noises (e.g., a rattle inside the case).
	No unusual smells (e.g., burning or smoky smells, particularly from ventilation holes).
	No taped notes that may suggest device deficiencies or operator concerns.

## G.3 Device Labeling

Check the labels provided by the manufacturer or the healthcare facilities are present and legible.

- Main unit label
- Integrated warning labels

## G.4 Protective Earth Resistance

1. Plug the probes of the analyzer into the device's protective earth terminal and protective earth terminal of the AC power cord.
2. Test the earth resistance with a current of 25 A.
3. Verify the resistance is less than limits.

### LIMITS

For all countries,  $R = 0.2 \Omega$  Maximum

## G.5 Earth Leakage Test

Run an Earth Leakage test on the device being tested before performing any other leakage tests.

The following outlet conditions apply when performing the Earth Leakage test:

- normal polarity (Normal Condition)
- reverse polarity (Normal Condition)
- normal polarity with open neutral (Single Fault Condition)
- reverse polarity with open neutral (Single Fault Condition)

### LIMITS

For UL60601-1,

- ◆ 300  $\mu$ A in Normal Condition
- ◆ 1000  $\mu$ A in Single Fault Condition

For IEC60601-1,

- ◆ 500  $\mu$ A in Normal Condition
- ◆ 1000  $\mu$ A in Single Fault Condition

## G.6 Patient Leakage Current

Patient leakage currents are measured between a selected applied part and mains earth. All measurements have a true RMS only

The following outlet conditions apply when performing the Patient Leakage Current test.

- normal polarity (Normal Condition)
- reverse polarity (Normal Condition)
- normal polarity with open neutral (Single Fault Condition)
- reverse polarity with open neutral (Single Fault Condition)
- normal polarity with open earth (Single Fault Condition)
- reverse polarity with open earth (Single Fault Condition)

### LIMITS

For CF  applied parts

- ◆ 10 $\mu$ A in Normal Condition
- ◆ 50 $\mu$ A in Single Fault Condition

For BF  applied parts

- ◆ 100µA in Normal Condition
- ◆ 500µA in Single Fault Condition

## G.7 Mains on Applied Part Leakage

The Mains on Applied Part test applies a test voltage, which is 110% of the mains voltage, through a limiting resistance, to selected applied part terminals. Current measurements are then taken between the selected applied part and earth. Measurements are taken with the test voltage (110% of mains) to applied parts in the normal and reverse polarity conditions

The following outlet conditions apply when performing the Mains on Applied Part test.

- Normal Polarity
- Reversed Polarity

### LIMITS

- For CF  applied parts: 50 µA
- For BF  applied parts: 5000 µA

## G.8 Patient Auxiliary Current

Patient Auxiliary currents are measured between any selected Applied Part connector and the remaining Applied Part connectors. All measurements may have a true RMS only response.

The following outlet conditions apply when performing the Patient Auxiliary Current test.

- normal polarity (Normal Condition)
- reverse polarity (Normal Condition)
- normal polarity with open neutral (Single Fault Condition)
- reverse polarity with open neutral (Single Fault Condition)
- normal polarity with open earth (Single Fault Condition)
- reverse polarity with open earth (Single Fault Condition)

### LIMITS

For CF  applied parts,

- ◆ 10µA in Normal Condition
- ◆ 50µA in Single Fault Condition

For BF  applied parts,

- ◆ 100µA in Normal Condition
- ◆ 500µA in Single Fault Condition

### NOTE

- 
- **Make sure the safety analyzer is authorized comply with requirement of IEC60601-1.**
  - **Follow the instructions of the analyzer manufacturer.**
-

**This page intentionally left blank.**

# H Abbreviations

---

Abbreviation	Full Name
°C	centigrade
°F	fahrenheit
μA	microampere
μV	microvolt
μs	microsecond
Ω	ohm
A	ampere
AC	alternating current
Adu	adult
AED	Semi-automated external defibrillation
AHA	American Heart Association
Ao	aortic pressure
Art	arterial
aVF	left foot augmented lead
aVL	left arm augmented lead
aVR	right arm augmented lead
awRR	airway respiratory rate
BAP	brachial arterial pressure
BP	blood pressure
bpm	beat per minute
bps	bit per second
BPSK	binary phase shift keying
BTPS	body temperature and pressure, saturated
CAA	Clinical Assistive Application
CE	Conformité Européenne
CISPR	International Special Committee on Radio Interference
CMS	central monitoring system
CO <sub>2</sub>	carbon dioxide
COHb	carboxyhemoglobin
COPD	chronic obstructive pulmonary disease
CPR	Cardiopulmonary resuscitation
CQI	CPR quality index
CVP	central venous pressure
dB	decibel

<b>Abbreviation</b>	<b>Full Name</b>
DC	direct current
Defib	defibrillation
Des	desflurane
Dia	diastolic
DPI	dot per inch
DVI	digital video interface
ECG	electrocardiograph
EEC	European Economic Community
EMC	electromagnetic compatibility
EMG	electromyograph
EMI	electromagnetic interference
Enf	enflurane
ESU	electrosurgical unit
Et	end-tidal
EtCO <sub>2</sub>	end-tidal carbon dioxide
FAP	femoral arterial pressure
FCC	Federal Communication Commission
FICO <sub>2</sub>	fraction of inspired carbon oxygen
g	gram
GCS	Glasgow Coma Scale
GHz	gigahertz
h	hour
Hal	halothane
HIS	hospital information system
HR	heart rate
Hz	hertz
I:E	inspiratory-expiratory ratio
IABP	intra-aortic balloon pump
IBP	invasive brood pressure
ICP	intracranial pressure
ID	identification
IEC	International Electrotechnical Commission
IEEE	Institute of Electrical and Electronic Engineers
in	inch
IP	internet protocol
Iso	isoflurane
J	Joule
k	kilo
kg	kilogram



<b>Abbreviation</b>	<b>Full Name</b>
kPa	kilopascal
L	litre
LA	left arm
LAP	left atrial pressure
lb	pound
LCD	liquid crystal display
LED	light emitting diode
LL	left leg
m	meter
MAC	minimal alveolar concentration
MAP	mean arterial pressure
mAh	Milliampere hour
Mb	mega byte
MethHb	methemoglobin
MEWS	Modified Early Warning Score
min	minute
ml	milliliter
mm	millimeter
mmHg	millimeters of mercury
ms	millisecond
mV	millivolt
MRI	magnetic resonance imaging
N/A	not applied
N <sub>2</sub> O	nitrous oxide
Neo	neonate
NIBP	noninvasive blood pressure
O <sub>2</sub>	oxygen
PA	pulmonary artery
Ped	pediatric
Pleth	plethysmogram
PNC	pacer not captured
PNP	pacer not paced
PR	pulse rate
PVC	premature ventricular complex
R	right
RA	right arm
RAP	right atrial pressure
Resp	respiration
RL	right leg

<b>Abbreviation</b>	<b>Full Name</b>
RR	respiration rate
rpm	breaths per minute
s	second
Sev	sevoflurane
SI	stroke index
SpO <sub>2</sub>	arterial oxygen saturation from pulse oximetry
SQI	signal quality index
SR	suppression ratio
Sync	synchronization
Sys	systolic pressure
TB	blood temperature
TBI	Traumatic Brain Injury
TD	temperature difference
Temp	temperature
UAP	umbilical arterial pressure
USB	universal serial bus
UVP	umbilical venous pressure
V	volt
VAC	volts alternating current

# Declaration of Conformity

Declaration of Conformity V1.0

## Declaration of Conformity



**Manufacturer:** Shenzhen Mindray Bio-Medical Electronics Co., Ltd.  
Mindray Building, Keji 12th Road South, Hi-tech Industrial Park,  
Nanshan, Shenzhen, 518057, P. R. China

**EC-Representative:** Shanghai International Holding Corp. GmbH (Europe)  
Eiffestraße 80  
20537 Hamburg, Germany

**Product:** Defibrillator/Monitor

**Model:** BeneHeart D30/BeneHeart D20/BeneHeart D20A/BeneHeart  
D20C/BeneHeart D60/BeneHeart D50/ BeneHeart D50A/BeneHeart  
D50C/BeneHeart DX/ BeneHeart DM

We herewith declare that the above mentioned products meet the provisions of the Council Directive 2014/53/EU concerning radio equipment. All supporting documentation is retained under the premises of the manufacturer.

Standards Applied:

<input checked="" type="checkbox"/> EN 60601-1:2006/A1:2013	<input checked="" type="checkbox"/> EN 60601-1-2: 2015
<input checked="" type="checkbox"/> EN 62311:2008	<input checked="" type="checkbox"/> ETSI EN 301 489-1 V2.2.3
<input checked="" type="checkbox"/> ETSI EN 301 489-3 V2.2.0	<input checked="" type="checkbox"/> ETSI EN 301 489-17 V3.1.1
<input checked="" type="checkbox"/> ETSI EN301 489-19V2.1.1	<input checked="" type="checkbox"/> ETSI EN301 489-52V1.1.0
<input checked="" type="checkbox"/> ETSI EN301 908-1 V13.1.1	<input checked="" type="checkbox"/> ETSI EN 301 908-2 V13.1.1
<input checked="" type="checkbox"/> ETSI EN 301 908-13 V13.1.1	<input checked="" type="checkbox"/> EN301 908-25 V15.1.1_15.0.2
<input checked="" type="checkbox"/> ETSI EN 301 893 V2.1.1	<input checked="" type="checkbox"/> ETSI EN301 511 V12.5.1
<input checked="" type="checkbox"/> EN 300 330V2.1.1	<input checked="" type="checkbox"/> ETSI EN303 413 V1.1.1
<input checked="" type="checkbox"/> ETSI EN 300 328 V2.2.2	/

Place, Date of Issue: Shenzhen, 2023.1.1

Signature:

Name of Authorized Signatory: Wang Xinbing

Position Held in Company: Deputy director, Technical Regulation

**This page intentionally left blank.**



