

Selection guide

Microplate selection guide

Your high-throughput sample preparation resource



Contents

1	Microplate selection guide	3
2	Drug discovery	7
3	Nucleic acid purification	9
4	UNIFILTER™ filtration microplates	13
5	UNIPLATE collection and analysis microplates	16
6	Seals and lids	17
7	Accessories	18
8	Filter selection guide	19

1

Microplate selection guide

Your high-throughput sample preparation resource

Cytiva offers a range of multiwell plates for use in nucleic acid sample preparation and drug discovery. We use a proprietary process to encapsulate the filter media which minimizes crosstalk or contamination between wells. This proprietary technology allows us to use a variety of Whatman™ filter media, as well as high quality media from other manufacturers. In addition, to further optimize UNIFILTER microplates for specific applications, we incorporate a variety of novel polymers, well densities, profiles, and accessories.

Cytiva also manufactures an assortment of microplates for sample collection, analysis, and storage. UNIFILTER microplates are available in 24-, 96-, and 384-well configurations. Collection/storage microplates are available in 24-, 48-, and 96-well configurations in various well designs as well as polymers. Most of our microplates with or without filters conform to ANSI/SBS¹ standards.

¹ ANSI is the American National Standards Institute and SBS is the Society of Biomolecular Screening.



UNIFILTER filtration microplates (p. 13)

UNIFILTER filtration microplates, which are produced in standard 24-, 96-, or 384- well formats, have a filter or membrane encapsulated in the base of each well.

Filtration microplates are available in clear or white polystyrene for use in high throughput biological assay screening applications. A wide range of filtration media to suit different biological assays is available.

The following filtration microplates are available for sample preparation and cleanup: 100 µl for 384 well, 250 µl, 350 µl, 800 µl and 2 ml for 96-well and 10 ml for 24-well. These microplates are available in polystyrene for biological samples and glass filled polypropylene for organic samples.

Well format and well volume

Well format	Well volume
384	100 µl
96	250, 350, and 800 µl, 2 ml
24	10 ml

Plate materials

Plate materials	Description
Clear polystyrene	Well contents can be seen
White polystyrene	Suitable for chemiluminescence and radioactivity
Natural polypropylene	Semi-clear. Well contents can be seen Better chemical compatibility than polystyrene
Glass-filled polypropylene	Better chemical compatibility than natural polypropylene



UNIPLATE collection and analysis microplates (p. 16)

Cytiva microplates for collection and analysis are available in 24-, 48-, and 96-well formats. These microplates are manufactured from polystyrene and polypropylene materials to accommodate a range of sampling and storage applications.

Accessories (p. 18)

Cytiva offers accessories for use with its filtration and collection microplates including lids, seals, and pierceable capmat.

Engineered for batch processing

Most microplates conform to the ANSI/SBS standards and are engineered for fast and convenient batch processing applications. These robust, high-quality microplates offer consistency and reproducibility, and are available in a range of polymers to suit your application requirements. Most microplate products are suitable for automated robotic handling and centrifuge carriers.



Capmat

Microplate selection guide

Drug discovery

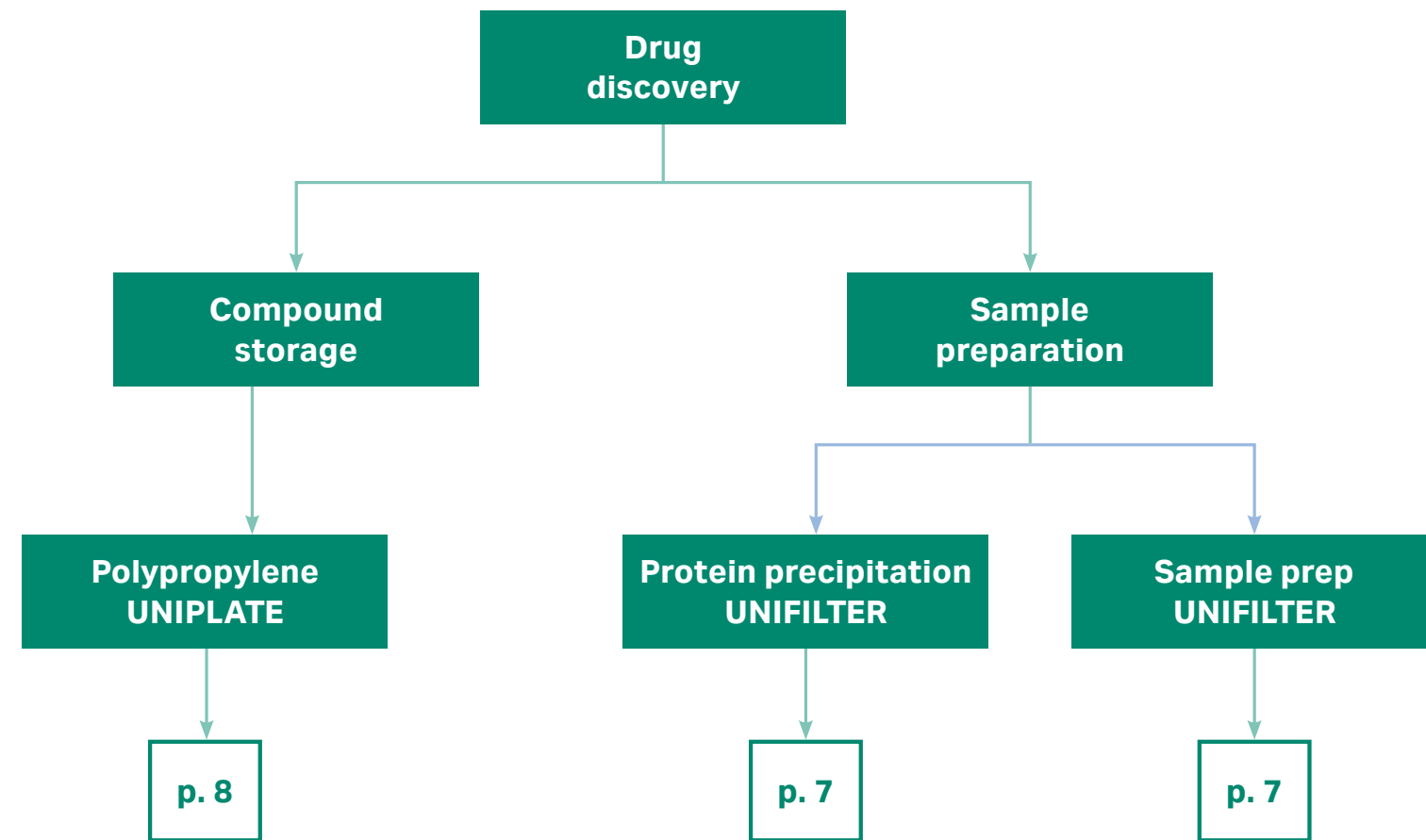

HPLC sample prep

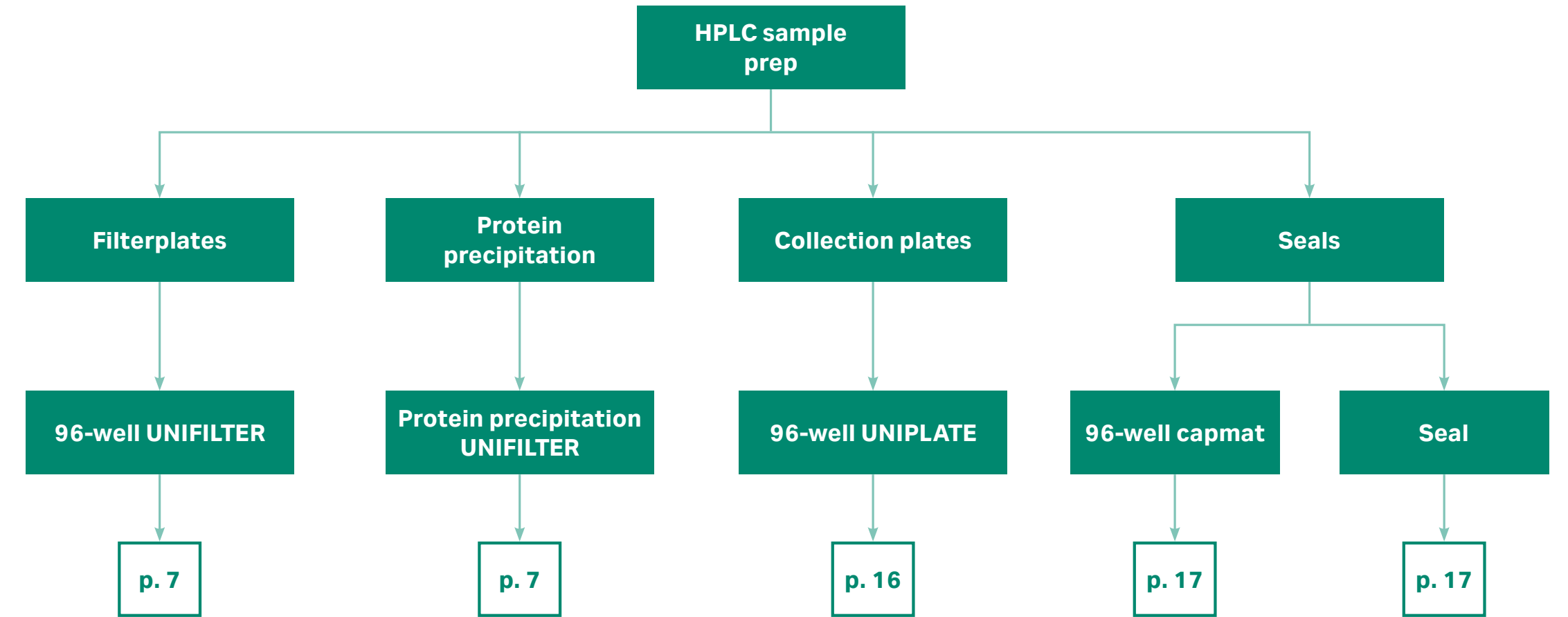

Nucleic acid sample preparation

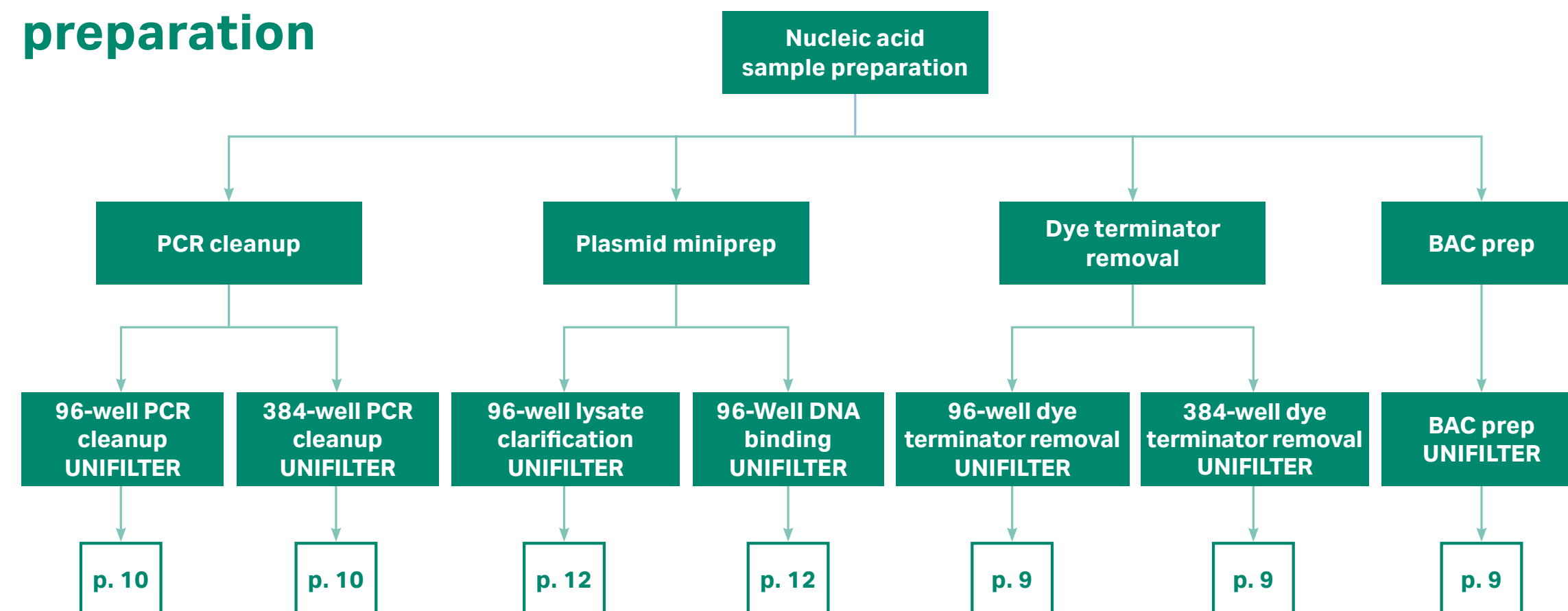

Sample storage

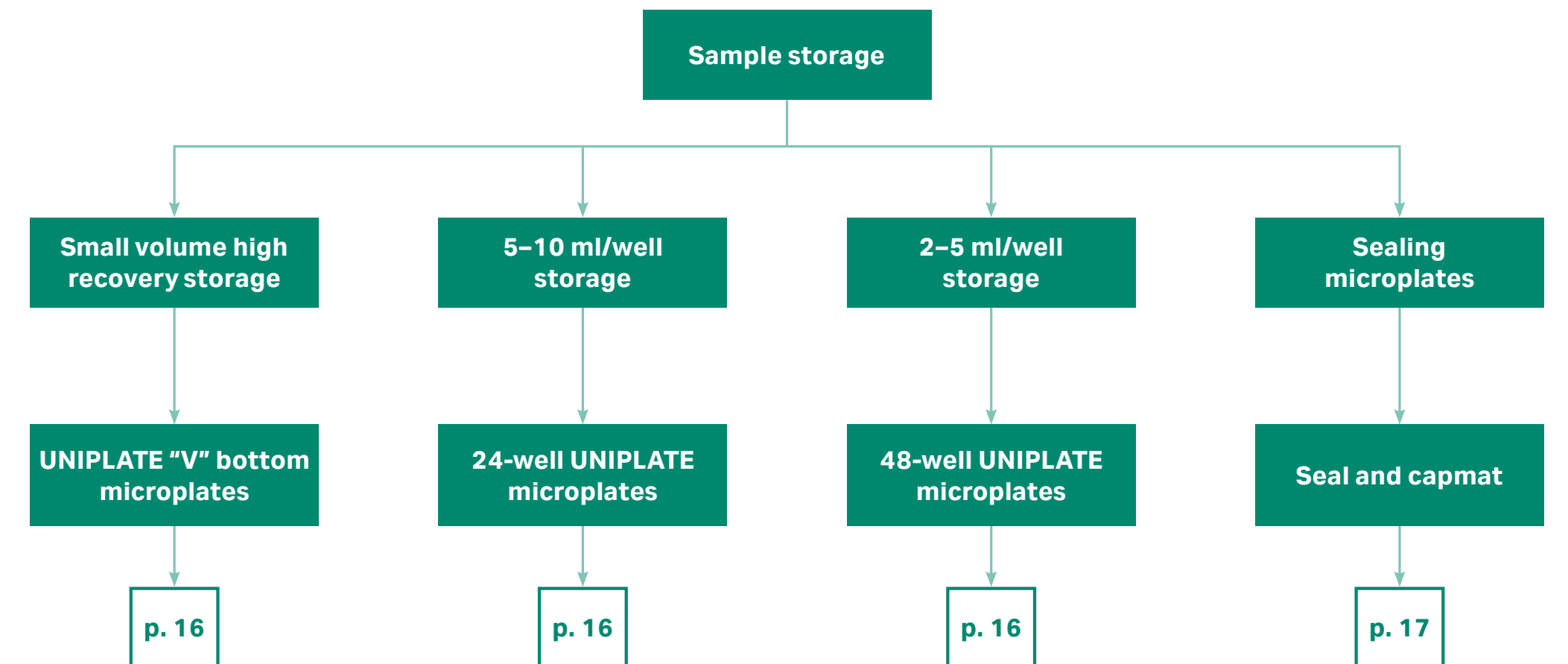

2

Drug discovery

Protein precipitation UNIFILTER

The Protein Precipitation UNIFILTER is optimized for removing acetonitrile-precipitated proteins from plasma or serum samples. The Protein Precipitation UNIFILTER is both robust and chemically resistant because it is made with 2 ml of a 96-well rigid glass-filled polypropylene.

The plates contain specially formulated dual membranes with two distinct layers. The top layer acts as a prefilter to remove coarse particulates. The bottom layer is oleophobic for retaining the well contents without dripping. This provides a final filter for removing fine particulate matter when vacuum or centrifugation is applied.

Sample prep UNIFILTER

Because most HPLC autosamplers can now accommodate 96-well plates, it makes more sense to prepare samples using 96-well filterplates instead of 96 syringe filters. The Sample Prep UNIFILTER incorporates a 0.45 µm PVDF membrane and is suitable for automated and robotic handling. The UNIFILTER is matched to its own UNIPLATE collection plate, which is available in inert polypropylene. The collection plate can be sealed with pierceable capmats or heat sealed. The samples can be filtered either by centrifugation or vacuum.

VFE UNIFILTER

VFE media is designed to remove particles > 5 µm, such as human white blood cells or epithelial cells.

Ordering information

Catalog number	Well format	Well volume	Plate material	Filter media	Well bottom	Quantity/case
Protein precipitation UNIFILTER						
7720-7236	96	2 ml	Glass polypropylene	Fast flow	—	5
7701-5200*	96	2 ml	Natural polypropylene	—	Round bottom	25
Sample prep UNIFILTER						
7700-7206	96	2 ml	Glass-filled polypropylene	0.45 µm Hydrophilic PVDF	—	25
7701-5200*	96	2 ml	Polypropylene	—	Round bottom	25
7704-0105	96	—	Silicone capmats for 750 µl microplates	—	—	50
VFE UNIFILTER						
7700-9902	24	10 ml	Natural polypropylene	VFE	—	25

* Collection Plates



Protein precipitation UNIFILTER



Sample prep UNIFILTER

UNIPLATE for compound storage

UNIPLATE microplates are suitable for compound storage. Cytiva offers a wide range of UNIPLATE microplates from 24- to 96-well and from 80 µl/well to 10 ml/well. Lids, capmats and seals are also available to cover the microplate. (see p.17)

Ordering information

Catalog number	Well format	Well volume	Plate material	Well bottom	Quantity/ case
UNIPLATE for compound storage					
7701-5102	24	10 ml	Natural polypropylene	Round	25
7701-5500	48	5 ml	Natural polypropylene	Flat (rectangular well)	25
7701-5200	96	2 ml	Natural polypropylene	Round	25

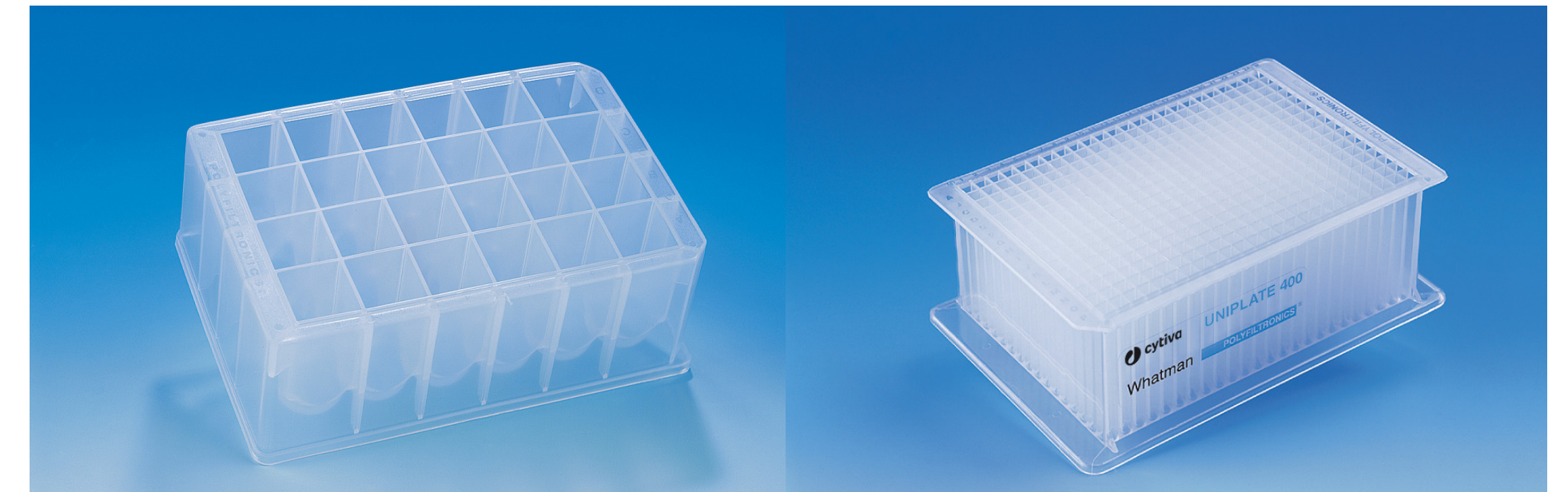

3

Nucleic acid purification

96-well dye terminator removal UNIFILTER

This UNIFILTER is used with gel filtration media for high throughput sequencing reaction cleanup. The UNIFILTER removes troublesome leftover dye terminators from DNA fragments and reduces well-to-well crosstalk. With 96-wells and a rigid polystyrene frame that can withstand centrifugation, the dye terminator removal UNIFILTER is an efficient, cost-effective tool for high-throughput sequencing reaction clean-up.

384-well dye terminator removal UNIFILTER

A 384-well version is also available for dye terminator removal.

BAC prep UNIFILTER

With ever-increasing demand for simple and fast methods to purify DNA from bacterial cultures, the BAC Prep UNIFILTER is the ideal solution for the clarification of lysates containing large insert vectors.

This UNIFILTER has a Cellulose Acetate membrane with a special support, which clears nonchaotropic bacterial lysates, and has long drip directors to prevent crosstalk.

Without further purification, the DNA is clean enough for further enzymatic manipulation. Cellulose acetate acts as both a depth filter and a fine particle filter. The 0.45 µm pores do not block because of the depth effect of the filter and does not bind either DNA or protein.

Ordering information

Catalog number	Well format	Well volume	Plate material	Filter media	Well bottom	Quantity/case
Dye terminator removal UNIFILTER						
7700-2801	96	800 µl	Polystyrene	—	Filter, LDD*	25
7701-5750†	96	750 µl	Natural polypropylene	—	Round	25
7700-1101	384	100 µl	Polystyrene	—	Filter, LDD*	50
BAC prep UNIFILTER						
7700-2808	96	800 µl	Clear polystyrene	0.45 µm, Cellulose acetate	Filter, LDD*	25
7701-5200†	96	2 ml	Natural polypropylene	—	Round	25

* Long drip director

† Collection plate

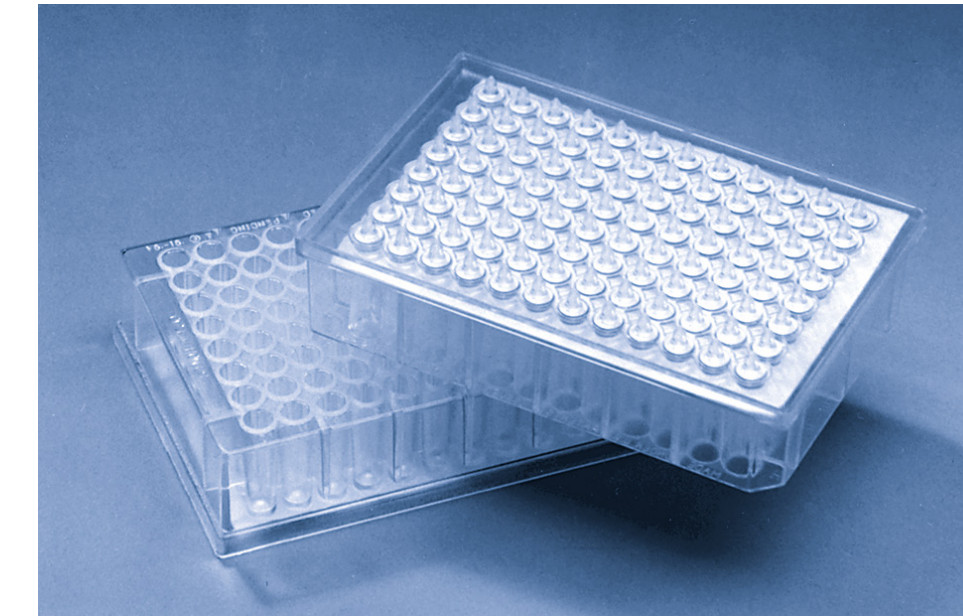

96-well dye terminator removal UNIFILTER

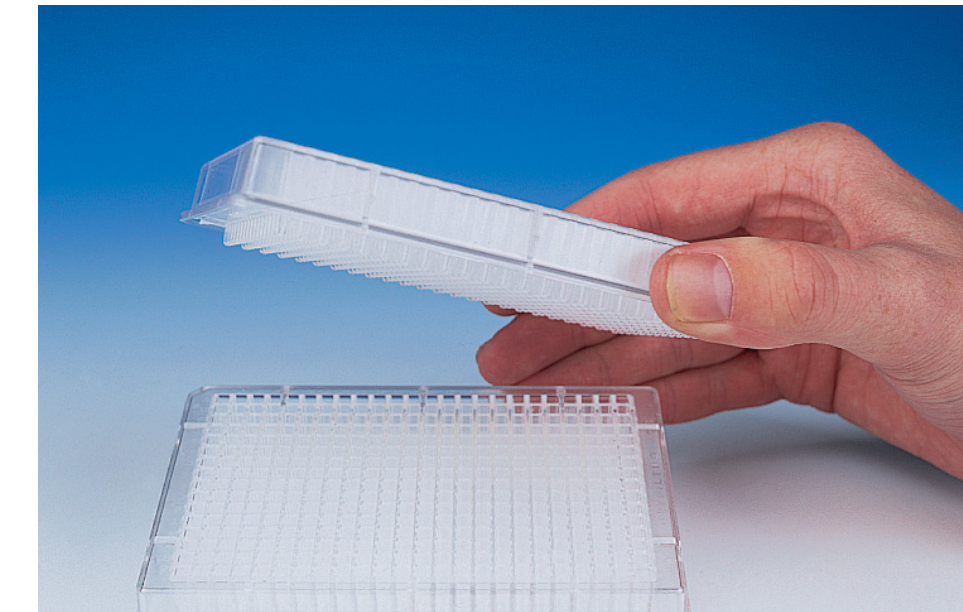

384-well dye terminator removal UNIFILTER

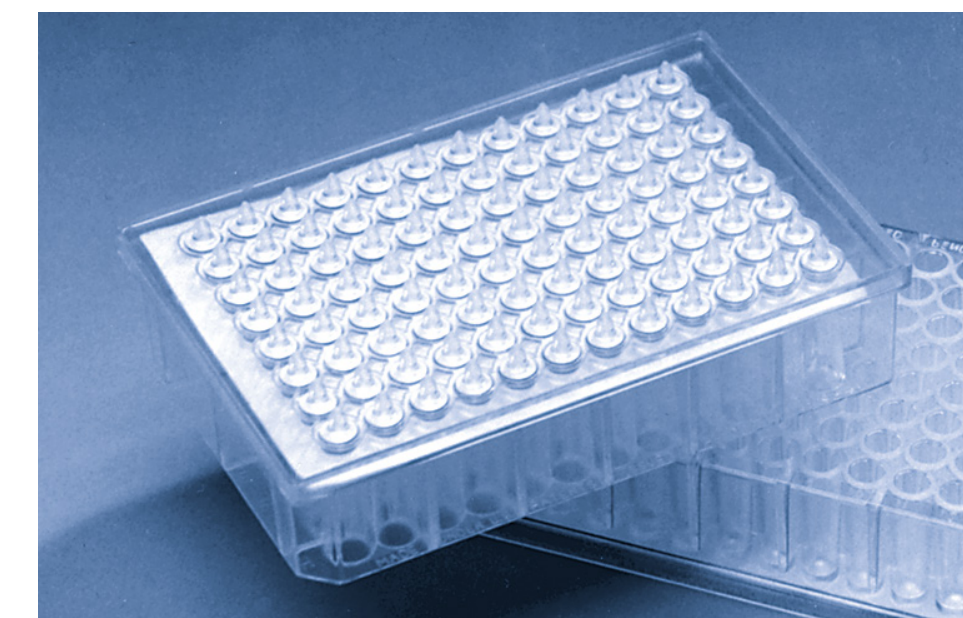

BAC prep UNIFILTER

96-well PCR cleanup UNIFILTER

Designed to process 96 samples in 10 min with excellent recovery. The PCR cleanup UNIFILTER reduces time consuming precipitations and labor-intensive resin purifications. Purified DNA is ready for sequencing, hybridization assays, restriction digests, ligations, and microarrays.

Features

- Removes up to 99% of proteins
- Designed to clean up PCR products from 100 bp to 10 kb
- Can be used with both vacuum and centrifuge techniques
- No need to remove mineral oil
- Easy to automate

384-well PCR cleanup UNIFILTER

A 384-well version is also available for PCR cleanup. Centrifugation is recommended.

Ordering information

Catalog number	Well format	Well volume	Plate material	Filter media	Drip director	Quantity/ case
PCR cleanup UNIFILTER						
7700-2810	96	800 µl	Clear polystyrene	DNA binding	Long	25
7701-5200*	96	2 ml	Polypropylene	—	—	25
7704-0001	—	—	Clear polyester adhesive seals	—	—	100
7700-2110	384	100 µl	Clear polystyrene	DNA binding	Long	50

* Collection plate

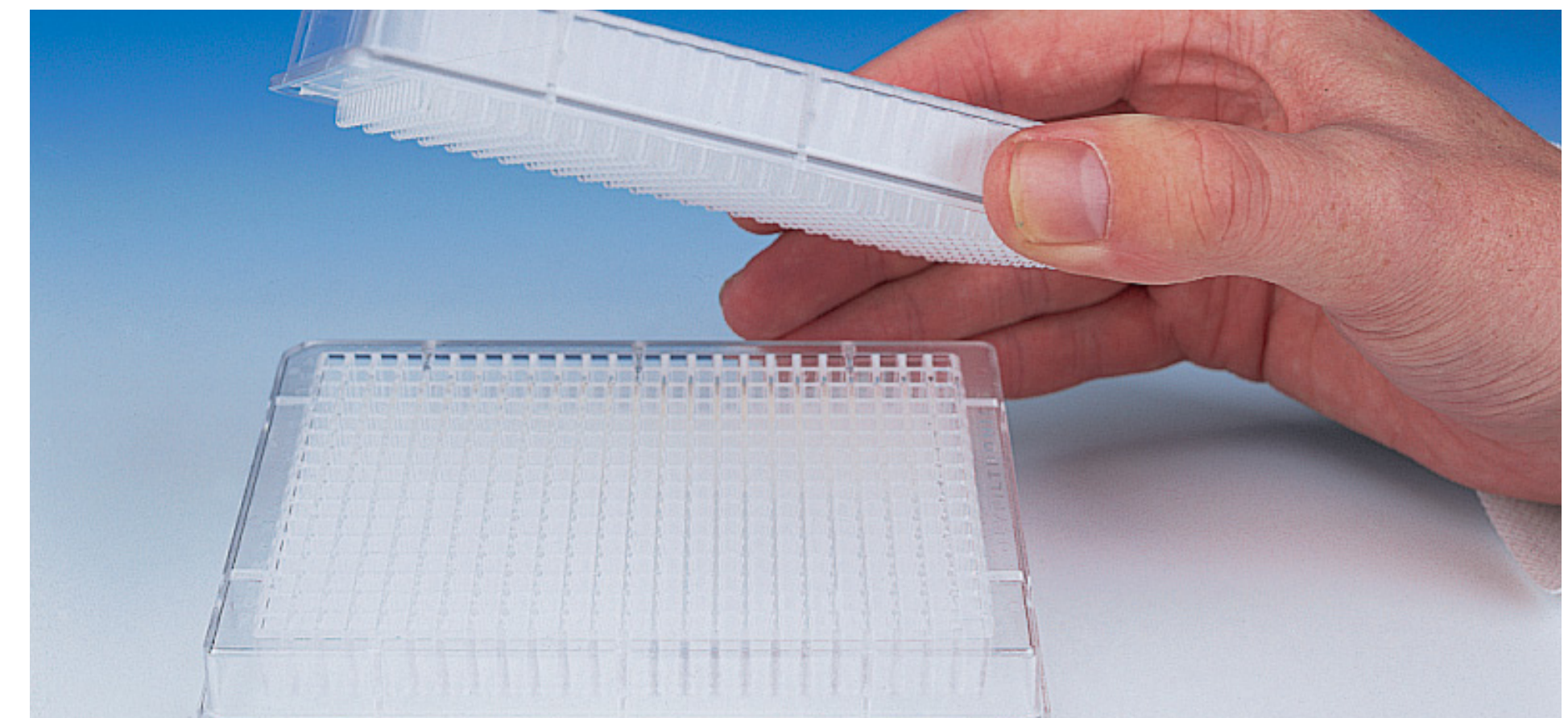
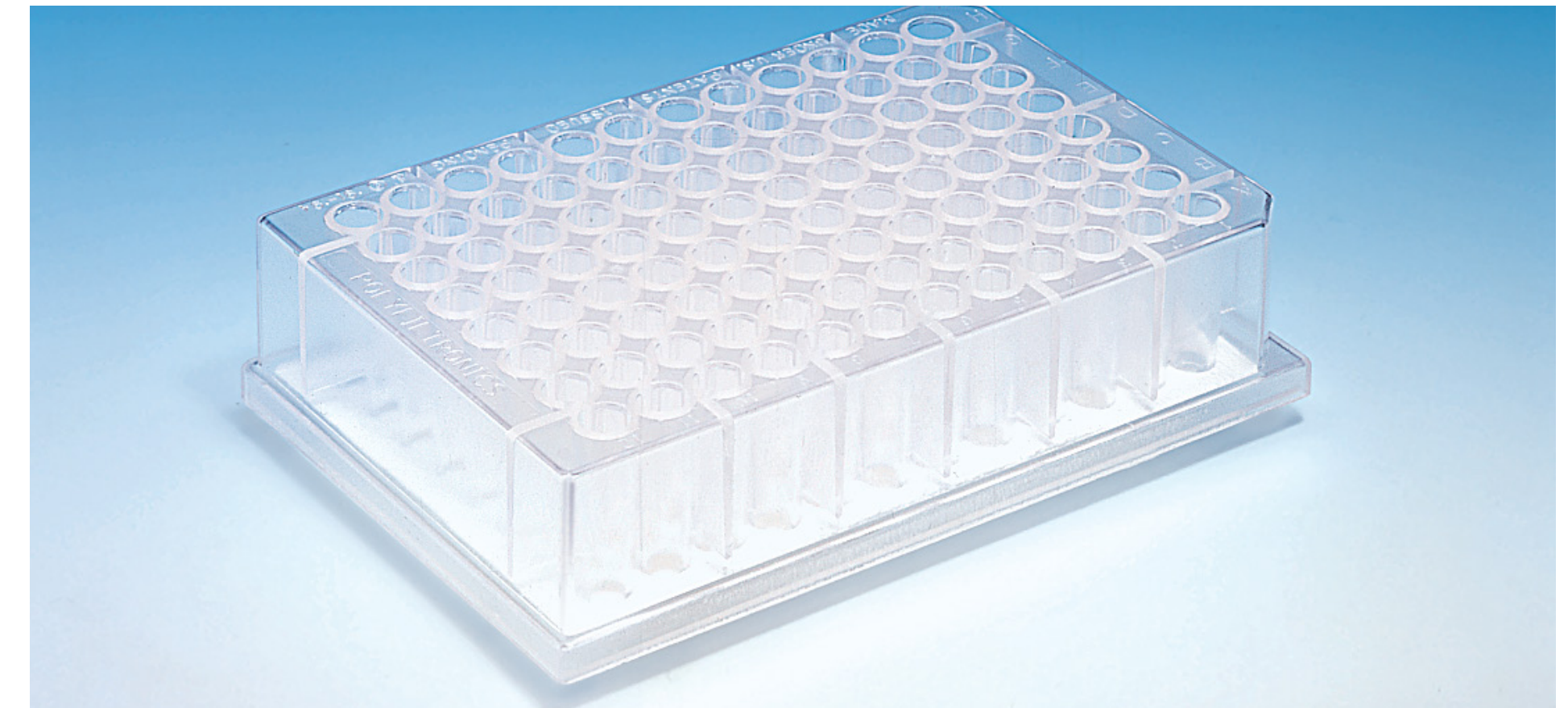

Plasmid miniprep plates

The preparation of plasmid DNA from bacterial culture is an extremely common procedure. The Plasmid miniprep plates simplifies the process, increasing throughput and improving the purity of plasmid DNA.

Features

- High purity DNA ready for sequencing, cloning, transformations and PCR
- Can be used with both vacuum and centrifuge techniques
- Easy to automate

Ordering information

Catalog number	Well format	Well volume	Plate material	Well bottom	Filter media	Irradiated with lid	Quantity/ case
Plasmid miniprep							
7700-2810	96	800 µl	Clear polystyrene	Filter, LDD*	DNA binding	No	25
Collection plate							
7701-5200	96	2 ml	Natural polypropylene	Round	—	No	25

* Long drip director

96-well lysate clarification UNIFILTER

The lysate clarification UNIFILTER can use either vacuum or a centrifuge. The vacuum process is significantly easier to automate with consistency across all wells. This method filters out cell debris to obtain plasmid DNA in the aqueous phase. Cytiva's filter technology is designed to deliver high particle retention and fast flow rates while producing a clean lysate. The lysate clarification UNIFILTER contains a dual membrane for faster flow and more precise clarification of bacterial lysates. The lysate clarification plates are important tools for high throughput plasmid DNA purification.

96-well DNA binding UNIFILTER

Plasmid DNA binding UNIFILTER works either as a stand-alone or as part of our high throughput miniprep system. Plasmid DNA is bound to the filter under chaotropic conditions, washed twice and then vacuumed dry on a vacuum manifold. The plasmid DNA is eluted by vacuum in a final volume of 100 μ l into a non-binding polypropylene collection plate using water or TE⁻¹ Buffer (10mM Tris 0.1mM EDTA pH 8). The DNA is ready to use and further ethanol precipitation is unnecessary. This should yield a final concentration of 50 to 100 ng/ μ l, depending on the original culture.

The Plasmid DNA Binding plate can be used with both vacuum and centrifuge techniques, making it a vital and flexible tool in every high throughput laboratory. The Plasmid DNA Binding plate is also available in a 384-well format.

Ordering information

Catalog number	Well format	Well volume	Plate material	Filter media	Quantity/ case
96-well lysate clarification UNIFILTER					
7700-0062	96	800 μ l	Clear polystyrene	Lysate clarification 0.45 μ m filter	25
96-well DNA binding UNIFILTER					
7700-2810	96	800 μ l	Clear polystyrene	DNA binding	25



4

UNIFILTER filtration microplates

The UNIFILTER microplates with filter-bottom wells are convenient and ready to use. Available in 24-, 96-, and 384-well formats, UNIFILTER microplates offer a choice of filter media to meet exact application requirements.

The drip director design of UNIFILTER microplates ensures precise collection of the filtrate or retentate to allow for further processing and analysis.

UNIFILTER microplates are available in a range of well volumes from 100 µl to 10 ml.

Features and benefits

- **Minimizes crosstalk**
Integral filter design minimizes well-to-well crosstalk
- **Economical**
Wide range of well volume options ensures efficient use of materials
- **Better control**
Choice of filter media allows control of the flow rate and retention characteristics
- **Versatile**
A broad range of filtration media is available including glass fiber, polypropylene, cellulose nitrate, cellulose acetate, nylon and ion exchange cellulose

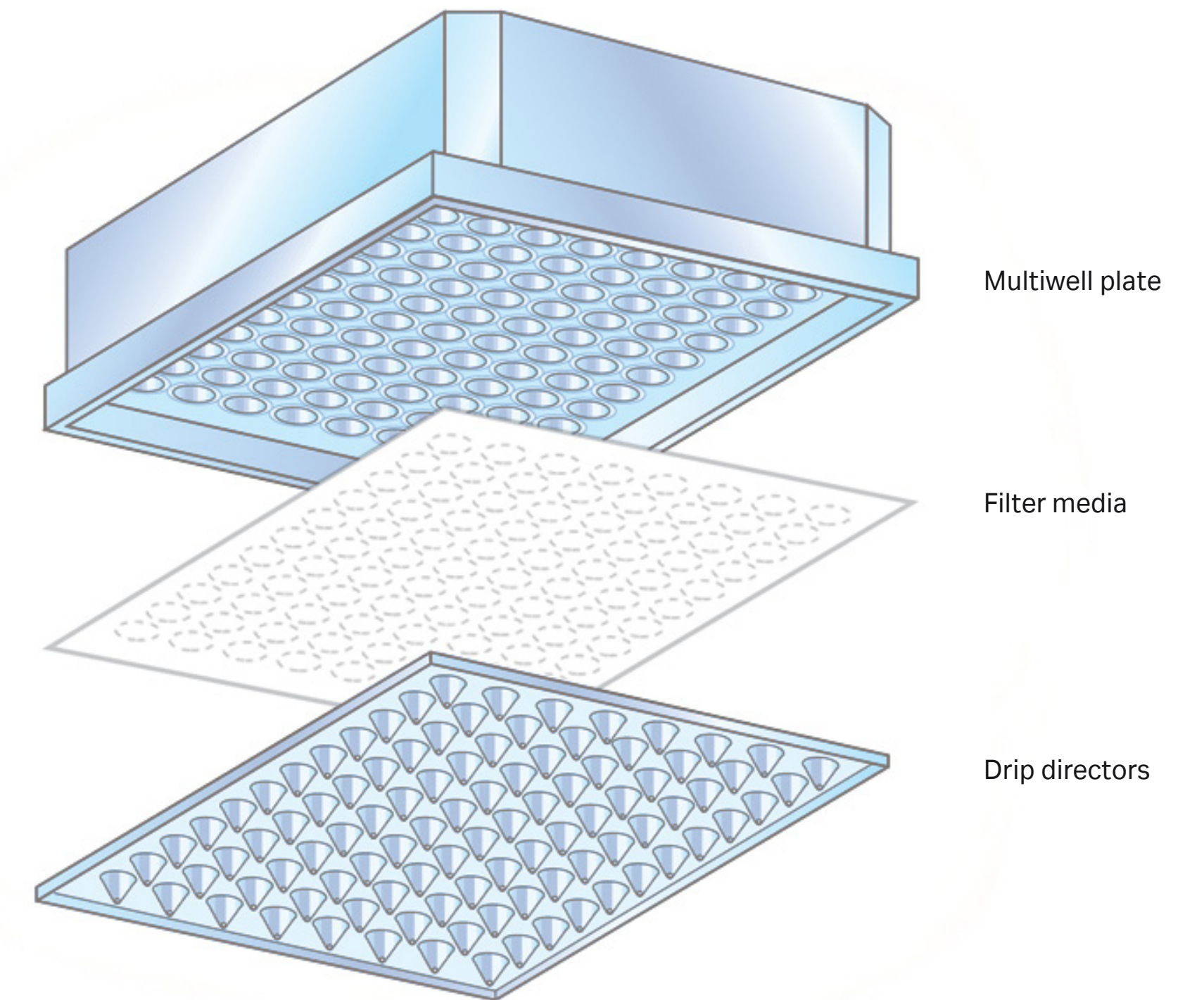

384-well 100 µl UNIFILTER

The 100 µl UNIFILTER allows a large enough sample for recovery after filtration. Beneath the filter plate are long drip directors designed to eliminate well-to-well contamination during the filtration process.

The 384-well filter plate is designed for DNA template clean-up, cell capture and for the removal of unwanted debris.

Ordering information

Catalog number	Well format	Well volume	Plate material	Filter media	Drip director	Quantity/ case
384-well 100 µl UNIFILTER						
7700-1101	384	100 µl	Clear polystyrene	GF/C	Long	50
7700-2110	384	100 µl	Clear polystyrene	DNA binding	Long	50

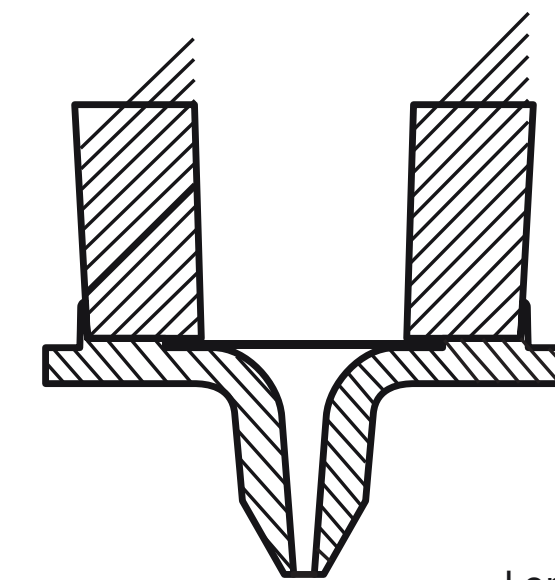
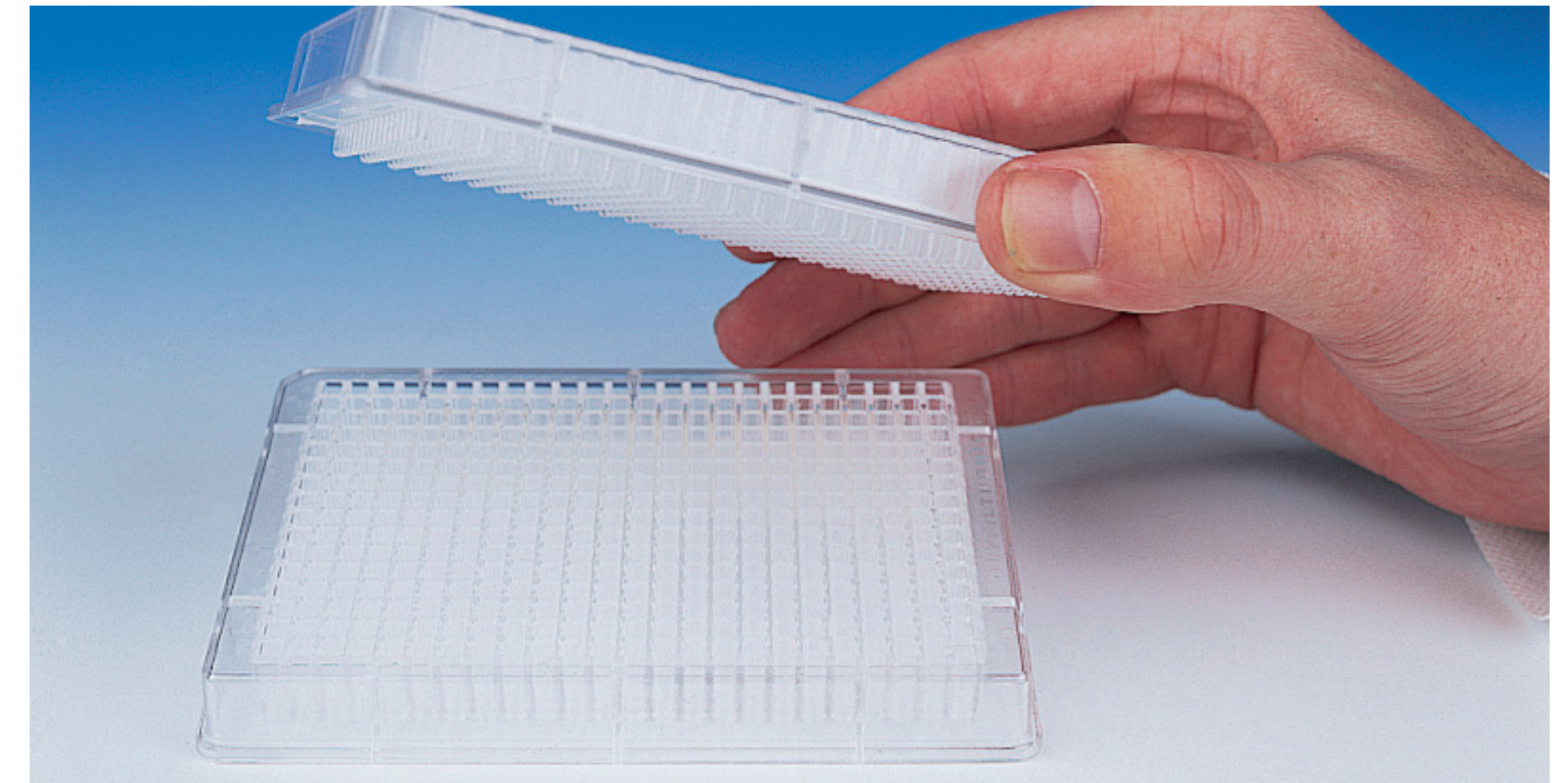

Long drip director

96-well 800 µl UNIFILTER

The long drip director in the 800 µl UNIFILTER plates is recommended for use in vacuum filtration and is typically used in purifications, isolations and separation of biomolecules, particularly DNA. The 800 µl well volume is designed for standard DNA plasmid minipreps (p. 11).

2 ml UNIFILTER

The 2 ml UNIFILTER microplate is widely used for applications that require larger sample or reagent volumes. Typically these applications include biomolecular purification by solid phase extraction and organic synthesis in combinatorial chemistry library generation. The glass-filled polypropylene construction of the 2 ml UNIFILTER microplate enables chemical and heat resistant operation. The long drip directors facilitate collection of filtrate without crosstalk.

Ordering information

Catalog number	Well format	Well volume	Plate material	Filter media	Drip director	Quantity/ case
96-well 800 µl UNIFILTER						
7700-2801	96	800 µl	Clear polystyrene	GF/C	Long	25
7700-2803	96	800 µl	Clear polystyrene	GF/B	Long	25
7700-2804	96	800 µl	Clear polystyrene	25-30 µm melt blown polypropylene	Long	25
7700-2805	96	800 µl	Clear polystyrene	0.45 µm PP membrane	Long	25
7700-2808	96	800 µl	Clear polystyrene	0.45 µm Cellulose acetate	Long	25
7700-2810	96	800 µl	Clear polystyrene	DNA binding	Long	25
7770-0062	96	800 µl	Clear polystyrene	25 µm melt blown polypropylene over 0.45 µm PP membrane	Long	25
96-well 2 ml UNIFILTER						
7700-7201	96	2 ml	Glass-filled polypropylene	GF/C	Long	25
7700-7206	96	2 ml	Glass-filled polypropylene	0.45 µm hydrophilic PVDF	Long	25
7700-7211	96	2 ml	Glass-filled polypropylene	GF/D	Long	25
7720-7236	96	2 ml	Glass-filled polypropylene	Protein precipitation fast flow	Long	5
24-well 10 ml UNIFILTER						
7700-9901	24	10 ml	Natural polypropylene	GF/C	Long	25
7700-9904	24	10 ml	Natural polypropylene	25-30 µm melt blown polypropylene	Long	25
7700-9905	24	10 ml	Natural polypropylene	1.0 µm PTFE	Long	25
7700-9917	24	10 ml	Natural polypropylene	10-12 µm melt blown polypropylene	Long	25
7700-9902	24	10 ml	Natural polypropylene	VFE	Long	25

10 ml UNIFILTER

The 10 ml UNIFILTER microplate is widely used for applications that require very large sample or reagent volumes. Typically these applications include biomolecule purification by solid phase extraction and organic synthesis in combinatorial chemistry library generation. The polypropylene construction of the filter plate permits chemical and heat-resistant operation. The long drip directors facilitate the collection of filtrate without crosstalk.



96 well 800 µl UNIFILTER

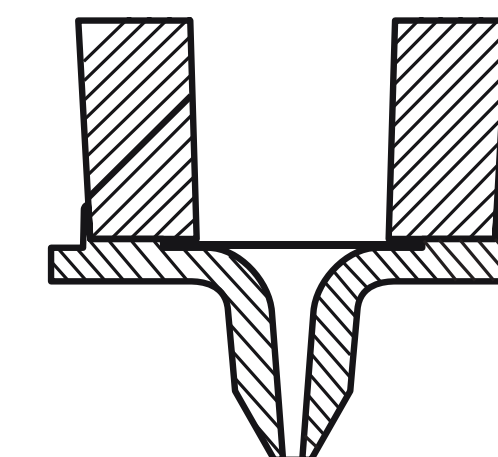

2 ml UNIFILTER

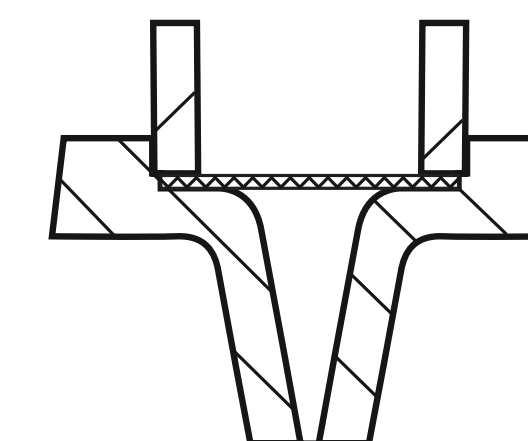

10 ml UNIFILTER

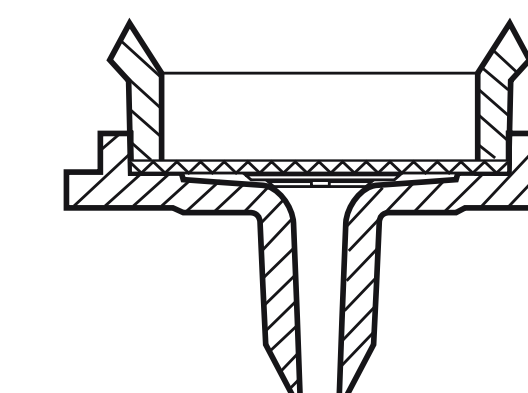

5

UNIPLATE collection and analysis microplates

UNIPLATE microplates

Cytiva offers a range of UNIPLATE collection microplates. Most UNIPLATE microplates conform to ANSI/SBS microplate standards and fit most microplate readers and automated plate handling devices. UNIPLATE collection microplates are suitable for a range of applications including simple filtrate collection when used in conjunction with our UNIFILTER microplates, as well as homogeneous assay techniques utilized in HTS.

Features and benefits

- **Range of volumes and well densities**
Choice of well volumes: 250 µl, 5 ml, and 10 ml
Choice of well densities: 24-, 48-, and 96-wells
- **Conforms to ANSI/SBS microplate standards**
Suitable for use with robotic handlers and centrifuge carriers

UNIPLATE “V” bottom microplate

The 96-well format UNIPLATE with “V” bottom is particularly suited for applications with small sample volumes. The vertical sides of the well, combined with the “V” design at the base of each well, ensure that all the material runs down the side walls and is channeled into the well base. The “V” bottom ensures maximum sample recovery typically $\geq 99\%$ liquid sample recovery is attained.

Ordering information

Catalog number	Well format	Well volume	Plate material	Well bottom	Irradiated with lid	Quantity/case
UNIPLATE microplates						
7701-5102	24	10 ml	Polypropylene	Round	No	25
7701-5110	24	10 ml	Polypropylene	Round	Yes	25
7701-5500	48	5 ml	Polypropylene	Flat (rectangular well)	No	25
7701-5200	96	2 ml	Polypropylene	Round	No	25
UNIPLATE “V” bottom microplate						
7701-3250	96	250 µl	White polystyrene	“V”	—	50



7701-5102

7701-5200



7701-5500

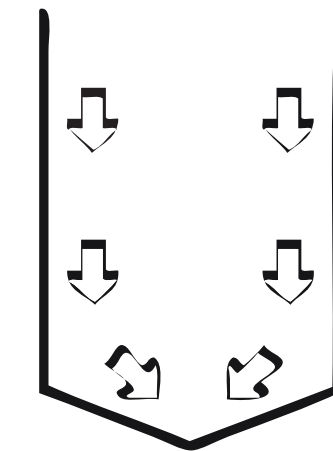

6

Seals and lids

Capmat

The flexible capmat individually seals the top of each well. A capmat may be used on either filter or collection microplates.

Lid

Suitable for use as dust covers and to prevent splashing or contamination when plates are being moved around the laboratory.

Seal

Seals are used to control humidity and reduce evaporation of samples. They prevent spills and contamination. Seals are self-sticking with inert adhesive.

Ordering information

Catalog number	Well format	Capmat material	Microplate compatibility	Quantity/case
Pierceable capmat				
7704-0105	96	Round format silicone	300, 750, and 800 µl microplates	50

Catalog number	Lid material	Quantity/case
Lid		
7704-1001	Clear polystyrene universal lid	100

Catalog number	Description	Quantity/case
Seal		
7704-0001	Clear polyester thin cold sealing film, adhesive backing, 0.05 mm thick	100



Capmat



Lid



Seal

7

Accessories

VacAssist vacuum assist frame

The VacAssist is a thin, transparent PTFE film stretched inside a light metal frame that fits on top of the UNIFILTER during the vacuuming process. If one well empties before the others, this device automatically seals the mouth of the empty well, allowing the other wells to evacuate.

Ordering information

Catalog number	Description	Quantity/case
UNIVAC 3 Vacuum to collect manifold accessory		
7705-0109	Replacement FKM o-rings for filter/collect manifold	5
VACASSIST Vacuum assist frame		
7705-0112	Vacuum assist (PTFE film) with frame	1



8

Filter selection guide

Filter media characteristics

Filter media	Flow rate*	Protein binding	Hydrophilic	Solvent resistance	Physical strength	Thermal resistance	General comments
Cellulose Nitrate (CN)	4	High	Yes	Poor	Brittle	< 125°C	Highly adsorptive membrane typically used for DNA/RNA/protein hybridization, also for ELISA and RIA based assays.
Cellulose Acetate (CA)	3	Low	Yes	Poor	Moderate	< 120°C	Typically used for low protein binding applications, good strength. General purpose microbiological filter.
Polypropylene (PP)	2	Negligible	No	Very good	Good	< 80°C	Typically used for prefiltration. Sensitive to gamma sterilization. Very low extractables, chemically inert.
Polyvinylidene fluoride (PVDF) Hydrophilic	4	Low	Yes	Good	Good	< 135°C	Low protein binding, good chemical resistance.
Glass Microfiber (GF)	5	Moderate	Yes	Very good	Poor	High	Wide range available. Typically used as absorptive or adsorptive wicking media and prefilters. Excellent particle retention and resistance to clogging. Used for DNA binding.

* Flow rate: 1 = low, 5 = high

Plate material chemical compatibility

Plate material	Polystyrene	Polypropylene
Acetic acid	R	R
Amino acids	R	R
Butyl alcohol	R	R
Ethanol	R	R
Hydrochloric acid	R (30%)	R
Methanol	R	R
Acetonitrile	NR	R
Chloroform	NR	R
Dichloromethane	NR	R
DMSO	NR	R
DMF	NR	R
Dioxane	NR	R
Methylene chloride	NR	R
Piperidine	NR	R
THF	NR	R
Toluene	NR	R
TFA	NR	R*

R = Recommended

NR = Not Recommended

* Room temperature, short term resistant

Filter media chemical compatibility

Solvent	CA	CN	GF	PP	PVDF
Acetic Acid 5%	L	R	R	R	R
Acetic Acid, Glacial	NR	NR	R	R	R
Acetone	NR	NR	R	R	NR
Acetonitrile	NR	NR	LR	R	R
Ammonia 6M	+	NR	R	R	LR
Amyl Acetate	NR	NR	R	R	LR
Amyl Alcohol	R	+	R	R	R
Benzene*	R	R	R	LR	R
Benzyl Alcohol*	LR	LR	R	R	R
Boric Acid	R	R	R	R	+
Butyl Alcohol	R	R	R	R	R
Butyl Chloride*	+	+	R	NR	R
Carbon Tetrachloride*	NR	R	R	LR	R
Chloroform*	NR	R	R	LR	R
Cyclohexanone	NR	NR	R	R	R
Chlorobenzene	+	R	R	+	R
Citric Acid	+	+	R	+	R
Cresol	NR	R	R	R	NR
Cyclohexane	R	R	R	R	R
Diethyl Acetamide	R	NR	R	R	NR
Dimethyl Formamide	NR	NR	R	R	NR
Dioxane	NR	NR	R	R	LR
DMSO	NR	NR	R	R	LR
Ethanol	R	NR	R	R	R
Ethers	LR	LR	R	R	LR
Ethyl Acetate	NR	NR	R	R	LR
Ethylene Glycol	LR	LR	R	R	R

Solvent	CA	CN	GF	PP	PVDF
Formaldehyde	LR	R	R	R	R
Freon TF	R	R	R	R	R
Formic Acid	LR	LR	R	R	R
Hydrochloric Acid Conc	NR	NR	R	LR	R
Hydrofluoric Acid	NR	NR	NR	LR	R
Hexane	R	R	R	R	R
Isobutyl Alcohol	R	LR	R	R	R
Isopropyl Alcohol	R	LR	R	+	+
Methanol	R	NR	R	R	R
Methyl Ethyl Ketone	LR	NR	R	R	R
Methylene Chloride*	NR	LR	R	LR	R
Nitric Acid Conc	NR	NR	R	NR	NR
Nitric Acid 6N	LR	LR	R	LR	LR
Nitrobenzene*	NR	NR	R	R	R
Pentane	R	R	R	R	R
Perchloroethylene	R	R	R	R	R
Pyridine	NR	NR	R	R	R
Phenol 0.5%	LR	R	R	R	R
Sodium Hydroxide 6N	NR	NR	NR	R	NR
Sulfuric Acid, Conc	NR	NR	R	NR	NR
Tetrahydrofuran	NR	NR	R	LR	R
Toluene*	LR	R	R	LR	R
Trichloroethane*	NR	LR	R	R	R
Trichloroethylene*	+	R	R	R	R
Water	R	R	R	R	R
Xylene	R	R	R	LR	R

R = Resistant; LR = Limited Resistance; NR = Not Recommended; + = Insufficient Data; * = Short Term Resistance of Housing.
The above data is to be used as a guide only. Testing prior to application is recommended.

[cytiva.com/whatman](https://www.cytiva.com/whatman)

Cytiva and the Drop logo are trademarks of Global Life Sciences IP Holdco LLC or an affiliate. UNIFILTER and Whatman are trademarks of Global Life Sciences Solutions USA LLC or an affiliate doing business as Cytiva.

© 2020 Cytiva

For local office contact information, visit [cytiva.com/contact](https://www.cytiva.com/contact)

CY14896-27Nov20-SG

