

USER MANUAL

DM0412

Low speed Centrifuge



Before using centrifuge, please carefully read this user manual for efficient operation and safety.

12301050

Ver.20180515

Contents

Safety Reminder.....	1
1. Intended use	3
2. Specifications	3
3. Declaration of Conformity	4
4. Required Operational Conditions.....	4
4.1 Basic operational conditions	4
4.2 Transport and storage conditions.....	4
5. Installation.....	5
5.1 Location.....	5
5.2 Connection of the power cord and grounding.....	5
6. Structure	6
8. Rotor Preparation	7
8.1 Prepare the samples.....	7
8.2 Inject the samples into tubes	7
8.3 Keep the tubes balanced.....	8
8.4 Inspect the rotor.....	8
8.5 Symmetrically load centrifuge tubes into rotor	8
9. Operation.....	8
9.1 Normal operation.....	8
9.2 RCF operation	10
9.3 Pulse operation	11
10. Maintenance	11
10.1 Cleaning	11
10.2 Rotor Installation.....	12
11. Troubleshooting.....	13
11.1 Possible problems and solutions.....	13
11.2 How to open the door	14
12. Instructions for the rotor and tubes.....	14
12.1 Rotor instructions	15
12.2 Tubes	16
13. Calculate RCF.....	17
14. Returning and Disposal	17
14.1 Returning Devices	17
14.2 Disposal.....	17
15. Ordering information.....	18
16. Warranty	18
16.1 Warranty of centrifuge.....	18
16.2 Warranty of the rotor	18
After-sales service	19

Safety Reminder

Common safety precautions

Carefully read the following safety precautions for a thorough understanding.

- Follow the instructions and procedures described in this manual to operate this centrifuge safely.
- Carefully read all safety messages in this manual and the safety instructions on the centrifuge.
- Safety messages are labeled as indicated below. They are in combination with signal words of “WARNING” and “CAUTION” with the safety alert symbol  to call your attention to items or operations that could be dangerous to you or other persons using this centrifuge. The definitions of signal words are as follows:



WARNING: Personal Danger

Warning notes indicate any condition or practice, which if not strictly observed, could result in personal injury or possible death.



CAUTION: Possible damage to centrifuge

Caution notes indicate any condition or practice, which if not strictly observed or remedied, could result in damage or destruction of the centrifuge.

NOTE: Notes indicate an area or subject of special merit, emphasizing either the product’s capability or common errors in operation or maintenance.

- Do not operate the centrifuge in any manner not described in this User Manual. When in doubt or have any troubles with this centrifuge, ASK FOR HELP.
- The precautions described in this User Manual are carefully developed in an attempt to cover all the possible risks. However, it is also important that you are alert for unexpected incidents. Be careful operating this centrifuge.



WARNING

- This centrifuge is not explosion-proof. Never use explosive or flammable samples.
- Do not install the centrifuge in or near places where inflammable gases are generated or chemicals are stored.

- Do not place dangerous materials within 30cm of the centrifuge.
- Prepare all necessary safety measures before using samples that are toxic, radioactive or contaminated with pathogenic micro-organisms. Use of these is at your own responsibility.
- If the centrifuge, rotor and accessories that have been contaminated by solutions with toxic, radioactive or pathogenic materials, clean it according to the decontamination procedure as specified.
- If you require service at site, please sterilize and decontaminate the centrifuge in advance, and then notify the service center the details of the materials and procedure.
- To avoid electrical shocks, insure hands are dry before handling the power cord or turning on/off the power switch.
- For safety purposes, do not enter within 30cm around this centrifuge when it is in operation.
- **While the rotor is rotating, never release the door lock.**
- Unauthorized repairs, disassembly, or modifying the centrifuge except by our service center are strictly prohibited.



CAUTION

- **This centrifuge must be located on a firm and level table.**

DEBALANSARE

- **CENTRIFUGA TREBUIE AMPLASATA ORIZONTAL PE O MASA DREAPTA /PLATA**
 - **CENTRIFUGA DISPUNE DE 4 PICIORUSE DIN SILICON CARE SE LIPESC DE MASA SI NU PERMIT BALANSAREA IN TIMPUL LUCRULUI**
 - Make sure the centrifuge is horizontal before running.
 - Do not move or relocate the centrifuge when it is running.
 - If fluid spills in the rotor chamber, please promptly clean and dry with a dry cloth to avoid sample contamination.
 - Ensure to remove any objects and fragments of the tubes dropped inside the rotor chamber before if an abnormality is found.
running the centrifuge.
 - Cautions with rotor
Make sure to run it below the allowable maximum speed.
 - (1) Always check for corrosion and damage on the rotor surface before using it. Do not use the rotor
 - (2) Do not set the speed beyond the allowable minimum speed of the rotor kits (rotor and adapters).
 - (3) Do not exceed the allowable imbalance.
 - (4) Use the rotor and tubes within their actual capacities.
- If any abnormal condition occurs during operation, please stop it immediately and contact our service center. Notify the service center is a warning code if displayed.
- Vibrations are likely to damage the centrifuge, contact our service center if abnormality observed.

1. Intended use

This device is a medical product (laboratory centrifuge) within the context of the IVD Directive 98/79/EC. The centrifuge is used for the centrifugal separation of human blood or urine samples in the rotor in accordance with EN ISO 12772. Operator should be trained before using the centrifuge. Detailed operation, please refer to the **User Manual below**.

2. Specifications

Maximum speed	4500rpm(300-4500rpm), increment: 100rpm	
Maximum RCF	2490×g, increment: 100×g	
Maximum capacity	10ml×12, 15ml×8	
Timer	30seconds -99minutes-HOLD, continuous operation	
Noise	56dB(A)	
Driving Motor	Brushless DC motor	
Safety devices	Door interlock, Over-speed detector, Error code runtime display	
Power requirements	Single-phase, 110V-240V, 50Hz/60Hz, 3A.	
Ambient condition		
-Set-up site	Indoor only	
-Altitude	Up to 2000 m above sea level	
-Ambient temperature	2°C ~ 40°C	
-Humidity	80%	
-Excess-voltage category	II	
-Pollution degree	2	
Device protection class	I	
EMC		
-Emitted interference,	EN/IEC 61326-1	FCC Class A
Interference immunity	Class A	
Dimensions (mm)	(L) 280× (W) 364× (H) 266	
Weight	6kg	
Additional features	Speed/RCF switch, Pulse operation, LCD display of runtime status, buzzer notification & alert	

3. Declaration of Conformity

Construction in accordance with the following safety standards:
EN 61010-1
EN 61010-2-020
EN 61010-2-101
Construction in accordance with the following EMC standards:
EN 61326-1/ FCC Part 15 Subpart B/ IECS 001
EN 61326-2-6:2006
Associated EU guidelines:
EMC directive: 2014/30/EU
IVD directive: 2014/35/EU
IVD directive: 98/79/EC
This ISM device complies with Canadian ICES-001. Cet appareil ISM est conforme à la norme NMB-001 du Canada.

Changes or modifications not expressly approved by the party responsible for compliance could void the user's authority to operate the equipment.

NOTE: This equipment has been tested and found to comply with the limits for a Class A digital device, pursuant to Part 15 of the FCC Rules. These limits are designed to provide reasonable protection against harmful interference when the equipment is operated in a commercial environment. This equipment generates, uses, and can radiate radio frequency energy and, if not installed and used in accordance with the instruction manual, may cause harmful interference to radio communications. Operation of this equipment in a residential area is likely to cause harmful interference in which case the user will be required to correct the interference at his own expense.

4. Required Operational Conditions

4.1 Basic operational conditions

- (1) Power: 110V-240V, 50Hz/60Hz, 3A.
- (2) Ambient temperature: 2°C~40°C.
- (3) Relative humidity: ≤80%.
- (4) No vibration and airflow around.
- (5) No electric dust, explosive and corrosive gases around.

4.2 Transport and storage conditions

- (1) Storage temperature: -40°C~55°C.
- (2) Relative humidity: ≤93%.

5. Installation

This section describes the instructions that you should abide when install the centrifuge to ensure your safety and the optimum performance. Before moving the centrifuge, the rotor must be removed.

 **WARNING**

- Improper power supply may damage centrifuge.
- Make sure the power source conforms to the required power supply before connecting.

5.1 Location

(1) Place this centrifuge on a firm, flat and level surface, ensure the four feet of this centrifuge stand on the counter firmly. Avoid installing on a slippery surface or surface prone to vibration.

(2) Ideal ambient temperature is $20^{\circ}\text{C}\pm 5^{\circ}\text{C}$, avoid placing the centrifuge in direct sunlight if temperature exceeds 30°C .

(3) Keep clear of the centrifuge at least 10cm on both sides and at least 30cm behind it to guarantee the cooling efficiency.

(4) Keep away from heat or water to avoid sample temperature issues or centrifuge failures.

5.2 Connection of the power cord and grounding

 **WARNING**

- To avoid electrical shocks, ensure your hands are dry when touching the power cord.
- This centrifuge must be grounded properly.

An minimum 10A outlet providing a sufficient ground is required, and this must meet local safety requirements.

6. Structure

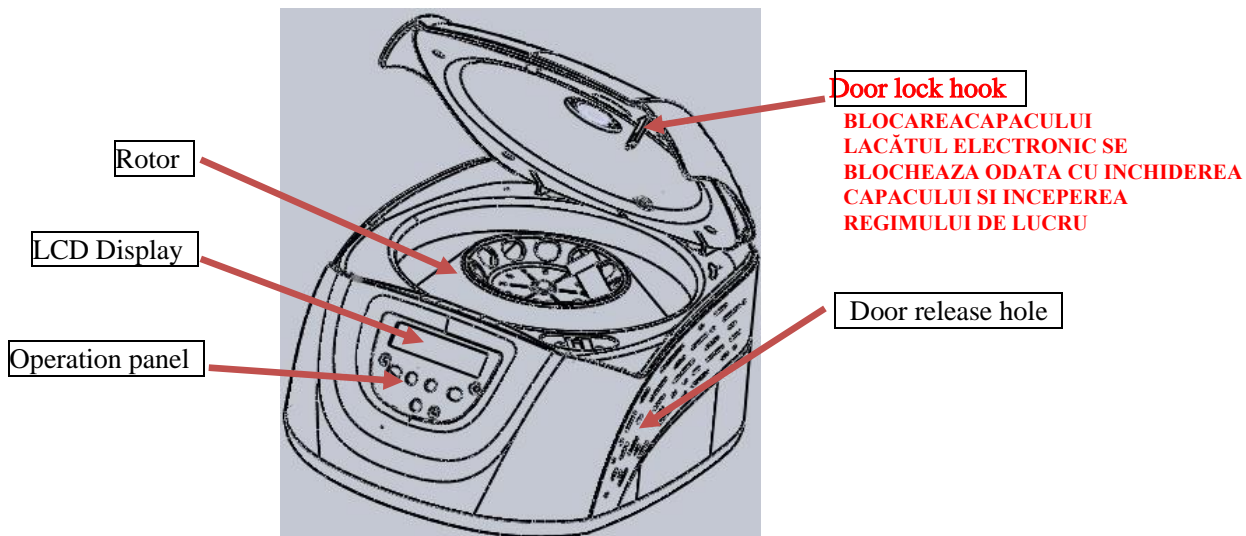

Figure 6-1 Front view of the centrifuge

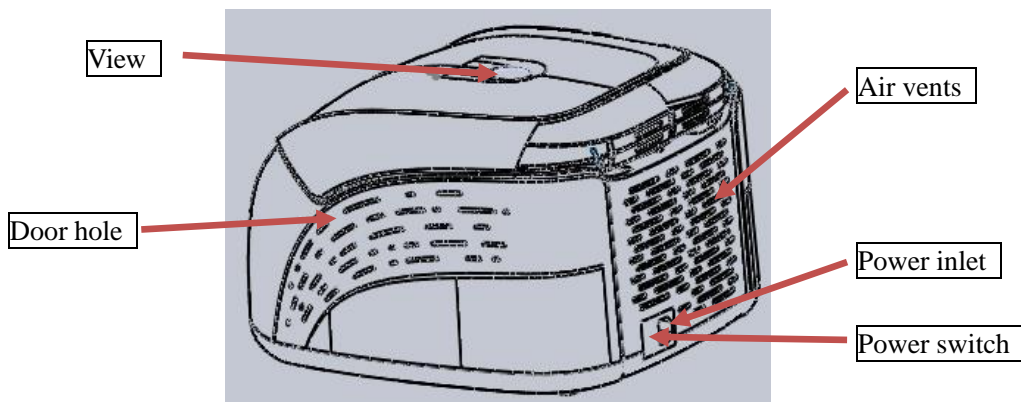

Figure 6-2 Rear view of the centrifuge

7. Operation panel

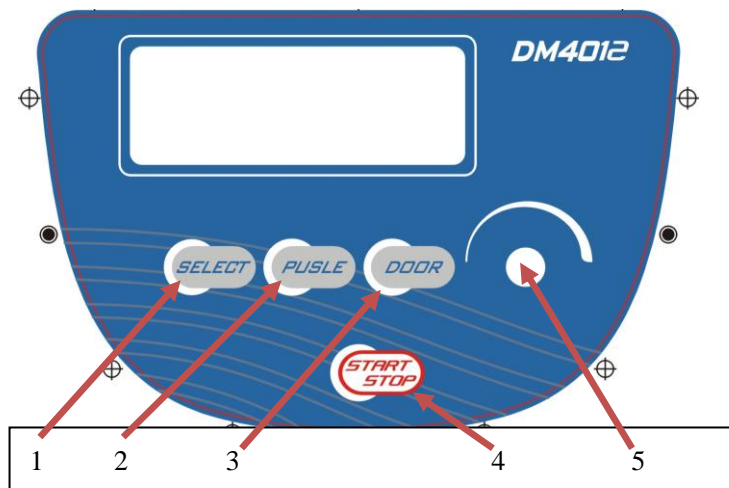







Figure 7-1 Operation panel

Item	Symbol	Name	Function
1		Select button	Press the button to choose the program which you want to modify.
2		Pulse button	The speed can be accelerated and held at the speed when pressing Pulse on.
3		Open/ lock button	Press the button to open the door The button is not available when the centrifuge is running.
4		Start/ Stop button	Press the button to start running. The centrifuge will brake to stop running if pressed during centrifugation.
5		Parameter button	Clockwise rotate to increase program values. Rotate anti-clockwise to decrease parameter values. Press the button, shift between speed and RCF display.

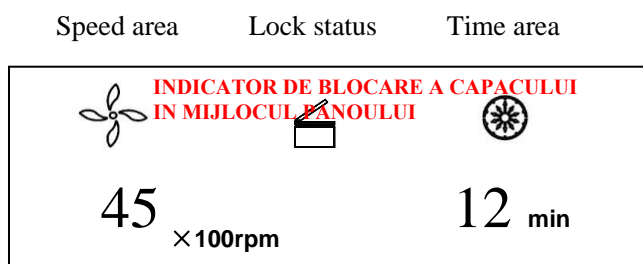



Figure 7-2 The main interface

Main interface is as figure 7-2. The speed is set to be 4500rpm, the door lock is released and the running time is 12 minutes. When speed symbol  is rotating, this indicates the centrifuge is running. If the rotation is faster, the speed is higher. Temperature of chamber is displayed and cannot be controlled. Time symbol  displays the ratio of working to time setting. The total time setting is divided into 10 sections.

8. Rotor Preparation

8.1 Prepare the samples

8.2 Inject the samples into tubes

CAUTION

- Do not overload samples into the centrifuge which will cause leaking.

- Do not exceed the actual capacity allowed in the user manual.

8.3 Keep the tubes balanced

- Although the centrifuge can accept sample balancing by eye, we recommend that you keep this centrifuge in a well-balanced condition to extend its life expectancy.
- Never intentionally run the centrifuge under an unbalanced condition even though the allowable imbalance is not exceeded.

8.4 Inspect the rotor

Check the rotor for corrosion or scratches before using.

 CAUTION

- If any abnormality such as corrosion or scratches are found, stop using the rotor and contact our service center.
- Only manufacturer's rotors must be used with the unit.

8.5 Symmetrically load centrifuge tubes into rotor

 CAUTION

- Make sure the rotor lid is securely fixed on the rotor, as well as the rotor and shaft are tightened. Otherwise, the rotor may be moved off while rotating and cause damage to the centrifuge and rotor.
- Firmly tighten the rotor lid to the rotor.

9. Operation

 CAUTION

- Do not push or lean against the centrifuge while it is running.
- Do not run the centrifuge when fragments or sample solutions are left in the centrifuge chamber. Always keep the centrifugal chamber clean.
- If the centrifuge makes strange noise during operation, stop it immediately and contact our service center. Notify them of the warning code if displayed.

9.1 Normal operation

Turn on the power switch, centrifuge will display the running interface last time after passing the self-diagnostic checks, see figure 9-1 below:

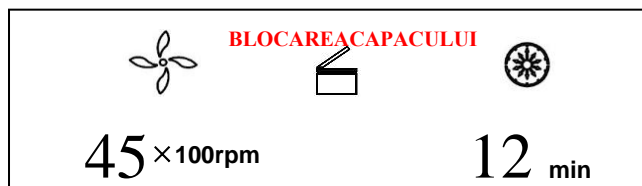











Figure 9-1 the last running interface

- Speed: 4500rpm. Running time: 12 minutes.
- The door lock is released.



1) Set the operation programs

Press the  button to select required program. The parameter can be modified when the program is flashing. Rotate the program button clockwise  to increase parameter value. Rotate the program button clockwise  to decrease parameter value. Rotate the program button  faster, and the parameter value will increase faster. The minimum speed increment is 100 rpm, the minimum time increment is 1 second.

(1) Set the speed

- Press the select button  until the speed rpm is displayed.
- When the speed button is selected, the speed symbol will flash the speed value.
- The minimum speed value you can set 500rpm, the minimum increment is 100 rpm.
- Rotate program button clockwise  to increase speed value. Rotate the program button anti-clockwise  to decrease speed value.
- You can speed-up set the speed value by rotating program button  quickly.
- There is a circulating function to increase/decrease the speed values. Rotate the program button clockwise  to change settings from small → large → maximum → minimum. Rotate the program button anti-clockwise  to change settings from large → small → minimum → maximum.

(2) Set the time



- Press select button , time value flashes in the time setting mode.
- Rotate the program button  to set running time from 30 seconds to 99 minutes.
- When the time displays HD, this is a continuous running mode.

2) Start the operation

(1) Press button to start running

- The door must be locked before rotor starts spinning.
- Timer will operate once the speed setting value is reached, the screen displays the remaining run time.

(2) View and modify the operation programs

- Operation programs can be modified after the centrifuge reaches the set speed.
- Pressing the select button , returns the display to the program interface and displays setting programs. Press the select button  to the desired program. When flashing, rotate parameter button  to modify values. Release the button after 5 seconds, and the centrifuge will return to normal operation mode and run according to the new value.
- If the set time value has been modified, the operation time is not affected and will continue.

(3) Warning display

- If an error occurs during the operation, the centrifuge will brake to stop automatically, and display the error code on the time/display area. The error code can be checked in the table 11-1, and corrective actions can be applied accordingly.

3) End the operation

(1) The centrifuge will brake when it reaches the set time or  button is pressed.

- When the rotor stops rotating, the centrifuge will start beeping to alert the operation has finished.

(2) Open the door

- The door can be released automatically when the operation has stopped.
- With the door closed, you are able to press the  button to open it.
- After ending the operation, the program will store the setting parameters of this operation, and will recall these parameters when restarting the program.

(3) Open the door and take out the rotor and samples.



9.2 RCF operation

(1) Turn on the power switch

(2) Set a RCF (Relative Centrifugal Force) value

 CAUTION
--

- Do not exceed the allowable maximum RCF value of the rotor and adapters.

- Press the select button  and choose speed unit $\times g$, the speed symbol will flash into RCF value input status.
- If no button is pressed after the speed value has flashed after 5 seconds, the input mode will be shut down.
- Rotate program button  to input a RCF value, RCF increment is $10\times g$.

(3) Set operating conditions

The other operation, please refer to the section 8.1.

9.3 Pulse operation

This function is used to remove the residual samples adhered to the interior of the tubes or for quick spins.

Note: The button works only while the rotor stopped and the door is locked.

(1) Turn on the power switch and load the rotor to the shaft, tighten the rotor lid and make sure it is in secured position, and then close the door.

(2) The centrifuge goes into preparation mode and displays last running values.

(3) Press  knob and hold, the centrifuge will speed up to the setting speed. While releasing the

 knob during acceleration, the centrifuge will start to decelerate and stop.

10. Maintenance

10.1 Cleaning

CAUTION

- If do not follow the recommended instructions for cleaning or disinfecting this may damage the centrifuge.

(1) Centrifuge

- If the centrifuge is exposed to ultraviolet rays for a long time, the color of the door may be changed or the label may be peel off. After using, cover the centrifuge with a piece of cloth to protect it from direct exposure.
- If the centrifuge needs cleaning, clean it with a cloth or sponge moistened with a neutral detergent solution.
- Sterilize the centrifuge by wiping with a cloth moistened with 70% ethanol solution.

(2) Rotor chamber

CAUTION

- Do not directly pour water, neutral detergent or disinfectant solution into the rotor chamber, otherwise fluids may leak into the drive units and cause corrosion or deterioration to the bearings.

- If the rotor needs cleaning, clean with cloth or sponge moistened with a neutral detergent solution.

Sterilize the centrifuge by wiping with a cloth moistened with 70% ethanol solution.

(3) Drive shaft

- We recommend regular maintenance for drive shaft. You can wipe the drive shaft with soft cloth, and then apply a thin coat of silicon grease.

(4) Door

- Clean and sterilize the door using the same method as the section (1) above.

(5) Rotor

- To prevent corrosion, remove the rotor from rotor chamber. If not in use for a long term, then detach the rotor lid and turn upside down to dry the tube holes and keep clean.
- For sample leaks in the rotor, rinse the rotor with water. Apply a thin coat of silicon grease to the rotor when it is completely dry.
- The rotor should be checked every 3 months to ensure the tube and rotor holes keep are clean and apply a thin coat of silicon grease.

10.2 Rotor Installation

(1) Installation

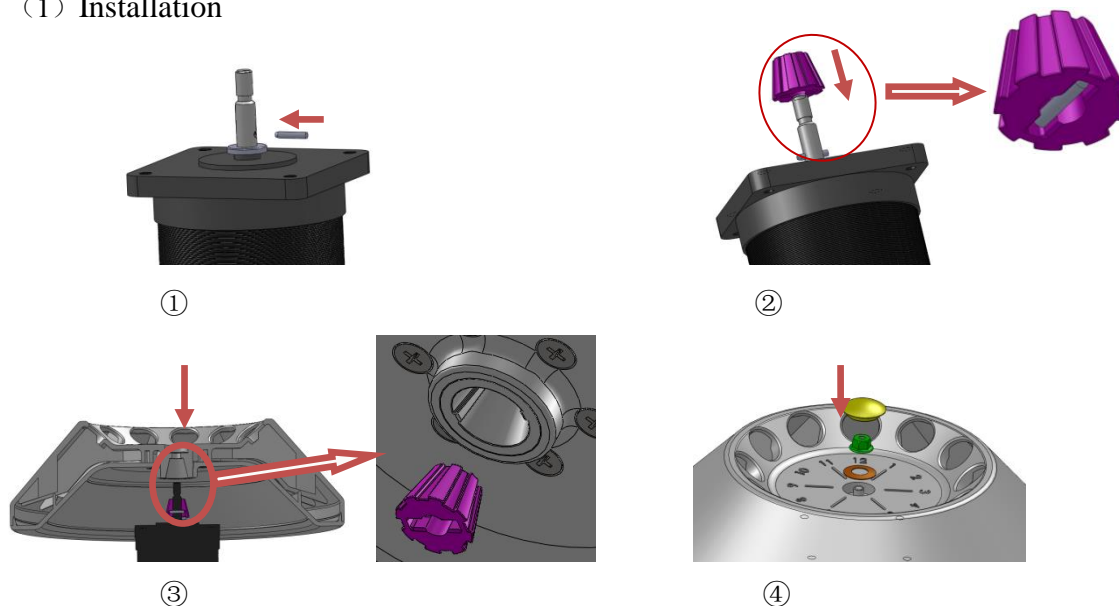

(2) Adjustment

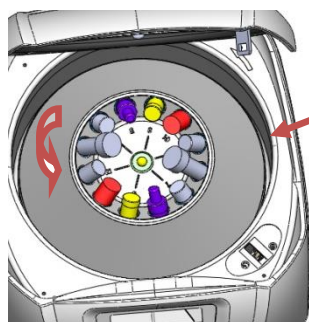

Observe here!

Before lock the rotor, rotate it, and observe carefully if there is obvious vibration, if so, please take off the rotor, turn some angle and install it again, until the rotor rotates smoothly, then, lock it firmly.

11. Troubleshooting

11.1 Possible problems and solutions

This centrifuge has a self-diagnostic function. If a problem occurs, an error/warning code will be displayed on the time display screen, and the operator can determine the malfunction with the alarm code below.

Symptom	Causes	Solutions	
Nothing appears on the screen when the POWER is turned on.	<ul style="list-style-type: none"> • Building power circuit breaker trips. 	<ul style="list-style-type: none"> • Remove the trouble and turn on the POWER. 	
Abnormal vibration	<ul style="list-style-type: none"> • Rotor do not match with spindle • Samples are imbalance 	<ul style="list-style-type: none"> • Install again the rotor • Weighting scales, install symmetrically 	
Alarm code appeared on the time display screen	E-02 Door fault	<ul style="list-style-type: none"> • The door opened in running. • The  button is pressed while the door opening. 	<ul style="list-style-type: none"> • Close the door immediately. • Close the door, and then start to operate.
	E-06 Set wrong speed	<ul style="list-style-type: none"> • The setting speed exceed the allowable range. 	<ul style="list-style-type: none"> • Modify the speed value.
	E-10~86	<ul style="list-style-type: none"> • Read the service manual 	<ul style="list-style-type: none"> • Contact with service center

Table 11-1 Possible problems and solutions

- Alarm codes E-1~E-9 are related to incorrect operation/programming. You can continue running the centrifuge after implementing corrective procedures.

11.2 How to open the door

1) In the case of power on

 CAUTION

- The door just can be opened while the power is on and rotor stops rotating.

- (1) Turn on the power switch, release the door automatically.
- (2) The door will be released automatically once the operation is finished.
- (3) It is available to release the door by press  button once the rotor stops.

2) In the case of power outage

The door cannot be opened automatically if there is a power outage. It is available to be opened manually as follows.

- (1) Ensure if the rotor has stopped rotating.
- Listen carefully to ensure no rotating sound can be heard.
 - (2) Insert a screw driver into a hole to open door.
 - Holes are located on the left and right sides of the unit.
 - Insert a screw driver into the two holes and push forward to release the door.

12. Instructions for the rotor and tubes

 CAUTION

- Read the instructions thoroughly, to properly load and use rotor.
- Do not exceed the allowable maximum speed of rotor, tube and adapters etc. Ensure the allowable maximum speed of adapters is lower than the rotor's maximum speed.

12.1 Rotor instructions

1) Rotor structure

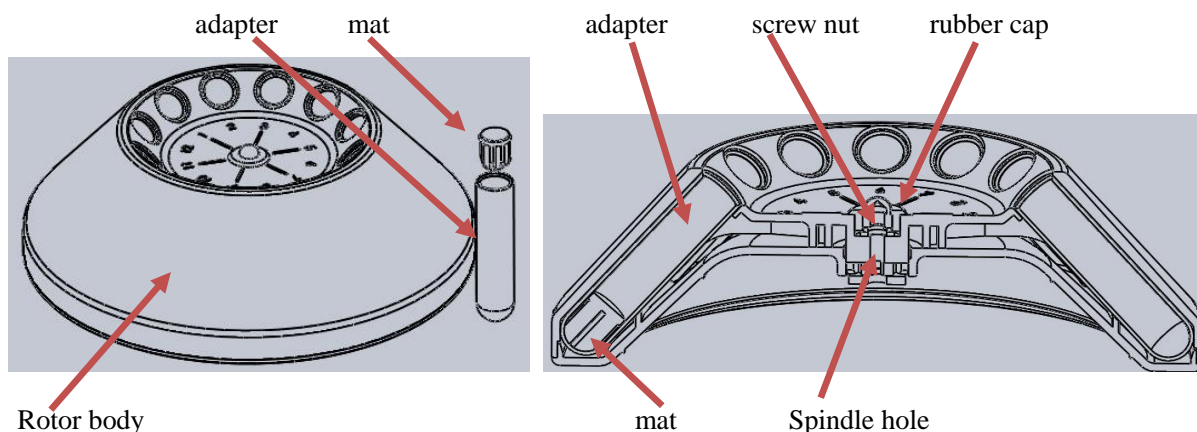

Figure 12-1 The rotor structure

2) Available rotors and adapters

Rotor type	Tubes	Tubes Per Rotor	Dimension (Φ×L mm)	Adapters	Maximum speed (rpm)	Radius cm	Maximum RCF (×g)
A12-10P	15ml con	8	17×120		4500	11	2490
	1.5-5ml vacu	12	13×82	A10P15 mat	4500	9.8	2218
	4-7 ml vacu	12	13×106	A10P15	4500	11	2490
			16×75	A10P15 Mat		9.8	2218
	8.5-10 ml vacu	12	16×107	A10P15	4500	11	2490
	2.7-3 (EU) ml collection tube	12	11×66	A10P15 mat	4500	9.8	2218
	7.5-8.2 (EU) ml collection tube	12	15×92	A10P15	4500	11	2490

Table 12-1 Rotors and adapters

3) Notice

- The centrifuge rotor can separate samples with a density lower than 2.0g/ml. If the samples density is over 2.0g/ml, please calculate allowable speed depending on the following formula.

$$\text{allow speed}(rpm) = \text{max speed} \times \sqrt{\frac{2.0(g/ml)}{\text{sample density}(g/ml)}}$$

4) Autoclaving

A12-10P rotor is made of plastic, cannot be high-pressure sterilization and UV irradiation, only ordinary sterilization can be used.

12.2 Tubes

1) Cleaning and sterilizing tubes

O: Applicable X: Inapplicable

Conditions		Materials	PA	PC	PP
Cleaning	Cleaning fluids	Acidic (pH5 or lower)	X	X	X
		Acidic (higher than pH5)	O	O	O
		Alkaline (higher than pH9)	O	X	O
		Alkaline (pH9 or lower)	O	O	O
		Neutral (pH7)	O	O	O
		Warm water(up to 70°C)	O	O	O
	Ultrasonic cleaning	Neutral detergent (pH7)	O	O	O
Sterilization	Autoclaving	115°C (0.7kg/cm ²) 30minutes	O	O	O
		121°C (1.0kg/cm ²) 20 minutes	X	O	O
		126°C (1.4kg/cm ²) 15 minutes	X	X	X
	Boiling	15 to 30 minutes	O	O	O
	Ultraviolet sterilization	200-300nm	X	X	X
	Gas sterilization	Ethylene oxide	O	X	O
		Formaldehyde	O	O	O

PA: Polyallomer PC: Polycarbonate PP: Polypropylene

Table 12-2 Cleaning and sterilizing conditions for tubes

2) Cleaning PC tubes

PC material is low in chemical resistance against alkaline solutions. Avoid using neutral detergents with pH higher than 9. Note that pH of some neutral detergents are still higher than 9 even if diluted according to the manufacturer's instructions. Use detergent with its pH between 7 and 9.

3) Autoclaving PA、PC and PP tubes

PA begins softening at about 120°C, PC and PP at about 130°C. Autoclave PA tubes at 115°C (0.7kg/cm²) for 30 minutes, PC and PP tubes at 121°C (0.1kg/cm²) for 20 minutes. If a certain temperature is exceeded, the tubes may be deformed.

When use a sterilizing chamber, please operate as follows:

(1) Place tubes in vertical position, mouths upward. If tubes are placed sideways, they may deform into an oval shape due to gravity.

(2) Remove locking nut and lid to prevent from deformation or rupture.

(3) Wait until the sterilizing chamber cools down to the room temperature before removing tubes.

4) Conditions and life expectancy of tubes

The life expectancy of plastic tubes depends on the characteristics of samples, speed of the rotor used, temperature applied and so on. When the plastic tubes are used for ordinary aqueous samples (pH between 5.0 and 9.0), their life expectancies are defined as follows.

Be operated at the maximum speed:

High quality tubes (PA、PC、PP): 30-50 operations

Ordinary tubes(PA、PC、PP): around 10 operations (Using in low speed can extend the tube life) .

Life expectancy of tubes also depends on the pretreatment conditions such as cleaning and sterilization, lifetime can be cut down.

Notice: Do not use damaged or cracked tubes.

13. Calculate RCF

An RCF can be determined with the following calculation formula.

$$RCF=1.118 \times r \times n^2 \times 10^{-5}$$

r—rotating radius, unit: cm; n—rotating speed, unit: rpm

14. Returning and Disposal

14.1 Returning Devices



Before returning the device, a transport securing device has to be installed.

If the device or its accessories are returned back, in order to provide protection for people, the environment and materials, it has to be decontaminated and cleaned before being shipped.

14.2 Disposal

Before disposal, the device must be decontaminated and cleaned to protect people, the environment and property. When you are disposing of the device, the respective statutory rules must be observed.

Pursuant to guideline 2002/96/EC (WEEE), all devices supplied after August 13,2005 may not be disposed as part of domestic waste. The device belongs to group 8 (medical devices) and is categorized in the business-to-business field.

The icon of the crossed-out trash can shows that the device may not be disposed as part of domestic waste. The waste disposal guidelines of the individual EC countries might vary. If necessary, contact your supplier.

15. Ordering information

Cat. No.	Model	Descriptions
913023410000	DM0412	Clinical Centrifuge, with A12-10P rotor kits, US plug, 110-240V/50/60Hz
913123410000	DM0412	Clinical Centrifuge, with A12-10P rotor kits, Cn plug, 110-240V/50/60Hz
913223410000	DM0412	Clinical Centrifuge, with A12-10P rotor kits, Euro plug, 100-240V/50/60Hz
913323410000	DM0412	Clinical Centrifuge, with A12-10P rotor kits, UK plug, 110-240V/50/60Hz
Accessories		
19200316	A12-10P	Rotor kits, 4500rpm, 15ml*8, used with DM0412
19200317	A10P15	rotor adapter, used with A12-10P, 12pcs/pk
19200318	A10P15 mat	Rotor adapter mat, used with A10P15, 12pcs/pk

16. Warranty

16.1 Warranty of centrifuge

This centrifuge is guaranteed for one years from the date of delivery provided that it has been operated and maintained properly.

16.2 Warranty of the rotor

The rotor is guaranteed for 5 years from the date of delivery upon manufacturer. Please pay attention, do not use the rotor once it has been corrosion or fatigue damage. The warranties of the centrifuge and the rotor become invalid in the case of the following conditions even if within the guarantee period expires:

- (1) Failures caused by incorrect installation.
- (2) Failures caused by rough or improper handling.
- (3) Failures caused by conveyance or relocation after installation.
- (4) Failures caused by unauthorized disassembly or modification.

- (5) Failures caused by using non-standard spare parts or accessories and unauthorized modification of the rotor or centrifuge.
- (6) Failures caused by natural disasters including fire, earthquakes and so on.
- (7) Consumables and parts have a limited guarantee period.

After-sales service

In order to ensure to operate centrifuge safely and efficiently, it is necessary for regular maintenance. If centrifuge has problems, do not attempt to repair it by yourself. Contact our sales or service center.

使用说明书

DM0412 低速离心机



大龙兴创实验仪器（北京）有限公司





在操作使用离心机之前，请认真阅读本使用说明书，充分理解与安全有关的注意事项。

目录

安全警示.....	1
1. 说明.....	3
2. 性能指标.....	3
3. 符合标准.....	4
4. 环境条件.....	4
4.1 基本运行条件.....	4
4.2 运输和贮存条件.....	4
5. 安装.....	5
5.1 安装位置.....	5
5.2 电源线与地线的连接.....	5
6. 结构.....	6
7. 操作面板.....	7
8. 转子准备.....	8
8.1 准备要分离的样品.....	8
8.2 将样品放入离心管中.....	8
8.3 确保离心管平衡.....	8
8.4 检查转子.....	8
8.5 确保将平衡好的离心管对称地放入转子孔内.....	8
9. 操作.....	9
9.1 正常运行操作.....	9
9.2 RCF 运行操作.....	11
9.3 短时运行操作.....	11
10. 维护.....	12
10.1 清洗.....	12
10.2 转子安装.....	13
11. 常见故障及解决办法.....	14
11.1 常见故障列表.....	14
11.2 如何打开上盖门.....	14
12. 转子及离心管介绍.....	15
12.1 转子介绍.....	15
12.2 离心管.....	17
13. RCF 的计算.....	18
14. 返厂和废弃.....	18
14.1 返厂.....	18
14.2 废弃.....	18
15. 订货信息.....	18
16. 质保.....	19
14.1 整机质保.....	19
14.2 转子质保.....	19
售后服务.....	19

安全警示

符号是国际通用的安全标志，请仔细阅读并充分理解下面的安全细则：

- 遵守说明书的操作要求，确保正确、安全地使用该离心机。
- 仔细阅读所有安全信息和安全提示。
- 安全信息作一下标记，安全符号分别同警告和告诫组合，提示用户潜在的危險。这两种组合以及提示符号的具体定义如下：

 **警告：人身危險。**
警告潜在的危險，如不严格遵守说明书的要求，可能会导致人身伤亡。

 **告诫：离心机损坏危險。**
警告潜在的离心机损坏危險，如不严格遵守说明书的要求，可能会导致离心机损坏。

提示：通常需要注意的事项。

- 不要以本说明书没有提及的方式使用该离心机，若遇到任何问题请与厂家制造商/供应商联系。
- 本说明书对潜在的危險已经作了比较完整的提示，然而，用户对不可预测的事情还须有必要警惕，小心使用该离心机。

 **警告**

- 该离心机是非防爆型，不要用于易燃、易爆样品的分离。
- 不要将该离心机安装在易燃气体、易燃化学物质附近。
- 该离心机30cm范围内不要放置危險品。
- 在对具有毒性、辐射性、致病有机体进行分离时，必须采取必要的安全措施，并自行承担不良后果。
- 如果离心机、转子及其它附件受到污染，请严格按照去污程序清洗消毒。
- 如果需要我们的现场帮助，需事先对该离心机进行消毒、去污，并告知服务中心所涉及的特殊物质详情。
- 不要用湿手接触电源线和电源开关，以防电击。
- 为安全起见，当离心机运行时，人员与离心机保持30厘米距离。
- 当转子运行时不要打开上盖。
- 除本公司的维修人员外，禁止非授权单位或个人维修、拆卸该离心机。



告诫

- 确保该离心机置于坚实而平整的水平桌面上。
- 离心机运行前要确保离心机水平。
- 打开上盖时要确保上盖与机壳角度大于70度。
- 当关上盖时，不要将手放在上盖和机壳之间。
- 当离心机运行时不要移动离心机，也不要依靠离心机。
- 当离心腔内有液体时，请及时用干布擦干，以避免污染样品。
- 在运行离心机前要保证离心腔清洁，务必取走离心腔中的异物，如离心管碎片等。
- 对于转子的提示：
 - (1) 在使用转子前检查转子表面是否有腐蚀或损坏，若有此类问题，则停止使用。
 - (2) 离心机设定转速不能超过转子组件及附件（转子、适配器）中所允许的最小转速，务必使离心机运行在最小允许转速以下。
 - (3) 不要超出所允许的不平衡量。
 - (4) 所使用的离心管应在它们的允许容量以内。
 - (5) 如果转子有盖子，运行前确保将盖子旋紧。
- 在运行过程中出现奇怪噪音等异常现象，请马上停机，与服务中心联系，并告知所显示的故障码。
- 地震有可能对离心机造成损坏，如果出现不正常情况，请与服务中心联系。

1. 说明

按照 IVD 98/79/EC 规定，该设备为一种医疗装置（实验室离心机），这种离心机主要用于血液或尿液样本的分离。使用本仪器前请进行专业培训，并严格按照说明书指导进行操作。

2. 性能指标

最高转速	4500rpm(300-4500rpm), 步长: 100rpm	
最大相对离心加速度	2490×g, 步长: 100×g	
容量	10ml×12, 15ml×8	
定时	30 秒 -99 分-HOLD (连续运行)	
噪音	56dB(A)	
驱动电机	直流无刷电机	
安全性能	门锁、超速、状态诊断系统	
电源	单相, 110V-240V, 50Hz/60Hz, 3A.	
环境条件		
-场所	室内	
-海拔	不超过 2000 米	
-环境温度	2°C ~ 40°C	
-湿度	80%	
-过电压类别	II	
-污染度	2	
防护等级	I	
EMC		
-辐射干扰,	EN/IEC 61326-1	FCC Class A
-辐射抗扰	Class A	
尺寸 (毫米)	(长) 255× (深) 245× (高) 140	
重量	6kgs	
其他功能	转速/加速度转换功能、短时运行功能、运行进程显示、声音提示功能	

3. 符合标准

离心机结构符合以下安全标准：

EN 61010-1

EN 61010-2-020

EN 61010-2-101

离心机结构符合以下电磁兼容标准：

EN 61326-1/ FCC Part 15 Subpart B/ IEC61010-1

EN 61326-2-6:2006

符合以下欧盟标准：

EMC directive: 2014/30/EU

LVD directive: 2014/ 35 /EU

IVD directive: 98/79/EC

This ISM device complies with Canadian ICES-001.

4. 环境条件

4.1 基本运行条件

- (1) 电源: 110V-240V, 50Hz/60Hz, 3A.
- (2) 环境温度: 2°C~40°C.
- (3) 相对湿度: ≤80%.
- (4) 周围无影响性能的振动和气流存在
- (5) 周围空气中无导电尘埃、爆炸性气体和腐蚀性气体存在。

4.2 运输和贮存条件

- (1) 环境温度范围: -40°C~55°C.
- (2) 相对湿度范围: ≤93%.

5. 安装

用户必须严格遵守本章的安装说明，切记！

警告

- 不正确的电源连接会损坏离心机。
- 在连接电源前请检查供电电源是否满足要求。

5.1 安装位置

- (1) 该离心机必须安装在坚实、平整和水平的台面上，且保证离心机四个脚与台面接触。不要将离心机安装在滑动台面上，否则容易引起较大振动。
- (2) 理想环境温度为 $20^{\circ}\text{C}\pm 5^{\circ}\text{C}$ ，环境温度不宜超过 30°C ，避免阳光直接照射该离心机。
- (3) 确保离心机两侧10cm间隙，离心机后侧30cm间隙，以确保离心机的风冷效果。
- (4) 离心机附近不能有热源或水源泄漏，否则容易导致样品温度升高或离心机故障。

5.2 电源线与地线的连接

警告

- 不要用湿手接触电源线，以防止电击。
- 该离心机必须良好地接地。

电源插板额定电流应为 10A 以上，并且要满足地方电气安全要求，保证具有良好的保护地端。

6. 结构



图 6-1 离心机正面图



图 6-2 离心机背面图

7. 操作面板

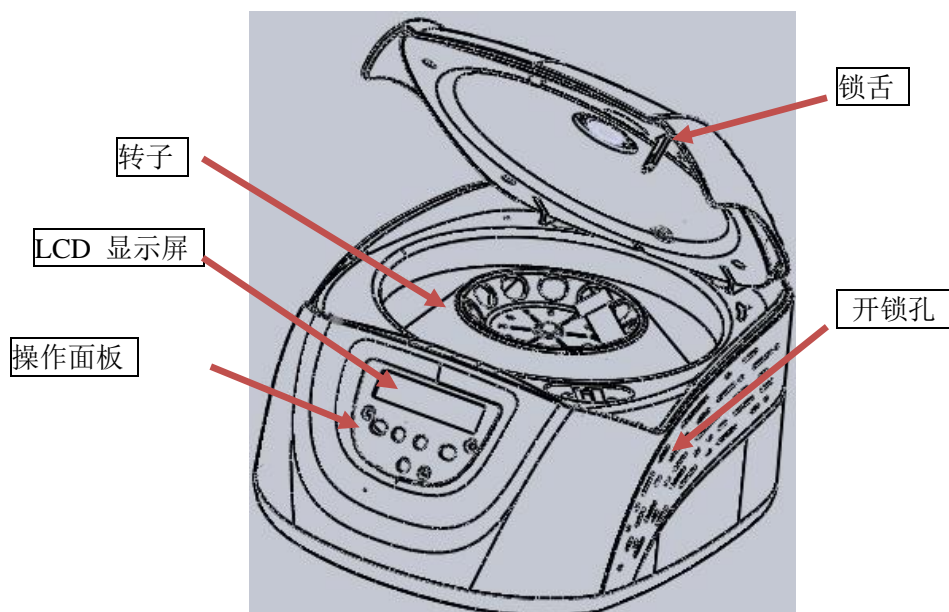

图 7-1 操作面板示意图

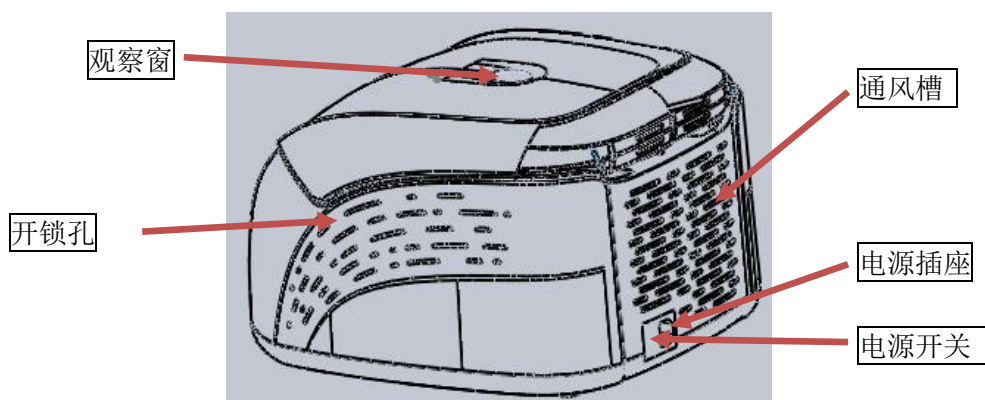
序号	图示	名称	功能
1		位选键	按下该键，可以选中需要输入的参数。
2		点动键	当上盖锁紧时，按下此键并保持住，则离心机升速运行直到设定转速，松开该键，则离心机停车。
3		门锁开关键	当转速为零时，按下该键，门锁打开。转速不为零时，按该键无效。
4		运行/停车键	当转速为零时，按下该键，离心机开始运行。离心机运行过程中，按下该键，离心机开始停车。
5		参数输入键	顺时针旋转，参数增加。逆时针旋转，参数减小。按下该键，可以选择速度挡或加速度挡。

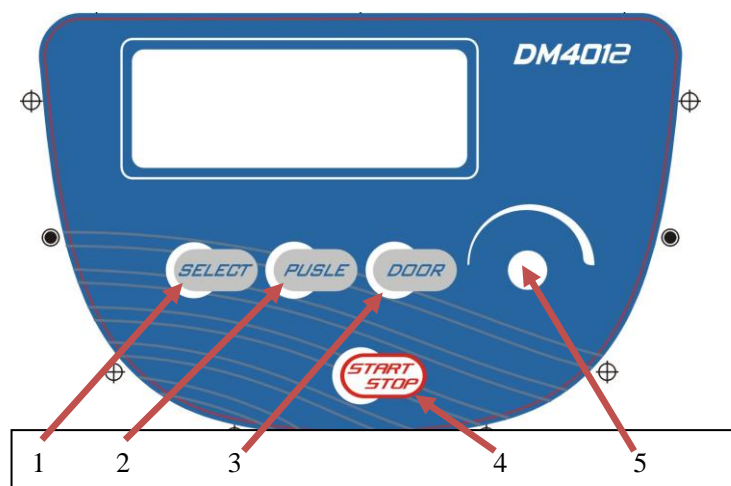

图 7-2 主画面示意图

主画面如图 7-2 所示. 此时转速设定为 4500rpm, 设定的运行时间为 12 分钟.

速度图标旋转时，表示机器正在运行. 其转动越快，表示转速越高.

时间显示图标将整个运行时间分成 10 等分，显示已运行时间占总时间的比例。

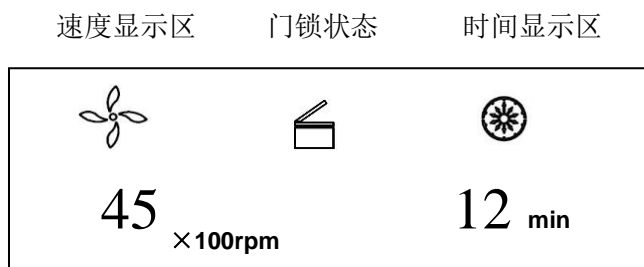
8. 转子准备

8.1 准备要分离的样品

8.2 将样品放入离心管中

告诫

- 在离心管中加入过量样品会引起泄露，因此不要加入过量样品。

- 样品量不超过说明书中所允许的最大限量。

8.3 确保离心管平衡

- 尽管该离心机允许目测平衡方法使用，但是，为了延长离心机使用寿命，建议样品使用天平称量，确保平衡。
- 尽管不平衡量是允许的，也不要在不好的平衡条件下运行该离心机。

8.4 检查转子

使用前需要检查转子是否有腐蚀或划痕。

告诫

- 如果发现转子上存在腐蚀或划痕等，请停止使用。
- 禁止在本机上使用其它牌号或规格的转子。

8.5 确保将平衡好的离心管对称地放入转子孔内

告诫

- 确保将转子与主轴旋紧，盖子安全固定在转子上。否则，在离心机运行时转子可能脱落，造成离心机或转子损坏。
- 转子盖与转子旋紧牢固。

9. 操作

⚠ 告诫

- 当离心机运行时不要移动离心机，也不要依靠离心机。
- 在运行离心机前要保证离心腔清洁，务必取走离心腔中的异物，如离心管碎片等。
- 在运行过程中出现奇怪噪音等现象，请马上停机，与我服务中心联系，并告知所显示的故障代码。

9.1 正常运行操作

打开电源开关显示亮，离心机自检完成后显示上一次运行参数。见图 8-1 所示。









图 9-1 上一次运行界面

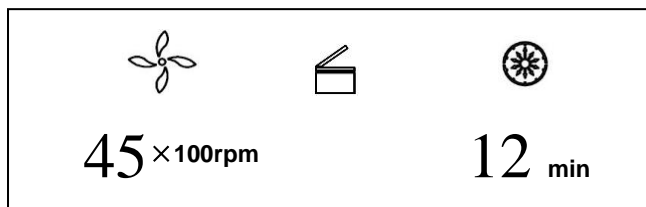



- 速度设定: 4500rpm. 时间设定: 12 分钟.
- 上盖门锁释放

1) 设置运行参数

向下轻按位选键 **SELEC** 可以选择需要输入的参数对象. 使该参数图标闪烁, 进入参数输入状态. 这时右旋参数键 , 可以增加参数, 左旋, 则减小参数. 参数键  转动越快, 输入参数的值变化越快, 反之, 参数键  转动越慢, 输入参数的值变化越慢. 转速、加速度的最小步长为 100rpm, 时间的最小步长为 1 秒钟。



(1) 设定转速

- 按位选键 **SELEC**, 选择转速单位为 rpm, 这时表示速度参数。
- 当选中速度位时, 速度值闪烁, 进入速度参数输入状态。
- 最小转速设定值为 200rpm, 最小步长为 10rpm。
- 顺时针旋转参数键  参数增加; 反之, 逆时针旋转参数键  参数减小。

- 参数键具有快速输入功能，快速旋转参数键，可以加快参数的变化。
- 增加、减少参数具有循环功能。顺时针旋转参数键，数值从小→大→最大→最小，如此循环；逆时针旋转参数键，数值从大→小→最小→最大，如此循环。

此循环；逆时针旋转参数键，数值从大→小→最小→最大，如此循环。

(2) 设定运行时间



- 按位选键，使时间值闪烁，进入时间设定模式。
- 旋转参数键输入时间设定值，设定范围 30 秒-99 分钟。
- 当时间显示 HD 时，表示连续运行模式。

2) 开始运行

(1) 按运行键启动运行

- 上盖门锁上，转子开始旋转。
- 当转速达到设定值后开始计时，时间显示剩余运行时间。

(2) 运行参数的查询和修改

- 离心机稳速运行后可对其运行参数进行修改。
- 按位选键，显示返回预备模式界面，显示设定的运行参数。这时，再轻按位选键

使所需要修改的参数图标闪烁，再旋转参数键修改其参数。无键操作 7 秒后离心机回到正常运行状态，并按新参数继续运行。

- 时间设定参数修改后，已运行时间不清零而将继续累加。

(3) 错误显示

● 离心机运行过程中出现故障，将自动停车，并在时间显示窗显示出故障代码，通过查询表 11-1，即可知道出错原因并可进行相应处理。

3) 结束运行

(1) 当运行时间到或按键时，离心机开始停车。

- 当转子停止旋转后，离心机鸣叫，告诉用户运行结束。

(2) 上盖门锁打开

- 运行结束，离心机自动打开上盖门锁。
- 上盖门锁关闭后，可以通过按键打开上盖门锁。

● 运行结束后，程序将自动储存本次运行的设定参数。再次开机时程序将自动调出最后一次运行的设定参数。



(3) 打开上盖门，取出样品和转子。

9.2 RCF 运行操作

(1) 接通电源开关

(2) 设定 RCF (相对离心加速度)

告诫

- 所设定的相对离心加速度不要超过离心管及其适配器所允许的最大相对离心加速度。
- 按下位选键  选择转速单位为×g，使离心加速度值闪烁，进入相对离心加速度输入状态。
- 加速度参数闪烁 7 秒后仍无按键操作，输入模式将被关闭。
- 旋转参数键 ，输入相对离心加速度，相对离心加速度以 10×g 步长变化。

(3) 设定运行条件

其它部分操作，请参照 8.1 部分。

9.3 短时运行操作

该功能通常用于去掉附着在离心管内壁上的样品，也能满足短时离心的应用要求。

提示：只有当转子没有转动并且上盖门锁紧时该按键才有效。

(1) 打开电源开关，将转子固定在主轴上，旋紧转子盖，并保证旋紧牢固，关闭上盖门。

(2) 离心机进入预备模式，并显示上次运行的参数值可重新设定目标转速。

(3) 按  键并保持住，转速不断上升，直到达到设定转速。当松开  键时开始减速停车。

10. 维护

10.1 清洗

 告诫

- 不按说明书的建议对离心机进行清洁或消毒有可能损坏离心机。

(1) 离心机

- 离心机长期暴露在紫外光线下，机壳的颜色会有变化，其上面的标签可能脱落。用完后请用布盖住离心机，避免光线照射。
- 离心机脏了后，请用布或海绵配以中性清洁剂清洗。
- 可以用布配以 70% 的酒精溶剂对离心机消毒。

(2) 离心腔

 告诫

- 不要将水及其它溶剂直接倒入离心腔，否则，这些溶剂可能进入驱动单元而引起轴承腐蚀或损坏。

- 如果离心腔脏了，可以用布或海绵配以中性清洁剂擦干净，用布配以 70% 酒精可以对离心机消毒。

(3) 驱动轴

- 建议对驱动轴做定期维护，可以用软布擦净驱动轴，然后在轴上涂一薄层硅脂。

(4) 上盖门

- 清洗或消毒上盖门方法同（1）离心机部分。

(5) 转子

- 为防止腐蚀，如果转子长期不用，请将转子从离心腔中取出，并取下转子上盖，将转子倒置，晾干转子孔。
- 如果有样品泄露在转子孔内，则用清水冲洗转子孔，晾干后在转子表面涂一薄层硅油。
- 转子需要定期维护，建议每三个月作一次清洗，保证试管孔与主轴孔清洁，并涂一薄层硅脂。

10.2 转子安装

(1) 安装

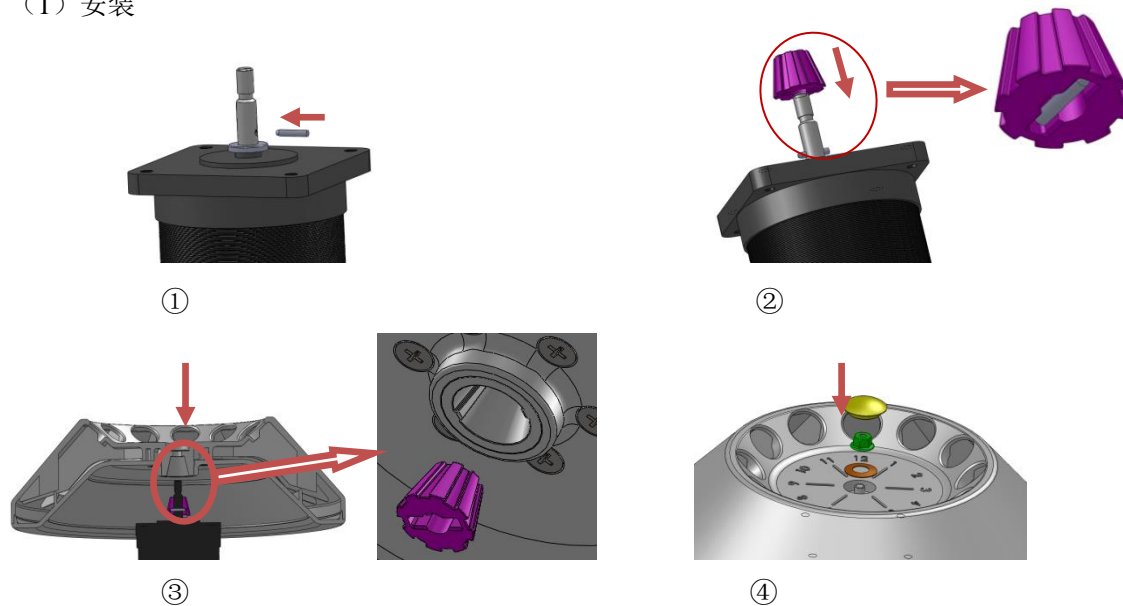

(2) 调整

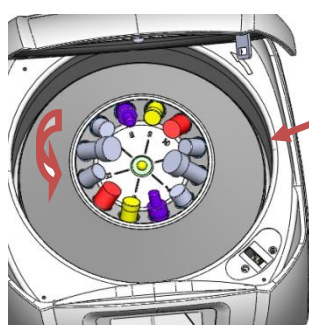

观察这里

在锁紧转子之前，用手旋转转子同时仔细观察是否有明显的晃动，如果有，请取下转子，转动一定的角度再重新安装，直到转子没有明显的晃动，再锁紧它。

11. 常见故障及解决办法

11.1 常见故障列表

该离心机具有自我诊断功能，当离心机出现故障不能运行时，在时间显示窗上会显示故障代码，根据故障代码即可知道故障原因。



现象	可能原因	解决办法	
通电没有显示	· 电源座断电	· 排除故障，重新通电	
离心机振动异常	· 转子和主轴配合不好 · 样品安装不对称	· 重新安装转子 · 天平称量，对称安装	
报警码显示在时间显示窗上	E-02 上盖门故障	· 运行中门打开 · 门开着时按下 	· 马上关闭盖门 · 关闭盖门，然后运行
	E-06 转速设定异常	· 设定转速超出转子所允许的最高转速	· 修改转速设定值
	E-10~86	· 见服务手册	· 与服务代表联系

表 11-1 常见故障及解决办法

- 故障码 E-1~E-9 与操作错误有关，故障清除后可以继续运行离心机。

11.2 如何打开上盖门

1) 通电情况下

 **提示：**

- 只有当离心机通电并且转子不转动时才能打开上盖门。

- (1) 离心机通电，上盖门锁自动打开。
- (2) 离心机运行结束后，上盖门锁自动打开。
- (3) 当转子停止运行，按  键，可以打开上盖门锁，这时可以翻开上盖门。

2) 断电情况下

突然断电不能打开上盖门时，可按以下步骤打开上盖门。

(1) 检查转子是否运转

- 仔细听，确保没有转动声音。

(2) 用小起子插入机壳小孔打开上盖门锁

- 小孔在左、右侧面板前端上方。
- 用两个小起子同时通过左右小孔向前推动，即可打开上盖门锁，翻开上盖门。

12. 转子及离心管介绍

⚠ 告诫

- 仔细阅读说明书，正确地安装和使用转子。
- 不要超过转子、试管及适配器等组件所允许的最高转速，有些适配器所允许的最高转速低于转子的最高转速。

12.1 转子介绍

1) 转子结构



图 12-1 转子结构

2) 转子和适配器

转子型号	离心管	可容纳数量	尺寸 (Φ×L mm)	适配器	最高转速(rpm)	半径 cm	最大相对离心加速度 (×g)
A12-10P	15ml con	8	17×120		4500	11	2490
	1.5-5ml vacu	12	13×82	A10P15 mat	4500	9.8	2218
	4-7 ml vacu	12	13×106	A10P15	4500	11	2490
			16×75	A10P15 Mat		9.8	2218
	8.5-10 ml vacu	12	16×107	A10P15	4500	11	2490
	2.7-3 (EU) ml collection tube	12	11×66	A10P15 mat	4500	9.8	2218
	7.5-8.2 (EU) ml collection tube	12	15×92	A10P15	4500	11	2490

表 12-1 转子和适配器列表

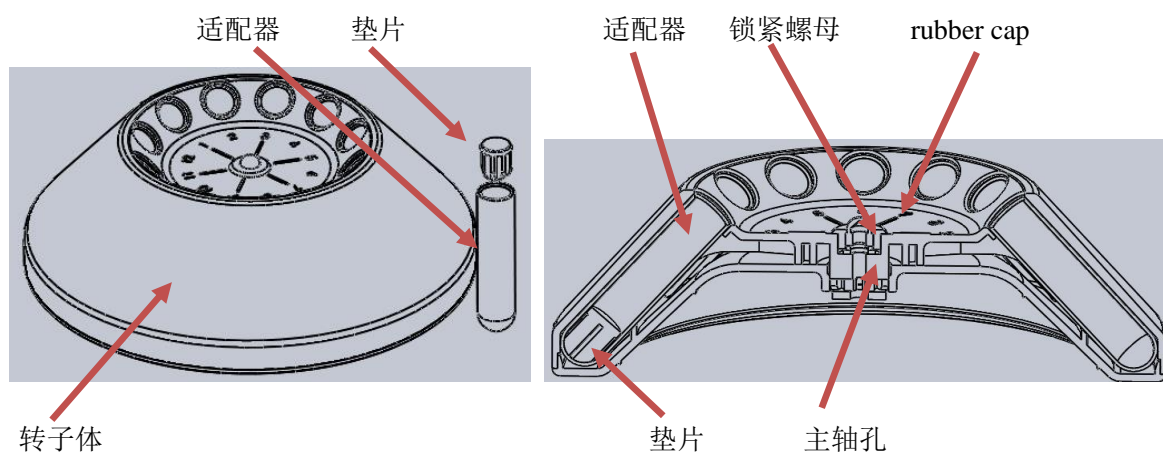
3) 注意事项

- 离心机转子可分离样品的密度在 2.0 g/ml 以下，如果被分离的样品密度超过 2.0 g/ml，请根据下面的公式计算允许的转速：

$$\text{允许转速}(rpm) = \text{最大转速} \times \sqrt{\frac{2.0(g/ml)}{\text{样品密度}(g/ml)}}$$

4) 灭菌

A12-10P 转子体使用高强度塑料制造，不可以进行高压灭菌和紫外光照射。

12.2 离心管

1) 清洗和消毒

O: 可用 X: 不可用

条件		材料	PA	PC	PP
清洗	流动清洗	酸性清洗剂 (pH5 或更低)	X	X	X
		酸性清洗剂 (高于 pH5)	O	O	O
		碱性清洗剂 (高于 pH9)	O	X	O
		碱性清洗剂 (pH9 或更低)	O	O	O
		中性清洗剂 (pH7)	O	O	O
		70℃热水	O	O	O
	超声清洗	中性清洗剂 (pH7)	O	O	O
消毒	高压灭菌	115℃ (0.7kg/cm ²) 30 分钟	O	O	O
		121℃ (1.0kg/cm ²) 20 分钟	X	O	O
		126℃ (1.4kg/cm ²) 15 分钟	X	X	X
	煮沸灭菌	15 to 30 分钟	O	O	O
	紫外线灭菌	200-300nm	X	X	X
	气体灭菌	乙烯氧化物	O	X	O
甲醛		O	O	O	

PA: 同质异晶聚合物 PC: 聚碳酸脂 PP: 聚丙烯

表 12-2 离心管的清洗和消毒条件

2) PC 离心管清洗

PC材料对碱性溶剂具有较低的化学稳定性，应避免使用pH值大于9的清洗剂。一些中性清洗剂按厂家的说明冲淡使用后其 pH 值仍大于 9，因此，建议使用 pH 值在 7-9 之间的清洁剂。

3) PA、PC 和 PP 离心管的高压灭菌

PA在120℃开始变软，而PC和PP是130℃。通常，PA可以在115℃ (0.7 kg/cm²) 经30分钟灭菌，而PC和PP可以在121℃ (1.0 kg/cm²) 经20分钟灭菌。如果温度过高，离心管就会变形。当使用灭菌皿时按如下操作：

- (1) 将离心管口向上，竖直放置。如果将离心管倾斜或侧向放置，由于重力作用将会变形。
- (2) 取下螺纹盖子和内部盖子以防止离心管变形或裂口。
- (3) 当灭菌皿降到室温之后才能将离心管取出。

4) 离心管的寿命

塑料离心管的寿命取决于样品特性、转子转速、离心温度等。当塑料离心管用于离心常规中性

样品（pH5-pH9）时，其寿命估计如下：

在最高转速下使用：

优质离心管（PA、PC、PP）：30-50次。

常规离心管：10次左右（低速使用可以增加使用次数）。

离心管寿命还与清洗和消毒的条件有关，使用寿命会有所降低。

注：不要使用有裂纹的离心管。

13. RCF 的计算

相对离心加速度（RCF）可以通过计算公式计算：

$$RCF=1.118 \times r \times n^2 \times 10^{-5}$$

r—旋转半径，单位：cm；n—旋转转速，单位：rpm

14. 返厂和废弃

14.1 返厂

 在仪器返厂前，请确认已安装运输固定装置。

为了保护人体健康，环境和材料安全，请在设备和配件返厂前进行消毒和清理。

14.2 废弃

为了保护人体健康和环境安全，设备在废弃前请进行消毒处理，废弃时请遵守相应的法律规定。根据 2002/96/EC(WEEE)规定，2005 年 8 月 13 日以后购买的设备均不能作为家居物进行废弃。这些设备属于 8 类（医疗设备）和企业对企业领域。带叉号的垃圾桶图标表示该设备不能作为家居物进行废弃处理。不同欧共体国家对这类废弃品的处理准则不同，如有必要，请联系供应商。

15. 订货信息

订货号码	型号	描述
913123410000	DM0412	低速离心机(含 A12-10P 转子), 国标插头, 110V-240V/50Hz/60Hz
Accessories		
19200316	A12-10P	转子, 最高转速 4500rpm, 最大容量 15ml*8
19200317	A10P15	转子适配器, 适用于 A12-10P 转子, 12pcs/pk
19200318		转子适配器垫片, 可以与 A10P15 配套使用, 12pcs/pk

16. 质保

16.1 整机质保

整机从交货之日起在正常维护的情况下保修一年。

16.2 转子质保

转子自交货之日起担保5年。特别注意，当转子已经被腐蚀或疲劳损坏，请不要再使用。因以下原因引起的主机或转子的损坏不属于担保范围。

- (1) 由于不正确安装引起的损坏。
- (2) 野蛮或不正确操作引起的损坏。
- (3) 安装完毕后重新移位或运输引起的损坏。
- (4) 由于无授权单位的拆卸或修改而引起的损坏。
- (5) 使用非我公司的部件，如转子、适配器等造成的损坏。
- (6) 由于自然灾害，包括火灾、地震等造成的损坏。
- (7) 易损件和具有保修期的部件。

售后服务

为了确保离心机安全高效地运行，需要定期维护。如果离心机出现问题，不要试图自己修复，请与服务代表中心联系。



DLAB Scientific Co., Ltd.

大龙兴创实验仪器（北京）股份公司

Yu An Road 31, Beijing Airport Economic core zone,

Shun yi District, Beijing, China

北京市顺义区临空经济核心区裕安路 31 号, 101318

Tel: 86-10-85653451/52/53

Fax: 86-10-85653383

E-mail: info@dlabsci.com

Service: service@dlabsci.com

[Http://www.dlabsci.com](http://www.dlabsci.com)