



Policy Of Enterprise



The autographs of Mr. CUI YUE LI, the former minister of ministry of Public Health.



ZHEJIANG GONGDONG MEDICAL TECHNOLOGY CO., LTD.

With almost 25 years' pursuit and unremitting efforts, "Gongdong" as a famous brand for the disposable medical plastic ware, has got sustained, steady, high-speed development.

In order to make the enterprise larger, stronger and better, "Gongdong" invested 7500 thousand dollars to establish the new factory in 2003. Now our 40000 square meters facility was built in line with GMP standard requirements. It has completed and gone into operation on 1<sup>st</sup>, Nov. 2004.

"Gongdong" take promoting the quality, strengthening the cooperation with our customers for products, technical and developing the market as the targets. We have got the license of export & import, passed the ISO 13485, got CE certificate and FDA 510(k).

"Gongdong" welcome people from all over the world to visit our factory, cooperate with us and develop the market in the world.

BUSINESS ENTERPRISE DEVELOPMENT POLICY  
HIGH EFFICIENCY HIGH QUALITY DEVELOPMENT  
WITH PROSPERITY TOGETHER



# Company Facility

# Contents

ZHEJIANG  
GONGDONG







Ultrasonic welding machine



Injection, blowing and stretch machine



Paper-plastic seal package machine

					
new products	NURSING PLASTIC WARE	VACUUM BLOOD TUBE	PETRI DISH	CENTRIFUGATION TUBE	PIPETTE TIP
1	3	7	11	15	19
					
CULTURE PLATE	TEST TUBE	TUBE RACK	COLORIMETRIC CUP	COLORIMETRIC CUP	SAMPLE CUP
21	25	27	29	31	33

# NEW PRODUCTS



new products



Item No.	Specification	Quantity (pcs)	Measurement (cm)
G1026	Test tube with graduation, 14.7×101mm with cap. Color: transparent or amber	1000	46×29×36



Item No.	Specification	Quantity (pcs)	Measurement (cm)
B1017	Quantitative siphon dropping tube. Siphon volume 3ul. Every drop volume 50ul.	1000	49×33×33



Item No.	Specification	Quantity (pcs)	Measurement (cm)
GD-H3	Vacuum Tube holder with Aspirating Needle and Straw	1000	48×32×32



Item No.	Specification	Quantity (pcs)	Measurement (cm)
K1028	Ear curettes, 147.5mm long	1600	49×33×33
K1029	Ear curettes, Φ3.9mm, 145.2mm long	1600	49×33×33
K1030	Ear curettes, Φ2.9mm, 146.4mm long	1600	49×33×33
K1031	Ear curettes, 148mm long	1600	49×33×33



Item No.	Specification	Quantity (pcs)	Measurement (cm)
GD018SCD	Blue Cap, Coagulation, Double Wall, 13x75mm, 1.8ml	1200	48×38×20
GD027SCD	Blue Cap, Coagulation, Double Wall, 13x75mm, 2.7ml	1200	48×38×20

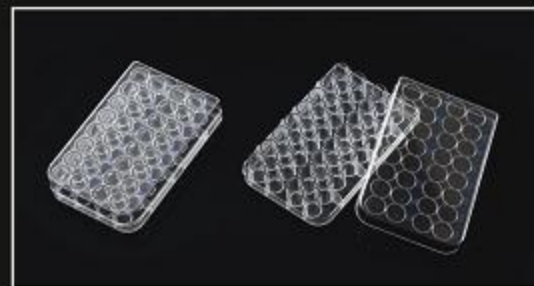

Item No.	Specification	Quantity (pcs)	Measurement (cm)
F1006	32wells culture plate, size 113.4×73.5×22mm, 1.5ml/hole	200	48×32×32



Item No.	Specification	Quantity (pcs)	Measurement (cm)
GDS-01	100wells transfer-store box for 13×100mm tube	60	61×41×41
GDS-02	100wells transfer-store box for 13×75mm tube	60	61×41×41



Item No.	Specification	Quantity (pcs)	Measurement (cm)
B1016	Sample cup match with Abbott I2000SR	12000	49×33×33



Item No.	Specification	Quantity (pcs)	Measurement (cm)
F1007	24wells culture plate, size 138.5×32×13.6mm, 154±4ul/hole	540	45×31×25



Item No.	Specification	Quantity (pcs)	Measurement (cm)
B1015	Sample cup match for machine.	4000	49×33×33



P1001-L



Item No.	Specification	Quantity (pcs)	Measurement (cm)
P1001-L	Vaginal Speculum large	100	49×24×38
P1001-M	Vaginal Speculum Middle	100	38×23×39
P1001-S	Vaginal Speculum Small	100	38×23×39



Item No.	Specification	Quantity (pcs)	Measurement (cm)
P1002-L	Vaginal speculum, Light source style, Large	80	56×40×30
P1002-M	Vaginal speculum, Light source style, Medium	100	56×40×30
P1002-S	Vaginal speculum, Light source style, Small	100	56×40×30

P1032

P1030



P1031

Item No.	Specification	Quantity (pcs)	Measurement (cm)
P1030	Anus speculum, Small	100	48×30×32
P1031	Anus speculum Medium	100	48×30×32
P1032	Anus speculum Large	100	48×30×32

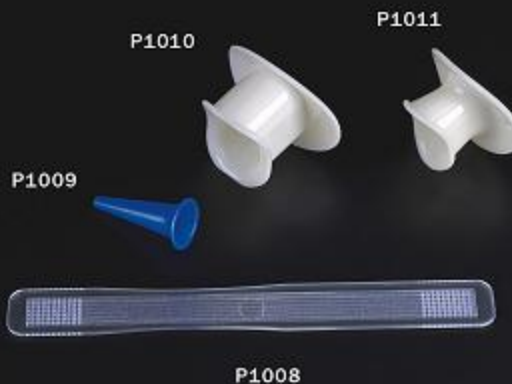

Item No.	Specification	Quantity (pcs)	Measurement (cm)
P1008	Tongue Depressor	2800	50×35×37
P1009	Ear Funnel	2500	55×31×43
P1010	Mouth Piece For Endoscopes Larger	1000	55×31×43
P1011	Mouth Piece For Endoscopes Medium	1000	55×31×38



Item No.	Specification	Quantity (pcs)	Measurement (cm)
P1004	Scissors Blue	1200	49×33×33

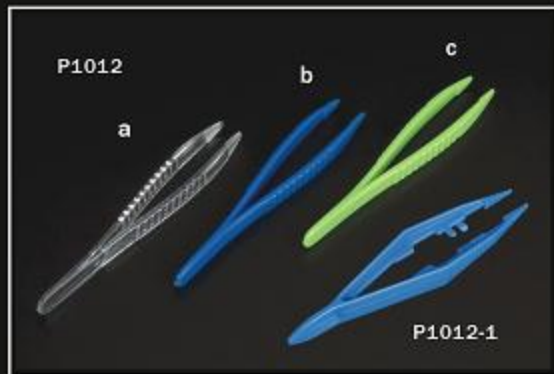

Item No.	Specification	Quantity (pcs)	Measurement (cm)
P1012 (a, b, c)	Tweezers 12.5cm Long	2500	48×32×32
P1012-1	Tweezers 10cm Long	2500	48×32×44

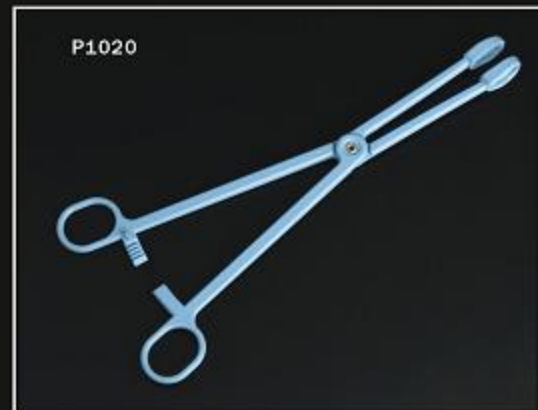

Item No.	Specification	Quantity (pcs)	Measurement (cm)
P1020	Sponge Holder 23cm Long	500	52×38×32



Item No.	Specification	Quantity (pcs)	Measurement (cm)
P1021	Sponge Holder 18cm Long	500	42×38×32

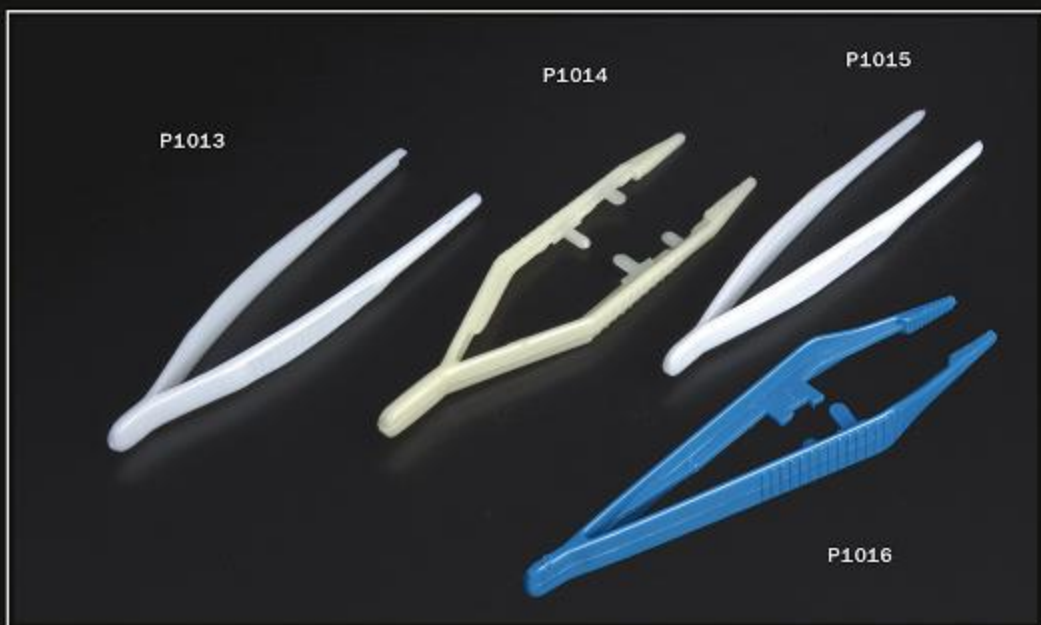

Item No.	Specification	Quantity (pcs)	Measurement (cm)
P1013 (with tooth)	Tweezers 12cm Long	2500	48×32×32
P1014	Tweezers 13cm Long	2000	48×32×32
P1015 (without tooth)	Tweezers 12cm Long	2500	48×32×32
P1016	Tweezers 13cm Long	2000	48×32×44



Item No.	Specification	Quantity (pcs)	Measurement (cm)
P1022	Sponge Holder 11cm Long	1200	49×33×33



Item No.	Specification	Quantity (pcs)	Measurement (cm)
P1023	Sponge Holder 10cm Long	1200	49×33×33



Item No.	Specification	Quantity (pcs)	Measurement (cm)
P1024	Sponge holder, 14.3cm long	1200	48×32×42
P1025	Sponge holder, 13.9cm long	1200	48×30×39

# VACUUM BLOOD TUBE



VACUUM  
BLOOD  
TUBE



Item No.	Specification	Quantity (pcs)	Measurement (cm)
GD030A	Red Cap, Plain 13×75mm, 3ml	1200	48×38×20
GD050A	Red Cap, Plain 13×75mm, 5ml	1200	48×38×20
GD070A	Red Cap, Plain 13×100mm, 7ml	1200	48×38×25
GD0100AR	Plain, with stopper 16×100mm, 10ml	800	53×42×24
GD0100A	Red Cap, Plain 16×100mm, 10ml	800	53×42×24



Item No.	Specification	Quantity (pcs)	Measurement (cm)
GD030CA	Red Cap, Clot Activator 13×75mm, 3ml	1200	48×38×20
GD050CA	Red Cap, Clot Activator 13×75mm, 5ml	1200	48×38×20
GD070CA	Red Cap, Clot Activator 13×100mm, 7ml	1200	48×38×25
GD0100CAR	Clot Activator, with stopper 16×100mm, 10ml	800	53×42×24
GD0100CA	Red Cap, Clot Activator 16×100mm, 10ml	800	53×42×24



Item No.	Specification	Quantity (pcs)	Measurement (cm)
GD020EK	Purple cap, EDTA K3/K2, 13×75mm, 2ml	1200	48×38×20
GD030EK	Purple cap, EDTA K3/K2, 13×75mm, 3ml	1200	48×38×20
GD050EK	Purple cap, EDTA K3/K2, 13×75mm, 5ml	1200	48×38×20
GD0100EKR	EDTA K3/K2, with stopper, 16×100mm, 10ml	800	53×42×24
GD0100EK	Purple cap, EDTA K3/K2, 16×100mm, 10ml	800	53×42×24

We can manufacture both EDTA K3 and EDTA K2



Item No.	Specification	Quantity (pcs)	Measurement (cm)
GD030SH	Green cap, Heparin Sodium, 13×75mm, 3ml	1200	48×38×20
GD050SH	Green cap, Heparin Sodium, 13×75mm, 5ml	1200	48×38×20
GD0100SHR	Heparin Sodium, with stopper, 16×100mm, 10ml	800	53×42×24
GD0100SH	Green cap, Heparin Sodium, 16×100mm, 10ml	800	53×42×24



Item No.	Specification	Quantity (pcs)	Measurement (cm)
GD030LH	Green cap, Heparin Lithium, 13×75mm, 3ml	1200	48×38×20
GD050LH	Green cap, Heparin Lithium, 13×100mm, 5ml	1200	48×38×25
GD0100LHR	Heparin Lithium, with stopper, 16×100mm, 10ml	800	53×42×24
GD0100LH	Green cap, Heparin Lithium, 16×100mm, 10ml	800	53×42×24



Item No.	Specification	Quantity (pcs)	Measurement (cm)
GD030LHG	Green cap, Heparin Lithium +Gel, 13×75mm, 3ml	1200	48×38×20
GD050LHG	Green cap, Heparin Lithium +Gel, 13×100mm, 5ml	1200	48×38×25



Item No.	Specification	Quantity (pcs)	Measurement (cm)
GD018SC	Blue Cap, Coagulation, 13×75mm, 1.8ml	1200	48×38×20
GD027SC	Blue Cap, Coagulation, 13×75mm, 2.7ml	1200	48×38×20
GD045SC	Blue Cap, Coagulation, 13×75mm, 4.5ml	1200	48×38×20



Item No.	Specification	Quantity (pcs)	Measurement (cm)
GD016SC	Black Cap, ESR, 13×75mm, 1.6ml	1200	48×38×20
GD024SC	Black Cap, ESR, 13×75mm, 2.4ml	1200	48×38×20



Item No.	Specification	Quantity (pcs)	Measurement (cm)
GD020SFH	Grey Cap, Glucose, 13×75mm, 2ml	1200	48×38×20
GD030SFH	Grey Cap, Glucose, 13×75mm, 3ml	1200	48×38×20

# VACUUM BLOOD TUBE



VACUUM BLOOD TUBE



Item No.	Specification	Quantity (pcs)	Measurement (cm)
GD040SGC	Yellow Cap, Separate Gel+Clot Activator, 13×75mm, 4ml	1200	48×38×20
GD060SGC	Yellow Cap, Separate Gel+Clot Activator, 13×100mm, 6ml	1200	48×38×25
GD085SGCR	Separate Gel+Clot Activator, with stopper, 16×100mm, 8.5ml	800	53×42×24
GD085SGC	Yellow Cap, Separate Gel+Clot Activator, 16×100mm, 8.5ml	800	53×42×24



Item No.	Specification	Quantity (pcs)	Measurement (cm)
GD005LH	Micro Blood Collection Tube, Heparin Lithium, 0.5ml	500	26×17×17
GD005A	Micro Blood Collection Tube, Plain, 0.5ml	500	26×17×17
GD005SGC	Micro Collection tube, Gel+Clot Activator, 0.5ml	500	26×17×17
GD005EK	Micro Blood Collection Tube, EDTAK3, 0.5ml	500	26×17×17



Item No.	Specification	Quantity (pcs)	Measurement (cm)
GD018SC-F	Blue Cap, Coagulation, 10.25×64mm (flat bottom), 1.8ml	1000	42×20×33
GD027SC-F	Blue Cap, Coagulation, 10.25×64mm (flat bottom), 2.7ml	1000	42×20×33
GD036SC-F	Blue Cap, Coagulation, 10.25×64mm (flat bottom), 3.6ml	1200	48×38×20



Item No.	Specification	Quantity (pcs)	Measurement (cm)
GDN050EK	5ml EDTAK3 Non-vacuum blood tube, Green Cap	1000	50×25×35
GDN050A	5ml Plain Non-vacuum blood tube, Red cap	1000	50×25×35
GDN050SP	5ml Fluoride Oxalate Non-vacuum Blood tube, Yellow cap	1000	50×25×35
GDN050LH	5ml, Lithium Heparin Non-vacuum blood tube, Dark Blue cap	1000	50×25×35



Item No.	Specification	Quantity (pcs)	Measurement (cm)
H1020	ESR Detector	10	35×23×20
GD016ESR	Black cap, ESR, 8×120mm, 1.6ml	1200	47×37×28
GD0128ESR	Black cap, ESR, 8×120mm, 1.28ml	1200	47×37×28



Item No.	Specification	Quantity (pcs)	Measurement (cm)
GDC-01	Sharp container, 1L	60	55×29×36.5
GDC-03	Sharp container, 3L	48	63.5×39×42

Item No.	Specification	Quantity (pcs)	Measurement (cm)
GDC-05	Sharp container, 5L	32	69×43×36
GDC-07	Sharp container, 7L	24	58×46.5×50
GDC-013	Sharp container, 13L	20	69×52×32



Item No.	Specification	Quantity (pcs)	Measurement (cm)
GDC005A	Capillary Blood Collection tube, Plain, 0.5ml	1000	31×18.5×31
GDC005EK	Capillary Blood Collection tube, EDTA K3, 0.5ml	1000	31×18.5×31
GDC005LH	Capillary Blood Collection tube, Heparin Lithium, 0.5ml	1000	31×18.5×31
GDC005SGC	Capillary Blood Collection tube, Gel+Clot Activator, 0.5ml	1000	31×18.5×31



Item No.	Specification	Quantity (pcs)	Measurement (cm)
GDN0100A	10ml Plain Non-vacuum Blood tube, White cap	1000	84×20.5×25
GDN0100LH	10ml Lithium Heparin Non-vacuum Blood tube, Dark blue cap	1000	84×20.5×25



For safe and dustproof product transportation and usage, GongDong uses exquisite plastic shell as package. The exquisite shell is more convenient for usage.

### Advantage:

- ★ Exquisite Appearance
- ★ Safe & Dustproof
- ★ Recycle



Item No.	Specification	Quantity (pcs)	Measurement (cm)
GDN18G	Needle 18G×1 1/2"	4000	36×28×39
GDN20G	Needle 20G×1 1/2"	4000	36×28×39
GDN21G	Needle 21G×1 1/2"	4000	36×28×39
GDN22G	Needle 22G×1 1/4"	4000	36×28×39
GD-BF22G	Butterfly Needle 22G×3/4"	2000	48×32×32
GD-H	Holder	2000	48×25×42
GD-H1	Holder with safety cover	2000	69×43×36

# PETRI DISH



PETRI DISH



K1001

Item No.	Specification	Quantity (pcs)	Measurement (cm)
K1001	150×15mm Petri Dish	180	45×35×45



K1002

Item No.	Specification	Quantity (pcs)	Measurement (cm)
K1002	90×20mm Petri Dish	500	47×47×44



K1002-C

Item No.	Specification	Quantity (pcs)	Measurement (cm)
K1002-C	90×20mm Petri Dish	500	47×47×44



K1003

Item No.	Specification	Quantity (pcs)	Measurement (cm)
K1003	90×15mm Two-Compartment	500	47×34×47



K1004-J

Item No.	Specification	Quantity (pcs)	Measurement (cm)
K1004-J	90×15mm Petri Dish	500	47×47×34



K1004-J  
3 Vents

K1004-M

K1004-T

Item No.	Specification	Quantity (pcs)	Measurement (cm)
K1004-J 3 Vents	90×15mm 3 Vents Petri Dish	500	47×47×34
K1004-M	90×15mm for machine use Petri Dish	500	47×47×34
K1004-T	90×15mm 3vents Petri Dish	500	47×47×34



K1005

K1006

Item No.	Specification	Quantity (pcs)	Measurement (cm)
K1005	70×15mm	600	48×32×33
K1006	65×15mm	650	48×32×33



K1007

K1008

Item No.	Specification	Quantity (pcs)	Measurement (cm)
K1007	50×15mm	1000	46×30×35
K1008	30×15mm	2000	49×33×35



K1020

K1021

K1022

Item No.	Specification	Quantity (pcs)	Measurement (cm)
K1020	10ul Moss Blue (EOG)	3000	38×28×20
K1021	1ul White (EOG)	3000	38×28×20
K1022	Needle Type Red (EOG)	3000	38×28×20



# PETRI DISH



PETRI DISH



Item No.	Specification	Quantity (pcs)	Measurement (cm)
K1011	Stool Container 20ml Black Cap With Stick	1000	48×32×32
K1012	Culture Bottle 25ml White Cap With Stick	650	44×30×35
K1012-1	Culture Bottle 25ml red cap with spoon	650	44×30×35



Item No.	Specification	Quantity (pcs)	Measurement (cm)
K1013	Stool Container 60ml Red Cap With Stick	500	48×33×49
K1013-1	Stool Container 60ml Red Cap Without Stick	500	48×33×49
K1014	Stool container, 4ml	2000	49×33×33



Item No.	Specification	Quantity (pcs)	Measurement (cm)
K1015	30ml Sputum Container	500	48×32×34
K1016	40ml Sputum Container	500	39×39×39
K1017	25ml Sputum Container	650	46×30×32
K1017-1	25ml Sputum Container Skirted Bottom	650	50×30×35



Item No.	Specification	Quantity (pcs)	Measurement (cm)
K1018	30ml Sputum Container	1000	56.5×31×57
K1019	20ml Sputum Cassette	2000	48×32×31
K1018-1	20ml Sputum Container	1500	42.5×38×42.5



Item No.	Specification	Quantity (pcs)	Measurement (cm)
H1015	100ml-120ml Specimen Container	500/1000	58×58×40 (Individual Packing) 60×38×57 (Bulk Packing)
H1016	60ml Labeled Specimen Container	500	43×43×40 (Individual Packing) 43×43×37 (Bulk Packing)



Item No.	Specification	Quantity (pcs)	Measurement (cm)
K1026	Urine Container with needle, W/Lid. Labeled, Sterilized	250	59×30×43
GD0105UA	Vacuum Urine Tube, Yellow cap No Additive, 16×100mm, 10.5ml	1000	84×21×24
GD0105UB	Vacuum Urine Tube, Yellow cap Boric Acid, 16×100mm, 10.5ml	1000	84×21×24



Item No.	Specification	Quantity (pcs)	Measurement (cm)
H1016-1	PS Safety Sample Cup	500	43×43×33
H1016-2	90ml Specimen Container	500	43×43×33

Item No.	Specification	Quantity (pcs)	Measurement (cm)
H1021	Specimen container, 140ml	500	
K1025	Sputum container with mouth on cap, 30ml	500	48×32×34

Item No.	Specification	Quantity (pcs)	Measurement (cm)
K1023	Mucus Trap, 40CC	50	40×27×20
K1024	Mucus Trap, 80CC	50	40×27×20

# CENTRIFUGATION TUBE



CENTRIFUGATION TUBE



D1001



CAP

Item No.	Specification	Quantity (pcs)	Measurement (cm)
D1001	50ml Conical With White Graduation Green Cap	500	48×32×42
D1001	50ml Conical With Black Graduation Green Cap	500	48×32×42
D1001	50ml Conical With White Graduation Blue Cap	500	48×32×42
D1001	50ml Conical With Black Graduation Blue Cap	500	48×32×42



D1002



CAP

Item No.	Specification	Quantity (pcs)	Measurement (cm)
D1002	50ml Self-standing Blue Cap	500	70×40×25
D1002	50ml Self-standing White Cap	500	70×40×25

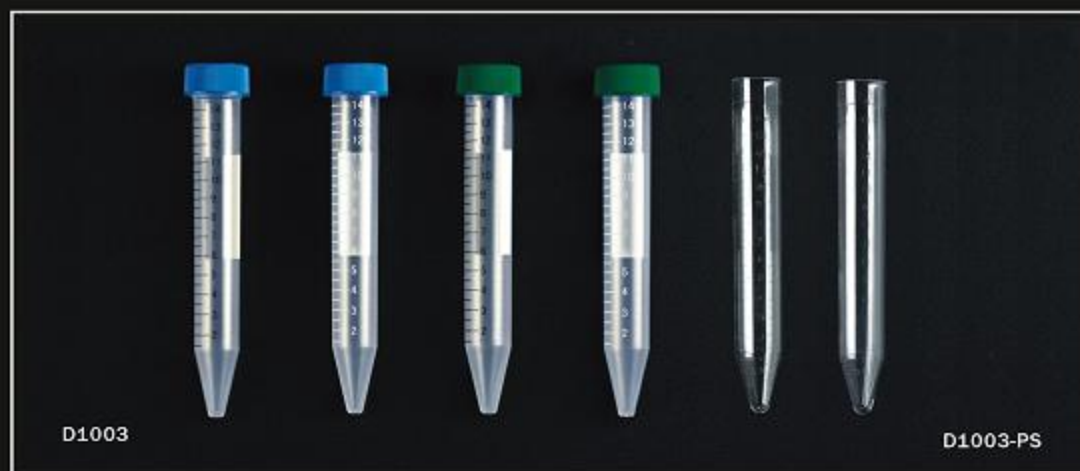

D1003

D1003-PS

Item No.	Specification	Quantity (pcs)	Measurement (cm)
D1003	15ml Conical With White Graduation Blue Cap	1000	44×28×37
D1003	15ml Conical With Black Graduation Blue Cap	1000	44×28×37
D1003	15ml Conical With White Graduation Green Cap	1000	44×28×37
D1003	15ml Conical With Black Graduation Green Cap	1000	44×28×37
D1003-PS	15ml Conical With Graduation	1000	44×28×37

# CENTRIFUGATION TUBE



CENTRIFUGATION TUBE



Item No.	Specification	Quantity (pcs)	Measurement (cm)
D1004	50ml	1000	49×33×33
D1005	15ml	1500	49×33×33
D1006	10ml	2000	49×33×33
D1008	5ml+Cap	3000	48×32×42

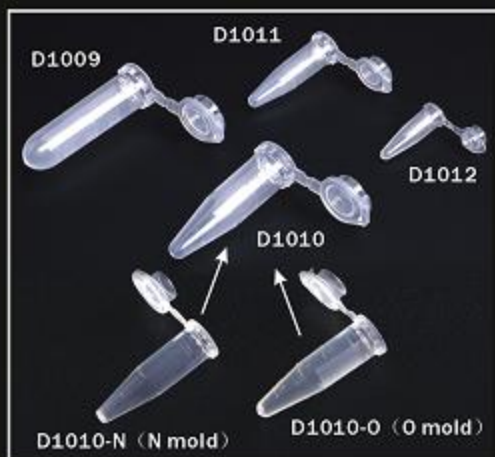

Item No.	Specification	Quantity (pcs)	Measurement (cm)
D1009	2ml	5000	48×32×32
D1010	1.5ml With Transparent Cap	6000	49×33×33
D1011	0.5ml	12000	49×33×33
D1012	0.2ml	30000	48×32×32



Item No.	Specification	Quantity (pcs)	Measurement (cm)
D1010-1	1.5ml With Colourful Cap	6000	49×33×33



Item No.	Specification	Quantity (pcs)	Measurement (cm)
D1013	5ml+Cap	2000	49×33×33
D1015	1.8ml	5000	48×32×32
D1016	1.8ml	5000	48×32×32



Item No.	Specification	Quantity (pcs)	Measurement (cm)
D1017	1.5ml Linked Green Cap	6000	49×33×33
D1018	1.5ml Linked Red Cap	6000	49×33×33

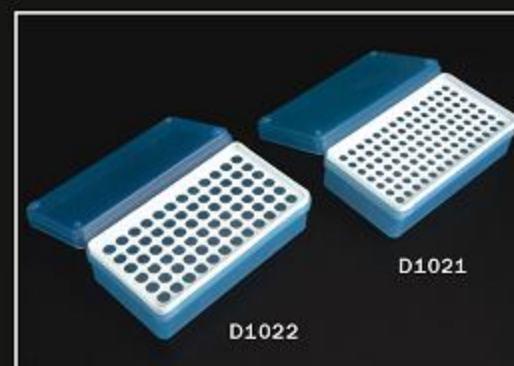

Item No.	Specification	Quantity (pcs)	Measurement (cm)
D1021	98 Wells Tube Rack For 0.5ml	40	48×33×32
D1022	72 Wells Tube Rack For 1.5ml	40	48×33×32

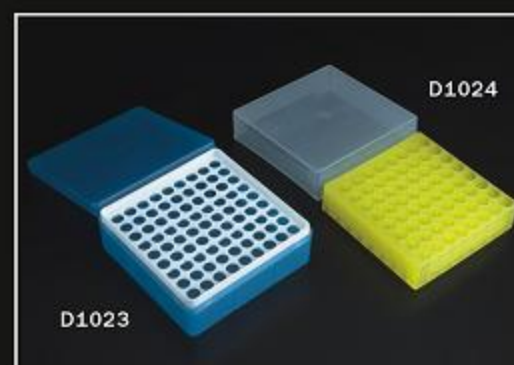

Item No.	Specification	Quantity (pcs)	Measurement (cm)
D1023	81 Wells Tube Rack For 1.5ml	40	48×33×32
D1024	Two Purpose Tube Rack	50	48×33×32

# PIPETTE TIP



PIPETTE TIP



Item No.	Specification	Quantity (pcs)	Measurement (cm)
E1007	200ul-1000ul Fit For Eppendorf	10000	48×32×38
E1008	10ul-300ul Fit For Eppendorf	30000	48×32×44
E1009	10ul 4×49mm Fit For Eppendorf	60000	48×32×32



Item No.	Specification	Quantity (pcs)	Measurement (cm)
E1010	10ul 5×32mm Fit For Gilson	60000	49×33×33
E1010-1	10ul 5×32mm With Filter Fit For Gilson	60000	49×33×33
E1011	10ul-200ul 6×50mm Fit For Gilson	30000	48×32×32
E1012	10ul-200ul 6×50mm Fit For Gilson	30000	48×32×32
E1013	200ul-1000ul 8×71mm Fit For Gilson	10000	48×32×38



Item No.	Specification	Quantity (pcs)	Measurement (cm)
E1014	10ul 5×32mm Fit For Finland	60000	49×33×33
E1015	10ul-200ul 6×50mm Fit For Finland	30000	48×32×32
E1016	10ul-250ul 6×52mm Fit For Finland	25000	48×32×32
E1017	200ul-1000ul 8×71mm Fit For Finland	10000	48×32×38



Item No.	Specification	Quantity (pcs)	Measurement (cm)
E1018	200ul-1000ul 8×71mm Fit For Switzerland	10000	48×32×38
E1019	10ul-200ul 6×50mm Fit For Switzerland	30000	48×32×32



Item No.	Specification	Quantity (pcs)	Measurement (cm)
E1020-1	10ul-1000ul With Filter Fit For Gilson	10000	48×32×32
E1021-1	10ul-200ul 6×50mm With Filter Fit For Gilson	30000	49×33×38



Item No.	Specification	Quantity (pcs)	Measurement (cm)
E1020	200ul-1100ul Automatic Inductive Tip for Bio-Rad	8000	49×33×38
E1021	300ul Automatic Inductive Tip for Bio-Rad	16000	48×32×32

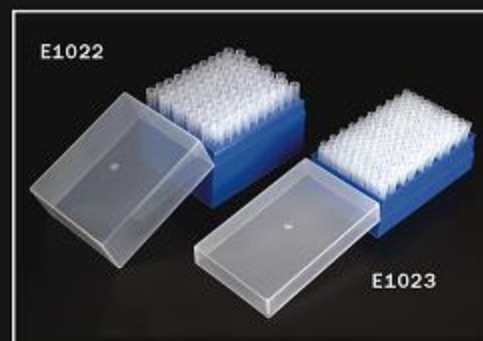

Item No.	Specification	Quantity (pcs)	Measurement (cm)
E1022	Tips Box 100wells For 1000ul	30	48×32×32
E1023	Tips Box 200 wells For 200ul	40	48×32×32

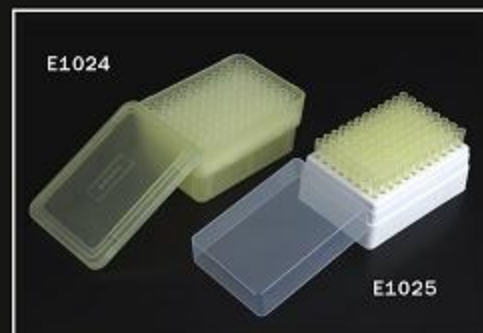

Item No.	Specification	Quantity (pcs)	Measurement (cm)
E1024	Tips Box 96 Wells For 200ul	68	48×32×32
E1025	Tips Box 96 Wells For 200ul&10ul	68	48×32×32

# CULTURE PLATE



Item No.	Specification	Quantity (pcs)	Measurement (cm)
F1001	72 Wells Culture Plate	800	49×33×33
F1002	40 Wells Culture Plate	600/550	49×33×33
F1003-U	"U" Bottom 96 Wells Culture Plate	270	48×32×32
F1003-F	"F" Bottom 96 Wells Culture Plate	270	48×32×32
F1003-V	"V" Bottom 96 Wells Culture Plate, Without Lid	270	48×32×32



Item No.	Specification	Quantity (pcs)	Measurement (cm)
F1004	24 Wells Culture Plate	170	43×27×21
F1008	20 Wells Plate	180	49×33×33



Item No.	Specification	Quantity (pcs)	Measurement (cm)
F1005	96 Wells Detachable Culture Plate	270	43×27×21



Item No.	Specification	Quantity (pcs)	Measurement (cm)
F1021	96 Wells Detachable Tissue Culture Plate, suitable for 8 or 12 wells strip	270	43×27×21



Item No.	Specification	Quantity (pcs)	Measurement (cm)
F1014	25u&35ul	16000	48×32×32
F1015	1ml	5000	54×34×38
F1016	3ml	5000	54×34×42
F1016-I	3ml Individual Packing	2500	61×41×41



Item No.	Specification	Quantity (pcs)	Measurement (cm)
F1016-1	1.5ml PIPET	5000	54×34×38
F1016-2	1ml SPOID(Blood Collecting)	5000	54×34×38

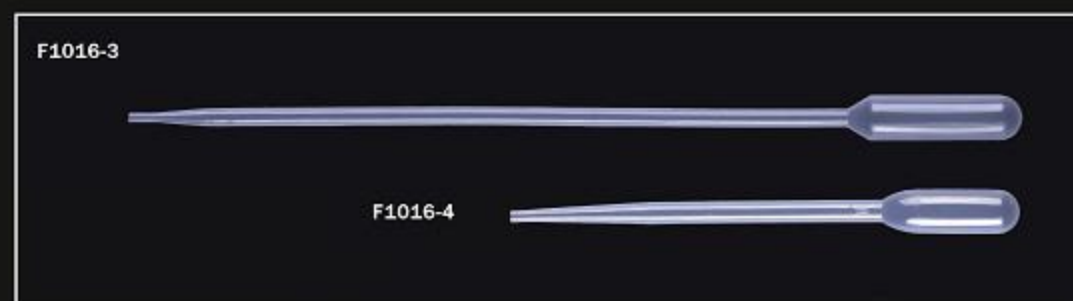

Item No.	Specification	Quantity (pcs)	Measurement (cm)
F1016-3	3.5ml PIPET	4000	54×34×40
F1016-4	1ml SPOID	5000	54×34×38



CULTURE PLATE

# CULTURE PLATE

F1016-5



F1016-6



Item No.	Specification	Quantity (pcs)	Measurement (cm)
F1016-5	3.5ml PIPET	4000	54×34×40
F1016-6	2ml PIPET	5000	54×34×42

F1016-7



F1016-8



Item No.	Specification	Quantity (pcs)	Measurement (cm)
F1016-7	5ml PIPET	4000	54×34×40
F1016-8	1ml fine tip PIPET	5000	54×34×38

F1016-9



F1016-10



Item No.	Specification	Quantity (pcs)	Measurement (cm)
F1016-9	2ml SPOID	5000	54×34×42
F1016-10	0.5ml	10000	49×33×33

F1006



F1007



Item No.	Specification	Quantity (pcs)	Measurement (cm)
F1006	52 Wells Reaction Plate	260	49×33×33
F1007	32 Wells Reaction Plate	360	49×33×33

F1009



Item No.	Specification	Quantity (pcs)	Measurement (cm)
F1009	Embedding Cassette	5000	48×32×44

F1010



F1011



Item No.	Specification	Quantity (pcs)	Measurement (cm)
F1010	Embedding Cassette White	4000	48×32×32
F1011	Embedding Cassette Green	2700	48×32×32

F1012



F1013



Item No.	Specification	Quantity (pcs)	Measurement (cm)
F1012	Isotope Bottle	1000	49×33×33
F1013	Anticoagulant Bottle	3200	61×41×41

F1017



F1018



Item No.	Specification	Quantity (pcs)	Measurement (cm)
F1017	5 Slices Dye Jar	320	48×32×32
F1018	10 Slices Dye Jar	230	48×32×32



CULTURE PLATE

# TEST TUBE



Item No.	Specification	Quantity (pcs)	Measurement (cm)
G1001	15×100mm,10ml	2000	43×35×33
G1002	13×100mm,7ml	3000	43×35×38
G1003	13×78mm,5.5ml	4008	48.5×32.5×31.5



Item No.	Specification	Quantity (pcs)	Measurement (cm)
G1004	12×60mm,3.5ml	6000	49.5×33×33
G1005	12×75mm,5mlps	4800	49.5×33×33
G1006	12×78mm,5.5ml	4800	49.5×33×33



Item No.	Specification	Quantity (pcs)	Measurement (cm)
G1007	16×53mm 6ml With Cap	3000	49.5×33×37
G1008	14×41mm 3ml With Cap	4500	49.5×33×37



Item No.	Specification	Quantity (pcs)	Measurement (cm)
G1009	13×100mm 7ml With Cap	3000	43×33×42
G1010	12×75mm 5ml With Cap	4800	49×33×38
G1011	12×60mm,3.5ml	6000	49×33×33



Item No.	Specification	Quantity (pcs)	Measurement (cm)
G1012	12×75mm,5ml	4008	48×32×32.5
G1013	12×75mm,5ml	4800	48×32×32.5
G1014	10×70mm,2.8ml	6600	48×32×32.5



Item No.	Specification	Quantity (pcs)	Measurement (cm)
G1015	15×100mm,5ml	2800	48×32×32.5
G1016	12ml With Cap	2800	48×32×32.5
G1017	12ml Urine Cup	1500	48×33×33
G1017-1	12ml Urine Cup with cap	1500	48×33×33



Item No.	Specification	Quantity (pcs)	Measurement (cm)
G1018	13×75mm,5.5ml	3600	48×33×33
G1019	15×50mm,4.5ml	3600	48×33×33



Item No.	Specification	Quantity (pcs)	Measurement (cm)
G1020	13×75mm,5.5ml	4800	49×32×33
G1021	12×75mm, 5ml pp/ps	4800	49×32×33



Item No.	Specification	Quantity (pcs)	Measurement (cm)
G1022	13×150mm,Tube With Swab	1800	54×35×27
G1023	13×75mm,Tube With Swab	2200	48×32×32
G10261	Cotton Swab With Amies Medium	600	54×35×27
G10262	Cotton Swab With Amies+Charcoal Medium	600	54×35×27
G10263	Cotton Swab With Cary Blair Medium	600	54×35×27
G10264	Cotton Swab With Stuart Medium	600	54×35×27
G10265	Cotton Swab With Stuart+Charcoal Medium	600	54×35×27



Item No.	Specification	Quantity (pcs)	Measurement (cm)
G1024	15×150mm,15ml	1500	49×33×33



TEST TUBE

# TUBE RACK

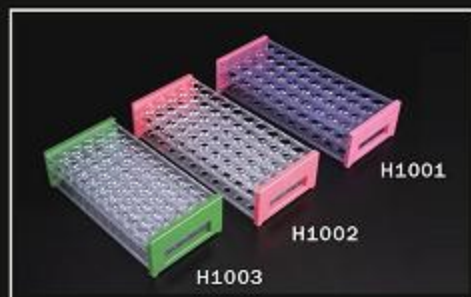

Item No.	Specification	Quantity (pcs)	Measurement (cm)
H1001	40 Wells $\phi$ 18mm Tube Rack	40	38×25×25
H1002	50 Wells $\phi$ 15mm Tube Rack	40	38×25×25
H1003	50 Wells $\phi$ 13mm Tube Rack	40	38×25×25

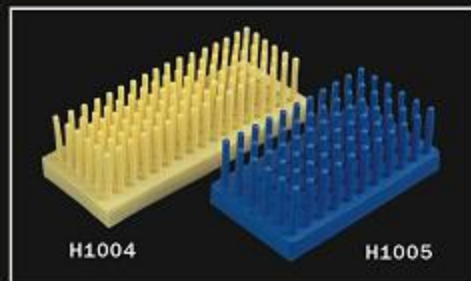

Item No.	Specification	Quantity (pcs)	Measurement (cm)
H1004	Pillar-Like $\phi$ 18mm Tube Rack	54	48×32×32
H1005	Pillar-Like $\phi$ 15mm Tube Rack	51	48×32×32

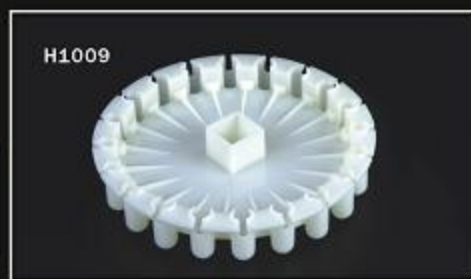

Item No.	Specification	Quantity (pcs)	Measurement (cm)
H1009	Washing Plate Natural White	200	54×35×38



Item No.	Specification	Quantity (pcs)	Measurement (cm)
H1013	Centrifugation Rack Orange, For 50ml, 15ml	50	44×28×37



Item No.	Specification	Quantity (pcs)	Measurement (cm)
H1018	Multi-Function Rack (Blue And Orange)	50	61×41×41



Item No.	Specification	Quantity (pcs)	Measurement (cm)
H1019	Double-Deck Multi-Function Rack	25	61×41×41



TUBE RACK

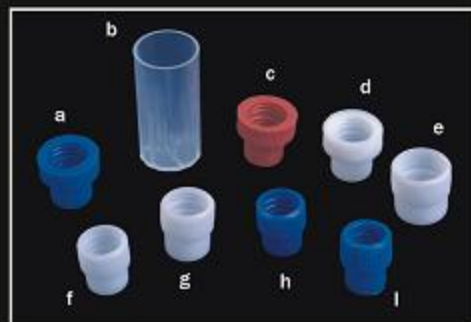

Item No.	Specification	Quantity (pcs)	Measurement (cm)
H1010 (a, c, d)	Tube Stopper For $\phi$ 13mm	20000	48×32×42
H1011(b)	Tube Stopper For $\phi$ 13mm	18000	48×32×42
H1011-1 (g, i)	Tube Stopper For $\phi$ 13mm	18000	48×32×42
H1012(e)	Tube Stopper For $\phi$ 15mm	15000	48×32×42
H1006(h)	Tube Stopper For $\phi$ 12mm	20000	44×32×32
H1014(f)	Tube Stopper For $\phi$ 12mm	24000	44×32×32



Item No.	Specification	Quantity (pcs)	Measurement (cm)
H1014-1	Tube stopper(Universal type), For $\phi$ 12mm	22000	49×33×33
H1014-2	Tube stopper(Universal type), For $\phi$ 13mm	18000	49×33×33



# COLORIMETRIC CUP

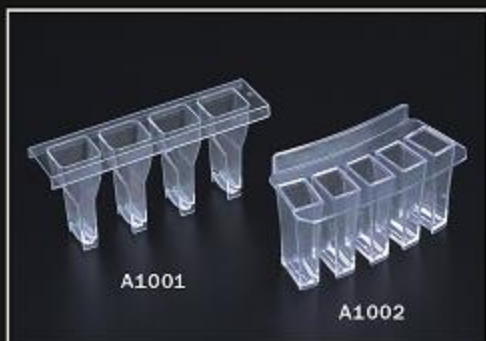

Item No.	Specification	Quantity (pcs)	Measurement (cm)
A1001	Tianjin Pulisheng & French Stago	1600	49×33×33
A1002	American MD2000/1800	960	49×33×33



Item No.	Specification	Quantity (pcs)	Measurement (cm)
A1003	CA 100 Mid-Asia	15000	49×33×33
A1004	French Organon	2688	49×33×33
A1005	BN 100 Special Protein Apparatus	2688	49×33×33

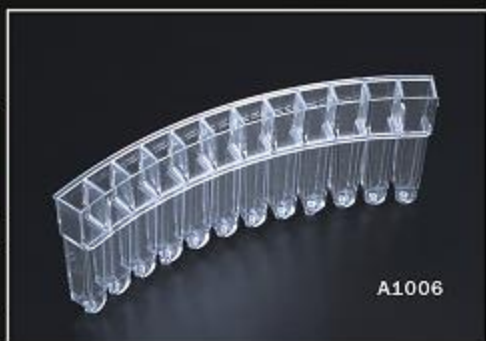

Item No.	Specification	Quantity (pcs)	Measurement (cm)
A1006	Roche Biochemical Analysis Cup	500	49×33×33

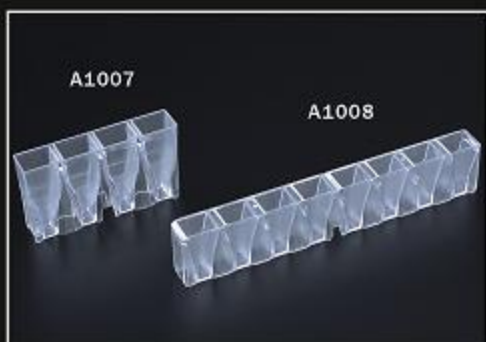

Item No.	Specification	Quantity (pcs)	Measurement (cm)
A1007	American Pacific, German TECO	3200	49×33×33
A1008	Beckman	1500	49×33×33



Item No.	Specification	Quantity (pcs)	Measurement (cm)
A1009	Italy BT2245	1000	49×33×33

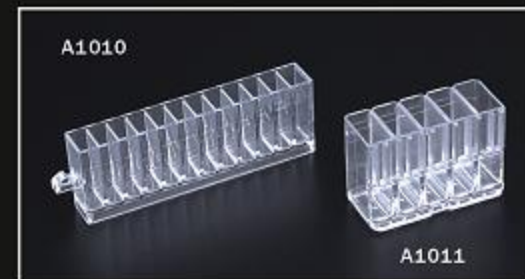

Item No.	Specification	Quantity (pcs)	Measurement (cm)
A1010	Finland Kangyi 12 Holes	3200	56×33×30
A1011	Corning Cups 5 Holes	2366	49×33×33



Item No.	Specification	Quantity (pcs)	Measurement (cm)
A1012	German BECL4 8Holes	1000	49×33×33
A1013	German BECL4 4Holes	2000	48×32×32
A1014	German BECL4 2Holes	4000	48×32×32



Item No.	Specification	Quantity (pcs)	Measurement (cm)
A1015	German BE 4 Holes	3500	49×33×33
A1016	German BE 2 Holes	7000	48×32×32
A1017	German BE 1 Hole	24000	48×32×32



Item No.	Specification	Quantity (pcs)	Measurement (cm)
A1018	Spain Cruor Apparatus	8000	49×33×33
A1019	German Labor	10000	49×33×33
A1020	German TECO Sample Cup	12000	49×33×33



COLORIMETRIC CUP

# COLORIMETRIC CUP



Item No.	Specification	Quantity (pcs)	Measurement (cm)
B1001	German BE Automatic	2610	48×32×32



Item No.	Specification	Quantity (pcs)	Measurement (cm)
B1002	German Sigma KC-40	12000	49×33×33
B1003	German TECO 2 Holes	10000	49×33×33
B1004	German TECO 1 Hole	34000	49×33×33



Item No.	Specification	Quantity (pcs)	Measurement (cm)
B1005	Abbott AXSYM	3600	48×33×33
B1006	Abbott AXSYM Reaction Jar	1200	48×33×33



Item No.	Specification	Quantity (pcs)	Measurement (cm)
B1007	Blood Tube	3000	49×33×33
B1008	Swiss SEROZYME	4000	49×33×33



Item No.	Specification	Quantity (pcs)	Measurement (cm)
B1009	Japan Dongya CA 1500	20000	48×32×37
B1010	Japan Dongya CA 530	20000	48×32×37
B1011	Japan Dongya CA 6000	20000	48×32×37



Item No.	Specification	Quantity (pcs)	Measurement (cm)
B1020	Japan Dongya CA7000	20000	48×32×37



Item No.	Specification	Quantity (pcs)	Measurement (cm)
B1012	American Beckman Special Protein ARRY-360 Sample Cup	400	49×33×33



Item No.	Specification	Quantity (pcs)	Measurement (cm)
B1013	Color Dilution Plate	100	49×33×33



Item No.	Specification	Quantity (pcs)	Measurement (cm)
B1014	Baojingman Automatic 10 Holes	1000	49×33×33



COLORIMETRIC CUP

# SAMPLE CUP



Item No.	Specification	Quantity (pcs)	Measurement (cm)
C1001	Hitachi 7150, 7060 Series: Aulinbas 2ml	5000	49×33×33
C1002	American Beckman CX Series, 0.5ml	8000	49×33×33
C1003	IL Sample Cup, Menarch Biochemical Analysis Apparatus(0.5ml)	13000	49×33×33



Item No.	Specification	Quantity (pcs)	Measurement (cm)
C1004	American Beckman 700(1.5ml) American Dupont Holland VITALAB SAMPLECUP	8000	49×33×33
C1005	Holland Vita lab 700	14000	48×32×32



Item No.	Specification	Quantity (pcs)	Measurement (cm)
C1006	AC900(22×45)	2100	56×33×30
C1007	CA490(22×60)	10000	54×35×38
C1008	Japan F800(30×70) Haematimeter Series	7500	56×33×30
C1009	Japan F800(30×60) Haematimeter Series	6000	48×32×32
C1010	Mairui(30×50)	10000	54×35×38



Item No.	Specification	Quantity (pcs)	Measurement (cm)
C1011	Holland ACE	24000	49×33×30
C1012	Swiss Cobas, White and Blue	12000	48×32×32



Item No.	Specification	Quantity (pcs)	Measurement (cm)
C1013	American M10, Italy BT2245 Biochemical Apparatus	20000	49×33×33
C1014	American Corning 560, 550 Series	18000	49×33×33
C1015	American M10, Italy BT2245 Biochemical Apparatus	10000	49×33×33

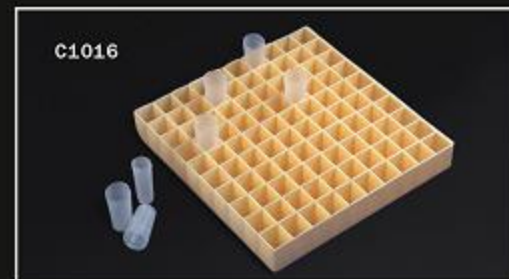

Item No.	Specification	Quantity (pcs)	Measurement (cm)
C1016	F800 100holes Sample rack	11	49×33×33



Item No.	Specification	Quantity (pcs)	Measurement (cm)
C1017	Hitachi Minimum	6000	49×33×33
C1018	American Yapel CCX	5000	49×33×33
C1019	Hitachi Conical	9000	49×33×33



Item No.	Specification	Quantity (pcs)	Measurement (cm)
C1020	Kodak Sample Cup	12000	49×33×33
C1021	Aulinbas Sample Cup	40000	49×33×33
C1022	Kodak Tip	16000	49×33×33



Item No.	Specification	Quantity (pcs)	Measurement (cm)
C1023	An' Tai 30 Holes Reaction Plate	900	49×33×30
C1024	An' Tai Sample Cup	26000	48×32×32



SAMPLE CUP