

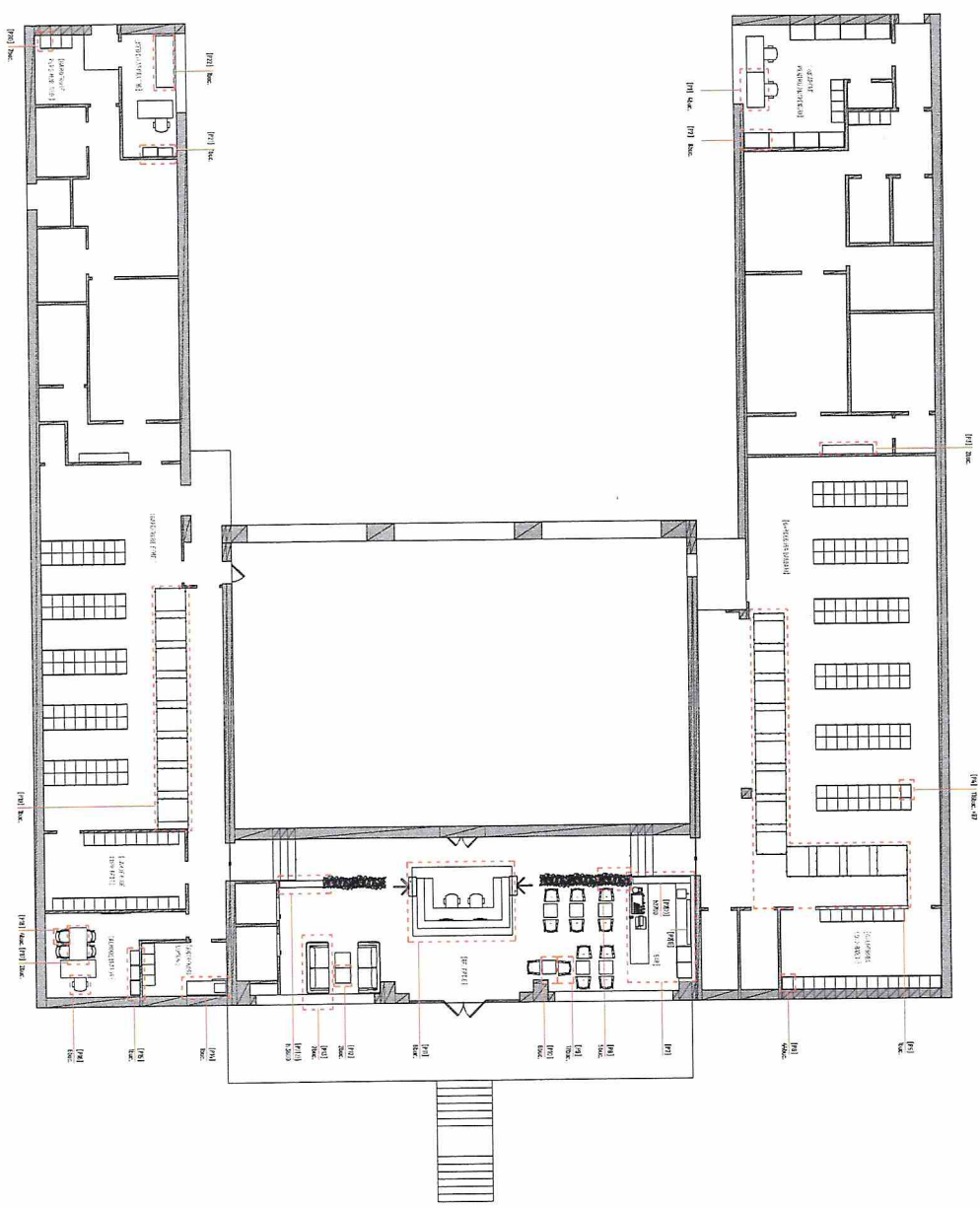

SPECIFICATIILE MOBILIER BAZIN DINAMO
str. Gh. Asachi 23A, mun. CHISINAU

PROIECT DESIGN MOBILIER
SPECIFICATIILE

PLAN CU TABEL SPECIFICATIIL



BORDEROU POZITIIL MOBILIER		
POZITIE	DESCRIERE	P
P1	Masa de lucru 700 x 1400 h/750	4
P2	Dulap metalic de depozitare echipament 1000 x 800 x 2200	8
P3	Scaun din metal si lemn 350 x 2000 h/450	2
P4	Garderoba pentru adulti 500 x 420 x 2200	2
P5	Cabine de schimbare haine Barbati (complex)	12
P6	Garderoba pentru copii 500 x 420 x 2000	4/4
P7	BAR	1
P8	Ghiveci cu plante decorative 300 x 1150 x 1100	5
P9	Scaun din lemn sau plastic	12
P10	Masa 550 x 550 x 750	6
P11	Receptie	1
P12	Masa de cafea 550 x 550 x 450	2
P13	Canapaa L 2m	2
P14	Masa tip chitinetă	1
P15	Dulap pentru mapse si garderoba pentru administrator	1
P16	Fotoliu de birou	6
P17	Masa atasament 1300 x 700 x 750	1
P18	Scaun de birou	4
P19	Cabine de schimbare haine Femei (complex)	8
P20	Garderole persoane cu mobilitate redusa	7
P21	Dulap pentru mapse si dulap pentru produse de laborator	7
P22	Pat medical	1

PROIECT DE DESIGN		
SPECIFICATIIL MOBILIER BAZIN DIMANNO, str. Gh. Asachi 23A, mun. CHISNAU		
SPECIFICATIIL MOBILIER		
Etapă	Planşa	Planşe
PE	1	19
PLAN CU TABEL SPECIFICATIIL		CHISNAU 2021

[P1]

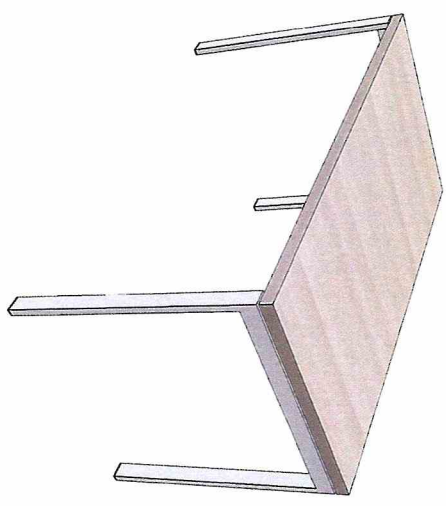
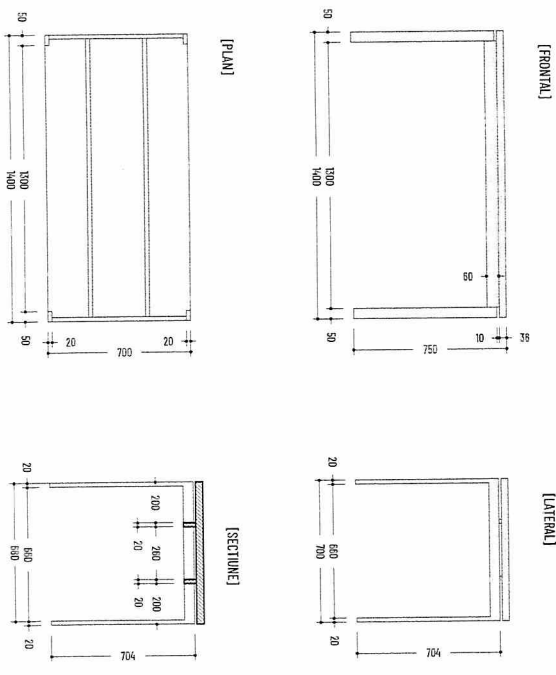

NOTA:

- Cantul (ABS) va fi pe tot perimetrul de 2mm.
- De verificat dimensiunile spatului si comunicatiile existente la obiect.
- La montare se va stabili amplasarea gaurii in masa pentru cabluri.

obiect	pozitie	material	culoare	cod
masa	top	Egger		H3328 S128
masa	picior	metal		Stelar gri bej
				RAL 9003

PROIECT DE DESIGN			
SPECIFICATIILE MOBILIER BAZIN DINAMKO, str. Gh. Asachi 23A, mun. CHISINAU			
SPECIFICATIILE MOBILIER			
POZITIE 1		Etapă	Planşa
Masa de lucru 700 x 1400 h/50		PE	2
			19
		CHISINAU 2021	

[P 2]

[FRONTAL]

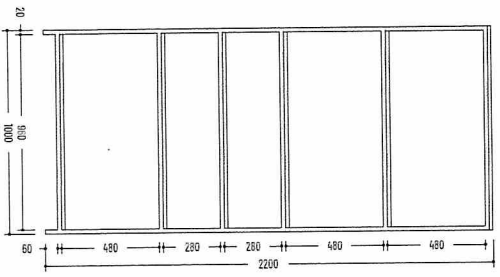

[SECTIUNE LATERAL]

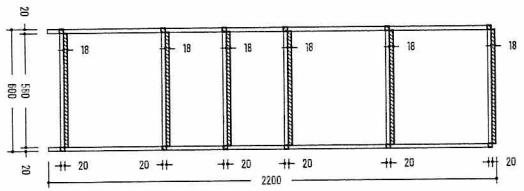

[SECTIUNE FRONTAL]

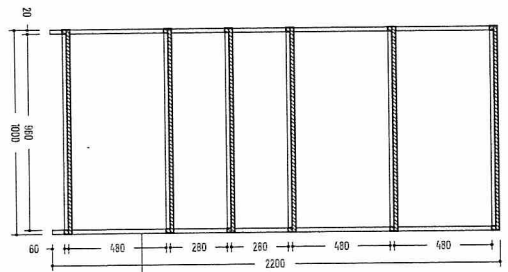

METAL 20x20

[PLAN]

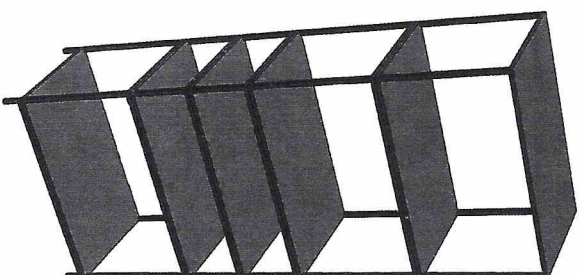
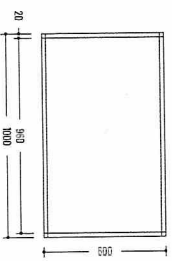

NOTA:

- Cantul (ABS) va fi pe tot perimetrul de 2mm.
- De verificat dimensiunile spațiului și comunicațiile existente la obiect.

obiect	pozitie	material	culoare	cod
masa	raft	Egger		U961
masa	carcasa	metal		RA19011

PROIECT DE DESIGN			
SPECIFICATIILE MOBILIER BAZIN DINAMO, str. Gh. Asachi 23A, mun. CHISNAU			
SPECIFICATIILE MOBILIER		Etapă	Planșa
Dulap metalic de depozitare echipament 1000 x 600 x 2200		PE	3
POZITIE 2		Planse	19
CHISNAU 2021			

[P 3]

[FRONTAL]

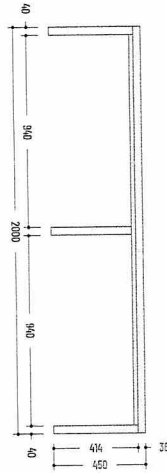

[LATERAL]

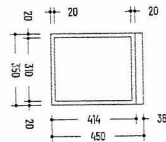

[PLAN]

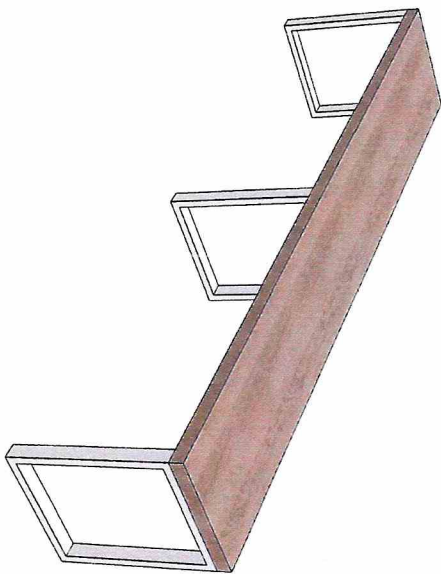
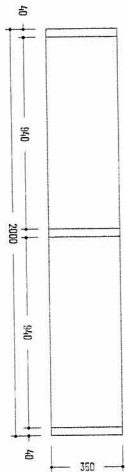

NOTA:

- Cantul (ABS) va fi pe tot perimetrul de 2mm
- De verificat dimensiunile spațiilor și comunicațiile existente la obiect.

obiect	pozitie	material	culoare	cod
scavn	top	Egger		H3326 ST28
scavn	picior	metal		Stelar grl bej RAL90 03

PROIECT DE DESIGN			
SPECIFICATIILE MOBILIER BAZIN DINAMO, str. 6th, Asachi 23A, mun. CHISNAU			
SPECIFICATIILE MOBILIER		Etapa	Planșa
POZITIE 3		PE	4
Scavn din metal si lemn 350 x 2000 h450		Planșa	19
		CHISNAU 2021	

[P 4]

[FRONTAL]

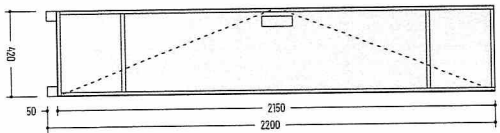

[SECȚIUNE]

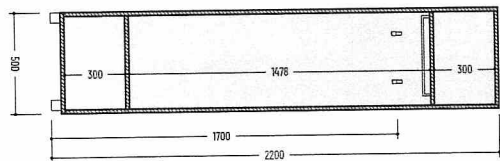

[PLAN]

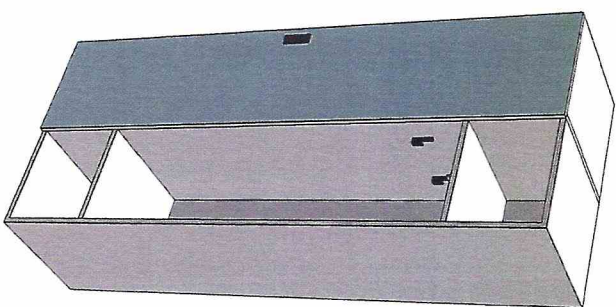
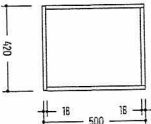

NOTA:

- Cantul (ABS) va fi pe tot perimetrul de 2mm
- De verificat dimensiunile spațiului și comunicațiile existente la obiect.

obiect	poziție	material	culoare	cod
garderoaba	corp	Egger		U732
garderoaba	fațadă	Egger		US00ST19
garderoaba	picior		negru	
garderoaba	maner		antracit	
garderoaba	cutere		negru	

PROIECT DE DESIGN			
SPECIFICAȚII MOBILIER BAZIN DIMANCI, str. 6th Asachi 23A, mun. CHISINAU			
SPECIFICAȚII MOBILIER			
POZȚIE 4			
Garderoaba pentru mături 500 x 420 x 2200			
Etapă	Planșa	Planșe	
PE	5	19	
			CHISINAU 2021

[P 5] / [P 19]

[FRONT]

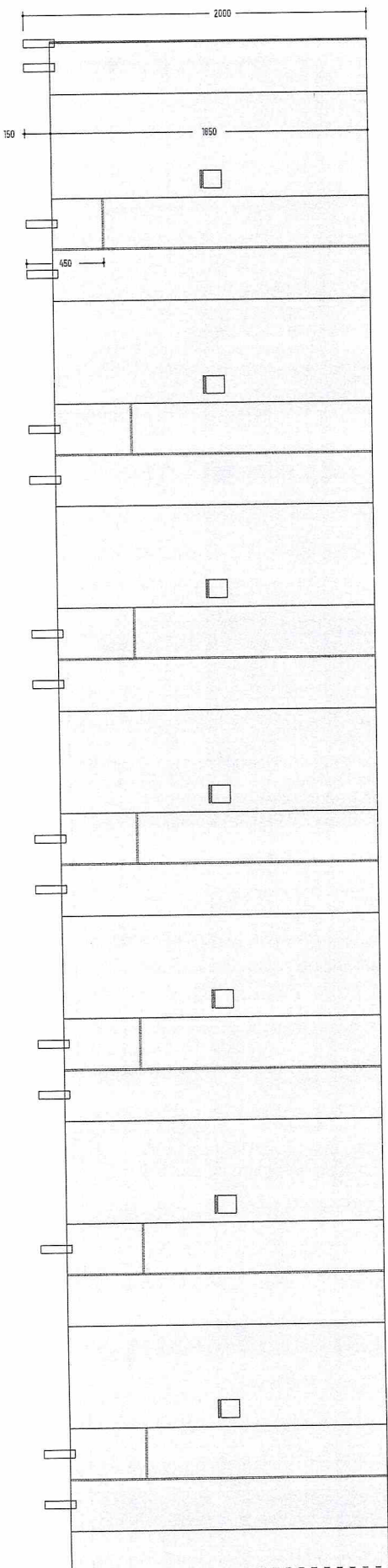

[PLAN]

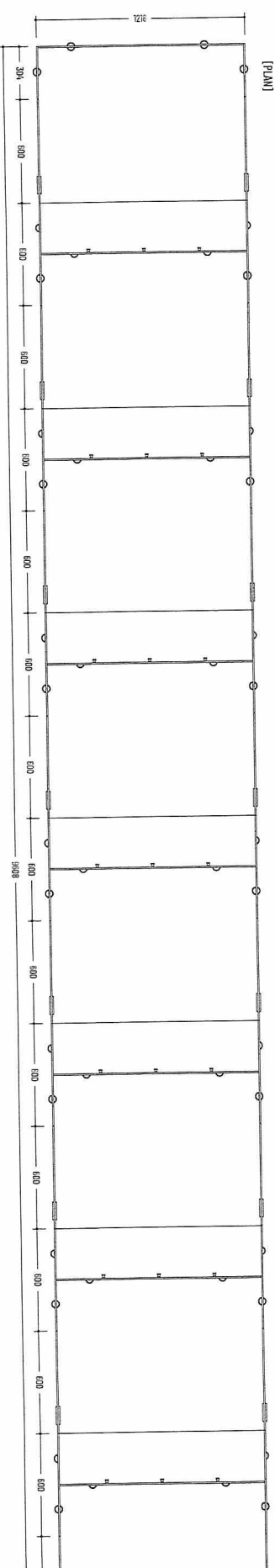

- NOTA:**
- Pentru executia garderobeilor sw va respecta tehnologia producatorului FUNDERMAX
 - De verificat dimensiunile spatiului si comunicatiile existente la obiect.

obiect	pozitie	material	culoare	cod
garderoaba	fatada	HPL		0830
garderoaba	fatada	HPL		Sea Green
garderoaba	fatada	HPL		0077
				Charcoal

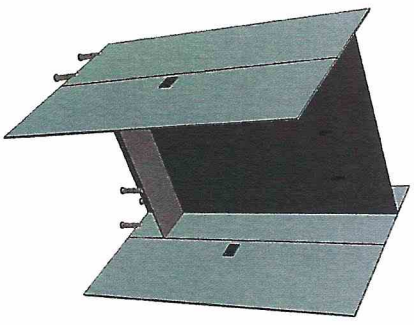

PROIECT DE DESIGN			
SPECIFICATIILE MOBILIER BAZIN DIAMOND, str. Gh. Asachi 23A, mun. CHISINAU			
SPECIFICATIILE MOBILIER			
POZITIE 5/19			
Cabine de schimbata haine Barbati/Femei (complex)			
Etapă	Planşa	Planşe	
PE	6	19	
CHISINAU 2021			

[FRONTAL]

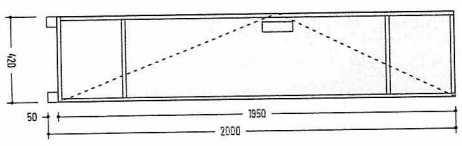

[SECTIONE]

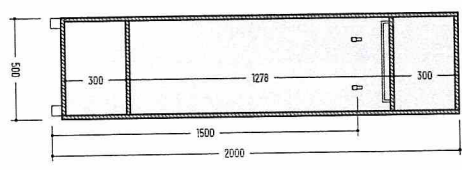

[PLAN]

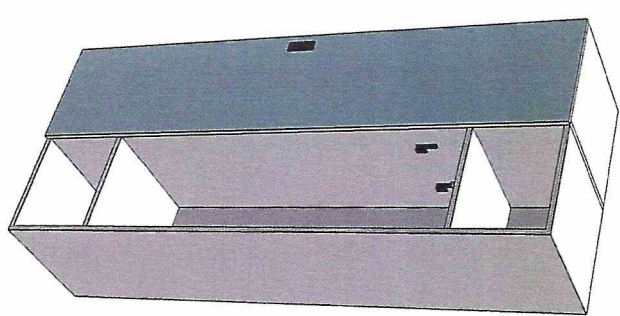
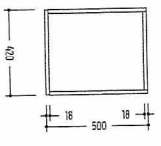

NOTA:

- Cantul (ABS) va fi pe tot perimetrul de 2mm
- De verificat dimensiunile spatului si comunicatiile existente la obiect.

obiect	pozitie	material	culoare	cod
garderoba	corp	Egger		U732
garderoba	fatada	Egger		U500S19
garderoba	picior		negru	
garderoba	maner		antracit	
garderoba	cutere		negru	

PROIECT DE DESIGN			
SPECIFICATIILE MOBILIER BAZIN DIAMAO, str. Gh. Asachi 23A, mun. CHISINAU			
SPECIFICATIILE MOBILIER			
POZITIE 6		Etapa	Planse
Garderoba pentru copii 500 x 420 x 2000		PE	19
		7	
			CHISINAU 2021

[P 7]

[SECTIUNII]

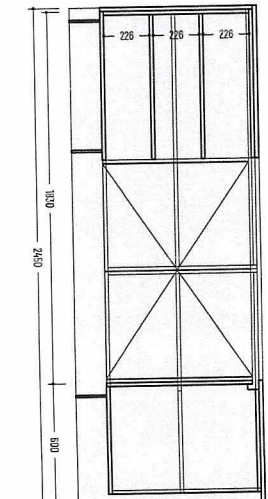
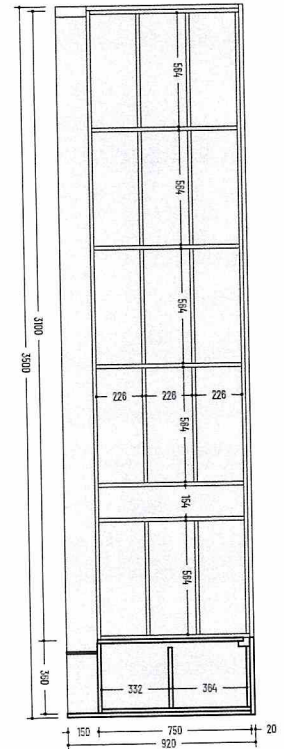
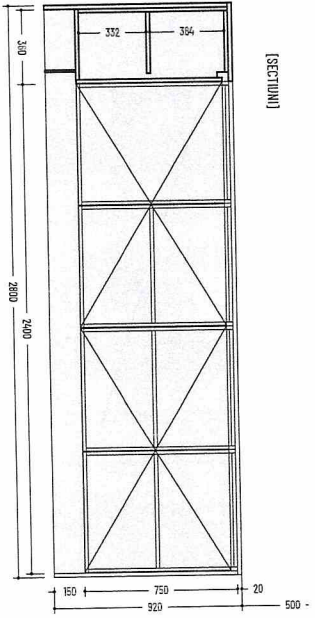

[PLAN]

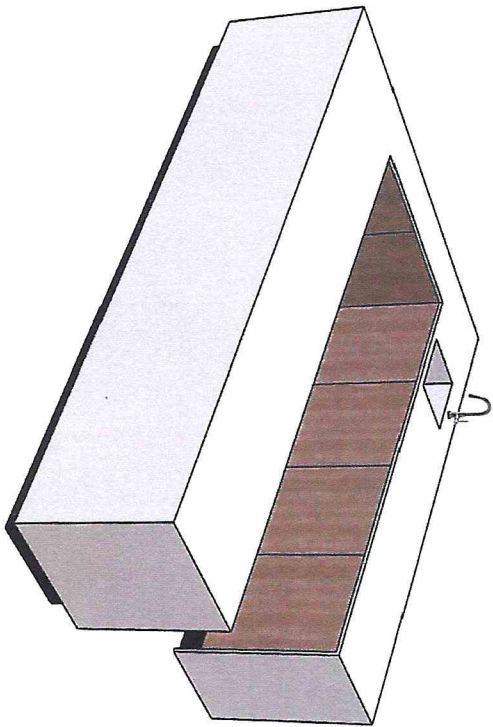
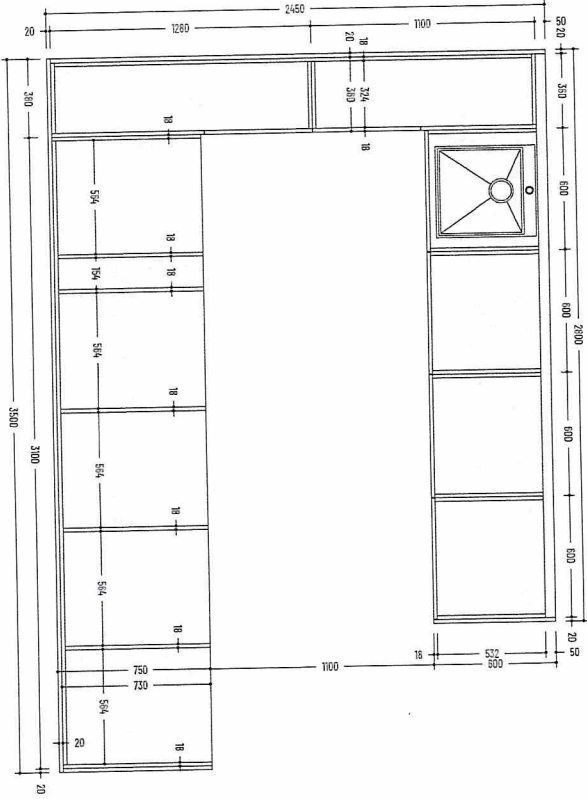

- NOTA:
- Furnitura aleasa va fi asemanator BLUM cu sistem de deschidere si inchidere lent si silentios
 - Cantul (ABS) va fi pe tot perimetrul de 2mm.
 - De verificat dimensiunile spatului si comunicatiile existente la obiect.

obiect	pozitie	material	culoare	cod
bar	corp	Egger		U732
bar	fatada exterior	AGT		734
bar	fatada interior	Egger		H8328S128

PROIECT DE DESIGN

SPECIFICATIIL MOBILIER BAZIN DINAMO, str. Gh. Asachi 23A, mun. CHISINAU

SPECIFICATIIL MOBILIER

Etapa	Planşa	Planşe
PE	8	19

POZITIE 7
BAR CHISINAU 2021

[P 7(1)]

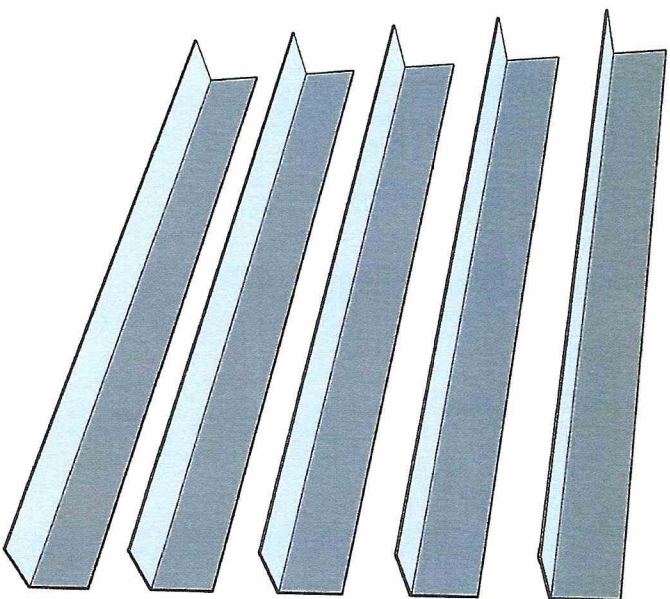
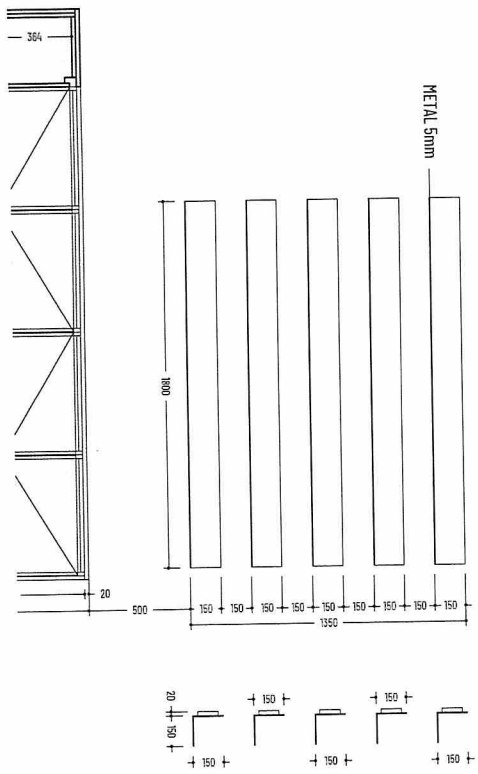

obiect	pozitie	material	culoare	cod
Bar	raft	metal		RAL 5027

PROIECT DE DESIGN			
SPECIFICATIILE MOBILIER BAZIN DINAMU, str. Gh. Asachi 23A, mun. CHISINAU			
SPECIFICATIILE MOBILIER		Etapă	Planşa
POZITIE 7 BAR		PE	19
		CHISINAU 2021	

[P 7(2)]
H2700/3600

[LATERAL]

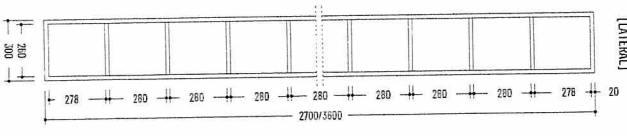

[FRONTAL]

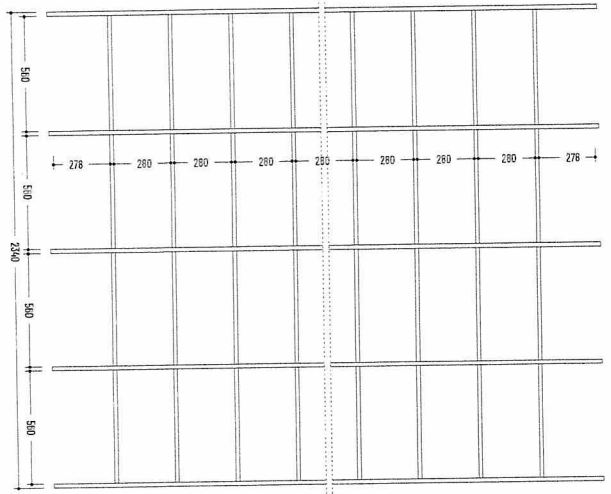

[SECTIONE 1]

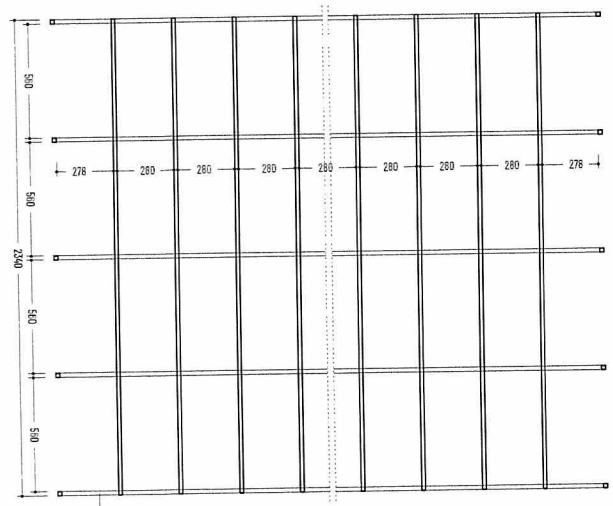

METAL 20x20

- NOTA:
- Furnitura aleasa va fi asamblator QJUM cu sistem de deschidere si inchidere lemii si salinitus.
 - Cantul (ABS) va fi pe tot perimetrul de 2mm.
 - De verificat dimensiunile spatului si comunicatiile existente la obiect.

obiect	pozitie	material	culoare	cod
rafturi	raft	Egger		H3326
rafturi	carcasa	metal		RAL901 6

[PLAN]

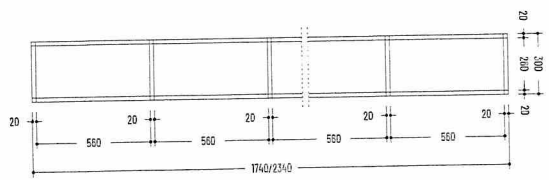

RAFT
1740x3600

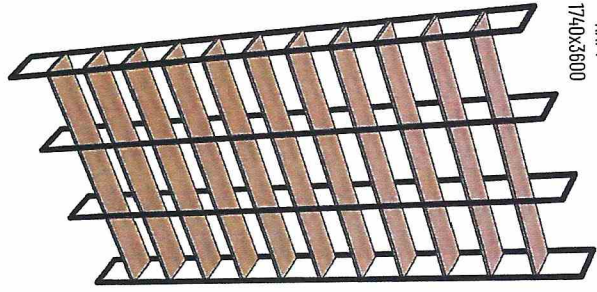

RAFT
2340x2700

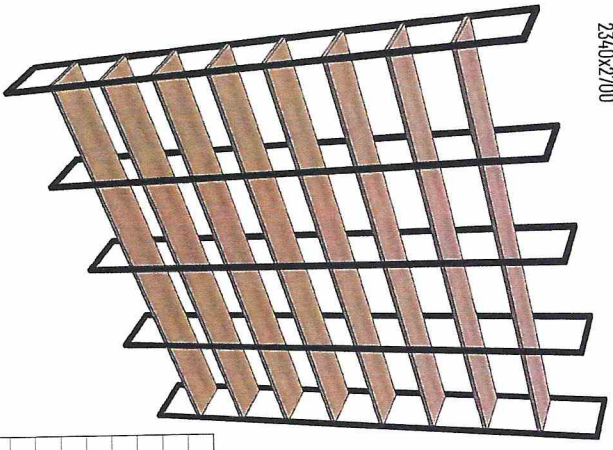

PROIECT DE DESIGN			
SPECIFICATIIL MOBILIER BAZIN DIAMOND, str. Gh. Asachi 23A, mun. CHISINAU			
SPECIFICATIIL MOBILIER		Etapă	Planşa
POZITIE 7 BAR		PE	10
			19
		CHISINAU 2021	

[P 8]

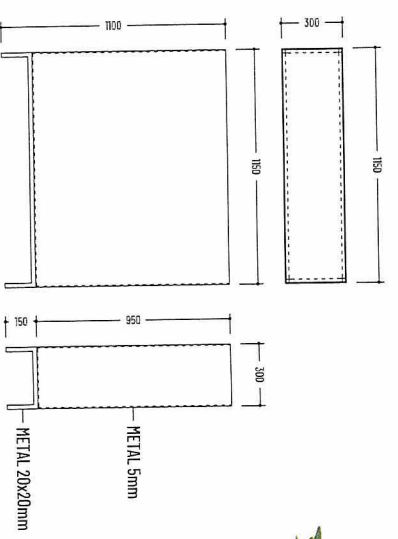

[P 10]

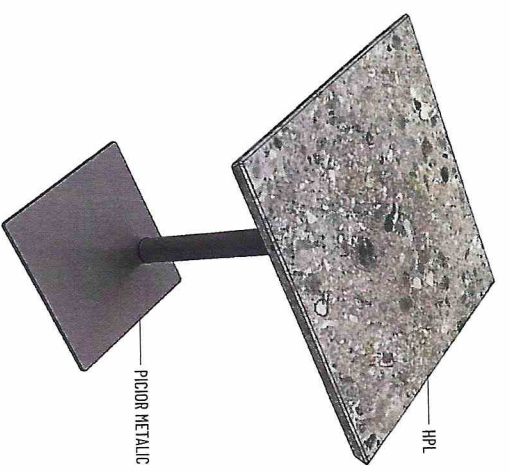
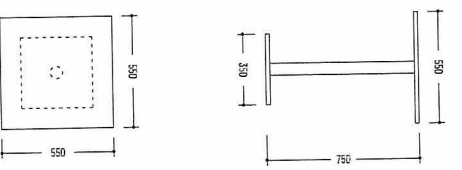

[P 9]

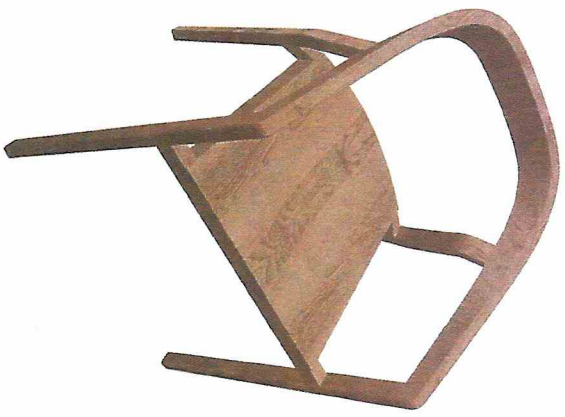

PROIECT DE DESIGN			
SPECIFICATIILE MOBILIER BAZIN DINAMO, str. Gh. Asachi 23A, mun. CHIȘNĂU			
SPECIFICATIILE MOBILIER		Etapă	Planșa
		PE	11
			19
POZIȚIE 8 Ghiveci cu plante decorative 300 x 1150 x 1100			
POZIȚIE 9 Scaun din lemn sau plastic			
POZIȚIE 10 Masa 550 x 550 h 750			
			CHIȘNĂU 2021

[P 11]

[SECTIUNE FRONTAL]

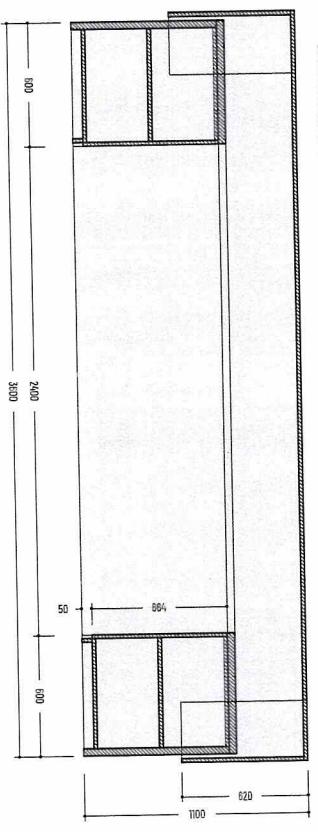

[FRONTAL]

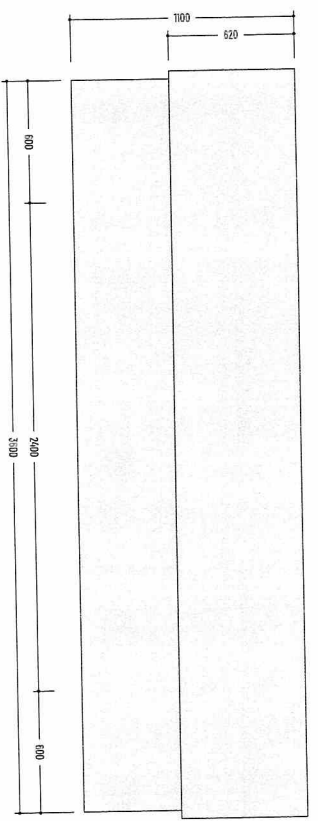

[PLAN]

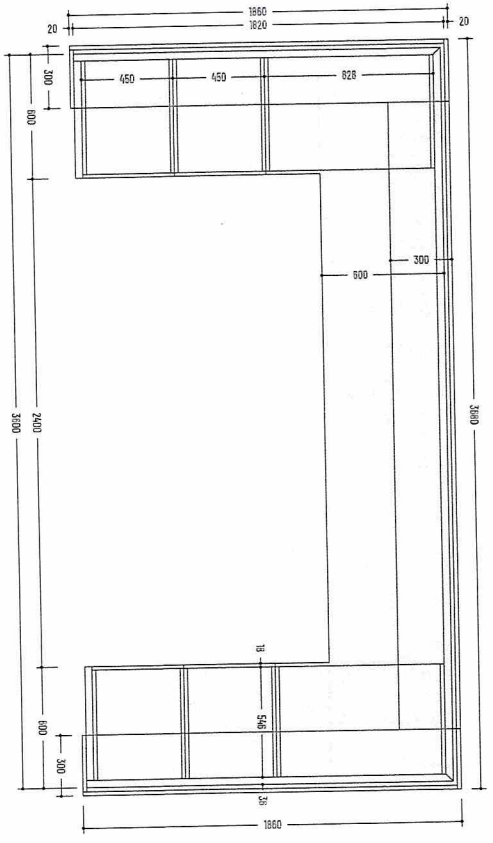

[SECTIUNE LATERAL]

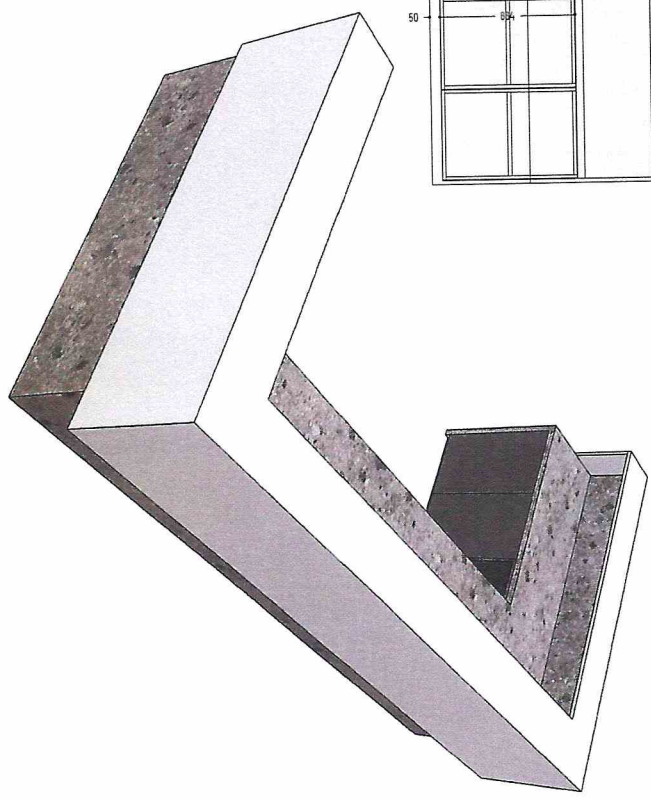
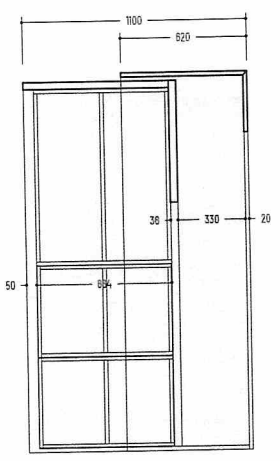

- NOTA:
- Furtitura aleasa va fi asamblator BLUM cu sistem de deschidere si inchidere lent, si selinfros
 - Cantul (ABS) va fi pe tot perimetrul de 2mm.
 - De verificat dimensiunile spatului si comunicatiile existente la obiect.
 - La montare se va stabili amplasarea gaurii in masa pentru cabluri.

obiect	pozitie	material	culoare	cod
receptie	corp	Egger		U732
receptie	fatada exterior 1	AGT		734
receptie	fatada exterior 2	Egger		F02S175
receptie	fatada interior	Egger		U732

PROIECT DE DESIGN			
SPECIFICATIILE MOBILIER BAZIN DINAMID.		str. Gh. Asach 23A, mun. CHISINAU	
SPECIFICATIILE MOBILIER		Etapa	Planşa
POZITIE 11 RECEPTIE		PE	12
			19
		CHISINAU 2021	

[P 12]

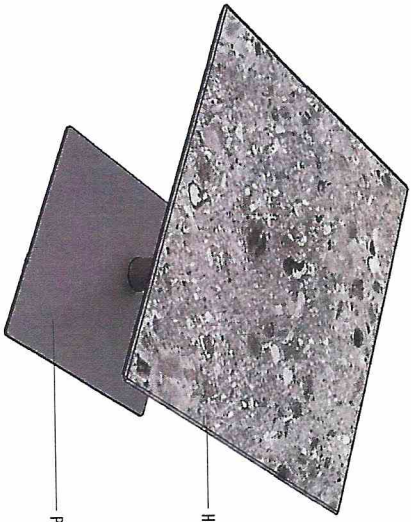
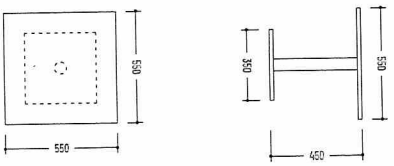

[P 13]



PROIECT DE DESIGN				
SPECIFICATIILE MOBILIER BAZIN DIAMOND, str. Gh. Asachi 23A, mun. CHISINAU				
SPECIFICATIILE MOBILIER		Etapa	Planşa	Planşe
POZITIE 12 Masa de cafea 550x550x450		PE	13	19
POZITIE 13 Canapea L-2m				
		CHISINAU 2021		

[P 14]

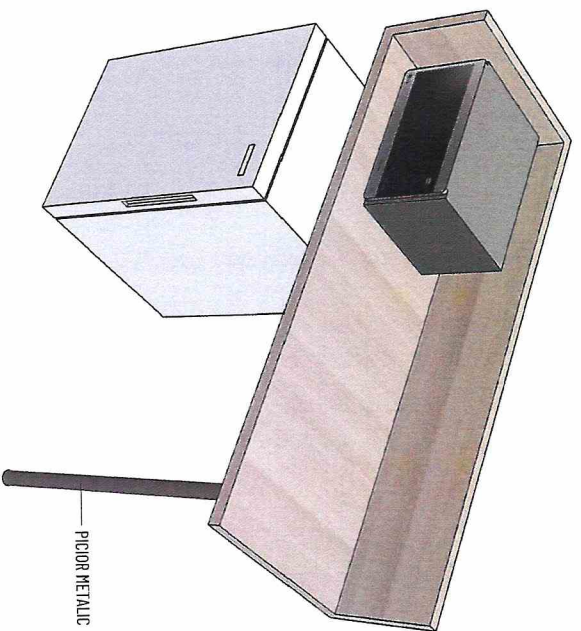
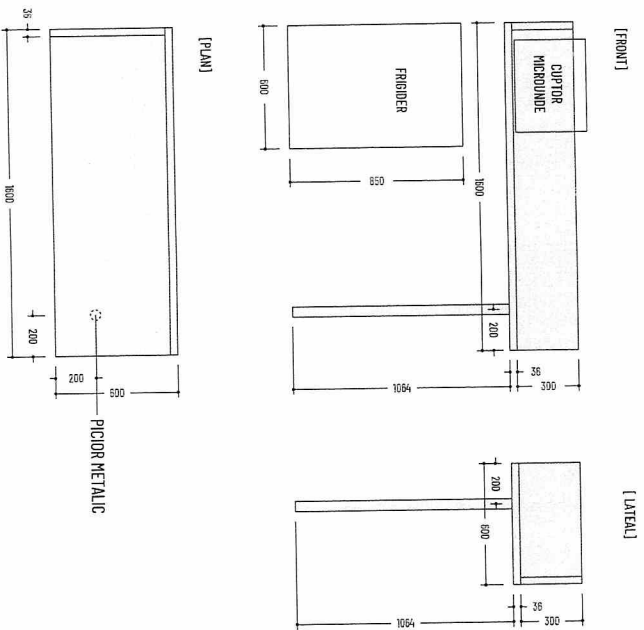

- NOTA:
- Furnitura aleasa va fi asamblator BLM cu sistem de deschidere si inchidere lent, si setintios
 - Cantul (ABS) va fi pe tot perimetrul de 2mm
 - De verificat dimensiunile spatului si comunicatiile existente la obiect.
 - La montare se va stabili amplasarea gaurii in masa pentru cabluri.

obiect	pozitie	material	culoare	cod
masa chichenea	corp	Egger		H3326
masa chichenea	picior	metal		

PROIECT DE DESIGN				
SPECIFICATIILE MOBILIER BAZIN DIAMOND, str. Gh. Asachi 23A, mun. CHISINAU				
SPECIFICATIILE MOBILIER				
POZITIE 14				
Masa tip chichenea				
Etapă		Planşa	Planşe	
PE		14	19	
				CHISINAU 2021

[P 15]

[FRONT]

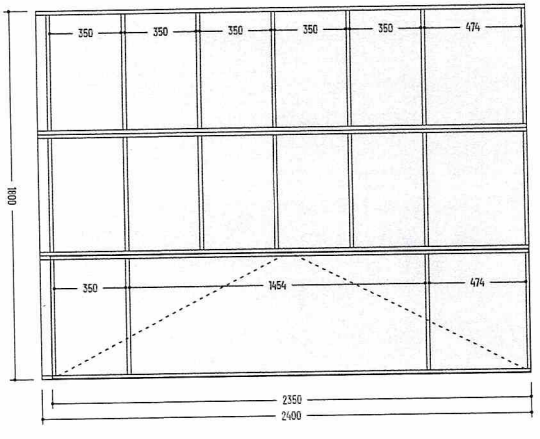

[SECTION]

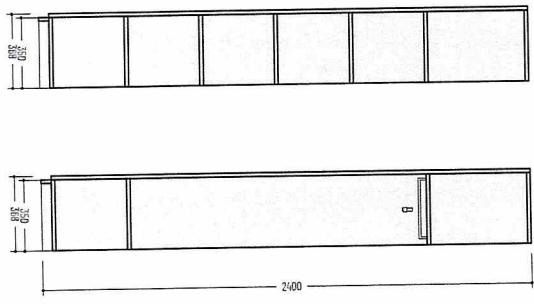

[PLAN]

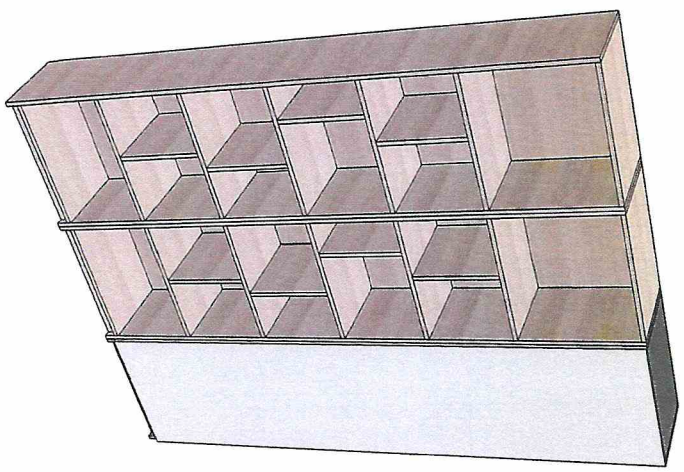
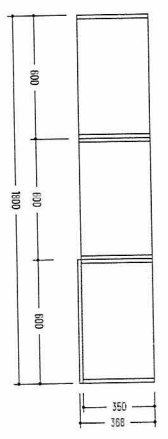

NOTA:

- Furnitura aleasa va fi asanatorul BLUM cu sistem de deschidere si inchidere lent, si seinfios
- Canul (ABS) va fi pe tot perimetrul de 2mm.
- De verificat dimensiunile spatului si comunicatiile existente la obiect.
- La montare se va stabili amplasarea gaurii pentru cabluri.

obiect	pozitie	material	culoare	cod
dulap	corp	Egger		H3326
dulap	fatada	AGT		734

PROIECT DE DESIGN

SPECIFICATIILE MOBILIER BAZIN DINAMID, str. Gh. Asachi 23A, mun. CHISINAU

SPECIFICATIILE MOBILIER

Etapă	Planşa	Planşe
PE	15	19

POZITIE 15
Dulap pentru mape si garderoba
pentru administrator

CHISINAU 2021

PROIECT DE DESIGN	
SPECIFICATIILE MOBILIER BAZIN DINAMID, str. Gh. Asachi 23A, mun. CHISINAU	
SPECIFICATIILE MOBILIER	
POZITIE 15 Dulap pentru mape si garderoba pentru administrator	
CHISINAU 2021	

[P17]

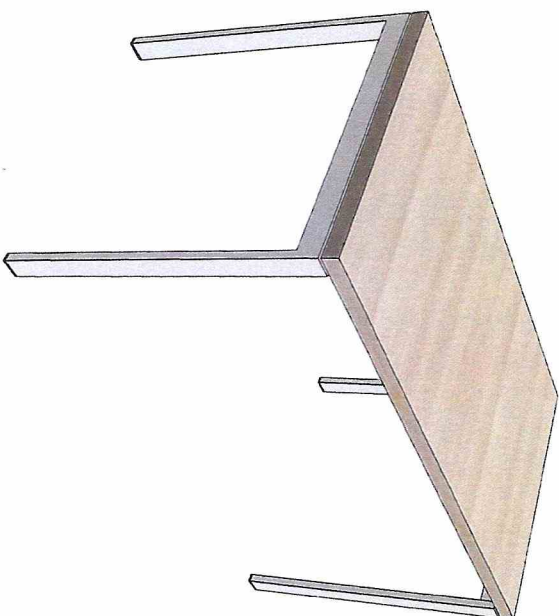

[P16]

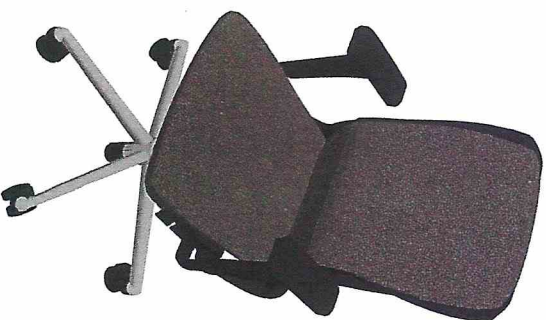

[P18]



[FRONTAL]

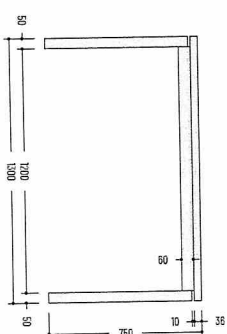

[LATERAL]

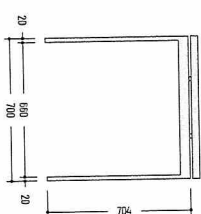

[PLAN]

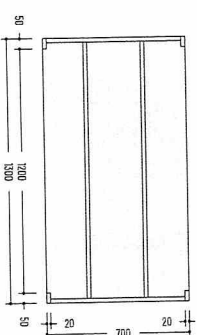

[SECTIONE]

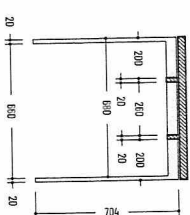

- NOTA:
- Cantul (ABS) va fi pe tot perimetrul de 2mm
 - De verificat dimensiunile spatului si comunicatiile existente la obiect.

obiect	pozitie	material	culoare	cod
masa atasament	top	Egger		H33296
masa atasament	picior	metal		RAL90 03

PROIECT DE DESIGN

SPECIFICATIIL MOBILIER BAZIN DINAMO. str. Gh. Asachi 23A, mun. CHISINAU

SPECIFICATIIL MOBILIER

Etapă	Planşa	Planşe
PE	16	19

POZITIE 16 Fotoliu de birou

POZITIE 17 Masa atasament 1300 x 700 x 750

POZITIE 18 Scaun de birou

CHISINAU 2021

[P 20]

[FRONTAL]

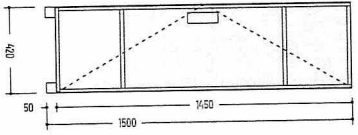

[SECTIONE]

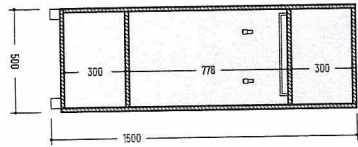

[PLAN]

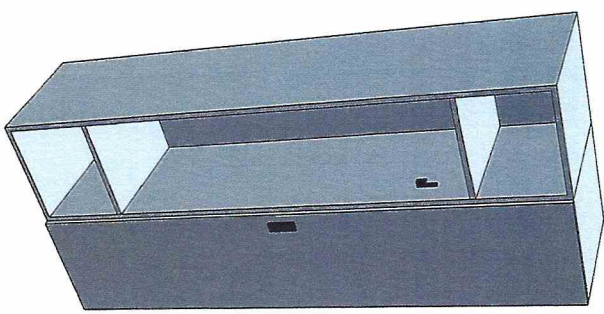
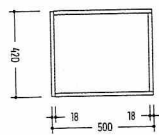

NOTA:

- Cantul (ABS) va fi pe tot perimetrul de 2mm.
- De verificat dimensiunile spațiului și comunicatiile existente la obiect.

obiect	pozitie	material	culoare	cod
garderoaba	corp	Egger		U732
garderoaba	fatada	Egger		U500ST9
garderoaba	picior		negru	
garderoaba	maner		antracit	
garderoaba	cutiere		negru	

PROIECT DE DESIGN			
SPECIFICATIILE MOBILIER BAZIN DINAMO, str. Gh. Asachi 23A, mun. CHISINAU			
SPECIFICATIILE MOBILIER			
POZITIE 20			
garderoabe persoane cu mobilitate redusa			
Etapa	Planşa	Planşe	
PE	17	19	
CHISINAU 2021			

[P 21]

[FRONT]

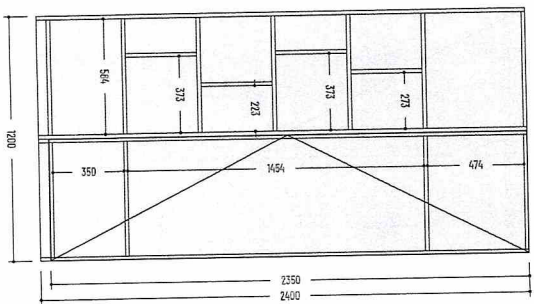

[SECTIUN]

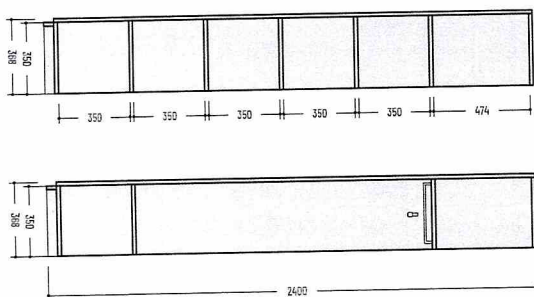

[PLAN]

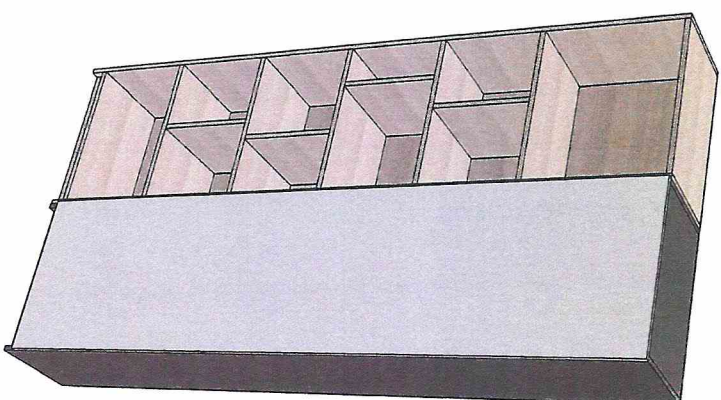
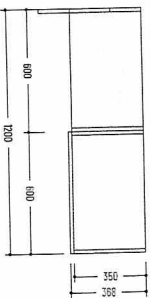

NOTA:

- Cantul (ABS) va fi pe tot perimetrul de 2mm.
- De verificat dimensiunile spatului si comunicatiile existente la obiect.

obiect	pozitie	material	culoare	cod
garderoba	corp 1	Egger		U732
garderoba	corp 2	ABS		734
garderoba	picior		negru	
garderoba	maner		antracit	
garderoba	cuiera		negru	

PROIECT DE DESIGN			
SPECIFICATIILE MOBILIER BAZIN DINAMIO, str. Gh. Asachi 23A, mun. CHISINAU			
SPECIFICATIILE MOBILIER			
POZITIE 21		CHISINAU 2021	
Dulap pentru mapes si dulap pentru produse de laborator			
Etapa		Planşa	Planşe
PE		18	19

[P22]

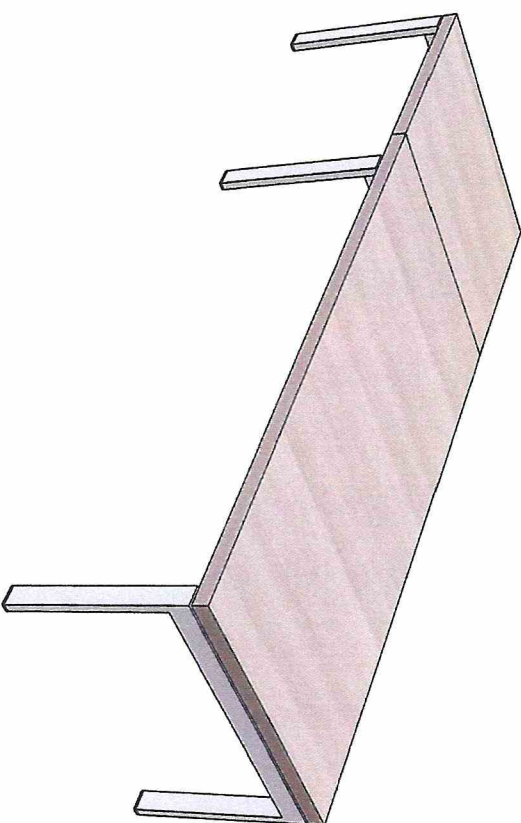
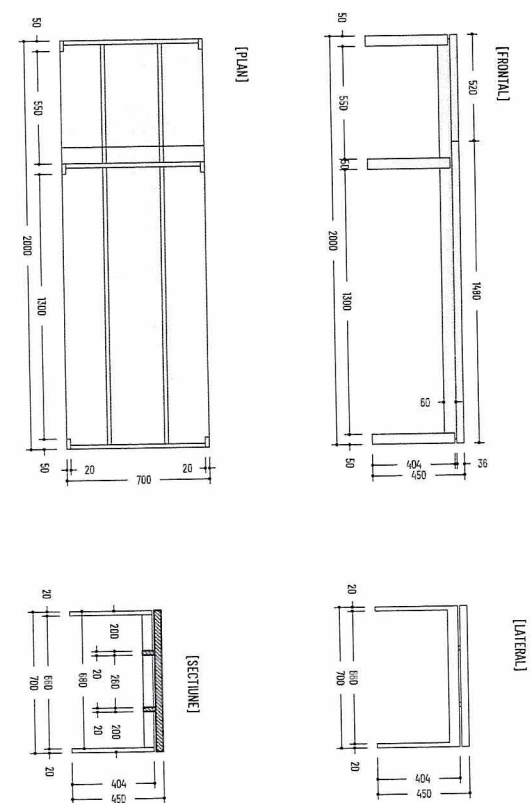

NOTA:

- Cantul (ABS) va fi pe tot perimetrul de 2mm.
- De verificat dimensiunile spațiilor și comunicațiile existente la obiect.

obiect	pozitie	material	culoare	cod
pat	top	Egger		H3326
pat	picior	metal		RAL9 003

PROIECT DE DESIGN			
SPECIFICATIILE MOBILIER BAZIN DINAMID, str. 6A, Asacii 23A, mun. CHISINAU			
SPECIFICATIILE MOBILIER		Etapa	Planşa
POZITIE 22		PE	19
Pat medicinal		Planşa	19
		CHISINAU 2021	