

accessories

for electrosurgery

akcesoria

do elektrochirurgii

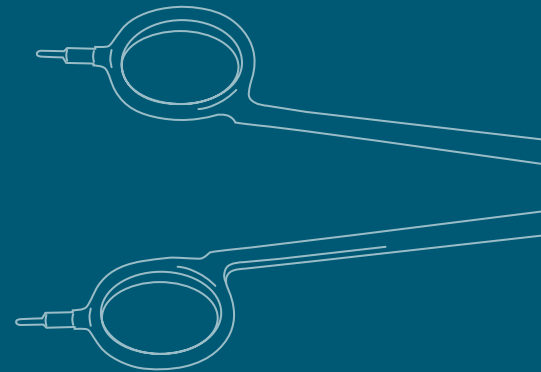
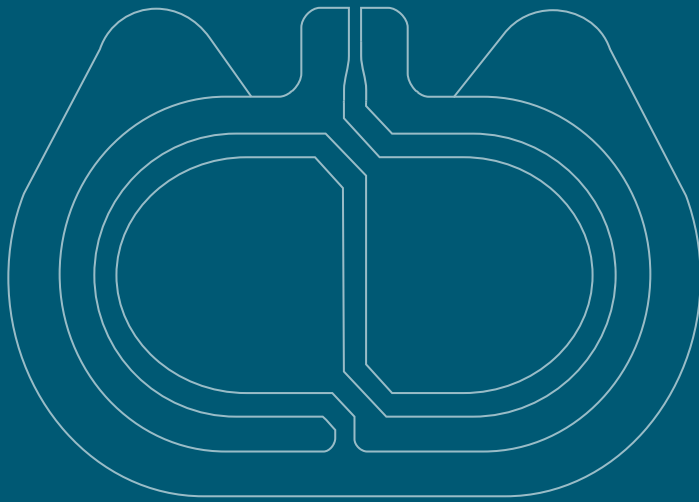
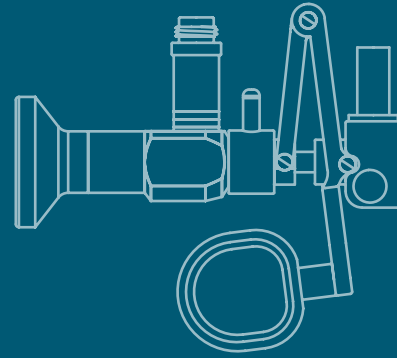



sds accessories	o o o o o o o o o	akcesoria sds
electrode handles	1	uchwyty elektrod
argon electrode handles	2	uchwyty elektrod argonowych
monopolar cables	3	kable monopolarne
bipolar cables	4	kable bipolarne
bipolar instruments	6	narzędzia bipolarne
ThermoStapler® vessel sealing clamps, angled	7	kleszczyki do bipolarnego zamykania naczyń, zagięte
sds bipolar arthroscopic electrodes	8	bipolarne elektrody artroskopowe sds
monopolar accessories	• o o o o o o o o o	akcesoria monopolarne
monopolar electrodes	9	elektrody monopolarne
monopolar tungsten electrodes	12	elektrody monopolarne wolframowe
monopolar microdissection electrodes	12	elektrody monopolarne do mikrodysekcji
monopolar long electrodes	13	elektrody monopolarne długie
monopolar laparoscopic electrodes	16	monopolarne elektrody laparoskopowe
monopolar electrodes' adaptors	17	adaptory elektrod monopolarnych
extensions for standard electrodes	17	przedłużacze do elektrod standardowych
electrode handles large	18	uchwyty elektrod szerokie
electrode handles small	18	uchwyty elektrod wąskie
sterile disposable monopolar handles & electrodes	19	sterylne uchwyty i elektrody jednorazowe
bipolar accessories	o • o o o o o o o	akcesoria bipolarne
bipolar forceps	20	szczypce bipolarne
bipolar scissors	21	nożyczki bipolarne
bipolar laparoscopic instruments	22	bipolarne narzędzia laparoskopowe
bipolar connecting cables	24	kable bipolarne
universal resectoscope	o o • o o o o o o	resektoskop uniwersalny
universal resectoscope 24/26 Fr	25	resektoskop uniwersalny 24/26 Fr
universal resectoscope 17,5 Fr	26	resektoskop uniwersalny 17,5 Fr
cables for resectoscope	28	kable do resektoskopu
containers for sterilization	29	pojemniki do sterylizacji
arthroscopy	o o o • o o o o o	artroskopia
bipolar arthroscopic electrodes	30	bipolarne elektrody artroskopowe
ThermoStapler®		ThermoStapler®
vessel sealing clamps	o o o o • o o o o	kleszczyki do bipolarnego zamykania naczyń
ThermoStapler® vessel sealing clamps, angled	31	kleszczyki do bipolarnego zamykania naczyń zagięte
ThermoStapler® vessel sealing clamps, straight	31	kleszczyki do bipolarnego zamykania naczyń proste
neutral electrodes	o o o o o • o o o	elektrody neutralne
disposable neutral electrodes	32	elektrody neutralne jednorazowe
reusable neutral electrodes	33	elektrody neutralne wielokrotnego użycia
neutral electrodes cables	34	kable do elektrod neutralnych
monopolar and bipolar cables	o o o o o o • o o	kable monopolarne i bipolarne
laparoscopic monopolar cables	35	kable monopolarne do laparoskopu
endoscopic monopolar cables	35	kable monopolarne do endoskopu
monopolar cables for resectoscope	36	kable monopolarne do resektoskopu
other bipolar cables	37	inne kable bipolarne
argon plasma coagulation	o o o o o o o • o	koagulacja argonowa
argon instruments	38	narzędzia argonowe
electrosurgical units and other accessories	o o o o o o o o •	aparaty elektrochirurgiczne i inne akcesoria
footswitches	40	włączniki nożne
trolleys	41	wózki pod aparaty elektrochirurgiczne
EMED electrosurgical units	43	aparaty elektrochirurgiczne EMED
smoke evacuation system	45	system odsysania dymów operacyjnych
WATERFALL endoscopic irrigation pump	46	endoskopowa pompa irygacyjna WATERFALL
product finder	48	indeks kodów
contact us	51	kontakt







electrode handles

uchwyty elektrod

SDS plug wtyk SDS	REF	cable length dł. kabla	Ø dia. średnica	
	322-14S	4m	4 mm	Electrode handle, large, 2 switches Uchwyt elektrody 4mm, szeroki, 2 przyciski
				
	215-23S	3 m	4 mm	Electrode handle, small, 2 switches Uchwyt elektrody, wąski, 2 przyciski
	218-23S	3 m	2.4 mm	Electrode handle, small, 2 switches Uchwyt elektrody, wąski, 2 przyciski
				

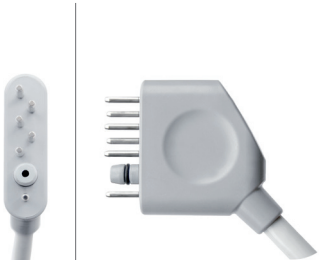

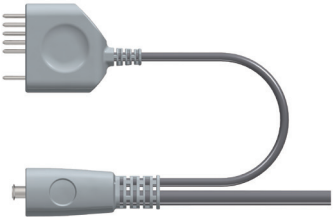





argon electrode handles

uchwyty elektrod argonowych

SDSA plug wtyk SDSA	REF	cable length dł. kabla	
 <p data-bbox="188 1032 502 1144">Integrated argon socket for atom and endo units Zintegrowane złącze argonowe do aparatów ATOM i ENDO</p>	932-14A	3.5 m	Argon electrode handle, large, 2 switches, SDSA plug Uchwyt elektrody argonowej, szeroki, 2 przyciski, wtyk SDSA 
	432-46A	3.5 m	Monopolar cable for argon flexible electrode, flat connector, SDSA plug Kabel monopolarny do giętkiej elektrody argonowej, złącze owalne, wtyk SDSA 
	932-14S	3.5 m	Argon electrode handle, large, 2 switches Uchwyt elektrody argonowej, szeroki, 2 przyciski 
	432-46S	3.5 m	Monopolar cable for argon flexible electrode, flat connector Kabel monopolarny do giętkiej elektrody argonowej, złącze owalne 







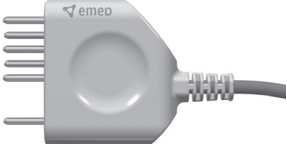

monopolar cables

kable monopolarne

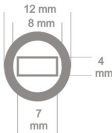
SDS plug wtyk SDS	REF	cable length dł. kabla		
	280-03S 280-05S	3 m 5 m	4 mm female gniazdo żeńskie 4 mm	Monopolar laparoscopic cable Kabel monopolarny do laparoskopu
				
	281-03S	3 m	3mm female gniazdo żeńskie 3 mm	Monopolar endoscopic cable Kabel monopolarny do narzędzi endoskopowych
				
	405-04S	4.5 m	2 mm male wtyk męski 2 mm	Monopolar cable for resectoscope Kabel monopolarny do resektoskopu
	 			
408-14S	4.5 m	angled connector złącze kątowe	Monopolar cable for STORZ resectoscope Kabel monopolarny do resektoskopu STORZ	
				
409-04S	4.5 m	3 mm male wtyk męski 3 mm	Monopolar cable for OLYMPUS resectoscope Kabel monopolarny do resektoskopu OLYMPUS	
 				

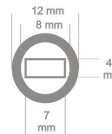
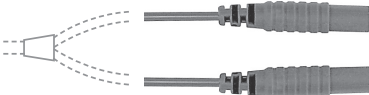





bipolar cables

kable bipolarne

SDS plug wtyk SDS	REF	cable length dł. kabla	
	351-03S 351-05S	3 m 5 m	Bipolar cable, straight connector Kabel bipolarny, złącze proste
	 		
	351-13S 351-15S	3 m 5 m	Bipolar cable, angled connector Kabel bipolarny, złącze kątowe
	 		
	401-03S 401-05S	3 m 5 m	Bipolar cable 2x2.6mm, for ThermoStapler® clamps Kabel bipolarny 2x2,6mm, do klemów ThermoStapler®
			
348-04S	4.5 m	Bipolar cable for STORZ resectoscope Kabel bipolarny do resektoskopu STORZ	
			
354-04S	4.5 m	Bipolar cable for resectoscope Kabel bipolarny do resektoskopu	
 			

bipolar cables

kable bipolarne



SDS plug wtyk SDS	REF	cable length dł. kabla	
	349-04S	4.5 m	Bipolar cable for OLYMPUS resectoscope Kabel bipolarny do resektoskopu OLYMPUS
			
	359-03S 359-05S	3 m 5 m	Bipolar cable for STORZ laparoscopy Kabel bipolarny laparoskopowy do narzędzi STORZ
			
	352-03S	3 m	Bipolar cable for WOLF laparoscopy Kabel bipolarny laparoskopowy do narzędzi WOLF
			
358-03S	3 m	Bipolar cable for BiTech scissors Kabel bipolarny do nożyczek BiTech	
			
	281-60S	SDS adaptor for bipolar endoscopic hemostasis probe Adapter SDS do bipolarnej sondy hemostatycznej <hr/> only for ENDO units tylko do aparatów ENDO	

bipolar instruments

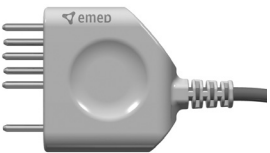
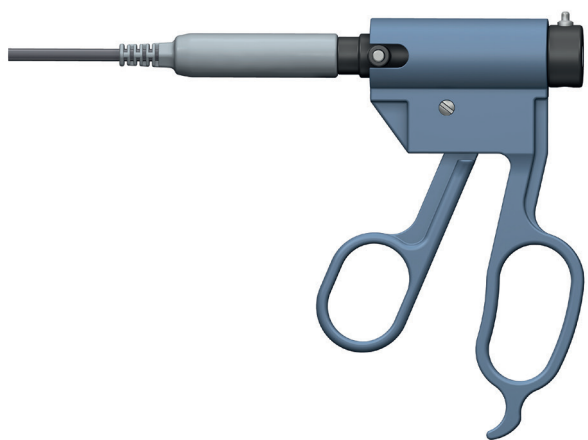
narzędzia bipolarne

SDS plug wtyk SDS	REF	cable length dł. kabla	
 <p>instrument with fixed cable instrument z nierozłącznym kablem</p>	824-13S	3 m	Handle for bipolar laparoscopic instrument, reusable Uchwyt do bipolarnego instrumentu laparoskopowego, wielorazowy
			

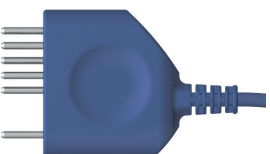
connection: laparoscopic inserts, page:
połączenie: wkłady laparoskopowe, strona: 23

SDS plug wtyk SDS	REF	cable length dł. kabla	box opakowanie	
	847-S30	3 m	10 pcs. 10 szt.	Disposable handle with knife electrode, 2 switches, sterile Uchwyt jednorazowy z elektrodą, nóż, 2 przyciski, sterylne
				
	847-S31	3 m	10 pcs. 10 szt.	Disposable handle with needle electrode, 2 switches, sterile Uchwyt jednorazowy z elektrodą, igła, 2 przyciski, sterylne
				







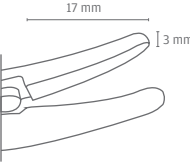
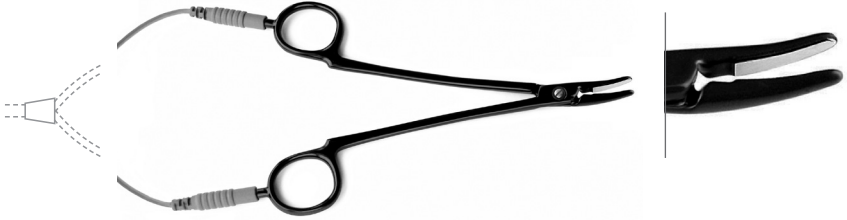
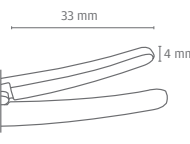
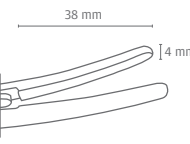
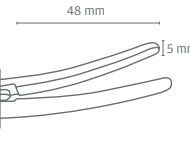
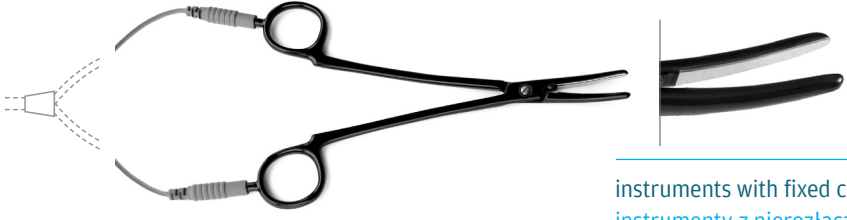

ThermoStapler® vessel sealing clamps, angled, SDS

kleszczyki do bipolarnego zamykania naczyń, zagięte, SDS

SDS plug wtyk SDS	REF	length długość		
	801-16S	16 cm		<p>ThermoStapler® - vessel sealing clamps, angled, smooth, with cable 3 m</p> <p>ThermoStapler® - kleszczyki do bipolarnego zamykania naczyń, zagięte, gładkie, z kablem 3 m</p>
				
	801-18S	18 cm		<p>ThermoStapler® - vessel sealing clamps, angled, smooth, with cable 3 m</p> <p>ThermoStapler® - kleszczyki do bipolarnego zamykania naczyń, zagięte, gładkie, z kablem 3 m</p>
	801-23S	23 cm		<p>ThermoStapler® - vessel sealing clamps, angled, smooth, with cable 3 m</p> <p>ThermoStapler® - kleszczyki do bipolarnego zamykania naczyń, zagięte, gładkie, z kablem 3 m</p>
	801-28S	28 cm		<p>ThermoStapler® - vessel sealing clamps, angled, smooth, with cable 3 m</p> <p>ThermoStapler® - kleszczyki do bipolarnego zamykania naczyń, zagięte, gładkie, z kablem 3 m</p>
 <p data-bbox="1082 1788 1441 1847">instruments with fixed cable instrumenty z nierozłącznym kablem</p>				

SDS bipolar arthroscopic electrodes

bipolarne elektrody artroskopowe SDS













SDS plug wtyk SDS	Bipolar electrode Elektroda bipolarna	REF	115 mm 170 mm	cable length dł. kabla	Bipolar needle electrode, angled 90°, 0.6 x 1.5 mm Elektroda bipolarna, igła, zagięta 90°, 0,6 x 1,5 mm
		58S-010 58S-030	115 mm 170 mm	3 m	Bipolar needle electrode, angled 90°, 0.6 x 1.5 mm Elektroda bipolarna, igła, zagięta 90°, 0,6 x 1,5 mm
		58S-020 58S-060	115 mm 170 mm	3 m	Bipolar needle electrode, angled 90°, 0.6 x 4 mm Elektroda bipolarna, igła zagięta 90°, 0,6 x 4 mm
		58S-040	115 mm	3 m	Bipolar button electrode, angled 90°, 1.5 x 4 mm Elektroda bipolarna, klawiszowa, zagięta 90°, 1,5 x 4 mm
		58S-110 58S-140	115 mm 170 mm	3 m	Bipolar vaporization electrode, Phazer, convex, angled 70°, ball 2.4 mm Elektroda bipolarna do waporyzacji - Phazer, wypukła, zagięcie 70°, śr. kulki 2,4 mm
		58S-930 58S-920	115 mm 170 mm	3 m	Bipolar vaporization electrode, round, VAP Elektroda bipolarna do waporyzacji, okrągła, VAP











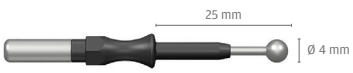



instruments with fixed cable
instrumenty z nierozłącznym
kablem



monopolar electrodes











elektrody monopolarne

for 4 mm handle do uchwytu 4 mm	REF	
	520-100	Lancet electrode straight, oval shape, 25 x 3.5 mm Elektroda lancet prosty, owalny, 25 x 3,5 mm
	520-200	Lancet electrode angled, rhombic, 19 x 1.8 mm, Elektroda lancet kątowy, romboidalny, 19 x 1,8 mm
	520-300	Lancet electrode straight, rhombic, 25 x 1.8 mm Elektroda lancet prosty, romboidalny, 25 x 1,8 mm
	520-500	Knife electrode straight, 25 x 3.5 mm Elektroda nóż prosty, 25 x 3,5 mm
	520-600	Spatula electrode, oval shape, straight, 2 x 24 mm Elektroda szpatuła owalna, prosta, 2 x 24 mm
	520-650	Spatula electrode, oval shape, angled, 3 x 24 mm Elektroda szpatuła owalna, kątowna, 3 x 24 mm
	520-700	Knife electrode straight, 25 mm Elektroda nóż prosty, 25 mm
	520-800	Lancet electrode, angular Elektroda lancet kątowy
	520-900	Lancet electrode straight Elektroda lancet prosty
	521-010	Needle electrode, straight, Ø 0.5 mm Elektroda igła prosta, Ø 0,5 mm
	521-020	Needle electrode, straight, Ø 0.7 mm Elektroda igła prosta, Ø 0,7 mm
	521-410	Ball electrode straight, Ø 2 mm Elektroda kulka prosta, Ø 2 mm

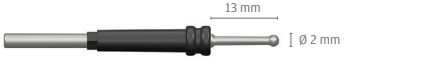
for 4 mm handle do uchwytu 4 mm	REF	
	521-420	Ball electrode straight, Ø 4 mm Elektroda kulka prosta, Ø 4 mm
	521-430	Ball electrode straight, Ø 6 mm Elektroda kulka prosta, Ø 6 mm
	521-480	Ball electrode, angled, Ø 2 mm Elektroda kulka kątowa, Ø 2 mm
	521-490	Ball electrode, angled, Ø 4 mm Elektroda kulka kątowa, Ø 4 mm
	521-210	Wire loop electrode, Ø 5 mm Elektroda pętla drucziana, Ø 5 mm
	521-220	Wire loop electrode, Ø 10 mm Elektroda pętla drucziana, Ø 10 mm
	521-230	Wire loop electrode, Ø 14 mm Elektroda pętla drucziana, Ø 14 mm
	521-350	Ribbon loop electrode, Ø 12 mm Elektroda pętla taśmowa, Ø 12 mm
	521-380	Ribbon loop electrode, Ø 16 mm Elektroda pętla taśmowa, Ø 16 mm
	521-110	Needle electrode, short, 0.5 Elektroda igła prosta, krótka, 0,5
	521-120	Needle electrode, short, 0.7 Elektroda igła prosta, krótka, 0,7
	521-600	Needle electrode, straight, 0.8 x 29 mm Elektroda igła prosta, 0,8 x 29 mm
	522-700	Spatula electrode, straight, 3 x 24 mm Elektroda szpatuła prosta, 3 x 24 mm
	523-210	Spatula electrode, straight, 2 x 16 mm, L: 40 mm Elektroda szpatuła prosta, 2 x 16 mm, dł. 40 mm
	523-200	Spatula electrode, straight, 2 x 16 mm, L: 80 mm Elektroda szpatuła prosta, 2 x 16 mm, dł. 80 mm

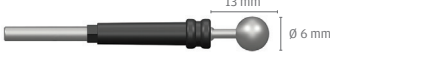
monopolar electrodes





elektrody monopolarne

for 2.4 mm handle do uchwyty 2,4 mm	REF	
	530-000	Spatula electrode, oval shape, straight, 2 x 24 mm Elektroda szpatała owalna, prosta, 2 x 24 mm
	530-100	Knife electrode straight, 25 x 3.5 mm Elektroda nóż prosty, 25 x 3,5 mm
	530-310	Needle electrode, straight, Ø 0.5 mm Elektroda igła prosta, Ø 0,5 mm
	530-320	Needle electrode, straight, Ø 0.7 mm Elektroda igła prosta, Ø 0,7 mm
	530-510	Ball electrode straight, Ø 2 mm Elektroda kulka prosta, Ø 2 mm
	530-520	Ball electrode straight, Ø 4 mm Elektroda kulka prosta, Ø 4 mm
	530-530	Ball electrode straight, Ø 6 mm Elektroda kulka prosta, Ø 6 mm
	530-580	Ball electrode, angled, Ø 2 mm Elektroda kulka kątowna, Ø 2 mm
	530-610	Wire loop electrode, Ø 5 mm Elektroda pętla druciana, Ø 5 mm
	530-620	Wire loop electrode, Ø 10 mm Elektroda pętla druciana, Ø 10 mm
	530-630	Wire loop electrode, Ø 14 mm Elektroda pętla druciana, Ø 14 mm

connection: monopolar electrode handles, pages:
połączenie: uchwyty elektrod monopolarnych, strony: [1, 18](#)

monopolar tungsten electrodes

elektrody monopolarne wolframowe

for 4 mm handle do uchwytu 4 mm	REF	
	522-300	Tungsten needle electrode, straight, insulated, 0.5 x 20 mm Elektroda igła wolframowa prosta, izolowana, 0,5 x 20 mm
	522-400	Tungsten needle electrode, angled, insulated, 0.5 x 20 mm Elektroda igła wolframowa kątowa, izolowana, 0,5 x 20 mm
	522-500	Tungsten needle electrode, straight, insulated, 0.5 x 40 mm Elektroda igła wolframowa prosta, izolowana, 0,5 x 40 mm
for 2.4 mm handle do uchwytu 2,4 mm		
	532-300	Tungsten needle electrode, straight, insulated, 0.5 x 20 mm Elektroda igła wolframowa prosta, izolowana, 0,5 x 20 mm







monopolar microdissection electrodes

elektrody monopolarne do mikrodysekcji

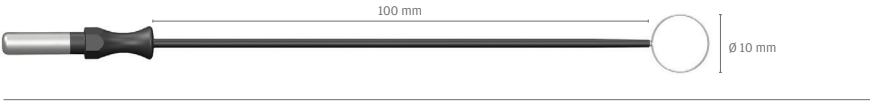
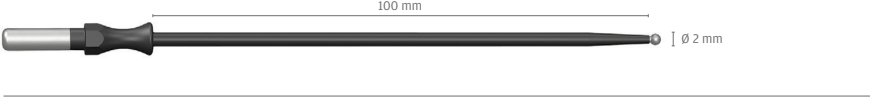
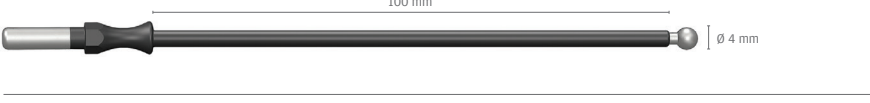
do uchwytu 4 mm for 4 mm handle	REF	
	528-650	Microdissection needle electrode, tungsten, flexible, 0.25 mm x 4 mm Elektroda igła do mikrodysekcji, wolfram, giętka, 0,25 mm x 4 mm
	529-000	Microdissection needle electrode, tungsten, flexible, 0.25 mm x 4 mm Elektroda igła do mikrodysekcji, wolfram, giętka, 0,25 mm x 4 mm
	529-050	Microdissection needle electrode, tungsten, angled 45°, flexible, 0.25 mm x 4 mm Elektroda igła do mikrodysekcji, kątowa 45°, giętka, wolfram, 0,25 mm x 4 mm

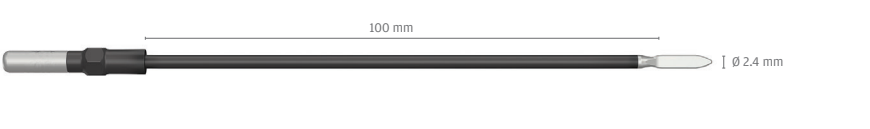
monopolar long electrodes

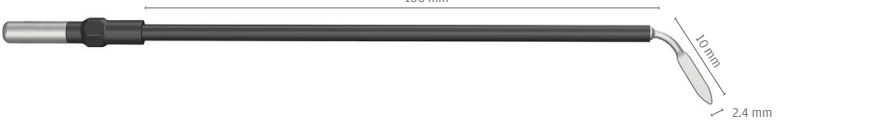
elektrody monopolarne długie

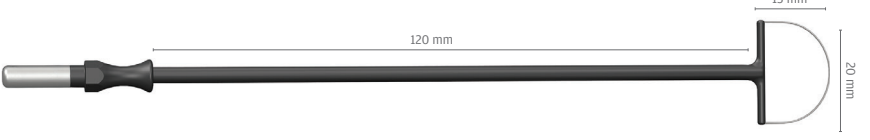
for 4 mm handle do uchwytu 4 mm	REF	
	523-910	Wire loop electrode, \varnothing 5 mm, L: 100 mm Elektroda pętla, \varnothing 5 mm, dł. 100 mm
	523-920	Wire loop electrode, \varnothing 10 mm, L: 100 mm Elektroda pętla, \varnothing 10 mm, dł. 100 mm
	524-010	Ball electrode straight, \varnothing 2 mm, L: 100 mm Elektroda kulka prosta, \varnothing 2 mm, dł. 100 mm
	524-020	Ball electrode straight, \varnothing 4 mm, L: 100 mm Elektroda kulka prosta, \varnothing 4 mm, dł. 100 mm
	524-030	Ball electrode straight, \varnothing 6 mm, L: 100 mm Elektroda kulka prosta, \varnothing 6 mm, dł. 100 mm
	524-130	Needle electrode straight, 0.8 x 12 mm, L: 100 mm Elektroda igła prosta, 0,8 x 12 mm, dł. 100 mm
	524-200	Knife electrode, straight, 2.4 x 10 mm, L: 100 mm Elektroda nóż prosty, 2,4 x 10 mm, dł. 100 mm
	524-260	Knife electrode, straight, 25 mm, L: 100 mm Elektroda nóż prosty, 25 mm, dł. 100 mm
	524-300	Knife electrode, angled, 2.4 x 10 mm, L: 100 mm Elektroda nóż kątowy 2,4 x 10 mm, dł. 100 mm
	524-600	Loop electrode, 10 x 10 mm, L: 120 mm Elektroda pętla, 10 x 10 mm, dł. 120 mm
	525-000	Loop electrode, 15 x 20 mm, L: 120 mm Elektroda pętla, 15 x 20 mm, dł. 120 mm





for 4 mm handle
do uchwytu 4 mm

	REF	
<p>120 mm</p> <p>20 mm</p> <p>20 mm</p>	525-100	<p>Loop electrode, 20 x 20 mm, L: 120 mm Elektroda pętla, 20 x 20 mm, dł. 120 mm</p>
<p>120 mm</p> <p>25 mm</p> <p>20 mm</p>	525-200	<p>Loop electrode, 25 x 20 mm, L: 120 mm Elektroda pętla, 25 x 20 mm, dł. 120 mm</p>
<p>25 mm</p> <p>10 mm</p> <p>115 mm</p>	526-400	<p>Triangle loop electrode, 10 x 25 mm, L: 115 mm Elektroda żagielek, 10 x 25 mm, dł. 115 mm</p>
<p>25 mm</p> <p>15 mm</p> <p>115 mm</p>	526-200	<p>Triangle loop electrode, 15 x 25 mm, L: 115 mm Elektroda żagielek, 15 x 25 mm, dł. 115 mm</p>
<p>25 mm</p> <p>20 mm</p> <p>115 mm</p>	526-300	<p>Triangle loop electrode, 20 x 25 mm, L: 115 Elektroda żagielek, 20 x 25 mm, dł. 115</p>
<p>120 mm</p> <p>10 mm</p>	525-800	<p>Loop electrode, 10 mm, L: 120 mm Elektroda pętla, 10 mm, dł. 120 mm</p>
<p>120 mm</p> <p>15 mm</p>	525-900	<p>Loop electrode, 15 mm, L: 120 mm Elektroda pętla, 15 mm, dł. 120 mm</p>
<p>120 mm</p> <p>20 mm</p>	526-000	<p>Loop electrode, 20 mm, L: 120 mm Elektroda pętla, 20 mm, dł. 120 mm</p>
<p>120 mm</p> <p>25 mm</p>	526-100	<p>Loop electrode, 25 mm, L: 120 mm Elektroda pętla, 25 mm, dł. 120 mm</p>

connection: monopolar electrode handles, pages:
połączenie: uchwyt elektrod monopolarnych, strony: [1, 18](#)

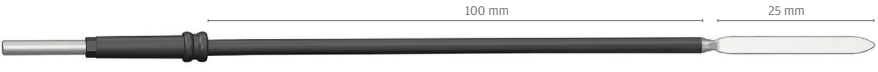
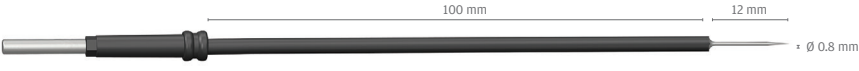

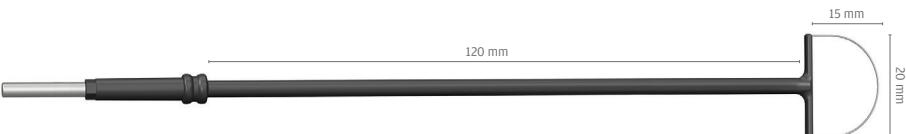
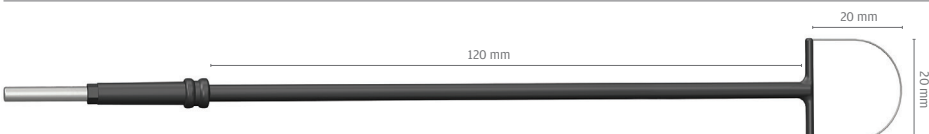
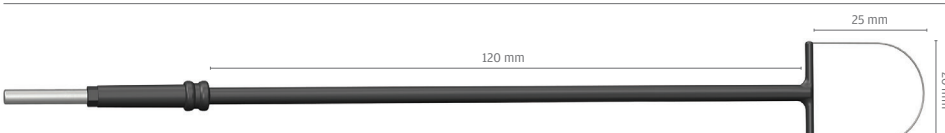

monopolar long electrodes

elektrody monopolarne długie

for 2.4 mm handle do uchwytu 2,4 mm	REF	
	534-100	Knife electrode, straight, 25 mm, L: 100 mm Elektroda nóż prosty, 25 mm, dł. 100 mm
	534-210	Needle electrode straight, 0,8 x 12 mm, L: 100 mm Elektroda igła prosta, 0,8 x 12 mm, dł. 100 mm
	534-420	Ball electrode straight, Ø 4 mm, L: 100 mm Elektroda kulka prosta, Ø 4 mm, dł. 100 mm
	534-460	Loop electrode, 10 x 10 mm, L: 120 mm Elektroda pętla, 10 x 10 mm, L: 120 mm
	535-000	Loop electrode, 15 x 20 mm, L: 120 mm Elektroda pętla, 15 x 20 mm, dł. 120 mm
	535-100	Loop electrode, 20 x 20 mm, L: 120 mm Elektroda pętla, 20 x 20 mm, dł. 120 mm
	535-200	Loop electrode, 25 x 20 mm, L: 120 mm Elektroda pętla, 25 x 20 mm, dł. 120 mm
	535-800	Loop electrode, 10 mm, L: 120 mm Elektroda pętla, 10 mm, dł. 120 mm
	535-900	Loop electrode, 15 mm, L: 120 mm Elektroda pętla, 15 mm, dł. 120 mm

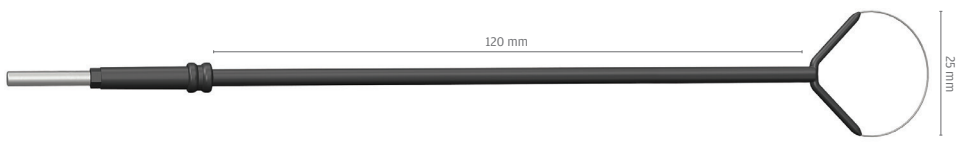
connection: monopolar electrode handles, pages:
połączenie: uchwyty elektrod monopolarnych, strony: [1, 18](#)

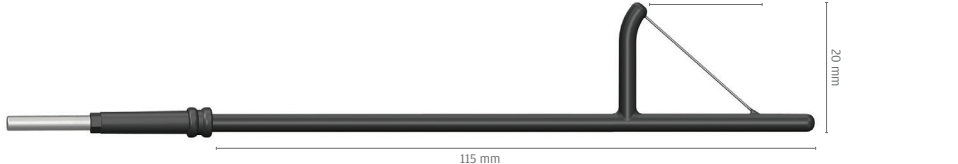
for 2.4 mm handle
do uchwytu 2,4 mm

	REF	
	536-000	Loop electrode, 20 mm, L: 120 mm Elektroda pętla, 20 mm, dł. 120 mm
	536-100	Loop electrode, 25 mm, L: 120 mm Elektroda pętla, 25 mm, dł. 120 mm
	536-200	Triangle loop electrode, 15 x 25 mm, L: 115 mm Elektroda żagielek, 15 x 25 mm, dł. 115 mm
	536-300	Triangle loop electrode, 20 x 25 mm, L: 115 Elektroda żagielek, 20 x 25 mm, dł. 115
	536-400	Triangle loop electrode, 10 x 25 mm, L: 115 mm Elektroda żagielek, 10 x 25 mm, dł. 115 mm

monopolar laparoscopic electrodes

elektrody monopolarne laparoskopowe

REF		
700-004	shaft 4 mm trzcpień 4 mm	Laparoscopic electrode, wide hook Elektroda laparoskopowa, hak szeroki



700-005	shaft 4 mm trzcpień 4 mm	Laparoscopic electrode, thin hook Elektroda laparoskopowa, hak wąski
---------	-----------------------------	---



connection: monopolar electrode handles, pages:
połączenie: uchwyty elektrod monopolarnych, strony: [1](#), [18](#)





monopolar electrodes' adaptors

adaptery elektrod monopolarnych

	REF	Ø dia. średnica	
 I Ø 2.4mm	529-350	Ø 2.4 mm	Adaptor for 2.4 mm electrodes to handle 4 mm Adapter elektrod 2,4 mm do uchwytu 4 mm

extensions for standard electrodes





przedłużacze do elektrod standardowych

	 Ø 4 mm	length długość	
	527-550	150 mm	Extension for electrodes 4 mm
	527-500	100 mm	Przedłużacz do elektrod standardowych 4 mm
	 Ø 2.4 mm		
	533-900	100 mm	Extension for electrodes 2.4 mm
	533-950	150 mm	Przedłużacz do elektrod standardowych 2,4 mm

The extended insulated shaft is enabling safe reaching to deeper tissue structures.
Wydłużony izolowany trzpień umożliwia użytkownikowi bezpieczne dotarcie do głębiej położonych struktur.



electrode handles large

uchwyty elektrod szerokie

3-pin plug wtyk 3-pin	REF	cable length dł. kabla	Ø dia. średnica	
	322-145	4m	4 mm	Electrode handle, large, 2 switches Uchwyt elektrody, szeroki, 2 przyciski
				
ERBE plug wtyk ERBE	REF	cable length dł. kabla	Ø dia. średnica	
	110-145	4 m	4 mm	Electrode handle, large, 2 switches Uchwyt elektrody, szeroki, 2 przyciski
				







electrode handles small

uchwyty elektrod wąskie

3-pin plug wtyk 3-pin	REF	cable length dł. kabla	Ø dia. średnica	
	215-230	3 m	4 mm	Electrode handle small, 2 switches Uchwyt elektrody wąski, 2 przyciski
	218-230	3 m	2.4 mm	Electrode handle small, 2 switches Uchwyt elektrody wąski, 2 przyciski
				

sterile disposable handles & electrodes

sterylne uchwyty i elektrody jednorazowe

	REF	cable length dł. kabla	box opakowanie	
3-pin plug wtyk 3-pin 	847-030	3 m	10 pcs. 10 szt.	Disposable handle with knife electrode, 2 switches, sterile Uchwyt jednorazowy z elektrodą, nóż, 2 przyciski, sterylny
	847-031	3 m	10 pcs. 10 szt.	Disposable handle with needle electrode, 2 switches, sterile Uchwyt jednorazowy z elektrodą, igła, 2 przyciski, sterylny
				
ERBE plug 5mm wtyk ERBE 5mm 	847-033	3 m	10 pcs. 10 szt.	Disposable handle with knife electrode, 2 switches, ERBE plug, sterile Uchwyt jednorazowy z elektrodą, nóż, 2 przyciski, wtyk ERBE, sterylny
				
3-pin plug wtyk 3-pin 	847-032	3 m	10 pcs. 10 szt.	Disposable handle with knife electrode, holster and tip cleaner, sterile Uchwyt jednorazowy z nożem, w zestawie
				

Disposable electrode, ball 4 mm, for 2.4 mm handle, sterile Elektroda jednorazowa, kulka 4 mm, do uchwytu 2,4 mm, sterylna	840-440	
	840-441	 non-stick
Disposable electrode, knife, for 2.4 mm handle, sterile Elektroda jednorazowa, nóż, do uchwytu 2,4 mm, sterylna	840-450	
	840-451	 non-stick
Disposable electrode, needle, for 2.4 mm handle, sterile Elektroda jednorazowa, igła, do uchwytu 2,4 mm, sterylna	840-460	
	840-461	 non-stick



bipolar forceps

szczypce bipolarne

	REF	length długość	TIP bransza	
	605-020 605-016	110 mm	0,5 mm 1 mm	Bipolar forceps, straight Szczypce bipolarne, proste



	605-021	110 mm	0,5 mm	Bipolar forceps, angled Szczypce bipolarne, kątowe
--	---------	--------	--------	---



	605-024 605-007 605-058 605-014 605-001	220 mm 195 mm 195 mm 160 mm 195 mm	1 mm 2 mm 2 mm / profile 1 mm 1 mm	Bipolar forceps, angled Szczypce bipolarne, kątowe
--	---	--	--	---



	605-070 605-030 605-041 605-029 605-040 605-057 605-027 605-039 605-011	300 mm 220 mm 220 mm 195 mm 195 mm 195 mm 160 mm 160 mm 160 mm	2 mm 2 mm 1 mm 2 mm 1 mm 2 mm/profile 2 mm 1 mm needle/igła	Bipolar forceps, straight Szczypce bipolarne, proste
--	---	--	---	---



	605-065	195 mm	1 mm	Bipolar forceps, bayonet, angled Szczypce bipolarne, bagnetowe, kątowe
--	---------	--------	------	---



	REF	length długość	TIP bransza	
	605-063	220 mm	1 mm	Bipolar forceps bayonet, angled up
	605-026	195 mm	1 mm	Szczypce bipolarne bagnetowe, kątowe góra



	605-031	220 mm	0,5 mm	Bipolar forceps, bayonet Szcypce bipolarne, bagnetowe
	605-034	195 mm	2 mm	
	605-002	195 mm	1 mm	
	605-008	195 mm	needle/igła	
	605-018	160 mm	1 mm	
	605-017	160 mm	0,5 mm	



bipolar scissors

nożyczki bipolarne

REF	length długość	
857-18110	18 cm	BiTech bipolar scissors, angled Nożyczki bipolarne BiTech, zagięte
857-21110	21 cm	
857-23110	23 cm	
857-28110	28 cm	

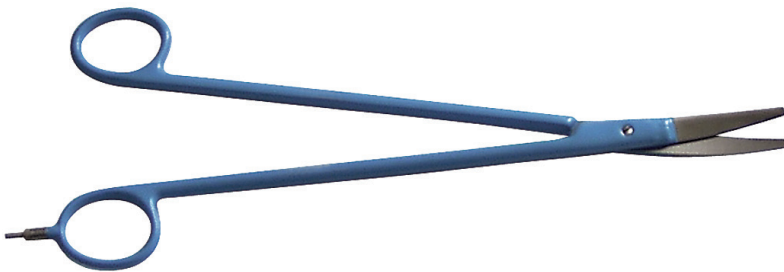

Bipolar scissors are intended for mechanical cutting with simultaneous bipolar coagulation. Do not use bipolar scissors in bipolar cutting mode.

Narzędzie służy do mechanicznego cięcia z jednoczesną koagulacją bipolarną. Nożyczek nie należy używać w trybie cięcia bipolarnego.

connection: bipolar cables, pages:
połączenie: kable bipolarne, strony: 5, 22



bipolar cables for scissors

kable bipolarne do nożyczek

	REF	length długość	
2-pin 29mm plug wtyk 2-pin 29mm	358-030 358-050	3 m 5 m	Bipolar cable for BiTech scissors Kabel bipolarny do nożyczek BiTech
			

bipolar laparoscopic instruments

bipolarne narzędzia laparoskopowe

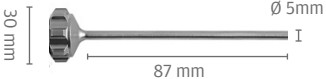
	REF	length długość	
 instrument with fixed cable, pages: 6 instrument z nierozłącznym kablem, strony: 6	824-101		Handle, reusable, for bipolar laparoscopic instrument Uchwyt, wielorazowy do bipolarnego instrumentu laparoskopowego
 30 mm 327 mm Ø 5mm	824-134	340 mm	Outer shaft, reusable, for bipolar laparoscopic instrument Rurka zewnętrzna, wielorazowa do bipolarnego instrumentu laparoskopowego
 30 mm 87 mm Ø 5mm	824-110	100 mm	



connection: bipolar cables, pages:
połączenie: kable bipolarne, strony: 4, 24





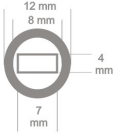

	REF	length długość	
 <p>ThermoStapler® 17 mm 1 mm</p>	824-519	100 mm	Insert: dissector Maryland, for bipolar laparoscopic instrument
	824-019	340 mm	Wkład disektor Maryland, wielorazowy do bipolarnego instrumentu laparoskopowego
 <p>ThermoStapler® 13 mm 5 mm</p>	824-501	100 mm	Insert: grasping forceps, fenestrated, for bipolar laparoscopic instrument
	824-010	340 mm	Wkład grasper okienkowy, wielorazowy do bipolarnego instrumentu laparoskopowego
 <p>ThermoStapler® 13 mm 4 mm</p>	824-030	340 mm	Insert: grasping forceps, toothed, large, reusable, for bipolar laparoscopic instrument
			Wkład grasper ząbkowany, pełny, wielorazowy do bipolarnego instrumentu laparoskopowego
 <p>ThermoStapler® 17 mm 3 mm</p>	824-031	340 mm	Insert: dissector Maryland, wide, reusable, for bipolar laparoscopic instrument
			Wkład disektor Maryland, szeroki, wielorazowy do bipolarnego instrumentu laparoskopowego
 <p>3 mm 12 mm</p>	824-011	340 mm	Insert: forceps, delicate curved, reusable, for bipolar laparoscopic instrument
			Wkład szczypce lekko zakrzywione, wielorazowy do bipolarnego instrumentu laparoskopowego
 <p>10 mm 12 mm</p>	824-014	340 mm	Insert: micro-grasper, fenestrated, reusable, for bipolar laparoscopic instrument
			Wkład mikro-grasper, okienkowy, wielorazowy do bipolarnego instrumentu laparoskopowego
 <p>14 mm 2 mm</p>	824-015	340 mm	Insert: grasping forceps, fenestrated, curved, reusable, for bipolar laparoscopic instrument
			Wkład grasper bipolarny, okienkowy, zakrzywiony, wielorazowy do bipolarnego instrumentu laparoskopowego
 <p>16 mm 2 mm</p>	824-018	340 mm	Insert: scissors, curved, reusable, for bipolar laparoscopic instrument
			Wkład nożyczki bipolarne, zakrzywione, wielorazowy do bipolarnego instrumentu laparoskopowego

Do not use bipolar scissors in bipolar cutting mode.
Nożyczek nie należy używać w trybie cięcia bipolarnego.

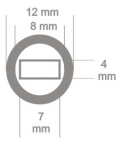
bipolar connecting cables



kable bipolarnie





	REF	cable length dł. kabla	plug wtyk	
	351-031	3 m	2-pin 29mm plug wtyk 2-pin 29mm	Bipolar cable Kabel bipolarny
	351-051	5 m		
	101-001	3 m	ERBE plug wtyk ERBE	Bipolar cable Kabel bipolarny
	101-000	4 m		
	287-030	3 m	BERCHTOLD, MARTIN plug wtyk BERCHTOLD, MARTIN	Bipolar cable Kabel bipolarny
	287-050	5 m		

		REF	cable length dł. kabla	plug wtyk	
 		351-131	3 m	2-pin 29 mm plug wtyk 2-pin 29 mm	Bipolar cable Kabel bipolarny
		351-151	5 m		
	 	101-101	3 m	ERBE plug wtyk ERBE	Bipolar cable Kabel bipolarny
		101-100	4 m		
	 	287-130	3 m	BERTHOLD, MARTIN plug wtyk BERTHOLD, MARTIN	Bipolar cable Kabel bipolarny
		287-150	5 m		

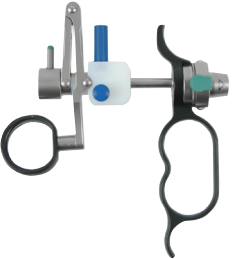
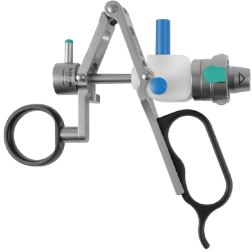
universal resectoscope 17,5 Fr.

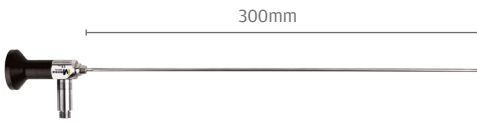





resektoskop uniwersalny 17,5 Fr.

	REF	
	77-417-17	<p>MINI-OFFICE „S”, Resectoscope inner sheath 17 charr with ceramic isolation, rotatable</p> <p>MINI-OFFICE „S”, Płaszcz wewnętrzny resektoskopu 17 charr z izolacją ceramiczną, obrotowy</p>
	77-417-18	<p>MINI-OFFICE „S”, Outer sheath, 17,5 charr perforation and 2 rotatable stopcocks</p> <p>MINI-OFFICE „S”, Płaszcz zewnętrzny resektoskopu 17,5 charr, perforowany, 2 zawory obrotowe</p>
	77-400-17	<p>Saline working element, bipolar, passive cutting, single stem, 17 charr</p> <p>Bipolarny element roboczy do soli fizjologicznej, pasywny do cięcia, pojedynczy trzonek, 17 charr</p>
	77-401-17	<p>Saline working element, bipolar, active cutting, single stem, 17 charr</p> <p>Bipolarny element roboczy do soli fizjologicznej, aktywny do cięcia, pojedynczy trzonek, 17 charr</p>

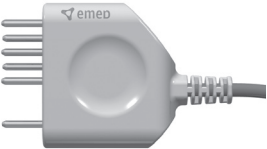
	REF	
	72-292-00	Premium HD Hysteroscope 300mm/0°/2,9mm Optyka Histeroskopu Premium HD 300mm/0°/2,9mm
	72-292-12	Premium HD Hysteroscope 300mm/12°/2,9mm Optyka Histeroskopu Premium HD 300mm/12°/2,9mm
	72-292-30	Premium HD Hysteroscope 300mm/30°/2,9mm Optyka Histeroskopu Premium HD 300mm/30°/2,9mm
	77-410-17	Loop electrode bipolar, angled 30° 17charr., Box of 6 pcs. Bipolarna elektroda pętlowa, kątowna 30°, 17 charr., op. 6 szt.
	77-412-17	Loop electrode bipolar, angled 30° 17charr., Box of 6 pcs. „Sharp-cut”/0,3mm Bipolarna elektroda pętlowa, kątowna 30°, 17 charr., op. 6 szt. „sharp-cut”/0,3mm
	77-430-13	Ball electrode saline, 2 mm, 13 charr, for „XS” system; box of 6 pcs. Bipolarna elektroda kulka, 2 mm, 13 charr., Do systemu MINI-OFFICE „XS”, Op. 6 szt.
	77-417-02	MINI-OFFICE „S”, Obturator for resectoscope sheaths 17 charr MINI-OFFICE „S”, Obturator do resektoskopu 17 charr

cables for resectoscope

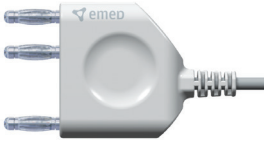
kable do resektoskopu

SDS plug wtyk SDS	REF	cable length dł. kabla	
	354-04S	4.5 m	Bipolar cable for resectoscope Kabel bipolarny do resektoskopu
			
	405-04S	4.5 m	Monopolar cable for resectoscope, 2 mm male plug Kabel monopolarny do resektoskopu, wtyk męski 2 mm
			
2-pin 29 mm plug wtyk 2-pin 29 mm	354-04S	4.5 m	Bipolar cable for resectoscope Kabel bipolarny do resektoskopu
			
3-pin plug wtyk 3-pin	405-14S	4.5 m	Monopolar cable for resectoscope, 2 mm male plug Kabel monopolarny do resektoskopu, wtyk męski 2mm
			

bipolar arthroscopic electrodes

bipolarne elektrody artroskopowe

		REF	length długość	
		587-010 587-030	115 mm 170 mm	Bipolar needle electrode, angled 90°, 0.6 x 1.5 mm Elektroda bipolarna, igła, zagięta 90°, 0,6 x 1,5 mm
		587-020 587-060	115 mm 170 mm	Bipolar needle electrode, angled 90°, 0.6 x 4 mm Elektroda bipolarna, igła zagięta 90°, 0,6 x 4 mm
		587-040	115 mm	Bipolar button electrode, angled 90°, 1.5 x 4 mm Elektroda bipolarna, klawiszowa, zagięta 90°, 1,5 x 4 mm
		587-110 587-140	115 mm 170 mm	Bipolar vaporization electrode, Phazer, convex, angled 70°, ball 2.4 mm Elektroda bipolarna do waporyzacji - Phazer, wypukła, zagięcie 70°, śr. kulki 2,4 mm
		587-930 587-920	115 mm 170 mm	Bipolar vaporization electrode, round, VAP Elektroda bipolarna do waporyzacji , okrągła , VAP

connection: bipolar cables, pages:
połączenie: kable bipolarne, strony: [4](#), [24](#)



ThermoStapler® vessel sealing clamps

kleszczyki do bipolarnego zamykania naczyń



angled
zagięte



straight
proste

	REF	length długość		
	801-116	16 cm		ThermoStapler® - bipolar vessel sealing clamps, angled, smooth Kleszczyki do bipolarnego zamykania naczyń, zakrzywione, gładkie
	801-118	18 cm		ThermoStapler® - bipolar vessel sealing clamps, angled, smooth Kleszczyki do bipolarnego zamykania naczyń, zakrzywione, gładkie
	801-123	23 cm		
	801-128	28 cm		
	801-218	18 cm		ThermoStapler® - bipolar vessel sealing clamps, straight, smooth Kleszczyki do bipolarnego zamykania naczyń, proste, gładkie
	801-223	23 cm		



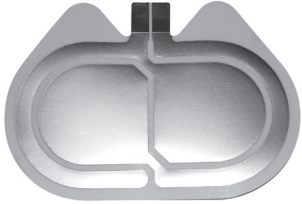
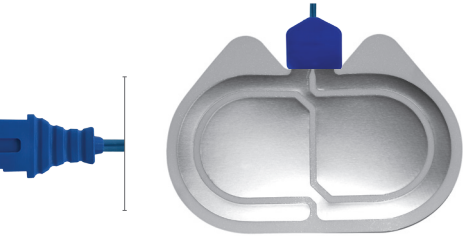
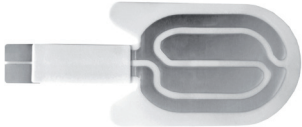
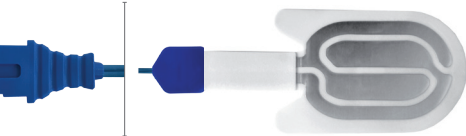

disposable neutral electrodes

elektrody neutralne jednorazowe

	REF	dimensions wymiały	box opakowanie	
	812-80H	176x122 mm	10x5 pcs. 10x5 szt.	<p>Disposable neutral electrode EMED SAFE, hydrogel, split, for adults and children, 176x122mm, 110cm²</p> <p>Elektroda neutralna jednorazowa EMED SAFE, hydrożel, dzielona, dla dorosłych i dzieci, 176x122mm, 110cm²</p>
	812-85H	176x122 mm	8x1 pcs. 8x1 szt.	<p>Disposable neutral electrode EMED SAFE, hydrogel, split, for adults and children, 176x122mm, 110cm², with 3m US cable</p> <p>Elektroda neutralna jednorazowa EMED SAFE, hydrożel, dzielona, dla dorosłych i dzieci, 176x122mm, 110cm², z kablem USA 3m</p>
	812-83H	181x76 mm	10x5 pcs. 10x5 szt.	<p>Disposable neutral electrode EMED SAFE, hydrogel, split, for infants, 181x76mm, 37cm²</p> <p>Elektroda neutralna jednorazowa EMED SAFE, hydrożel, dzielona, dla noworodków, 181x76mm, 37cm²</p>
	812-88H	181x76 mm	8x1 pcs. 8x1 szt.	<p>Disposable neutral electrode EMED SAFE, hydrogel, split, for infants, 181x76mm, 37cm², with 3m US cable</p> <p>Elektroda neutralna jednorazowa EMED SAFE, hydrożel, dzielona, dla noworodków, 181x76mm, 37cm², z kablem USA 3m</p>









reusable neutral electrodes

elektrody neutralne wielokrotnego użycia

	REF	dimensions wymiary	cable length dł. kabla	plug wtyk	
	242-008	30x17 cm	4 m	EMED plug wtyk EMED	Neutral silicone electrode, reusable, for adults Elektroda neutralna silikonowa, wielorazowa, dla dorosłych
					
	242-003	30x17 cm	0.5 m		Neutral silicone electrode, reusable, for adults Elektroda neutralna silikonowa, wielorazowa, dla dorosłych
					

neutral electrodes cables



kable do elektrod neutralnych

	REF	cable length dł. kabla	plug wtyk	
	380-030	3 m	flat plug wtyk płaski	Disposable neutral electrode cable Kabel elektrody neutralnej jednorazowej
	380-050	5 m		
				
	294-030	3 m	EU 6.3mm plug wtyk EU 6,3mm	Disposable neutral electrode cable Kabel elektrody neutralnej jednorazowej
	294-050	5 m		
				
	385-030	3 m	flat plug wtyk płaski	Cable for reusable silicone neutral electrode Kabel wielorazowej elektrody neutralnej silikonowej
	385-050	5 m		
				
	295-030	3 m	EU 6.3mm plug wtyk EU 6,3mm	Cable for reusable neutral silicone electrode 242-003, 232-003 Kabel wielorazowej elektrody neutralnej silikonowej 242-003, 232-003
	295-050	5 m		
				





Laparoscopic monopolar cables

kable monopolarne do laparoskopu

	female 4 mm gniazdo żeńskie 4 mm	REF	cable length dł. kabla	
3-pin plug wtyk 3-pin		280-130 280-150	3 m	Monopolar laparoscopic cable Kabel monopolarny do laparoskopu
			5 m	
ERBE plug wtyk ERBE			101-051	5 m
USA 8mm male plug wtyk męski USA 8mm				360-030 360-050
		5 m		





endoscopic monopolar cables

kable monopolarne do endoskopu

	female 3 mm gniazdo żeńskie 3 mm	REF	cable length dł. kabla	
3-pin plug wtyk 3-pin		281-130	3 m	Monopolar endoscopic cable Kabel monopolarny do narzędzi endoskopowych
ERBE plug wtyk ERBE			181-030	3 m
USA 8mm male plug wtyk męski USA 8mm				161-030





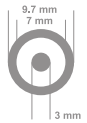

monopolar cables for resectoscope

kable monopolarne do resektoskopu

	male 2 mm wtyk męski 2 mm	REF	cable length dł. kabla	
ERBE plug wtyk ERBE	  	106-045	4.5 m	Monopolar cable for resectoscope Kabel monopolarny do resektoskopu
USA 8mm male plug wtyk męski USA 8mm		375-045	4.5 m	Monopolar cable for resectoscope Kabel monopolarny do resektoskopu
3-pin plug wtyk 3-pin		405-145	4.5 m	Monopolar cable for resectoscope Kabel monopolarny do resektoskopu
3-pin plug wtyk 3-pin	angled connector złącze kątowe			
		408-145	4.5 m	Monopolar cable for STORZ resectoscope Kabel monopolarny do resektoskopu STORZ
	male plug 3 mm wtyk męski 3 mm	 	409-145	4.5 m

other bipolar cables

inne kable bipolarne

2-pin 29mm plug wtyk 2-pin 29mm	REF	cable length dł. kabla	
	348-045	4.5 m	Bipolar cable for STORZ resectoscope Kabel bipolarny do resektoskopu STORZ
			
	354-045	4.5 m	Bipolar cable for resectoscope Kabel bipolarny do resektoskopu
			
	349-045	4.5 m	Bipolar cable for OLYMPUS resectoscope Kabel bipolarny do resektoskopu OLYMPUS
			
359-030 359-050	3 m 5 m	Bipolar cable for laparoscopy STORZ Kabel bipolarny laparoskopowy do narzędzi STORZ	
			
352-030 352-050	3 m 5 m	Bipolar cable for WOLF laparoscopy Kabel bipolarny laparoskopowy do narzędzi WOLF	
			



argon instruments

narzędzia argonowe







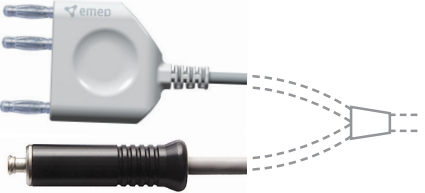

REF	
932-031	Argon electrode, rigid, insulated shaft, 25 mm w. length, dia. 5 mm Elektroda argonowa sztywna do koagulacji, 25 mm dł. robocza, śr. 5 mm
932-032	Argon electrode, rigid, insulated shaft, 100 mm w. length, dia. 5 mm Elektroda argonowa sztywna do koagulacji, 100 mm dł. robocza, śr. 5 mm
932-034	Argon electrode, rigid, insulated shaft, 320 mm w. length, dia. 5 mm Elektroda argonowa sztywna do koagulacji, 320 mm dł. robocza, śr. 5 mm
932-054	Argon needle, rigid, insulated shaft, 40 mm w. length, dia. 5 mm Igła prosta 14 mm, argonowa sztywna, dł. robocza 40 mm, śr. 5 mm
932-044	Argon needle, rigid, insulated shaft, 115 mm w. length, dia. 5 mm Igła prosta 14 mm argonowa sztywna, dł. robocza 115 mm, śr. 5 mm
932-057	Argon lancet 14mm, rigid, insulated shaft, 40 mm w. length, dia. 5 mm Lancet prosty 14 mm argonowy sztywny, dł. robocza 40 mm, śr. 5 mm
932-056	Argon lancet, rigid, insulated shaft, 115 mm w. length, dia. 5 mm Lancet prosty 14 mm argonowy sztywny, dł. robocza 115 mm, śr. 5 mm

rigid electrodes handle: 932-145, 932-14A or 932-141, pages:
uchwyt do elektrod sztywnych: 932-145, 932-14A lub 932-141, strony: [2, 39](#)

	REF	dia. średnica	length długość		
	932-148	1.5 mm	1.5 m	TBS*	Flexible argon probe, reusable Giętka sonda argonowa, wielorazowa
	932-149	2.3 mm	2.2 m	GIT*	
	932-150	3.2 mm	2.2 m	GIT	
	932-151	1.5 mm	3 m	TBS	*TBS - tracheobronchial
	932-152	2.3 mm	3 m	GIT	*GIT - gastrointestinal

























flat type plug / złącze owalne

3-pin/LuerLock plug wtyk 3-pin/ LuerLock	REF	cable length dł. kabla	
	932-141	3.5 m	Argon electrode handle, large, 2 switches Uchwyt elektrody argonowej, szeroki, 2 przyciski
			
	432-146	3.5 m	Monopolar cable for argon flexible electrode, flat connector Kabel monopolarny do giętkiej elektrody argonowej, złącze owalne
			
	REF		
	100-051		Argon Cylinder 5L (empty cylinder - with no gas) Butla argonowa 5L (pusta / bez gazu)
	100-151		Argon Cylinder 10L (empty cylinder - with no gas) Butla argonowa 10L (pusta / bez gazu)
 <p data-bbox="193 1500 512 1561">other types available on request inne typy dostępne na żądanie</p>	5501640		Argon regulator P300-P40EMED, DIN 477/6 (Europe) Reduktor argonowy P300-P40EMED, DIN 477/6 (Europa)
	5501565		Argon regulator P300-P40EMED, DIN 477/6 (Europe) with pressure sensor Reduktor argonowy P300-P40EMED, DIN 477/6 (Europa) z czujnikiem ciśnienia
	5501641		Argon regulator P300-P40EMED, DIN 477/10 (Northern Europe) Reduktor argonowy P300-P40EMED, DIN 477/10 (Europa Północna)
	5501621		Argon regulator P300-P40EMED, BS 341/3 (UK) Reduktor argonowy P300-P40EMED, BS 341/3 (Wielka Brytania)
	5501631		Argon regulator P300-P40EMED, CGA 580 (America) Reduktor argonowy P300-P40EMED, CGA 580 (Ameryka)
 	SLGS 033SB		Argon bacteria filter, 0.33mm, 0.22um, sterile, 1pcs. Filtr argonowy antybakteryjny, 0,33mm, 0,22 um, sterylny, 1szt.
	100-053		Pneumatic argon cable, L: 3 m Kabel pneumatyczny do argonu, dł. 3 m other lengths available on request inne długości dostępne na żądanie

footswitches



włączniki nożne

		REF	cable length dł. kabla	
	 	100-336		Three-pedal footswitch, MultiSwitch, wireless Włącznik nożny 3-przyciskowy, MultiSwitch, bezprzewodowy
		100-316	5 m	Three-pedal footswitch, 6-pin plug Włącznik nożny 3-przyciskowy, wtyk 6-pinowy
	 	100-313		MultiSwitch, two-pedal footswitch, wireless Włącznik nożny 2-przyciskowy MultiSwitch, bezprzewodowy
		100-303	5 m	MultiSwitch, two-pedal footswitch, 6-pin plug Włącznik nożny 2-przyciskowy MultiSwitch, wtyk 6-pinowy
		100-302	5 m	Two-pedal footswitch, 6-pin plug Włącznik nożny 2-przyciskowy, wtyk 6-pinowy
	 	100-315		One-pedal footswitch, for COAGULATION, wireless Włącznik nożny 1-przyciskowy, do KOAGULACJI, bezprzewodowy
		100-305	5 m	One-pedal footswitch, for COAGULATION, 6-pin plug Włącznik nożny 1-przyciskowy, do KOAGULACJI, wtyk 6-pinowy
	 	100-314		One-pedal footswitch, for CUTTING, wireless Włącznik nożny 1-przyciskowy, do CIĘCIA, bezprzewodowy
		100-304	5 m	One-pedal footswitch, for CUTTING, 6-pin plug Włącznik nożny 1-przyciskowy, do CIĘCIA, wtyk 6-pinowy
	 	100-311		One-pedal footswitch, wireless Włącznik nożny 1-przyciskowy, bezprzewodowy
		100-301	5 m	One-pedal footswitch, 6-pin plug Włącznik nożny 1-przyciskowy, wtyk 6-pinowy

For ES120 unit and WATERFALL pump
Do aparatu ES120 i pompy WATERFALL

trolleys

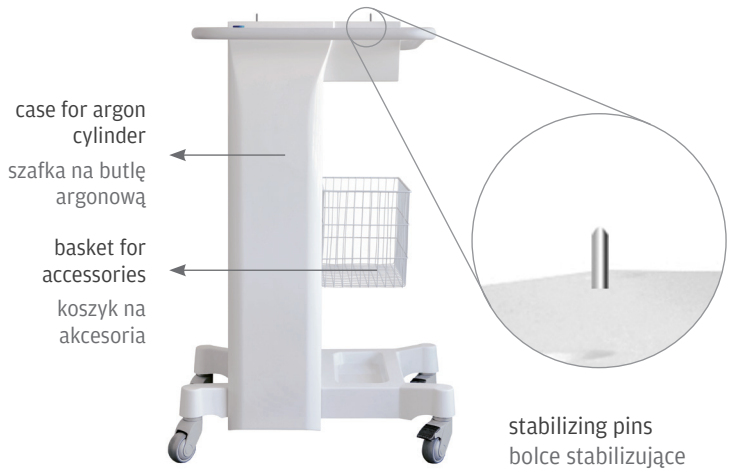
wózki pod aparaty elektrochirurgiczne

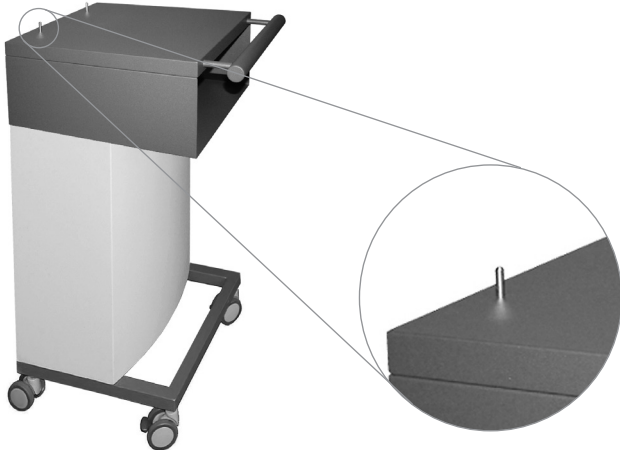
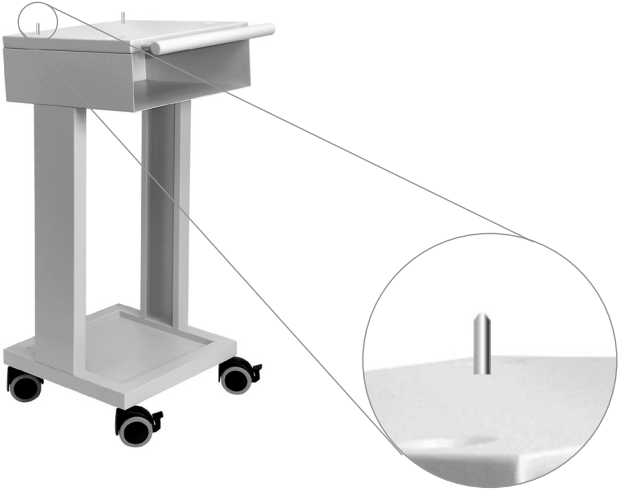

	REF	
 <p>case for argon cylinder szafka na butlę argonową</p> <p>basket for accessories koszyk na akcesoria</p> <p>stabilizing pins bolce stabilizujące</p>	080-100	<p>SpectrumLine trolley with argon cylinder case for electrosurgical units (2x 5L/10L), basket</p> <p>Wózek SpectrumLine z szafką na butlę argonowe do aparatów elektrochirurgicznych (2x 5L/10L), koszyk</p> <p>Trolley for units: SPECTRUM, ES350 Wózek do aparatów: SPECTRUM, ES350</p>
 <p>case for argon cylinder szafka na butlę argonową</p> <p>basket for accessories koszyk na akcesoria</p>	080-060	<p>TinyLine trolley with argon cylinder case for electrosurgical units (5L/10L), basket</p> <p>Wózek TinyLine z szafką na butlę argonową do aparatów elektrochirurgicznych (5L/10L), koszyk</p> <p>Trolley for units: ATOM, ENDO Wózek do aparatów: ATOM, ENDO</p>
 <p>case for accessories szafka na akcesoria</p>	080-061	<p>TinyLine trolley for electrosurgical units with case for accessories</p> <p>Wózek TinyLine do aparatów elektrochirurgicznych z szafką na akcesoria</p> <p>Trolley for units: ATOM, ARTRO, ATOM smart Wózek do aparatów: ATOM, ARTRO, ATOM Smart</p>

	REF	
 <p data-bbox="571 1011 753 1073">stabilizing pins bolce stabilizujące</p>	<p data-bbox="885 801 986 827">080-040</p>	<p data-bbox="1013 643 1412 731">NewLine trolley with argon cylinder case for electro-surgical units (2x5L)</p> <p data-bbox="1013 772 1295 883">Wózek NewLine z szafką na butle argonowe do aparatów elektrochirurgicznych (2x5L)</p> <p data-bbox="1013 923 1279 985">Trolley for units: ES350 Wózek do aparatów: ES350</p>
 <p data-bbox="571 1757 753 1819">stabilizing pins bolce stabilizujące</p>	<p data-bbox="885 1312 986 1338">080-005</p> <p data-bbox="885 1692 986 1719">080-006</p>	<p data-bbox="1013 1205 1375 1263">SimpleLine trolley for electro-surgical units</p> <p data-bbox="1013 1304 1321 1361">Wózek SimpleLine do aparatów elektrochirurgicznych</p> <p data-bbox="1013 1394 1423 1455">Trolley for units: ES300, ES350, ES120 Wózek do aparatów: ES300, ES350, ES120</p> <p data-bbox="1013 1557 1423 1614">SimpleLine trolley without stabilizing pins for electro-surgical units</p> <p data-bbox="1013 1647 1305 1733">Wózek SimpleLine bez bolców stabilizujących do aparatów elektrochirurgicznych</p> <p data-bbox="1013 1766 1348 1827">Trolley for units: ES350, ES120 Wózek do aparatów: ES350, ES120</p>

EMED electrosurgical units

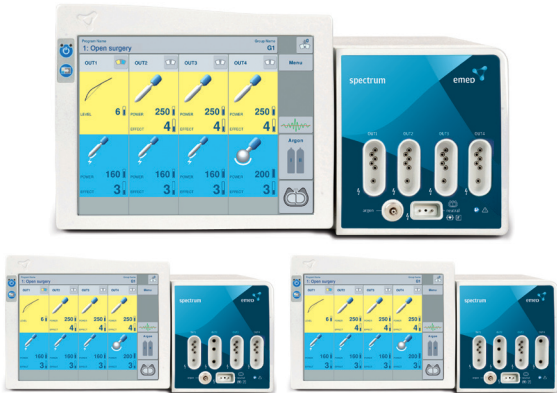
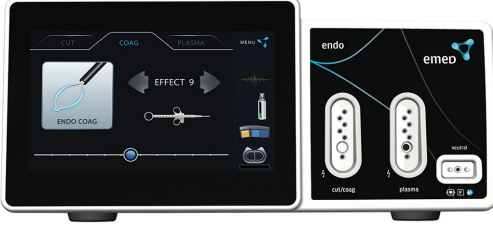
aparaty elektrochirurgiczne EMED

	REF	
 <p>The image shows the EMED SPECTRUM electrosurgical unit. It features a large touchscreen display on the left with a multi-panel interface for 'Open surgery' and 'Endo surgery'. The display shows various energy settings and waveforms. To the right is a control panel with several buttons and a 'neutral' indicator.</p>	100-013	Electrosurgical unit SPECTRUM Aparat elektrochirurgiczny SPECTRUM
 <p>The image shows the EMED ATOM electrosurgical unit. The touchscreen display displays four modes: POLYPO CUT, MONO CUT, ENDO SPRAY, and FORCED COAG. The control panel has two main output buttons labeled 'OUT 1' and 'OUT 2', along with a 'neutral' indicator.</p>	100-620	Electrosurgical unit ATOM Aparat elektrochirurgiczny ATOM
 <p>The image shows the EMED ENDO electrosurgical unit. The touchscreen display shows 'ENDO COAG' and 'EFFECT 9' settings. The control panel includes buttons for 'cut/coag' and 'plasma', and a 'neutral' indicator.</p>	100-600	Electrosurgical unit ENDO Aparat elektrochirurgiczny ENDO
 <p>The image shows the EMED ARTRO electrosurgical unit. The touchscreen display shows 'ARTRO' settings with 'OUT EFFECT 3' and 'COAG EFFECT 3'. The control panel has an 'OUT' button and a 'neutral' indicator.</p>	100-610	Electrosurgical unit ARTRO Aparat elektrochirurgiczny ARTRO

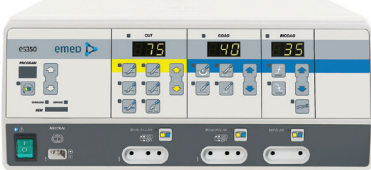
	REF	
	100-630	Electrosurgical unit ATOM smart Aparat elektrochirurgiczny ATOM Smart
	100-015	Electrosurgical unit ES 120 Aparat elektrochirurgiczny ES 120
	100-007	Electrosurgical unit ES 350 Aparat elektrochirurgiczny ES 350

other accessories

inne akcesoria

	REF	
	F7520	Disposable abrasive tip cleaner, sterile, 100 pcs. Czyścik narzędzi elektrochirurgicznych, przyklejany, jednorazowy, op. 100 szt.







smoke evacuation system

system odsysania dymów operacyjnych

	REF	
	020-001	Smoke evacuator ARIA Odsysacz dymu ARIA
 	PA2010B	PenAdapt with 10 mm x 122 cm tubing with an adapter to 22 mm x 183 cm hose Nakładka na uchwyt z przewodem 10 mm x 122 cm
 	PA2010	PenAdapt with 10 mm x 122 cm tubing with an adapter to 22 mm x 183 cm hose, 10pcs Nakładka na uchwyt z przewodem 10 mm x 122 cm, opakowanie 10szt.
 	848-030	Disposable smoke evacuation handle with non-stick knife electrode, 2 switches, cable 3m, 3-pin plug, sterile Uchwyt jednorazowy do odsysania dymu z elektrodą nieklejącą, nóż, 2 przyciski, kabel dł. 3m, wtyk 3-pin, sterylny
	VS353	ARIA - spare filter ARIA - filtr wymienny
	BFPP7/8-10	ARIA, pre-filter, sterile, single-use, 10 pcs. ARIA, filtr wstępny, jednorazowego użytku, 10 szt.

WATERFALL endoscopic irrigation pump

endoskopowa pompa irygacyjna WATERFALL

	REF	
	020-100	WATERFALL endoscopic irrigation pump WATERFALL endoskopowa pompa irygacyjna
 (24h)	50200	EndoPump for Pentax® endoscope compatible wash pump Dren EndoPump do endoskopu Pentax kompatybilny z pompą irygacyjną EMED
 (24h)	50100	EndoPump for Olympus® endoscope compatible Emед washing pump Dren EndoPump do endoskopu OLYMPUS kompatybilny z pompą irygacyjną EMED
 (no 24h)	50190	Single-use connector compatible with Olympus® water jet channel endoscope Zawór jednorazowy kompatybilny z kanałem wodnym endoskopu Olympus®
 (no 24h)	50390	Fujifilm® water jet channel endoscope compatible disposable connector Zawór jednorazowy kompatybilny z kanałem wodnym endoskopu Fujifilm®
 (6-pin)	100-301	One-pedal footswitch, cable 5 m, 6-pin plug Włacznik nożny 1-przyciskowy, kabel 5 m, wtyk 6-pin

measuring devices for electrosurgical units

urządzenia pomiarowe do aparatów elektrochirurgicznych

	REF	
 <p>The image shows two views of the Emed ESU Test Case. On the left, the grey foam-lined case is open, revealing a blue and white electronic device. On the right, the closed case is shown, featuring the 'emed' logo and the text 'ETC1 - Emed ESU Test Case'.</p>	010-002	<p>ETC1 – Emed ESU Test Case ETC1 – Walizka testowa do aparatów Emed</p>
 <p>The image shows two views of the VA Argon flow meter. On the left, the device is inside its open grey foam-lined case. On the right, the flow meter is shown standing upright on a blue base with a blue tube connected to it.</p>	010-005	<p>VA Argon flow meter Rotametr do pomiaru przepływu Argonu</p>
 <p>The image shows two views of the MODUM ElectroSurgical Analyzer. On the left, the device is inside its open grey foam-lined case. On the right, the device is shown as a white rectangular unit with a large black touchscreen displaying various icons and data.</p>	010-100	<p>MODUM ElectroSurgical Analyzer MODUM Analizator elektrochirurgiczny</p>

product finder

indeks kodów



product finder

REF	Page/Strona
010-002	47
010-005	47
010-100	47
020-001	45
020-100	46
080-005	42
080-006	42
080-040	42
080-060	41
080-061	41
080-100	41
100-007	44
100-013	43
100-015	44
100-051	39
100-053	39
100-151	39
100-301	46
100-301	40
100-302	40
100-303	40
100-304	40
100-305	40
100-311	40
100-313	40
100-314	40
100-315	40
100-316	40
100-336	40
100-600	43
100-610	43
100-620	43
100-630	44
101-000	25
101-001	25
101-051	35
101-100	26
101-101	26

REF	Page/Strona
106-045	36
110-145	19
161-030	35
181-030	35
215-230	19
215-235	1
218-230	19
218-235	1
242-003	33
242-008	33
280-035	3
280-055	3
280-130	35
280-150	35
281-035	3
281-130	35
281-605	5
287-030	25
287-050	25
287-130	26
287-150	26
294-030	34
294-050	34
295-030	34
295-050	34
322-145	19
322-145	1
348-045	37
348-045	4
349-045	37
349-045	5
351-031	26
351-035	4
351-051	26
351-055	4
351-131	26
351-135	4
351-151	26

REF	Page/Strona
351-155	4
352-030	37
352-035	5
352-050	37
354-045	37
354-045	29
354-045	29
354-045	4
358-030	23
358-035	5
358-050	23
359-030	37
359-035	5
359-050	37
359-055	5
360-030	35
360-050	35
375-045	36
380-030	34
380-050	34
385-030	34
385-050	34
401-035	4
401-055	4
405-045	29
405-045	3
405-145	36
405-145	29
408-145	36
408-145	3
409-045	3
409-145	36
432-146	39
432-46A	2
432-46S	2
520-100	9
520-200	9
520-300	9

REF	Page/Strona	REF	Page/Strona	REF	Page/Strona
520-500	9	526-000	14	587-040	30
520-600	9	526-100	14	587-060	30
520-650	9	526-200	14	587-110	30
520-700	9	526-300	14	587-140	30
520-800	9	526-400	14	587-920	30
520-900	9	527-550	18	587-930	30
521-010	9	527-500	18	585-010	8
521-020	9	528-650	12	585-020	8
521-110	10	529-000	12	585-030	8
521-120	10	529-050	12	585-040	8
521-210	10	529-350	18	585-060	8
521-220	10	530-000	11	585-110	8
521-230	10	530-100	11	585-140	8
521-350	10	530-310	11	585-920	8
521-380	10	530-320	11	585-930	8
521-410	9	530-510	11	605-001	21
521-420	10	530-520	11	605-002	22
521-430	10	530-530	11	605-007	21
521-480	10	530-580	11	605-008	22
521-490	10	530-610	11	605-011	21
521-600	10	530-620	11	605-014	21
522-300	12	530-630	11	605-016	21
522-400	12	532-300	12	605-017	22
522-500	12	533-900	18	605-018	22
522-700	10	533-950	18	605-020	21
523-200	10	534-100	15	605-021	21
523-210	10	534-210	15	605-024	21
523-910	13	534-420	15	605-026	22
523-920	13	534-460	15	605-027	21
524-010	13	535-000	15	605-029	21
524-020	13	535-100	15	605-030	21
524-030	13	535-200	15	605-031	22
524-130	13	535-800	15	605-034	22
524-200	13	535-900	15	605-039	21
524-260	13	536-000	16	605-040	21
524-300	13	536-100	16	605-041	21
524-600	13	536-200	16	605-057	21
525-000	13	536-300	16	605-058	21
525-100	14	536-400	16	605-063	22
525-200	14	587-010	30	605-065	21
525-800	14	587-020	30	605-070	21
525-900	14	587-030	30	700-004	17

REF	Page/Strona	REF	Page/Strona	REF	Page/Strona
700-005	17	840-450	20	SLGS 033SB	39
72-292-00	28	840-451	20	VS353	45
72-292-12	28	840-460	20		
72-292-30	28	840-461	20		
77-400-17	27	847-030	20		
77-401-17	27	847-031	20		
77-410-17	28	847-032	20		
77-412-17	28	847-033	20		
77-417-02	28	847-530	6		
77-417-17	27	847-531	6		
77-417-18	27	848-030	45		
77-430-13	28	857-18110	22		
801-116	31	857-21110	22		
801-118	31	857-23110	22		
801-123	31	857-28110	22		
801-128	31	932-031	38		
801-165	7	932-032	38		
801-185	7	932-034	38		
801-218	31	932-044	38		
801-223	31	932-054	38		
801-235	7	932-056	38		
801-285	7	932-057	38		
812-80H	32	932-141	39		
812-83H	32	932-149	38		
812-85H	32	932-14A	2		
812-88H	32	932-145	2		
824-010	24	932-150	38		
824-011	24	932-152	38		
824-014	24	50100	46		
824-015	24	50190	46		
824-018	24	50200	46		
824-019	24	50390	46		
824-030	24	5501565	39		
824-031	24	5501621	39		
824-101	23	5501631	39		
824-110	23	5501640	39		
824-134	23	5501641	39		
824-135	6	5501661	39		
824-501	24	BFPF7/8-10	45		
824-519	24	F7520	44		
840-440	20	PA2010	45		
840-441	20	PA2010B	45		

contact us

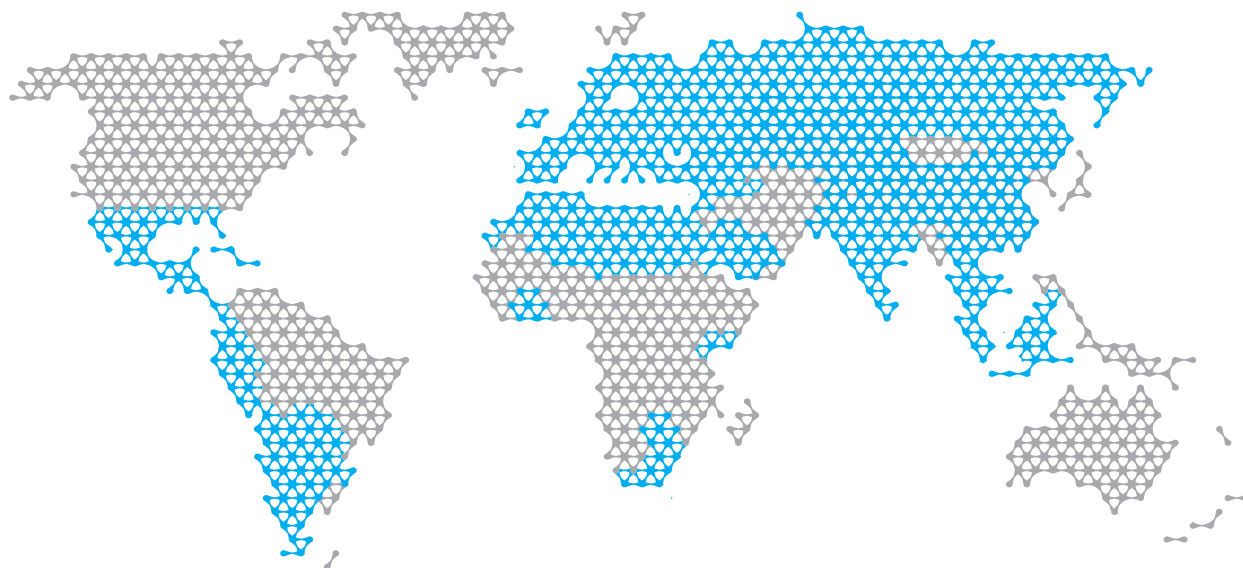

For more information please contact your EMED representative.

Copyright© EMED.

All rights reserved. Any copying, distribution, publishing in whole or in part without written EMED permission is prohibited.

For product information, including indications, contraindications, warnings, precautions, potential adverse effects and patient counselling information, see the Instructions For Use.

Aby uzyskać więcej informacji o produktach skontaktuj się z producentem lub autoryzowanym przedstawicielem.

Copyright© EMED.

Wszelkie prawa zastrzeżone. Wszelkie kopiowanie, rozpowszechnianie, publikowanie w całości lub w części bez pisemnej zgody EMED jest zabronione. Więcej informacji o produktach, w tym wskazania, przeciwwskazania, ostrzeżenia, środki ostrożności oraz potencjalne skutki niepożądane znajdują się w Instrukcjach Używania.

EMED SP. Z O. O. SP. K.

Ryżowa 69a, 05-816 Opacz-Kolonia

Phone: +48 22 723 08 00

www.emed.pl



(240)K01(10)2110

REF 2024.06.K01

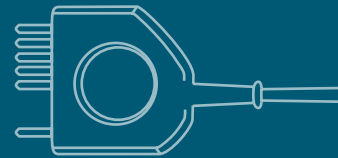
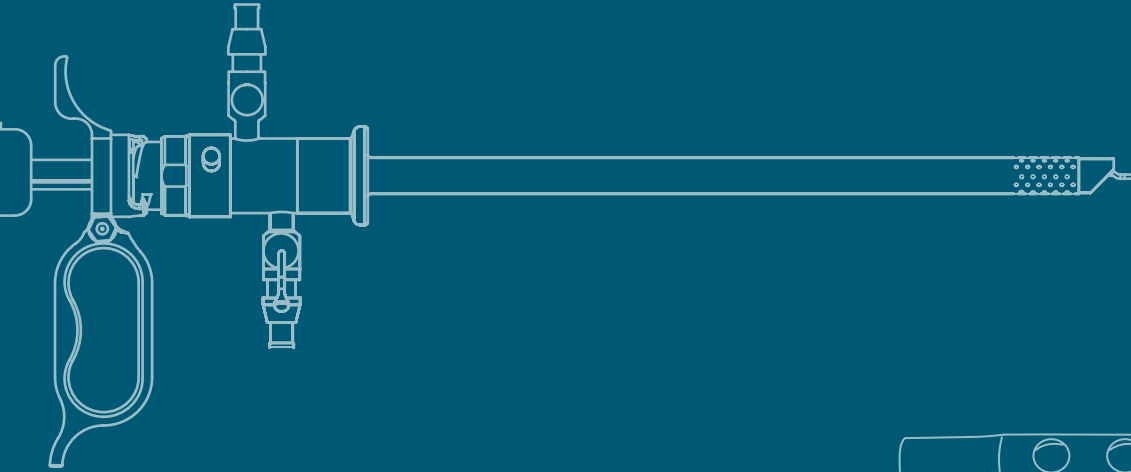
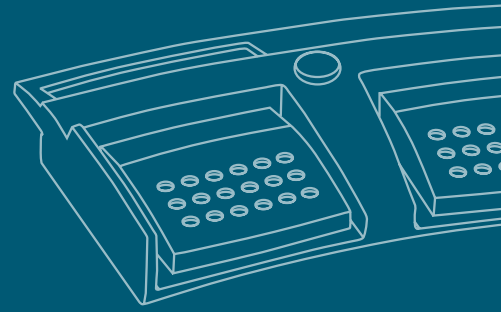
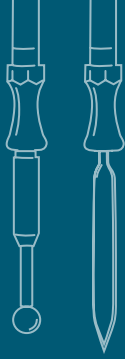

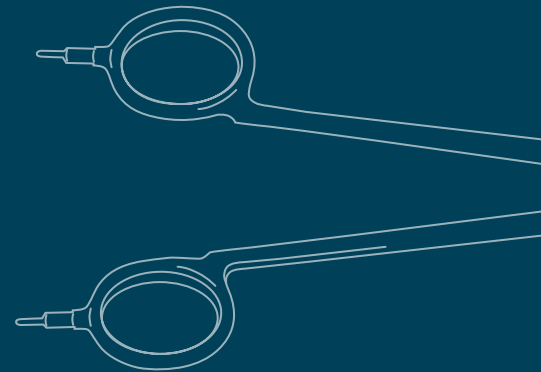
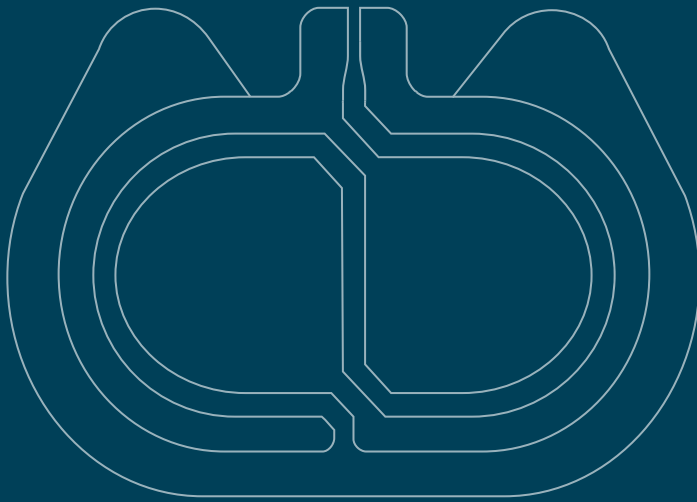
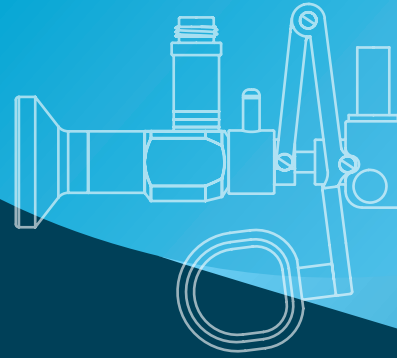

Attention! This brochure does not replace instructions for use! Consult instruction for use!

Uwaga! Niniejszy katalog nie zastępuje instrukcji używania! Należy zapoznać się z instrukcjami używania!



Scan QR code to check the current version of the catalogue.
Zeskanuj kod QR, aby sprawdzić aktualną wersję katalogu.