



Benannt durch/Designated by
 Zentralstelle der Länder
 für Gesundheitsschutz
 bei Arzneimitteln und
 Medizinprodukten
 www.zlg.de
 BS-MDR-099



Product Service

EU Quality Management System Certificate (MDR)

Pursuant to Regulation (EU) 2017/745 on Medical Devices, Annex IX Chapters I and III
 (Class IIa and Class IIb Devices)

No. G10 072017 0015 Rev. 00

Device(s):	Risk classification	CND Code	Intended Purpose
INSTRUMENTS FOR ANESTHESIA AND PULMONARY VENTILATION SUPPORT	IIb	Z120301	Intended for respiratory support, administration of anesthetic and treatment of neonatal, pediatric and adult patients.

The validity of this certificate depends on conditions and/or is limited to the following: ./.

Revision History including Changes:

Revision / Issue Date / Report
 Rev. 00 / 2020-02-17 / 713170827

ZERTIFIKAT ◆ CERTIFICATE ◆ 認證書 ◆ CERTIFIKAT ◆ CERTIFICADO ◆ CERTIFICAT



Benannt durch/Designated by
Zentralstelle der Länder
für Gesundheitsschutz
bei Arzneimitteln und
Medizinprodukten
www.zlg.de
ZLG-BS-244.10.08



Product Service

EC Certificate

Full Quality Assurance System
Directive 93/42/EEC on Medical Devices (MDD), Annex II excluding (4)
(Devices in Class IIa, IIb or III)

No. G1 072017 0014 Rev. 01

Manufacturer: **MAQUET CRITICAL CARE AB**
Röntgenvägen 2
171 54 Solna
SWEDEN

Facility(ies): MAQUET CRITICAL CARE AB
Röntgenvägen 2, 171 54 Solna, SWEDEN

**Product Category(ies): Anaesthesia, Monitoring, Ventilator and
Perfusion Systems**

The Certification Body of TÜV SÜD Product Service GmbH declares that the aforementioned manufacturer has implemented a quality assurance system for design, manufacture and final inspection of the respective devices / device categories in accordance with MDD Annex II. This quality assurance system conforms to the requirements of this Directive and is subject to periodical surveillance. For marketing of class III devices an additional Annex II (4) certificate is mandatory. See also notes overleaf.

Report No.: 713161324

Valid from: 2020-01-22
Valid until: 2024-05-26

Date, 2020-01-22

Christoph Dicks
Head of Certification/Notified Body

ZERTIFIKAT ◆ CERTIFICATE ◆ 認證書 ◆ CERTIFICADO ◆ CERTIFICAT



Certificate

No. Q5 072017 0013 Rev. 01

Holder of Certificate: **MAQUET CRITICAL CARE AB**
GETINGE ✱
Röntgenvägen 2
171 54 Solna
SWEDEN

Facility(ies): MAQUET CRITICAL CARE AB
Röntgenvägen 2, 171 54 Solna, SWEDEN

See Scope of Certificate

Certification Mark:



Scope of Certificate: **Design, development and manufacturing of Anaesthesia, Monitoring, Ventilator Systems and Perfusion Systems**

Applied Standard(s): EN ISO 13485:2016
Medical devices - Quality management systems - Requirements for regulatory purposes (ISO 13485:2016)
DIN EN ISO 13485:2016

The Certification Body of TÜV SÜD Product Service GmbH certifies that the company mentioned above has established and is maintaining a quality management system, which meets the requirements of the listed standard(s). All applicable requirements of the testing and certification regulation of TÜV SÜD Group have to be complied with. For details and certificate validity see: www.tuvsud.com/ps-cert?q=cert:Q5_072017_0013_Rev._01

Report No.: 713193727

Valid from: 2020-12-30

Valid until: 2023-12-29

Date, 2020-12-28

Christoph Dicks
Head of Certification/Notified Body

CERTIFICATE



EN ISO 13485:2016

DEKRA Certification GmbH hereby certifies that the organization

Richard Wolf GmbH

Scope of certification:

Design and development, production, distribution, installation and service of systems, active medical devices (sterile, non-sterile), non-active medical devices (sterile, non-sterile) for human medicine, in particular for endoscopy and extracorporeal shockwave application.
Design and development, production, and distribution of non-active implants in urology and surgery as well as accessories for processing (cleaning, disinfection, sterilization)

Certified location:

Pforzheimer Straße 32, 75438 Knittlingen, Germany

(further locations see annex)

has established and maintains a quality management system according to the above mentioned standard. The conformity was adduced with audit report no. 50593-R2-00.

Certificate registration no.:	50593-14-02	Certificate valid from:	2021-11-29
Validity of previous certificate:	2021-11-28	Certificate valid to:	2024-11-28



Ruth Delbeck-Bayer
DEKRA Certification GmbH, Stuttgart, 2021-11-29



Annex to the Certificate No. 50593-14-02

Revision status: 0

valid from 2021-11-29 to 2024-11-28

The following locations / companies belong to the certificate above:

	Headquarter	Certified location	Scope of certification
	Richard Wolf GmbH	Pforzheimer Straße 32 75438 Knittlingen Germany	see page 1
	at the following locations / at the companies at the following locations		Scope of certification
1.	Richard Wolf GmbH	Reuchlinstraße 10-11 10553 Berlin Germany	Manufacture of flexible and rigid endoscopes



Ruth Delbeck-Bayer
DEKRA Certification GmbH, Stuttgart, 2021-11-29

Annex to the EC Certificate No. 50593-16-05

Valid from 2020-04-01 to 2024-05-26

Revision status of the annex: 0 dated 2020-04-01

Devices/device categories included in the certificate:

- Rigid mediastinoscope
- Rigid nephroscope
- Rigid optical laparoscope
- Rigid ureterorenoscope
- Spinal needle, single-use
- Spring-loaded pneumoperitoneum needle, reusable
- Surgical drill guide, reusable
- Surgical fluid/smoke waste management system suction unit
- Surgical guillotine
- Surgical irrigation tubing set, reusable
- Surgical irrigation tubing set, single-use
- Surgical irrigation/aspiration handpiece, reusable
- Surgical irrigation/aspiration tubing set
- Surgical power tool system control unit, line-powered
- Tissue extraction bag
- Tissue morcellation system
- Tissue morcellation system handpiece, line-powered
- Uterine manipulator cervical cup/transilluminator
- Uterine manipulator, reusable
- Uterine probe

Class II b:

- Electrosurgical system generator
- Endoscopic electrosurgical electrode, bipolar, reusable
- Endoscopic electrosurgical electrode, bipolar, single-use, sterile
- Endoscopic electrosurgical handpiece/electrode, monopolar, reusable
- Endoscopic electrosurgical electrode, monopolar, single-use
- Endoscopic electrosurgical handpiece/electrode, bipolar, reusable
- Endoscopic electrosurgical handpiece/electrode, monopolar, reusable
- Endoscopic electrosurgical handpiece/electrode, monopolar, single-use
- General/multiple surgical diode Laser system
- Hysteroscopic irrigation/insufflation system
- Laparoscopic insufflator
- Laser lithotripsy system
- Operating room audiovisual data/device management system application software
- Piezoelectric lithotripsy system
- Soft-tissue/mesh anchor, non-bioabsorbable
- Ultrasonic lithotripsy system
- Electromechanical orthopaedic extracorporeal shock wave therapy system



Ruth Delbeck-Bayer
DEKRA Certification GmbH, Stuttgart, 2020-04-01
Notified Body ID-number: 0124

DEKRA Certification GmbH * Handwerkstraße 15 * D-70565 Stuttgart * www.dekra-certification.de

EC CERTIFICATE

for the Quality Assurance System



according the Directive 93/42/EEC, Annex V

As a Notified Body of the European Union, DEKRA Certification GmbH certifies, that the company
Richard Wolf GmbH

Pforzheimer Straße 32, 75438 Knittlingen, Germany

Certified location:

Pforzheimer Straße 32, 75438 Knittlingen, Germany

applies a quality assurance system according to the Directive 93/42/EEC Annex V for the medical devices listed in the annex. The approval is based on the result of the re-certification audit report no. 50593-Z7-00, the decision dated 2020-04-01 and is only valid in connection with the successful performance of the annual surveillance audits.

This certificate is valid from 2020-04-01 to 2024-05-26

Registration No.: 50593-17-04



Ruth Delbeck-Bayer
DEKRA Certification GmbH Stuttgart; 2020-04-01
Notified Body ID-number: 0124



Benannt durch/Designated by
Zentralstelle der Länder
für Gesundheitsschutz
bei Arzneimitteln und
Medizinprodukten
www.zlg.de
ZLG-BS-295.10.02

Annex to the EC Certificate No. 50593-17-04

Valid from 2020-04-01 to 2024-05-26

Revision status of the annex: 0 dated 2020-04-01

Devices/device categories included in the certificate:

Class I s:

For the products listed below, review of the Quality Assurance System refers exclusively to aspects of manufacture concerned with securing and maintaining sterile conditions.

- Endoscope inflation bulb
- Proctoscope, single-use
- Rectoscope, single-use



Ruth Delbeck-Bayer



DEKRA Certification GmbH, Stuttgart, 2020-04-01
Notified Body ID-number: 0124

DEKRA Certification GmbH * Handwerkstraße 15 * D-70565 Stuttgart * www.dekra-certification.de

Servo-i Ventilator Spare Parts List

Figure 3: Patient unit, Inspiratory section

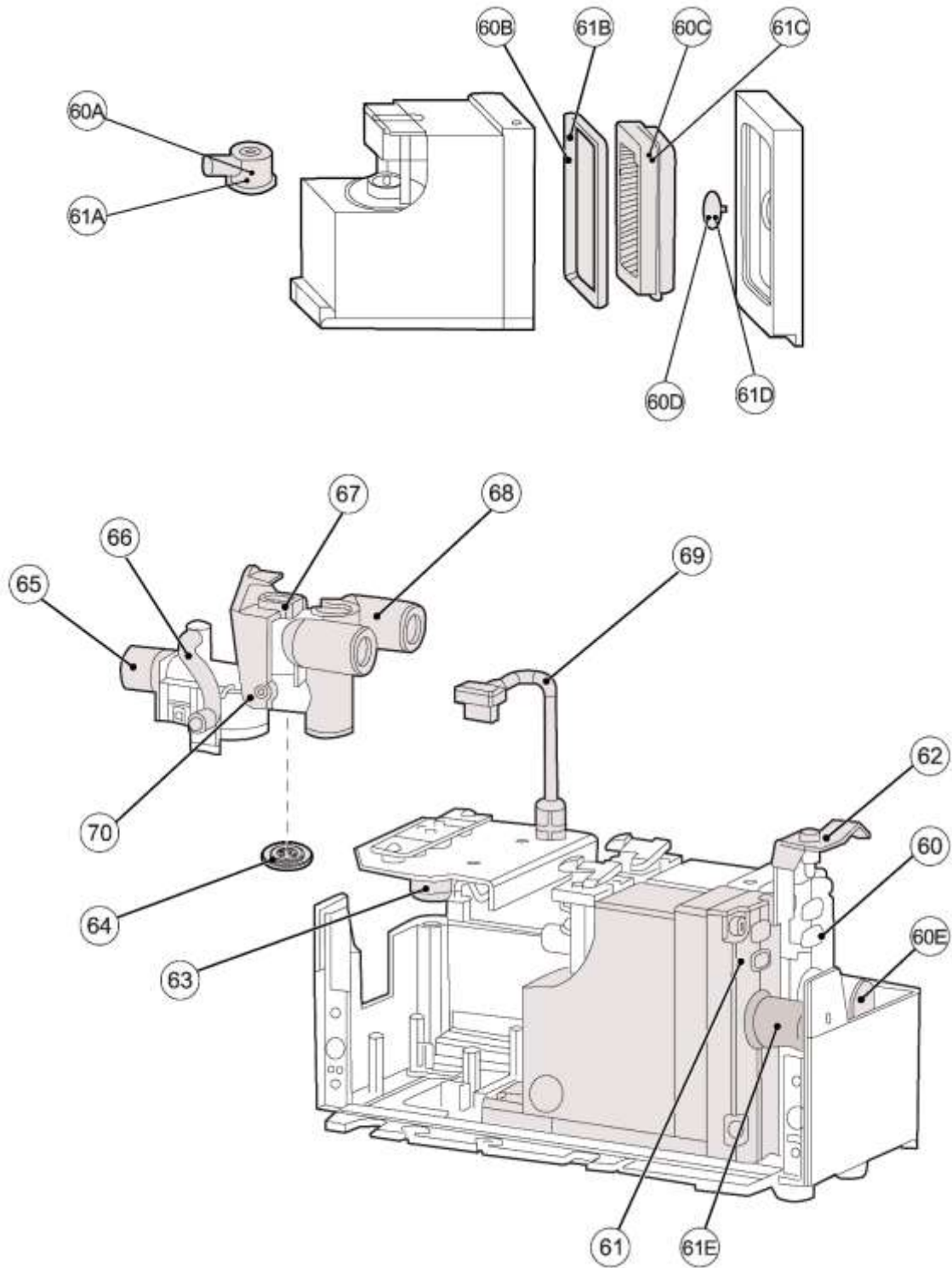

Servo-i Ventilator Spare Parts List

Table 3: Patient unit, Inspiratory section

ID	Part no.	Description	Comments
60	6671137	Gas module O2, Type III	
60A	6693792	Nozzle unit	
60B	6039528	Rubber seal for bacteria filter	
60C	6169416	Bacteria Filter for Gas Module	
60D	6169358	Non-return valve, 2 pcs	
60E	6532654	Module adapter O2, with O-rings	Fits only modules with 2 screws in end plate
61	6671135	Gas module Air, Type III	
61A	6693792	Nozzle unit	
61B	6039528	Rubber seal for bacteria filter	
61C	6169416	Bacteria Filter for Gas Module	
61D	6169358	Non-return valve, 2 pcs	
61E	6532647	Module adapter AIR, with O-rings	Fits only modules with 2 screws in the end plate
62	6488113	Module bracket	
63	6670330	Pull magnet incl. bracket	
64	9303892	Filter for O2 cell, 25 pcs	
65	6532662	Inspiratory pipe	
66	6532977	Tube	
67	6640044	O2 cell	
68	6448612	Connector muff	
69	6487958	Cable for O2 cell	
70	6888750	O2 cell holder	

Servo-i Ventilator Spare Parts List

Figure 4: Patient unit, Expiratory section

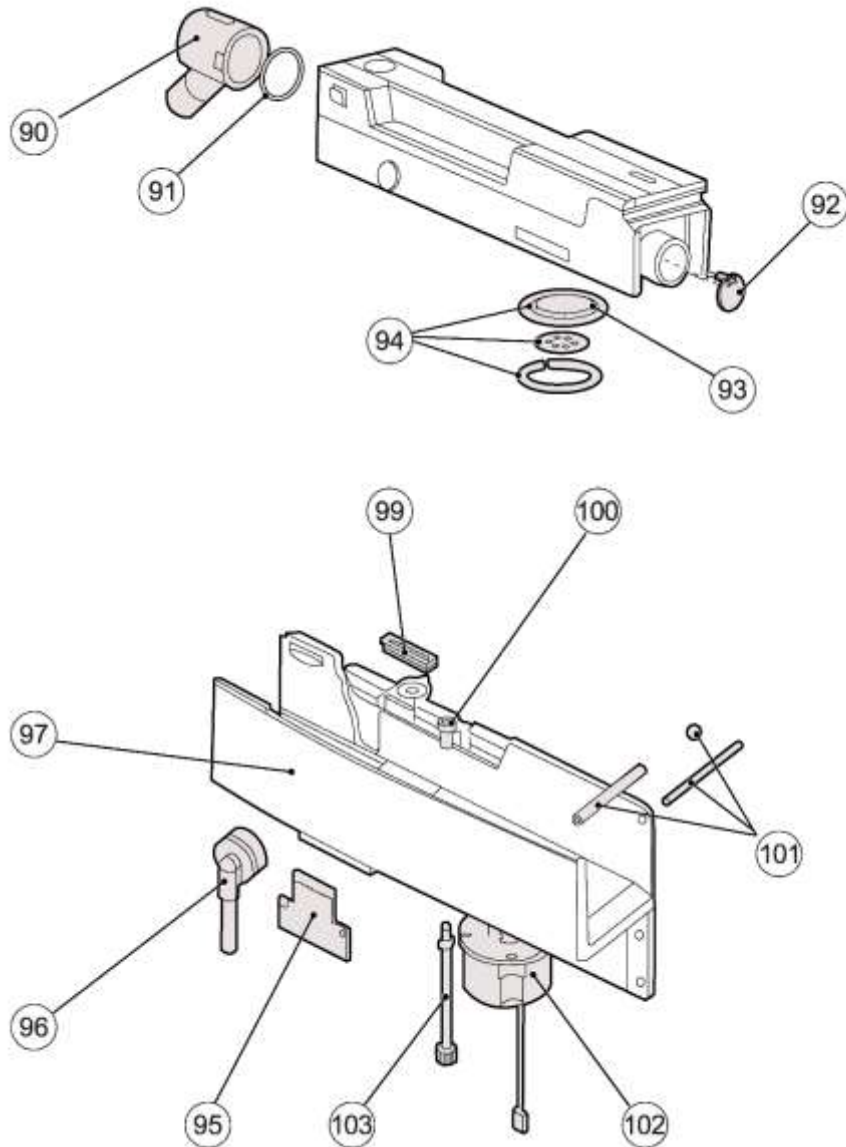

Servo-i Ventilator Spare Parts List

Table 4: Patient unit, Expiratory section

ID	Part no.	Description	Comments
90	6695105	Moisture trap	
91	9344144	O-ring 26.2x 3, 10 pcs	
92	6679572	Expiratory One-way valve, 10 pcs	
93	6670360	Membrane, 10 pcs	Include only membrane
94	6586791	Membrane with washer and ring, 1pcs	
95	6696972	Circuit board PC1785 incl. 6468016	
96	6449172	Filter holder	
97	6586775	Cassette Compartment	For S/N < 70000 Small colour difference from original detail
	6693432	Cassette Compartment, above S/N 70000	For S/N < 70000
99	6448166	Gasket	
100	6447895	Seal	
101	6586809	Locking pin	
102	6696975	Expiratory valve coil	
103	6533579	Expiratory pressure transducer tube	
104	6696947	Expiratory cassette incl. 6447960	Complete expiratory cassette Not shown in picture

Temperature monitoring system

Lot: 124

This item is included in the Vario Single and Vario Twin versions.



Quad temperature module (70101.0847)

* Maximum four temperatures.

This item is included in the Vario Single and Vario Twin versions.



Temperature probe box, 4 probe connections (70101.0848)

Includes:

- 1.3 meter connection cable.

To be mounted on the Temperature box hold or placed in the console rack.



Temperature box holder (70101.0849)

- For mast mounting.



Temperature Probe, oxygenator, adult (70101.7182)

Compatible with:

- Quadrox-i, Adult and Small Adult.
- Quadrox-iD, Adult.
- Quadrox-iR, Adult and Small Adult.
- Plegiox.



Temperature Probe, oxygenator, pediatric (70104.7770)

Compatible with:

- Quadrox-i, Pediatric and Neonatal.
- Quadrox-iD, Pediatric.

Air emboli protection

Level detection

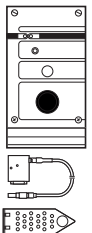

Level detection kit (70101.0854)

Kit includes:

- Air protection module for level sensor (to be placed in the console rack).
- Capacitive level sensor with cable 2 meter (70101.0855).
- Level sensor pad, 100 pieces (70102.2208).

Level and bubble detection

This item is included in the Vario Single and Vario Twin versions.

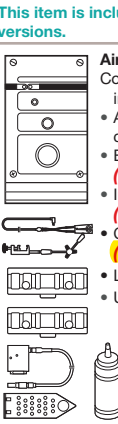

Air emboli protection system (70101.0853)

Complete system for level and bubble sensors includes:

- Air protection module (to be placed in the console rack).
- Bubble sensor complete with cable 2.1 meter (70101.0858).
- Insert (one pair) for 3/8" x 3/32" tubing (70101.0861).
- Capacitive level sensor with cable 2 meter (70101.0855).
- Level sensor pad, 100 pieces (70102.2208).
- Ultrasonic gel dispenser (70101.0859).

* Alternative inserts can be ordered separately (see below).

Bubble detection

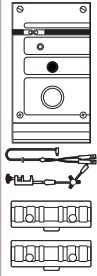

Bubble detection kit (70103.1541)

Kit includes:

- Air protection module (to be placed in the console rack).
- Bubble sensor complete with cable 2.1 meter (70101.0858).
- Insert (one pair) for 3/8" x 3/32" tubing (70101.0861).
- Ultrasonic gel dispenser (70101.0859).

* Alternative inserts can be ordered separately (see below).

Extra sensor pads



Level sensor pad, 100 pcs (70102.2208)

Disposable level sensor pad, quantity 100.

- To be surface mounted on the reservoir at the level of supervision.

Inserts



Bubble sensor insert (one pair)

- For 1/4" x 1/16" tubing (70101.0864)
- For 1/4" x 3/32" tubing (70101.0865)
- For 3/8" x 1/16" tubing (70101.0860)
- For 3/8" x 3/32" tubing * (70101.0861)
- For 1/2" x 1/16" tubing (70103.4514)
- For 1/2" x 3/32" tubing (70101.0863)

* Included in Bubble detection kit (70103.1541) and Air emboli protection system (70101.0853).

Extra gel



Ultrasonic gel dispenser (70101.0859)

- Gel to improve the sensitivity of the bubble sensor.

ENDOCAM Logic 4K Lenses

RIWO lens with snap-on mechanism and C-Mount thread, steam-sterilizable and reprocessable by machine

Product no.



AUTOCLAVE
134° C / 273° F

RIWO lens F 14mm
f = 14 mm

85261144

RIWO lens F 24mm
f = 24 mm

85261244

RIWO zoom lens with snap-on mechanism and C-Mount thread, steam-sterilizable and reprocessable by machine



AUTOCLAVE
134° C / 273° F

RIWO zoom lens F 13-29mm
f = 13-29 mm

85261504

RIWO angular lens with rotatable snap-on mechanism and C-Mount thread, suspension function, suitable for reprocessing by machine and low-temperature procedure



RIWO angled lens F 14mm
f = 14 mm

5257141

RIWO angled lens F 17mm
f = 17 mm

5257171

ENDOCAM Logic HD Camera controller

ENDOCAM
1



- Various equipment variants. The variants exclusively refer to the configuration of output and input signals
- Digital signal processing
- Outstandingly wide range of application due to integration of various applied parts and diagnostic methods
- updates can be applied at any time via USB port
- Storage of high-resolution images and HD videos on USB storage media
- Integration of further image signals via picture-in-picture port (3G-SDI)
- Specialized for use in integrated operating rooms as a central **core nova module**

- User-friendly. Clinically-devised presets are pre-programmed for various disciplines. This includes applications using standard and fiber endoscopes as well as sensor endoscopes with chip-on-the-tip technology. Personal settings can easily be saved as well
- Maximum flexibility: The resolution of all signal outputs can be adapted individually to the connected system
- Patient data can be entered using the connected USB keyboard
- Direct printing possible
- Modern, clearly arranged on-screen menu
- Dialog function:
 1. Control of connected ENDOLIGHT light source for optimum illumination with maximum protection for the endoscope
 2. Monitor display of major device parameters for further devices (pressure indication, set flow, residual gas display, etc.)

ENDOCAM Logic HD controller bndl

Comprising:

1x ENDOCAM Logic HD controller	552510x
1x hand-held remote control USB	5525401
1x USB flash memory 8 GB	56540028
1x CAN-BUS terminator	5590.989
1x HDMI / DVI-D cable, lockable, 3.0 m	103843
1x power cable	2440.03

Controller equipment variants:

2x HDMI out	55251011
2x HDMI out / 2x 3G-SDI out	55251051
2x HDMI out / 2x 3G-SDI out / PIP in	55251061
2x HDMI out / 2x 3G-SDI out / analog out.....	55251071
2x HDMI out / 2x 3G-SDI out / PIP in / analog out	55251081

ENDOCAM Logic HD

Technical data of camera controller

ENDOCAM
1

Camera controller		552510x		
Device properties				
Type of controls	Touchscreen			
Max. video signal resolution	1920 x 1200 pixels			
White balance, color temperature range	2300 K to 7000 K			
Noise level	34 dB to 48 dB max.			
Digital zoom	1.5x max.			
Individually configurable profiles	at least 5 profiles			
Brightness control	Automatic shutter control + automatic gain control			
Image format of saved pictures / videos	JPEG, TIFF (max. 1920 x 1080) / MPEG4 (max. 1920 x 1080)			
Operating conditions	+10°C to +40°C, 30% to 75% rel. humidity, atmospheric pressure 700 hPa to 1060 hPa			
Operating mode	Continuous operation			
Equipment				
IP rating	IP20			
Cooling method	Controlled fan			
Power supply				
Mains + frequency	100-240 VAC, 50/60 Hz			
Power consumption	100 VA			
Current rating	max. 1.0 A			
Regulatory standards				
Safety	US/ CA: UL 2601-1 / CSA C22.2 NO.601.1, EU: EN 60601			
EMC	EN 60601-1-2 / IEC 601-1-2			
Medical device class	Class 1			
Classification of applied part	CF			
Interfaces				
Video outputs	2x 3G-SDI, 2x HDMI, 1x YC, 1x CV			
PiP input	1x 3G-HD-SDI			
Remote output	2 x 3.5 mm jack, stereo			
USB port (on front panel, for external storage media)	USB 2.0 (FAT32/NTFS formatting)			
Resolution (HDMI output)	Adjustable in the user menu 1280 x 1024/60P (5:4) 1920 x 1080/60P (16:9) 1920 x 1200/60P (16:10)			
Resolution (3G-SDI output) also supports HD-SDI	Adjustable in the user menu 1280 x 720/50P (16:9) 1920 x 1080/50I (16:9) 1920 x 1080/50P (16:9) 1280 x 720/60P (16:9) 1920 x 1080/60I (16:9) 1920 x 1080/60P (16:9)			
Resolution of SD outputs for video (Composite) and S-Video (Y/C)	Adjustable in the user menu PAL 720 x 576/50I (4:3) NTSC 720 x 486/59.94I (4:3)			
Resolution of picture-in-picture input (3G-SDI)	1280 x 720/50P (16:9) 1920 x 1080/50I (16:9) 1920 x 1080/50P (16:9) 1280 x 720/60P (16:9) 1920 x 1080/60I (16:9) 1920 x 1080/60P (16:9)			
Dimensions and weights				
Weight	6.2 kg			
Dimensions (W x H x D)	300 x 120 x 416 mm			

VIII23 || Subject to modifications. Please note that some products may not be available in all countries. Please always take note of the information that is provided with the product. For more detailed information, please consult with your contact partner or directly with Richard Wolf GmbH.

ENDOCAM Logic HD 3-chip HD camera head

ENDOCAM
1



- Digital image processing and digital signal transmission
- 2 programmable camera head buttons with 4 available functions
- Universal C-Mount lens connection
- Cable outlet angled at 30°
- Camera head cable can be replaced in the hospital by technicians
- Steam-sterilizable
- Can be reprocessed by machine
- Suitable for low-temperature procedure

ENDOCAM Logic HD camera head **85525922**

3-chip type, cable length 3 m

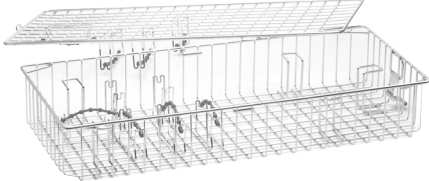





Recommended accessories	Product no.	
RIWO lens	C-Mount, f = 14 mm	85261144
	C-Mount, f = 24 mm	85261244
RIWO zoom lens	C-Mount, f = 13 - 29 mm	85261504
	Perforated basket for camera head (L x W x H) 448 x 200 x 73 mm	38002

VIII23 || Subject to modifications. Please note that some products may not be available in all countries. Please always take note of the information that is provided with the product. For more detailed information, please consult with your contact partner or directly with Richard Wolf GmbH.

TROCAR SLEEVES 5.5 MM

TROCAR SLEEVES

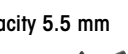
3

RIWO-ART trocar sleeves with magnetic ball valve 				Tip tapered/blunt	Tip tapered/ pointed	Tip triangular	
				Trocar tip blunt Size 5.5 mm	Trocar tip pointed Size 5.5 mm	Trocar tip triangular Size 5.5 mm	
Stainless steel sheath tube		WL	Capacity	Product no.	WL 129 mm	WL 129 mm	WL 129 mm
Trocar sleeve straight capacity 5.5 mm WL 60 mm smooth 		60 mm	5.5 mm	8921.052	8921.101	8921.111	8921.121
Trocar sleeve slanted capacity 5.5 mm WL 60 mm smooth 		60 mm	5.5 mm	8921.051	8921.101	8921.111	8921.121
Trocar sleeve straight capacity 5.5 mm WL 60 mm with thread 		60 mm	5.5 mm	8921.062	8921.101	8921.111	8921.121
Trocar sleeve slanted capacity 5.5 mm WL 60 mm with thread 		60 mm	5.5 mm	8921.061	8921.101	8921.111	8921.121
Plastic tube Trocar sleeve straight capacity 5.5 mm WL 60 mm with thread 		60 mm	5.5 mm	8921.072	8921.101	8921.111	8921.121
					WL 169 mm	WL 169 mm	WL 169 mm
Trocar sleeve straight capacity 5.5 mm WL 100 mm smooth 		100 mm	5.5 mm	8921.054	8921.103	8921.113	8921.123
Trocar sleeve straight capacity 5.5 mm WL 100 mm with thread 		100 mm	5.5 mm	8921.053	8921.103	8921.113	8921.123







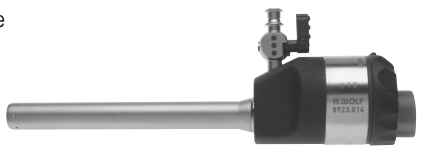

Accessories	Product no.
Spare ball capacity 5.5 mm	8921.901
Spare O rings capacity 3.5 mm (PACK= 10 PCS), capacity Ø 3.5–5.5 mm	8921.951
Sealing cap capacity 3.4–5.1 mm (PACK= 10 PCS) blue	89.02

III23 || Subject to modifications. Please note that some products may not be available in all countries. Please always take note of the information that is provided with the product. For more detailed information, please consult with your contact partner or directly with Richard Wolf GmbH.

TROCAR SLEEVE 10 MM WITH INSUFFLATION STOPCOCK

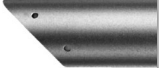
TROCAR SLEEVES

3

RIWO-ART trocar sleeves with magnetic ball valve 				Tip tapered/blunt 	Tip tapered/pointed 	Tip triangular 	
				Trocar tip blunt Size 10 mm	Trocar tip pointed Size 10 mm	Trocar tip triangular Size 10 mm	
Stainless steel sheath tube		WL	Capacity	Product no.	WL 164 mm	WL 164 mm	WL 164 mm
Trocar sleeve straight capacity 10 mm WL 100 mm 	100 mm	10 mm	8923.014	8923.103	8923.113	8923.123	
Trocar sleeve slanted capacity 10 mm WL 100 mm 	100 mm	10 mm	8923.013	8923.103	8923.113	8923.123	
Trocar sleeve straight capacity 10 mm WL 100 mm with thread 	100 mm	10 mm	8923.024	8923.103	8923.113	8923.123	
Trocar sleeve slanted capacity 10 mm WL 100 mm with thread 	100 mm	10 mm	8923.023	8923.103	8923.113	8923.123	
					WL 214 mm	WL 214 mm	WL 214 mm
Trocar sleeve straight capacity 10 mm WL 150 mm 	150 mm	10 mm	8923.016	-	8923.115	8923.125	
Trocar sleeve straight capacity 10 mm WL 150 mm with thread 	150 mm	10 mm	8923.026	-	8923.115	8923.125	

Accessories	Product no.
Spare ball capacity 7 mm	8923901
Spare O rings capacity 7 mm (PACK= 10 PCS), capacity Ø 7–12.5 mm	8923951
Sealing cap capacity 9.5–10.1 mm (PACK= 10 PCS) red	8908
Stopcock insert bndl cap. 3.0 mm (PACK= 5 PCS)	896.0002

III23 || Subject to modifications. Please note that some products may not be available in all countries. Please always take note of the information that is provided with the product. For more detailed information, please consult with your contact partner or directly with Richard Wolf GmbH.

INSUFFLATOR HIGHFLOW 45 BASIC











		Product no.
Insufflator 45 BASIC bndI consisting of: Insufflator 45 BASIC FR 45 l/min (2235001), Insufflation tube set L 2.5 m (8170.101), Hygiene filter, sterile, disposable (PACK= 10 PCS) (4171.111) and power cable 3 m long (2440.03)		22350011
Accessories: Tube sets for insufflation		
Insufflation tube set L 2.5 m, High Flow, D = 8 mm, autoclavable		8170.232
Insufflation tube set L 2.5 m, autoclavable		8170.101
Insufflation tube set L 2.7 m, with integrated hygiene filter, disposable, (PACK= 10 PCS) in individual sterile packaging		4170.501
Hygiene filter, sterile, disposable (PACK= 10 PCS) in individual sterile packaging		4171.111
Accessories for gas supply		
CO ₂ connection tube 1.5 m NIST-NIST		74021038
with		
Pressure reducer for CO ₂ connector DIN 477-1	DIN 477-1	74007054
Pressure reducer for CO ₂ connector DIN EN ISO 407	DIN EN ISO 407	74007055
Pressure reducer for CO ₂ connector ISO 5145	ISO 5145	74007056
or		
Connection tube for CO ₂ 5.0 m DIN for centralized CO ₂ gas supply (Dräger)		74021039
Connection tube for CO ₂ 5.0 m NF for centralized CO ₂ gas supply (Liquid Air)		74021040
Software modules (optional)		
Software module CAN bus CAN bus interface for integration in CORE		2235101
Software module BABY MODE BABY MODE for special use in pediatrics		2235102
Software module VIDEO DISPLAY: video display using DIALOG via CAN bus		2235103

Electrodes

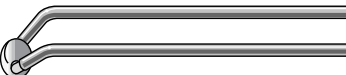
For Resectoscopes, 4 mm

25° & 12° Endoscopes

For sheath		22 Fr.	24 Fr.	26 Fr.	28 Fr.
For continuous-irrigation sheath		25 Fr.	27 Fr.	28.9 Fr.	
Cutting electrode (0.3 mm wire)  Sterile, 10/box	Branches	blue	green	white	—
	Type	8422.1310	8424.1310	8426.1320*	N/A
	Stem	red	red	red	—
Cutting electrode (0.35 or 0.4 mm wire)  Sterile, 10/box	Branches	blue	green	white	yellow
	Type	8422.3510	8424.1410	8426.1420*	8428.3510*
	Stem	red	blue	blue	blue
Straight cutting electrode  Sterile, 5/box	Branches	blue		white	
	Type	8423.0405		8427.0425*	
	Stem	blue		blue	
Roller bar coagulating electrode  Sterile, 5/box	Branches	blue		white	
	Type	8423.0205		8427.0225*	
	Stem	red		red	
Large roller egg electrode  Sterile, 5/box	Branches	blue		blue	
	Type	8423.0235		8423.0235	
	Stem	blue		blue	
Smaller roller ball electrode  Sterile, 5/box	Branches	blue		blue	
	Type	8422.4355		8422.4355	
	Stem	red		red	
Coagulating electrode  Sterile, 5/box	Branches	blue		white	
	Type	8423.0105		8427.0125*	
	Stem	blue		blue	
Hook electrode  Sterile, 5/box	Branches	blue		white	
	Type	8423.0905		8427.0925*	
	Stem	red		red	
Collins knife electrode  Sterile, 5/box	Branches	blue		white	
	Type	8423.1905		8427.1925*	
	Stem	red		red	

*Electrode with guide fins for better stabilization.





Bipolare Electrodes

for multiple use
12°/30°



Bipolare Elektroden

zum Mehrfachgebrauch
12°/30°

für Dauerspül-Schaft for continuous-irrigation sheath	Bügel Loop	Stiel Stem	Für Schaftgrößen in Charr. / for sheath sizes in Fr.			
			DS 22/24	iS 24	DS 24/26	iS 26
Schneide-Elektrode Cutting electrode 	Schlinge Loop 0.3 mm	Gabel Branches	blau / blue	blau / blue	blau / blue	blau / blue
			8622133	8622131	8622131	8622131
Koagulations-Elektrode Coagulating electrode 	Zylinder Cylinder 1.2 mm	Gabel Branches	blau / blue	blau / blue	blau / blue	blau / blue
			8623022	8623022	8623022	8623022
Haken-Elektrode Hook electrode 	Haken Hook	Gabel Branches	blau / blue	blau / blue	blau / blue	blau / blue
			862309	862309	862309	862309
		Stiel Stem	gelb / yellow	gelb / yellow	gelb / yellow	gelb / yellow
			862309	862309	862309	862309
		Stiel Stem	gelb / yellow	gelb / yellow	gelb / yellow	gelb / yellow
			862309	862309	862309	862309

DS = Dauerspülung / Continuous irrigation

iS = intermittierende Spülung / intermittent irrigation

7



AUTOCLAVE
134° C / 273° F

Protective Sterilization Sleeve for a maximum of 5 resection or vaporisation electrodes or urethrotome knives, outer Ø 20 mm, length 328 mm 8428.901

Sterilisations-Schutzhülse zur Aufnahme von max. 5 Resektions- oder Vaporisations-Elektroden oder Urethrotommesser, Außen-Ø 20 mm, Länge 328 mm 8428.901