



GIMA

PROFESSIONAL MEDICAL PRODUCTS

**MATERASSINO AD ARIA AD ELEMENTI INTERCAMBIABILI
INTERCHANGEABLE CELL AIR MATTRESS
MATELAS PNEUMATIQUE À AIR À ÉLÉMENTS INTERCHANGEABLES
LUFTBLASEN-MATTE MIT AUSWECHSELBAREN ZELLEN
COLCHÓN DE AIRE CON ELEMENTOS INTERCAMBIABLES
COLCHÃO DE AR COM ELEMENTOS TROCÁVEIS
ΜΙΚΡΟ ΣΤΡΩΜΑ ΑΕΡΑ ΚΑΙ ΑΝΤΑΛΛΑΞΙΜΑ ΣΤΟΙΧΕΙΑ
MATERACYK POWIETRZNY Z WYMIENNYMI ELEMENTAMI
CSERÉLHETŐ ELEMES LEVEGŐS MATRAC**

فرش هوائي بعناصر قابلة للتبديل والتغيير

È necessario segnalare qualsiasi incidente grave verificatosi in relazione al dispositivo medico da noi fornito al fabbricante e all'autorità competente dello Stato membro in cui si ha sede.

All serious accidents concerning the medical device supplied by us must be reported to the manufacturer and competent authority of the member state where your registered office is located.

Il est nécessaire de signaler tout accident grave survenu et lié au dispositif médical que nous avons livré au fabricant et à l'autorité compétente de l'état membre où on a le siège social.

Jeder schwere Unfall im Zusammenhang mit dem von uns gelieferten medizinischen Gerät muss unbedingt dem Hersteller und der zuständigen Behörde des Mitgliedsstaats, in dem das Gerät verwendet wird, gemeldet werden.

Es necesario informar al fabricante y a la autoridad competente del Estado miembro en el que se encuentra la sede sobre cualquier incidente grave que haya ocurrido en relación con el producto sanitario que le hemos suministrado.

É necessário notificar ao fabricante e às autoridades competentes do Estado-membro onde ele está sediado qualquer acidente grave verificado em relação ao dispositivo médico fornecido por nós.

Σε περίπτωση που διαπιστώσετε οποιοδήποτε σοβαρό περιστατικό σε σχέση με την ιατρική συσκευή που σας παρέχουμε θα πρέπει να το αναφέρετε στον κατασκευαστή και στην αρμόδια αρχή του κράτους μέλους στο οποίο βρίσκεστε.

Należy poinformować producenta i kompetentne władze danego Kraju członkowskiego o każdym poważnym wypadku związanym z wyrobem medycznym naszej produkcji.

A gyártónak, illetve a székhely szerinti tagállam illetékes hatóságának jelezni kell bármilyen olyan súlyos balesetet, amely az általunk szállított orvostechnikai eszközzel kapcsolatban történt.

يجب الإبلاغ فوراً عن أي حادث خطير وقع فيما يتعلق بالجهاز الطبي الذي زودنا به إلى الجهة الصانعة والسلطة المختصة في الدولة العضو التي يقع فيها.

REF

QDC-303 (GIMA 28564)

REF

P4000IIE (B) (GIMA 28565)

REF

QDC-303+P4000IIE (B) (GIMA 28566)



Guangdong Yuehua Medical Instrument Factory Co., Ltd.
Rongsheng Science and Technology Zone,
Daxue Road, Shantou, Guangdong, China
Made in China

EC

REP

SUNGO Europe B.V.
Fascinatio Boulevard 522, Unit 1.7, 2909VA Capelle aan den IJssel, The Netherlands



Gima S.p.A
Via Marconi, 1 - 20060 Gessate (MI) - Italy
gima@gimaitaly.com - export@gimaitaly.com
www.gimaitaly.com



Ganci
Hooks
Crochets
Haken
Ganchos
Ganchos
άγκιστρα
haki
Kampó
هوكس

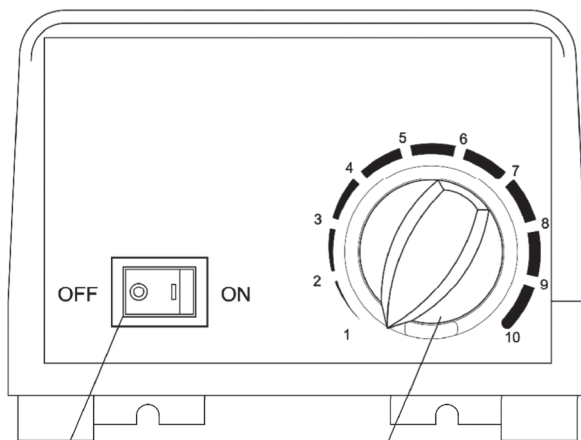

Alimentazione
Power
Courant
Strom
Corriente
Alimentação
Ρεύμα
Prąd
Áram
تيار

Manopola regolazione pressione
Pressure adjustment dial
Bouton de réglage de la pression
Luftdruckgriff
Manivela de regulación de la presión
Punho de regulação da pressão
Λαβή ρύθμισης της πίεσης
Gałka regulacji ciśnienia powietrza
Nyomást szabályozó kezelőgomb
مفتاح ضبط الضغط

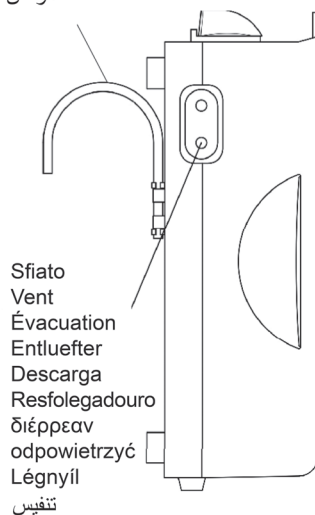

Sfiato
Vent
Évacuation
Entlüfter
Descarga
Resfolegadouro
διέρευαν
odpowietrzyć
Légnyíl
تنفيس

Schema elettrico
Circuit diagram
Schéma électrique
Stromlaufplan
Esquema eléctrico
Esquema elétrico
Ηλεκτρικό διάγραμμα
Schemat elektryczny
Elektromos kapcsolási rajz

التخطيط الكهربائي

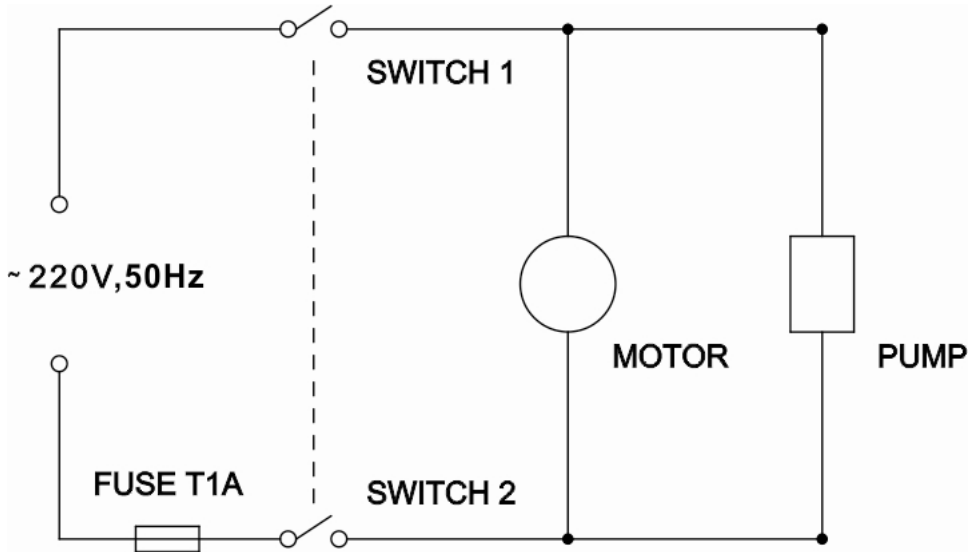

**Brief**

The BUBBLE MATTRESS consists of two parts: the mattress and the pump. The pump utilizes a small compressor to remain quiet and energy efficient. The control panel is simple and very user friendly. The mattress relieves pressure by sequentially deflating and inflating alternate air cells on approximately 6 minutes timed intervals. It is widely recognized that constant pressure to a bony prominence is the leading cause of skin breakdown. The continuous movement supplied by the unit lessens the areas of constant pressure and enhances circulation.

Operation

1. Place the mattress on the bed frame with the hose end at the foot section of the bed frame.
2. Using the integrated hooks, securely hang the pump on the bed end at the foot end or place on a smooth flat surface.
3. Connect the air hoses from the mattress to the pump.
4. Plug the pump into a wall outlet. Be sure the power cord is safely away from possible hazards.
5. Turn on the power switch on the control panel of the pump. The pump will begin to inflate the mattress.
6. After inflation, adjust the mattress using the dial on the pump.

Caution

1. *Do not smoke on or near the pump.*
2. *Keep the pump away from heated surfaces.*
3. *Explosion risk if used in the presence of flammable anesthetics.*
4. *Replace fuse as marked: T1A 250V. Power Input: ~ 220V 50Hz, 0.1A*

Product Specifications

DIMENSIONS	
MATTRESS (Length x Width x Height)	77"×35"×3" (200cm×90cm×7cm)
Extension Flaps	20"(50cm) For both sides
PUMP (Length x Width x Height)	10"×5"×4" (25cm×12cm×10cm)
WEIGHT OF PRODUCT	
MATTRESS WEIGHT	5 lbs (2.3kg)
PUMP WEIGHT	3 lbs (1.4kg)
WEIGHT CAPACITY	
MAXIMUM PATIENT WEIGHT	135kg
ELECTRICAL	
OPERATING POWER	~ 220V 50Hz, 0.1A MAX
FUSES	T1A 250V
ENVIRONMENTAL CONDITIONS	
OPERATING CONDITIONS	
Ambient Temperature	10°C to 40°C (50°F to 104°F)
Relative Humidity	10% to 75%
STORAGE AND SHIPPING CONDITIONS	
Ambient Temperature	-18°C to +43°C (0°F to 110°F)
Relative Humidity	10% to 95%













Cleaning instruction

Mattress

Clean the mattress regularly with neutral detergent or alcohol. Heating or steam sterilization is not available.

Pump

Clean the pump regularly with neutral detergent or alcohol. Do not open the pump housing – risk of electric shock. Do not get the pump wet or submerge it in any liquid.

	Keep in a cool, dry place		Keep away from sunlight		Temperature limit
	WEEE disposal		Manufacturer		Humidity limit
	Follow instructions for use		Type BF applied part		Consult instructions for use
REF	Product code	LOT	Lot number	SN	Serial number
	Caution: read instructions (warnings) carefully	CE	Medical Device compliant with Regulation (EU) 2017/745	MD	Medical Device
	Class II applied	EC REP	Authorized representative in the European community		Date of manufacture
	Importer				



Disposal: *The product must not be disposed of along with other domestic waste. The users must dispose of this equipment by bringing it to a specific recycling point for electric and electronic equipment.*

GIMA WARRANTY TERMS

The Gima 12-month standard B2B warranty applies.