

ALLGEMEINCHIRURGIE
GENERAL SURGERY
CIRUGÍA GENERAL
CHIRURGIA GENERALE



Reda Instrumente GmbH
Gänsäcker 34 · P.O. Box 131
D-78532 Tuttlingen

Telefon +49 / 74 62 / 94 45-0
Telefax +49 / 74 62 / 94 45-20
E-mail: info@Reda-Instrumente.de
<http://www.Reda-Instrumente.de>

Ausgabe Nr. 8
Datum: 06/2022



Charrière (Ch) French (F)	Durchmesser in mm	Inches
1	0,33	0,013
2	0,67	0,025
3	1,00	0,039
4	1,33	0,051
5	1,67	0,065
6	2,00	0,0787
7	2,33	0,092
8	2,67	0,105
9	3,00	0,1181
10	3,33	0,131
11	3,67	0,144
12	4,00	0,1575
13	4,33	0,170
14	4,67	0,184
15	5,00	0,1968
16	5,33	0,210
17	5,67	0,223
18	6,00	0,2362
19	6,33	0,249
20	6,67	0,263
21	7,00	0,2756
22	7,33	0,288
23	7,67	0,302
24	8,00	0,3150
25	8,33	0,328
26	8,67	0,341
27	9,00	0,3543
28	9,33	0,367
29	9,67	0,380
30	10,00	0,3973
31	10,33	0,407
32	10,67	0,420
34	11,33	0,446
36	12,00	0,4724
38	12,67	0,494
40	13,33	0,5199
45	15,00	0,5905

Gauge (G)	Durchmesser in mm	Inches
35	0,13	0,005
34	0,18	0,007
33	0,20	0,008
32	0,23	0,009
31	0,25	0,010
30	0,30	0,012
29	0,33	0,013
28	0,36	0,014
27	0,41	0,016
26	0,46	0,018
25	0,51	0,020
	0,53	0,021
24	0,56	0,022
23	0,64	0,025
22	0,71	0,028
21	0,81	0,032
20	0,89	0,035
	0,97	0,038
19	1,07	0,042
18	1,27	0,050
17	1,50	0,059
16	1,65	0,065
15	1,83	0,072
14	2,11	0,083
13	2,41	0,095
12	2,77	0,109
11	3,05	0,120
10	3,40	0,134
9	3,76	0,148
8	4,19	0,165
7	4,57	0,180
6	5,16	0,203

1 OZ	0,028 ml
5 OZ	0,140 ml
16 OZ	0,450 ml

35 OZ	1,0 l
128 OZ	3,7 l

GARANTIE / WARRANTY / GARANTIA / GARANZIA

GARANTIE

Wir gewähren auf alle **Reda**-Instrumente 5 Jahre Garantie. Voraussetzung ist der sach- und fachgerechte Einsatz der Instrumente. Von der Garantie sind Verschleißerscheinungen ausgeschlossen.

WARRANTY

Our **Reda** products are free from manufacturing defects in material and workmanship. We therefore give on all instruments a guarantee of five years provided that the instruments are maintained and cleaned properly and used normally for their intended purpose.

GARANTIA

Estamos convencidos de nuestra calidad y concedemos a todos los instrumentos de **Reda** 5 años de garantía contra cualquier defecto de fabricación, siempre y cuando se usen adecuadamente. De la garantía excluimos la manifestación de desgaste.

GARANZIA

Siamo convinti della nostra qualità e concediamo cinque anni di garanzia sulla funzione dei tutti gli strumenti **Reda** sotto la presupposizione che l'utilizzo è da esperto. Escluso della garanzia sono tracce di consumo.

Kathetereinführzangen, Saugrohre
 Catheter Introducing Forceps, Suction tubes
 Pinzas para catéteres, Tubos de aspiración
 Pinze per introdurre le sonde, Cannule per aspirazione

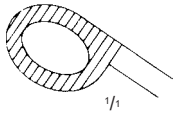

05190-25
 25 cm, 10"

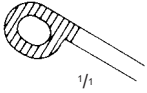

05190-20
 20 cm, 8"



05190-17
 17 cm, 6 3/4"

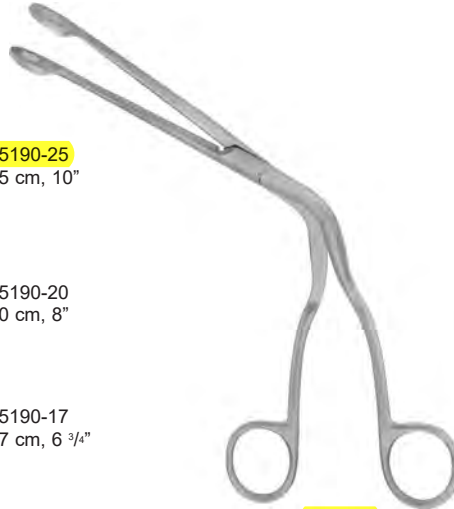

MAGILL



ANDREW-PYNCHON
 05170-24
 6 mm \varnothing , 1/2"
 24 cm, 9 1/2"



COOLEY
 05160-02
 8 mm \varnothing , 0.3"
 36 cm, 14 1/4"



COOLEY
 05160-03
 8 mm \varnothing , 0.3"
 30 cm, 11 3/4"



DE BAKEY
 05160-04
 3 mm \varnothing , 0.1"
 27 cm, 10 1/2"

\varnothing 15 mm



\varnothing 9 - 13 mm

FINSTERER
 05180-32
 32 cm, 12 3/4"

Chirurgische Scheren
 Operating Scissors
 Tijeras para cirugía
 Forbici per chirurgia



STANDARD
 09102-11 11,5 cm, 4½"
 09102-13 13,0 cm, 5"
 09102-14 14,5 cm, 5¾"
09104-14 TC
 09102-15 15,5 cm, 6"
 09102-16 16,5 cm, 6½"
 09102-18 18,5 cm, 7¼"
 09102-20 20,0 cm, 8"



STANDARD
 09110-11 11,5 cm, 4½"
 09110-13 13,0 cm, 5"
09110-14 14,5 cm, 5¾"
09114-14 TC
 09110-15 15,5 cm, 6"
 09110-16 16,5 cm, 6½"
09110-18 18,5 cm, 7¼"
 09110-20 20,0 cm, 8"



STANDARD
 09120-11 11,5 cm, 4½"
 09120-13 13,0 cm, 5"
 09120-14 14,5 cm, 5¾"
09124-14 TC
 09120-15 15,5 cm, 6"
 09120-16 16,5 cm, 6½"
 09120-18 18,5 cm, 7¼"
09120-20 20,0 cm, 8"



STANDARD
 09103-11 11,5 cm, 4½"
 09103-13 13,0 cm, 5"
 09103-14 14,5 cm, 5¾"
09105-14 TC
 09103-15 15,5 cm, 6"
 09103-16 16,5 cm, 6½"
 09103-18 18,5 cm, 7¼"
 09103-20 20,0 cm, 8"



STANDARD
 09111-11 11,5 cm, 4½"
 09111-13 13,0 cm, 5"
 09111-14 14,5 cm, 5¾"
09115-14 TC
 09111-15 15,5 cm, 6"
 09111-16 16,5 cm, 6½"
 09111-18 18,5 cm, 7¼"
 09111-20 20,0 cm, 8"



STANDARD
 09121-11 11,5 cm, 4½"
 09121-13 13,0 cm, 5"
 09121-14 14,5 cm, 5¾"
09125-14 TC
 09121-15 15,5 cm, 6"
 09121-16 16,5 cm, 6½"
 09121-18 18,5 cm, 7¼"
 09121-20 20,0 cm, 8"

Präparierscheren
 Dissecting Scissors
 Tijeras de disección
 Forbici per dissezione

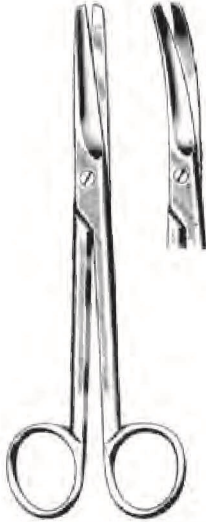

MAYO		
09160-14	14,5 cm, 5 $\frac{3}{4}$ "	09161-14
09164-14	14,5 cm, 5$\frac{3}{4}$"	09165-14
09164-14 TC	14,5 cm, 5 $\frac{3}{4}$ "	09165-14 TC
09160-15	15,0 cm, 6"	09161-15
09160-17	17,0 cm, 6 $\frac{3}{4}$ "	09161-17
09164-17	17,0 cm, 6$\frac{3}{4}$"	09165-17
09164-17 TC	17,0 cm, 6 $\frac{3}{4}$ "	09165-17 TC
09160-19	19,0 cm, 7 $\frac{1}{2}$ "	09161-19
09160-23	23,0 cm, 9"	09161-23
09164-23	23,0 cm, 9"	09165-23
09164-23 TC	23,0 cm, 9"	09165-23 TC
09160-28	28,0 cm, 11"	09161-28



MAYO-STILLE		
09170-15	15,0 cm, 6"	09171-15
09174-15	15,0 cm, 6"	09175-15
09174-15 TC	15,0 cm, 6"	09175-15 TC
09170-17	17,0 cm, 6$\frac{3}{4}$"	09171-17
09174-17	17,0 cm, 6 $\frac{3}{4}$ "	09175-17
09174-17 TC	17,0 cm, 6 $\frac{3}{4}$ "	09175-17 TC
09170-21	21,0 cm, 8 $\frac{1}{4}$ "	09171-21
09174-21	21,0 cm, 8 $\frac{1}{4}$ "	09175-21
09174-21 TC	21,0 cm, 8 $\frac{1}{4}$ "	09175-21 TC



MAYO-NOBLE

09180-17 17,0 cm, 6 $\frac{3}{4}$ " 09181-17

Präparierscheren
Dissecting Scissors
Tijeras de disección
Forbici per dissezione



METZENBAUM

09280-12	09284-12 TC
12 cm, 4¾"	
09280-15	09284-15 TC
15 cm, 6"	
09280-18	09284-18 TC
18 cm, 7"	
09280-20	09284-20 TC
20 cm, 8"	
09280-23	09284-23 TC
23 cm, 9"	
09280-25	09284-25 TC
25 cm, 10"	
09280-28	09284-28 TC
28 cm, 11"	
09280-30	09284-30 TC
30 cm, 12"	



METZENBAUM

09281-12	09285-12 TC
12 cm, 4¾"	
09281-15	09285-15 TC
15 cm, 6"	
09281-18	09285-18 TC
18 cm, 7"	
09281-20	09285-20 TC
20 cm, 8"	
09281-23	09285-23 TC
23 cm, 9"	
09281-25	09285-25 TC
25 cm, 10"	
09281-28	09285-28 TC
28 cm, 11"	
09281-30	09285-30 TC
30 cm, 12"	



METZENBAUM FINO

09282-15	09286-15 TC
15 cm, 6"	
09282-18	09286-18 TC
18 cm, 7"	
09282-20	09286-20 TC
20 cm, 8"	
09282-23	09286-23 TC
23 cm, 9"	
09282-25	09286-25 TC
25 cm, 10"	
09282-28	09286-28 TC
28 cm, 11"	



METZENBAUM FINO

09283-15	09287-15 TC
15 cm, 6"	
09283-18	09287-18 TC
18 cm, 7"	
09283-20	09287-20 TC
20 cm, 8"	
09283-23	09287-23 TC
23 cm, 9"	
09283-25	09287-25 TC
25 cm, 10"	
09283-28	09287-28 TC
28 cm, 11"	

Präparierscheren
Dissecting Scissors
Tijeras de disección
Forbici per dissezione

NOIR

Wellenschliff
Wave cut
Corte de onda
Taglio a onda

**METZENBAUM**

09285-15W
14,5 cm, 5¾"



09285-18W
18 cm, 7"



09285-20W
20 cm, 8"

Chirurgische Scheren, fein
 Operating Scissors, fine
 Tijeras para cirugía, finas
 Forbici per chirurgia, fine



IRIS



09340-09 9 cm 09341-09

09340-10 10 cm 09341-10

09340-11 11 cm 09341-11

09344-11 TC

09345-11 TC

gerade
 straight
 rectas
 rette

gebogen
 curved
 curvas
 curve

abgewinkelt
 angled
 angulada
 angolata

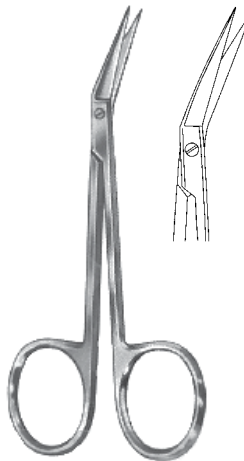

IRIS
 09346-11
 11 cm, 4 $\frac{3}{8}$ "

Tonsillen-, Gefäßscheren
Tonsil, Vascular Scissors
 Tijeras amígdalas y vasculares
 Forbici per tonsilli e vascolari



COTTLE
 09405-16
09406-16 TC
 16 cm, 6¼"

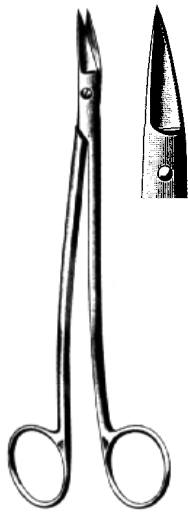

DEAN
 09425-17 09427-17
 17 cm, 6¾"

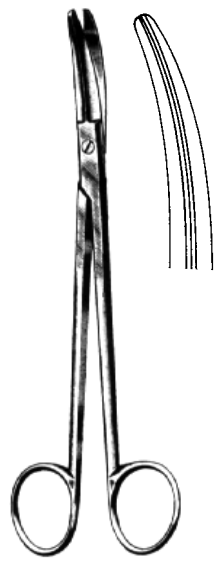

BOETTCHER
 09435-18
 18 cm, 7"

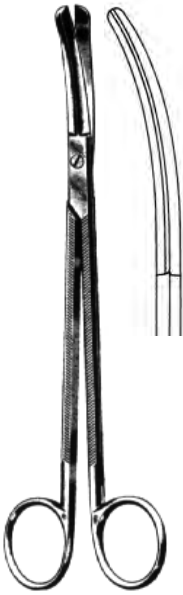

GOOD
 09437-19
 19 cm, 7½"

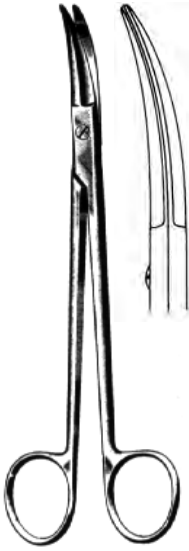

PRINCE
 09439-17
 17 cm, 6¾"



09470-11
 11 cm, 4¾"

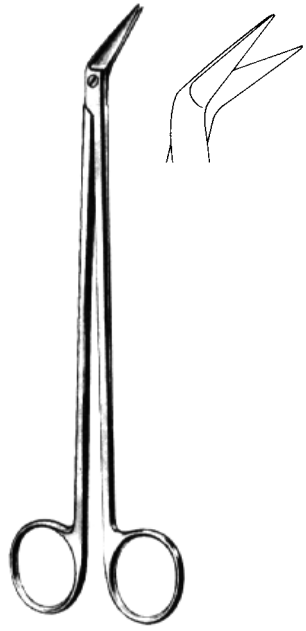

POTTS-DE MARTEL
 09473-21
 21 cm, 8¼"

Gefäßscheren
 Vascular Scissors
 Tijeras vasculares
 Forbici vascolari

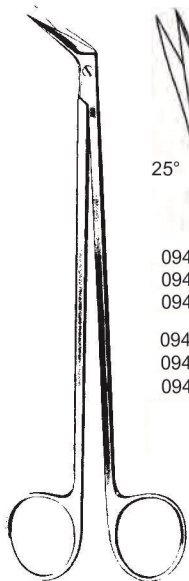

POTTS-SMITH
 19 cm, 7½"

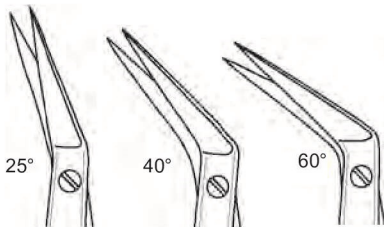

- | | | |
|-------------|-------------|--------------------|
| 09480-25 | 09480-40 | 09480-60 |
| 09480-25 TC | 09480-40 TC | 09480-60 TC |
| 09480-25 SC | 09480-40 SC | <u>09480-60 SC</u> |
| 09481-25 | 09481-40 | 09481-60 |
| 09481-25 TC | 09481-40 TC | 09481-60 TC |
| 09481-25 SC | 09481-40 SC | 09481-60 SC |

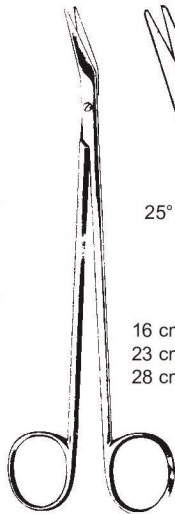

DE BAKEY

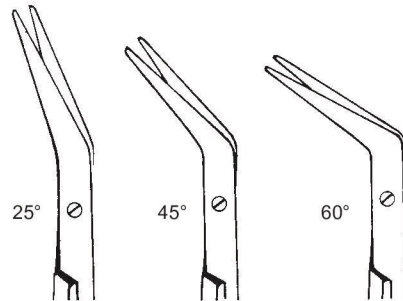

- | | | | |
|-------|----------|----------|----------|
| 16 cm | 09490-16 | 09491-16 | 09492-16 |
| 23 cm | 09490-23 | 09491-23 | 09492-23 |
| 28 cm | 09490-28 | 09491-28 | 09492-28 |

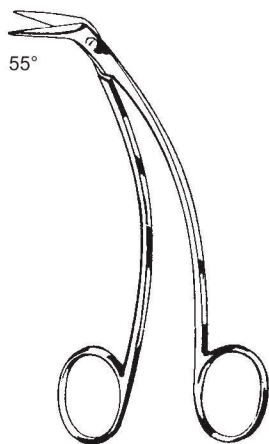

FAVALORO
 09496-15 15 cm, 6"

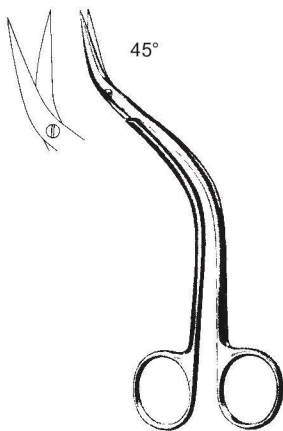

DE BAKEY
 09497-15 15,5 cm, 6"



KELLY
 09540-16 09541-16
09542-16 TC 09543-16 TC
 16 cm, 6¼"

Knorpelscheren, Nasenschere, Gefäßscheren
 Cartilage Scissors, Nasel Scissors, Vascular Scissors
 Tijeras para cartilago, Tijeras nasales, Tijeras vasculares
 Forbici per cartilagine, Forbici nasali, Forbici vascolari



gezahnt
 saw edge
 dentadas
 dentellata

MARTIN
 09613-20
 18 cm, 7"



McINDOE
 09614-19
 19 cm, 7½"



FOMON
 09617-13
 13 cm, 5½"



SCHMIEDEN-TAYLOR
 09619-17
 17 cm, 6¾"

Darmscheren, Nagelspaltschere, Fadenscheren

Enterotomy Scissors, Nail Splitting Scissors, Stitch Scissors

Tijeras para intestino, Tijeras para hender uña, Tijeras para hilos

Forbici per enterotomia, Forbici per staccare unghie, Forbici per legature



FERGUSSON
09770-18
18 cm, 7"

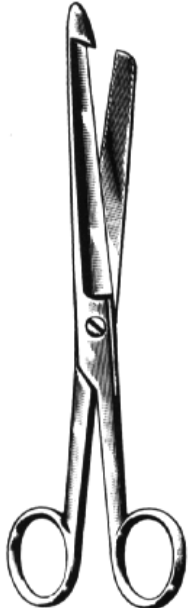

09772-21
21 cm, 8¼"



09774-21
21 cm, 8¼"

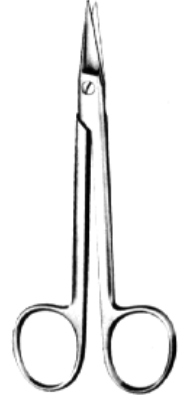

— SYSTRUNK —
09775-13 09777-13
13 cm, 5½"



SPENCER
09802-09
9 cm, 3½"



SPENCER
09802-11
11 cm, 4¾"



NORTHBENT
09803-09 9 cm, 3½"
09803-13 13 cm, 5½"



LITTAUER
09804-14
14 cm, 5½"



HEATH
09809-15
15 cm, 6"

Verbandscheren, Gipsschere
 Bandage Scissors, Plaster Scissors
 Tijeras para vendajes, Tijeras para yeso
 Forbici per bendaggi, Forbici per gesso

Gaze
 Gauze
 Gaza
 Garza



SMITH US ARMY
 09898-20
 18 cm, 7"



LISTER
 9 cm, 3½" 09901-09
 11 cm, 4¾" 09901-11
 14 cm, 5½" 09901-14 09905-14 TC
 18 cm, 7" 09901-18 09905-18 TC
 18 cm, 7" 09901-20



LISTER
 09906-18 18 cm, 7"
 09906-20 18 cm, 7"



BERGMANN
 09911-23
 23 cm, 9"

Ultra-Light-Pinzetten
Ultra-Light-Forceps
 Pinzas-Ultra-Ligera
 Pinza-ultra-leggera

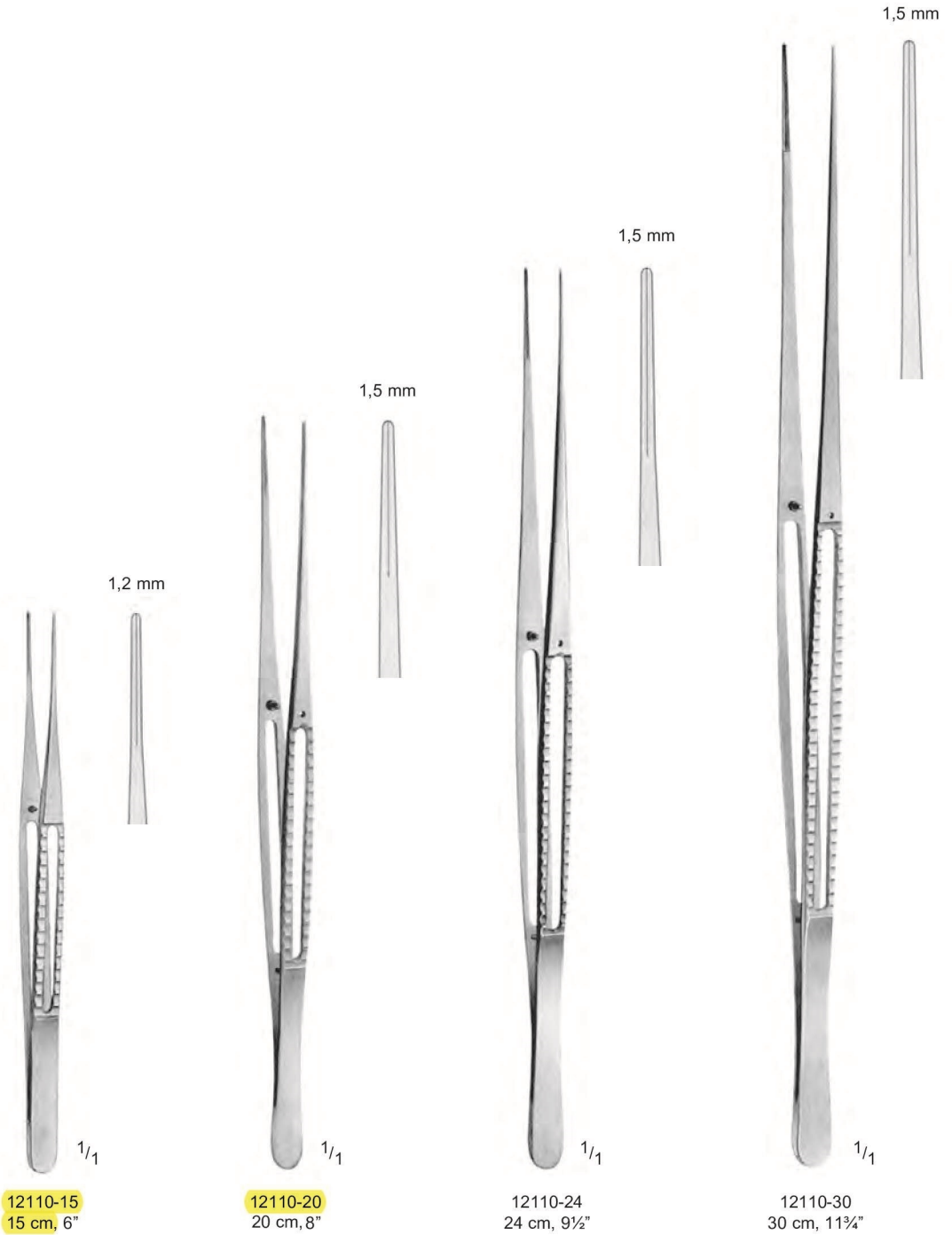

Atraumatische Pinzetten
 Atraumatic Tissue Forceps
 Pinzas atraumáticas
 Pinze atraumatiche



DE BAKEY
 12302-16 16 cm, 6¼"
 12302-20 18 cm, 7"
 12302-24 24 cm, 9½"



DE BAKEY
 12306-16 16 cm, 6¼"
 12306-20 18 cm, 7"
 12306-24 24 cm, 9½"
 12306-30 30 cm, 11¼"



DE BAKEY
 12308-16 16 cm, 6¼"
 12308-20 18 cm, 7"
 12308-24 24 cm, 9½"
 12308-30 30 cm, 11¼"

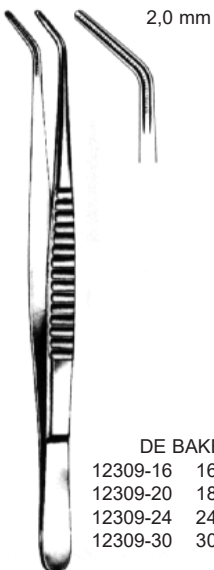

DE BAKEY
 12309-16 16 cm, 6¼"
 12309-20 18 cm, 7"
 12309-24 24 cm, 9½"
 12309-30 30 cm, 11¼"



DE BAKEY
 12304-16 16 cm, 6¼"
 12304-20 18 cm, 7"
 12304-24 24 cm, 9½"
 12304-30 30 cm, 11¼"

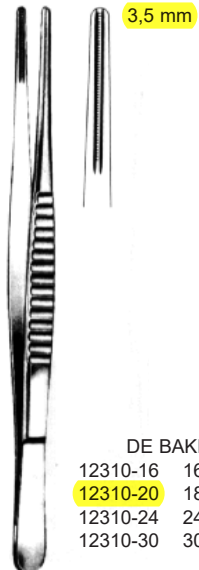

DE BAKEY
 12310-16 16 cm, 6¼"
 12310-20 18 cm, 7"
 12310-24 24 cm, 9½"
 12310-30 30 cm, 11¼"

Gefäßklemmen, Bulldogklemmen, Arterienklemmen
 Hemostatic Forceps
 Pinzas hemostáticas
 Pinze serrafina, Pinze emostatiche



DIEFFENBACH
 13102-04 3,5 cm, 1.4"
 13102-05 5,5 cm, 2.2"



gerade
 straight
 recta
 rette

gebogen
 curved
 curva
 curve



DIEFFENBACH
 13103-04 3,5 cm, 1.4"
 13103-05 5,5 cm, 2.2"

JOHNS-HOPKINS

13110-50	5,0 cm, 2"	13111-50
13110-55	5,5 cm, 2.2"	13111-55
13110-65	6,5 cm, 2.6"	13111-65
13110-70	7,0 cm, 2 3/4"	13111-70
13110-75	7,5 cm, 3"	13111-75
13110-90	9,0 cm, 3 1/2"	13111-90

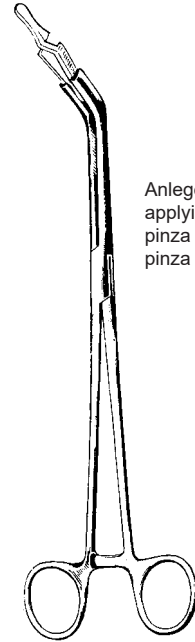

Anlegezange
 applying forceps
 pinza para poner
 pinza applicatrice

13115-00
 23 cm, 9"

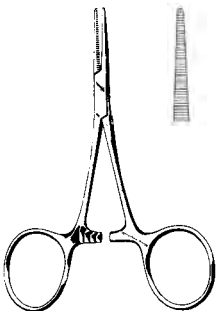

HARTMANN
 13210-10
 10 cm, 4"

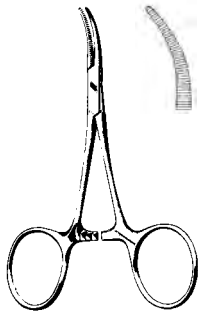

HARTMANN
 13211-10
 10 cm, 4"

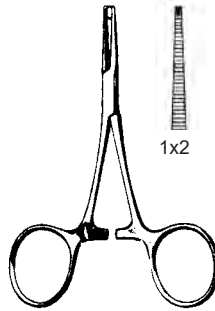

HARTMANN
 13212-10
 10 cm, 4"

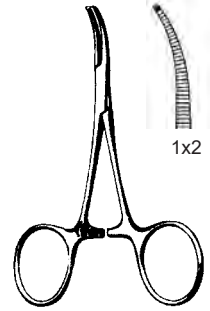

HARTMANN
 13213-10
 10 cm, 4"

Micro-HARTMANN
 13214-10
 10 cm, 4"

Micro-HARTMANN
 13215-10
 10 cm, 4"

Arterienklemmen
Hemostatic Forceps
Pinzas hemostáticas
Pinze emostatiche



TITAN — HALSTED-MOSQUITO — TITAN

13224-12	13220-12	12,5 cm, 5"	13221-12	13225-12
	13220-14	14,0 cm, 5 1/2"	13221-14	
	13220-18	18,0 cm, 7"	13221-18	
	13220-21	21,0 cm, 8 1/4"	13221-21	



— HALSTED-MOSQUITO micro —

13222-12	12,5 cm, 5"	13223-12
----------	-------------	----------

JACOBSON micro

13226-12	12,5 cm, 5"	13227-12
----------	-------------	----------

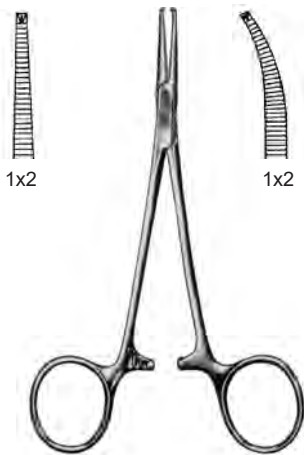

— HALSTED-MOSQUITO —

13230-12	12,5 cm, 5"	13231-12
13230-14	14,0 cm, 5 1/2"	13231-14
13230-18	18,0 cm, 7"	13231-18
13230-21	21,0 cm, 8 1/4"	13231-21

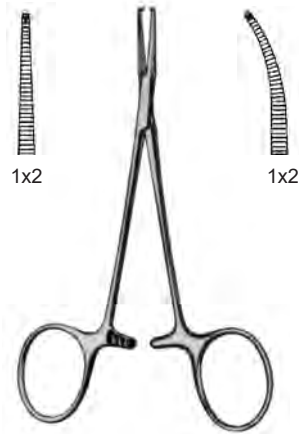

— HALSTED-MOSQUITO micro —

13232-12	12,5 cm, 5"	13233-12
----------	-------------	----------

Arterienklemmen
Hemostatic Forceps
Pinzas hemostáticas
Pinze emostatiche

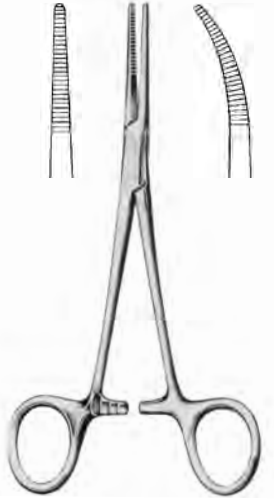

KELLY

13240-14 14 cm, 5 1/2" 13241-14
13240-18 18 cm, 7" 13241-18
13244-14 14 cm, 5 1/2" 13245-14
TITAN TITAN



KELLY-RANKIN

13242-16 16 cm, 6 1/4" 13243-16



TERRIER

13228-13
13 cm, 5 1/8"

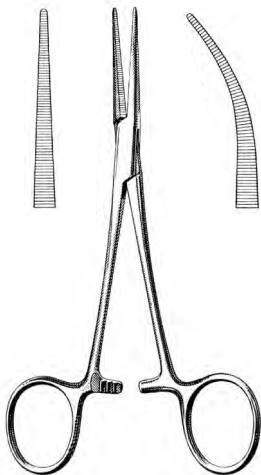

COLLER-CRILE

13256-14 14 cm, 5 1/2" 13257-14
13258-16 16 cm, 6 1/4" 13259-16

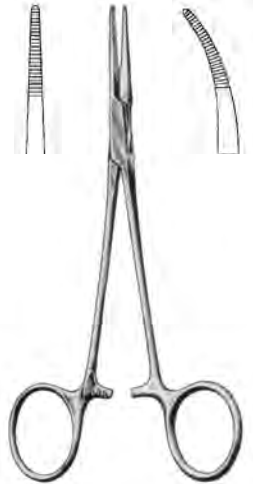

PROVIDENCE-HOSPITAL

13270-14 14 cm, 5 1/2" 13271-14

Arterienklemmen
Hemostatic Forceps
Pinzas hemostáticas
Pinze emostatiche

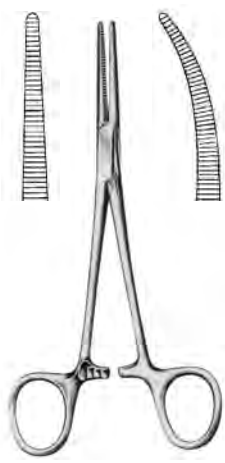

CRILE
13250-14 14 cm, 5 1/2" 13251-14
13250-18 18 cm, 7" 13251-18
13254-14 14 cm, 5 1/2" 13255-14
TITAN TITAN



CRILE
13260-14 14 cm, 5 1/2" 13261-14



CHRISTOPHE
16 cm, 6 1/4"

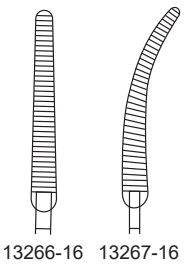

13266-16 13267-16

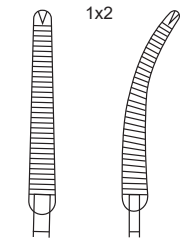

13268-16 13269-16

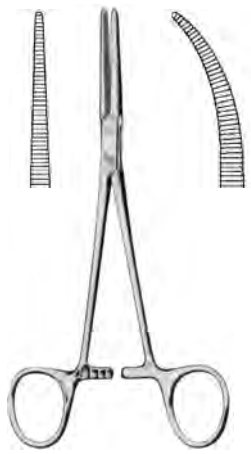

CRILE-RANKIN
13262-16 16 cm, 6 1/4" 13263-16

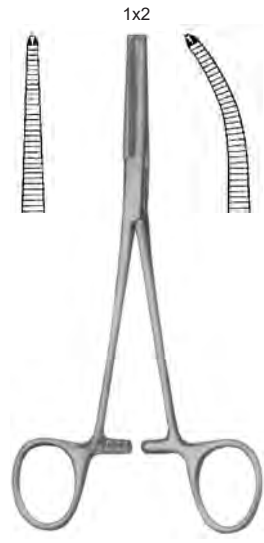

CRILE-RANKIN
13264-16 16 cm, 6 1/4" 13265-16

Arterienklemmen
Hemostatic Forceps
Pinzas hemostáticas
Pinze emostatiche

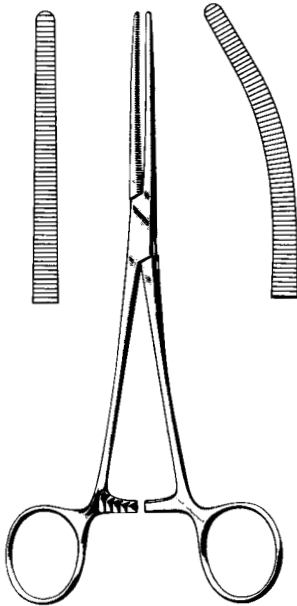

ROCHESTER-PEAN

13310-13	13 cm, 5 1/8"	13311-13
13310-14	14 cm, 5 1/2"	13311-14
13310-16	16 cm, 6 1/4"	13311-16
13310-18	18 cm, 7"	13311-18
13310-20	20 cm, 8"	13311-20
13310-22	22 cm, 8 3/4"	13311-22
13310-24	24 cm, 9 1/2"	13311-24
13310-26	26 cm, 10 1/4"	13311-26
13310-30	30 cm, 11 3/4"	13311-30

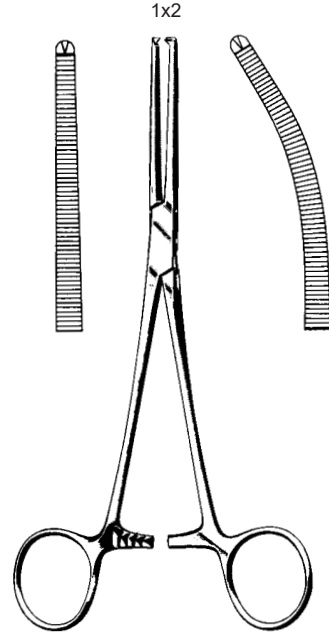

ROCHESTER-OCHSNER

13320-13	13 cm, 5 1/8"	13321-13
13320-14	14 cm, 5 1/2"	13321-14
13320-16	16 cm, 6 1/4"	13321-16
13320-18	18 cm, 7"	13321-18
13320-20	20 cm, 8"	13321-20
13320-22	22 cm, 8 3/4"	13321-22
13320-24	24 cm, 9 1/2"	13321-24
13320-26	26 cm, 10 1/4"	13321-26
13320-30	30 cm, 11 3/4"	13321-30

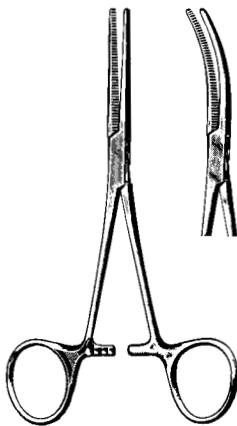

Fein
Delicate
Delicada
Fina

PEAN

13312-14	14 cm, 5 1/2"	13313-14
13312-16	16 cm, 6 1/4"	13313-16

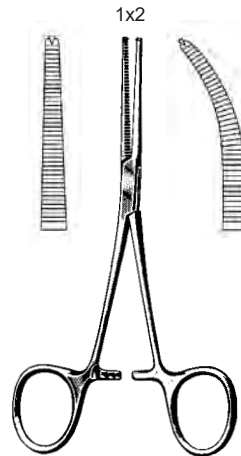

Fein
Delicate
Delicada
Fina

KOCHER

13322-14	14 cm, 5 1/2"	13323-14
13322-16	16 cm, 6 1/4"	13323-16

Arterienklemmen
Hemostatic Forceps
Pinzas hemostáticas
Pinze emostatiche



OVERHOLT-BABY
13420-14
14 cm, 5 1/2"



OVERHOLT-GEISSENDOERFER
21 cm, 8 1/4"

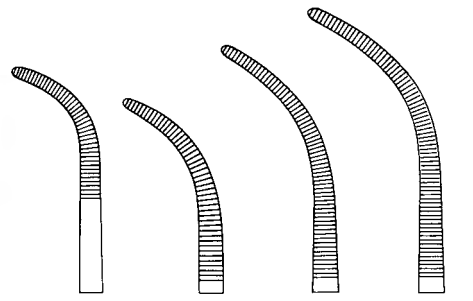

Fig. 1
13421-01

Fig. 2
13421-02

Fig. 3
13421-03

Fig. 4
13421-04

13425-02
26 cm
10 1/4"

13425-03
27 cm
10 1/2"

13425-04
27,5 cm
10,8"

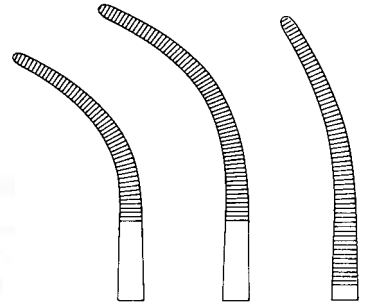

Fig. 5
13421-05

Fig. 6
13421-06

Fig. 7
13421-07

13425-05
27 cm
10 1/2"

13425-06
28 cm
11"



OVERHOLT

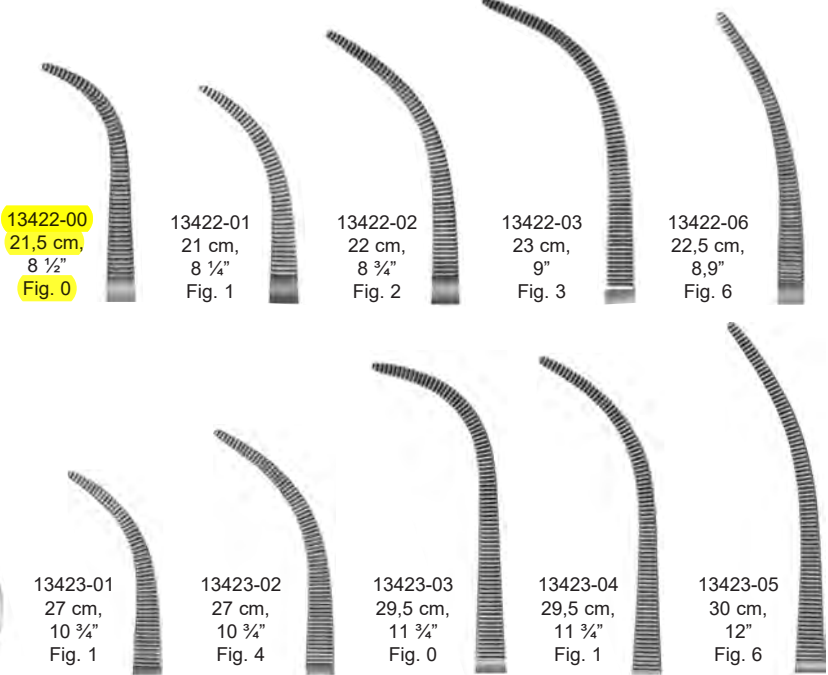

13422-00
21,5 cm,
8 1/2"
Fig. 0

13422-01
21 cm,
8 1/4"
Fig. 1

13422-02
22 cm,
8 3/4"
Fig. 2

13422-03
23 cm,
9"
Fig. 3

13422-06
22,5 cm,
8,9"
Fig. 6

13423-01
27 cm,
10 3/4"
Fig. 1

13423-02
27 cm,
10 3/4"
Fig. 4

13423-03
29,5 cm,
11 3/4"
Fig. 0

13423-04
29,5 cm,
11 3/4"
Fig. 1

13423-05
30 cm,
12"
Fig. 6

Arterienklemmen
Hemostatic Forceps
Pinzas hemostáticas
Pinze emostatiche

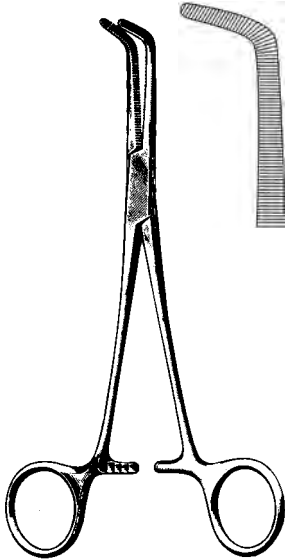

MIXTER
13471-14 14 cm, 5 ½"
13471-16 16 cm, 6 ¼"
13471-18 18 cm, 7"
13471-23 23 cm, 9"

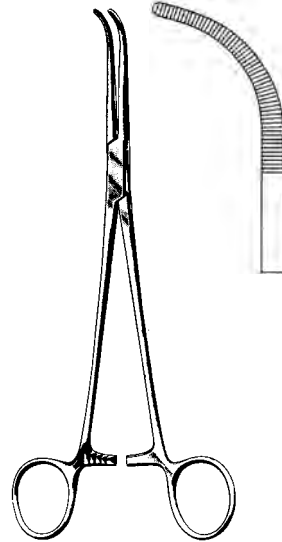

MIXTER
13473-22
22 cm, 8 ¾"



KANTROWITZ
13474-19 19 cm, 7 ½"
13474-24 24 cm, 9 ½"
13474-26 26 cm, 10 ¼"



MIXTER BABY
13475-14
14 cm, 5 ½"



MIXTER BABY
13475-18
18 cm, 7"

Wundhaken
Retractors
Separadores
Divaricatori

Satz, set, juego, serie

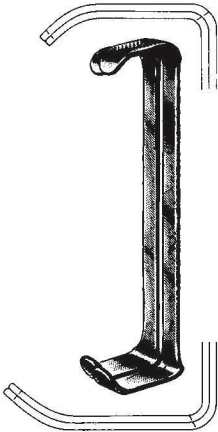

FARABEUF
19102-12
12 cm, 4 3/4"

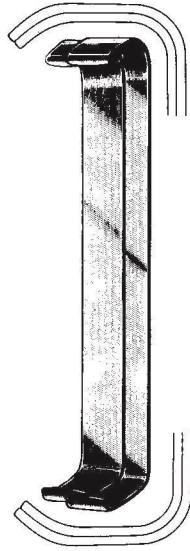

FARABEUF
19102-15 15 cm, 6"
19102-20 20 cm, 8"



COLLIN
19104-15
15 cm, 6"

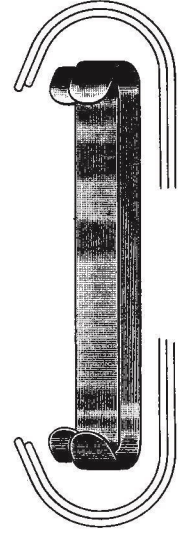

PARKER
19110-13
13,5 cm, 5 1/4"

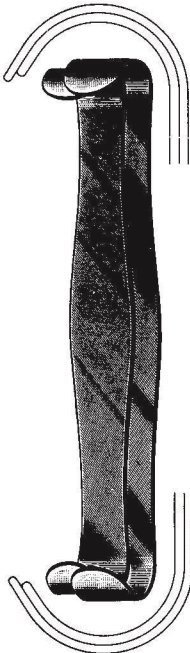

PARKER
19110-18 18 cm, 7"

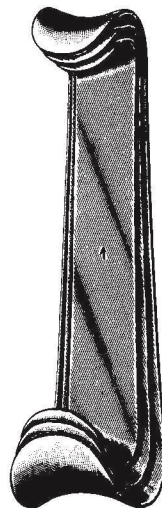

ROUX
19120-00

Fig. 1 = 24x20 mm
Fig. 2 = 29x26 mm
Fig. 3 = 35x29 mm

Fig. 1 = 30x28 mm
Fig. 2 = 36x36 mm
Fig. 3 = 38x43 mm

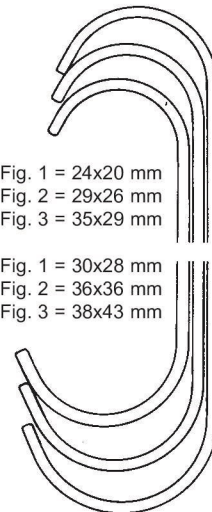

19120-14 Fig. 1 14 cm, 5 1/2"
19120-15 Fig. 2 15 cm, 6"
19120-17 Fig. 3 17 cm, 6 3/4"

Wundhaken
Retractors
 Separadores
 Divaricatori



19388-40 70x40 mm
 19388-50 70x50 mm
 19388-65 70x65 mm



MORRIS
 24,5 cm
 9 3/4"

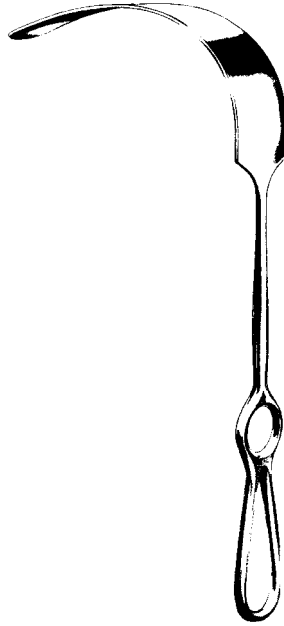

KELLY
 19385-38 160x38 mm
 19385-57 160x57 mm
 27 cm, 10 1/2"



SIMON
 19480-22 115x22 mm
 19480-27 115x27 mm
 28 cm, 11"



19482-45 45x25 mm
 19482-73 73x28 mm
 19482-82 82x28 mm

HEANEY
 27 cm, 10 1/2"

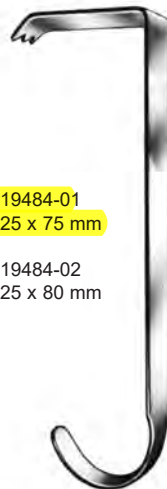

19484-01
 25 x 75 mm

19484-02
 25 x 80 mm

HIBBS
 24 cm, 9 1/2"



125x37 mm

SAUERBRUCH
 19492-25
 25 cm, 10"

Wundsperrer
Retractors
Separadores
Divaricatori

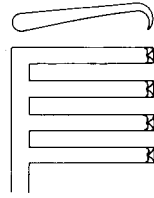
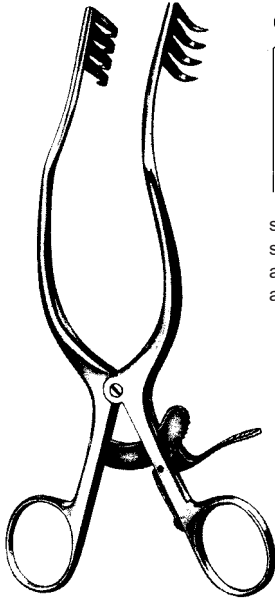

spitz
sharp
agudo
acuto

ANDERSON ADSON
19679-20 19,5 cm, 7 3/4"



stumpf
blunt
romo
smusso

NORFOLK / NORWICH
19679-22 22 cm, 8 3/4"

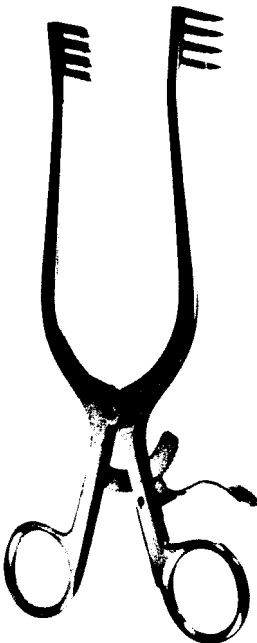

spitz
sharp
agudo
acuto

ADSON
19680-19 19 cm, 7 1/2" 19681-19

stumpf
blunt
romo
smusso



stumpf
blunt
romo
smusso

TRAVERS
19681-21 21,5 cm, 8 1/2"

Sonden
 Probes, Directors
 Sondas, estiletos
 Sonde, specilli



2 mm ø

- 11,5 cm, 4 1/2" 21102-11
- 13,0 cm, 5 1/8" 21102-13
- 14,5 cm, 5 3/4" 21102-14
- 16,0 cm, 6 1/4" 21102-16
- 18,0 cm, 7" 21102-18
- 20,0 cm, 8" 21102-20
- 25,0 cm, 10" 21102-25



1 mm ø

- 21104-11
- 21104-13
- 21104-14
- 21104-16
- 21104-18
- 21104-20
- 21104-25



2 mm ø

- 21106-11
- 21106-13
- 21106-14
- 21106-16
- 21106-18
- 21106-20
- 21106-25



21108-14
 14,5 cm, 5 3/4"



BRODIE
 21109-18
 18 cm
 7"



- 13,0 cm, 5 1/8" 21110-13
- 14,5 cm, 5 3/4" 21110-14
- 16,0 cm, 6 1/4" 21110-16
- 18,0 cm, 7" 21110-18
- 20,0 cm, 8" 21110-20



DOYEN
 21111-14
 14 cm
 5 1/2"



21112-14
 14,5 cm
 5 3/4"



NELATON
 21120-16
 16 cm
 6 1/4"



FISH
 21121-14
 14 cm, 5 1/2"
 21121-18
 18 cm, 7"



WATSON-CHEYNE
 21122-13
 13 cm, 5 1/8"
 21122-18
 18 cm, 7"

Krampfader-Besteck in Metalletui
 Varicose vein probe set in metal case
 Juego para várices en estuche de metal
 Astuccio per varici in scatola di metallo



NABATOFF
21150-00
 135x100x25 mm
 compl.

21150-02
 Sondenspitze
 Probe Tip
 Puntas sueltas
 Punte

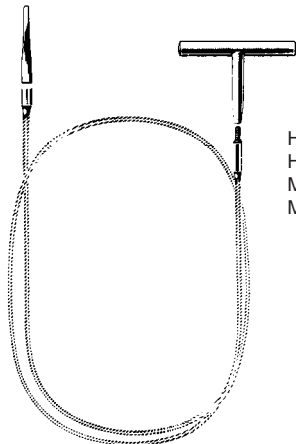

21150-80
 Handgriff
 Handle only
 Mango suelto
 Manico solo

21150-90

Zugseil
 cable flexible
 cable de traccion flex.
 Corda di trazione fless.

Oliven
 Olives
 Olivas
 Olivas

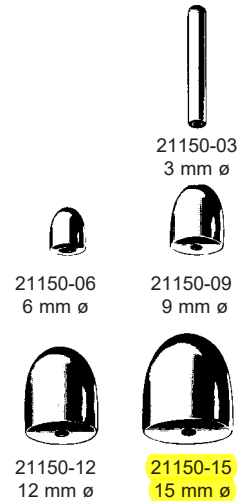

Hohlmeißelzangen
 Bone Rongeurs
 Pinzas-gubias
 Pinze sgorbie

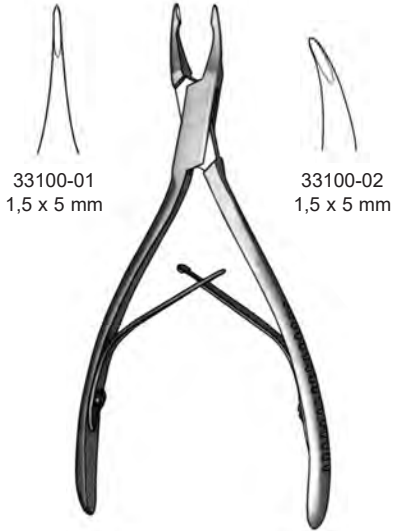

33100-01
1,5 x 5 mm

33100-02
1,5 x 5 mm

MICRO FRIEDMAN
14 cm, 5/2"



2 mm

FRIEDMAN Mini
33101-12 12 cm, 4 3/4"



3,5 mm

FRIEDMAN
33101-14 14 cm, 5 1/2"

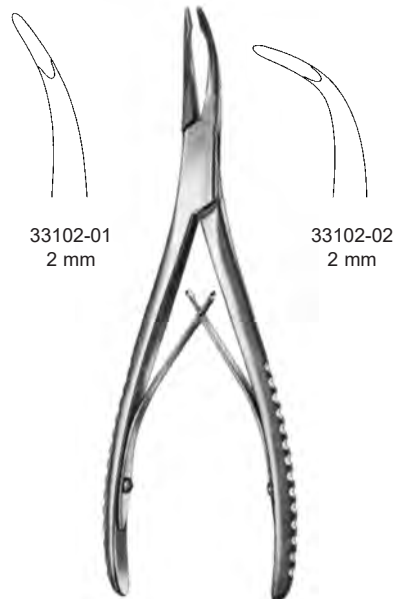

33102-01
2 mm

33102-02
2 mm

STELLBRINK
17 cm, 6 3/4"

Hohlmeißelzangen
 Bone Rongeurs
 Pinzas-gubias
 Pinze sgorbie



OLIVECRONA
 33147-20
 20 cm, 7.9"

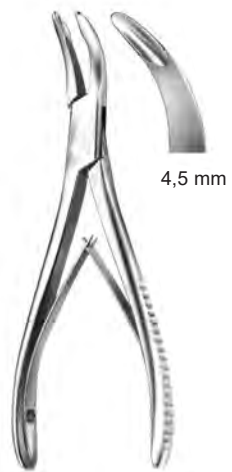

BANE-HARTMANN
 33148-18
 17,5 cm, 7"



LEMPERT
 33150-16 33151-16
 16 cm, 6 1/4"



JANSEN
 17 cm, 6 3/4"



LEMPERT
 33154-18 33155-18
 18,5 cm, 7 1/4"



BEYER
 33156-18
 18 cm, 7"

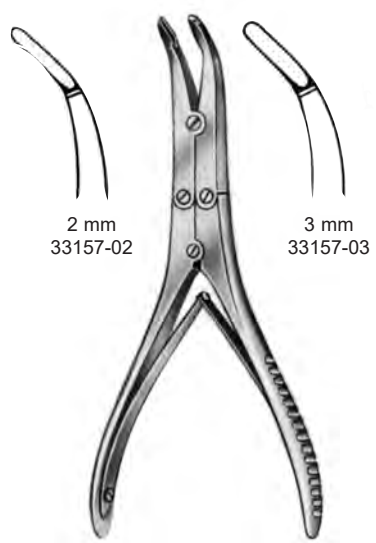

KLEINERT-KUTZ
 15 cm, 6"

Scharfe Löffel
Bone Currettes
Cucharillas cortantes
Curette taglianti



33485-21 21 cm, 8 1/4"
oval/rund
ovale/ronde
ovalado/redondo
ovale/rotonda



WILLIGER
17,5 cm, 7"

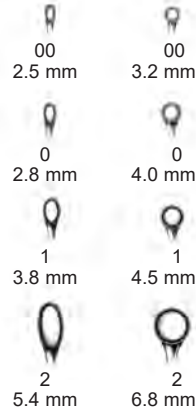
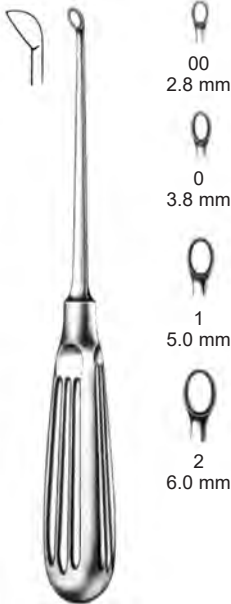
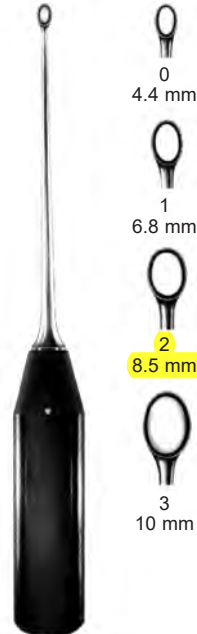

Fig. 00	33485-99	33486-99
0	33486-00	33487-00
1	33486-01	33487-01
2	33486-02	33487-02



DAUBENSPECK	Fig. 00	33487-99
20 cm, 8"	0	33488-00
	1	33488-01
	2	33488-02



27 cm, 10 1/2"	Fig. 0	33489-00
	1	33489-01
	2	33489-02
	3	33489-03

Osteotome, Hohlmeißel
 Osteotome, Gouges
 Osteótomo, Gubias
 Osteotomia, sgorbie

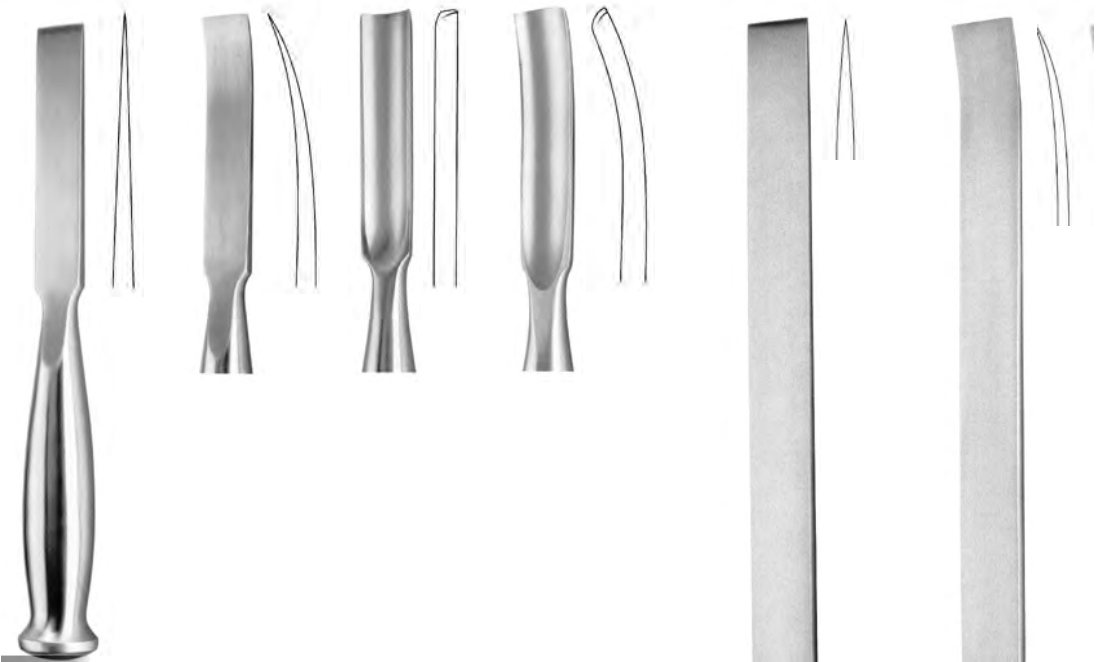

SMITH-PETERSEN
 20 cm, 8"

6 mm	33644-06	33645-06	33647-06	
9 mm	33644-09	33645-09	33647-09	33649-09
13 mm	33644-13	33645-13		
14 mm			33647-14	33649-14
16 mm	33644-16	33645-16	33647-16	33649-16
19 mm	33644-19	33645-19	33647-19	33649-19
25 mm	33644-25	33645-25	33647-25	33649-25
32 mm	33644-32	33645-32	33647-32	33649-32

LAMBOTTE

24 cm, 9 1/2"

24 cm, 9 1/2"

33650-04	4 mm	33651-04
33650-06	6 mm	33651-06
33650-08	8 mm	33651-08
33650-10	10 mm	33651-10
33650-13	13 mm	33651-13
33650-16	16 mm	33651-16
33650-18	18 mm	33651-18
33650-20	20 mm	33651-20
33650-25	25 mm	33651-25
33650-30	30 mm	33651-30
33650-38	38 mm	33651-38
33650-44	44 mm	33651-44
33650-50	50 mm	33651-50

Osteotome, Flachmeißel, Hohlmeißel
 Osteotome, Chisels, Gouges
 Osteótomo, Cinceles, Gubias
 Osteotomia, Scalpelli, Sgorbie



HOKE

14 cm, 5 1/2"

33668-03	3 mm
33668-05	5 mm
33668-06	6 mm
33668-08	8 mm
33668-09	9 mm
33668-13	13 mm
33668-16	16 mm
33668-19	19 mm



HIBBS

24 cm, 9 1/2"

33670-06	6 mm
33670-09	9 mm
33670-13	13 mm
33670-16	16 mm
33670-19	19 mm
33670-25	25 mm
33670-32	32 mm



HIBBS

24 cm, 9 1/2"

33671-06	6 mm
33671-09	9 mm
33671-13	13 mm
33671-16	16 mm
33671-19	19 mm
33671-25	25 mm
33671-32	32 mm



HIBBS

24 cm, 9 1/2"

33672-06	6 mm
33672-09	9 mm
33672-13	13 mm
33672-16	16 mm
33672-19	19 mm
33672-25	25 mm
33672-32	32 mm



HIBBS

24 cm, 9 1/2"

33673-06	6 mm
33673-09	9 mm
33673-13	13 mm
33673-16	16 mm
33673-19	19 mm
33673-25	25 mm
33673-32	32 mm



HIBBS

24 cm, 9 1/2"

33675-06	6 mm
33675-09	9 mm
33675-13	13 mm
33675-16	16 mm
33675-19	19 mm
33675-25	25 mm
33675-32	32 mm

Meißel
Chisels
Cinceles
Scalpelli



33676-02
9 cm, 3 1/2"
Spannschlüssel
Key
Llave
Clé
Chiave

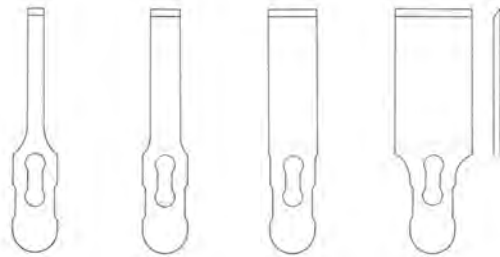

5 mm 33676-05 8,5 mm, 3,4"
10 mm 33676-10 8,5 mm, 3,4"
16 mm 33676-16 8,5 mm, 3,4"
25 mm 33676-25 8,5 mm, 3,4"

Meißelklingen
auswechselbar
Chisel blades
interchangeable
Hojas de cincel
intercambiables
Lame intercambiabili

33676-01
18,5 cm, 7 1/4"
Griff allein
Handle only
Mango suelto
Manico solo

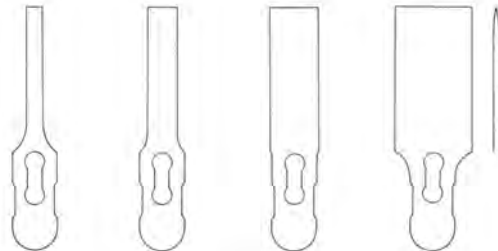

5 mm 33677-05 8,5 mm, 3,4"
10 mm 33677-10 8,5 mm, 3,4"
16 mm 33677-16 8,5 mm, 3,4"
25 mm 33677-25 8,5 mm, 3,4"

Osteotomklingen
auswechselbar
Osteotome blades
interchangeable
Hojas de osteótomo
intercambiables
Lame per osteotomia
intercambiabili

Elevatoren, Raspatoren
Elevators, Raspatories
Elevadores, Periostótomos
Elevatori, Periostotomi

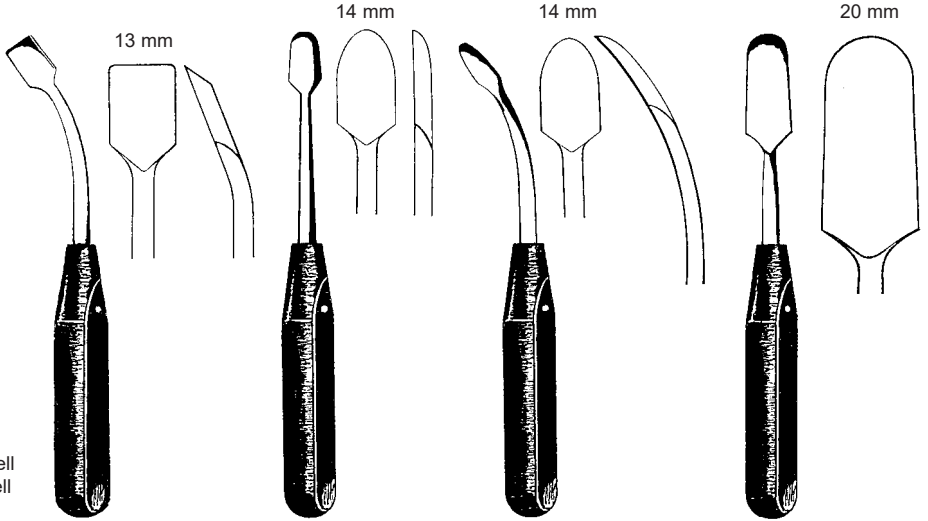

mit Ferrozellgriff
with Ferrozell-Handle
con mango de Ferrozell
con manico di Ferrozell

33745-19
18,5 cm, 7 1/4"

33746-19
19,5 cm, 7 3/4"

33747-18
18,5 cm, 7 1/4"

33748-20
20 cm, 8"

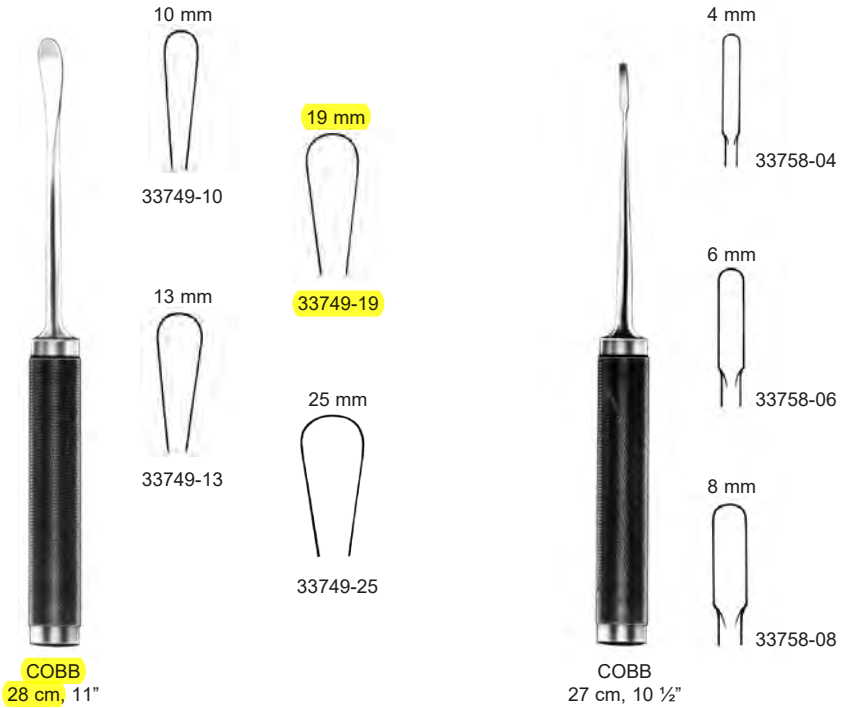

COBB
28 cm, 11"

COBB
27 cm, 10 1/2"

Knochenhebel
Bone Levers
Elevadores para huesos
Elevatori per ossa

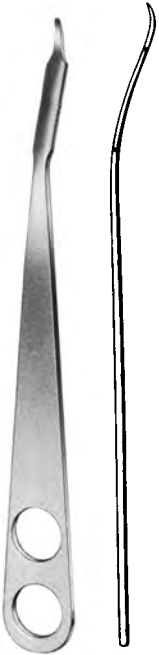

HOHMANN
23,5 cm, 9 1/4"
33801-08 8 mm
33801-10 10 mm
33801-12 12 mm

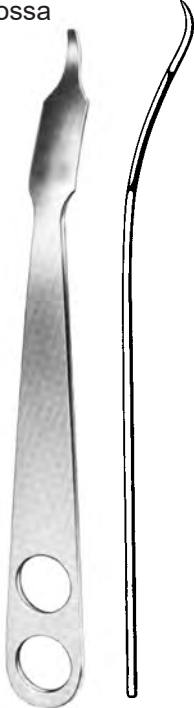

HOHMANN
33801-18
18 mm, 3/4"
23,5 cm, 9 1/4"

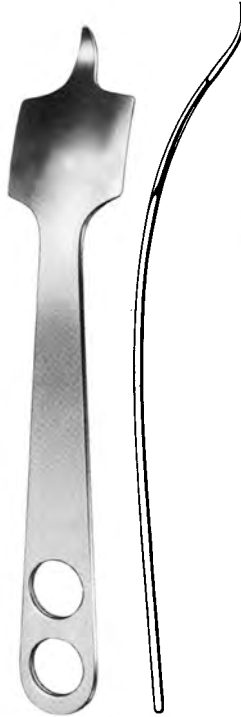

HOHMANN
33801-43
43 mm, 1 3/4"
26 cm, 10 1/4"



HOHMANN
33801-70
70 mm, 2 3/4"
25 cm, 10"



KÖNIG
33802-01
15 cm, 6"



KÖNIG
33802-02
15 cm, 6"



33802-14
14 cm, 5 1/2"



HAYES
33803-05
15 cm, 6"



33803-07
15 cm, 6"

Knochenhebel
Bone Levers
Elevadores para huesos
Elevatori per ossa



HOHMANN
25 cm, 10"
33803-43 43 mm

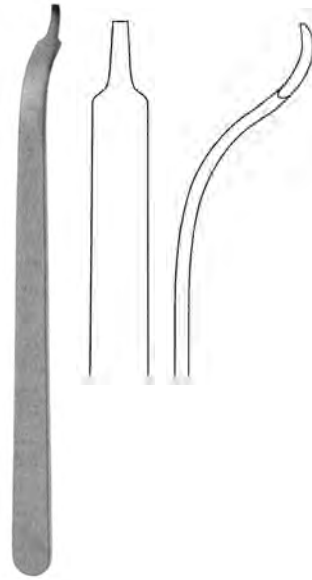

BUCK-GRAMCKO
33804-15 7,5 mm



HOHMANN
25 cm, 10"
33805-22 22 mm



HOHMANN
29 cm, 11 1/2"
33805-33 33 mm



HOHMANN
27,5 cm, 10 3/4"
33807-24 24 mm



HOHMANN
25 cm, 10"
33809-22 22 mm

Retraktor, Knochenhebel, Meniskushaken
 Retractor, Bone Levers, Meniscus Retractors
 Separador, Elevadores p. huesos, Separadores para menisco
 Divaricatori, Elevatori per ossa, Divaricatori per il menisco

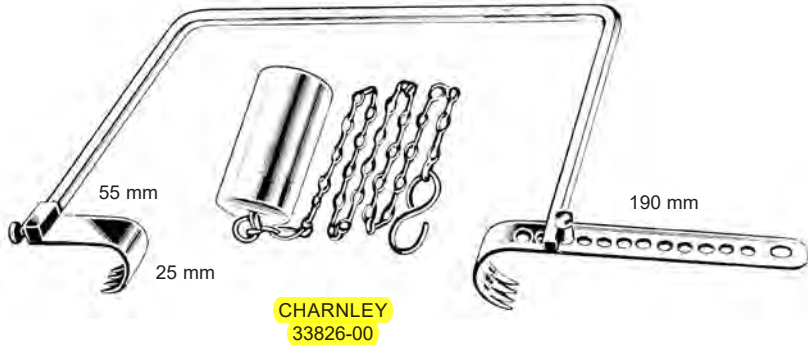

33826-01 spitz, gerieft
 pointed tip, serrated
 punta aguda, dentada
 punta acuta, zigrinata

33826-02 stumpf, gerieft
 blunt tip, serrated
 punta roma, dentada
 punta smussa, zigrinata

33826-03 stumpf, glatt
 blunt tip, smooth
 punta roma, lisa
 punta smussa, liscia

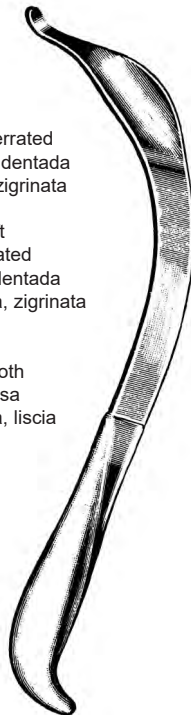

AUFRANC-COBRA
26 cm, 10 1/4"



BLOUNT
33827-17
17,5 cm, 7"

Dura Dissektoren
Dura Dissectors
Elevadores
Scollatori

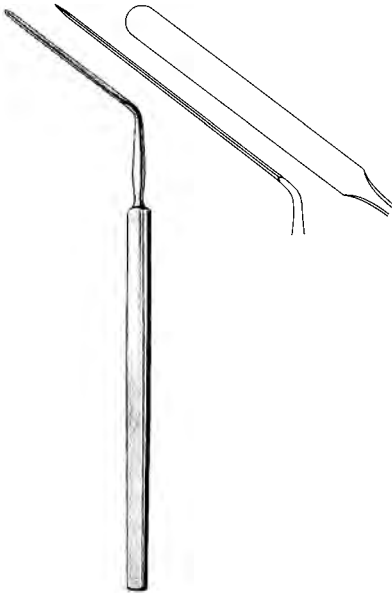

HORSLEY
41155-20
20 cm, 8"



WOODSON
41156-18
18 cm, 7"



FRAZIER
41158-01
15 cm, 6"



HOEN
41158-02
15 cm, 6"

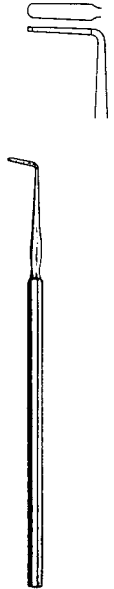

HOEN
41158-03
15 cm, 6"



PENFIELD
41161-01
17,5 cm, 6,9"



PENFIELD
41161-02
19,5 cm, 7 3/4"



PENFIELD
41161-03
19,5 cm, 7 3/4"



PENFIELD
41161-04
21,5 cm, 8 1/2"



PENFIELD
41161-05
29 cm, 11,4"

Hirnspatel, Saugrohre, Punktionskanüle
 Brain Spatulas, Suction Tubes, Puncture Cannulas
 Espatulas cerebrales, Tubos de aspiración, Tubo de punción
 Spatole cerebrali, Tubi aspirazioni, cannula per punzione



biegsam
 malleable
 maleable
 malleabile

DAVIS	18 cm, 7"
41254-06	6 mm, ¼"
41254-10	9 mm, ⅜"
41254-13	13 mm, ½"
41254-16	16 mm, ⅝"
41254-19	19 mm, ¾"
41254-25	25 mm, 1"
41254-32	32 mm, 1 ¼"
41254-38	38 mm, 1 ½"



ADSON
 41290-21
 21 cm, 8 ¼"
 ø 4 mm



isoliert
 isolated
 isolada
 isolato

FERGUSSON
 41294-40
 18 cm, 7"
 ø 4 mm, 90°

mm	Charr.	F.G.	30°	75°
Ø 1,7	5	41295-05		
Ø 2,0	6	41295-06		41297-06
Ø 2,3	7	41295-07		41297-07
Ø 2,7	8	41295-08		41297-08
Ø 3,0	9	41295-09		41297-09
Ø 3,3	10	41295-10		41297-10
Ø 3,7	11	41295-11		41297-11
Ø 4,0	12	41295-12		41297-12
Ø 5,0	15	41295-15		

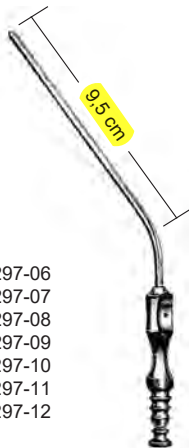

FRAZIER /FERGUSSON
 41295-06 – 41297-12
 19 cm, 7 ½"



FRAZIER /FERGUSSON
 41298-12
 12 cm, 4 ¾" / 3 mm

Wirbelkörperspreizer
 Lamina Spreaders
 Separadores para cuerpos vertebrales
 Divaricatori per corpi vertebrali



CLOWARD
 41401-16
 16 cm, 6 ¼"



INGE
 41405-17
 17 cm, 6 ¾"

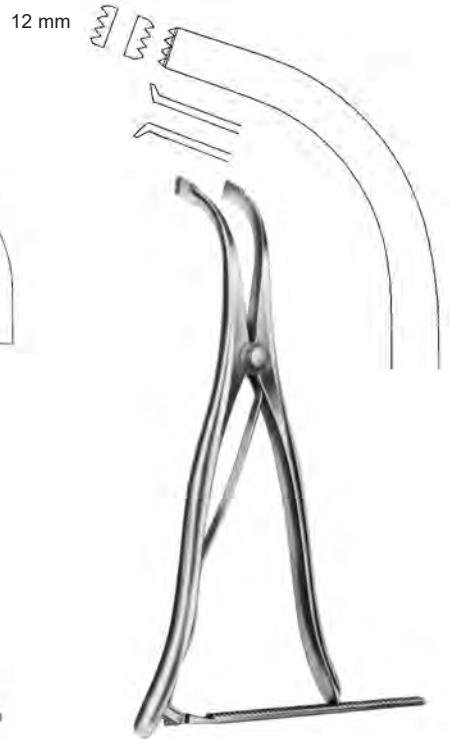

INGE
 41405-27
 27 cm, 10 ½"



CLOWARD
 41406-01
 12,5 cm, 5"

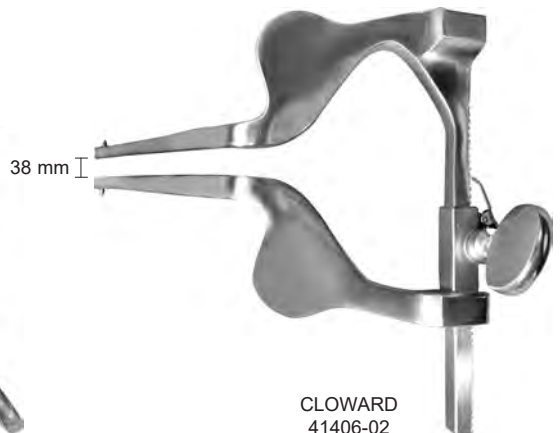

CLOWARD
 41406-02
 7,6 cm, 3"

Löffel, Schlingen, Häkchen
 Ear spoons, Loops, Hooklets
 Cucharas, Asas, Ganchitos
 Cucchiai, Anse, Uncinetti



GROSS
 45171-12
 12 cm, 4 3/4"



BILLEAU
 16 cm, 6 1/4"

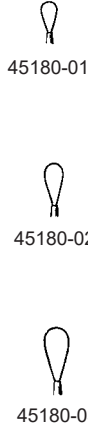

45180-01
 45180-02
 45180-03



LANGENBECK
 45181-13
 13 cm, 5 1/8"



ZAUFAL
 45184-16
 16 cm, 6 1/4"



ZAUFAL-JANSEN
 45185-15
 15 cm, 6"



DAY
 16 cm, 6 1/4"

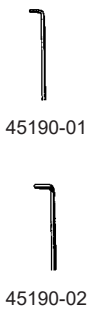

45190-01
 45190-02



WAGENER
 14 cm, 5 1/2"

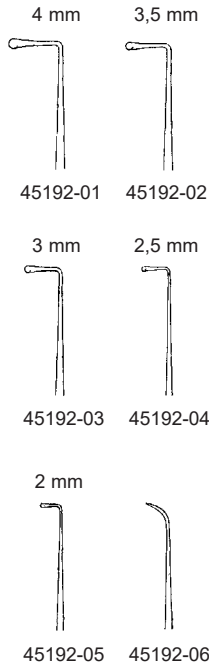

4 mm 3,5 mm
 45192-01 45192-02
 3 mm 2,5 mm
 45192-03 45192-04
 2 mm
 45192-05 45192-06



LUCAE
 14 cm, 5 1/2"

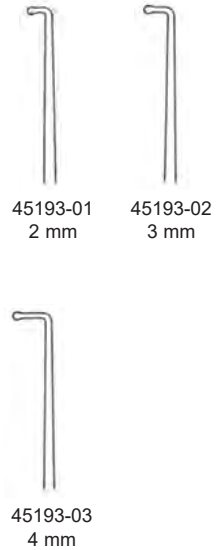

45193-01 45193-02
 2 mm 3 mm
 45193-03
 4 mm

Polypenschnürer, Ohrzängchen
Snares, Ear Forceps
Cierra-nudos, Pinzas auriculares
Serranodi, Pinze auricolari



KRAUSE
45220-16
16 cm, 6 1/4"

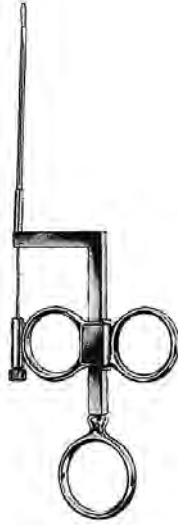

WILDE
45222-17
17 cm, 6 3/4"



45225-02
doz./doc./dozz.
0,2 mm

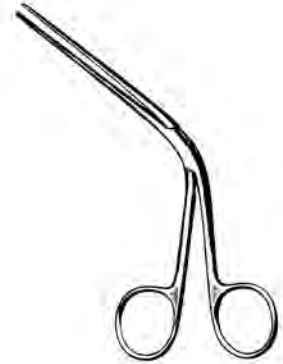

TILLEY
45243-14
14 cm, 5 1/2"



LITTAUER
45245-12
12 cm, 4 3/4"

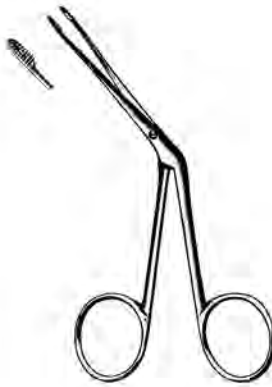

HARTMANN
45246-12
12 cm, 4 3/4"



HARTMANN
45246-14
14 cm, 5 1/2"

Mikro-Ohrscheren, Mikro-Ohrzängchen
Micro Ear Scissors, Micro Ear Forceps
 Tijeras auriculares micro, Pinzas auriculares micro
 Forbici auricolari micro, Pinze auricolari micro

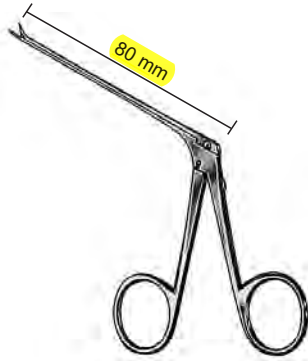

45310-40 - 45322-70

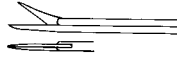

A
 BELLUCCI
 45310-40
 micro mini
 4 mm



A
 BELLUCCI
 45312-55
 micro standard
 5,5 mm

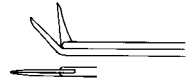

D
 BELLUCCI
 45313-55
 micro standard
 5,5 mm

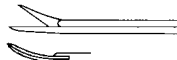

B
 BELLUCCI
 45315-55
 micro standard
 5,5 mm

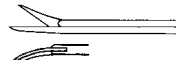

C
 BELLUCCI
 45317-55
 micro standard
 5,5 mm



A
 SHEA
45320-70
 7,0 mm

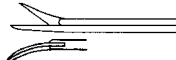

C
 SHEA
 45321-70
 7,0 mm



B
 SHEA
 45322-70
 7,0 mm

- A:** gerade / **straight** / recta / retta
B: rechts / right / derecha / destra
C: links / left / izquierda / sinistra
D: aufgebogen / curved up / curva in alto / curva hacia arriba
E: nach unten gebogen / curved down / curva in basso / curva hacia abajo

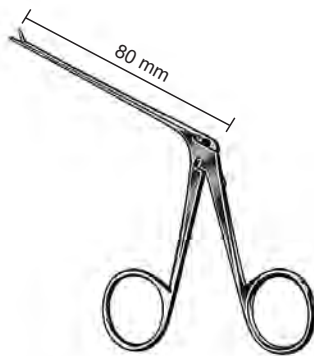

45350-40 - 45360-35



A
 45350-40
 4 mm



A
 45350-70
 7 mm



A
 45352-40
 4 mm



C
 45353-60
 6 mm



B
 45355-60
 6 mm



D
 45357-40
 4 mm



E
 45359-40
 4 mm



A
 45360-35
 3,5 mm

Mikro-Ohrzängchen, Hammerkopfstanze

Micro **Ear Forceps**, Malleus punch

Pinzas auriculares micro, Pinza saca-bocadas para cabeza de martillo

Pinze auricolari micro, Pinze taglianti per testa del martelletto taglio a scalpello

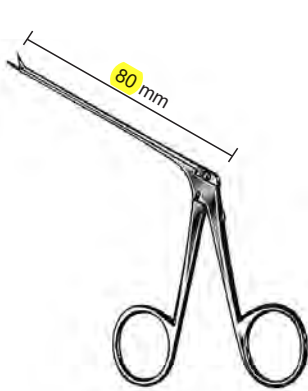

45362-45 - 45383-30



A
45362-45
4,5 mm



C
45363-45
4,5 mm



B
45365-45
4,5 mm

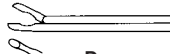

D
45367-50
5,0 mm



E
45369-50
5,0 mm

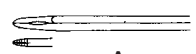

A
GREVEN
45370-50
5,0 mm

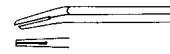

McGEE
45371-40
0,8x4,0 mm



COS
45373-30
1,8x0,8x3,0 mm



JUERS
45375-60
6,0 mm



JUERS
45377-60
6,0 mm



B
HAUGH
45383-30
45° 3 mm

- A:** gerade / straight / recta / retta
B: rechts / right / derecha / destra
C: links / left / izquierda / sinistra
D: aufgebogen / curved up / curva in alto / curva hacia arriba
E: nach unten gebogen / curved down / curva in basso / curva hacia abajo

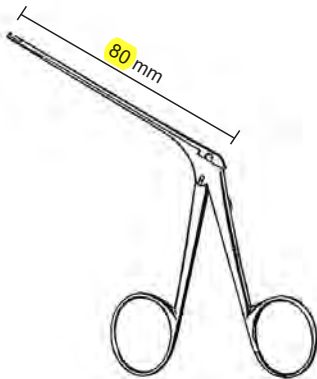

DIETER
45385-01 - 45387-02

micro ø 1,3 mm



45385-01

aufwärts
upward
arriba
in alto

mini ø 1,8 mm

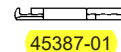

45387-01



45385-02

abwärts
downward
abajo
in basso

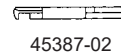

45387-02

Mikro-Ohrzängchen
 Micro Ear Forceps
 Pinzas auriculares micro
 Pinze auricolari micro



WULLSTEIN

45400-01
0,9 x 1 mm45400-02
0,8 x 1,3 mm45400-03
1 mm45401-25
1,7 x 2,5 mm45402-10
0,9 x 1 mm45403-13
0,8 x 1,3 mm45404-13
0,8 x 1,3 mm

Dissektoren, Küretten, Elevatoren, Mikro-Meßsonde
 Dissectors, Curettes, Elevators, Micro measuring rod
 Dissectores, Curetas, Elevadores, Sonda para medir
 Dissettori, Curette, Elevatori, Sonda auricolare per misurare

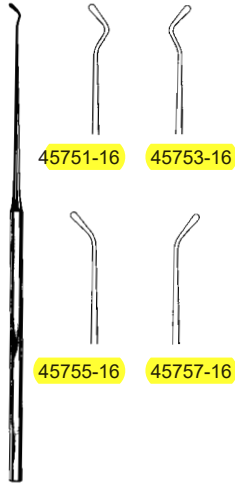

45751-16

45753-16

45755-16

45757-16

FISCH

45751-16 - 45757-16

16 cm, 6 1/4"

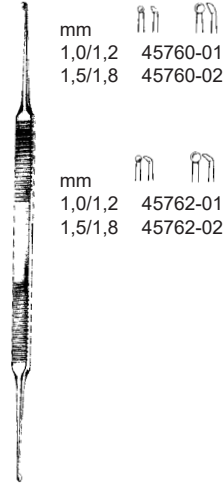

mm
 1,0/1,2 45760-01
 1,5/1,8 45760-02

mm
 1,0/1,2 45762-01
 1,5/1,8 45762-02

HOUSE

45760-01 - 45762-02

15 cm, 6"

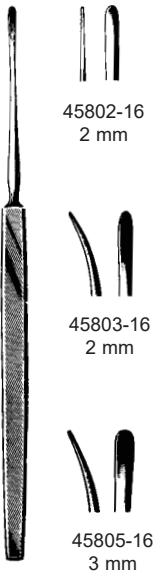

45802-16
 2 mm

45803-16
 2 mm

45805-16
 3 mm

LEMPERT

45802-16 - 45805-16

16 cm, 6 1/4"

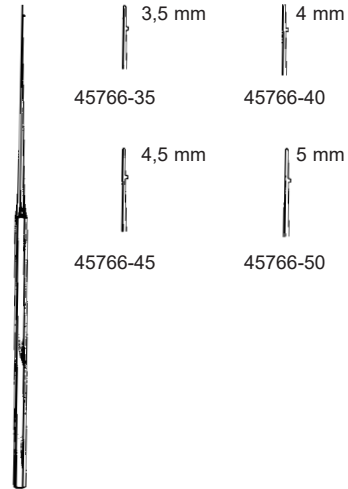

3,5 mm
 45766-35

4 mm
 45766-40

4,5 mm
 45766-45

5 mm
 45766-50

HOUSE

45766-35 - 45766-50

16 cm, 6 1/4"

Nasenspekula
Nasal Specula
Especulos nasales
Specoli nasali



THUDICHUM
47050-01 - 47050-07

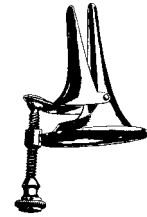
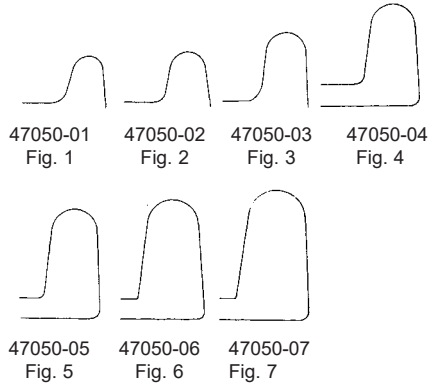

VOLTOLINI
47060-01 - 47060-03



HARTMANN-HALLE
47102-01 - 47102-03
15 cm, 6"

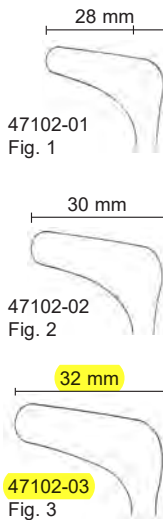

leichtes Modell
lightweight
mod. ligero
mod. leggero

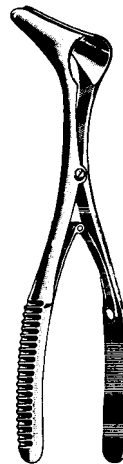

	Mod. WIEN	
Baby, bébé	47112-01	25 mm
Kind, child, niño, bamb.	47112-02	30 mm
Erwachs., Adult, adulto	47112-03	35 mm

Mod. WIEN
47113-03

Nasenspekula, Kehlkopfspiegel
 Nasal Specula, Laryngeal Mirrors
 Espéculos nasales, espejos laríngeos
 Specoli nasali, Specchi laringei

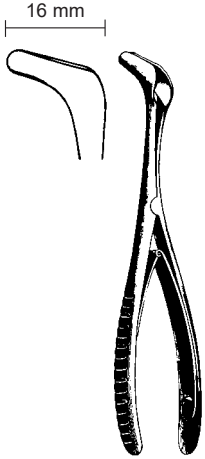

TIECK-HALLE
 47116-13
 13,5 cm, 5 1/4"



REDA
 47118-13
 12,5 cm, 5"

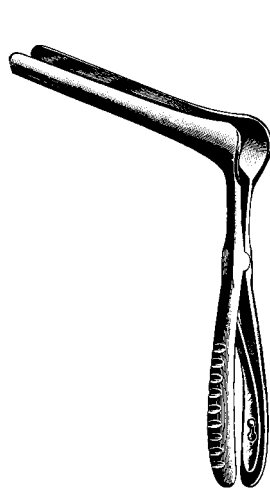

KILLIAN
 47120-35 - 47120-90
 13 cm, 5 1/8"



47120-35
 35 mm
 47120-50
 50 mm
 47120-75
 75 mm
 47120-90
 90 mm



COTTLE
 14 cm, 5 1/2"

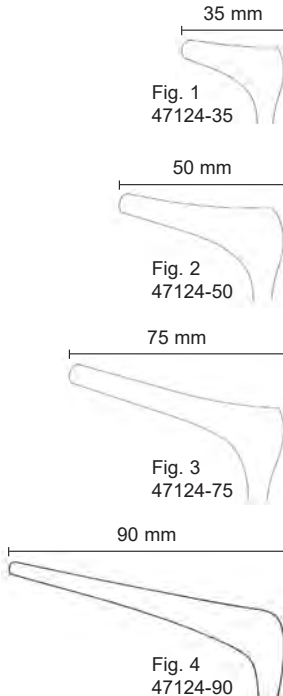

Fig. 1
 47124-35

Fig. 2
 47124-50

Fig. 3
 47124-75

Fig. 4
 47124-90



MICHEL
 47139-12 - 47139-18
 25 cm, 10"

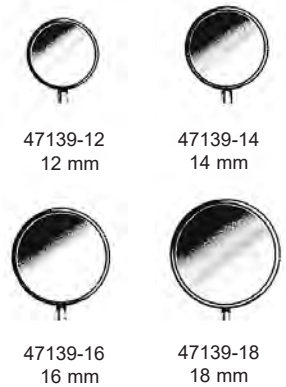

47139-12
 12 mm

47139-14
 14 mm

47139-16
 16 mm

47139-18
 18 mm

Nasenpinzetten, Polypenzange
 Ear Dressing Forceps, Ear Polypus Forceps
 Pinzas auriculares, Pinzas para pólipos
 Pinze auricolari, Pinze per polipi

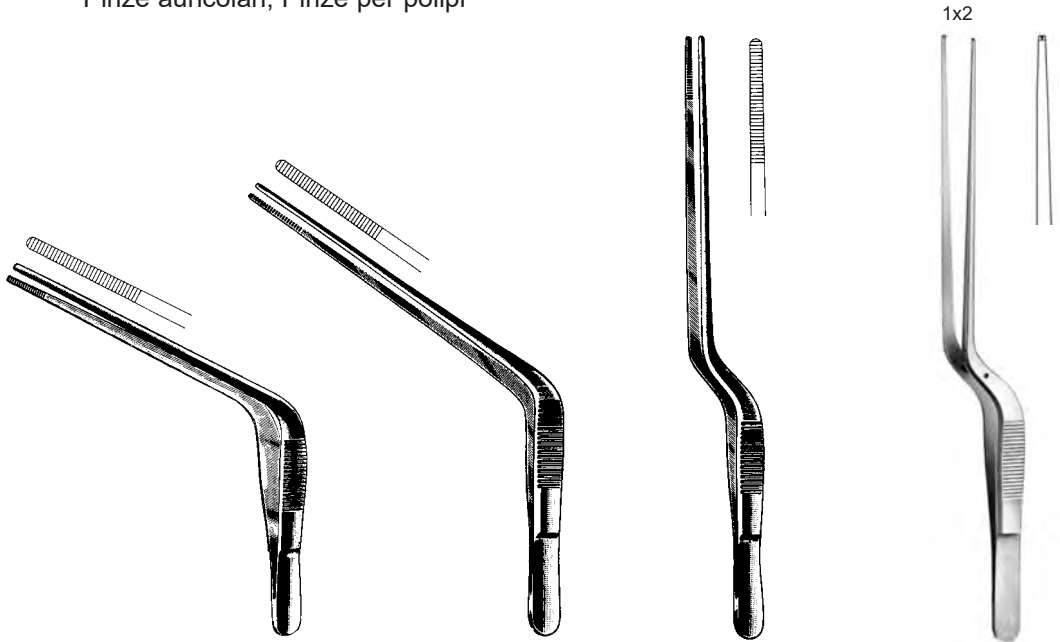

TROELTSCH
 47151-15
 15 cm, 6"

TROELTSCH
 47151-18
 18 cm, 7"

JANSEN-GRUENWALD
 47154-18 18 cm, 7"
 47154-20 20 cm, 8"

JANSEN
 47155-20
 20 cm, 8"

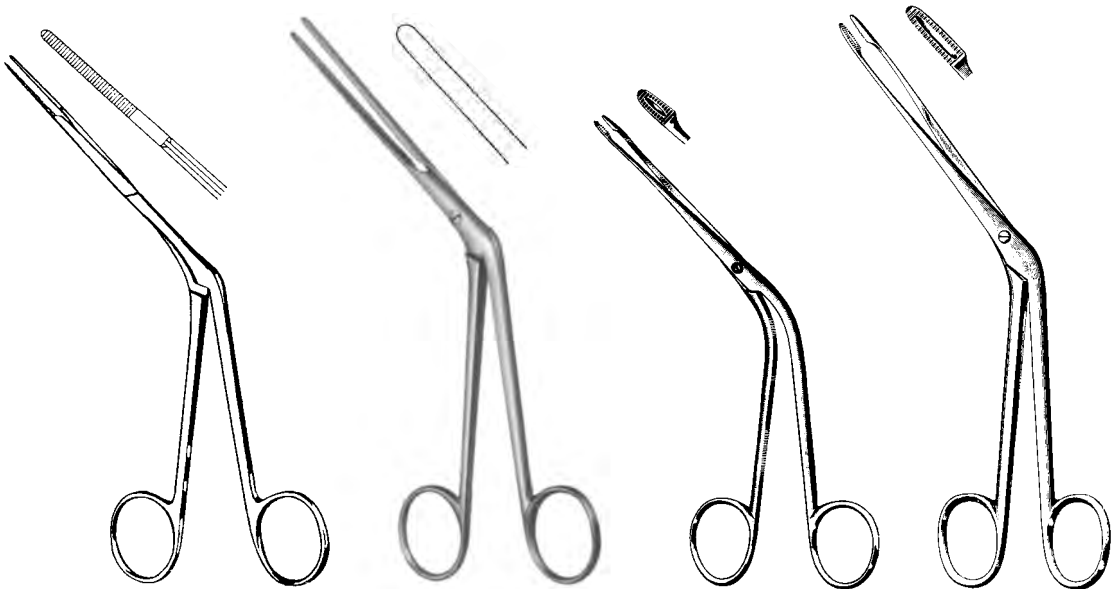

WESTMACOTT
 47158-20
 20 cm, 8"

LUBET-BARBON
 47159-20
 20 cm, 8"

HARTMANN
 47161-16
 16 cm, 6 1/4"

HARTMANN
 47161-20
 20 cm, 8"

Scharfe Nasenzangen, Septumzangen
 Nasal Cutting Forceps, Septum Forceps
 Pinzas cortantes nasales y para el tabique nasal
 Pinze taglianti nasali, Pinze per il setto nasale



CRAIG
 47192-18
 18 cm, 7"

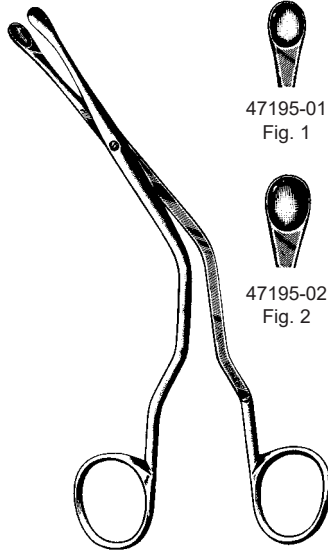

LUC
 47195-01 - 47195-02
 19 cm, 7 1/2"

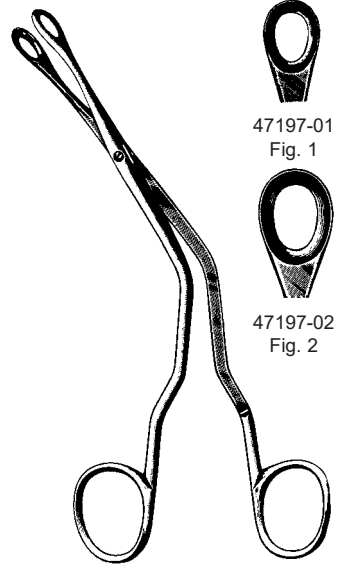

LUC
 47197-01 - 47197-02
 19 cm, 7 1/2"



Fig. 1
 47223-01
 3,0 mm

Fig. 2
 47223-02
 3,6 mm

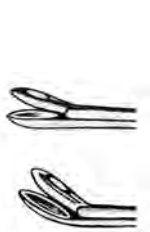

Fig. 0 47223-00	Fig. 1 47223-01	Fig. 2 47223-02
2,5 mm	3,0 mm	3,6 mm
47224-00	47224-01	47224-02

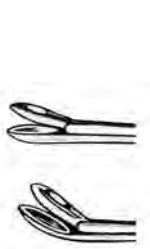
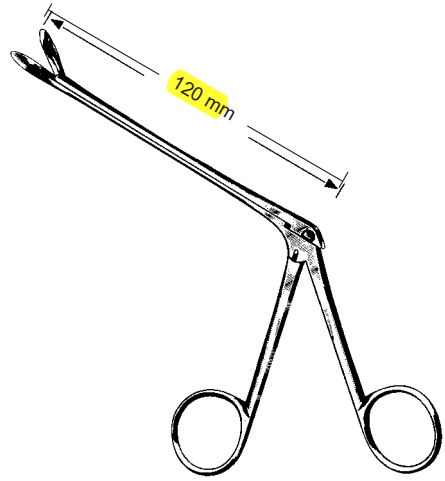
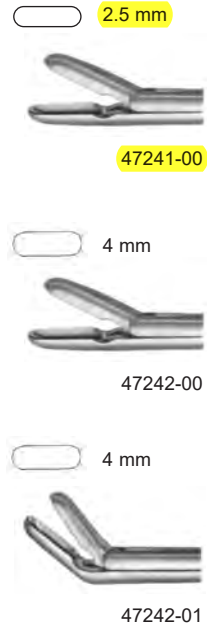
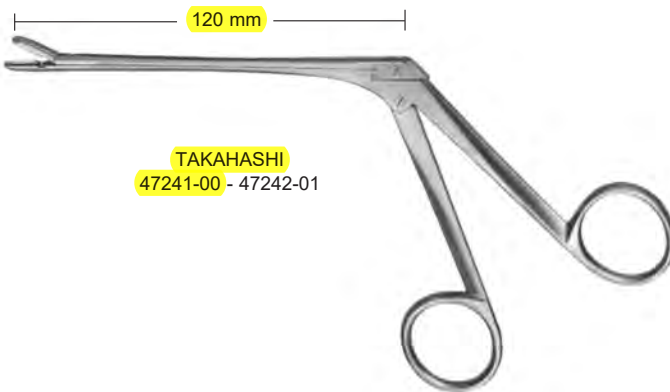
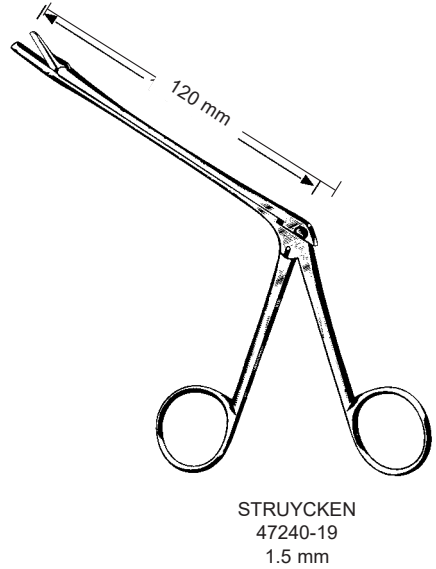
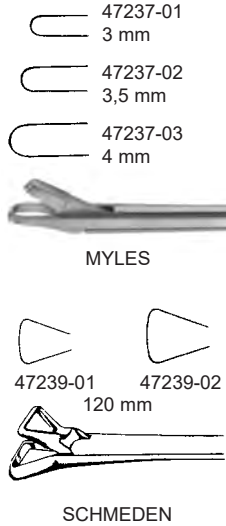
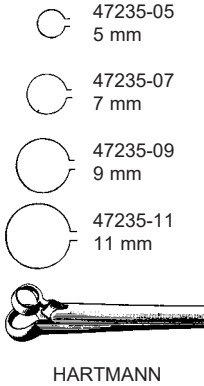

Fig. 3 47223-03	Fig. 4 47223-04	Fig. 5 47223-05
4,2 mm	4,8 mm	5,8 mm
47224-03	47224-04	47224-05



WEIL-BLAKESLEY
 47223-01 - 47224-05

Scharfe Nasenzangen
 Nasal Cutting Forceps
 Pinzas cortantes nasales
 Pinze taglianti nasali



Kieferhöhlenstanze, Nasenschere
 Antrum Punch Forceps, nasal scissors
 Pinzas cortantes para maxilares, tijera nasal
 Pinze sfenoidali, forbici nasali



47304-01 5x3,5 mm

47304-03 5x4 mm



47304-02 5x3,5 mm

47304-04 5x4 mm



HAJEK-KOFLER
 47304-01 - 47304-04

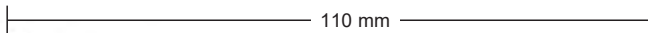

47305-02
 rechts gebogen
 right curved
 curva a la derecha
 curva a destra



47305-03
 links gebogen
 left curved
 curva a la izquierda
 curva a sinistra



47305-01
 gerade
 straight
 recta
 retta



Nasennmesser
 Nasal Knives
 Bisturies nasales
 Coltelli nasali

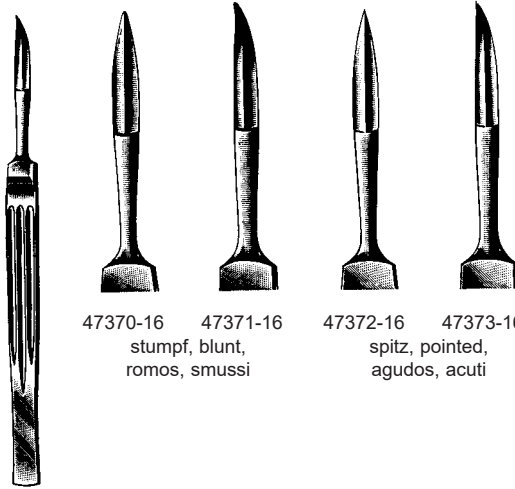

47370-16 47371-16
 stumpf, blunt,
 romos, smussi

47372-16 47373-16
 spitz, pointed,
 agudos, acuti

JOSEPH
 47370-16 - 47373-16
 16 cm, 6 1/4"



FREER
 47374-16
 16,5 cm, 6 1/2"



FREER
 47375-19
 19 cm, 7 1/2"

Zungendrucker, Wangen- und Lippenhalter, Zungenzangen
 Tongue Depressor, Cheek and Lip Retractor, Tongue Holding Forceps
 Baja-lenguas, Separadores para labios y mejillas, Pinza tira-lenguas
 Abassalingua, Divaricatori per guance e labbra, Pinza tiralingua

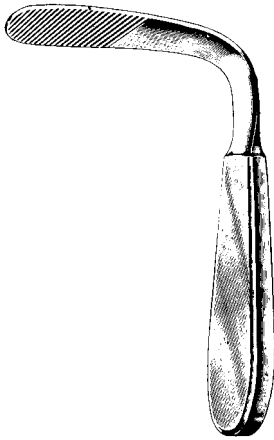

TOBOLD
 49119-14
 14,5 cm, 5 3/4"

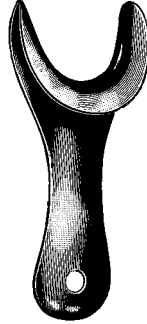

49230-11
 11 cm, 4 3/8"

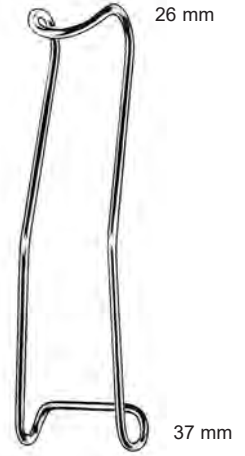

STERNBERG
 49231-12 12 cm, 4 3/4"
 49231-14 14 cm, 5 1/2"
 49231-16 16 cm, 6 1/4"



49235-19
 19 cm, 7 1/2"

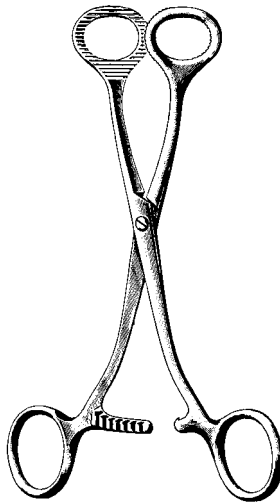

COLLIN
 49250-16 16 cm, 6 1/4"
 49250-18 18 cm, 7"

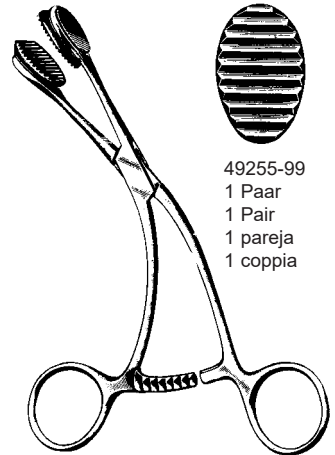

49255-99
 1 Paar
 1 Pair
 1 pareja
 1 coppia
 YOUNG
 49255-16
 16 cm, 6 1/4"

Ligaturklemmen
Ligature clamps
Pinzas clamps para ligaduras
Pinze per legature

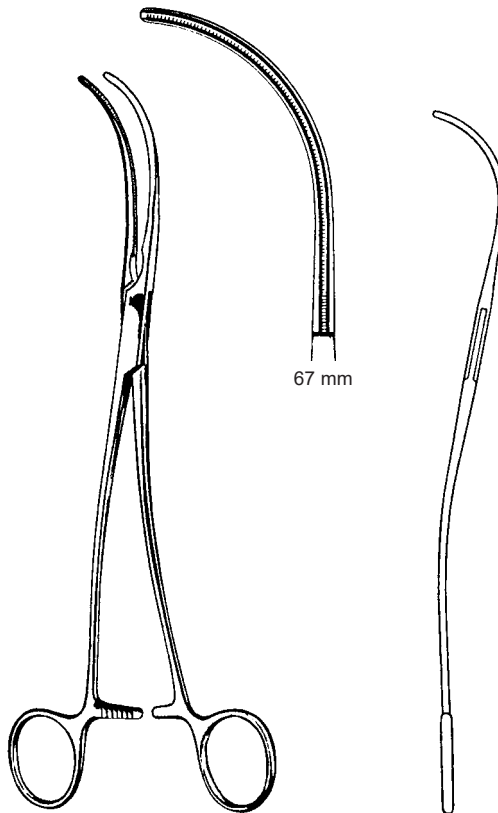

67 mm

DE BAKEY
61022-24
24 cm, 9 1/2"

Ligaturklemme
Ligature clamp
Pinzas clamps para ligaduras
Pinze per legature

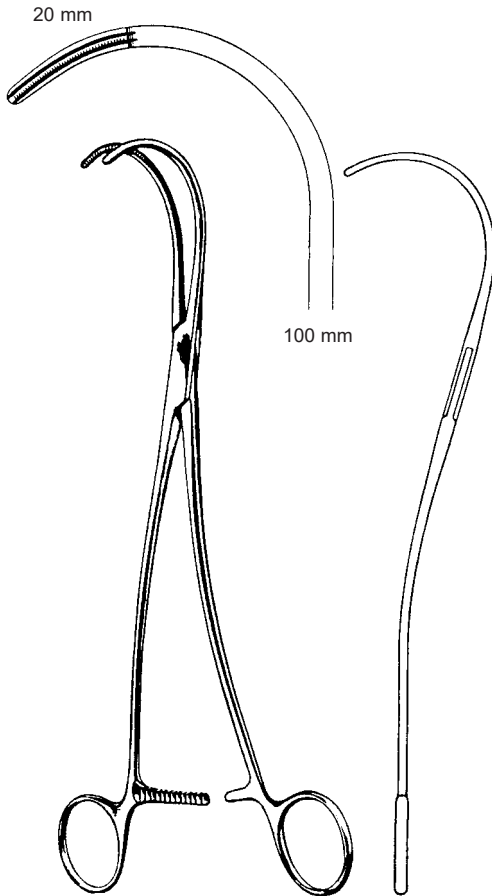

DE BAKEY
61023-25
25 cm, 10"

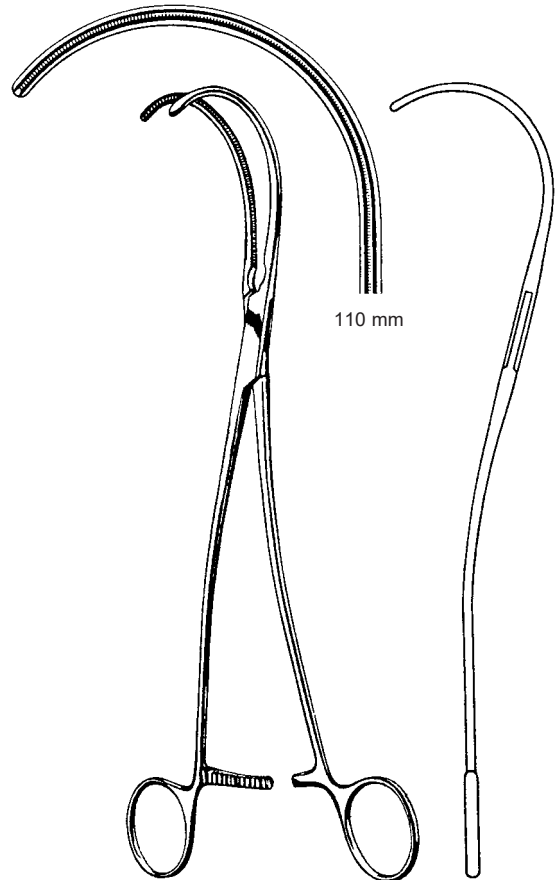

DE BAKEY
61023-26
26 cm, 10 1/4"

Aorta- und Aneurysmaklemme
 Aortic- and Aneurysm Clamps
 Pinzas aórticas y para aneurisma
 Pinze per aorta e per aneurisma

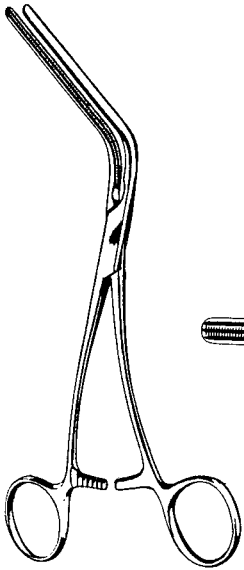

MORRIS-DE BAKEY
 61032-18 - 61032-25

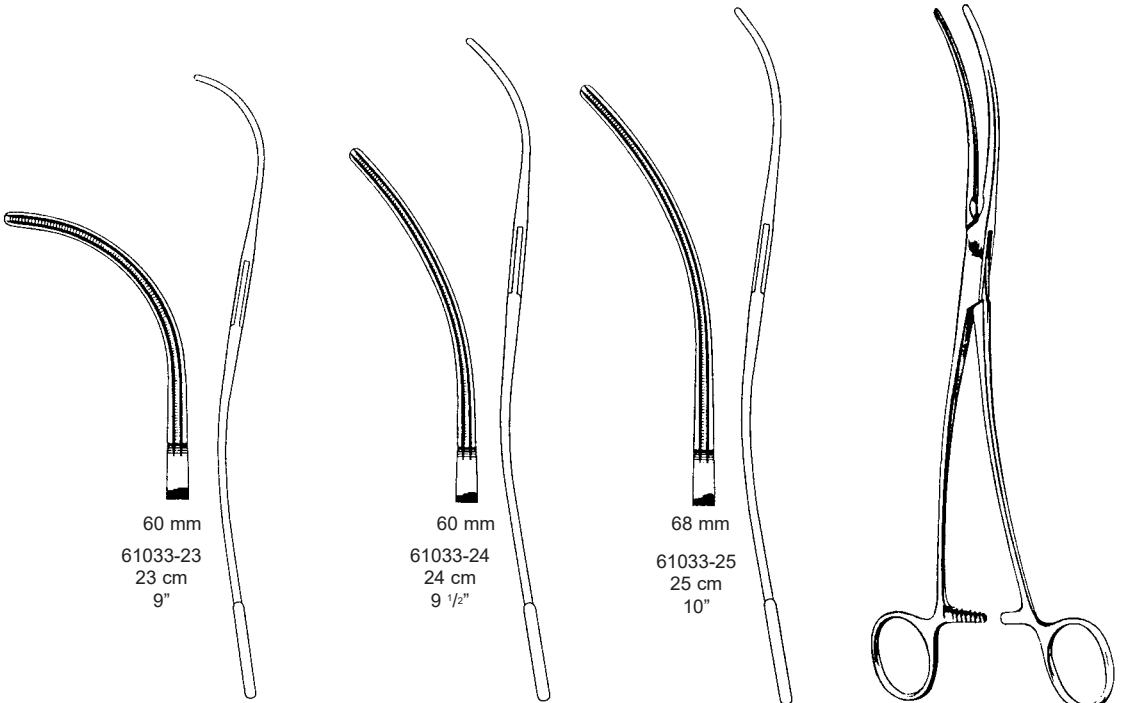
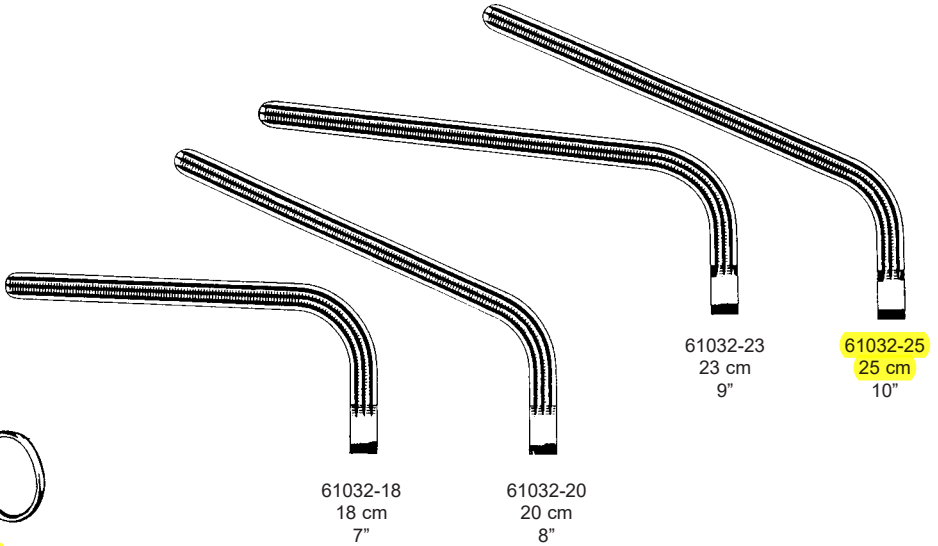

DE BAKEY-BAHNSON
 61033-23 - 61033-25

Atrauma

Mehrzweck-Gefäßklemmen, Anastomosenklemmen
 Multi purpose Vascular Clamps, Anastomosis Clamps
 Pinzas vasculares de usos múltiples, Pinzas para anastomosis
 Pinze vascolari universali, Pinze per anastomosi

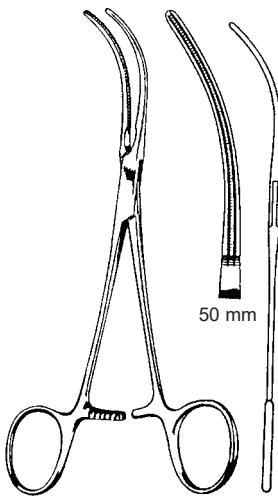

GLOVER
 61149-17
 17 cm, 6 3/4"

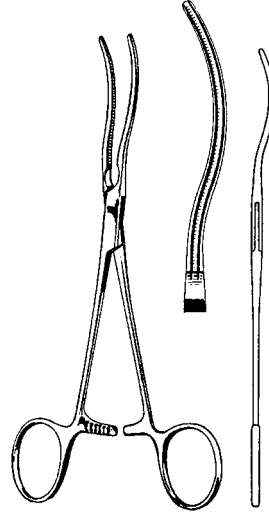

GLOVER
 61151-17
 17 cm, 6 3/4"

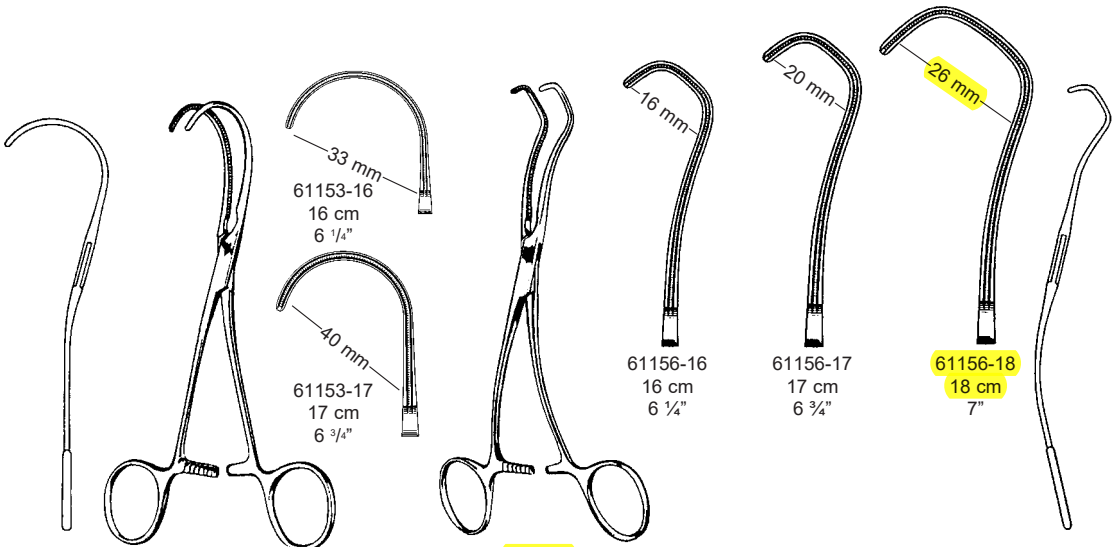

DE BAKEY
 61153-16 - 61153-17

DERRA
 61156-16 - 61156-18

Anastomosenklemmen, Kinder-Gefäßklemmen
 Anastomosis Clamps, Pediatric Vascular Clamps
 Pinzas para anastomosis, Pinzas vasculares pediátricas
 Pinze per anastomosi, Pinze vascolari pediatriche

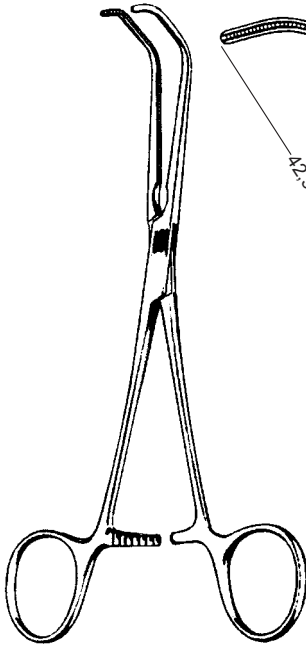

DE BAKEY-BECK
 61157-17 17 cm, 6 3/4"

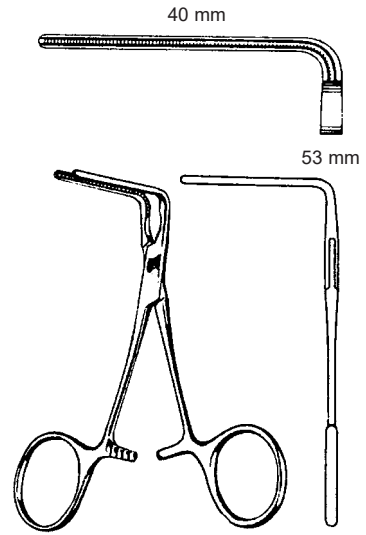

DE BAKEY
 61158-10 10 cm, 4"

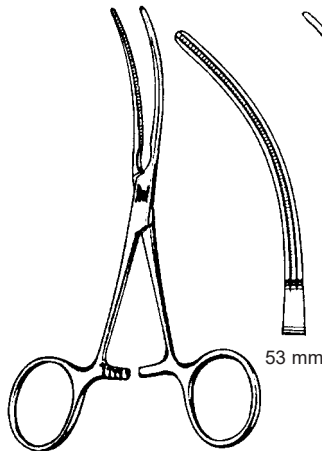

DE BAKEY
 61158-11 11 cm, 4 3/8"

Gallensteinsonden, Gallengangdilatoren

Gall Stone Probes, **Bile duct dilators**

Exploradores para cálculos biliares, Dilatadores para conductos biliares

Sonde per calcoli biliari, Dilatatori per condotti biliari

biegsam
malleable
maleable
malleabile

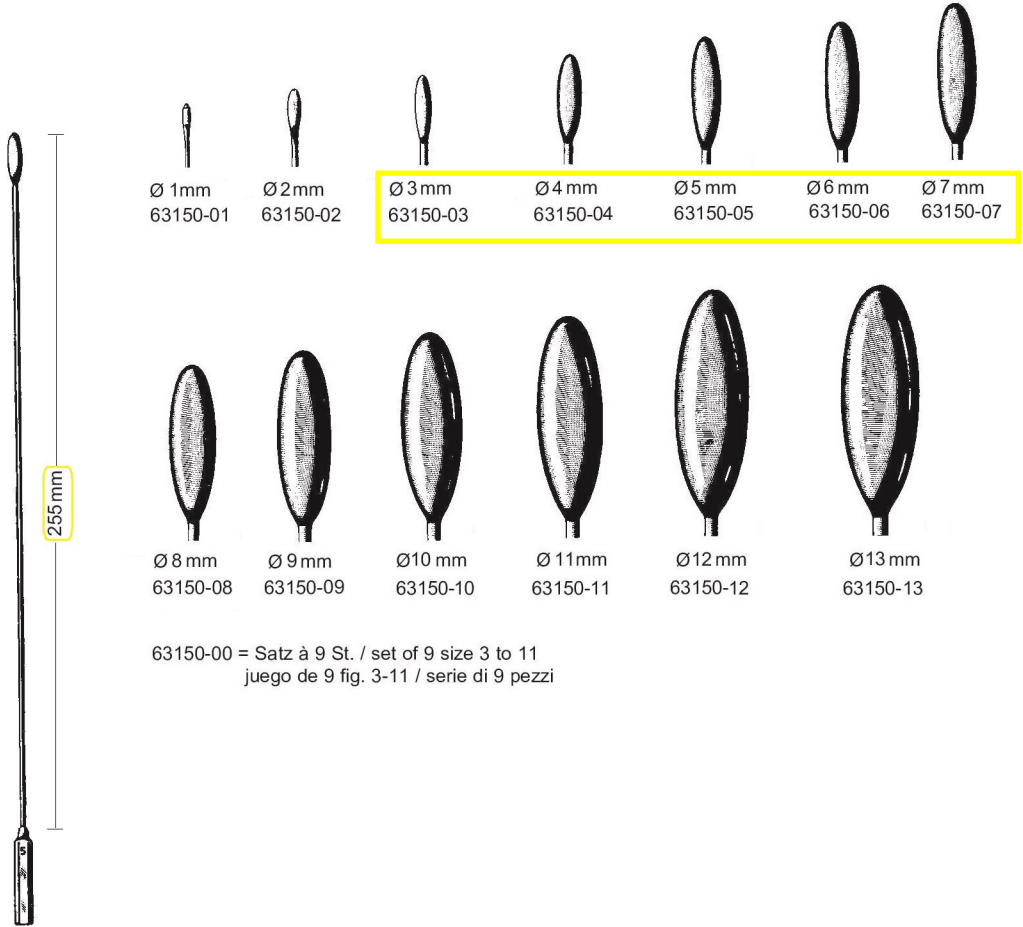

Ø 1mm
63150-01

Ø 2mm
63150-02

Ø 3mm
63150-03

Ø 4mm
63150-04

Ø 5mm
63150-05

Ø 6mm
63150-06

Ø 7mm
63150-07

Ø 8mm
63150-08

Ø 9mm
63150-09

Ø 10mm
63150-10

Ø 11mm
63150-11

Ø 12mm
63150-12

Ø 13mm
63150-13

63150-00 = Satz à 9 St. / set of 9 size 3 to 11
juego de 9 fig. 3-11 / serie di 9 pezzi

BAKES

63150-01 - 63150-13
30 cm, 11 3/4"

Uterus Biopsiezangen
 Biopsy Specimen Forceps
 Pinzas sacabocado p. biopsia
 Pinze per biopsia

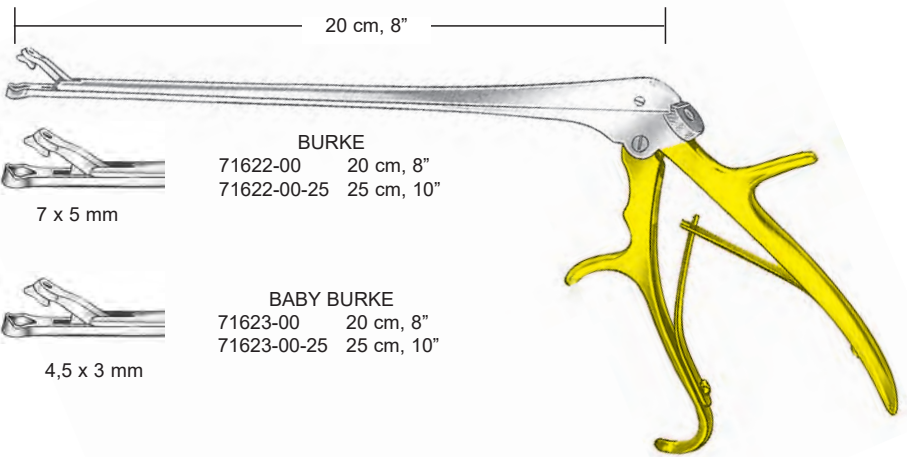
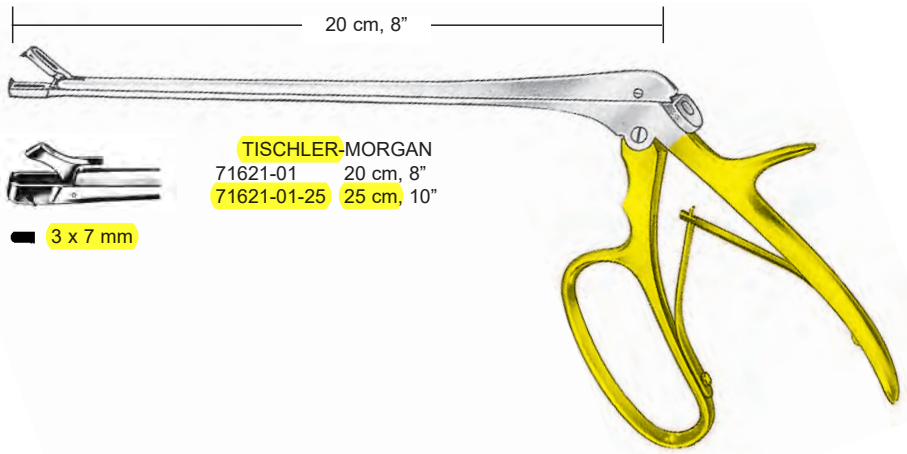
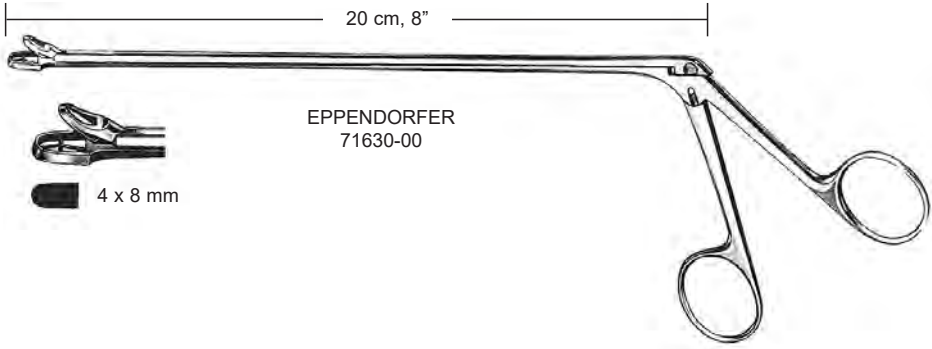

Kappenzangen, Nadel-Sterilisierkästen
 Sterilizing Forceps, Needle Sterilizing cases
 Combinacion tapa-pinza, Estuches para esterilizar agujas
 Pinza coperchio, Scatole per sterilizzare aghi

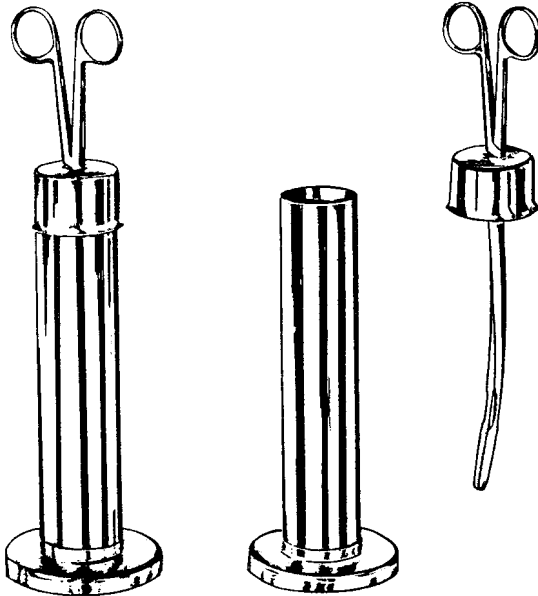

89111-25 25 cm, 10"
 89111-32 32 cm, 12^{3/4}"



89112-65
 65 x 15 mm



89113-65



89114-00
 150 x 95 x 13 mm

Schüsseln
Bowls
Cubetas
Scodelle



18/10
Stainless Steel
Acero inoxidable
Acciaio inossidabile

matt
satin finish
pulidas mate
opaco



Abmessungen in mm sizes in mm Tamaños en mm misura in mm		Inhalt capacity capacidad capacità	
Ø x h	oz	l	
40 x 19	2	0,05	89127-04
61 x 30	3	0,07	89127-06
80 x 40	5	0,14	89127-08
116 x 50	12	0,35	89127-11
128 x 55	16	0,45	89127-12
147 x 65	25	0,70	89127-14
167 x 75	39	1,10	89127-16
187 x 85	57	1,60	89127-18

Abmessungen in mm sizes in mm Tamaños en mm misura in mm		Inhalt capacity capacidad capacità	
Ø x h	l		
100x30	0,15	89129-11	



	mm x mm	l
89133-16	165 x 60	0,75
89133-17	175 x 70	1,00
89133-22	220 x 80	2,00
89133-24	240 x 110	3,00
89133-31	310 x 120	6,00
89133-34	345 x 125	8,50
89133-38	380 x 130	11,00



89139-17	170 mm	0,25 l
89139-20	200 mm	0,35 l
89139-25	250 mm	0,5 l
89139-27	275 mm	0,75 l

Monopolare Pinzetten
 Monopolar Forceps
 Pinzas monopolares
 Pinze monopolare



ohne Buchse
 without socket
 sin casquillo
 senza presa



91800-18 18 cm, 7"
 91800-21 21 cm, 8 1/4"
 91800-25 25 cm, 10"

1 x 2 teeth



91900-18 18 cm, 7"
 91900-21 21 cm, 8 1/4"
 91900-25 25 cm, 10"



91801-18 18 cm, 7"
 91801-21 21 cm, 8 1/4"
 91801-25 25 cm, 10"

mit Buchse
 with socket
 con casquillo
 con presa



Knochenhebel
 Bone Levers
 Elevadores para huesos
 Elevatori per ossa

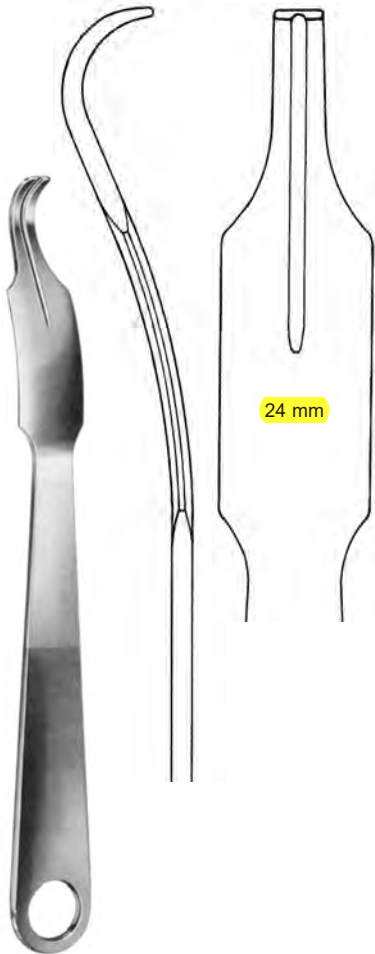

LANGE-HOHMANN
 33810-24
 25 cm, 10"

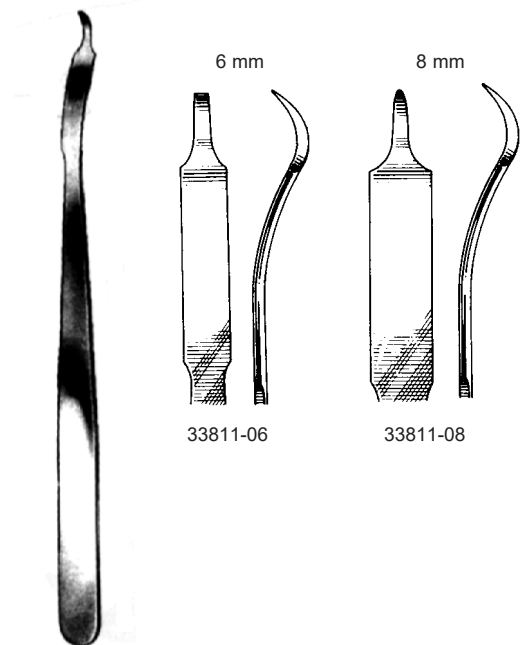

HOHMANN mini
 16 cm, 6 1/4"

Septum Elevatoren
Septum Elevators
Elevadores para el tabique
Elevatori per setto

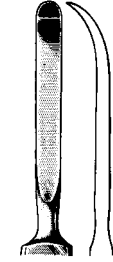
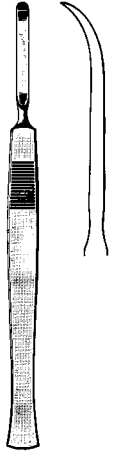

47410-04
4 mm

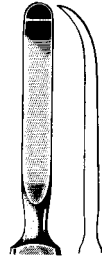

47410-05
5 mm



HALLE
47410-16
16.5 cm, 6 1/2"



JOSEPH
47411-16
16 cm, 6 1/4"

McKENTY
47410-04 - 47410-05
15 cm, 6"

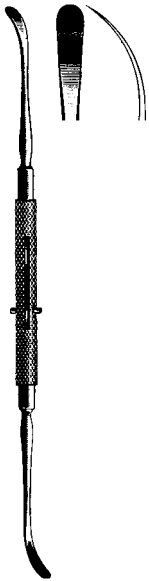

ROGER
47413-19
19 cm, 7 1/2"



MASING
47414-21
22 cm, 8 3/4"

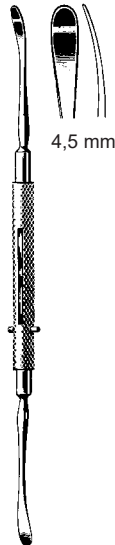

FREER
47415-18
18 cm, 7"

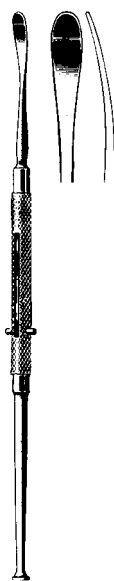

FREER
47417-19
19 cm, 7 1/2"

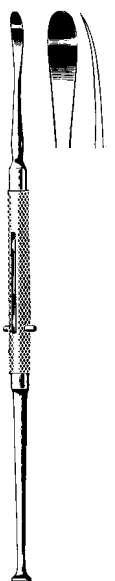

FREER
47419-19
19 cm, 7 1/2"

Wundsperrer
Retractors
Separadores
Divaricatori



ADSON
19682-26 - 19683-26
26,5 cm, 10 1/2"

spitz
sharp
agudo
acuto

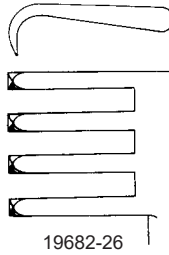

19682-26

stumpf
blunt
romo
smusso

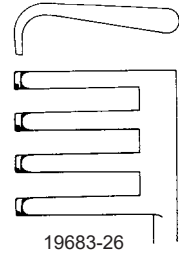

19683-26

- 19684-14 14 cm, 5 1/2"
- 19684-16 16 cm, 6 1/4"
- 19684-20 20 cm, 8"
- 19684-26 26 cm, 10 1/4"

spitz
sharp
agudo
acuto

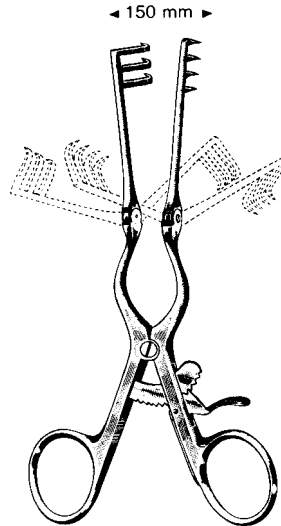

ADSON

- 19685-14 14 cm, 5 1/2"
- 19685-16 16 cm, 6 1/4"
- 19685-20 20 cm, 8"
- 19685-26 26 cm, 10 1/4"

stumpf
blunt
romo
smusso



Weitere Kataloge und Prospekte
Other catalogues and prospects

HNO / Sinuskopie
ENT / Sinuscopy

Sterilisations Behälter
Sterilization Container System

Endoskopie
Endoscopy

Urologie / Arthroskopie
Urology / Arthroscopy

Plastische Chirurgie
Plastic surgery

Orthopädie
Orthopedic

Titan Instrumente
Titanium Instruments

Neurochirurgie
Neurosurgery

REDA Instrumente GmbH
Gänsäcker 34, D-78532 Tuttlingen
Tel: 0049 (0) 7462 9445 0
Email: info@reda-instrumente.de
Web: www.reda-instrument.de