

ELECTRICITY METERS
TYPES NIK 2300...P1..., NIK 2300...P3..., NIK 2300...P6...,
OPERATIONS MANUAL
ААШХ.411152.073 OM

Content

1. General information	3
1.1. Compliance with standards	3
2. Description of meters and the principle of their operation.....	3
2.1. Designation	3
2.2. Functionality of meters	4
2.3. Versions of meters	5
2.4. Measured parameters	8
2.5. Technical characteristics of meters	9
2.6. Resistance to mechanical influences and ignition.....	11
2.7. Operating conditions requirements	11
2.8. Composition of meters	11
2.8.1. Appearance of meters.....	11
2.8.2. Meter case design.....	13
2.8.3. Measuring elements	14
2.8.4. Data storage	14
2.8.5. View button.....	14
2.8.6. Function button	14
2.8.7. Calendar and clock.....	15
2.8.8. Indicators.....	15
2.8.9. Load control relay	15
2.8.10. Sensors	15
2.8.11. Description of LED.....	15
2.8.12. Power supply of meters	17
2.8.13. Meter interfaces.....	17
2.9. Operation principle of the meter	18
2.9.1. Measurement.....	18
2.9.2. Parameterization of meters.....	18
2.9.3. Rate module	19
3. Protection of meters from unauthorized interference.....	21
3.1. Constructive means of protection	21
3.1. Registration of opening of a terminal cover and a casing	22
3.2. Sealing of the function button	22
3.3. Software protection of access to the accumulated data.....	22
3.4. Registration of external influences.....	23
4. Marking.....	23
4.1. Description of the design of the nameplate of the NIK 2300...P1...	24
5. Delivery set	25
6. Packing.....	25
7. Intended use	26
7.1. Preparation of the meter for use and installation procedure.....	26
7.2. Backup battery	27
7.3. Using the meter	28
7.4. Data reading	28
7.4.1. Ways to read information.....	28
7.4.2. Options for reading data through interfaces.....	28
7.4.3. Readable data	28
7.4.4. Display of total energy and total power	29
7.5. Description of the windows displayed on the LCD	29
7.5.1. The order of changing windows.....	29
7.5.2. Indication of different operating modes of meters	30
7.5.3. Error and fault indication	30
7.5.4. Examples of displayed windows.....	31
8. Maintenance	32
8.1. General instructions	32
8.2. Instructions for safety precautions	32
9. Transportation and storage.....	32
9.1. Requirements for transportation and storage of the product.....	32
10. Requirements for environmental protection and disposal of the device	33
11. Manufacturer's warranties	33

Appendix A. Overall and installation dimensions	34
Appendix B. Wiring diagrams of meter interfaces	35
Appendix C. Schemes for connecting meters to the consumer network.....	36
Appendix D. Table of OBIS codes that can be displayed.....	37
Appendix E. Error codes.....	41
Appendix F. Scheme of the rate grid of the meter	42

1. General information

This operations manual (hereinafter - OM) applies to electricity meters of types NIK 2300...P1..., NIK 2300...P3..., NIK 2300...P6... (hereinafter - meters).

The OM considers the operation of meters, their intended use, maintenance, storage, and transportation.

Installation, dismantling, connection, and disconnection of the meter must be performed in accordance with the current rules of operation of electrical installations and safety, only by qualified personnel in accordance with the requirements of this document.

The organization authorized to perform the installation, maintenance, and dismantling of meters is fully responsible for the fact that its staff has carefully studied this manual, has sufficient qualifications to perform work, and strictly complies with local regulations on the safety and operation of electrical installations.

1.1. Compliance with standards

Table 1 lists the standards that meters types NIK 2300...P1..., NIK 2300...P3..., NIK 2300...P6... meet.

Table 1. Standards

EN 50470-1	Electricity metering equipment (a.c.) Part 1: General requirements, tests, and test conditions - Metering equipment (class indexes A, B, and C).
EN 50470-3	Electricity metering equipment (a.c.) - Part 3: Particular requirements - Static meters for active energy (class indexes A, B, and C).
EN 62053-23	Electricity metering equipment (a.c.) — Particular requirement — Part 23: Static meters for reactive energy (classes 2 and 3).
EN 62059-32-1	Electricity metering equipment — Dependability — Part 32-1: Durability — Testing of the stability of metrological characteristics by applying elevated temperature.
GOST 22261	Measuring instruments for electrical and magnetic quantities. General technical conditions.
IEC 60721-3-3	Classification of environmental conditions - Part 3-3: Classification of groups of environmental parameters and their severities - Stationary use at weather-protected locations.
IEC 62053-52	Electricity metering equipment (AC). Particular requirements. Part 52: Symbols.
GOST 12.1.004-91	System of labor safety standards. Fire Security. General requirements.

2. Description of meters and the principle of their operation

2.1. Designation

Electricity meters NIK 2300...P1..., NIK 2300...P3..., NIK2300...P6... (hereinafter referred to as meters) are designated for the metering of the electrical active or active and reactive energy and implementation of multi-rate accounting in three-phase four-wire AC circuits in communal and other spheres.

NIK 2300...P1..., NIK 2300...P3..., NIK2300... P6... meters are three-phase meters with an electronic display and three measuring elements, with direct connection by voltage and current. Meters are designed to measure active electric energy in the forward and reverse directions at one or more rates with accuracy class B (according to the requirements of EN 50470-3), as well as to measure reactive electric energy with accuracy class 2 (according to EN 62053-23).

The meters are equipped with an "optical port" interface and can be additionally equipped with an interface for remote data transmission, i.e. RS-485, first-generation PLC interface, or third-generation PLC G3 interface. The main test outputs are pulse test outputs, with contacts connected to special connectors.

Meters can be used in automatic electricity control and accounting systems.

The meters meet the requirements of the Technical Regulations of Legislatively Regulated Measuring Equipment, approved by the resolution of the Cabinet of Ministers of Ukraine on January 13, 2016, №94.

The design of the meters corresponds to the set of design documentation ААІІХ.411152.073.

According to climatic and mechanical requirements, the meter meets the requirements of EN 50470-1, EN 50470-3, and EN 62053-23.

The meter meets the requirements of EN 62059-32-1 according to the results of research on stability and metrological reliability.

Meters are made in various versions which differ in functionality and technical characteristics. Descriptions of meter versions are shown in Table 3, Table 4, and Table 5. The description of the technical characteristics of the meters is shown in Table 7.

2.2. Functionality of meters

Table 2 contains information about the functionality of the meters.

Table 2. Functions of the NIK 2300... P1... meters

Pulse test outputs with optical isolation.
Recognition and registration of interference (external magnetic and electromagnetic field, opening of the casing, and the terminal cover).
Real-time calendar and clock with a backup battery.
Interfaces: main - optical port, additional RS485 or PLC G3.
Rates grid: Number of rates - up to 4; Number of rate seasons - up to 12; Number of week profiles - up to 10; Number of day profiles - up to 16; Holidays - up to 30.
Energy measurement: Final registers; Instantaneous load values.
Indication of measured and stored data on the liquid crystal display.
Ability to navigate customized menus with the "View" button 

Use a lifetime backup battery.

Indication of the operation of the meter with optical indicators on the front panel of the meters.
--

2.3. Versions of meters

All meters use liquid crystal displays (hereinafter - LCD) as an electronic display. All meters have an optical port, pulse outputs, LED active or active and reactive energy measurement indicators, a case opening sensor, and a terminal cover opening sensor. All meters are equipped with a built-in backup battery. All meters are equipped with a "View" button, which is designed to control the menu of the meter display, and a programmable function button.

The main test outputs are pulse outputs with the contacts connected to special connectors. At the customer's request, an interface for remote data transmission can be additionally installed in the meters: RS-485, first-generation PLC interface, or third-generation PLC G3 interface. Also, the meter can be equipped with a load control relay (see Table 3, Table 4, Table 5), magnetic and (or) electromagnetic field sensors, and an additional external backup battery for multi-rate versions of the meter at the request of the customer.

The meter versions differ by the ability to measure reactive energy, the ability to measure energy at several rates, the presence and type of additional interface, the presence of magnetic and electromagnetic field sensors, the ability to measure active energy in the opposite direction, reference voltage, the number of measured values.

All possible versions of meters and the structure of their designations are shown in Table 3, Table 4, and Table 5.

Table 2. Designation of NIK 2300...P1... meter versions

NIK 2300	A	X	P1	X	2	X	0	X	X	X	X
	<i>Reference voltage</i>										
	1 3x220/380 V										
	2 3x230/400 V										
	3 3x240/416 V										
	<i>Ability to measure energy</i>										
	1 In the forward direction										
	2 In the forward and reverse direction										
	<i>Sensors</i>										
	0 Without sensors										
	M The magnetic field sensor is installed										
	C The electromagnetic field sensor is installed										
	MC Magnetic field and electromagnetic field sensors are installed										
	<i>Relay availability</i>										
	0 Without load control relay										
	2 The load control relay is installed										
	<i>The first interface availability</i>										
	0 The module is not installed										
	2 RS-485 interface is installed										
	8 PLC interface is installed										
9 PLC G3 interface is installed											
<i>The main interface availability</i>											
2 The meter with optical port and additional sealed function button											
T Indication of multi-rate meters											
<i>Wiring type</i>											
P1 Direct connection with rated and maximal current 5 (100) A											
<i>Type of the measured energy</i>											
R Measurement of the reactive energy											
A Measurement of the active energy											

Table 3. Designation of NIK 2300...P3... meter versions

NIK 2300	A	X	P3	2	X	0	X	X	X	X
										<i>Reference voltage</i>
										1 3x220/380 V
										2 3x230/400 V
										3 3x240/416 V
										<i>Ability to measure energy</i>
										1 In the forward direction
										2 In the forward and reverse direction
										<i>Sensors</i>
										0 Without sensors
										M The magnetic field sensor is installed
										C The electromagnetic field sensor is installed
										MC Magnetic field and electromagnetic field sensors are installed
										<i>Relay availability</i>
										0 Without load control relay
										<i>The first interface availability</i>
										0 The module is not installed
										2 RS-485 interface is installed
										8 PLC interface is installed
										9 PLC G3 interface is installed
										<i>The main interface availability</i>
										2 The meter with optical port and additional sealed function button
										<i>Wiring type</i>
										P3 Direct connection with rated and maximal current 5 (60) A
										<i>Type of the measured energy</i>
										R Measurement of the reactive energy
										A Measurement of the active energy

Table 4. Designation of NIK 2300...P6... meter versions

NIK 2300	A	X	P6	X	2	X	0	X	X	X	X
	<i>Reference voltage</i>										
	1 3x220/380 V										
	2 3x230/400 V										
	3 3x240/416 V										
	<i>Ability to measure the active energy</i>										
	1 In the forward direction										
	2 In the forward and reverse direction										
	<i>Sensors</i>										
	0 Without sensors										
	M The magnetic field sensor is installed										
	C The electromagnetic field sensor is installed										
	MC Magnetic field and electromagnetic field sensors are installed										
	<i>Relay availability</i>										
	0 Without load control relay										
2 The load control relay is installed											
<i>The first interface availability</i>											
0 The module is not installed											
2 RS-485 interface is installed											
8 PLC interface is installed											
9 PLC G3 interface is installed											
<i>The main interface availability</i>											
2 The meter with optical port and additional sealed function button											
T Indication of multi-rate meters											
<i>Wiring type</i>											
P6 Direct connection with rated and maximal current 5 (80) A											
<i>Type of the measured energy</i>											
R Measurement of the reactive energy											
A Measurement of the active energy											

2.4. Measured parameters

The list of parameters measured by the meter depends on its ability to measure electricity at several rates and the ability to measure reactive energy. The list is given in Table 6.

Table 6. Parameters measured by the meter

№	Measured parameters	AR	A
1.	Active energy (A+), kWt·h for each rate and in total for all rates*; in total for all phases.	+	+
2.	Active energy (A-), kWt·h for each rate and in total for all rates*; in total for all phases.	+	+
3.	Reactive energy (R +), kvar·h for each rate and in total for all rates*; total for all phases.	+	-

№	Measured parameters	AR	A
4.	Reactive energy (R -), kvar·h for each rate and in total for all rates*; total for all phases.	+	-
5.	Total energy S +, kVA·h in total for all phases.	+	
6.	Total energy S-, kVA · h for each phase and total for all phases.	+	
7.	Active energy A+ + A- , kWh at each rate and in total for all rates*; in total for all phases.	+	+
8.	Active energy A+ - A- , kWh at each rate and in total for all rates*; in total for all phases.	+	+
9.	Instantaneous voltage value for each phase, V.	+	+
10.	Instant value of current strength for each phase; total algebraic current strength for all phases, A.	+	
11.	The instantaneous value of the power factor cos φ for each phase and the total three-phase cos φ. The arrows show the quadrant of the located vector.	+	+
12.	Instantaneous frequency value for each phase, Hz.	+	+
13.	The instantaneous value of active power A + and A-, that passes through the meter for each phase and in total for all phases, kW.	+	+
14.	The instantaneous value of reactive power R + and R- passing through the meter for each phase and all phases, kvar.	+	-
15.	Total power S + and S- passing through the meter for each phase and in total for all phases, kVA.	+	-
16.	Active power A+ + A- and A+ - A- passing through the meter for each phase and all phases, kW.	+	+
17.	The current value of date and time.	+	+

Notes:

- * - parameters of multi-rate meters;
- The data in column AR refer to meters capable of measuring active and reactive energy, and the data in column A refer to meters capable of measuring only active energy.
- In AR and A columns, the “+” sign indicates that the corresponding parameter is being measured, and the “-” sign is not being measured.

2.5. Technical characteristics of meters

Overall and installation dimensions of meters are given in "Appendix A".

Schemes for connecting meter interfaces are given in "Appendix B", and schemes for connecting meters to the consumer network in "Appendix C".

A table of OBIS codes that can be displayed is given in the appendix "Appendix D".

The list of possible errors reported on the LCD is given in the appendix "Appendix E".

The main parameters of the meters are shown in Table 7.

Table 5. The main technical parameters

Parameter, characteristic	Value, description
Accuracy class for measurement of active energy (according to EN 50470-3)	B

Parameter, characteristic	Value, description
Accuracy class for measurement of reactive energy (according to EN 62053-23)	2
Reference voltage U_n , V	Subject to version (see Table 3, Table 4 and Table 5)
Voltage operating range, % of U_n	-20 to +15
Starting current, I_{st} A for active energy	12,5
Starting current, I_{st} A for reactive energy	15,6
Minimum current I_{min} , A	0,25
Transient current I_{tr} , A	0,5
Reference current, I_{ref} , A	5
Maximum current, I_{max} , A	100, 60. 80 (subject to meter type)
Reference frequency f_{ref} , Hz	50
Meter constant by default (active energy), imp/(kWh)	8000
Meter constant by default (reactive energy), imp/(kvar·h)	8000
Power consumption of meter without PLC interface in voltage circuits ($I = I_b$), less than, V·A (W)	10 (2)
Power consumption of meter with PLC interface in voltage circuits ($I = I_b$), less than, V·A (W)	20 (5)
Power consumption of meter in current circuits (at I_{ref}), less than, V·A	0,05
The default data rate of the optical port, baud	9600
The number of LCD digits to display basic information	6+2
Integration period (set during parameterization), minutes	1, 2, 5, 10, 15, 20, 30, 60
Number of rates, up to*	4
Number of rate seasons *	12
Number of week profiles *	10
Number of day profiles, up to *	16
Number of holidays, up to *	30
Storage of a load profile with the integration period of 60 minutes, days	180
Storage of data on consumed energy at all rates at the end of the day, days	180
Storage of data on consumed energy at all rates at the end of the month, months	48
Storage of average values of voltage on phases L1, L2, L3 with the integration period of 10 minutes, days	10
The maximum allowable voltage at the terminals of the pulse output in the open state, I_n	30
The maximum allowable current of the output circuit of the pulse output in the closed state, mA	30
The main absolute error of the built-in clock of the meter, s/day	± 0,5
Average failure time, not less than, hours	200 000
Mean lifetime, not less than, years	24
Verification interval, years	10
Working temperature range, °C	-40 to +70
Storage temperature range, °C	-40 to +70

Parameter, characteristic	Value, description
Relative humidity at a temperature +30 °C, not more than, %	95
Degree of protection	IP54
Mechanical class	M2
Electromagnetic class	E2
Overall dimensions, less than, mm	296x172x56
Weight, not more, kg	2

Notes:

- * Multi-rate meters only. (see Table 2, Table 3, Table 4).

2.6. Resistance to mechanical influences and ignition

On resistance to mechanical influences meters belong to group 4 in accordance with GOST 22261.

The degree of protection of the meter shell from the penetration of solid objects and water is IP 54 (according to GOST 14254).

The meter meets GOST 12.1.004-91 on fire safety requirements.

The material of the base, the terminal cover, and the cover of the board of the meter clamps corresponds to the standard UL94 - V0 - self-extinguishing for 10 seconds on a vertically mounted sample, with the possibility of the formation of drops of non-flammable particles.

The material of the meter casing complies with the standard UL94 - V2 - self-extinguishing for 30 seconds on a vertically mounted sample with the possibility of the formation of drops of burning particles.

2.7. Operating conditions requirements

The meters can be operated in areas with climate types "cold" and "cold temperature" in climatic conditions of category 3K7 according to the classification according to IEC 60721-3-3 (except for the possibility of condensation and ice formation in the environment where they are operated).

The meters are designed to be installed in an explosion-proof environment, without conductive dust, and aggressive gases. Meters can be placed in unheated rooms, as well as in outdoor cabinets, which provide protection against daily changes in climatic conditions and prevent moisture condensation and ice formation. It is forbidden to install meters in direct sunlight.

The value of relative humidity at 30 °C is not more than 95%.

Temperature range:

- operation - from minus 40 to plus 70 ° C;
- storage - from minus 40 to plus 70 ° C.

2.8. Composition of meters

2.8.1. Appearance of meters

An example of the appearance of meters and the location of controls is shown in Figure 1. For meters types NIK 2300... P1..., NIK 2300... P3... and NIK 2300... P6 ... the location of the elements shown in the figure is similar.

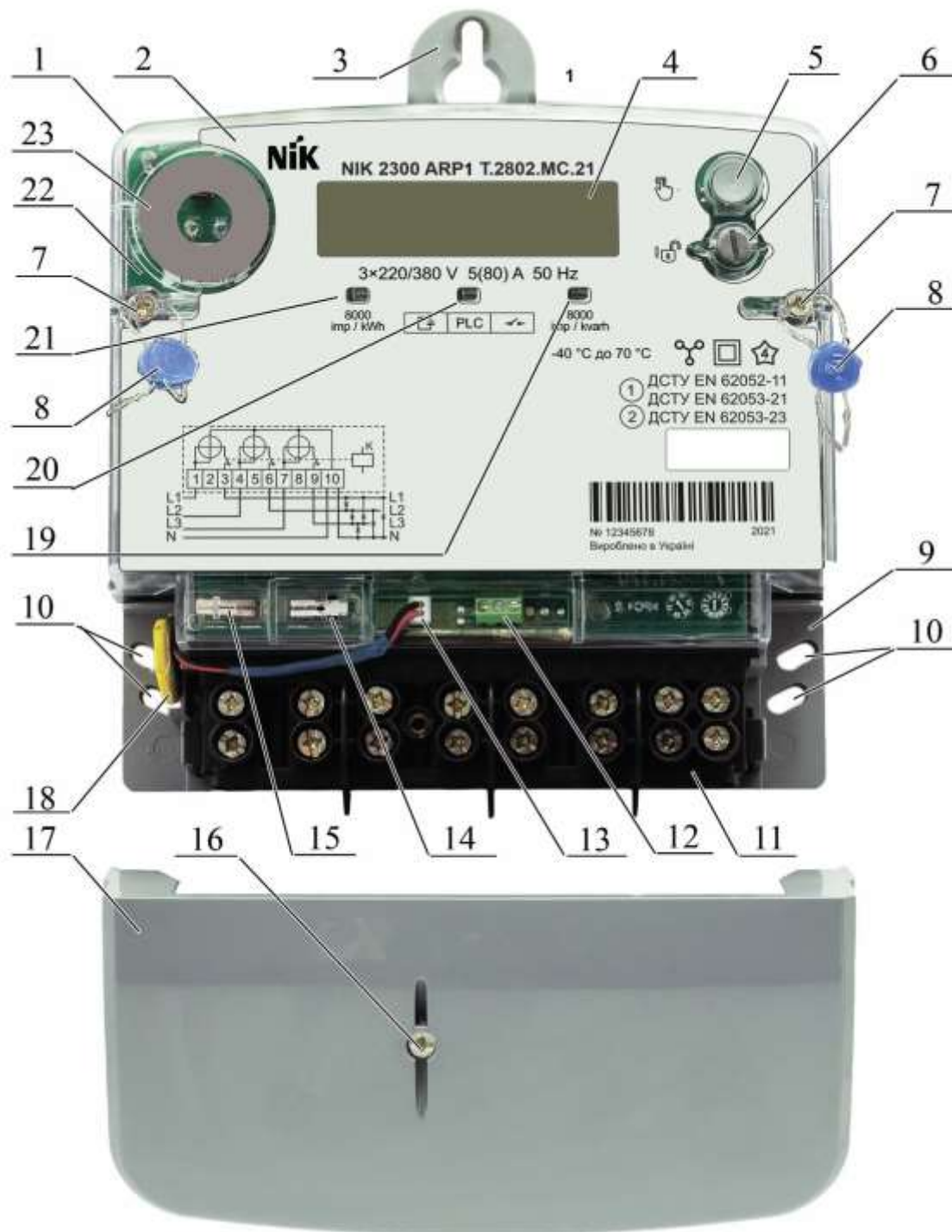

Figure 1. Appearance of meters

The figure shows the following elements:

1. The casing of the meter;
2. Nameplate of the meter;
3. Clamp for fastening of the meter;
4. The electronic display of the meter;
5. "View" button;
6. Function button;
7. Sealing screws of the casing;
8. Seals;

9. The base of the meter;
10. Holes in the base for mounting the meter;
11. Clamp unit;
12. Contacts of the main test output of the meter;
13. External backup battery connector;
14. Sensor for opening the terminal cover;
15. The sensor of the opening of a casing of the meter;
16. Sealing screw of the cover of clamps;
17. Cover of clamps;
18. External backup battery;
19. LED indicator for reactive energy measurement;
20. LED indicator of exchange via PLC or PLC G3 interfaces;
21. LED indicator of active energy measurement;
22. Printed circuit board with electronic components;
23. Optical port interface.

2.8.2. Meter case design

The meter is made in the isolation case of a II class of protection which consists of a base and a casing. The design of the meter base has holes and a clamp for mounting the meter at the installation site.

A printed circuit board with a display, LED indicators, sensors, other electronic components, and connectors is attached to the base. On the casing of the meter, there is a nameplate with information about the meter (see section 4.1) made by tampon printing.

The casing is attached to the base with two screws that can be sealed. The casing of the meter provides special outflows with holes for screw sealing. In addition, the casing and the base of the meter are fastened with a solid seam by laser welding.

A clamp unit with primary voltage and current converters is also installed on the base. The presence of protective partitions between the phase terminals of the clamp unit ensures the impossibility of a short circuit between them. The network wires and load wires are fastened to the corresponding terminals with the help of screws when the meter is connected. The clamp unit is closed with a cover. The terminal cover fastens to a base by means of the screw with the possibility of its sealing. The special outflow with an aperture in the terminal cover is provided in order to make sealing possible.

The PCB also has connectors for the main test outputs of the meter, the RS-485 interface, and an additional external backup battery, which can only be accessed with the removed terminal cover.

The design of the case provides the impossibility of removal of a cover of the meter without removal of a terminal cover.

Numbers corresponding to the factory number of the meter are put on a base and a casing. The same number is indicated on the nameplate, which makes it impossible to forge them. At the request of the

customer, it is possible to install a disposable number seal on one of the coupling screws of the meter and apply (duplicate) the number of the seal on the meter case so that it covers the casing and base of the meter case.

2.8.3. Measuring elements

The primary converter in voltage circuits is a resistive voltage divider. Three measuring elements (shunts) are used in the current circuits of the meters.

2.8.4. Data storage

Non-volatile memory is used to store data in meters. The accumulated values of electricity and parameters of the meter are stored in the memory. Accumulated energy values and parameters of meters, must be stored for at least 20 years in the absence of voltage at the terminals of meters.

2.8.5. View button

The meters are equipped with a "View" button (see Figure 1), which is used to switch the menu on the electronic display when the meter is connected to the mains. The meter operates in battery mode in the absence of mains voltage. The meter turns on for a while in the display mode when you press the "View" button. You can also read the measured and saved values by switching the menu. The duration of operation of the meters in the display mode and the list of displayed windows depends on the parameterization of the meters.

2.8.6. Function button

The function button located on the meter is designed to perform operations specified by the customer in the supply contract of meters. This button, depending on the software settings, can perform various functions:

- Cleaning the event log;
- Cleaning of half-hour, daily, and monthly profiles, and profile that can be configured individually;
- Cancel the indication on the LCD of the triggering event of the magnetic field sensor. Cancellation of the indication is possible only if the cause of the indication is eliminated;
- Cancellation of the indication on the LCD of the triggering event of the electromagnetic field sensor. Cancellation of the indication is possible only if the cause of the indication is eliminated;
- Switch on the load control relay after it has tripped. Switching on the relay is possible only if the reason for switching off the relay is eliminated;
- Unconditional disconnection of the load control relay;
- Restart the meter;
- Cleaning of registers of logging of excess of the maximum allowed value of instantaneous power;
- Lock and unlock the optical port.

Use of the function button is possible only when its slot is in a vertical position (see Figure 1). If you turn the slot of the button to a horizontal position, it becomes impossible to press it. In this position, the

button can be sealed through a hole in the button and special recesses in the meter casing. The sealing of the button is performed similarly to the sealing of the meter casing. This eliminates the unauthorized use of the button and the opening of the casing without damaging the seals.

2.8.7. Calendar and clock

The meters have a real-time clock and a calendar. The real-time clock is used for multi-rate metering of electricity, determination of the average power for the period of integration, and registration of events with a time stamp. The real-time clock can switch to winter and summer time automatically or on a date that is set during parameterization.

To reduce the dependence of the clock error on the ambient temperature, a temperature sensor is installed in the meter. To ensure the continuity of the built-in clock when the mains voltage is disconnected, the meters are equipped with a built-in backup battery.

2.8.8. Indicators

LED operation indicators for active and reactive energy measurement and an information exchange indicator via PLC or PLC G3 interfaces are displayed on the front panel through special holes in the nameplate (see Figure 1).

2.8.9. Load control relay

Individual versions of meters can be equipped with load control relays (see Table 3, Table 4, Table 5). This allows you to disconnect or connect loads to the consumer through any communication interface. Depending on the parameterization, the relay can be switched off automatically when the maximum allowable values of voltage, current, and power are registered, and after the triggering of magnetic or electromagnetic field sensors.

2.8.10. Sensors

The meters have sensors for opening the casing and the terminal cover. When the meter casing or the terminal cover is opened, the corresponding sensor is activated and a record of this event with the date and time is placed in the event log of the meter. Similarly, records of closing the terminal cover are recorded in the log.

At the request of the customer, meters can be equipped with sensors of magnetic and electromagnetic fields.

For more information on the operation of the sensors - see Section "3 Protection of meters from unauthorized interference".

2.8.11. Description of LED

The meters use a liquid crystal display (hereinafter - LCD), the appearance and elements of which are described below (see Figure 2).

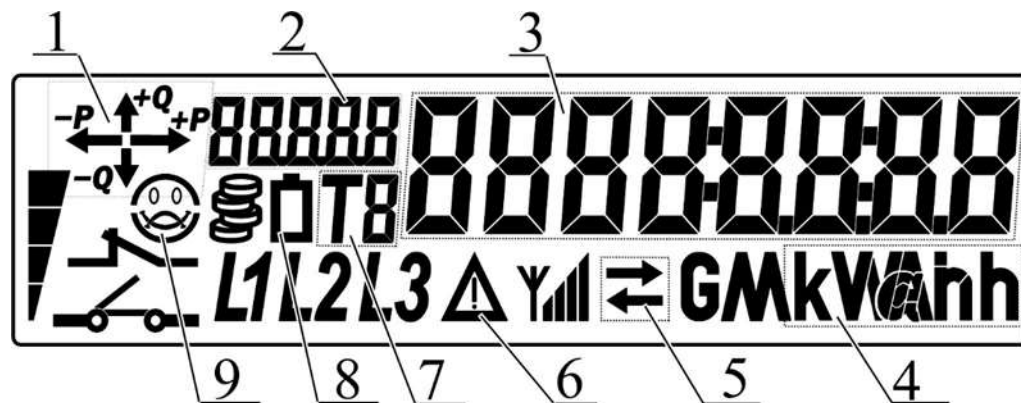

Figure 2. Appearance of LCD

The following elements of the LCD are indicated in this figure:

1. Group of energy angle quadrant indicators:

1.1. « \rightarrow^{+P} » active power (A+);

1.2. « \leftarrow^{-P} » active power (A-);

1.3. « \uparrow^{+Q} » full power vector in the first quadrant (A+R+);

1.4. « \leftarrow^{-P} » full power vector in the second quadrant (A-R+);

1.5. « \downarrow^{-Q} » full power vector in the third quadrant (A-R-);

1.6. « \downarrow^{-Q} » full power vector in the fourth quadrant (A+R-);

1.7. « \uparrow^{+Q} » reactive power (R+);

1.8. « \downarrow^{-Q} » reactive power (R-).

2. Group of indication of OBIS-code of the displayed parameter

3. Group to display the value of the measured parameter;

4. Unit of indication group:

4.1. «**A**» current in amperes;

4.2. «**V**» voltage in volts

4.3. «**kW**» active power in kilowatts;

4.4. «**kVar**» reactive power in kilovars;

4.5. «**kW h**» active energy in kilowatt-hours;

4.6. «**h**» network frequency.

5. Indicator of data exchange through interfaces « \rightleftarrows »;

6. The indicator of internal error « Δ », flashes when an error occurs, or during the emergency rate;

7. «**TB**» number of the current rate;

8. Backup battery low charge indicator « \square ». If the symbol is displayed, the battery needs to be replaced.

9. Load connection indicator. When the load is disconnected, the symbol , is displayed. When the load is connected, the indicator is not used.

LED symbols not marked in the figure are not used in these meters.

2.8.12. The power supply of meters

A pulse power supply is used to power the meters, which converts the rectified input voltage into the voltage required to power all units and modules of the meters.

The meter microcontroller switches to battery-saving mode in the absence of mains voltage. Only the internal clock of the meter works in this mode. When the mains voltage is switched on, the energy of the built-in battery is not used. In extreme conditions, without mains voltage, the meter can operate for at least 24 years. At the customer's request, the meters can be additionally equipped with an external backup battery to back up the built-in backup battery.

2.8.13. Meter interfaces

The meters have a main interface (optical port) and one additional interface (depending on the version). The type and availability of the interface are reflected in the version name of the meter, which is indicated on the nameplate and in the passport (see Table 3, Table 4, and Table 5). The nameplate of the meter contains information about the type of interface in this version of the meter.

The markings of interfaces on the nameplate are given in "Table 11. Description of symbols of interfaces on the nameplate".

Data from the meter can be read simultaneously through all available interfaces.

Table 6. Available interfaces

Interface	Description
RS-485	Asynchronous interface, for a half-duplex multipoint communication line of the "common bus" type, in which data transmission is carried out by means of differential signals. The interface has galvanic isolation of the communication line. The interface is compatible with the ANSI TIA / EIA-485-A: 1998 standard. Communication speed from 1200 to 19200 baud.
PLC	Interface for data transmission on power lines with a modulated signal. First-generation PLC interface. <ol style="list-style-type: none"> 1. Marked as "PLC" on the nameplate. 2. Exchange speed up to 150 Kbps. 3. CENELEC-A frequency band (10kHz to 95kHz). 4. DCSK modulation.

Interface	Description
(PLC G3)	<p>Interface for data transmission on power lines with a modulated signal. Third generation PLC G3 interface.</p> <ol style="list-style-type: none"> 1. Marked as "PLC3" or "PLC 3" on the nameplate. 2. Exchange speed up to 150 Kbps. 3. CENELEC-A frequency band (10kHz to 95 kHz). 4. OFDM modulation. <div style="border: 1px solid black; border-radius: 10px; padding: 10px; margin-top: 10px;">  The PLC and PLC G3 interfaces are not compatible. </div>

2.9. Operation principle of the meter

2.9.1. Measurement

Measurement of the active and reactive electrical energy is accomplished through the analog-to-digital conversion of electrical signals which come from the primary current sensors (shunts) and voltage sensors (resistive dividers) onto the input of the analog-to-digital converter (ADC) of the controller, which converts signals into digital code. The controller calculates the root mean square (RMS) value of the current, voltage, power, the current value of the power factor for each phase, as well as the value of active and reactive energy in total and for each rate.

The controller manages the LCD, electrical and optical interfaces, main pulse outputs, load relays, and processes information from mechanical buttons, magnetic and electromagnetic field sensors, case opening sensors, and terminal cover opening sensor.

Non-volatile memory is used to store data in the meters. The accumulated values of the electric power and parameters of the meters are stored in memory. The measured energy values and parameters of the meters are stored for at least 20 years in the absence of voltage at the terminals.

2.9.2. Parameterization of meters

During parameterization, the configuration constants of the meters are entered into its memory. Parameterization is performed through the optical port in two stages:

- factory parameterization;
- parameterization at the consumer's venue.

The meter has two levels of access to change and read data and settings. Both access levels are password protected:

1. Operator access level: you can change all parameters except the barcode and meter version; you can change the user password, but you can not change the factory password.
2. User access level: you can only read data from the meter about its parameters and settings.

In the memory of the meters through the electrical interface are written constants that adapt the meter to local operating conditions when parameterizing at the consumer's venue. An example of information that is written to the memory of the meters is shown in Table 9.

Parameterization of meters at the consumer's venue is carried out by the power supply or the authorized organization by means of special software. Parameterization is possible only with a password with operator access rights.

Table 9. Information stored in the memory of the meter

Parameter	Value	
	default	allowed
Speed of data exchange between the meter and the installed interface: RS-485	9600 baud	1200 to 19200 baud
Transmission speed for the optical port	9600 baud	9600 baud
Time to disconnect when the interface is inactive	120 s	1 to 250 s
Meter address: - senior "HI" - junior "LOW"	generated based on the serial number	0 to 65535 11 to 26
User password Operator password	1111111111111111 2222222222222222	1 to 16 characters 1 to 16 characters
Location of the meter (Street) Location of the meter (House) Location of the meter (Apartment) Location of the meter (Owner)	- - - -	0 to 100 characters 0 to 100 characters 0 to 100 characters 0 to 100 characters
Values of voltage thresholds, at the output of which, for at least the set time, the indication is turned on and the event is recorded in the memory of the meter: - for meters of direct and combined connection U _{max} U _{min} - for transformer meters connection U _{max} U _{min}	253 V 176 V 67 V 46 V	40 to 600 V 40 to 600 V 40 to 600 V 40 to 600 V
The time after which there will be an indication of the voltage output beyond the thresholds and the event is recorded in the memory of the meter	5 s	1 to 250 s
Relay operation	Off	On or off
Summer/winter time transition parameters	automatic transition	- automatic transition; - transition to the specified month, day; - no transition
Number of rates Number of profiles per week Number of rate seasons Number of profiles per day Holidays	4 10 12 16 30	

2.9.3. Rate module

The meter software rate module can support up to 4 rates and record the data of energy measured by meters in the registers of active and reactive energy separately for each of the 4 rates.

The effect of each rate during the year is scheduled in time using the annual rate plan. The annual rate plan consists of rate plans of the day, rate plans of the week, and rate plans of the seasons.

2.9.3.1. Active rate

All rates are numbered from 1 to 4. Only one of the four possible rates can be valid at any time of the day. This rate is called active, unlike other currently inactive rates.

2.9.3.2. Rate plan of the day

The rate plan of the day is a numbered sequence and time of activation of a rate during the day. The rate module allows you to set up to 12 changes in the active rate during the day and supports up to 16 different rate plans per day. The numbering of rate plans for the day is from 1 to 16. Each change of the rate during the day is set by the moment of rate activation (hours, minutes, seconds) and the number of this rate (from 1 to 4).

2.9.3.3. Rate plan of the week

The rate plan of the week allows you to assign each day of week one of the 16 possible rate plans of the day. The meter rate module supports up to 10 different rate plans per week. The numbering of rate plans of the week is from 1 to 10. For each day of the week, the number of the selected rate plan of the day is indicated. The change of daily rate plans during the week occurs when the day changes, at 00:00:00 according to the built-in real-time clock. The current rate plan of the week is called active.

2.9.3.4. Rate plan of the season

The rate module of the meter allows you to divide the calendar year into seasons (up to 12 different rate seasons are supported), and assign a rate plan to each of them. The season rate plan (or season rate) describes the sequence and time of change of weekly rate plans during the season. The numbering of rate seasons is from 1 to 12. The current rate season is considered active. The rate season is set by the moment of activation of the season and the number of its rate plan.

2.9.3.5. Lists of holidays

The rate module allows to support up to 30 separate rate daily plans for special days (their numbering is from the 1st to the 30th), the moment of activation of which is set for a specific date in month-day format, as opposed to regular daily rate plans, which occurs sequentially when changing the day of the week. Such rate plans allow you to configure the switching of rates for special days, for example, holidays. When the corresponding holiday date arrives on the built-in clock and calendar, the change of rates will be performed according to the holiday daily plan, i.e. the holiday daily plan will be active, and not the usual one, which should be activated on the corresponding day of the week.

2.9.3.6. Setting up rate plans

Adjustment of daily, weekly, seasonal, and holiday rate plans is performed when parameterizing meters with the help of special software. The parameters of each rate plan of the day, week, season, or holiday are set when setting up, and thus, the sequence and time of activation of a rate within a day, week, season, or in case of a set holiday date is set.

2.9.3.7. Rate grids

The set of configured rate plans (days, holidays, weeks, and seasons) that are currently in force is called the active annual rate plan, or active rate grid. It is not possible to edit the active rate grid. The rate module of the meter software allows you to additionally configure another, currently passive, rate grid. You can activate it later. This provides the opportunity to make the necessary changes in rate plans. The scheme of the rate grid is described in Annex E.

2.9.3.8. Change of rate plans

The meter rate module tracks the activation moments of the respective rates, controlling the current time, day of the week, and date according to the built-in clock and real-time calendar. When the moment set in the rate plans of the day, week, season, or holiday comes, the corresponding rate is activated and it is valid until the next rate is activated.

2.9.3.9. Emergency rate

In case of failure of the built-in real-time clock, the emergency rate is automatically activated in the meter, and all calculated energy values are recorded in the emergency rate registers, while the corresponding symbol (icon  and rate number) flashes on the electronic display. The emergency rate number is set during parameterization.

2.9.3.10. Accumulation of data on rates

The measured values of energy parameters are accumulated in the corresponding registers in the memory of the meter. The rate module for each rate provides a separate set of registers for the accumulation of values of energy parameters.

2.9.3.11. Load profiles

To collect statistics on energy consumption during the operation of the meter, in advance, at the stage of its parameterization, you can create a load profile - a list of measured values (up to 8 values), for which the integration period is specified. The values of the measured values included in the load profile will be periodically (with the specified period) recorded and stored in the relevant registers of the meter memory. Accumulated information can be read from the meter using the appropriate software through the available interfaces.

The integration period when parameterizing the load profile is set in minutes from a number of fixed values 1, 2, 5, 10, 15, 20, 30, and 60 minutes.

The storage depth of the load profile of each type of measured energy depends on the integration period and the set maximum period of 60 minutes can be up to 180 days.

3. Protection of meters from unauthorized interference

3.1. Constructive means of protection

The casing and the terminal cover are attached to the base with sealing screws. The groove on the perimeter of the base provides an overlap with a connection of at least 4 mm, which eliminates unauthorized

penetration into the measuring part of the meters without damaging the housing. In addition to the sealing screws, laser welding can be used to attach the casing to the base.

The design of the case provides the impossibility of removal of a casing of the meter without removal of a terminal cover.

Numbers corresponding to the factory number of the meter are put on a base and a casing. The same number is indicated on the nameplate, which makes it impossible to forge them. At the request of the customer, it is possible to install a disposable number seal on one of the tightening screws of the meter and apply (duplicate) the number of the seal on the meter body so that it covers the casing and base of the meter casing.

Additional sealing is performed by a disposable protective number plate on the meter case in the place of its connection to the casing.

3.1. Registration of opening of a terminal cover and a casing

The opening of the meter casing or the terminal cover is fixed by the sensor of the opening of the casing or the sensor of opening the terminal cover, respectively. The events of opening the casing and the terminal cover are recorded in the corresponding log. The recording of the activation of the sensor of the opening of a terminal cover and/or the sensor of the opening of a casing during the absence of voltage in the network is carried out thanks to the built-in battery of reserve power supply

3.2. Sealing of the function button

To prevent unauthorized use, the design of the function button provides the ability to seal it in a locked state.

3.3. Software protection of access to the accumulated data

The information in the meters is available for reading through the optical port or other available interfaces. Access to data is possible only after entering the password. After entering the wrong password 5 times in a row, the meter will remain locked for 30 minutes.

There are several levels of access to read or write data through external interfaces:

1. User - can only read identification data;
2. Information collection system - can read all data and change clock and interface settings;
3. Power engineer - can read all the data, as well as change several parameters;
4. Manufacturer - can read and write all the settings of the device.

At any level of access it is impossible:

- Change or affect the measurement results.
- Change or affect calibration metrological constants.
- Change the version or checksum of the program.
- Change or affect the measurement data archive.
- Modify or affect the event log archive.

3.4. Registration of external influences

The magnetic field sensor, which can be installed in meters, is activated under the influence of a constant magnetic field of more than 100 mT. If the duration of exposure is more than 3 s, a record of this event with a date and time mark is recorded in the event log of the meter. A record of the termination of the magnetic field influence with a date and time will be recorded in the event log 60 seconds after the end of the influence of the magnetic field.

The electromagnetic field sensor, which can be installed in meters, is triggered by the influence of an electromagnetic field with a voltage greater than that specified during parameterization. If the duration of exposure is more than 3 s, a record of this event with a date and time mark is recorded in the event log of the meter. A record of the termination of the electromagnetic field influence with a date and time will be recorded in the event log 60 seconds after the end of the influence of the electromagnetic field.



The duration of such events is determined by the period from the beginning to the end of the relevant external influence.

4. Marking

Marking of the meter corresponds to EN 62053-52, EN 50470-1, EN 50470-3, EN 62053-23 and drawings of the manufacturer.



Possible symbols indicated on the nameplate of the meter, depending on the version, are described in Table 10.

Table 10. Marking symbols placed on the nameplate of the meter

Symbol	Description
	Symbol of the meter with three measuring elements.
	Symbol of meters in the insulating casing with protection class II.

On the meter nameplate, the table with the designated interfaces and relays (see Figure 1. Appearance of the meters) includes the alphanumeric designation of the interfaces (see Table 3, Table 4, and Table 5) and the symbols described in Table 11.

Table 11. Description of interface symbols on the nameplate

Marking	Description
RS-485, PLC, PLC3, or PLC 3	availability of the corresponding interface.
	availability of an optical port;
	availability of the load control relay;

The connection diagram of the meter is printed on the nameplate and (or) on the inside of the terminal cover.

The scheme of connection of meters is given in the appendix "Appendix C".

4.1. Description of the design of the nameplate of the NIK 2300...P1...

An example of the design of the meter nameplate is shown in Figure 3. For meters of types NIK 2300... P1..., NIK 2300... P3... and NIK 2300... P6... the location of the elements shown in the figure is similar.

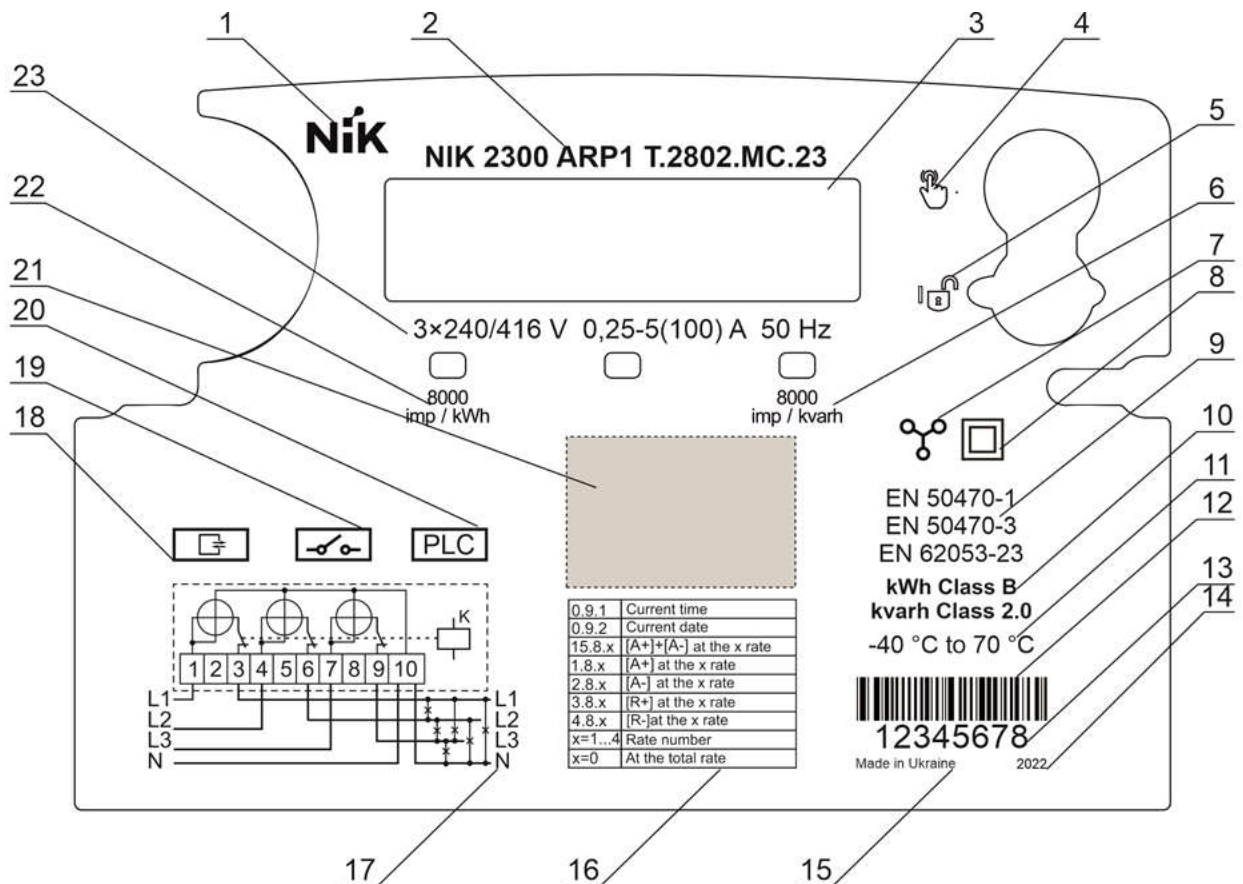

Figure 3. Example of NIK 2300 ... P1... nameplate design

The figure shows the following elements:

1. Registered trademark;
2. Symbol of meter version;
3. The window for the electronic display of the meter;
4. Marking of the "View" button;
5. Marking of the function button;
6. Marking of the indicator of measurement of reactive energy (metering constant of the main test output of the meter for the measurement of reactive energy);
7. Symbol of the number of measuring elements;
8. Symbol of protection class II;
9. Standards that the meter complies with, including standards for accuracy classes for measuring active and reactive energies;
10. Accuracy classes of the meter;
11. Operating temperature range;
12. Place for meter barcode;

13. Factory number according to the numbering system of the manufacturer;
14. Year of manufacture of the meter;
15. The inscription "Made in Ukraine";
16. Table of OBIS codes;
17. Wiring diagram of the meter;
18. Symbol of the presence of an optical port;
19. Symbol of the presence of the load control relay
20. Symbol of the presence and type of the first additional interface;
21. Area for conformity assessment mark, additional metrological marking, and additional information at the request of meter owners;
22. Marking of the active energy measurement indicator (metering constant of test electrical output of the meter for the measurement of active energy);
23. Main technical characteristics (reference voltage, reference and maximum current, reference frequency).

Notes:

1. Inscriptions on the nameplate may be made in other languages at the request of the customer.
2. Additional elements may be applied to the nameplate at the request of the customer.
3. Depending on the design of the meter, the list of elements on the nameplate may change compared to the figures.
4. It is allowed to change the relative position of the elements and their dimensions on the nameplate when changing its geometry or meter casing and for other production reasons.

5. Delivery set

The delivery set of the meter is given in Table 12.

Table 7. Delivery set

Name	Quantity
AC meter type NIK 2300... P1... or NIK 2300... P3... or NIK 2300... P6...	1 pc.
Passport AAIIX.411152.073 IIC*	1 copy.
Operations manual AAIIX.411152.073 HE*	1 copy.
Software **	1 copy.
Consumer packaging	1 pc.
Declaration of Conformity	1 copy.
* It can be downloaded electronically from the manufacturer's site at https://nik-el.com .	
**According to the supply contract.	

6. Packing

One meter with operational documentation is placed in the consumer packaging.

Consumer packaging with a packed meter is pasted with adhesive tape. A packing sheet is pasted on top of the consumer packaging.

Another version of the meter packaging is carried out at the request of the customer with an indication in the supply contract.

Meters packed in consumer containers are placed in transport containers. The box also contains shipping documentation, including a packing list containing the following information:

- the inscription "Made in Ukraine";
- trademark of the manufacturer;
- name and version designation of meters;
- number of packed meters;
- a signature or personal mark of the packer;
- TCD mark of the manufacturer;
- gross weight, in kilograms;
- packing date.

The overall dimensions of the transport container do not exceed the dimensions 366 mm x 245 mm x 520 mm.

Gross weight: less than 2.5 kg.

7. Intended use

7.1. Preparation of the meter for use and installation procedure

The meter should be installed in rooms that meet the requirements specified in section "2.7 Requirements for operating conditions".

Installation, dismantling, connection, and disconnection of the meter can be performed only by an authorized organization.

The organization authorized to perform the installation, maintenance, and dismantling of meters is fully responsible for the fact that its staff has carefully studied this manual, has sufficient qualifications to perform work, and strictly complies with local regulations on the safety and operation of electrical installations.

Installation, dismantling, connection, and disconnection of the meter must be performed in accordance with the current rules of operation of electrical installations and safety, only by qualified personnel in accordance with the requirements of this document.

Installation, dismantling, connection, and disconnection of the meter must be performed by personnel with no less than the third qualification group according to the rules of safe operation of consumer's electrical installations.

Installation and connection of the meter are performed in the following sequence:

1. Before installing the meter, it is necessary to de-energize the electrical network and take measures to ensure the impossibility of reversing its state before installation is complete;
2. Unpack the meter and make sure there is no mechanical damage, and the seals remained their integrity.

3. Fix the meter at the metering point. The meter is mounted on a DIN rail and fixed with two clamps. It is also possible to install the meter at the metering point with three screws according to Figure 1. DIN rail type is TH/35 7.5, standard metal rail with 35 mm wide special profile.
4. Connect the meter in accordance with the scheme given in the "Appendix B Schemes of connecting meters to the consumer network".
5. The screws of the terminal must be tightened with a slotted screwdriver (blade thickness 1 mm) to the stop with a torque of 3.5 ± 0.5 N.
6. Apply voltage to the meter, and make sure that the indication on the LCD indicates the normal operation of the meter, described in section "2.8.11 Description of the LCD", otherwise you need to fix the connection or replace the meter.
7. Fasten the terminal cover with screws to the stop with a torque of 0.5 ± 0.1 N • m, and apply seals.

When connecting the meter to the mains, rigid, rigid multicore or flexible multicore types of conductors can be used.

Conductor material: copper or aluminum.

When connecting the meter to the mains with aluminum wire, these wires must be pressed into special sleeves to prevent corrosion of the connections in the terminals of the meter.

The diameter of the cross-section is selected depending on the maximum current flowing through the conductor (from 3 to 6 mm).

7.2. Backup battery

To power the meter clock, depending on the version, a built-in backup battery is used, which is designed to last for the entire life of the meter. Replacement of the battery is possible only in the service center of the manufacturer. If the low battery indicator on the electronic display flashes (see Figure 2, symbol ) , this means that the battery is low and you need to contact a service center.

At the customer's request, the meter can be additionally equipped with an external backup battery to back up the internal battery. If necessary, its replacement is carried out only by the energy supply organization or authorized organization in the following order:

1. Before installing the meter, it is necessary to de-energize the electrical network and take measures to ensure the impossibility of reversing its state before installation is complete;
2. Cut off the seal of the terminal cover, unscrew the sealing screw;
3. Remove the terminal cover;
4. Disconnect the battery connector from the PCB;
5. Remove the old backup battery and install a new one.
6. Connect the external battery connector to the appropriate contacts on the PCB, considering the polarity. If the symbol  continues to be displayed on the LCD after replacing the battery, then the installed battery is discharged or the polarity of the battery does not match the respective contacts;
7. Set the current date and time in the meter via the optical port or other available interfaces;

8. Close the terminal cover on the meter, tighten the sealing screw and apply the seal.

7.3. Using the meter

In operating mode, the meter measures active and reactive electrical energy, in the forward and reverse directions with the increasing results (see Table 6).

LED for active "8000 imp/kW•h" and reactive energy "8000 imp/kvar•h" are installed in the meter. When the load is connected to the measured circuit, the indicators flash at a frequency proportional to the power consumed. Operation indicators are switched synchronously with the main test output.

The main test outputs are implemented on electronic switches with optical isolation. The maximum allowable voltage of the key in the open state is not less than 30 V, and the maximum allowable current of the key in the closed state is not less than 30 mA.

7.4. Data reading

7.4.1. Ways to read information

Information from the meter can be read:

- Visually, from the electronic display;
- Through any interface installed in the meter (see Table 3, Table 4, and Table 5).

7.4.2. Options for reading data through interfaces

There are the following options to read data through the interfaces

- via electrical interfaces RS-485, PLC, PLC G3 (if available);
- via the optical communication interface (optical port).

A description of the interfaces is given in section "2.8.13 Meter interfaces". The OP200 (Optical-Probe or analog) and the corresponding software are used for connection on the optical communication interface.

7.4.3. Readable data

By connecting to the meter, it is possible to:

- read or change the rate model of the meter;
- read the load profile of each type of measured energy;
- read the value of each type of energy for each rate, and in total for all rates for the last day or month;
- read the event log;
- set the clock and calendar;
- read the values of all values measured by the meter;
- read or change the settings of the interfaces, the parameters of the indication thresholds, and information about the location of the meter;
- change the access password;
- turn on or off the sound of the meter, which plays when you press the buttons;
- change the rate number or time intervals of the relay output;

- change the number and order of windows on the LCD.

7.4.4. Display of total energy and total power

The meters calculate the values of each type of energy to the third decimal place, and the LCD displays the values to the second decimal place, thus:

- the value of each type of total energy at all rates, which is displayed on the LCD of the meter (WΣLCD), may be greater than the value of the total energy WΣv calculated by the formula (1) by not more than 0.004 kW (2).

$$W\Sigma v = W1+W2 + W3 + W4; \quad (1)$$

$$W\Sigma LCD - W\Sigma B \leq 0,004 \text{ kW}; \quad (2)$$

where W1, W2, W3, and W4 are energy values displayed on the LCD of the meter on the first, second, third, and fourth rates, respectively.

- the value of each type of energy for a certain period Wp read from the meter using the parameterization program may be more than 0.048 kW bigger (3) than the sum of the energy values of 30-minute intervals WΣ30 read from the meter using the parameterization program for the same period.

$$Wp - W\Sigma 30 \leq 0.048 \text{ kW} \quad (3)$$

7.5. Description of the windows displayed on the LCD

7.5.1. The order of changing windows

At the first moment after turning on the meter, all segments of the LCD are lit. Then certain data that depend on the parametrization are formed on the LCD in sequential order after the power is supplied. Each type of data is hereinafter referred to as a data window, or simply a window. The list of windows and the order of their output are set when parameterizing the meters. The default display time for each window is 10 seconds.

In the automatic menu mode, the information on the LCD changes every 10 seconds. The table with the full list of OBIS codes is given in the appendix "Appendix D".



Figure 4. An example of the displayed window

"Figure 4. An example of the displayed window" shows one of the possible windows of the meter. From the table "Table D. 1" it is clear that in this window the data of measurement of the consumed active energy are deduced with the corresponding symbol "→+P", that means (A +) total for all rates (OBIS-code 1.8.0). The symbol "T3" mean that the meter is currently storing energy at the third rate. The display of the

symbols "L1", "L2", and "L3" means that the voltage values on the first, second, and third phases are within the set limits.

In manual mode, each time you press the "View" button, the next window configured during parameterization is displayed with the measured values, the corresponding OBIS code, and units of measurement.

7.5.2. Indication of different operating modes of meters

If the meters fail, the symbol  on the electronic display starts flashing (see Figure 2). In the field of the measured parameter value (see Figure 2) error codes are periodically displayed, and when pressing the "View" button, first all errors that occurred in the meter are displayed, and after them, the data calculated and measured by the meter. The list of error codes is given in the appendix "Appendix E. Error codes" of this manual.

The emergency rate is activated in cases of failure of the rate system or the internal clock of the meter. The effect of the emergency rate in the meters is shown on the electronic display by flashing the symbol  (Figure 2, item 6) and flashing the emergency rate number (Figure 2, position 7). In this case, when you click the "View" button, or when the windows are automatically switched, the "Err 006" window periodically appears.

For meters, the current rate number is displayed in position 7 (see Figure 2). For meters measuring active energy in two directions, the rate number under review, as well as other parameters measured and calculated by the meter, are displayed in position 2 (see Figure 2) in the form of OBIS codes. The list of OBIS codes that the meters support is given in the appendix "Appendix C. Table of OBIS codes".

The versions of meters that measure active energy in two directions display the quadrant of the energy angle on the electronic display, using the symbols of position 1 (see Figure 2).

If one or more "L1", "L2", and "L3" symbols flash simultaneously in the window during energy indication then at the corresponding phase the voltage has exceeded the set thresholds. The indicator flashes at 0.5 Hz if the voltage is low, and at 2 Hz if it is high.

The reverse direction of energy is displayed as "-" signs in front of the indicators "L1", "L2", and "L3".

If the symbols "L1", "L2", and "L3" alternately flash in the window during the energy indication then the meters are not connected to the network correctly (incorrect phase sequence).

If the LCD shows a  symbol (see Figure 2) then either the meter has malfunctioned, the sensors were triggered (magnetic field sensor or electromagnetic field sensor) or there is the debt.

If the LCD shows the  symbol (see Figure 2) then the built-in backup battery needs to be replaced. The procedure for replacing the battery is described in section "7.2 Backup battery".

7.5.3. Error and fault indication

If there is a failure during the operation of the meter, the LCD displays a window with an error and its code. The error code consists of three characters, an example of the window is shown in Figure 5.

Err 051

Figure 5. Meter failure window

If the fault indication shows on the LCD, then the meter should be repaired (except when the terminal cover is opened to service the meter, when magnetic or electromagnetic field sensors were triggered, and if Error 006 (real-time clock failure) or Error 232 (parameterization error) occurs. The table of error codes is given in the appendix "Appendix E".

7.5.4. Examples of displayed windows

The order of display of windows on the LCD screen depends on the parameterization. Each OBIS code output corresponds to the measured value. The values of each of the possible OBIS codes are given in Appendix D. By successively pressing the "View" button, the OBIS code of the corresponding measured value is selected, the value of which must be read visually. The "View" button is pressed to display the value of the measured value separately for one specific rate or phase, if necessary.

Examples of windows reflecting active energy (A +) (total by phases and rates, total by phases and separately by rates, total by rates) are shown in figures 6 - 11. Display of values and units of active energy (A-), reactive energy (R +), and reactive energy (R-) are similar.



Figure 6. Active energy (A +) in total by phases and rates



Figure 7. Active energy (A +) of the L2 phase in total by rates



Figure 8. Output window of the current clock time



Figure 9. Output window of the current clock date



Figure 10. The window for displaying the value of the active energy module



Figure 11. Software version display window

The meter can display the software version number. However, due to the limitations of the LCD, the prefix version "EM" is not displayed, and the separator "v" is replaced by "F". Figure 11 shows the display on the LCD of the software version EM5113.v.2.00.

8. Maintenance

8.1. General instructions

Maintenance of meters in compliance with the operating conditions is carried out not more than once every 6 years (specified by the manufacturer).

Maintenance consists of the operation of calibration or repair and calibration of the meter.

The verification operation is performed by an authorized body.

The repair and calibration operation are performed at the manufacturer's factory.

8.2. Instructions for safety precautions

The meter meets the requirements of GOST 22261 for operational safety.

According to the method of protection of a person from electric shock, the meter complies with class II in accordance with EN 50470-3.

Insulation between all circuits of current, voltage, "ground" on the one hand and the terminals of the interfaces and main test leads on the other withstands a test voltage of 4 kV (RMS) at a frequency of (50 ± 2.5) Hz for 1 min.

Insulation resistance between the housing and electrical circuits is not less than:

- 20 MOhm - under normal conditions;
- 7 MOhm - at ambient temperature (30 ± 2) °C and relative humidity of 90%.

The meter meets GOST 12.1.004-91 according to fire safety requirements.

9. Transportation and storage

9.1. Requirements for transportation and storage of the product

Conditions of transportation and storage of the meter in the transport packaging of the manufacturer are corresponding to the category of climatic conditions 3K7 according to IEC 60721-3-3.

The meter can be transported in covered railway cars, transported by road with protection from rain and snow, water transport, as well as transported in sealed heating compartments of aircraft.

Transportation must be carried out in accordance with the rules of carriage applicable to each mode of transport.

The meter in a transport container is steady against the influence of ambient temperature from minus 40 to plus 70 °C, the influence of relative humidity of ambient air to 95% at a temperature of 30 °C, and atmospheric pressure from 70 to 106,7 kPa (from 537 to 800 mmHg).

The meter in a transport container is steady against the influence of a transport shaking at a number of blows from 80 to 120 per minute with the acceleration of 30 m/s².

10. Requirements for environmental protection and disposal of the device

After the end of its service life, the device must not be disposed of with household waste. The disposal must be carried out in compliance with all applicable requirements of the local legislation.

In order to eliminate possible damage to the environment, due to uncontrolled waste disposal, please separate this product from other waste and reuse it or its components.

Production waste is subject to disposal in accordance with DSTU 4462.3.01: 2006.

Users can contact the product manufacturer about handing over a non-reusable appliance.

11. Manufacturer's warranties

The manufacturer guarantees the compliance of the meters with the requirements of EN 50470-1, EN 50470-3, EN 62053-23, and IEC 62053-52:2010 if the consumer complies with the conditions of operation, storage, and installation established by this operations manual.

The warranty period of operation of meters is 3 years from the moment of their sale. In the absence of a mark on the date of sale, the warranty period is determined from the date of issue.

When exporting, the manufacturer guarantees the quality of meters and their compliance with the requirements of the operations manual for 3 years from the time of meters crossing the State Border of Ukraine if the customer complied with the customer operating and storage conditions described in this operations manual and maintaining the seal of the manufacturer.

In the event of failure or non-compliance of meters with the requirements of this operations manual during the warranty period, the meters must be repaired by the organization authorized to carry out warranty repairs or replaced by the manufacturer.

Meters transported, stored, installed, connected, or used in violation of the requirements specified in the operating manual and meters that have damage to the casing, base, clamp pads or the consequences of their thermal heating, damaged seal of the manufacturer, as well as if the product has pronounced mechanical damage received as a result of any actions of the buyer or third parties, not subject to warranty repair, and repaired at the expense of the consumer.

The manufacturer is not responsible for meters that have failed during operation due to incorrect connection.

Post-warranty repairs are carried out by an organization authorized to carry out repairs or by the manufacturer under a separate agreement.

The warranty period of storage is 1 year from the moment of shipment of meters.

Appendix A. Overall and installation dimensions

(Mandatory)

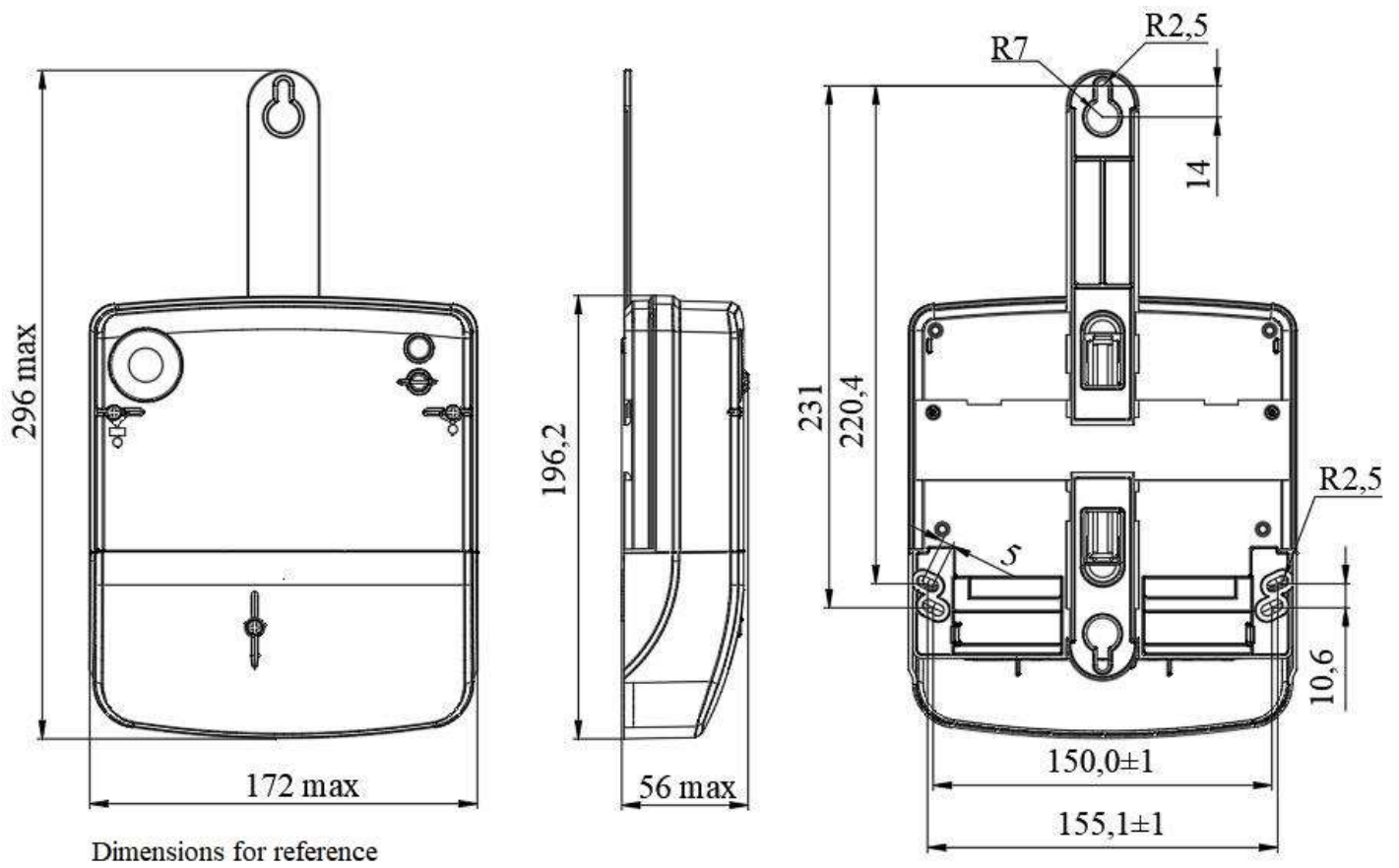

Figure A. 1. Overall and installation dimensions of meters

Appendix B. Wiring diagrams of meter interfaces

(Mandatory)

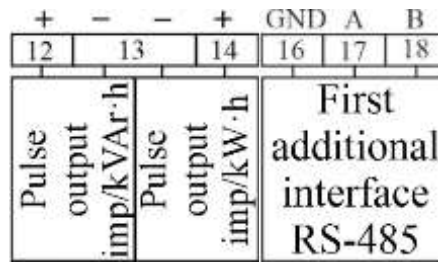

Figure B. 1. Wiring diagram of interfaces and test pulse outputs of meters

Figure B. 1 shows the connection diagram of the interfaces and the main pulse outputs of the meter.

Depending on the meter version, terminals 12, 16...18 may not be installed or may not be used.

Appendix C. Schemes for connecting meters to the consumer network

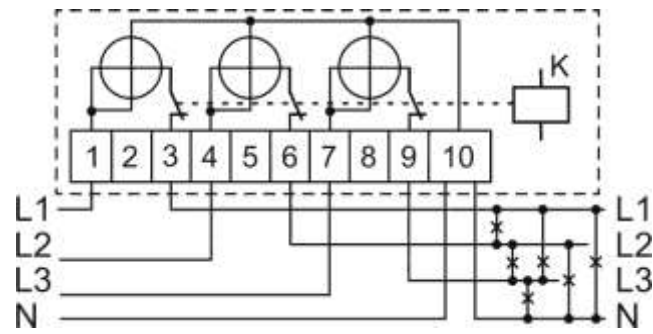

Figure B. 1. Connection of meters types NIK 2303...P1..., NIK 2303...P3..., NIK 2303...P6...

Figure B. 1 shows the scheme of connecting meters to the consumer network. The presence of the load cut-off relay "K" depends on the version of the meter.

Appendix D. Table of OBIS codes that can be displayed

Table D. 1. List of OBIS codes that can be displayed on the screen

(the number of codes depends on the modification of the meter)

№	Measured values	OBIS-code
1.	Indication of the current time of the meter hours in the format "hours: minutes: seconds"	0.9.1
2.	Indication of the current date of the meter hours in the format "day-month-year"	0.9.2
3.	Indication of the unique serial number of the meter	96.1.0
4.	Meter type indication	96.1.1
5.	Software version indication	96.1.10
6.	Software checksum indication	96.1.11
7.	Current transformation coefficient	0.4.2
8.	Voltage transformation coefficient	0.4.3
9.	Active energy (1 + 4 quadrant), kW·h	1.8.0
10.	Active energy (1 + 4 quadrant) of phase L1, kW·h	21.8.0
11.	Active energy (1 + 4 quadrant) of phase L2, kW·h	41.8.0
12.	Active energy (1 + 4 quadrant) of phase L3, kW·h	61.8.0
13.	Active energy at the nth rate, kW·h (n is from 1 to 4)	1.8.n (1.8.1-1.8.4)
14.	Active energy (2 + 3 quadrants), kW·h	2.8.0
15.	Active energy (2 + 3 quadrants) of phase L1, kW·h	22.8.0
16.	Active energy (2 + 3 quadrants) of phase L2, kW·h	42.8.0
17.	Active energy (2 + 3 quadrants) of phase L3, kW·h	62.8.0
18.	Active energy at the nth rate, kWh (n - from 1 to 4)	2.8.n (2.8.1-2.8.4)
19.	Reactive energy (1 + 2 quadrant), kVAr·h	3.8.0
20.	Reactive energy (1 + 2 quadrant) of phase L1, kVAr·h	23.8.0
21.	Reactive energy (1 + 2 quadrant) of phase L2, kVAr·h	43.8.0
22.	Reactive energy (1 + 2 quadrant) of phase L3, kVAr·h	63.8.0
23.	Reactive energy (1 + 2 quadrant) at the nth rate, kVAr·h (n - from 1 to 4)	3.8.n (3.8.1-3.8.4)
24.	Reactive energy (3 + 4 quadrants), kVAr·h	4.8.0
25.	Reactive energy (3 + 4 quadrants) of phase L1, kVAr·h	24.8.0
26.	Reactive energy (3 + 4 quadrants) of phase L2, kVAr·h	44.8.0
27.	Reactive energy (3 + 4 quadrants) of phase L3, kVAr·h	64.8.0
28.	Reactive energy (3 + 4 quadrants) at the nth rate, kVAr·h (n - from 1 to 4)	4.8.n (4.8.1-4.8.4)
29.	Reactive energy (1 quadrant) for A +, kVAr·h	5.8.0
30.	Reactive energy (1 quadrant) for A + phase L1, kVAr·h	25.8.0
31.	Reactive energy (1 quadrant) for A + phase L2, kVAr·h	45.8.0
32.	Reactive energy (1 quadrant) for A + phase L3, kVAr·h	65.8.0
33.	Reactive energy (1 quadrant) for A + at the nth rate, kVAr·h (n - from 1 to 4)	5.8.n (5.8.1-5.8.4)
34.	Reactive energy (2 quadrant) for A-, kVAr·h	6.8.0
35.	Reactive energy (2 quadrant) for A-phase L1, kVAr·h	26.8.0
36.	Reactive energy (2 quadrant) for A-phase L2, kVAr·h	46.8.0
37.	Reactive energy (2 quadrant) for A-phase L3, kVAr·h	66.8.0
38.	Reactive energy (2 quadrants) for A - according to the nth rate, kVAr·h (n - from 1 to 4)	6.8.n (6.8.1-6.8.4)
39.	Reactive energy (3 quadrant) for A-, kVAr·h	7.8.0
40.	Reactive energy (3 quadrant) for A-phase L1, kVAr·h	27.8.0
41.	Reactive energy (3 quadrant) for A-phase L2, kVAr·h	47.8.0

№	Measured values	OBIS-code
42.	Reactive energy (3 quadrant) for A-phase L3, kVAr·h	67.8.0
43.	Reactive energy (3 quadrant) for A - according to the nth rate, kVAr·h (n - from 1 to 4)	7.8.n (7.8.1-7.8.4)
44.	Reactive energy (4 quadrant) for A +, kVAr·h	8.8.0
45.	Reactive energy (4 quadrant) for A + phase L1, kVAr·h	28.8.0
46.	Reactive energy (4 quadrant) for A + phase L2, kVAr·h	48.8.0
47.	Reactive energy (4 quadrant) for A + phase L3, kVAr·h	68.8.0
48.	Reactive energy (4 quadrant) for A + at the nth rate, kVAr·h (n - from 1 to 4)	8.8.n (8.8.1-8.8.4)
49.	Total energy S + (1 + 4 quadrants), kVA · h	9.8.0
50.	Total energy S + (1 + 4 quadrants) of phase L1, kVA · h	29.8.0
51.	Total energy S + (1 + 4 quadrants) of phase L2, kVA · h	49.8.0
52.	Total energy S + (1 + 4 quadrants) of phase L3, kVA · h	69.8.0
53.	Total energy S- (2 + 3 quadrants), kVA · h	10.8.0
54.	Total energy of S- (2 + 3 quadrants) phase L1, kVA · h	30.8.0
55.	Total energy of S- (2 + 3 quadrants) phase L2, kVA · h	50.8.0
56.	Total energy of S- (2 + 3 quadrants) phase L3, kVA · h	70.8.0
57.	Active energy A + + A- , kW · h	15.8.0
58.	Active energy A + + A- phase L1, kW · h	35.8.0
59.	Active energy A + + A- phase L2, kW · h	55.8.0
60.	Active energy A + + A- phase L3, kW · h	75.8.0
61.	Active energy A + + A- according to the nth rate, kWh (n - from 1 to 4)	15.8.n (15.8.1-15.8.4)
62.	Active energy A + - A- , kW · h	16.8.0
63.	Active energy A + - A-) phase L1, kW · h	36.8.0
64.	Active energy A + - A-) phase L2, kW · h	56.8.0
65.	Active energy A + - A-) phase L3, kW · h	76.8.0
66.	Active energy A + - A- at the nth rate, kW · h	16.8.n (16.8.1-16.8.4)
67.	Active energy (1 quadrant), kWh	17.8.0
68.	Active energy (1 quadrant) of phase L1, kWh	37.8.0
69.	Active energy (1 quadrant) of phase L1, kWh	57.8.0
70.	Active energy (1 quadrant) of phase L1, kWh	77.8.0
71.	Active energy (2 quadrant), kWh	18.8.0
72.	Active energy (2 quadrant) of phase L1, kWh	38.8.0
73.	Active energy (2 quadrant) of phase L1, kWh	58.8.0
74.	Active energy (2 quadrant) of phase L1, kWh	78.8.0
75.	Active energy (3 quadrant), kWh	19.8.0
76.	Active energy (3 quadrant) of phase L1, kWh	39.8.0
77.	Active energy (3 quadrant) of phase L1, kWh	59.8.0
78.	Active energy (3 quadrant) of phase L1, kWh	79.8.0
79.	Active energy (4 quadrant), kWh	20.8.0
80.	Active energy (4 quadrant) of phase L1, kWh	40.8.0
81.	Active energy (4 quadrant) of phase L1, kWh	60.8.0
82.	Active energy (4 quadrant) of phase L1, kWh	80.8.0
83.	Instant active power (1 + 4 quadrants), kW	1.7.0
84.	Instantaneous active power (1 + 4 quadrants) of phase L1, kW	21.7.0
85.	Instantaneous active power (1 + 4 quadrants) of phase L2, kW	41.7.0
86.	Instantaneous active power (1 + 4 quadrants) of phase L3, kW	61.7.0
87.	Instantaneous active power (2 + 3 quadrants), kW	2.7.0
88.	Instantaneous active power (2 + 3 quadrants) of phase L1, kW	22.7.0
89.	Instantaneous active power (2 + 3 quadrants) of phase L2, kW	42.7.0

№	Measured values	OBIS-code
90.	Instantaneous active power (2 + 3 quadrants) of phase L3, kW	62.7.0
91.	Instantaneous reactive power (1 + 2 quadrants), kVAr	3.7.0
92.	Instantaneous reactive power (1 + 2 quadrants) of phase L1, kVAr	23.7.0
93.	Instantaneous reactive power (1 + 2 quadrants) of phase L2, kVAr	43.7.0
94.	Instantaneous reactive power (1 + 2 quadrants) of phase L3, kVAr	63.7.0
95.	Instantaneous reactive power (3 + 4 quadrants), kVAr	4.7.0
96.	Instantaneous reactive power (3 + 4 quadrants) of phase L1, kVAr	24.7.0
97.	Instantaneous reactive power (3 + 4 quadrants) of phase L2, kVAr	44.7.0
98.	Instantaneous reactive power (3 + 4 quadrants) of phase L3, kVAr	64.7.0
99.	Instantaneous reactive power on the n-th quadrant, kVAr	n.7.0 (5.7.0-8.7.0)
100.	Instantaneous reactive power on the n-th quadrant of phase L1, kVAr	n.7.0 (25.7.0-28.7.0)
101.	Instantaneous reactive power on the n-th quadrant of phase L2, kVAr	n.7.0 (45.7.0-48.7.0)
102.	Instantaneous reactive power on the n-th quadrant of phase L3, kVAr	n.7.0 (65.7.0-68.7.0)
103.	Instant total power S + (1 + 4 quadrants), kVA	9.7.0
104.	Instantaneous total power S + (1 + 4 quadrants) of phase L1, kVA	29.7.0
105.	Instantaneous total power S + (1 + 4 quadrants) of phase L2, kVA	49.7.0
106.	Instantaneous total power S + (1 + 4 quadrants) of phase L3, kVA	69.7.0
107.	Instantaneous full power S- (2 + 3 quadrants), kVA	10.7.0
108.	Instantaneous total power of S- (2 + 3 quadrants) phase L1, kVA	30.7.0
109.	Instantaneous total power of S- (2 + 3 quadrants) phase L2, kVA	50.7.0
110.	Instantaneous total power of S- (2 + 3 quadrants) phase L3, kVA	70.7.0
111.	Instant active power A + + A-), kW	15.7.0
112.	Instantaneous active power A + + A-) phase L1, kW	35.7.0
113.	Instantaneous active power A + + A-) phase L2, kW	55.7.0
114.	Instantaneous active power A + + A-) phase L3, kW	75.7.0
115.	Instant active power A + - A-), kW	16.7.0
116.	Instantaneous active power A + - A-) phase L1, kW	36.7.0
117.	Instantaneous active power A + - A-) phase L2, kW	56.7.0
118.	Instantaneous active power A + - A-) phase L3, kW	76.7.0
119.	Instantaneous active power on the nth quadrant, kW	n.7.0 (17.7.0-20.7.0)
120.	Instantaneous active power on the n-th quadrant of phase L1, kW	n.7.0 (37.7.0-40.7.0)
121.	Instantaneous active power on the n-th quadrant of phase L2, kW	n.7.0 (57.7.0-60.7.0)
122.	Instantaneous active power on the n-th quadrant of phase L3, kW	n.7.0 (77.7.0-80.7.0)
123.	The current strength of phase L1, A	31.7.0
124.	The current strength of phase L2, A	51.7.0
125.	The current strength of phase L3, A	71.7.0
126.	Phase voltage L1, B	32.7.0
127.	Phase voltage L2, V	52.7.0
128.	Phase voltage L3, V	72.7.0
129.	Phase power factor L1	33.7.0
130.	Phase power factor L2	53.7.0
131.	Phase power factor L3	73.7.0
132.	The value of the fundamental harmonic of the phase L1, Hz	34.7.0
133.	The value of the fundamental harmonic of the phase L2, Hz	54.7.0
134.	The value of the fundamental harmonic of the phase L3, Hz	74.7.0

№	Measured values	OBIS-code
135.	The angle between phases L1 and L2	81.7.10
136.	The angle between phases L1 and L3	81.7.20

Appendix E. Error codes

Table E. 1 Error codes of meters

Error Code	Value	Action
Err 006	Real-time clock failure	Check if the backup battery has failed. Set the clock via the optocoupler or one of the interfaces. Check whether the rate grid parameterization is performed correctly
Err 016	Internal system failure	Contact your power company and service center
Err 040	The terminal cover of the meter is open	Install the terminal cover, or tighten the terminal cover sealing screw
Err 044	The cover of the casing of the meter is open	Contact your power company and service center
Err 051	Internal system failure	Contact your power company and service center
Err 090	Inequality of currents in phase and neutral circuits	Check the meter connection diagram
Err 091	Reverse current (does not occur in the versions of meters that measure active electrical energy in the forward and reverse directions)	Check the meter connection diagram
Err 200	Internal system failure	Contact your power company and service center
Err 201	Internal system failure	Contact your power company and service center
Err 205	Internal system failure	Contact your power company and service center
Err 206	Internal system failure	Contact your power company and service center
Err 230	Internal system failure	Contact your power company and service center
Err 231	Internal system failure	Contact your power company and service center
Err 232	Parameterization error	Check whether the rate grid parameterization is performed correctly
Err 237	Internal system failure	Contact your power company and service center
rAd, o	Trigger of the electromagnetic field sensor	Contact your power company
ПРРРХ	Trigger of the magnetic field sensor	Contact your power company

Appendix F. Scheme of the rate grid of the meter

Figure F. 1 shows a simplified scheme of configuration and operation of the rate grid of the meter.

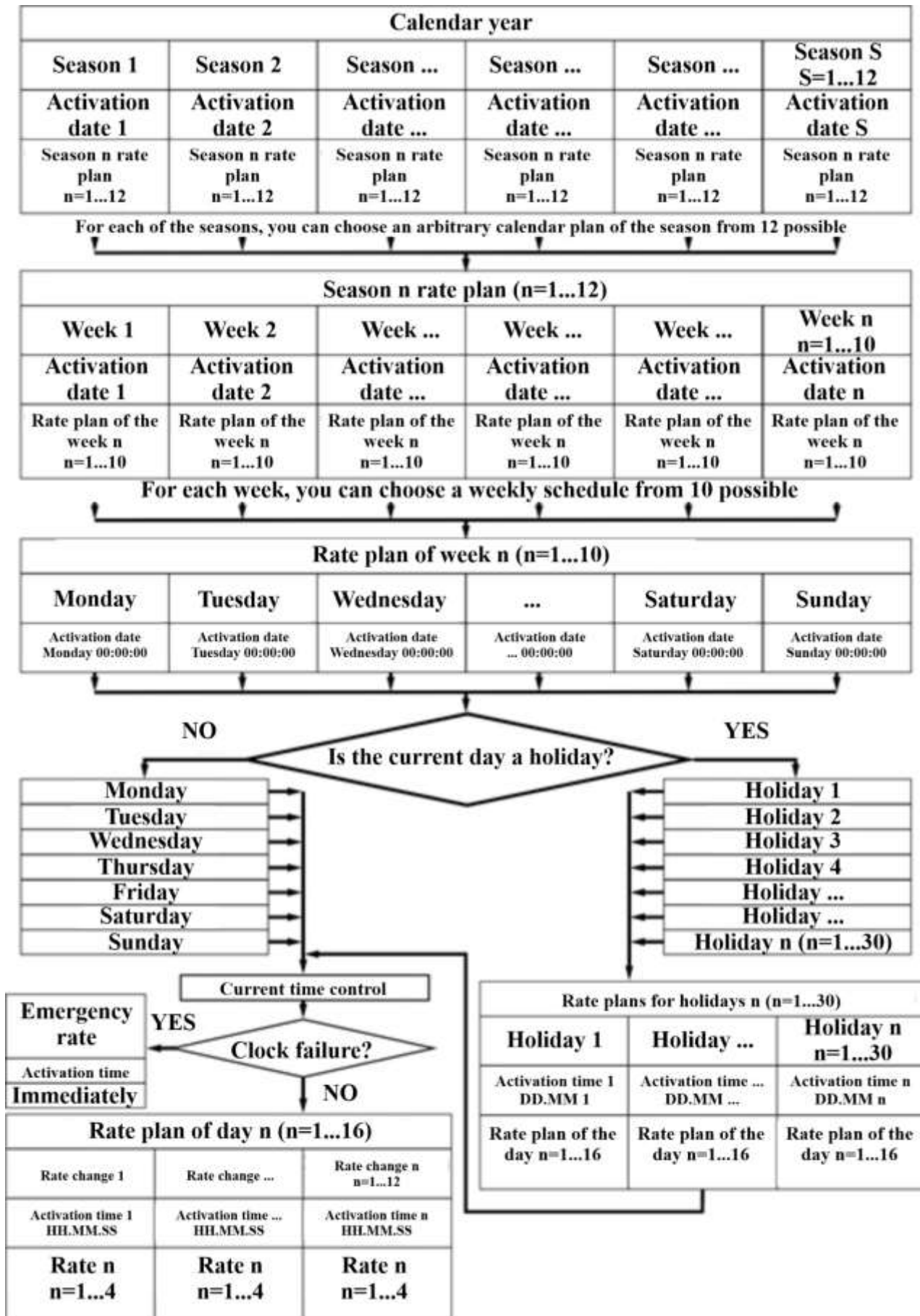

Figure F. 1. Rate grid