



ELECTROTECHNICAL TESTING INSTITUTE
Pod Lisem 129
171 02 Praha 8 - Troja

No. of pages: 1
No. of annexes/No. of an. pages: 2/38

No. of the Test Report: 701588-01/01

Issued: 31. 7. 2017



TEST REPORT

Name of product: Luminaire for road and street lighting
Type of product: URBINI LED, class I
Ratings: 220-240 V, 50/60Hz, 21, 29, 38 W, IK 08, IP 66
Class I
Serial number: -
Manufacturer: LUG Light Factory Sp. z o.o.,
ul. Gorzowska 11, 65-127 Zielona Góra,
Republic of Poland
Production site: LUG Light Factory Sp. z o.o.,
ul. Gorzowska 11, 65-127 Zielona Góra,
Republic of Poland
Ordering firm: LUG Light Factory Sp. z o.o.,
ul. Gorzowska 11, 65-127 Zielona Góra,
Republic of Poland
Number of tested samples: 1
Samples submitted on: 3. 7. 2017
Location of testing: EZÚ
Tested from 3. 7. 2017 **through** 31. 7. 2017
Other data: -
The product was tested according to: IEC 60598-1:2014,
IEC 60598-2-3:02,
EN 60598-1:15,
EN 60598-2-3:03+A1:11,
~~IEC 62471:2006~~ blue light hazard only

Compiled by:  Lukáš Fér



Approved by:  Zdeněk Dvořák
Testing laboratory technical manager

Test results stated in the test report apply only to the tested subject and unless specified otherwise in the test report, the tests were performed using the method and under the conditions determined in the test regulations, technical norm, instructions for use and information provided by the manufacturer on the tested subject and using accessories required by the manufacturer.
Without written consent, this report must not be reproduced in any other way than as a whole.



Test Report issued under the responsibility of:



TEST REPORT
IEC / EN 60598-2-3
Luminaires
Part 2: Particular requirements
Section 3: Luminaires for road and street lighting

Report Number..... : 701588-01/01
Date of issue : 31. 07. 2017
Total number of pages 37 + 1 Atachements (one page)

Name of Testing Laboratory preparing the Report **Elektrotechnický zkušební ústav (EZÚ)**
Pod Lisem 129, 171 02 Praha 71 – Troja, Czech Republic

Applicant's name LUG Light Factory Sp.z o.o.
Address Ul. Grozowska 11, 65-127 Zilena Góra, Poland

Test specification:

Standard : IEC 60598-1:2014,
IEC 60598-2-3:2002 + A1:2011
EN 60598-1:2015,
EN 60598-2-3:2003+A1:2011

Test procedure : CB, ENEC Scheme

Non-standard test method : N/A

Test Report Form No..... : IEC60598_2_3J

Test Report Form(s) Originator : Intertek Semko AB

Master TRF : 2014-09

Copyright © 2014 IEC System of Conformity Assessment Schemes for Electrotechnical Equipment and Components (IECEE System). All rights reserved.



This publication may be reproduced in whole or in part for non-commercial purposes as long as the IECEE is acknowledged as copyright owner and source of the material. IECEE takes no responsibility for and will not assume liability for damages resulting from the reader's interpretation of the reproduced material due to its placement and context.

If this Test Report Form is used by non-IECEE members, the IECEE/IEC logo and the reference to the CB Scheme procedure shall be removed.

This report is not valid as a CB Test Report unless signed by an approved CB Testing Laboratory and appended to a CB Test Certificate issued by an NCB in accordance with IECEE 02.

General disclaimer:

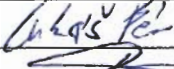
The test results presented in this report relate only to the object tested.
This report shall not be reproduced, except in full, without the written approval of the Issuing CB Testing Laboratory. The authenticity of this Test Report and its contents can be verified by contacting the NCB, responsible for this Test Report.

Test item description	Luminaires for road and street lighting	
Trade Mark		
Manufacturer	LUG Light Factory Sp.z o.o.	
Model/Type reference	URBINI LED see page 4	
Ratings	220-240 V, 50-60 Hz, 21, 29, 38 W LED, IP 66, IK08, class I	
Responsible Testing Laboratory (as applicable), testing procedure and testing location(s):		
<input checked="" type="checkbox"/>	CB Testing Laboratory:	
Testing location/ address	Elektrotechnický zkušební ústav (EZÚ) Pod Lisem 129, 171 02 Praha 71 – Troja, Czech Republic	
<input type="checkbox"/>	Associated CB Testing Laboratory:	
Testing location/ address		
Tested by (name, function, signature)	Lukáš Fér	
Approved by (name, function, signature) ...:	Zdeněk Dvořák	
<input type="checkbox"/>	Testing procedure: TMP/CTF Stage 1:	
Testing location/ address		
Tested by (name, function, signature)		
Approved by (name, function, signature) ...:		
<input type="checkbox"/>	Testing procedure: WMT/CTF Stage 2:	
Testing location/ address		
Tested by (name + signature)		
Witnessed by (name, function, signature) ..:		
Approved by (name, function, signature) ...:		
<input type="checkbox"/>	Testing procedure: SMT/CTF Stage 3 or 4:	
Testing location/ address		
Tested by (name, function, signature)		
Witnessed by (name, function, signature) ..:		
Approved by (name, function, signature) ...:		
Supervised by (name, function, signature) :		

List of Attachments (including a total number of pages in each attachment):

Annex 1: components (one page)
 Annex 2: temperature measurements, thermal tests of Section 12 (one page)
 Annex 3: photo (two pages)
 Annex 4: instruction (two pages)
 Attachment 1: Photobiological hazard ČSN EN 62471 blue light hazard only (one page)

Summary of testing:

Tests performed (name of test and test clause): all required tests

Testing location: as above

Summary of compliance with National Differences: ---

List of countries addressed

The product fulfils the requirements of _____ (insert standard number and edition and delete the text in parenthesis, leave it blank or delete the whole sentence, if not applicable)

Copy of marking plate:

The artwork below may be only a draft. The use of certification marks on a product must be authorized by the respective NCBs that own these marks.



Test item particulars	
Classification of installation and use : Luminaires for road and street lighting	
Supply Connection : Wires :	
Possible test case verdicts:	
- test case does not apply to the test object : N/A (Not applicable)	
- test object does meet the requirement : P (Pass)	
- test object does not meet the requirement : F (Fail)	
Testing	
Date of receipt of test item : 03. 07. 2017	
Date (s) of performance of tests : 03. 07. 2017 - 31. 07. 2017	
General remarks:	
"(See Enclosure #)" refers to additional information appended to the report. "(See appended table)" refers to a table appended to the report.	
Throughout this report a <input checked="" type="checkbox"/> comma / <input type="checkbox"/> point is used as the decimal separator.	
Manufacturer's Declaration per sub-clause 4.2.5 of IEC60598-1:	
The application for obtaining a CB Test Certificate includes more than one factory location and a declaration from the Manufacturer stating that the sample(s) submitted for evaluation is (are) representative of the products from each factory has been provided.....	<input type="checkbox"/> Yes <input checked="" type="checkbox"/> Not applicable
When differences exist; they shall be identified in the General product information section.	
Name and address of factory (ies) : --- 	
General product information:	
The tested sample was selected in accordance with Annex S of ČSN EN 60958-1.	
Tested type: LUG URBINI LED 130232.5L111.101 220-240 V, 50/60 Hz, IP 66, class I, ta 35 °C, IK 08	

IEC / EN 60598-2-3			
Clause	Requirement + Test	Result - Remark	Verdict

3.2 (0) GENERAL TEST REQUIREMENTS			
3.2 (0.1)	Information for luminaire design considered	Standard Yes <input checked="" type="checkbox"/> No <input type="checkbox"/>	—
3.2 (0.3)	More sections applicable	Yes <input type="checkbox"/> No <input checked="" type="checkbox"/>	—

3.4 (2) CLASSIFICATION			
3.4 (2.2)	Type of protection	Class I	—
3.4 (2.3)	Degree of protection	IP66	—
3.4 (2.4)	Luminaire suitable for direct mounting on normally flammable surfaces	Yes <input checked="" type="checkbox"/> No <input type="checkbox"/>	—
3.4 (2.5)	Luminaire for normal use	Yes <input checked="" type="checkbox"/> No <input type="checkbox"/>	—
	Luminaire for rough service	Yes <input type="checkbox"/> No <input checked="" type="checkbox"/>	—
3.4 (-)	Modes of installation of road or street lighting		—
	a) on a pipe	Yes <input checked="" type="checkbox"/> No <input type="checkbox"/>	—
	b) on a mast arm	Yes <input checked="" type="checkbox"/> No <input type="checkbox"/>	—
	c) on a post top	Yes <input checked="" type="checkbox"/> No <input type="checkbox"/>	—
	d) on span or suspension wires	Yes <input type="checkbox"/> No <input checked="" type="checkbox"/>	—
	e) on a wall	Yes <input checked="" type="checkbox"/> No <input type="checkbox"/>	—

3.5 (3) MARKING			
3.5 (3.2)	Mandatory markings		P
	Position of the marking		P
	Format of symbols/text		P
3.5 (3.3)	Additional information		P
	Language of instructions		P
3.5 (3.3.1)	Combination luminaires		N/A
3.5 (3.3.2)	Nominal frequency in Hz		P
3.5 (3.3.3)	Operating temperature		N/A
3.5 (3.3.4)	Symbol or warning notice		N/A
3.5 (3.3.5)	Wiring diagram		P
3.5 (3.3.6)	Special conditions		N/A
3.5 (3.3.7)	Metal halide lamp luminaire – warning		N/A
3.5 (3.3.8)	Limitation for semi-luminaires		N/A
3.5 (3.3.9)	Power factor and supply current		N/A

IEC / EN 60598-2-3			
Clause	Requirement + Test	Result - Remark	Verdict
3.5 (3.3.10)	Suitability for use indoors		N/A
3.5 (3.3.11)	Luminaires with remote control		N/A
3.5 (3.3.12)	Clip-mounted luminaire – warning		N/A
3.5 (3.3.13)	Specifications of protective shields		N/A
3.5 (3.3.14)	Symbol for nature of supply		N/A
3.5 (3.3.15)	Rated current of socket outlet		N/A
3.5 (3.3.16)	Rough service luminaire		N/A
3.5 (3.3.17)	Mounting instruction for type Y, type Z and some type X attachments		N/A
3.5 (3.3.18)	Non-ordinary luminaires with PVC cable		N/A
3.5 (3.3.19)	Protective conductor current in instruction if applicable		N/A
3.5 (3.3.20)	Provided with information if not intended to be mounted within arm's reach		N/A
3.5 (3.3.21)	Non-replaceable and non-user replaceable light sources information provided		N/A
	Cautionary symbol		N/A
3.5 (3.3.22)	Controllable luminaires, classification of insulation provided		N/A
3.5 (3.4)	Test with water		P
	Test with hexane		P
	Legible after test		P
	Label attached		P
3.5 (-)	Additional information in instruction leaflet		
	a) Design attitude		P
	b) Weight		P
	c) Overall dimensions		P
	d) Maximum projected area if applicable		P
	e) Cross-sectional area of wires if applicable		P
	f) Suitability for indoors use		N/A
	g) Dimensions of the compartment		N/A
	h) Torque setting to be applied to bolts or screws		P
	i) Maximum mounting height		P
3.6 (4)	CONSTRUCTION		
3.6 (4.2)	Components replaceable without difficulty		P

IEC / EN 60598-2-3			
Clause	Requirement + Test	Result - Remark	Verdict
3.6 (4.3)	Wireways smooth and free from sharp edges		P
3.6 (4.4)	Lampholders		
3.6 (4.4.1)	Integral lampholder		N/A
3.6 (4.4.2)	Wiring connection		N/A
3.6 (4.4.3)	Lampholder for end-to-end mounting		N/A
3.6 (4.4.4)	Positioning		N/A
	- pressure test (N)		—
	After test the lampholder comply with relevant standard sheets and show no damage		N/A
	After test on single-capped lampholder the lampholder have not moved from its position and show no permanent deformation		N/A
	- bending test (N)		—
	After test the lampholder have not moved from its position and show no permanent deformation		N/A
3.6 (4.4.5)	Peak pulse voltage		N/A
3.6 (4.4.6)	Centre contact		N/A
3.6 (4.4.7)	Parts in rough service luminaires resistant to tracking		N/A
3.6 (4.4.8)	Lamp connectors		N/A
3.6 (4.4.9)	Caps and bases correctly used		N/A
3.6 (4.4.10)	Light source for lampholder or connection according IEC 60061 not connected another way		N/A
3.6 (4.5)	Starter holders		
	Starter holder in luminaires other than class II		N/A
	Starter holder class II construction		N/A
3.6 (4.6)	Terminal blocks		
	Tails		P
	Unsecured blocks		N/A
3.6 (4.7)	Terminals and supply connections		
3.6 (4.7.1)	Contact to metal parts		P
3.6 (4.7.2)	Test 8 mm live conductor		P
	Test 8 mm earth conductor		P
3.6 (4.7.3)	Terminals for supply conductors		N/A
3.6 (4.7.3.1)	Welded method and material		
	- stranded or solid conductor		N/A
	- spot welding		N/A

IEC / EN 60598-2-3			
Clause	Requirement + Test	Result - Remark	Verdict
	- welding between wires		N/A
	- Type Z attachment		N/A
	- mechanical test according to 15.8.2		N/A
	- electrical test according to 15.9		N/A
	- heat test according to 15.9.2.3 and 15.9.2.4		N/A
3.6 (4.7.4)	Terminals other than supply connection		N/A
3.6 (4.7.5)	Heat-resistant wiring/sleeves		N/A
3.6 (4.7.6)	Multi-pole plug		N/A
	- test at 30 N		N/A
3.6 (4.8)	Switches		
	- adequate rating		N/A
	- adequate fixing		N/A
	- polarized supply		N/A
	- compliance with IEC 61058-1 for electronic switches		N/A
3.6 (4.9)	Insulating lining and sleeves		
3.6 (4.9.1)	Retainment		N/A
	Method of fixing		—
3.6 (4.9.2)	Insulated linings and sleeves:		
	Resistant to a temperature > 20 °C to the wire temperature or		N/A
	a) & c) Insulation resistance and electric strength		N/A
	b) Ageing test. Temperature (°C)		N/A
3.6 (4.10)	Double or reinforced insulation		
3.6 (4.10.1)	No contact, mounting surface – accessible metal parts – wiring of basic insulation		P
	Safe installation fixed luminaires		P
	Capacitors and switches		N/A
	Interference suppression capacitors according to IEC 60384-14		N/A
3.6 (4.10.2)	Assembly gaps:		
	- not coincidental		N/A
	- no straight access with test probe		N/A
3.6 (4.10.3)	Retainment of insulation:		
	- fixed		N/A

IEC / EN 60598-2-3			
Clause	Requirement + Test	Result - Remark	Verdict
	- unable to be replaced; luminaire inoperative		N/A
	- sleeves retained in position		N/A
	- lining in lampholder		N/A
3.6 (4.11)	Electrical connections and current-carrying parts		
3.6 (4.11.1)	Contact pressure		N/A
3.6 (4.11.2)	Screws:		
	- self-tapping screws		P
	- thread-cutting screws		N/A
3.6 (4.11.3)	Screw locking:		
	- spring washer		P
	- rivets		N/A
3.6 (4.11.4)	Material of current-carrying parts		P
3.6 (4.11.5)	No contact to wood or mounting surface		P
3.6 (4.11.6)	Electro-mechanical contact systems		N/A
3.6 (4.12)	Screws and connections (mechanical) and glands		
3.6 (4.12.1)	Screws not made of soft metal		P
	Screws of insulating material		N/A
	Torque test: torque (Nm); part.....:	1,2; Driver cover	P
	Torque test: torque (Nm); part.....:		N/A
	Torque test: torque (Nm); part.....:		N/A
3.6 (4.12.2)	Screws with diameter < 3 mm screwed into metal		N/A
3.6 (4.12.4)	Locked connections:		
	- fixed arms; torque (Nm).....:		N/A
	- lampholder; torque (Nm)		N/A
	- push-button switches; torque 0,8 Nm.....:		N/A
3.6 (4.12.5)	Screwed glands; force (Nm)	2,5	P
3.6 (4.13)	Mechanical strength		
3.6 (4.13.1)	Impact tests:		
	- fragile parts; energy (Nm).....:	Optical part; 5 (IK 08)	P
	- other parts; energy (Nm)	Body, covers; 5 (IK 08)	P
	1) live parts		P
	2) linings		N/A
	3) protection		P
	4) covers		P

IEC / EN 60598-2-3			
Clause	Requirement + Test	Result - Remark	Verdict
3.6 (4.13.3)	Straight test finger		P
3.6 (4.13.4)	Rough service luminaires		
	- IP54 or higher		N/A
	a) fixed		N/A
	b) hand-held		N/A
	c) delivered with a stand		N/A
	d) for temporary installations and suitable for mounting on a stand		N/A
3.6 (4.13.6)	Tumbling barrel		N/A
3.6 (4.14)	Suspensions, fixings and means of adjusting		
3.6 (4.14.1)	Mechanical load:		
	A) four times the weight		N/A
	B) torque 2,5 Nm		N/A
	C) bracket arm; bending moment (Nm).....:		N/A
	D) load track-mounted luminaires		N/A
	E) clip-mounted luminaires, glass-shelve. Thickness (mm)		N/A
	Metal rod. diameter (mm)		N/A
	Fixed luminaire or independent control gear without fixing devices		N/A
3.6 (4.14.2)	Load to flexible cables		
	Mass (kg)		—
	Stress in conductors (N/mm ²)		N/A
	Mass (kg) of semi-luminaire		—
	Bending moment (Nm) of semi-luminaire		N/A
3.6 (4.14.3)	Adjusting devices:		
	- flexing test; number of cycles.....:		N/A
	- strands broken.....:		N/A
	- electric strength test afterwards		N/A
3.6 (4.14.4)	Telescopic tubes: cords not fixed to tube; no strain on conductors		N/A
3.6 (4.14.5)	Guide pulleys		N/A
3.6 (4.14.6)	Strain on socket-outlets		N/A
3.6 (4.15)	Flammable materials		
	- glow-wire test 650°C		N/A

IEC / EN 60598-2-3			
Clause	Requirement + Test	Result - Remark	Verdict
	- spacing ≥ 30 mm		N/A
	- screen withstanding test of 13.3.1		N/A
	- screen dimensions		N/A
	- no fiercely burning material		N/A
	- thermal protection		N/A
	- electronic circuits exempted		N/A
3.6 (4.15.2)	Luminaires made of thermoplastic material with lamp control gear		
	a) construction		N/A
	b) temperature sensing control		N/A
	c) surface temperature		N/A
3.6 (4.16)	Luminaires for mounting on normally flammable surfaces		
	No lamp control gear	(compliance with Section 12)	N/A
3.6 (4.16.1)	Lamp control gear spacing:		
	- spacing 35 mm		P
	- spacing 10 mm		N/A
3.6 (4.16.2)	Thermal protection:		
	- in lamp control gear		P
	- external		N/A
	- fixed position		N/A
	- temperature marked lamp control gear		P
3.6 (4.16.3)	Design to satisfy the test of 12.6	(see clause 12.6)	N/A
3.6 (4.17)	Drain holes		
	Clearance at least 5 mm		N/A
3.6 (4.18)	Resistance to corrosion		
3.6 (4.18.1)	- rust-resistance		N/A
3.6 (4.18.2)	- season cracking in copper		N/A
3.6 (4.18.3)	- corrosion of aluminium		N/A
3.6 (4.19)	Igniters compatible with ballast		N/A
3.6 (4.20)	Rough service vibration		N/A
3.6 (4.21)	Protective shield		
3.6 (4.21.1)	Shield fitted if tungsten halogen lamps or metal halide lamps		N/A
	Shield of glass if tungsten halogen lamps		N/A
3.6 (4.21.2)	Particles from a shattering lamp not impair safety		N/A

IEC / EN 60598-2-3			
Clause	Requirement + Test	Result - Remark	Verdict
3.6 (4.21.3)	No direct path		N/A
3.6 (4.21.4)	Impact test on shield		N/A
	Glow-wire test on lamp compartment.....:		N/A
3.6 (4.22)	Attachments to lamps not cause overheating or damage		N/A
3.6 (4.23)	Semi-luminaires comply Class II		N/A
3.6 (4.24)	Photobiological hazards		
3.6 (4.24.1)	No excessive UV radiation if tungsten halogen lamps and metal halide lamps (Annex P)		N/A
3.6 (4.24.2)	Retinal blue light hazard	Risk Group 1	
	Luminaires with E_{thr} :		
	a) Fixed luminaires		N/A
	- distance x m, borderline between RG1 and RG2....:		N/A
	- marking and instruction according 3.2.23		N/A
	b) Portable and handheld luminaires		N/A
	- marking according 3.2.23 if RG1 exceeded at 200 mm according to IEC/TR 62778		N/A
	Portable luminaires for children IEC 60598-2-10 and Mains socket outlet nightlights IEC 60598-2-12 not exceed RG1 at 200 mm according to IEC/62778		N/A
3.6 (4.25)	Mechanical hazard		
	No sharp point or edges		P
3.6 (4.26)	Short-circuit protection		
3.6 (4.26.1)	Adequate means of uninsulated accessible SELV parts		N/A
3.6 (4.26.2)	Short-circuit test with test chain according 4.26.3		
	Test chain not melt through		N/A
	Test sample not exceed values of Table 12.1 and 12.2		N/A
3.6 (4.27)	Terminal blocks with integrated screwless earthing contacts		
	Test according Annex V		N/A
	Pull test of terminal fixing (20 N)		N/A
	After test, resistance < 0,05 Ω		N/A
	Pull test of mechanical connection (50 N)		N/A
	After test, resistance < 0,05 Ω		N/A
	Voltage drop test, resistance < 0,05 Ω		N/A

IEC / EN 60598-2-3			
Clause	Requirement + Test	Result - Remark	Verdict
3.6 (4.28)	Fixing of thermal sensing control		
	Not plug-in or easily replaceable type		N/A
	Reliably kept in position		N/A
	No adhesive fixing if UV radiations from a lamp can degrade the fixing		N/A
	Not outside the luminaire enclosure		N/A
	Test of adhesive fixing:		
	Max. temperature on adhesive material (°C).....:		—
	100 cycles between t min and t max		N/A
	Temperature sensing control still in position		N/A
3.6 (4.29)	Luminaires with non-replaceable light source		
	Not possible to replace light source		N/A
	Live part not accessible after parts have been opened by hand or tools		N/A
3.6 (4.30)	Luminaires with non-user replaceable light source		
	If protective cover provide protection against electric shock and marked with "caution, electric shock risk" symbol:		
	Minimum two fixing means		N/A
3.6 (4.31)	Insulation between circuits		
	Circuits insulated from LV supply fulfil requirements according 4.31.1 – 4.31.3		P
	Controllable luminaires requiring same level of insulation for all components, the insulation between control terminals and LV supply fulfil requirements according 4.31.1 – 4.31.3		P
3.6 (4.31.1)	SELV circuits		
	Used SELV source		P
	Voltage ≤ ELV		P
	Insulating of SELV circuits from LV supply		P
	Insulating of SELV circuits from other non SELV circuits		N/A
	Insulating of SELV circuits from FELV		N/A
	Insulating of SELV circuits from other SELV circuits		N/A
	SELV circuits insulated from accessible parts according Table X.1		P
	Plugs not able to enter socket-outlets of other voltage systems		N/A

IEC / EN 60598-2-3			
Clause	Requirement + Test	Result - Remark	Verdict
	Socket outlets does not admit plugs of other voltage systems		N/A
	Plugs and socket-outlets does not have protective conductor contact		N/A
3.6 (4.31.2)	FELV circuits		
	Used FELV source		N/A
	Voltage \leq ELV		N/A
	Insulating of FELV circuits from LV supply		N/A
	FELV circuits insulated from accessible parts according Table X.1		N/A
	Plugs not able to enter socket-outlets of other voltage systems		N/A
	Socket outlets does not admit plugs of other voltage systems		N/A
	Socket-outlets does not have protective conductor contact		N/A
3.6 (4.31.3)	Other circuits		
	Other circuits insulated from accessible parts according Table X.1		P
	Class II construction with equipotential bonding for protection against indirect contacts with live parts:		
	- conductive parts are connected together		N/A
	- test according 7.2.3 of above		N/A
	- conductive part not cause an electric shock in case of an insulation fault		N/A
	- equipotential bonding in master/slave applications		N/A
	- master luminaire provided with terminal for accessible conductive parts of slave luminaires		N/A
	- slave luminaire constructed as class I		N/A
3.6 (4.32)	Overvoltage protective devices		
	Comply with IEC 61643-11		N/A
	External to controlgear and connected to earth:		
	- only in fixed luminaires		N/A
	- only connected to protective earth		N/A
3.6.1 (-)	At least IP X3 or X5 respectively. IP		N/A
	Column-integrated luminaires:		
	- parts below 2,5 m. IP		N/A
	- parts above 2,5 m. IP	IP66	P

IEC / EN 60598-2-3			
Clause	Requirement + Test	Result - Remark	Verdict
3.6.2 (-)	Suspension on span wires		N/A
3.6.3 (-)	Means for attaching the luminaire or external parts to its support appropriate to the weight		N/A
3.6.3.1 (-)	Static load test		
	- drag coefficient	1,2	P
	- loaded area (m ²)	0,03489	P
	- used load (N)	51	P
	- measured deformation (cm/m)	0,1	P
	- no rotation		P
3.6.4 (-)	Adjustable lampholders		N/A
3.6.5 (-)	Luminaires installed above 5 m, glass covers shall be:		
	a) glass that fractures into small pieces (test according to 3.6.5.1), or		N/A
	b) glass having a high impact shock resistance (test according to 3.6.5.2), or		N/A
	c) protected by any means to retain glass fragments		N/A
	For tunnel luminaires 3.6.5.1 apply		N/A
	Method of protection declared by the manufacturer		N/A
3.6.5.1 (-)	Protection by the use of glass that fractures into small pieces		
	- number of particles is more than 40		N/A
3.6.5.2 (-)	Protection by the use of high impact resistant glass		
3.6.5.2.1 (-)	Glass covers have high mechanical strength		N/A
	Test according IEC 62262 with test apparatus according IEC 60068-2-75 with impact energy of 5J on preconditioned sample		N/A
3.6.5.2.2 (-)	Glass covers not break into large pieces		N/A
	- test according 3.6.5.1, number of particles is more than 20		N/A
3.6.6 (-)	Connection compartment of column-integrated luminaire		
	- provides adequate space		N/A
	- means for attachment		N/A
	- means for attachment of metal corrosion-resistant		N/A
3.6.7 (-)	Compliance with ISO standard or other		N/A
3.6.8 (-)	Doors of column-integrated luminaires:		
	- corrosion-resistant		N/A
	- opening only possible for an authorized person		N/A

IEC / EN 60598-2-3			
Clause	Requirement + Test	Result - Remark	Verdict
	- impact test 5 Nm		N/A
	- sample show no damage		N/A
3.6.9 (-)	Column-integrated luminaire:		
	- dimension of the cable entry slot (mm)		N/A
	- cable path from the slot to the connection compartment (mm)		N/A
	- cable path free from obstruction that might cause abrasion of the cable		N/A

3.7 (11)	CREEPAGE DISTANCES AND CLEARANCES		
3.7 (11.2)	Creepage distances and clearances	See Table 3.7 (11.2)	
	Working voltage (V)	230	—
	Rated pulse voltage (kV)		—
	Voltage form	Sinusoidal <input checked="" type="checkbox"/> Non-sinusoidal <input type="checkbox"/>	—
	PTI	< 600 <input checked="" type="checkbox"/> ≥ 600 <input type="checkbox"/>	—
	Impulse withstand category (Normal category II) (Category III Annex U)	Category II <input type="checkbox"/> Category III <input type="checkbox"/>	—

3.8 (7)	PROVISION FOR EARTHING		
3.8 (7.2.1 + 7.2.3)	Accessible metal parts		P
	Metal parts in contact with supporting surface		P
	Resistance < 0,5 Ω	0,07	P
	Self-tapping screws used		N/A
	Thread-forming screws		N/A
	Thread-forming screw used in a groove		N/A
	Earth makes contact first		N/A
	Terminal blocks with integrated screwless earthing contacts tested according Annex V		N/A
	Protective earthing of the luminaire not via built-in control gear		N/A
3.8 (7.2.2 + 7.2.3)	Earth continuity in joints, etc.		N/A
3.8 (7.2.4)	Locking of clamping means		N/A
	Compliance with 4.7.3		N/A

IEC / EN 60598-2-3			
Clause	Requirement + Test	Result - Remark	Verdict
	Terminal blocks with integrated screwless earthing contacts tested according Annex V		N/A
3.8 (7.2.5)	Earth terminal integral part of connector socket		N/A
3.8 (7.2.6)	Earth terminal adjacent to mains terminals		N/A
3.8 (7.2.7)	Electrolytic corrosion of the earth terminal		N/A
3.8 (7.2.8)	Material of earth terminal		P
	Contact surface bare metal		N/A
3.8 (7.2.10)	Class II luminaire for looping-in		N/A
	Double or reinforced insulation to functional earth		N/A
3.8 (7.2.11)	Earthing core coloured green-yellow		N/A
	Length of earth conductor		N/A
3.8.1 (-)	Attachment prevented from rotation		P

3.9 (14)	SCREW TERMINALS		
	Separately approved; component list	(see Annex 1)	N/A
	Part of the luminaire	(see Annex 3)	N/A

3.9 (15)	SCREWLESS TERMINALS AND ELECTRICAL CONNECTIONS		
	Separately approved; component list	(see Annex 1)	N/A
	Part of the luminaire	(see Annex 4)	N/A

3.10 (5)	EXTERNAL AND INTERNAL WIRING		
3.10 (5.2)	Supply connection and external wiring		
3.10 (5.2.1)	Means of connection	Prepared wires	P
	Outdoor luminaire has not PVC insulated external wiring if not class III or SELV ≤ 25 V a.c./60 V d.c. or protected from outdoor environment		P
3.10 (5.2.2)	Type of cable	H03VV-F	P
	Nominal cross-sectional area (mm ²)	0,75	P
	Cables equal to IEC 60227 or IEC 60245		P
3.10 (5.2.3)	Type of attachment, X, Y or Z	X	P
3.10 (5.2.5)	Type Z not connected to screws		N/A
3.10 (5.2.6)	Cable entries:		
	- suitable for introduction		N/A
	- adequate degree of protection		N/A

IEC / EN 60598-2-3			
Clause	Requirement + Test	Result - Remark	Verdict
3.10 (5.2.7)	Cable entries through rigid material have rounded edges		P
3.10 (5.2.8)	Insulating bushings:		
	- suitably fixed		N/A
	- material in bushings		N/A
	- material not likely to deteriorate		N/A
	- tubes or guards made of insulating material		N/A
3.10 (5.2.9)	Locking of screwed bushings		N/A
3.10 (5.2.10)	Cord anchorage:		
	- covering protected from abrasion		N/A
	- clear how to be effective		N/A
	- no mechanical or thermal stress		N/A
	- no tying of cables into knots etc.		N/A
	- insulating material or lining		N/A
3.10 (5.2.10.1)	Cord anchorage for type X attachment:		
	a) at least one part fixed		P
	b) types of cable		P
	c) no damaging of the cable		P
	d) whole cable can be mounted		P
	e) no touching of clamping screws		P
	f) metal screw not directly on cable		P
	g) replacement without special tool		P
	Glands not used as anchorage		N/A
	Labyrinth type anchorages		N/A
3.10 (5.2.10.2)	Adequate cord anchorage for type Y and type Z attachment		N/A
3.10 (5.2.10.3)	Tests:		
	- impossible to push cable; unsafe		P
	- pull test: 25 times; pull (N).....: 30	30	P
	- torque test: torque (Nm).....: 0,08	0,08	P
	- displacement ≤ 2 mm		P
	- no movement of conductors		P
	- no damage of cable or cord		P

IEC / EN 60598-2-3			
Clause	Requirement + Test	Result - Remark	Verdict
	- function independent of electrical connection		N/A
3.10 (5.2.11)	External wiring passing into luminaire		N/A
3.10 (5.2.12)	Looping-in terminals		N/A
3.10 (5.2.13)	Wire ends not tinned		P
	Wire ends tinned: no cold flow		N/A
3.10 (5.2.14)	Mains plug same protection		N/A
	Class III luminaire plug		N/A
	No unsafe compatibility		N/A
3.10 (5.2.16)	Appliance inlets (IEC 60320)		N/A
	Installation couplers (IEC 61535)		N/A
	Other appliance inlet or connector according relevant IEC standard		N/A
3.10 (5.2.17)	No standardized interconnecting cables properly assembled		N/A
3.10 (5.2.18)	Used plug in accordance with		
	- IEC 60083		N/A
	- other standard		N/A
3.10 (5.3)	Internal wiring		
3.10 (5.3.1)	Internal wiring of suitable size and type		P
	Through wiring		
	- not delivered/ mounting instruction		N/A
	- factory assembled		P
	- socket outlet loaded (A)..... :		N/A
	- temperatures :	(see Annex 2)	N/A
	Green-yellow for earth only		N/A
3.10 (5.3.1.1)	Internal wiring connected directly to fixed wiring		
	Cross-sectional area (mm ²)..... :	0,5	P
	Insulation thickness		P
	Extra insulation added where necessary		N/A
3.10 (5.3.1.2)	Internal wiring connected to fixed wiring via internal current-limiting device		N/A

IEC / EN 60598-2-3			
Clause	Requirement + Test	Result - Remark	Verdict
	Adequate cross-sectional area and insulation thickness		N/A
3.10 (5.3.1.3)	Double or reinforced insulation for class II		N/A
3.10 (5.3.1.4)	Conductors without insulation		N/A
3.10 (5.3.1.5)	SELV current-carrying parts		N/A
3.10 (5.3.1.6)	Insulation thickness other than PVC or rubber		N/A
3.10 (5.3.2)	Sharp edges etc.		P
	No moving parts of switches etc.		N/A
	Joints, raising/lowering devices		N/A
	Telescopic tubes etc.		N/A
	No twisting over 360°		N/A
3.10 (5.3.3)	Insulating bushings:		
	- suitable fixed		N/A
	- material in bushings		N/A
	- material not likely to deteriorate		N/A
	- cables with protective sheath		N/A
3.10 (5.3.4)	Joints and junctions effectively insulated		N/A
3.10 (5.3.5)	Strain on internal wiring		N/A
3.10 (5.3.6)	Wire carriers		P
3.10 (5.3.7)	Wire ends not tinned		P
	Wire ends tinned: no cold flow		N/A
3.10.1 (-)	Cord anchorage if applicable		N/A
	- pull test: 25 times; pull (N)..... :		N/A
	- torque test: torque (Nm) :		N/A

3.11 (8)	PROTECTION AGAINST ELECTRIC SHOCK		
3.11 (8.2.1)	Live parts not accessible		P
	Basic insulated parts not used on the outer surface without appropriate protection		P
	Basic insulated parts not accessible with standard test finger on portable, settable and adjustable luminaires		P

IEC / EN 60598-2-3			
Clause	Requirement + Test	Result - Remark	Verdict
	Basic insulated parts not accessible with Ø 50 mm probe from outside, other types of luminaires		N/A
	Lamp and starterholders in portable and adjustable luminaires comply with double or reinforced insulation requirements		N/A
	Basic insulation only accessible under lamp or starter replacement		N/A
	Protection in any position		P
	Double-ended tungsten filament lamp		N/A
	Insulation lacquer not reliable		P
	Double-ended high pressure discharge lamp		N/A
	Relevant warning according to 3.2.18 fitted to the luminaire		N/A
3.11 (8.2.2)	Portable luminaire adjusted in most unfavourable position		N/A
3.11 (8.2.3.a)	Class II luminaire:		
	- basic insulated metal parts not accessible during starter or lamp replacement		N/A
	- basic insulation not accessible other than during starter or lamp replacement		N/A
	- glass protective shields not used as supplementary insulation		N/A
3.11 (8.2.3.b)	BC lampholder of metal in class I luminaires shall be earthed		N/A
3.11 (8.2.3.c)	SELV circuits with exposed current carrying parts:		
	Ordinary luminaire:		
	- touch current		N/A
	- no-load voltage		N/A
	Other than ordinary luminaire:		
	- nominal voltage		N/A
3.11 (8.2.4)	Portable luminaire have protection independent of supporting surface		N/A
3.11 (8.2.5)	Compliance with the standard test finger or relevant probe		N/A
3.11 (8.2.6)	Covers reliably secured		P
3.11 (8.2.7)	Discharging of capacitors $\geq 0,5 \mu\text{F}$		N/A
	Portable plug connected luminaire with capacitor		N/A

IEC / EN 60598-2-3			
Clause	Requirement + Test	Result - Remark	Verdict
	Other plug connected luminaire with capacitor		N/A
	Discharge device on or within capacitor		N/A
	Discharge device mounted separately		N/A
3.12 (12)	ENDURANCE TEST AND THERMAL TEST		
3.12.2 (-)	If IP > IP 20 relevant test of (12.4), (12.5) and (12.6) after (9.2) before (9.3) specified in 3.13		—
3.12 (12.3)	Endurance test:		
	- mounting-position	On pipe	—
	- test temperature (°C).....	45	—
	- total duration (h)	240	—
	- supply voltage: Un factor; calculated voltage (V)....	253	—
	- lamp used	LED module	—
3.12 (12.3.2)	After endurance test:		
	- no part unserviceable		P
	- luminaire not unsafe		P
	- no damage to track system		N/A
	- marking legible		P
	- no cracks, deformation etc.		P
3.12 (12.4)	Thermal test (normal operation)	(see Annex 2)	P
3.12 (12.5)	Thermal test (abnormal operation)	(see Annex 2)	N/A
3.12 (12.6)	Thermal test (failed lamp control gear condition):		
3.12 (12.6.1)	Through wiring or looping-in wiring loaded by a current of (A)		—
	- case of abnormal conditions.....		—
	- electronic lamp control gear		N/A
	- measured winding temperature (°C): at 1,1 Un		—
	- measured mounting surface temperature (°C) at 1,1 Un		N/A
	- calculated mounting surface temperature (°C)		N/A
	- track-mounted luminaires		N/A
3.12 (12.6.2)	Temperature sensing control		
	- case of abnormal conditions.....		—

IEC / EN 60598-2-3			
Clause	Requirement + Test	Result - Remark	Verdict
	- thermal link		N/A
	- manual reset cut-out		N/A
	- auto reset cut-out		N/A
	- measured mounting surface temperature (°C).....:		N/A
	- track-mounted luminaires		N/A
3.12 (12.7)	Thermal test (failed lamp control gear in plastic luminaires):		
3.12 (12.7.1)	Luminaire without temperature sensing control		N/A
3.12 (12.7.1.1)	Luminaire with fluorescent lamp $\leq 70W$		N/A
	Test method 12.7.1.1 or Annex W		—
	Test according to 12.7.1.1:		
	- case of abnormal conditions.....:		—
	- Ballast failure at supply voltage (V)		—
	- Components retained in place after the test		N/A
	- Test with standard test finger after the test		N/A
	Test according to Annex W:		
	- case of abnormal conditions.....:		—
	- measured winding temperature (°C): at 1,1 Un		—
	- measured temperature of fixing point/exposed part (°C): at 1,1 Un.....:		—
	- calculated temperature of fixing point/exposed part (°C)		—
	Ball-pressure test.....:		N/A
3.12 (12.7.1.2)	Luminaire with discharge lamp, fluorescent lamp $> 70W$, transformer $> 10 VA$		
	- case of abnormal conditions.....:		—
	- measured winding temperature (°C): at 1,1 Un		—
	- measured temperature of fixing point/exposed part (°C): at 1,1 Un.....:		—
	- calculated temperature of fixing point/exposed part (°C)		—
	Ball-pressure test.....:		N/A
3.12 (12.7.1.3)	Luminaire with short circuit proof transformers $\leq 10 VA$		N/A
	- case of abnormal conditions.....:		—

IEC / EN 60598-2-3			
Clause	Requirement + Test	Result - Remark	Verdict
	- Components retained in place after the test		N/A
	- Test with standard test finger after the test		N/A
3.12 (12.7.2)	Luminaire with temperature sensing control		
	- thermal link	Yes <input type="checkbox"/> No <input type="checkbox"/>	—
	- manual reset cut-out.....	Yes <input type="checkbox"/> No <input type="checkbox"/>	—
	- auto reset cut-out	Yes <input type="checkbox"/> No <input type="checkbox"/>	—
	- case of abnormal conditions.....		—
	- highest measured temperature of fixing point/ exposed part (°C):		—
	Ball-pressure test:.....		N/A
3.12.1 (-)	Temperature reduction if for outdoor use only		N/A
3.12.2 (-)	(See above)		—
3.12.3 (-)	Glass covers used within the thermal limits declared by the glass manufacturer		N/A

3.13 (9)	RESISTANCE TO DUST, SOLID OBJECTS AND MOISTURE		
3.13.1 (-)	If IP > IP 20 the order of tests as specified in clause 3.12		
3.13 (9.2)	Tests for ingress of dust, solid objects and moisture:		—
	- classification according to IP	IP66	—
	- mounting position during test	On pipe	—
	- fixing screws tightened; torque (Nm).....		—
	- tests according to clauses	9.2.2, 9.2.7	—
	- electric strength test afterwards		P
	a) no deposit in dust-proof luminaire		N/A
	b) no talcum in dust-tight luminaire		P
	c) no trace of water on current-carrying parts or on insulation where it could become a hazard		N/A
	d) i) For luminaires without drain holes – no water entry		N/A
	d) ii) For luminaires with drain holes – no hazardous water entry		N/A
	e) no water in watertight luminaire		P
	f) no contact with live parts (IP 2X)		N/A
	f) no entry into enclosure (IP 3X and IP 4X)		N/A
	f) no contact with live parts (IP3X and IP4X)		N/A

IEC / EN 60598-2-3			
Clause	Requirement + Test	Result - Remark	Verdict
	g) no trace of water on part of lamp requiring protection from splashing water		P
	h) no damage of protective shield or glass envelope		P
3.13 (9.3)	Humidity test 48 h		P

3.14 (10) INSULATION RESISTANCE AND ELECTRIC STRENGTH			
3.14 (10.2.1)	Insulation resistance test		P
	Cable or cord covered by metal foil or replaced by a metal rod of mm Ø		—
	Insulation resistance (MΩ).....		—
	SELV		
	- between current-carrying parts of different polarity :		N/A
	- between current-carrying parts and mounting surface	>110 MΩ	P
	- between current-carrying parts and metal parts of the luminaire	>110 MΩ	P
	- between the outer surface of a flexible cord or cable where it is clamped in a cord anchorage and accessible metal parts		N/A
	- Insulation bushings as described in Section 5		N/A
	Other than SELV		
	- between live parts of different polarity.....		N/A
	- between live parts and mounting surface.....	>550 MΩ	P
	- between live parts and metal parts	>550 MΩ	P
	- between live parts of different polarity through action of a switch		N/A
	- between the outer surface of a flexible cord or cable where it is clamped in a cord anchorage and accessible metal parts	>550 MΩ	P
	- Insulation bushings as described in Section 5		N/A
3.14 (10.2.2)	Electric strength test		P
	Dummy lamp		N/A
	Luminaires with ignitors after 24 h test		N/A
	Luminaires with manual ignitors		N/A
	Test voltage (V)		N/A
	SELV		

IEC / EN 60598-2-3			
Clause	Requirement + Test	Result - Remark	Verdict
	- between current-carrying parts of different polarity :		N/A
	- between current-carrying parts and mounting surface	500 V	P
	- between current-carrying parts and metal parts of the luminaire	500 V	P
	- between the outer surface of a flexible cord or cable where it is clamped in a cord anchorage and accessible metal parts		N/A
	- Insulation bushings as described in Section 5		N/A
	Other than SELV		
	- between live parts of different polarity		N/A
	- between live parts and mounting surface	1460 V	P
	- between live parts and metal parts	1460 V	P
	- between live parts of different polarity through action of a switch		N/A
	- between the outer surface of a flexible cord or cable where it is clamped in a cord anchorage and accessible metal parts	1460 V	P
	- Insulation bushings as described in Section 5		N/A
3.14 (10.3)	Touch current (mA)	0,0025	P
	Protective conductor current (mA)	0,036	P

3.15 (13)	RESISTANCE TO HEAT, FIRE AND TRACKING		
3.15 (13.2.1)	Ball-pressure test		N/A
3.15 (13.3.1)	Needle-flame test (10 s)		N/A
3.15 (13.3.2)	Glow-wire test (650°C)		N/A
3.15 (13.4)	Proof tracking test (IEC 60112)		N/A

IEC / EN 60598-2-3							
Clause	Requirement + Test	Result - Remark					Verdict
3.7 (11.2)	TABLES: Creepage distances and clearances						
Table 11.1	Minimum distances (mm) for a.c. (50/60 Hz) sinusoidal voltages						
RMS working voltage (V) not exceeding	50	150	250	500	750	1000	
Creepage distances: see critical component							
Required basic insulation, PTI \geq 600	0,6	0,8	1,5	3	4	5,5	
Measured	-	-	$\geq 1,5$	-	-	-	
Required basic insulation, PTI < 600	1,2	1,6	2,5	5	8	10	
Measured	-	-	-	-	-	-	
Required supplementary insulation PTI \geq 600	-	0,8	1,5	3	4	5,5	
Measured	-	-	-	-	-	-	
Required supplementary insulation PTI < 600	-	1,6	2,5	5	8	10	
Measured	-	-	$\geq 2,5$	-	-	-	
Required reinforced insulation	-	3,2	5	6	8	11	
Measured	-	-	-	-	-	-	
Clearances							
Required basic insulation	0,2	0,8	1,5	3	4	5,5	
Measured	-	-	-	-	-	-	
Required supplementary insulation	-	0,8	1,5	3	4	5,5	
Measured	-	-	$\geq 1,5$	-	-	-	
Required reinforced insulation	-	1,6	3	6	8	11	
Measured	-	-	-	-	-	-	
Table 11.2	Minimum distances (mm) for non-sinusoidal pulse voltages						
Rated pulse voltage (peak kV)	2,0	2,5	3,0	4,0	5,0	6,0	8,0
Required clearances	1,0	1,5	2	3	4	5,5	8
Measured	-	-	-	-	-	-	-
Rated pulse voltage (peak kV)	10	12	15	20	25	30	40
Required clearances	11	14	18	25	33	40	60
Measured	-	-	-	-	-	-	-
Rated pulse voltage (peak kV)	50	60	80	100	-	-	-
Required clearances	75	90	130	170	-	-	-
Measured	-	-	-	-	-	-	-

IEC / EN 60598-2-3			
Clause	Requirement + Test	Result - Remark	Verdict
3.15 (13.2.1)	TABLE: Ball Pressure Test of Thermoplastics		N/A
3.15 (13.3.1)	TABLE: Needle-flame test (IEC 60695-11-5)		N/A
3.15 (13.3.2)	TABLE: Glow-wire test (IEC 60695-2-11)		N/A
3.15 (13.4)	TABLE: Proof tracking test (IEC 60112)		N/A

ANNEX 1		TABLE: Critical components information					
Object / part No.	Code	Manufacturer/ trademark	Type / model	Technical data	Standard	Mark(s) of conformity ¹⁾	
Description:		LUG URBINI LED 130232.5L111.101					
LED module	B	LUG	ML180400 W757.01A	U _{max} 44 V, t _c 85 °C, I _{max} 1150 mA	62031	Tested in equipment	
Driver	B	ELT	LCM 42 / 350...1050 - E	220-240 V, 50/60 Hz, t _c 75 °C		ENEC 01	
Wires LED	B		LGY	300/500 V, 0,5 mm ²	IEC227		
Ext. wires	B	Nkt cable	H03VV-F	3G0,75	IEC227		
Supplementary information: ¹⁾ Provided evidence ensures the agreed level of compliance. See OD-CB2039. The codes above have the following meaning: A - The component is replaceable with another one, also certified, with equivalent characteristics B - The component is replaceable if authorised by the test house C - Integrated component tested together with the appliance D - Alternative component							

ANNEX 2		TABLE: Temperature measurements, thermal tests of Section 12					
	Type reference.....:	LUG URBINI LED 130232.5L111.101				—	
	Lamp used.....:	LED module LUG				—	
	Lamp control gear used.....:	ELT LCM 42 / 350...1050 - E				—	
	Mounting position of luminaire.....:	On pipe				—	
	Supply wattage (W).....:	36,9				—	
	Supply current (A).....:	---				—	
	Calculated power factor.....:	---				—	
Table: measured temperatures corrected for $t_a = 35\text{ °C}$:							
	- abnormal operating mode.....:	Not used; see supplementary information				—	
	- test 1: rated voltage.....:	230 V				—	
	- test 2: 1,06 times rated voltage or 1,05 times rated wattage.....:	243,8 V				—	
	- test 3: Load on wiring to socket-outlet, 1,06 times voltage or 1,05 times wattage.....:	---				—	
	- test 4: 1,1 times rated voltage or 1,05 times rated wattage.....:	---				—	
	Through wiring or looping-in wiring loaded by a current of A during the test.....:	---				—	
Temperature measurements, (°C)							
Part	Ambient	Clause 12.4 – normal				Clause 12.5 – abnormal	
		test 1	test 2	test 3	limit	test 4	limit
LED module t_c	35	65	---	---	85	---	---
Driver t_c	35	75	---	---	75	---	---
LED wires	35	---	59	---	90	---	---
Internal wires	35	---	54	---	90	---	---
Terminal block	35	---	35	---	85	---	---
External wires	35	---	35	---	90	---	---
Supplementary information: Temperature marked control gear 100 °C.							

ANNEX 3 Photo

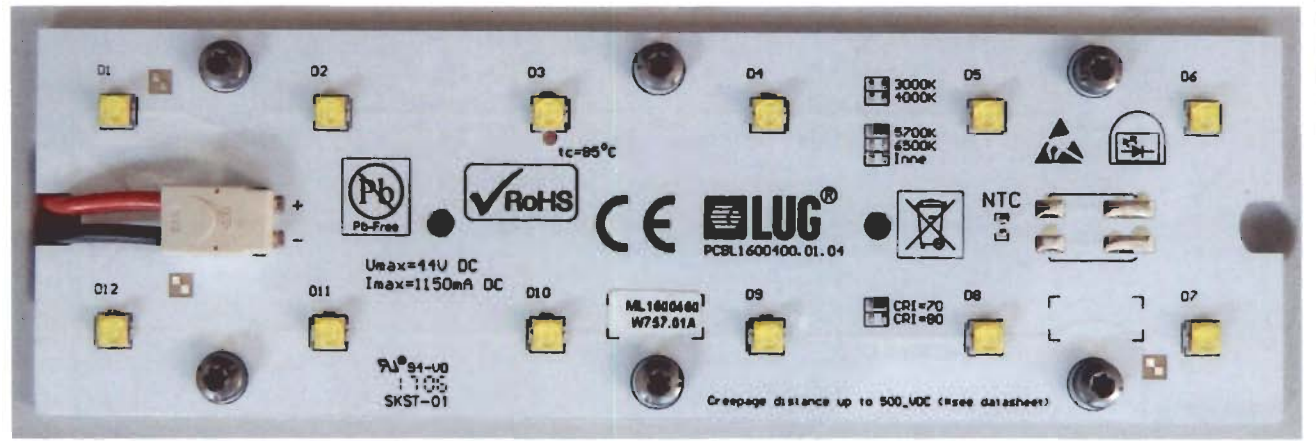
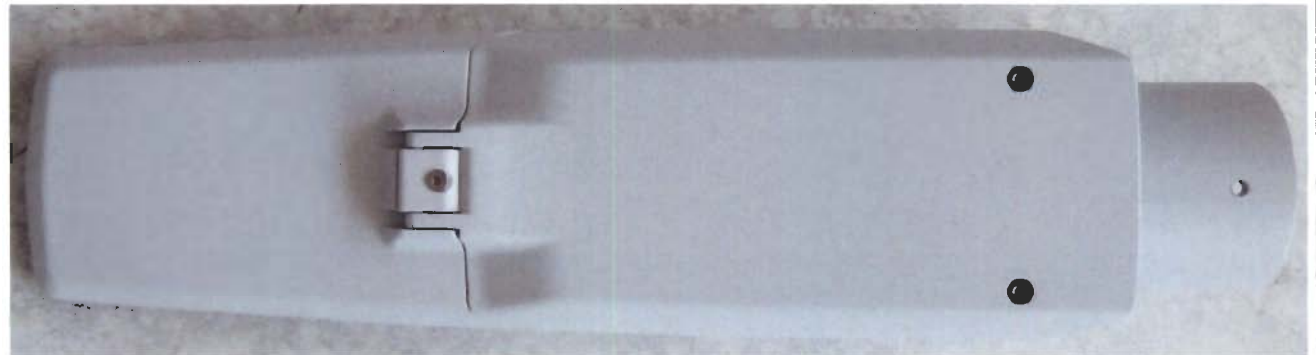
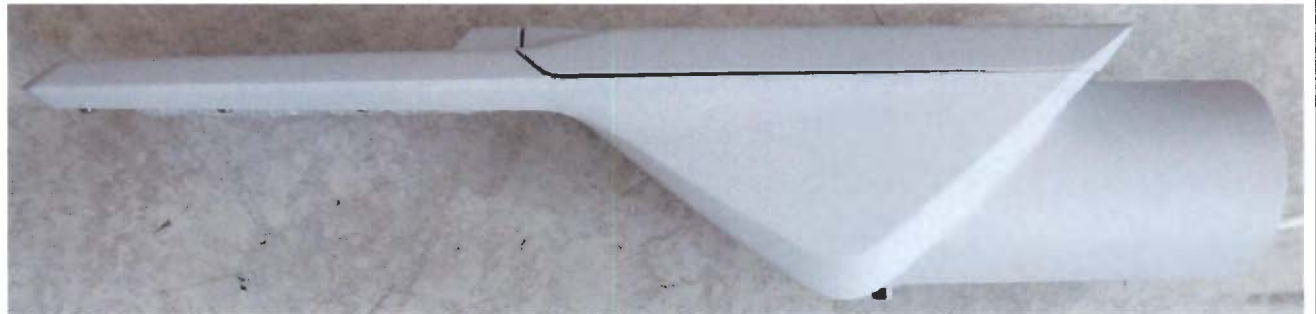

ANNEX 3 Photo

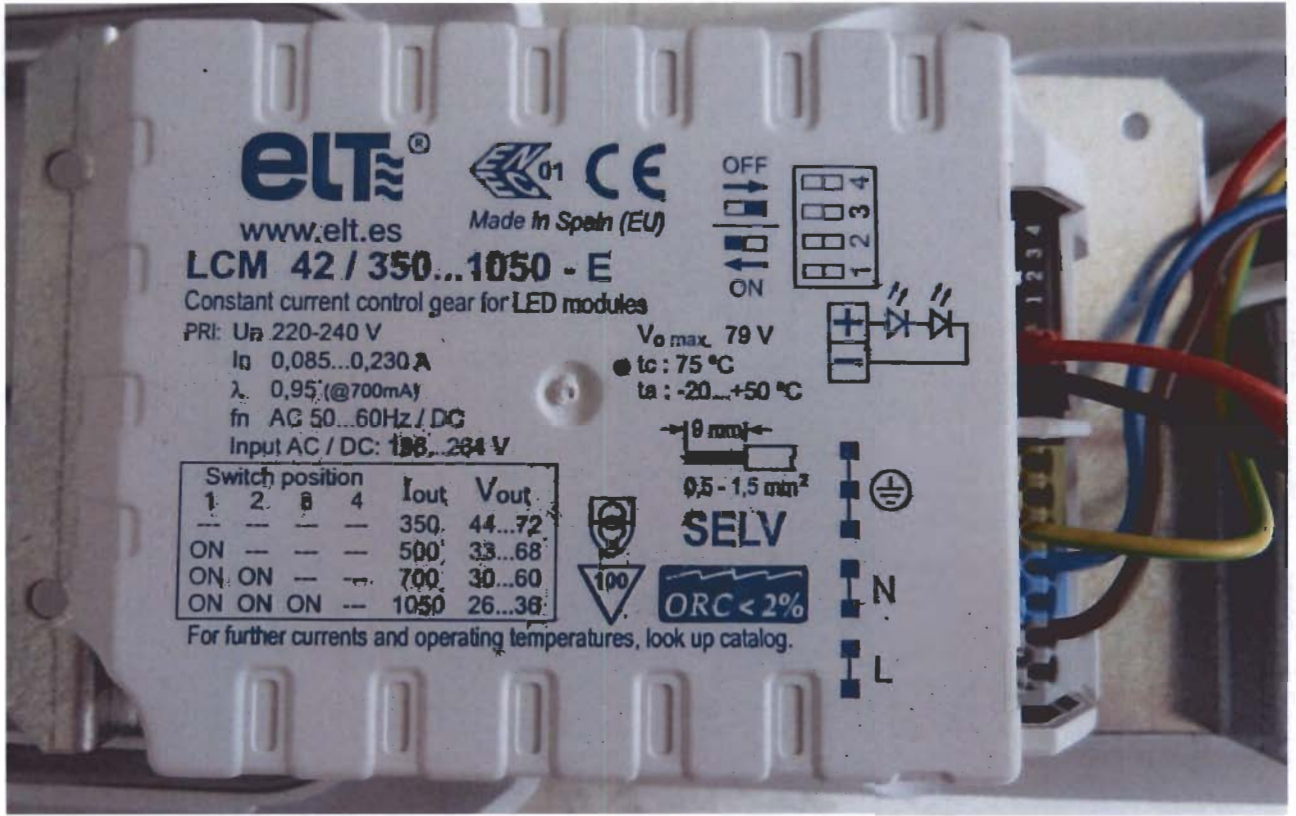

WAŻNE INFORMACJE | IMPORTANT INFORMATION | IMPORTANTES INFORMAÇÕES ÚTEIS | ВАЖНАЯ ИНФОРМАЦИЯ | WICHTIGE INFORMATIONEN

 Unikaj bezpośredniego patrzenia na źródła światła.
Avoid direct looking at light source light.
É fait éviter un regard direct sur les sources de lumière.
Evite mirar directamente a la fuente de luz.
Не смотрите напрямую на световые источники света.
Den direkten augenkontakt in die led vermeiden.

 Wymień uszkodzoną szybę.
Replace broken glass.
Remplacement du verre cassé.
Substituir o vidro quebrado.
Заменить поврежденное стекло.
Austausch zerbrochenes Glas.

 Niniejszą instrukcję należy zachować do przyszłego wykorzystania.
Keep this instruction leaflet for any further reference.
Conserver cette notice jusqu'à un emploi prochain.
Este manual debe ser mantenido para futuro uso.
Настоящее руководство следует сохранять для будущего использования.
Das vorliegende Bedienungsanleitung für zukünftigen Bedarf aufbewahren.

AKCESORIA | ACCESSORIES | ACCESSOIRES | ACESSÓRIOS | АКЦЕССУАРЫ | ZUBEHÖR

 **150170.00817**
Reductor 60/76mm
Reducer 60/76mm
Réducteur 60/76mm
Redutor 60/76mm
Редуктор 60/76mm
Minderer 60/76mm



LUG Light Factory Sp. z o.o.
05-127 Zielona Góra, ul. Gorzowska 11
e-mail: handlowy@lug.pl
tel. +48 68 411 72 68 | 69 | 70 | 71 | 79 |
fax +48 68 411 72 88 | 89





www.lug.com.pl

INFORMACJA
W tym celu należy zwrócić uwagę na następujące informacje:
Organizacja Działania Sprzętu Świecącego i Światłowodowy System Światłowodowy (OSW)
35-500 Kłobucko ul. Wolności 4
tel. 022 20 686 27
KRS 000036984
NIP 525 080 42 00
www.osw.pl
osw@osw.pl

4/4

LUG
INSTALLATION INSTRUCTION
Version 07/2017/008
URBINI LED

INSTRUCIA MONTAŻU | ИНСТРУКЦИЯ ПО МОНТАЖУ | MONTAGEANLEITUNG | INSTRUCTIONS DE MONTAGE | NÁVOD K MONTÁŽI | INSTRUCCIONES DE MONTAJE | KOKOROPNO - JA KINNETYCHSET
MONTAGEANLEITUNG | INSTRUCCIONES DE MONTAJE | MONTAGEANLEITUNG | INSTRUCCIONES DE MONTAJE | KOKOROPNO - JA KINNETYCHSET
MONTAGEANLEITUNG | INSTRUCCIONES DE MONTAJE | MONTAGEANLEITUNG | INSTRUCCIONES DE MONTAJE | KOKOROPNO - JA KINNETYCHSET

-  MONTAŻU POWINNA DOKONAĆ OSOBA POSIADAJĄCA ODPOWIEDNIE WYKWALENIA
 MONTAZI POWINNA WYKONAĆ OSOBA POSIADAJĄCA ODPOWIEDNIE WYKWALENIA
 DIE MONTAGE VON EINER PERSONE, DIE ÜBER ENTSPRECHENDE KENNZEICHEN VERFÜGT GEMACHT WERDEN
 LA MONTAGE DEUT FARE UNA PERSONA CHE POSSIEDA LEI ESPERIENZE COMPETENTES

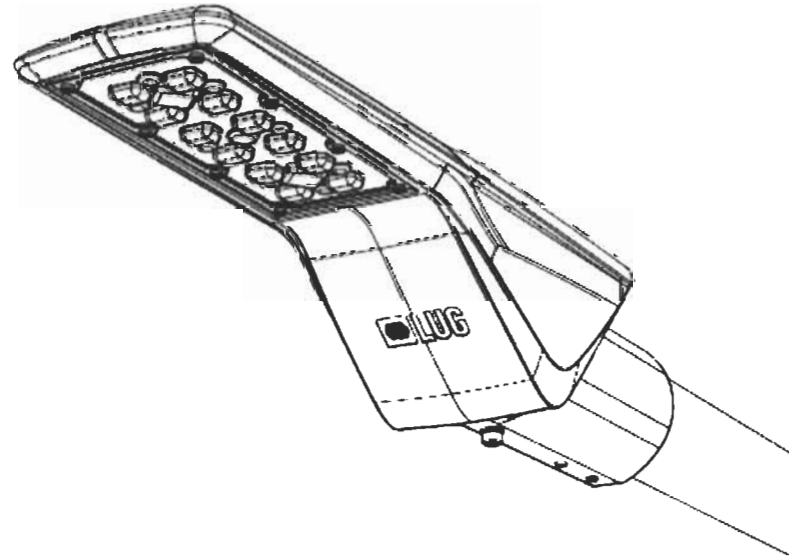

1/4

INSTRUCTION BODY IA 1308

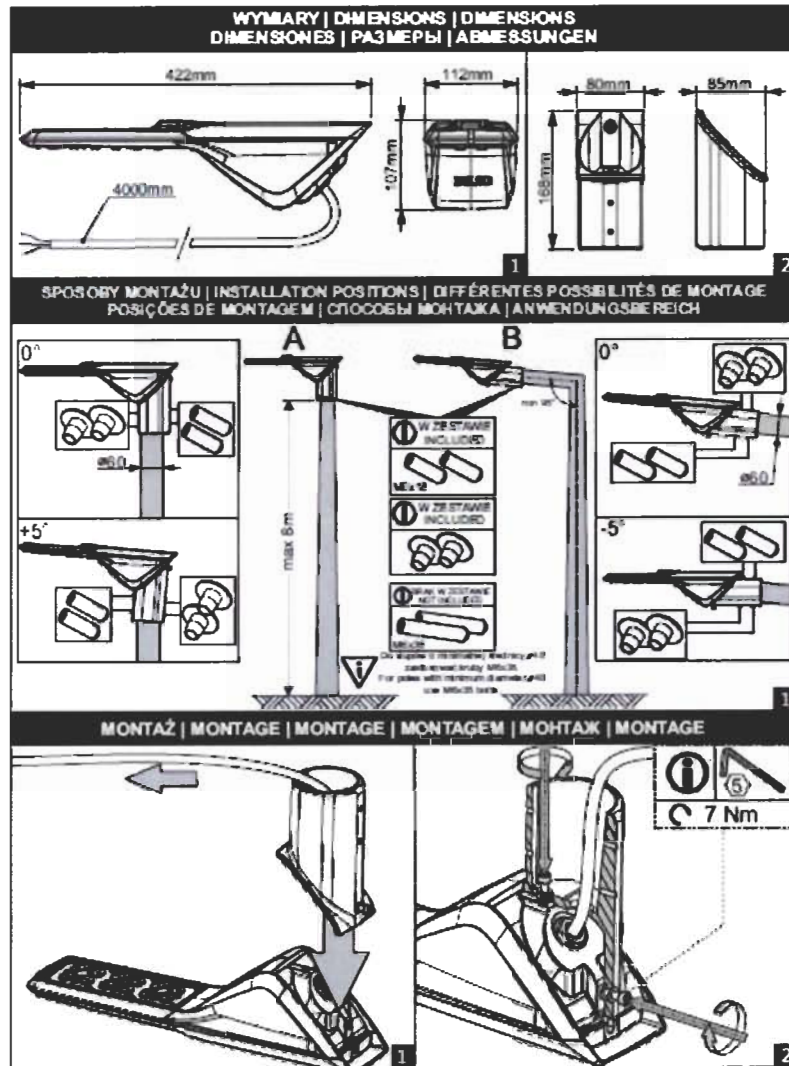

www.lug.com.pl

2/4

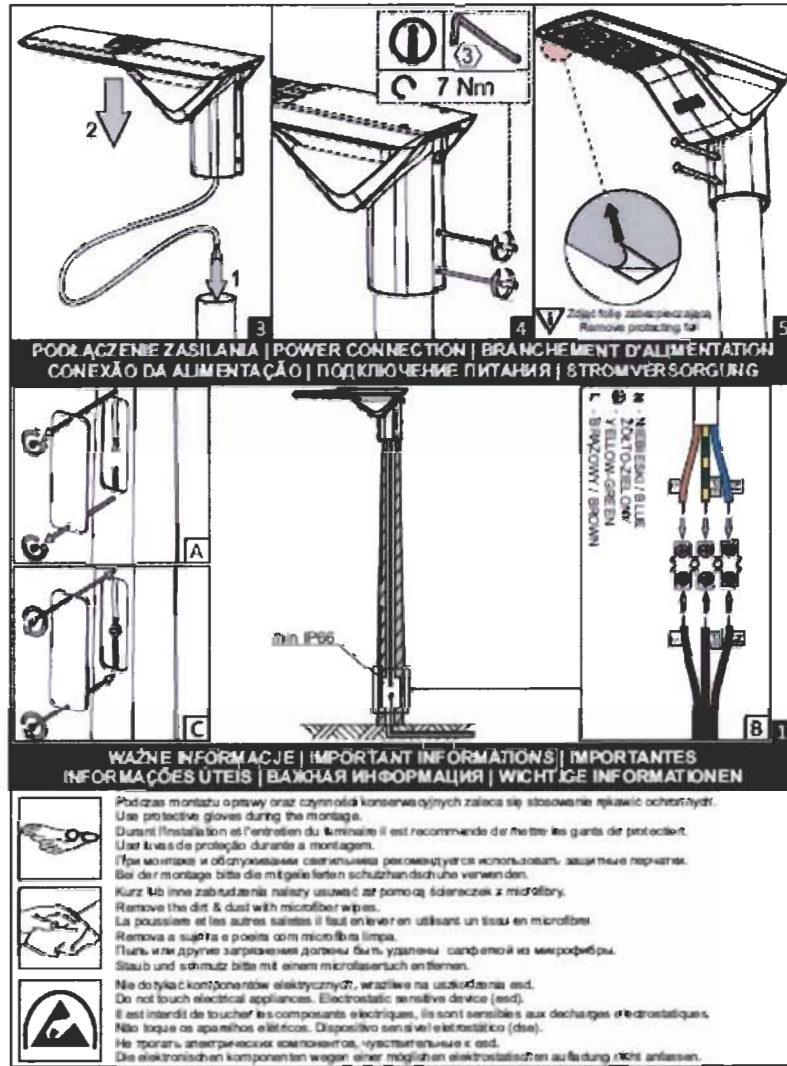

3/4

www.lug.com.pl

EN 60598-2-3			
Clause	Requirement + Test	Result - Remark	Verdict

ATTACHMENT TO TEST REPORT IEC 60598-2-1
EUROPEAN GROUP DIFFERENCES AND NATIONAL DIFFERENCES
 LUMINAIRES
 PART 2: PARTICULAR REQUIREMENTS
 SECTION 1: LUMINAIRES FOR ROAD AND STREET LIGHTING

Differences according to : EN 60598-2-3:1989 used in conjunction with
 EN 60598-1:2015

Annex Form No. : EU_GD_IEC60598_2_3J

Annex Form Originator : OVE

Master Annex Form : 2015-04

Copyright © 2015 IEC System for Conformity Testing and Certification of Electrical Equipment (IECEE), Geneva, Switzerland. All rights reserved.

CENELEC COMMON MODIFICATIONS (EN)	
-----------------------------------	--

1.5 (3)	MARKING		
1.5 (3.3.101)	For luminaires not supplied with terminal block: Adequate warning on the package		---

1.6 (4)	CONSTRUCTION		
1.6 (4.11.6)	Electro-mechanical contact systems		---

1.10 (5)	EXTERNAL AND INTERNAL WIRING		
1.10 (5.2.1)	Connecting leads		---
	- without a means for connection to the supply		---
	- terminal block specified		---
	- relevant information provided		---
	- compliance with 4.6, 4.7.1, 4.7.2, 4.10.1, 11.2, 12 and 13.2 of Part 1		---
1.10 (5.2.2)	Cables equal to EN 50525		---
	Replace table 5.1 – Supply cord		---

1.12 (12)	ENDURANCE TESTS AND THERMAL TESTS		
1.12 (12.4.2c)	Thermal test (normal operation) see footnote c to table 12.2 relating to unsleeved fixed wiring		---

EN 60598-2-3			
Clause	Requirement + Test	Result - Remark	Verdict
ZB	ANNEX ZB, SPECIAL NATIONAL CONDITIONS (EN)		
(3.3)	DK: power supply cords of class I luminaires with label		---
(4.5.1)	DK: socket-outlets		---
(5.2.1)	CY, DK, FI, GB: type of plug		---
ZC	ANNEX ZC, NATIONAL DEVIATIONS (EN)		
(4 & 5)	FR: Shuttered socket-outlets 10/16A		---
	FR: Safety requirements for high buildings (Arrêté du 30 décembre 2011 portant règlement de sécurité pour la construction des immeubles de grande hauteur et leur protection contre les risques d'incendie et de panique; Section VIII; Article GH 48, Eclairage)		---
	Glow-wire test for outer parts of luminaires:		
	- 850°C for luminaires in stairways and horizontal travel paths		---
	- 650°C for indoor luminaires		---
	GB: Requirements according to United Kingdom Building Regulation		---

ČSN EN 62471			
Clause	Requirement + Test	Result - Remark	Verdict

Measured values

Risk	Symbol	Measured value	Group
Blue light	L_B	$103 \text{ W}\cdot\text{m}^{-2}\cdot\text{sr}^{-1}$	RG1

Measured with supply voltage 230 V. Ambient temperature 25 °C.
Measured at 500 lx distance.

Conclusion

Light source can be considered as light source in Risk Group 1 (RG 1).

Emission limits for risk groups of continuous wave lamps						
Risk	Action spectrum	Symbol	Units	Emission Measurement		
				Exempt	Low risk	Mod risk
				Limit	Limit	Limit
Blue light	$B(\lambda)$	L_B	$\text{W}\cdot\text{m}^{-2}\cdot\text{sr}^{-1}$	100	10000	4000000

Measured by: Lukáš Fér

