

NeoGen

Tibia Nail System

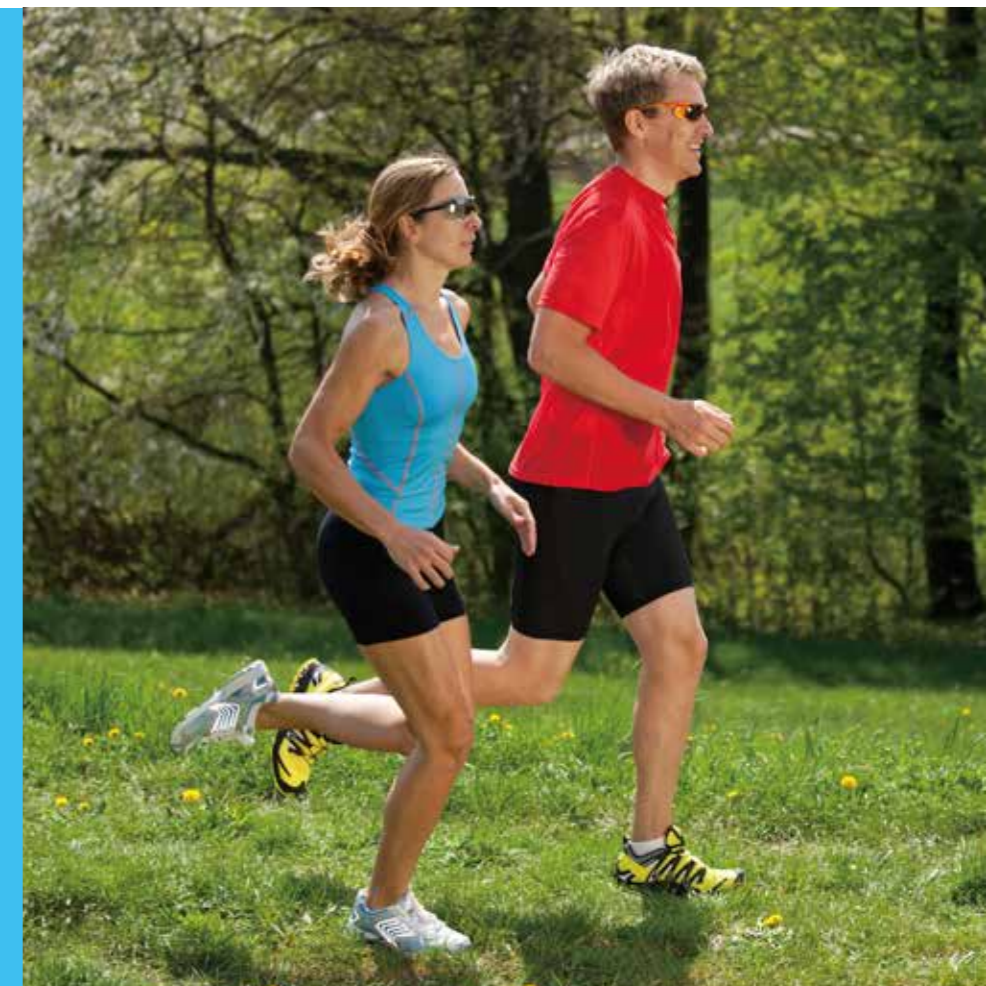

**LESS
IS MORE**

TABLE OF CONTENT

Preface	01
Surgical Technique	
Patient Preparation	02
Entry Portal	03
Fracture Reduction	04
Canal Preparation	04
Nail Selection	05
Drill Guide Assembly	05
Proximal Locking	06
Proximal Locking Screw (Transverse) Insertion	06
Proximal Locking Screw (Medial Oblique 25°) Insertion	09
Proximal Locking Screw (Lateral Oblique 25°) Insertion	10
Distal Locking	11
Stabilizing Distal Aiming Bar	11
Distal M / L Locking Screw Insertion	13
Distal A / P Locking Screw Insertion (Optional)	15
End Cap Placement	16
Closure	16
NeoGen Nail Extraction Technique	17
Appendix	18
Products Information	
Implants	19
Instruments	22

PREFACE

Nails

The locations of the distal screw holes have been moved closer to the distal end of the nail which allows the surgeon to nail more distal tibia fractures. The distal locking holes are now located at 5, 15, and 25mm from the distal tip of the nail.

The driving end of the nail offers a multiplanar locking configuration which has been clinically proven to increase the stability of the nail construct.

Screw Holes

The distal end of the nail offers the choice of two anterior/posterior or two medial/lateral screw options. The design allows for more options in fracture management and better stability in some fracture patterns.

The distal end of the implant offers a compression slot in the medial/lateral plane. This allows the fracture to be dynamized while maintaining rotational stability.

Round Shape Nails Design

Allows the implant to be inserted over a Ball Tip Guide Wire and aids in removal. Diameter choices standard sizes are 8.3mm (solid core), 9mm, 10 mm, and 11.5mm diameters.

Screws

Made of Ti6AL4V - An alloy that offers strength and improved biocompatibility.

Fluted Self - tapping Tip designed to make the screw easier to capture bone, and minimize the need for surgical steps.

Special Captured Feature - The head of the screw features internal threads that allows it to be captured by the Screwdriver for Locking Screw .

Enlarged threads at the head of the screw allows for solid bone purchase at the near cortex and minimize screw back out.

Indications

The NeoGen Tibia Nail System is indicated for shaft fractures between the proximal and distal third of the tibia. Indications include transverse, comminuted, spiral, oblique, and segmental fractures. The Tibia Nail may also be used for treatment of non unions or malunions as well as prophylactic nailings of impending pathological fractures.

SURGICAL TECHNIQUE

Patient Preparation

Position the patient supine. Place a sterile bolster (leg roll) under the thigh and flex the leg for positioning. Check the axial alignment by stretching a "bovie" cord through the middle of the patella to the second toe. The cord should bisect the middle of the tibial plateau and talar dome in the A/P view when the leg is straight. Adjust the leg for rotation and length by comparison with the uninjured leg and by visualizing the fracture configuration. Insertion alignment can be slightly proximal to the fibular neck, but below the articular surface of the to avoid joint damage. A slightly lateralized entry portal is optimal (Fig.1).



(Fig.1)

SURGICAL TECHNIQUE

Entry Portal

Make a 3 cm incision medial to the patellar tendon. Place the Assembly of Entry Drill Sleeve (898128) & Entry Inner Trochar (898127) through the incision to bone (Fig.2). Adjust to align the Assembly with the axial line of the tibial shaft in the A/P and lateral image views. Attach the Tip Threaded Guide Pin (899490) (Fig.3) to power. Insert the Guide Pin when the axial alignment is acceptable and centered along the tibia. The target zone should be just lateral to the medial tibia tubercle. The Assembly may be backed out as needed to confirm that the pilot hole is started correctly. Insert the pin approximately 3 cm in depth. Once proper placement of the Tip Threaded Guide Pin has been established, the Entry Inner Trochar should be removed.

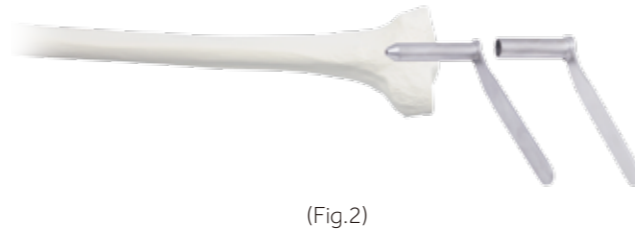

(Fig.2)



(Fig.3)



(Fig.4)

Attach the Entry Reamer (898122) to power and insert over the Tip Threaded Guide Pin to ream the proximal portion of the tibia. The reamer should be inserted such that it is reaming the anterior cortex and not directed toward the posterior cortex. The Entry Drill Sleeve functions as a soft tissue protector. The reamer should be advanced to the medullary canal of the tibia, approximately 4-5 cm. Confirm the position of the reamer under lateral X-ray views as well. Remove the Entry Reamer (Tibia) and Tip Threaded Guide Pin (Fig.4). In addition, Awl (899463) also can be used for initial opening of the tibia tuberosity tip.

Instrument



898128
Entry Drill Sleeve
(Knee)



898127
Entry Inner Trochar
(Knee)



899490
Guide Wire, Ø 2.5mm

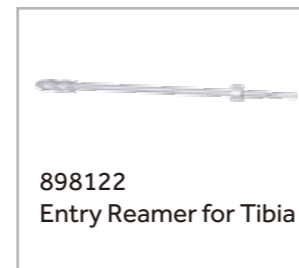

898122
Entry Reamer for Tibia



899463
Entry Drill Sleeve
(Femur)

SURGICAL TECHNIQUE

Fracture Reduction

Insert the Reducer through the Entry Drill Sleeve and advance it into the distal medullary canal to reduce the fracture (Fig. 5). Attach the Guide Wire Holder (899471) to the Ball Tip Guide Wire (899470) and introduce it into the medullary canal through the Reducer and Entry Drill Sleeve. The Ball Tip Guide Wire can be positioned by rotating the Reducer while placing the wire into the medullary canal. Remove the Guide Wire Holder from the guide wire to allow for removal of the Reducer. When the Ball Tip Guide Wire is in place, remove the Reducer.

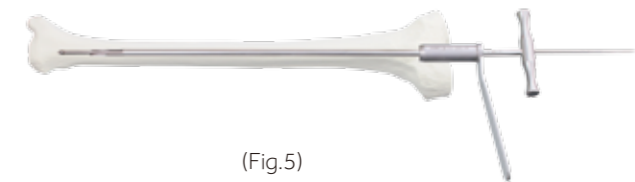

(Fig.5)

Note: The Reducer may be too large to use if the patient has a small diameter intramedullary canal. If this is the case, reduce the tibia manually.

Instrument

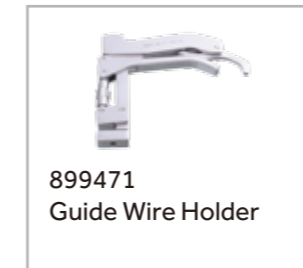

899471
Guide Wire Holder



899470
Ball Tip Guide

Canal Preparation

Canal preparation is dependent on surgical decision. If reaming is planned, use progressive reamers through the Entry Drill Sleeve. Unreamed nails are selected based on preoperative planning, but should offer sufficient size to provide translational fill of the intramedullary canal in mid-diaphysis. If reaming is selected, proceed to sequentially ream the tibial shaft beginning with the 8.5 mm reamer head. Sequentially ream in half millimeter increments to 0.5 mm to 1.0 mm larger than the selected nails size (Fig.6).

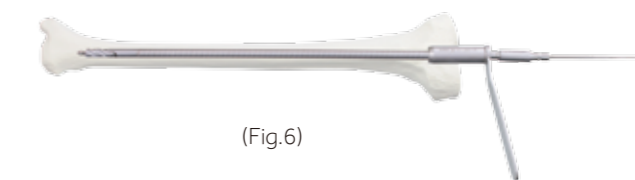

(Fig.6)

SURGICAL TECHNIQUE

Nail Selection

Determine nail diameter from image intensifier, or sounding the canal. Never insert a nail that has a larger diameter than the last reamer used. Confirm placement of the Ball Tip Guide Wire at the desired portion of the distal tibia metaphysis.

Note: Make provisions for countersinking the tibial nail to minimize impingement problems at the knee. Allow for reduction of the fracture, if dynamization is required. Read the nail length from the calibrations exposed at the other end of the Gauge.

Drill Guide Assembly

Insert the Guide Bolt (899500) into the Insertion Handle (899499). Use the Guide Bolt Wrench (899497) and T-handle (899468) to secure the bolt to nail, and then screw the Guide Bolt onto the top of the Insertion Handle with the proximal side of the nail. This assembly is used to drive the nail into the medullary canal (Fig.7). If necessary, Impactor (899502) is able to be connected onto the top of Insertion Handle to assist nail insertion (Fig.8). Insert the Tissue Protector (899464) in the incision parallel to the Entry Drill Sleeve. Remove the Entry Drill Sleeve, the Tissue Protector will assist in maintaining control of the surrounding tissues and provide continued access to bone.

Advance the nail over the Ball Tip Guide Wire and carefully pass the fracture. Countersink the nail approximately 2-5mm into the tibia proximally. Confirm rotation as is appropriate, and then remove the Guide Wire.

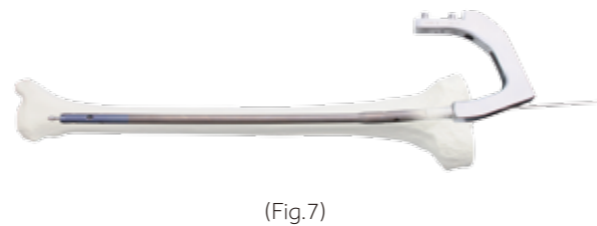

(Fig.7)



(Fig.8)

Instrument



899500
Guide Bolt



899499
Insertion Handle

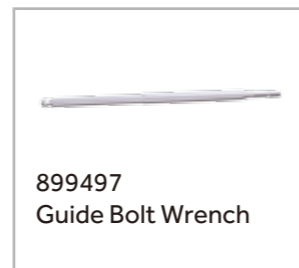

899497
Guide Bolt Wrench



899468
T-Handle with Quick
Coupling



899502
Impactor



899464
Tissue Protector

SURGICAL TECHNIQUE

Proximal Locking

Attach the Proximal Aiming Bar (Left: 899526 / Right: 899527) to the Insertion Handle. The Drill Guide is keyed so that the Proximal Aiming Bar will only fit one way. Secure the Proximal Aiming Bar to the Drill Guide by tightening the Proximal Bolt (899503) by hand. Final tightening can also be accomplished by placing the end of the Bolt Wrench (899505) into the hex holes in the Proximal Bolt (Fig.9). The Guide Bolt will also be used to rotate the Insertion Handle 180° as needed for lateral oblique screw insertion.



(Fig.9)

Instrument



899526
Proximal Aiming
Bar (Knee)



899527
Proximal Aiming
Bar (Knee)



899503
Proximal Bolt

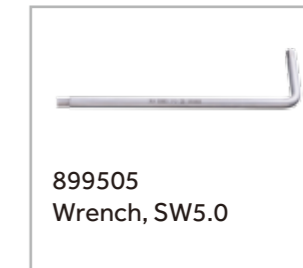

899505
Wrench, SW5.0

Proximal Locking Screw (Transverse) Insertion

Proximal Locking Screw (Transverse) Insertion: insert the Outer Drill Sleeve (899511) through the proximal hole on the Proximal Aiming Bar. Make a skin incision and insert the sleeve to bone. Measure the screw length and insert the proximal screw at the transverse plane by either of the following techniques:

a. Pre-drilling Technique- Make a stab incision at the entry hole and push the Outer Drill Sleeve through the Drill Guide hole until it is touching the lateral cortex. Introduce the Ø4.3 Drill Sleeve (899514) through the Outer Drill Sleeve (Fig.10-11).



(Fig.10)

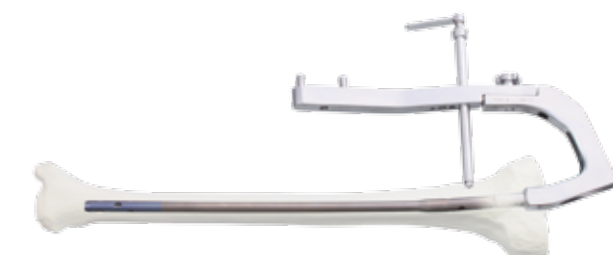

(Fig.11)

SURGICAL TECHNIQUE

Attach the Ø4.3 Drill Bit (899517) to power drill. Drill to, but not through the opposite cortex and measure for proper length(Fig.12). The length measurements are taken from the calibrations of the drill in relation to the end of the Ø4.3 Drill Sleeve.



(Fig.12)

The appropriate length of 5.0mm screw is selected and attached to the Screwdriver for Locking Screw (899487/899488). The Drill Bit and Ø4.3 Drill Sleeve are removed and the screw is inserted through the Outer Drill Sleeve. Rotate the screwdriver handle and place screw in bone. It is recommended that final tightening of the 5.0mm screw should always be under manual control using the Screwdriver for Locking Screw (Fig.13-14).



(Fig.13)



(Fig.14)

Instrument



899511
Outer Drill Sleeve



899514
Drill Sleeve 4.3



899517
Replacement Rod

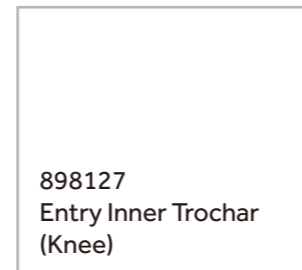

898127
Entry Inner Trochar
(Knee)



899487
Screwdriver for
Locking Screw



899488
Screwdriver for
Locking Screw, long

SURGICAL TECHNIQUE

B. Screw Depth Gauge- Predrill through both cortices. The surgeon should check that the Outer Drill Sleeve is positioned so that it is touching the bone. The hook end of the Screw Depth Gauge (899484) is inserted through the Outer Drill Sleeve and through the bone. It is then drawn back so that the hook engages the outer surface of the far cortex. The correct length of screw now can be read at the top of the Outer Drill Sleeve (Fig.15). The appropriate length of 5.0mm screw is selected and attached to the Screwdriver for Locking Screw. It is recommended that final tightening of the 5.0mm screw should always be under manual control by using Screwdriver for Locking Screw.

Note: Once screw is seated the Connection Rod in the cannulated T-Handle of Screwdriver for Locking Screw turned counterclockwise and the Screwdriver for Locking Screw releases the screw to remove the T-Handle.

Note: Once screw is seated, turn the Nut in the cannulated Screwdriver counterclockwise. The Screwdriver releases from the locking screw, and then the Screwdriver for Locking Screw & the Outer Drill Sleeve need to be removed for Proximal Medial Oblique 25° Screw Placement at the medial side



(Fig.15)

Instrument

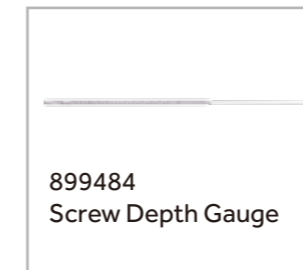

899484
Screw Depth Gauge

SURGICAL TECHNIQUE

Proximal Locking Screw (Medial Oblique 25°) Insertion:

Attach the Proximal Aiming Device (899531) to the Proximal Aiming Bar. Secure the Proximal Aiming Device to the Proximal Aiming Bar by tightening the Proximal Bolt by hand. Final tightening can also be accomplished by placing the end of the Bolt Wrench into the hex holes in the Proximal Bolt. Insert the Outer Drill Sleeve through the top hole on the Proximal Aiming Device. Make a skin incision and insert the sleeve to bone. Then place the Medial Oblique 25° locking screw by following the same technique of Proximal Locking Screw (Transverse) Insertion (Fig.16-19).

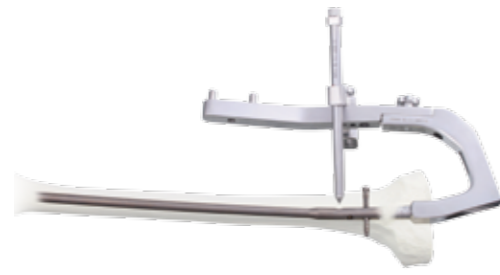

(Fig.16)

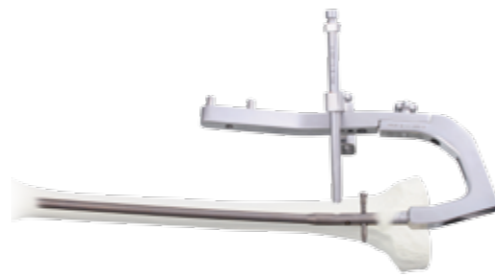

(Fig.17)

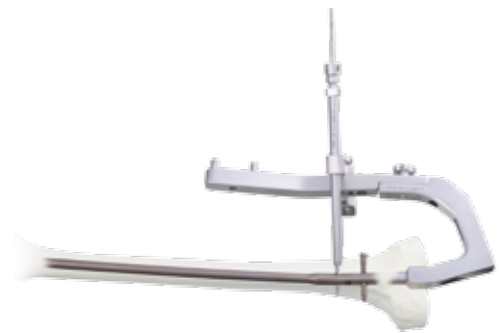

(Fig.18)



(Fig.19)

Instrument



899531
Proximal Aiming
Device (Knee)

SURGICAL TECHNIQUE

Proximal Locking Screw (Lateral Oblique 25°) Insertion:

For insertion of the lateral oblique screw, the Guide Bolt is loosened and back-turned two complete revolutions. This allows the Guide to be lifted and rotated 180°. After rotating the Drill Guide, retighten with the Guide Bolt, making sure the key is engaged. The guide is now in correct position for placement of the lateral oblique screw (Fig.20). Again, the top hole on the Proximal Aiming Device should be chosen for the lateral locking screw insertion. Place the lateral oblique 25° screws following the same technique of Medial oblique 25° screw insertion (Fig.21).



(Fig.20)



(Fig.21)

Attention:

For left tibia of the proximal medial & lateral oblique 25° locking screws: the Top Hole on the Aiming Device is always been chosen for screws insertion no matter of medial or lateral side (if the nail is inserted from medial side).

For right tibia of the proximal medial & lateral oblique 25° locking screws: the Bottom Hole on the Aiming Device is always been chosen for screws insertion no matter of medial or lateral side (if the nail is inserted from medial side).

SURGICAL TECHNIQUE

Distal Locking

The Distal target technique is used. First, the rotation is confirmed with the tibia to be satisfactory. Next, the image intensifier is used to obtain perfect circles radiographically on the medial view or the anterior view.

For diameter 8 & 9mm nail: there are 3 screw holes at the distal side, 1 screw hole on the A/P position, 2 screw holes on the M/L position. For diameter 10 & 11.5mm nail: there are 4 screw holes at the distal side, 2 screw holes on the A/P position, 2 screw holes on the M/L position

Unscrew the Proximal Bolt and remove the Proximal Aiming Device. The Distal Aiming Bar (899528) is introduced onto the Proximal Aiming Bar (899526), moved downwards until the number corresponding to the nail length is at the level of the front of the Distal Aiming bar, and locked firmly into place with Distal Bolt (899504). Note that there is an arrow on the Proximal Aiming Bar and Distal Aiming Bar corresponding to each nail length. The distal locking screws are inserted in the frontal plane, normally from the medial side. On rare occasions, because of skin damage medially, or because of the configuration of a distal fracture, the surgeon may wish to insert the screws from the lateral side.

Instrument



Stabilizing Distal Aiming Bar

There are 4 holes on the Targeter (899529). Attached the Targeter onto the distal end of the Distal Aiming Bar, and tighten it by using the Distal Bolt at the bottom of the Targeter.(Fig. 22)

Instrument



(Fig.22)

SURGICAL TECHNIQUE

Note: no matter of which diameter of the tibial nail has been chosen, the most distal hole on the Targeter is always corresponding to the most distal screw hole of the tibial nail by A/P view, and the most proximal hole of the Targeter is always corresponding to the most proximal screw hole of the tibial nail at the distal side by M/L view.

Assemble the Trochar (Distal Positioning) (899507) with the Outer Drill Sleeve (Distal Positioning) (899506). Insert this assembly onto the most proximal hole of the Targeter. An incision is made beneath this assembly, and the tibial cortex exposed by blunt dissection (Fig.23).

Replace the Trochar (Distal Positioning) by Ø5.2 Drill Sleeve (899508), attach the Ø5.2 Drill Bit (899509) with power, and drill only the anterior tibia cortex, then finish drilling by using Position Rod Drill (899510) manually till it touches the nail by hand feeling (Fig. 24-25). Since the flat design of the Position Rod Drill tip, the bone chips are able to be removed for Position Rod (899530) insertion.

The Position Rod is inserted through the Outer Drill Sleeve (Distal Positioning), and through the anterior tibia cortex, down to the nail, contact being confirmed by tapping its tip on the nail.(Fig. 26)

The E Block (899532 / 899533) is now attached so that: the upper fork which laser marked the number corresponding with the nail diameter fits into the groove on the Positioning Rod shaft. The other two forks grip the Targeter (Fig. 27).

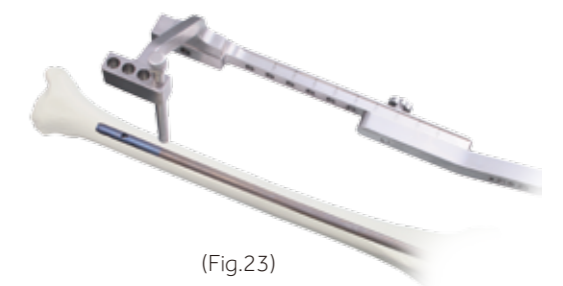

(Fig.23)

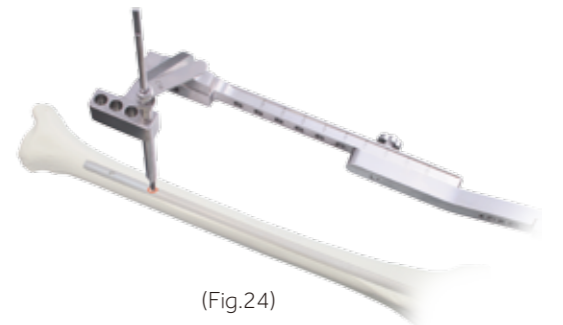

(Fig.24)

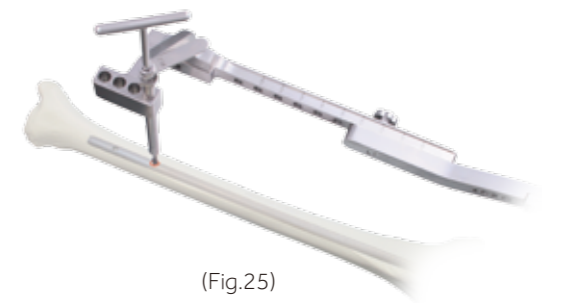

(Fig.25)



(Fig.26)



(Fig.27)

SURGICAL TECHNIQUE

Positioning Rod is now properly held so that its tip is in contact with the nail itself. The surgeon maintains this contact throughout. If the Positioning Rod handle is pushed too hard, it is sometimes possible to push the tip of the Positioning Rod past the nail. This must be avoided, since it will result in the drill bit passing posterior to the nail. Gentle contact is required.

Instrument



Distal M/L Locking Screw Insertion

The two Outer Drill Sleeves are inserted through each of the media-lateral holes on the Distal Aiming Bar (Tibia) to locate the sites for the incisions (Fig.28). Before making the incisions, the surgeon should carry out a final check for reduction of the fracture, remembering the possibility of distraction. An incision will be made beneath each Screw Guide, and the tibial cortex exposed in each case by blunt dissection. If the approach is from the lateral side, the surgeon must ensure that the tendons and vessels are not damaged during the locking procedure, by careful soft tissue dissection down to the bone. A single 1-3 cm incision is made over the points of contact with the skin, down through the deep fascia after completely checking.



(Fig.28)

SURGICAL TECHNIQUE

The Outer Drill Sleeves are now further inserted down to the bone with the aid of the Trochar (899512). Remove the Trochar, insert either the Ø4.0 Drill Sleeve (899513) or Ø4.3 Drill Sleeve (899514) depends on the chosen nail's diameter. Correspondingly, Ø4.0 Drill Bit or Ø4.3 Drill Bit is chosen accordingly. (Detailed information, Please see Appendix Table 1).

The surgeon now grips the T-handle of the Position Rod to keep its tip against the nail, and maintains this position throughout the drilling procedures. The first media-lateral locking hole is now drilled as for proximal locking at the distal area of the nail (Fig. 29).

Remove the Ø4.0 Drill Sleeve or Ø4.3 Drill Sleeve, then the Replacement Rod (899519) is now inserted into the Outer Drill Sleeve, so that it passes through the nail, and engages the far cortex. This Replacement Rod has now stabilized the position of the aiming bar. Do not drill the second hole until the angled Replacement Rod is in position.

Now that screw guide alignment is maintained by this Replacement Rod, the surgeon may release the handle of Positioning Rod.

The distal locking screw hole at the distal area of the nail is now drilled by same techniques have been applied for the proximal locking screw hole drilled at the distal area of the nail.

Screw length is able to be obtained by reading directed from the drill's calibration or using the Screw Depth Gauge (Screw Depth Gauge using method please see: Screw Depth Gauge, page: 7/15). Remove the Drill Sleeve, a locking screw of correct length and diameter is now inserted into through the Outer Drill Sleeve, rotate through the bone with the Screwdriver for Locking Screw.



(Fig.29)

SURGICAL TECHNIQUE

The Replacement Rod is removed from the first Outer Drill Sleeve, and the surgeon again maintains the position of the Positioning Rod by gripping its T-handles. The same technique is followed for insertion of the remaining screw(Fig. 30). A check is now carried out with the Image Intensifier or by X-ray to confirm that both screws have passed through the nail and that reduction has been maintained. The Positioning Rod, Outer Drill Sleeve and Targeter are removed.



(Fig.30)

Note: All NeoGen locking screw measuring devices, measure from bottom of head to the last complete thread of screw. This is the working length of the screw. Thus, the screw itself is longer than the measurement and adding length is not necessary.

Bone graft or bone graft substitutes should be used to fill in gaps around the bones to enhance bony union.

Instrument

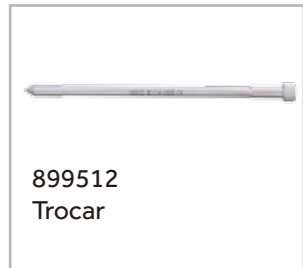

899512
Trocar



899513
Drill Sleeve 4.0



899514
Drill Sleeve 4.3



899519
Replacement Rod

Distal A/P Locking Screw Insertion (Optional)

Insert the Outer Drill Sleeve and Trochar through the most distal hole on the Targeter. A stab incision is now made beneath the Drill Sleeve, and the cortex exposed in each incision by blunt dissection, taking care to avoid damage to, the neurovascular structures. The Outer Drill Sleeve and Trochar are then advanced until they are in contact with the cortex. Use of either the standard Predrill technique or Screw Depth Gauge technique (page:6-8) to finish screw placement(Fig. 31).

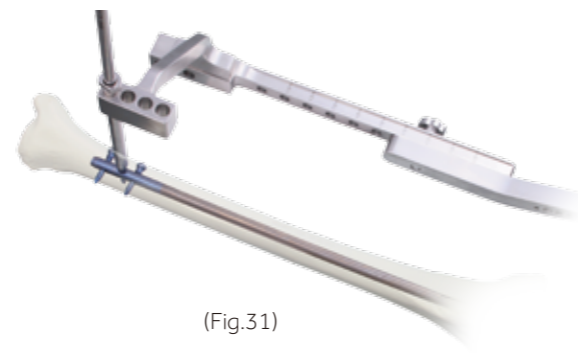

(Fig.31)

Note: For 11.5mm nail, the Targeter can be used for A/P placement of the second locking screw. The correct hole to insert the Drill Sleeves on the Targeter for the second A/P locking screw insertion is always next to the Positioning Rod hole no matter of the Distal Aiming Bar at the medial or lateral side.

SURGICAL TECHNIQUE

Tibia Nail	Number of Screw Holes @ Distal Side- A/P view	Number of Screw Holes@ Distal Side-M/L view
8.3&9mm nail	1	2
10&11.5 mm nail	2	2

End Cap Placement

If the end cap is considered, then attach the appropriate end cap by the Screwdriver for Locking Screw. Insert the end cap, and then turn the Connection Rod counterclockwise to finally remove the cannulated T-Handle.

Closure

Final position of the fracture is confirmed. Following completion of nailing and interlocking screw placement, the Guide and Drill Guide are disassembled by backing off the Quick Bolt. Irrigate incision with saline and close in a standard fashion(Fig. 32)



(Fig.32)

SURGICAL TECHNIQUE

NEOGEN Nail Extraction Technique

Nail removal may normally be carried out after 18-24 months provided that there is radiological evidence of union. Union may be expected to occur after 6 months with nailing procedures in the tibia. The situation may be different in open fractures, nonunions or corrective osteotomies. In such cases the nail should be left in situ for a minimum of 24 months.

Place the patient in the supine position on a radiolucent table. After prepping and draping, remove any distal screws and all but one proximal screw from the nail, leaving the screw closest to the driving end of the nail.

Under fluoroscopy, the proximal end of the nail is exposed through a small incision. It may be necessary to clear some new bone from the end of the nail. The nail end cap is removed with the Screwdriver for Locking Screw, and the Extractor (899498) is screwed on to the nail, and tightened firmly. This should be accomplished prior to the removal of the proximal locking screws to prevent the nail from deflecting posteriorly.

The locking screw proximal is now removed. The nail is then removed, either by manual traction on the Extractor, or by reverse hammering using Impactor, after the Impactor screwing on to the proximal end of the Extractor.

Instrument



APPENDIX

NeoGen Tibia Nails						
Process	Factors	Φ8mm	Φ9mm	Φ10mm	Φ11.5mm	
Entry	Proximal Dia.	11.5mm				
	Entry Reamer	Entry Reamer (Tibia) (898122)				
Proximal Locking	Proximal Color	Dark Golden				
	No.of Proximal Locking Screws	3				
	Proximal Locking Screws	5.0mm				
	Drill Bits for Locking Screws	Drill Bit, Φ4.3 (899517)				
	Drill Sleeve for Locking Screws	Drill Sleeve, 4.3 (899514)				
Distal Locking	Distal Color	Blue			Dark Golden	
	No.of Distal Locking Holes	3		4		
	Distal Locking Screws	4.5mm			5.0mm	
	Positioning Instruments	Drill Sleeve (899506)				
		Drill Sleeve, 5.2 (899508)				
		Drill Bit, Φ5.2 (899509)				
		Position rod Drill (899510)				
		Position Rod (899530)				
		E-Block, 8/9 (899532)		E-Block, 10/11.5 (899533)		
	Drill Bits for Distal Locking	Drill Bit, Φ4.0 (899515)			Drill Bit, Φ4.3 (899517)	
Drill Sleeve for Distal Locking	Drill Sleeve, 4.0 (899513)			Drill Sleeve, 4.3 (899514)		

PRODUCTS INFORMATION

Implants



NeoGen Tibial Nails			
Code	Instruments name	Size	Materials
33140026	NeoGen Tibia Nails	8.3X260mm	TA
33140028	NeoGen Tibia Nails	8.3X280mm	TA
33140030	NeoGen Tibia Nails	8.3X300mm	TA
33140032	NeoGen Tibia Nails	8.3X320mm	TA
33140034	NeoGen Tibia Nails	8.3X340mm	TA
33140036	NeoGen Tibia Nails	8.3X360mm	TA
33140038	NeoGen Tibia Nails	8.3X380mm	TA
33140040	NeoGen Tibia Nails	8.3X400mm	TA
33140042	NeoGen Tibia Nails	8.3X420mm	TA
33141026	NeoGen Tibia Nails	9X260mm	TA
33141028	NeoGen Tibia Nails	9X280mm	TA
33141030	NeoGen Tibia Nails	9X300mm	TA
33141032	NeoGen Tibia Nails	9X320mm	TA
33141034	NeoGen Tibia Nails	9X340mm	TA
33141036	NeoGen Tibia Nails	9X360mm	TA
33141038	NeoGen Tibia Nails	9X380mm	TA
33141040	NeoGen Tibia Nails	9X400mm	TA
33141042	NeoGen Tibia Nails	9X420mm	TA
33142026	NeoGen Tibia Nails	10X260mm	TA
33142028	NeoGen Tibia Nails	10X280mm	TA
33142030	NeoGen Tibia Nails	10X300mm	TA
33142032	NeoGen Tibia Nails	10X320mm	TA
33142034	NeoGen Tibia Nails	10X340mm	TA
33142036	NeoGen Tibia Nails	10X360mm	TA
33142038	NeoGen Tibia Nails	10X380mm	TA
33142040	NeoGen Tibia Nails	10X400mm	TA
33142042	NeoGen Tibia Nails	10X420mm	TA

PRODUCTS INFORMATION

33143026	NeoGen Tibia Nails	11.5X260mm	TA
33143028	NeoGen Tibia Nails	11.5X280mm	TA
33143030	NeoGen Tibia Nails	11.5X300mm	TA
33143032	NeoGen Tibia Nails	11.5X320mm	TA
33143034	NeoGen Tibia Nails	11.5X340mm	TA
33143036	NeoGen Tibia Nails	11.5X360mm	TA
33143038	NeoGen Tibia Nails	11.5X380mm	TA
33143040	NeoGen Tibia Nails	11.5X400mm	TA
33143042	NeoGen Tibia Nails	11.5X420mm	TA



NeoGen Locking Screws			
Code	Instruments name	Size	Materials
33111025	NeoGen Locking Screws	4.5X26mm	TA
33111030	NeoGen Locking Screws	4.5X30mm	TA
33111035	NeoGen Locking Screws	4.5X35mm	TA
33111040	NeoGen Locking Screws	4.5X40mm	TA
33111045	NeoGen Locking Screws	4.5X45mm	TA
33111050	NeoGen Locking Screws	4.5X50mm	TA
33111055	NeoGen Locking Screws	4.5X55mm	TA
33111060	NeoGen Locking Screws	4.5X60mm	TA
33111065	NeoGen Locking Screws	4.5X65mm	TA
33111070	NeoGen Locking Screws	4.5X70mm	TA
33111075	NeoGen Locking Screws	4.5X75mm	TA
33111080	NeoGen Locking Screws	4.5X80mm	TA
33111085	NeoGen Locking Screws	4.5X85mm	TA
33111090	NeoGen Locking Screws	4.5X90mm	TA
33112025	NeoGen Locking Screws	5X26mm	TA
33112030	NeoGen Locking Screws	5X30mm	TA
33112035	NeoGen Locking Screws	5X35mm	TA
33112040	NeoGen Locking Screws	5X40mm	TA
33112045	NeoGen Locking Screws	5X45mm	TA
33112050	NeoGen Locking Screws	5X50mm	TA
33112055	NeoGen Locking Screws	5X55mm	TA
33112060	NeoGen Locking Screws	5X60mm	TA

PRODUCTS INFORMATION

33112065	NeoGen Locking Screws	5X65mm	TA
33112070	NeoGen Locking Screws	5X70mm	TA
33112075	NeoGen Locking Screws	5X75mm	TA
33112080	NeoGen Locking Screws	5X80mm	TA
33112085	NeoGen Locking Screws	5X85mm	TA
33112090	NeoGen Locking Screws	5X90mm	TA
33112091	NeoGen Locking Screws	5X95mm	TA
33112092	NeoGen Locking Screws	5X100mm	TA



NeoGen Nail Caps

Code	Instruments name	Size	Materials
33110000	NeoGen Nails Caps(Knee)	∅ 8.2	TA
33144005	NeoGen Nails Caps(Knee)	∅ 11.5, +5	TA
33144010	NeoGen Nails Caps(Knee)	∅ 11.5, +10	TA
33144015	NeoGen Nails Caps(Knee)	∅ 11.5, +15	TA

PRODUCTS INFORMATION

Instruments

Code	Description	QTY.
899460	Neogen Nail Instruments Set	
898357	Neogen Nail Basic Instruments Set (Empty)-PPSU	1
898358	NeoGen Nail Special Instruments Set (Empty)-PPSU	1
898196	NeoGen Nail Special Instruments Set Empty Tray	1
899461	Awl	1
899464	Tissue Protector	1
899467	L-Hex Wrench, SW3 for Stopper ∅ 7mm	1
899469	Reducer	1
899470	Ball Tip Guide Wire	1
251170	Guide Wire Holder	1
050013	Hex Reamer Shaft-Dual Direction	1
899472	Hex Reamer Shaft-Mono Direction	1
050085	Reamer, ∅ 8.5mm	1
050090	Reamer, ∅ 9mm	1
050095	Reamer, ∅ 9.5mm	1
050100	Reamer, ∅ 10mm	1
050105	Reamer, ∅ 10.5mm	1
050110	Reamer, ∅ 11mm	1
050115	Reamer, ∅ 11.5mm	1
050120	Reamer, ∅ 12mm	1
050125	Reamer, ∅ 12.5mm	1
050130	Reamer, ∅ 13mm	1
050135	Reamer, ∅ 13.5mm	1
899468	T-Handle with Quick Coupling	1
899497	Guide Bolt Wrench Shaft	1
899498	Extractor	1
899499	Insertion Handle	1
899500	Guide Bolt	2
899502	Impactor	1
899489	Guide Wire Sleeve 2.5	1
899490	Guide Wire, ∅ 2.5mm	3
899491	Guide Wire with Threaded Tip, ∅ 2.5mm	3
899492	Direct Measuring Device for Guide Wires	1
899484	Screw Depth Gauge	1
899485	Tap, ∅ 4.5mm	1
899486	Tap, ∅ 5.0mm	1
899496	Tap, ∅ 6.4mm	1
899493	Drill Sleeve 6.4	2
899494	Drill Bit, ∅ 6.4mm	1
899495	Stopper, ∅ 6.4mm	1

Code	Description	QTY.
899487	Screwdriver for Locking Screw	1
899488	Screwdriver for Locking Screw, Long	1
899503	Proximal Bolt	2
899504	Distal Bolt	3
899505	Bolt Wrench, SW5.0	1
899506	Trochar Sleeve (Position Rod)	1
899507	Trochar (Position Rod)	1
899508	Drill Sleeve 5.2 (Position Rod)	1
899509	Drill Bit, ∅ 5.2mm (Position Rod)	1
899510	Position Rod Drill (Position Rod)	1
899511	Trocar Sleeve for Locking Screw	2
899512	Trocar for Locking Screw	1
899513	Drill Sleeve 4.0	1
899514	Drill Sleeve 4.3	1
899515	Drill Bit, ∅ 4.0mm	2
899516	Stopper, ∅ 4.0mm	1
899517	Drill Bit, ∅ 4.3mm	2
899518	Stopper, ∅ 4.3mm	1
899519	Replacement Rod	1
899462	Entry Inner Trochar (Femur)	1
899463	Entry Drill Sleeve (Femur)	1
899465	Entry Reamer (Femur)	1
899466	Stopper, ∅ 7mm	2
899520	Proximal Aiming Bar (Femur)	1
899521	Distal Aiming Bar (Femur)	1
899522	Targeter (Femur)	1
899523	Position Rod	1
899524	E Block 10/9 (Femur)	1
899525	E Block 12/11 (Femur)	1
898127	Entry Inner Trochar (Knee)	1
898128	Entry Drill Sleeve (Knee)	1
898122	Entry Reamer (Knee)	1
899526	Proximal Aiming Bar (Knee), Left	1
899527	Proximal Aiming Bar (Knee), Right	1
899531	Proximal Aiming Device (Knee)	1
899528	Distal Aiming Bar (Knee)	1
899529	Targeter (Knee)	1
899530	Position Rod (Knee)	1
899532	E Block 9/8(Knee)	1
899533	E Block 11.5/10 (Knee)	1

Optional

Code	Description
898381	Awl
898382	Radiographic Ruler
251620	Joint Screwdriver for End Cap

Implant Case

Code	Description
898371	NeoGen Femoral Nails implant case
898372	NeoGen Tibia Nails implant case
98702	NeoGen Femoral nail Implant case (Paragon)
98701	NeoGen Tibia nail Implant case (Paragon)

PRODUCTS INFORMATION



899461
Awl



899464
Tissue Protector



899467
L-Hex Wrench, SW3
for Stopper Φ 7mm

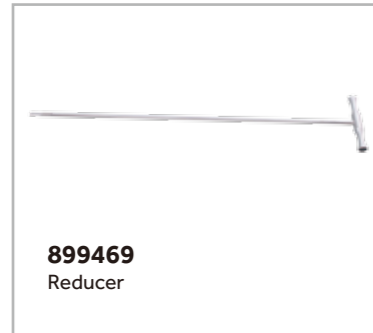

899469
Reducer



899470
Ball Tip Guide Wire



251170
Guide Wire Holder

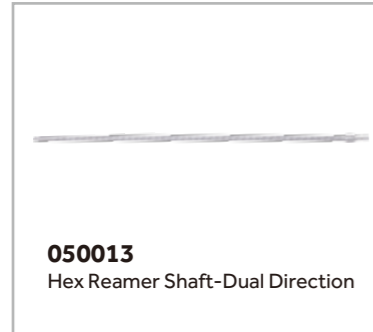

050013
Hex Reamer Shaft-Dual Direction



899472
Hex Reamer Shaft-Mono Direction



050085
Reamer, Φ 8.5mm



050090
Reamer, Φ 9mm



050095
Reamer, Φ 9.5mm



050100
Reamer, Φ 10mm

PRODUCTS INFORMATION



050105
Reamer, Φ 10.5mm



050110
Reamer, Φ 11mm



050115
Reamer, Φ 11.5mm



050120
Reamer, Φ 12mm



050125
Reamer, Φ 12.5mm



050130
Reamer, Φ 13mm



050135
Reamer, Φ 13.5mm



899468
T-Handle with Quick Coupling



899497
Guide Bolt Wrench Shaft



899498
Extractor



899499
Insertion Handle



899500
Guide Bolt

PRODUCTS INFORMATION



899502
Impactor



899489
Guide Wire Sleeve 2.5

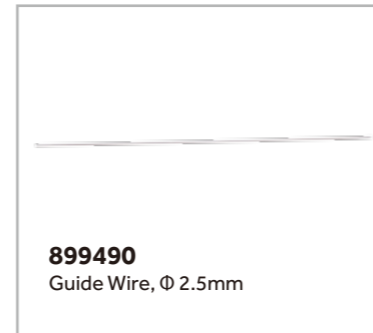

899490
Guide Wire, Ø 2.5mm

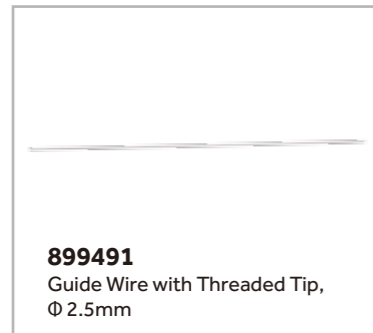

899491
Guide Wire with Threaded Tip,
Ø 2.5mm



899492
Direct Measuring Device for
Guide Wires

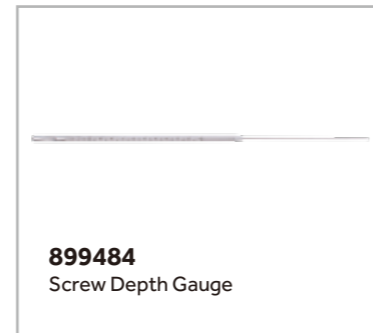

899484
Screw Depth Gauge



899485
Tap, Ø 4.5mm



899486
Tap, Ø 5.0mm

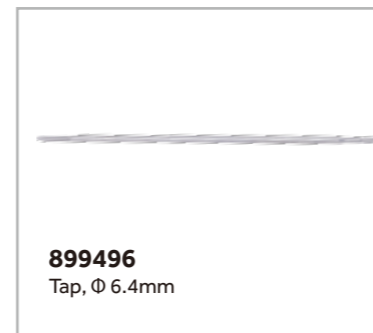

899496
Tap, Ø 6.4mm



899493
Drill Sleeve 6.4



899494
Drill Bit, Ø 6.4mm



899495
Stopper, Ø 6.4mm

PRODUCTS INFORMATION



899487
Screwdriver for Locking Screw



899488
Screwdriver for Locking Screw,
Long



899503
Proximal Bolt



899504
Distal Bolt



899505
Bolt Wrench, SW5.0



899506
Trochar Sleeve (Position Rod)



899507
Trochar (Position Rod)



899508
Drill Sleeve 5.2 (Position Rod)

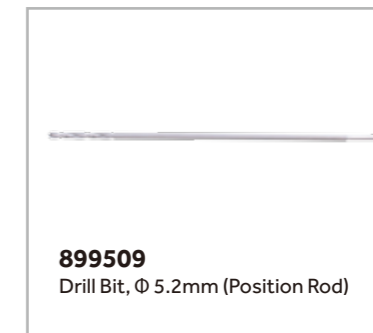

899509
Drill Bit, Ø 5.2mm (Position Rod)



899510
Position Rod Drill (Position Rod)





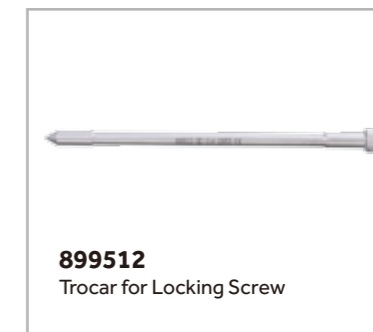



899511
Trocar Sleeve for Locking Screw



899512
Trocar for Locking Screw

PRODUCTS INFORMATION

 899513 Drill Sleeve 4.0	 899514 Drill Sleeve 4.3	 899515 Drill Bit, Ø 4.0mm
 899516 Stopper, Ø 4.0mm	 899517 Drill Bit, Ø 4.3mm	 899518 Stopper, Ø 4.3mm
 899519 Replacement Rod	 899462 Entry Inner Trochar (Femur)	 899463 Entry Drill Sleeve (Femur)
 899465 Entry Reamer (Femur)	 899466 Stopper, Ø 7mm	 899520 Proximal Aiming Bar (Femur)

PRODUCTS INFORMATION

 899521 Distal Aiming Bar (Femur)	 899522 Targeter (Femur)	 899523 Position Rod
 899524 E Block 10/9 (Femur)	 899525 E Block 12/11 (Femur)	 898127 Entry Inner Trochar (Knee)
 898128 Entry Drill Sleeve (Knee)	 898122 Entry Reamer (Knee)	 899526 Proximal Aiming Bar (Knee), Left
 899527 Proximal Aiming Bar (Knee), Right	 899531 Proximal Aiming Device (Knee)	 899528 Distal Aiming Bar (Knee)

PRODUCTS INFORMATION

NOTE



NOTE
