

Endoscopes

OPERATION MANUAL

Upper and Lower Gastrointestinal Endoscopes

EG-720R

EC-720R/M

EC-720R/I

EC-720R/L

This Operation Manual provides details on how to prepare and operate the endoscope and describes cautions to be observed. Please read this manual thoroughly before operating the endoscope. After reading this manual, store it nearby the endoscope so that you can review it whenever necessary.

Introduction

1 Precautions

2 Product Overview

3 Workflow

4 Preparation and Inspection

5 How to Use

6 Troubleshooting

7 Service

Appendix



CE 0123



Contents at a Glance

Introduction

This chapter explains about this manual.

Chapter 1 Precautions

Before using this product, read this chapter carefully so that you can operate it correctly. This chapter describes the warnings and cautions for safe operation of the endoscope.

Chapter 2 Product Overview

This chapter describes details on the accessories supplied with this product, the nomenclature and functions of the endoscope, and related equipment connected to this product.

Chapter 3 Workflow

This chapter describes the workflow of endoscopy, which differs depending on the type of endoscope and accessories to be used.

Chapter 4 Preparation and Inspection

This chapter describes the inspection and preparation methods to be performed before using the endoscope, its accessories and related equipment.

Chapter 5 How to Use

This chapter describes the basic operation procedures of this product and precautions to observe.

Chapter 6 Troubleshooting

This chapter describes actions which should be taken if problems occur while inspecting or using the endoscope.

Chapter 7 Service

This chapter explains the services regarding this product.

Appendix

This chapter describes main specifications, related equipment used in combination with this product, electromagnetic compatibility (EMC), etc.

Contents

Contents at a Glance	iii
Introduction	1
About This Manual	1
◆ Endoscope Operation Manuals	2
How to Read This Manual	3
◆ Terms	3
◆ Conventions Used in This Manual	3
Chapter 1 Precautions	1-1
1.1 Intended Use	1-1
1.2 Applicability of Endoscopy and Endoscopic Treatment	1-1
1.3 User Qualifications	1-2
1.4 Prohibition of Modification and Improper Repair	1-2
1.5 Reprocessing Before the First Use/Reprocessing and Storage After Use	1-3
1.5.1 Reprocessing Before the First Use/Reprocessing After Use	1-3
1.5.2 Storage After Use	1-4
1.5.3 Disposal	1-4
1.6 For Safe Operation	1-4
1.7 Maintenance	1-4
1.8 Symbols	1-5
1.9 Precautions for Transportation	1-7
1.10 Precautions Against Electric Shock	1-7
1.11 Electromagnetic Compatibility (EMC)	1-8
1.12 General Warnings and Cautions	1-10
1.12.1 Precautions for Inspection Before Use	1-10
1.12.2 Handling Precautions	1-11
1.12.3 Abnormalities during Use of This Product	1-15
1.12.4 Precautions for Water Jet Function	1-16
1.13 Precautions for Equipment Used in Combination	1-18
1.13.1 Precautions for High-Frequency Treatment	1-20
1.13.2 Precautions for Endotherapy Device and Syringe	1-21
1.14 Main Adverse Events	1-22
Chapter 2 Product Overview	2-1
2.1 Checking Package Contents	2-1
2.1.1 Endoscope	2-1
2.1.2 Accessories	2-2
◆ Accessories Common to All Models	2-2
◆ Accessories for Endoscopes with Specific Functions	2-3
2.2 Nomenclature and Functions of Endoscope	2-4
◆ Scope Connector (One Step Connector)	2-6

	◆ LG Flexible Portion	2-6
	◆ Control Portion (G7 control portion)	2-6
	◆ Boot.....	2-7
	◆ Insertion Portion (Applied Part).....	2-8
2.3	Nomenclature and Functions of Distal End of Endoscope	2-9
2.4	Location of Each Label.....	2-10
2.4.1	Location of Labels	2-10
2.5	System Configuration	2-11
2.5.1	System Configuration (Combination with EP-6000).....	2-12
2.5.2	System Configuration (Combination with VP-7000 and BL-7000)	2-14
Chapter 3	Workflow	3-1
3.1	When Using Standard Functions.....	3-2
3.2	When Using Water Jet Function.....	3-4
Chapter 4	Preparation and Inspection	4-1
4.1	Preparation of the Equipment.....	4-2
	◆ Endoscope	4-2
	◆ Accessories.....	4-2
	◆ Related Equipment (Essential)	4-3
	◆ Related Equipment (To be Prepared when Necessary)	4-3
	◆ Personal Protective Equipment.....	4-4
	◆ Others	4-4
4.2	Transporting Endoscope	4-5
4.3	Inspecting Endoscope	4-6
4.3.1	Inspecting Control Portion.....	4-6
4.3.2	Inspecting Insertion Portion.....	4-6
4.3.3	Inspecting Distal End	4-7
4.3.4	Inspecting Bending Section.....	4-8
	◆ Inspection for Smooth Operation	4-8
	◆ Inspecting Up/Down Angulation	4-9
	◆ Inspecting Left/Right Angulation	4-10
4.3.5	Inspecting Scope Connector.....	4-11
4.4	Inspecting and Attaching Accessories.....	4-12
4.4.1	Forceps Valve	4-12
4.4.2	Suction Valve	4-13
4.4.3	Air/Water Valve	4-15
4.4.4	J Tube	4-17
4.5	Preparing Related Equipment	4-19
4.5.1	Inspecting Related Equipment	4-19
4.5.2	Preparing System.....	4-19
4.6	Connecting Endoscope to Processor (Light Source) and Related Equipment.....	4-21
4.6.1	Connecting to Processor (Light Source)	4-21
4.6.2	Attaching Water Tank.....	4-22
4.6.3	Attaching Suction Unit.....	4-23

4.6.4	Attaching J Tube	4-24
4.6.5	Attaching Water Pump	4-25
4.7	Inspecting Functions Used in Combination with Related Equipment	4-26
4.7.1	Inspecting Endoscopic Images	4-26
4.7.2	Inspecting Scope Switch	4-27
4.7.3	Inspecting Air/Water Supply Function	4-28
4.7.4	Inspecting Suction Function	4-29
4.7.5	Inspecting Instrument Channel	4-30
4.7.6	Inspecting Water Jet Channel	4-30
Chapter 5 How to Use		5-1
5.1	Preparation	5-3
5.1.1	Preparing Related Equipment	5-3
5.1.2	Pretreatment of Patient	5-3
5.1.3	Preparing Mouthpiece	5-3
5.2	Insertion and Observation	5-4
5.2.1	Insertion	5-4
5.2.2	Observing Endoscopic Image	5-5
5.2.3	Operating Scope Switch	5-6
5.2.4	Bending Operation	5-7
5.2.5	Operating Air/Water Valve	5-8
5.2.6	Operating Suction Valve	5-10
5.3	Using Water Jet Function	5-11
5.4	Injecting Fluids from Instrument Channel Inlet	5-13
5.5	Treatment	5-14
5.5.1	Using Endotherapy Devices	5-14
5.5.2	Use of Non-Flammable Gases	5-16
5.5.3	High-Frequency Treatment	5-16
5.6	Endoscope Withdrawal	5-18
5.7	Reprocessing Endoscope	5-19
Chapter 6 Troubleshooting		6-1
6.1	Troubleshooting	6-2
6.1.1	Problem with Displayed Images	6-2
6.1.2	Problem with Scope Switch	6-3
6.1.3	Problem with Bending Section	6-3
6.1.4	Problem with Air/Water Supply	6-4
6.1.5	Problem with Suction	6-5
6.1.6	Problem with Water Jet Function	6-5
6.1.7	Problem with Related Equipment	6-6
	◆ Problem with Endotherapy Devices	6-6
	◆ Problem with Image Recorder	6-6
6.2	Withdrawal of Endoscope with Abnormality	6-7
6.2.1	When Endoscopic Images Appear on the Monitor	6-7
6.2.2	When Either Normal Observation Mode or Special Light Observation Mode is Not Available	6-8

6.2.3	When Endoscopic Images Do Not Appear on the Monitor or a Frozen Image Cannot be Restored	6-8
6.3	Handling of Endoscope with Abnormality	6-9
6.3.1	When Suction Valve Does Not Return to Its Original Position	6-9
6.4	Returning Endoscope for Repair	6-11
Chapter 7	Service	7-1
7.1	Service	7-1
7.2	After-Sales Service	7-1
	◆ Repairs during the warranty period	7-1
	◆ Repairs after the warranty period	7-1
Appendix		Appendix-1
	Main Specification	Appendix-1
	◆ Classification of Medical Electrical Equipment	Appendix-1
	◆ Electromagnetic Compatibility (EMC) Related Standard	Appendix-1
	◆ Applied Part	Appendix-1
	◆ Specifications	Appendix-2
	Operating Environment, Transport Environment and Storage Environment	Appendix-6
	◆ Operating Environment	Appendix-6
	◆ Transport Environment	Appendix-6
	◆ Storage Environment	Appendix-6
	◆ Term of Validity/Period for Use (Durability)	Appendix-6
	Accessories	Appendix-7
	◆ Accessories Common to All Models	Appendix-7
	◆ Accessories for Endoscopes with Specific Functions	Appendix-7
	Related Equipment Used in Combination	Appendix-8
	◆ Compatible Processor and Light Source	Appendix-8
	◆ Water Tank	Appendix-8
	◆ Suction Unit	Appendix-8
	◆ Endoscopic CO ₂ Regulator and Accessories	Appendix-8
	◆ Water Pump	Appendix-9
	◆ Electrosurgical Unit	Appendix-9
	◆ Ultrasonic Processor	Appendix-9
	◆ Mouthpiece	Appendix-9
	◆ Hood	Appendix-9
	◆ Compatible Endotherapy Devices	Appendix-10
	◆ Medical Device Directive	Appendix-10
	Electromagnetic Compatibility (EMC) Information	Appendix-11
	Disposal of Electric and Electronic Equipment	Appendix-21
	Index	Appendix-22
	Service Centers	

Introduction

This chapter explains about this manual.

About This Manual

This manual provides necessary information for using this product, such as the equipment overview, operation procedures and precautions to observe. In addition, the Reprocessing Manual supplied with this product describes the reprocessing and storage methods for the endoscope. This manual does not provide information about procedures or any aspects of endoscopic techniques.

Before using this product, thoroughly read and understand this manual, the Reprocessing Manual and the manual of related equipment and use this product as instructed. Also, after reading this manual, store it close to this product for future reference to keep this product in optimum working condition.

If you have any questions or comments about any information in this manual, contact your local FUJIFILM dealer.

The EG-720R, EC-720R/M, EC-720R/I and EC-720R/L endoscopes are used in combination with the EP-6000 processor. These endoscopes can also be used in combination with the VP-7000 processor and the BL-7000 light source. The explanation in this manual is based on the premise that the endoscope is used in combination with the EP-6000 processor unless otherwise noted.

This manual may not be reproduced in whole or in part in any form without prior permission.
The information contained in this manual may be subject to change without prior notice.

Trademarks

The company names and product names described in this manual are trademarks or registered trademarks of FUJIFILM Corporation or its subsidiaries.

Other holders' trademarks

All other company names and product names described in this manual are trademarks or registered trademarks of their respective owners.

Copyright © 2018-2021 FUJIFILM Corporation. All rights reserved.

◆ Endoscope Operation Manuals

Manage and store “Operation Manual” and “Reprocessing Manual” together as a set.

Endoscope Operation Manual

Model: EG-720R, EC-720R/M, EC-720R/I, EC-720R/L

⇒ This manual provides necessary information for using the endoscope such as the equipment overview, operation procedures and precautions to observe.

Endoscope Reprocessing Manual

Model: EG-720R, EC-720R/M, EC-720R/I, EC-720R/L

⇒ This manual describes the reprocessing and storage methods of the endoscope.

Note

- In this manual, the Endoscope Operation Manual is referred to as “this manual”, and the Endoscope Reprocessing Manual as “the Reprocessing Manual.”

How to Read This Manual

◆ Terms

Term	Description
Reprocessing	It refers to disinfection or sterilization performed after the manual cleaning of the endoscope and its accessories according to the Reprocessing Manual supplied with this product.
This product	It refers to the endoscope with or without attached accessories.
Standard accessory	It refers to the parts and devices included in the package or supplied with this product.
Accessory	It refers to the parts and devices directly attached to or used with the endoscope.
Related equipment	It refers to the devices directly or indirectly connected to or used with this product during a procedure.
Consumable item	It refers to parts and products whose life expectancy is limited and which require replacement once they show signs of wear or irregularity. Such parts and products cannot be repaired or refurbished and should be replaced after any irregularity (described in "Section 4.4 Inspecting and Attaching Accessories") is observed. <div style="border: 1px solid black; padding: 2px; margin-top: 5px;"> Note <ul style="list-style-type: none"> • Some of the parts and products may be able to be repaired. For details on them, contact your local FUJIFILM dealer. </div>

◆ Conventions Used in This Manual

This manual uses the following conventions for easier understanding.

Convention	Description
WARNING	Explains dangerous situations that may cause death or serious injury if not avoided.
CAUTION	Explains situations that may cause injury if not avoided. Explains situations that may cause damage to equipment if not avoided.
(1), (2), (3), ...	Indicates consecutive numbers in operating procedures for the order in which successive steps in the procedure should be taken.
Note	Indicates a comment or supplementary information.
→	Indicates a reference.

Before using this product, read this chapter carefully so that you can operate it correctly. This chapter describes the warnings and cautions for safe operation of the endoscope.

1.1 Intended Use

FUJIFILM Endoscope Model EG-720R is intended for the observation, diagnosis and endoscopic treatment of the upper digestive tract, specifically the pharynx, larynx, esophagus, stomach and duodenum, and for the observation of the oral cavity at medical facilities under the management of physicians.

FUJIFILM Endoscope Models EC-720R/M, EC-720R/I and EC-720R/L are intended for the observation, diagnosis and endoscopic treatment of the lower digestive tract, specifically the rectum, sigmoid colon, large intestine and ileocecal region, at medical facilities under the management of physicians.

Never use this product for any other purposes.

WARNING

- Never use this product for any other purposes. It may cause severe harm to patient and/or end-users.

1.2 Applicability of Endoscopy and Endoscopic Treatment

Proper clinical judgment should be exercised for the applicability of endoscopy and endoscopic treatment. If there are official standards on the applicability of endoscopy and endoscopic treatment that are defined by the hospital's administrators or other official institutions, such as academic societies on endoscopy, follow those standards.

Perform endoscopy and endoscopic treatment only when the benefits outweigh the risks.

1.3 User Qualifications

WARNING

- The healthcare facilities owning this product are responsible for the use and maintenance of this product. If this product is not used or maintained properly, it may cause severe harm to patient or end-users.
- This product is intended for use by medical professionals who have received proper training in endoscopic procedures. This manual does not provide information about procedures or any aspects of endoscopic techniques. Not following the recommendations may cause severe harm to patient or end-users.

If there are official standards for user qualifications for performing endoscopy and endoscopic treatment that are defined by the hospital's medical administrators or other official institutions such as academic societies on endoscopy, follow those standards.

The physician should be capable of safely performing the planned endoscopy and endoscopic treatment following guidelines set by the academic societies on endoscopy, etc., and considering the difficulty of endoscopy and endoscopic treatment.

1.4 Prohibition of Modification and Improper Repair

Do not modify this product or its components, and do not disassemble, repair or in any other way reverse-engineer these products. Even if you find a defect, do not attempt to repair these products yourself. FUJIFILM Corporation shall not be liable for any defects, adverse events or device failures caused by such modifications, disassembly, repairs or reverse-engineering.

FUJIFILM Corporation shall not be liable for malfunctions, adverse events or damages caused by remodeling, maintenance, and repair using repair parts other than those authorized by FUJIFILM Corporation.

FUJIFILM Corporation shall not be liable for malfunctions, adverse events or damages caused by installation, relocation, remodeling, maintenance, and repair not performed by FUJIFILM Corporation or by dealers authorized by FUJIFILM Corporation.

WARNING

- Do not disassemble or modify this product. Do not perform unauthorized repairs. If any disassembly, modification or improper repair is performed, it may cause severe harm to patient or end-users.

CAUTION

- Do not disassemble or modify this product. Do not perform unauthorized repairs. If any disassembly, modification or improper repair is performed, it may cause equipment failure.

1.5 Reprocessing Before the First Use/Reprocessing and Storage After Use

1.5.1 Reprocessing Before the First Use/Reprocessing After Use

This product has not been reprocessed. The endoscope and its accessories must be reprocessed prior to first use as per instructions provided in the Reprocessing Manual. After using the endoscope and its accessories, reprocess and store them according to the instructions provided in the Reprocessing Manual.

Note

- Delayed reprocessing of endoscopes is not recommended.

WARNING

- The entire surface and each channel of the endoscope and the accessories must be reprocessed prior to first use, after any servicing, after any subsequent use, and after storage as per instructions provided in the Reprocessing Manual, even if the accessories were not used during a procedure. In addition, store this product as per instructions provided in the Reprocessing Manual. Inadequate reprocessing or storage may cause infection.
- When using this product for a patient with Creutzfeldt-Jakob disease, use it exclusively for a patient with the same disease, or properly discard this product after use. Since the cleaning, disinfection and sterilization methods described in the Reprocessing Manual of this product cannot eliminate the causal agents of Creutzfeldt-Jakob disease, the product could be a source of infection. For the treatment of Creutzfeldt-Jakob disease, refer to local guidelines.
- Immediately upon completion of the procedure, it is imperative that pre-cleaning is performed as per instructions provided in the Reprocessing Manual. Otherwise, residual organic debris may begin to dry and solidify and hinder effective removal and reprocessing, causing infection.

CAUTION

- The entire surface and each channel of the endoscope and the accessories must be reprocessed prior to first use, after any servicing, after any subsequent use, and after storage as per instructions provided in the Reprocessing Manual. In addition, store this product as per instructions provided in the Reprocessing Manual. Inadequate reprocessing or storage may cause equipment damage, or reduce performance.
- Do not forcibly twist or bend the insertion tube of the endoscope. It could damage the endoscope.

1.5.2 Storage After Use

Store this product after reprocessing. For details on the reprocessing and storage of the endoscope, refer to the Reprocessing Manual.

1.5.3 Disposal

For details on the disposal of the endoscope and accessories, refer to the Reprocessing Manual.

1.6 For Safe Operation

Be sure to prepare a spare endoscope for unexpected events such as the failure of this product. Otherwise, you may not be able to continue the endoscopic procedure. If the spare endoscope is not available, prepare other alternative means such as abdominal surgery.

Note

- It is highly recommended that spare or back-up equipment be available to complete procedures due to unforeseen circumstances including but not limited to interruption or loss of a clear endoscopic image, equipment failure, etc.
- If an endoscopic image is lost or compromised during a therapeutic procedure, immediately stop treatment and withdraw the endotherapy device together with the endoscope. Use back-up equipment to complete the procedure as necessary.

1.7 Maintenance

WARNING

















- Deterioration or degradation of the endoscope components or its accessories may occur due to factors such as long-term use, procedures, routine handling and repeated reprocessing. Have this product checked by service personnel once every six months or once every 100 cases, whichever comes first. Use of nonfunctional equipment may cause severe harm to patient or end-users.

This product should not be subjected to any type of repair or maintenance procedure while it is being clinically used on a patient (or while it is being reprocessed).

The more the product is used, the greater the probability of failure of the endoscope and its accessories. Do not use the endoscope that shows any sign of abnormality or irregularity. Take appropriate measures by following "Chapter 6 Troubleshooting." If the irregularity is still observed after inspection, contact your local FUJIFILM dealer.

1.8 Symbols

This section explains the safety signs used in this product.

Symbol	Description
	Do not re-use / Single patient use only
	Lot number
	Serial number
	Date of manufacture
	Manufacturer
	Authorised representative in the European Community
	Authorised representative domiciled in Switzerland
 (Blue)	Refer to instructions for use
	Temperature limitation
	Keep dry
	Non-sterile
	CE marking
	Type BF applied part
	WEEE marking ^{**1}
	Humidity limitation
	Atmospheric pressure limitation
	Minimum diameter of the instrument channel: 2.8 mm

Symbol	Description
	Minimum diameter of the instrument channel: 3.8 mm

*1 This product shall not be treated as household waste.

1.9 Precautions for Transportation

WARNING

- Carry a reprocessed endoscope in a clean manner. If personal protective equipment such as gloves is contaminated, the contaminants adhere to the endoscope and it can be a source of infection.
- Contact your local FUJIFILM dealer when this product is returned for repair. Be sure to reprocess this product before returning for repair. If a product which is not reprocessed is returned, it can create a risk of infection to users, service personnel or other persons in contact with it.

CAUTION

- When transporting a reprocessed endoscope, firmly grasp the control portion and scope connector. If only the LG flexible portion or the boot is grasped, it may damage the endoscope.
- When transporting a reprocessed endoscope, do not coil the insertion tube or the LG flexible portion of the endoscope with a small diameter. Doing so may cause endoscope failure.
- When transporting the endoscope to the outside of the hospital, store the endoscope in a FUJIFILM-specified carrying case. Not doing so may cause product failure.

1.10 Precautions Against Electric Shock

WARNING

- Connect the power plug of related equipment to be used to the protective earth receptacle. Not doing so may cause an electric shock.

CAUTION

- Do not use related equipment which is not described in this manual. If the endoscope is used in combination with endoscopic accessories connected to other medical devices, it may cause an electric shock due to an increase in patient leakage current.

1.11 Electromagnetic Compatibility (EMC)

This product generates, uses and can radiate electromagnetic energy. To prevent electromagnetic interference within the vicinity of this product, read the following precautions and properly handle this product and other devices in the vicinity.

Install and use this product according to “Electromagnetic Compatibility (EMC) Information” in Appendix.

WARNING

- Do not place any objects that emit strong electromagnetic waves near this product. Otherwise, malfunction of this product may occur.
- Do not use this product adjacent to other equipment. If such use is necessary, this product and the other equipment should be observed to verify that they are operating normally. Failure to do so could result in improper operation.
- Do not use portable and mobile RF communications equipment closer than 30 cm to any part of this product. Otherwise, degradation of the performance of this product could result.

CAUTION

- Use this product in the specified environment and with specified methods. Failure to do so may result in an abnormality of an endoscopic image (rotation or inversion of the viewing image).
- Noise may appear on the monitor of this product due to the effect of electromagnetic interference. In this case, turn off the device emitting the electromagnetic waves or move the device away from the monitor.

This product may receive electromagnetic interference even if related equipment conforming to EN 55011 is used.

Use of this product may cause electromagnetic interference. Depending upon the strength of electromagnetic interference within the vicinity of this product, malfunction of this product or peripherals may occur. If this product does cause harmful electromagnetic interference to other devices, or if this product receives electromagnetic interference from other devices, we recommend that you may try to correct the interference by one or more of the following measures:

- Change the orientation or position of any affected device.
- Increase the spacing between devices.
- Connect the product into an outlet on a circuit different from that to which the other device(s) are connected.
- Take mitigation measures such as shielding the installation location of any affected device.

If the problem cannot be solved with the above measures, stop using this product and consult the manufacturer or your local FUJIFILM dealer for help.

Do not use this product near devices, such as MRI systems, that generate strong electromagnetic waves. Doing so may cause malfunction of this product.
(If this product is used in combination with an electrosurgical unit, follow the instructions provided in the operation manuals of the electrosurgical unit and high-frequency endotherapy device.)

1.12 General Warnings and Cautions

Observe the following cautions when handling this product. Also, there are some cautions in each chapter.

1.12.1 Precautions for Inspection Before Use

WARNING

- Make sure to inspect the endoscope and accessories before use according to the procedures provided in this manual. Do not use the equipment that shows any signs of abnormality or irregularity. Use of abnormal equipment may lead to misdiagnosis or increase risks to patient safety.
- Make sure to check the forceps valve before use. If the inspection result shows any sign of abnormality or irregularity, replace the forceps valve with a new one already reprocessed. Use of an abnormal forceps valve may cause the leakage of body fluid, posing an infection risk.
- Turn the up/down and left/right angulation knobs slowly in each direction until they stop. Repeat this operation several times to confirm that the bending section angulates smoothly and correctly. If the endoscope with an abnormal angulation knob is used, the bending section does not return to its neutral position, causing patient injury.
- If water leaks from the forceps valve or suction valve during the inspection of the suction function, replace the forceps valve with a new reprocessed forceps valve or the suction valve with a reprocessed spare suction valve. A leaking forceps valve or suction valve may cause backflow of body fluid, posing an infection control risk.
- If water leaks from the air/water valve during the inspection of the air/water supply function, replace it with a reprocessed spare one. A leaking air/water valve may cause backflow of body fluid, posing an infection control risk.
- Turn off the light of the processor (light source) before inspecting the objective lens. Viewing the light from the light guide directly may damage your eyes.

CAUTION

- Make sure to inspect the endoscope and accessories before use according to the procedures provided in this manual. Do not use the equipment that shows any signs of abnormality or irregularity. Use of abnormal equipment may cause equipment malfunction.
- Do not forcibly turn the angulation knob further after turning the knob until it stops. If the angulation knob is forcibly turned, it may cause malfunction of the endoscope.
- Make sure that no moisture or foreign matter (such as dust, gauze fibers, metallic fragments) adheres to the scope connector before connecting it to the processor (light source). If the scope connector with moisture or foreign matter (such as dust, gauze fibers, metallic fragments) is connected, it may cause malfunction or failure of the devices.
- Do not attach anything to the power-receiving section. In addition, make sure that no foreign matter such as metallic fragments adheres to the power-receiving section. Adhesion of foreign matter may cause thermal injury, or malfunction or failure of the devices.

CAUTION

- Do not touch the light guide cover glass. A dirty light guide cover glass may result in the reduction of light intensity.
- If abnormalities and/or material changes including but not limited to cracking, flaking, pitting, corrosion, etc. which can create rough surfaces or sharp edges, holes/depressions, compromise sealed surfaces and/or negatively affect device functionality are found, contact your local FUJIFILM dealer.

1.12.2 Handling Precautions

WARNING

- Wear personal protective equipment (such as goggles, facemask, chemical-resistant and waterproof gloves, antifouling protective clothing, cap and shoe covers) during a procedure as well as during reprocessing to protect your eye and skin and to prevent infection. Not doing so may cause infection.
- If you encounter any resistance during a procedure, insert the endoscope slowly. Do not force it in. Do not insert or bend the endoscope without securing the view on the monitor. Not following the recommendations above may cause injury to tissues in the body cavity, bleeding or perforation.
- The forceps valve is intended for single use. Discard it after use. If a deteriorated forceps valve is used, body fluids may leak, causing infection.
- Reprocess the forceps valve before use. Use of an improperly reprocessed forceps valve can create a risk of infection.
- Use a reprocessed forceps valve, air/water valve, suction valve and mouthpiece. Insufficient reprocessing could be a source of infection.
- Ensure that the forceps valve is properly attached to the instrument channel inlet. If this product is used without the forceps valve attached, body fluid may leak and it could be a source of infection.
- The lid of the forceps valve must be closed when using the endoscope. Not doing so may cause leak of body fluids and increase a risk of infection.
- When the lid of the forceps valve needs to be opened during a procedure, place a piece of gauze, etc. over it to prevent leakage. Otherwise, body fluids may leak or splash from the forceps valve, posing an infection control risk to the patient or end-user.
- During an inspection or procedure, use sterile water. If sterile water is not used, it can create a risk of infection.
- Do not quickly release one's finger from the suction valve during aspiration. Doing so may cause a splattering of body fluids from the suction valve and increase a risk of infection.
- Do not supply an excessive amount of air or gas during a procedure. Doing so may cause patient pain, injury to tissues in the body cavity, bleeding, perforation and/or embolism.
- Never use endotherapy devices, operate, insert or withdraw the endoscope, perform bending, air supply, suction or water jet operation, or operate the related equipment while viewing an enlarged endoscopic image on the monitor. Otherwise, injury to tissues in the body cavity, bleeding and/or perforation may result.

WARNING

- Never use endotherapy devices, operate, insert or withdraw the endoscope, or operate the related equipment without viewing or while freezing the endoscopic image on the monitor. Otherwise, injury to tissues in the body cavity, bleeding and/or perforation may result.
- Do not use endotherapy devices, operate, insert or withdraw the endoscope, perform bending, air supply, suction or water jet operation, or operate the related equipment whenever the endoscopic image is compromised, unclear, blurry, etc. due to any reason or condition including loss of image, power interruption, water droplets or dirt/debris adhering to the objective lens, etc. Doing so may cause injury to tissues in the body cavity, bleeding and/or perforation.
- If a patient sneezes or moves abruptly during the procedure, malfunction of the endoscope and patient bleeding or trauma may occur. Depending on the degree of malfunction, safe endoscope withdrawal may be difficult or impossible, causing severe harm to patient and/or end-users.
- Do not perform retroflexed observation forcibly. Performing retroflexed observation in a narrow lumen may make it impossible to straighten the angle of the bending section and/or withdraw the endoscope from the patient.
- When this product is used for a patient with an active implantable medical device such as a pacemaker, consult a cardiovascular specialist and the manufacturer of the active implantable medical device to ensure patient safety. The radio waves radiated from this product may cause medical devices such as a pacemaker to malfunction or break down, seriously affecting patient safety.
- Do not look directly into the light coming from the light guide at the distal end of the endoscope. Viewing the light from the light guide directly may damage your eyes.
- Do not apply excessive force of the endoscope or endotherapy device against mucosal surfaces. Doing so may cause injury to tissues in the body cavity, bleeding and/or perforation.
- Do not bend or insert the endoscope while an endotherapy device protrudes from the distal end. Excessive force of the endotherapy device may be unintentionally applied against mucosal surfaces, causing injury to tissues in the body cavity, bleeding and/or perforation.
- When the endoscope is used for the pharynx or larynx, ensure that any fluid or excised tissue sample does not enter the trachea, as doing so can create breathing difficulty and/or risk of asphyxiation.
- Use the air/water channel cleaning adapter only for pre-cleaning of the air/water channel. If it is used during a procedure, continuous air supply may occur and cause patient injury.
- Do not forcibly advance or withdraw the endoscope into/from the patient, angulate the bending section forcibly or operate it quickly. It may cause patient injury, bleeding or perforation.
- Insert the endoscope while observing the endoscopic image to secure patient safety. Not doing so may cause patient pain, injury, bleeding and/or perforation.

WARNING

- When using special light observation mode, use it after sufficiently understanding the difference between the color tone and brightness of normal light observation mode and those of special light observation mode. Use images displayed in special light observation mode as reference information only. Always use the standard endoscopic image in normal light observation mode when performing a diagnosis. Otherwise, it may cause misdiagnosis.
- The endoscopic image may flicker while switching between normal light observation mode and special light observation mode. Therefore, do not perform any endoscopic operation or treatment while switching between normal light observation mode and special light observation mode. Otherwise, injury to tissues in the body cavity, bleeding and/or perforation may result.
- Do not forcibly turn the angulation knob further after turning the knob until it stops. If the angulation knob is forcibly turned, the angulation mechanism may malfunction and the bending section may not return to its neutral position, making it difficult to withdraw the endoscope.
- If the bending section does not return to its neutral position during a procedure, do not withdraw the endoscope forcibly. Consult your local FUJIFILM dealer. If the endoscope is withdrawn forcibly, injury to tissues in the body cavity, bleeding and/or perforation may result.
- Be extremely careful when performing retroflexed observation in a narrow lumen. Do not perform retroflexed observation forcibly. Otherwise, it may become impossible to straighten the angle of the bending section and/or withdraw the endoscope from the patient.
- Avoid aspirating solid materials or thick fluids. If the suction valve does not return to its original position, stop aspiration immediately and slowly withdraw the endoscope. If any solid materials or thick fluids adhere to or clog the suction valve, suction may not stop, causing damage to mucous membrane.
- When injecting fluids by attaching a syringe to the forceps valve, open the lid of the forceps valve and insert the syringe straight into the forceps valve. Otherwise, the forceps valve may be damaged or the syringe may be accidentally detached during fluid injection and body fluids may leak or splash from the forceps valve, posing an infection control risk to the patient or end-user.
- Do not strongly press the endotherapy device against tissues in the body cavity. Otherwise, injury to tissues in the body cavity, bleeding and/or perforation may result.
- Unless the endoscope's bending section is in a neutral position (essentially "straight"), do not withdraw the endoscope whenever the endoscopic image is compromised, unclear, blurry, etc. due to any reason or condition including loss of image, power interruption, water droplets or dirt/debris adhering to the objective lens, etc. Doing so may cause injury to tissues in the body cavity, bleeding and/or perforation.
- Firmly connect the scope connector of the endoscope and the processor (light source). If the scope connector is not connected properly, the endoscopic image may flicker or be lost, which may cause patient injury, bleeding and/or perforation.
- Never use endotherapy devices, insert or withdraw the endoscope, or perform water jet operation while viewing an image in special light observation mode. Otherwise, injury to tissues in the body cavity, bleeding and/or perforation may result.

CAUTION

- Do not use this product outside the operating environment specified in “Main Specification.” Otherwise, it can cause product malfunction or failure.
- Do not apply unnatural force or impact on the insertion portion, bending section, control portion, LG flexible portion or scope connector. Doing so may cause malfunction of the endoscope.
- When holding the endoscope, hold it by the control portion. Handling it up by the insertion portion or LG flexible portion is difficult to hold and may exert an unnatural force, resulting in instrument failure.
- During an observation, do not perform close observation for an extended period of time. Use the endoscope with a minimum necessary amount of brightness and time while maintaining an appropriate distance. Thermal energy created by illumination may cause burn injury.
- Immediately after detaching the scope connector from the processor (light source), do not touch the light guide prong with hands since it may be extremely hot. There is a risk of burn injury.
- If the brightness level of the processor (light source) is high, the surface temperature at and around the distal end of the endoscope may exceed 41°C. Do not allow the distal end to remain in contact with the same site for an extended period of time. It may cause burn injury.
- Do not use a mouthpiece that is damaged, deformed, or reveals other irregularities. Doing so may cause injury in the oral cavity and/or equipment failure.
- When observing the oral cavity, shield this product from extraneous light as far as possible by darkening the room, etc. Otherwise, a clear endoscopic image may not be obtained.
- Do not directly apply Xylocaine spray to the insertion portion. Do not use olive oil as a lubricant for insertion. It may cause deterioration of the outer surface.
- Avoid forcible or excessive angulation as this may impose a severely heavy load on the wire controlling the bending section. This may cause stretching or tearing of the wire.
- The lid of the forceps valve must be closed when using the endoscope. Not doing so can reduce the efficacy of the endoscope’s suction system, making it impossible to perform aspiration.
- When inserting an endotherapy device, close the lid of the forceps valve. If the lid is open, it can reduce the efficacy of the endoscope’s suction system, making it impossible to perform aspiration.
- When attaching the suction valve to the suction valve cylinder of the endoscope, align the recessed and projecting portions and slowly insert the suction valve straight into the suction valve cylinder of the endoscope. If the suction valve is attached forcibly, it may be damaged.
- Do not use any lubricants to the air/water valve. It may impair the functionality of the valve or may clog the channel, diminishing functionality of air/water supply.
- Slowly insert the air/water valve straight into the air/water valve cylinder of the endoscope. If the air/water valve is attached forcibly, it may be damaged.

CAUTION

- Firmly connect the scope connector of the endoscope and the processor (light source). Do not look into the connecting part between the endoscope and the processor (light source). Light leaking from the connecting part may cause damage to the eyes.
- If you encounter any resistance during a procedure, insert the endoscope slowly. Do not force it in. Do not insert or bend the endoscope without securing the view on the monitor. Not following the recommendations above may cause endoscope failure or patient injury.
- When the shutter speed is set to "HIGH", take care not to set the brightness level too high. Thermal energy created by illumination may cause burn injury.
- Do not push the boot of the control portion against the bed, etc. during a procedure. Doing so may cause endoscope failure.

1.12.3 Abnormalities during Use of This Product**WARNING**

- If any abnormality occurs during use, carry out safety checks such as checking the patient's condition and discontinue use immediately. Not doing so may seriously affect patient safety.
- If an abnormality occurs during a treatment, stop the treatment immediately and slowly pull out the endotherapy device from the endoscope. If the endotherapy device cannot be pulled out from the endoscope, withdraw the tip of the endotherapy device to the instrument channel outlet of the endoscope, and then slowly pull out the endoscope and endotherapy device together. If the treatment is not stopped or the endotherapy device is forcibly pulled out, it may cause injury to tissues in the patient's body cavity, bleeding and/or perforation.
- During a procedure, if any abnormality (loss of image, dark image, bright image, etc.) is found in the endoscopic image, the imaging section may have malfunctioned. If this happens, stop the treatment immediately and slowly pull out the endoscope. If the endoscope is used as it is, it may cause overheating of the distal end, possibly resulting in mucosal burns or other injury.
- If it is necessary to supply air or water from the suction connector when an abnormality is found in the suction valve during a procedure, do so while pressing the suction valve. If air or water is supplied without pressing the suction valve, body fluids may leak or splash from the suction valve, posing an infection control risk.

Note

- If any abnormality occurs with this product, refer to "Chapter 6 Troubleshooting."
Should any safety concerns arise with this product, contact your local FUJIFILM dealer.

1.12.4 Precautions for Water Jet Function

This section is applicable only to the endoscopes with the water jet function.

→ “Table 3.1 Function of each model and applicable workflow”

WARNING

- Depending upon the specific brand, type or model of irrigation pump and related irrigation components/accessories, individual components may be sterile or may need to be reprocessed before clinical use. Prior to use of any irrigation pump, tubing and components, follow all manufacturers' instructions for preparation and use including the need to reprocess each item before a procedure. Use of improperly reprocessed or non-sterile irrigation system components could pose a risk of infection.
- Confirm that all components of the water pump (irrigation source) have been reprocessed or are sterile, single patient use items. The components of the FUJIFILM water pump (irrigation source) have not been reprocessed. Before using irrigation components for a procedure for the first time, reprocess them as per the instructions described in the manual of the water pump. Use of an improperly reprocessed water pump can be a source of infection.
- Avoid direct contact of the mucosal surface with the distal end of endoscope while washing the target site using the water jet function. Not doing so may cause damage to the mucous membrane.
- Regardless of irrigation or water source, the FUJIFILM J tube (JT-500) must be used with the water jet channel. If the specified J tube is not used, body fluids may leak, posing infection risks to patients and/or end-users.
- When using a J tube, ensure that it has been properly reprocessed. Use of an improperly reprocessed J tube could be a source of infection.
- Inspect the reusable components of the water pump. If any abnormal part is found, replace it with a new one. If any abnormal component is used, it could be a source of infection.
- After the water pump is used in a procedure, reprocess it for each case according to the instructions of the operation manual of the water pump. Use of improperly reprocessed water pump could be a source of infection.
- When an endoscope is used but the water jet function is not used, close the water jet inlet cap to block the water jet inlet. If the endoscope is used with the water jet inlet cap left open, it may cause leak of body fluids, posing infection risks to patients and/or end-users.
- Use a sterile syringe or reprocessed water pump and irrigation components for supplying water to the water jet nozzle. Use of a non-sterile or inadequately reprocessed device may pose an infection risk.
- Never perform water jet operation while viewing an image in special light observation mode. Otherwise, injury to tissues in the body cavity, bleeding and/or perforation may result.

CAUTION

- Do not detach the J tube until the endoscope is transported to the location where reprocessing is performed after a procedure. Otherwise, fluid may drip from the water jet channel and it may come into contact with related equipment, causing equipment failure.

CAUTION

- When an endoscope is used but the water jet function is not used, close the water jet inlet cap to block the water jet inlet. If the water jet inlet cap is open, it can reduce the effectiveness of the endoscope's suction system and/or allow insufflated air to escape from an unsealed pathway.
- When using the water jet function, be sure to use the FUJIFILM J tube model JT-500 regardless of irrigation or water source. If the specified J tube is not used, water may leak from the water jet channel and it may come into contact with related equipment, causing a failure of related equipment.
- When connecting the J tube to the endoscope, do not overtighten the endoscope side connector of the J tube. Doing so may damage the connector of the J tube or make it impossible to detach.
- When connecting the J tube to the endoscope and/or other components, do not overtighten the connector of the J tube. Doing so may damage the connector of the J tube or that of the endoscope.

1.13 Precautions for Equipment Used in Combination

Use this product in combination with related equipment described in this manual.

→ “Appendix - Related Equipment Used in Combination”

Using related equipment not described in this manual can result in not only abnormal operations but also equipment damage and/or patient or end-user injury.

For details, see “Electromagnetic Compatibility (EMC) Information” in Appendix.

→ “Appendix - Electromagnetic Compatibility (EMC) Information”

WARNING

- Use this product only in combination with related equipment described in this manual. Otherwise, it is unable to ensure its functionality, and may cause severe harm to patient or end-users.
- Set the suction pressure between 40 and 53 kPa. If the suction pressure is too high, patient debris or fluids may leak or splash from the forceps valve, posing infection control risks to patient or operator.
- Keep the endoscope away from the contactless power feeding device that cannot be used in combination. If the power is supplied unintentionally, laser light emitted from the endoscope may cause severe harm to patient or end-users.
- When the hood is used, wear protective clothing when detaching the hood from the distal end of the endoscope. Otherwise, it may pose an infection risk.
- Firmly connect the suction tube from the suction unit to the suction connector on the scope connector. If the suction tube is not attached properly, body fluid may drip from the tube and can pose an infection control risk.

CAUTION

- Turn off the light of the processor (light source) except during an inspection, procedure, etc., when necessary. If the light of the processor (light source) is left on, the distal end of the endoscope and its surroundings may become hot, causing burn injury to the patient or end-user.
- If the endoscope is used in combination with the processor VP-7000 and the light source BL-7000, when turning off VP-7000, also turn off BL-7000. If the light source remains on after turning off the processor, the ALC (automatic light control) does not function and the maximum amount of light is emitted. As a result, the distal end of the endoscope and its surroundings may become hot, causing burn injury to the patient or end-user.
- Use this product only in combination with related equipment described in this manual. Otherwise, it creates a risk of equipment malfunction.
- Use the endoscopic CO₂ regulator described in this manual. If another insufflation device is connected, the air/water supply function lessens and may result in improper cleaning of the lens.
- Set the suction pressure between 40 and 53 kPa. If the suction pressure is too high, the endoscope may adhere to mucous membrane, resulting in damage to the mucous membrane.

CAUTION

- Secure the distal hood using medical grade tape with no twist or peeling. Do not press the hood against the digestive tract wall with undue force. It may damage mucous membrane.
- Fix the hood securely to the endoscope before use. Otherwise, the hood may fall off during a patient procedure.
- Do not grasp the bending section forcefully when attaching or detaching the hood. It may cause malfunction of the endoscope.
- Do not subject the scope connector to strong impact. Install the processor (light source) away from obstacles to prevent the scope connector connected to the processor (light source) from accidental impact damage. During the operation of an electric bed, etc., ensure that the scope connector connected to the processor (light source) does not hit the bed. Otherwise, the scope connector of the endoscope and the processor (light source) may malfunction.
- With regard to the amount of sterile water in the water tank, follow the instructions provided in the operation manual of the water tank. If the amount of sterile water in the water tank exceeds the limit, the air/water supply function may be disabled or it may cause equipment failure due to contact with leaked sterile water.
- Attach the water tank to the specified position of the cart or processor (light source). Otherwise, fluid may leak from the connector of the water tank and it may come into contact with related equipment, causing equipment failure.
- Firmly connect the suction tube from the suction unit to the suction connector on the scope connector. If the suction tube is not attached properly, body fluid may drip from the tube and come into contact with related equipment, causing equipment failure.

Note

- For details on how to use related equipment, refer to the operation manual of related equipment.
- Before using this product, thoroughly read the operation manual of related equipment used in combination with this product.

1.13.1 Precautions for High-Frequency Treatment

WARNING

- Set the minimum required output power of the electrosurgical unit and high-frequency endotherapy device within the specified output range as per instructions provided in the operation manual of the electrosurgical unit and high-frequency endotherapy device. If the output power is inappropriate, it may cause injury to tissues in the body cavity, thermal injury, bleeding or perforation.
- If the intestines contain a flammable gas, replace it with air or a non-flammable gas such as air or CO₂ before performing high-frequency treatment. Performing high-frequency treatment while the intestines are filled with a flammable gas could result in an explosion and/or fire.
- Wear chemical-resistant and waterproof gloves when performing high-frequency treatment. If not worn, there is a risk of thermal injury or electric shock.
- Always keep pacemaker users away from the electrosurgical unit. The pacemaker may malfunction.
- When performing high-frequency treatment, maintain enough distance between the distal end of endoscope and the tip of the electrosurgical unit. Energize the electrosurgical unit after bringing the tip of the endotherapy device into the field of view. When the high-frequency endotherapy device or energizing part makes contact with the distal end of the endoscope, do not energize the electrosurgical unit. When performing high-frequency treatment, suck mucus adhering to the tissues in the body cavity first and then energize the electrosurgical unit. If the unit is energized when the endotherapy device in contact with the distal end of the endoscope or mucus, it may cause thermal injury.
- Before performing high-frequency treatment, basic in vitro experiments must be performed sufficiently by the user to acquire the skills necessary for high-frequency treatment.
- In the case of high-frequency treatment on the larynx, ensure that the endoscope or endotherapy device does not make contact with the vocal cords. There is a risk of damaging the vocal cords.
- Use an electrosurgical unit conforming to EN 60601-2-2 (IEC 60601-2-2). If any other electrosurgical unit is used, it may cause severe harm to patient and/or end-users.
- Use the electrosurgical unit and related endotherapy devices per instructions provided in the operation manual for each respective device. Otherwise, device failure, electric shock and/or burns may occur.
- This product is not intended for use with the laser cauterization system. Do not use this product in combination with the laser cauterization system.

CAUTION

- Prevent patient's body from touching electric conductor such as metal part of bed while performing high-frequency treatment. It could cause thermal injury to a patient due to energization via the conductive part.
- When performing high-frequency treatment, take care that patient's vomitus or body fluids do not make contact with the conductive parts such as a metal part of the bed. It could cause thermal injury to a patient due to energization via vomitus or body fluids.

CAUTION

- While performing high-frequency treatment, ensure that the end-user does not touch the patient. It could cause thermal injury to a patient and/or end-user.
- Operate the electrosurgical unit within specified output range as per instructions provided in the operation manual of the electrosurgical unit. Leakage current may cause thermal injury.
- Do not energize the electrosurgical unit when the high-frequency endotherapy device or electrically active portion is in contact with the distal end of endoscope. Thermal injury to a patient or endoscope failure may occur.
- Do not apply the current under the circumstance that patient's clothing is wet when performing high-frequency treatment. Doing so may cause thermal injury.

1.13.2 Precautions for Endotherapy Device and Syringe**WARNING**

- When inserting an endotherapy device into the endoscope, or when injecting fluids by attaching a syringe to the instrument channel inlet, slowly insert the endotherapy device or syringe straight into the endoscope. Also, when withdrawing it, slowly pull straight out. If an endotherapy device or syringe is inserted or withdrawn quickly, or if it is inserted or withdrawn obliquely against the forceps valve, the forceps valve may be damaged or accidentally detached, or a clearance may be generated between the lid and the main body of the forceps valve. As a result, body fluid may be splattered around leading to infection to the patient or end-user.
- Do not perform a procedure with an endotherapy device hung over the forceps valve. Doing so may cause leakage of body fluids and increase a risk of infection.
- Use sterile or reprocessed endotherapy devices. Non-sterile or inadequately reprocessed endotherapy devices may pose an infection risk.

CAUTION

- If resistance is encountered while advancing an endotherapy device within the instrument channel, do not forcibly advance the endotherapy device. Otherwise, it may cause malfunction of the endoscope.

1.14 Main Adverse Events

The following adverse events may occur while using this product: cardio-respiratory arrest, asphyxia, infection, electric shock, misdiagnoses, impossibility of removing, transferring to laparotomy, injury, thermal burn, eye damage, inflammation, tissue injury, perforation, uncollectible/residue in the body, chemical injury, interruption of examination and extension of examination time.

This chapter describes details on the accessories supplied with this product, the nomenclature and functions of the endoscope, and related equipment connected to this product.

2.1 Checking Package Contents

Check the endoscope and other components in the package against the items shown in the figures below. Inspect the endoscope and each component for damage. If the endoscope or a component is damaged, or if a component is missing, contact your local FUJIFILM dealer.

2.1.1 Endoscope

Note

- Figures in parentheses indicate the number of articles.

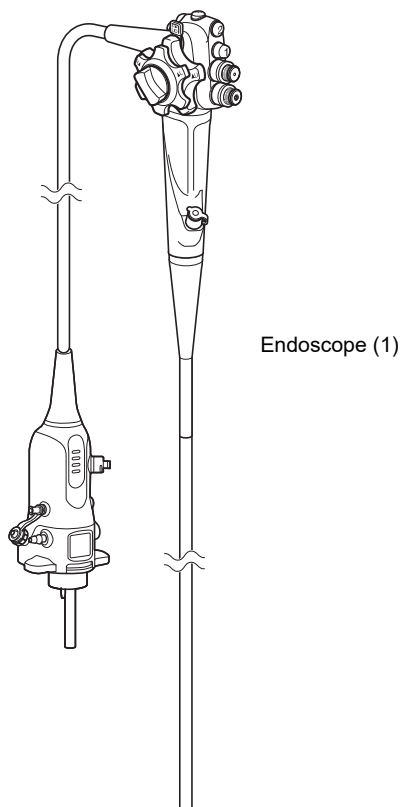







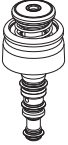

2.1.2 Accessories

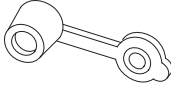
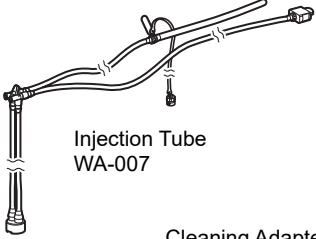
Note

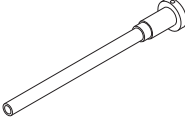
- Figures in parentheses indicate the number of articles.

◆ Accessories Common to All Models

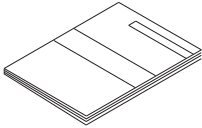
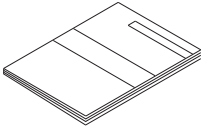
 <p>Suction Valve SB-605 (1)</p>	 <p>Air/Water Valve AW-603 (1)</p>	 <p>Air/Water Channel Cleaning Adapter CA-611 (1)</p>	 <p>Forceps Valve FOV-DV7 (10)</p>
 <p>Injection Tube WA-007</p>	 <p>Cylinder Adapter WA-010</p>	 <p>Ventilation Adapter AD-7 (1)</p>	 <p>Cylinder/Inlet Brush WB11003FW (1)</p>
 <p>Suction Channel Brush WB7024FW (1)</p>	 <p>Cleaning Adapter CA-610 (1)</p>	 <p>Operation Manual (1)</p>	 <p>Reprocessing Manual (1)</p>

◆ Accessories for Endoscopes with Specific Functions

<Accessories for Endoscopes with Water Jet Function>

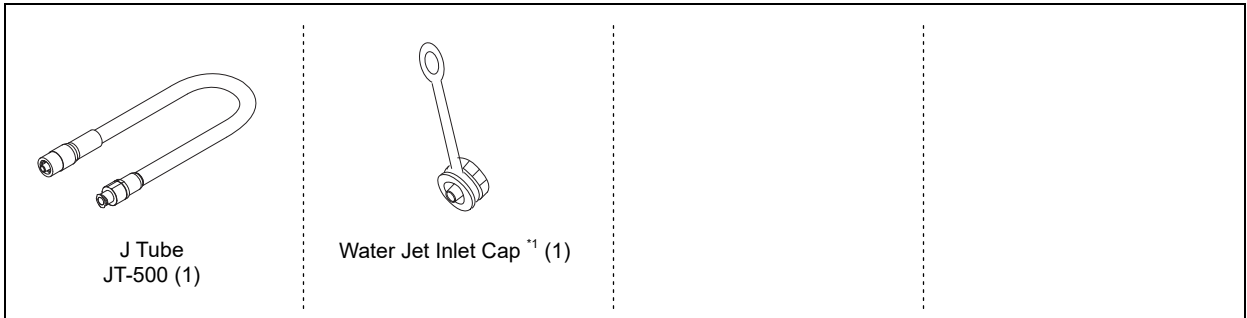

*1 This accessory is attached to the endoscope at the time of shipment.

<Carrying Case>

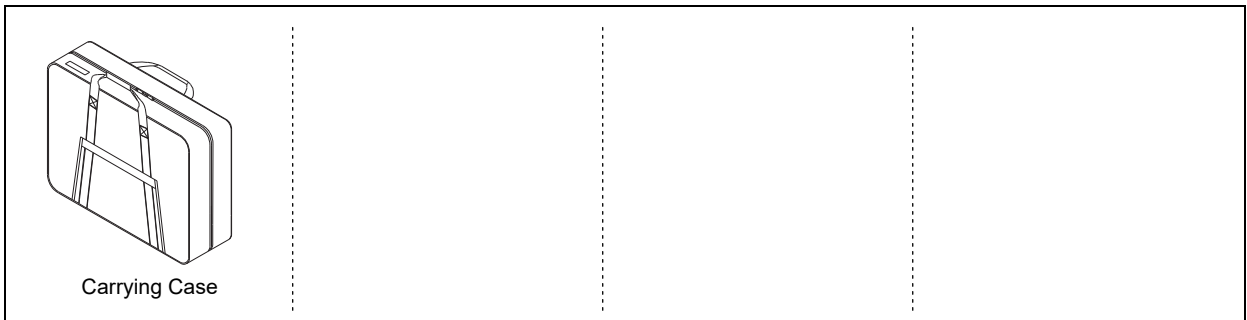

2.2 Nomenclature and Functions of Endoscope

This product consists of the following parts.

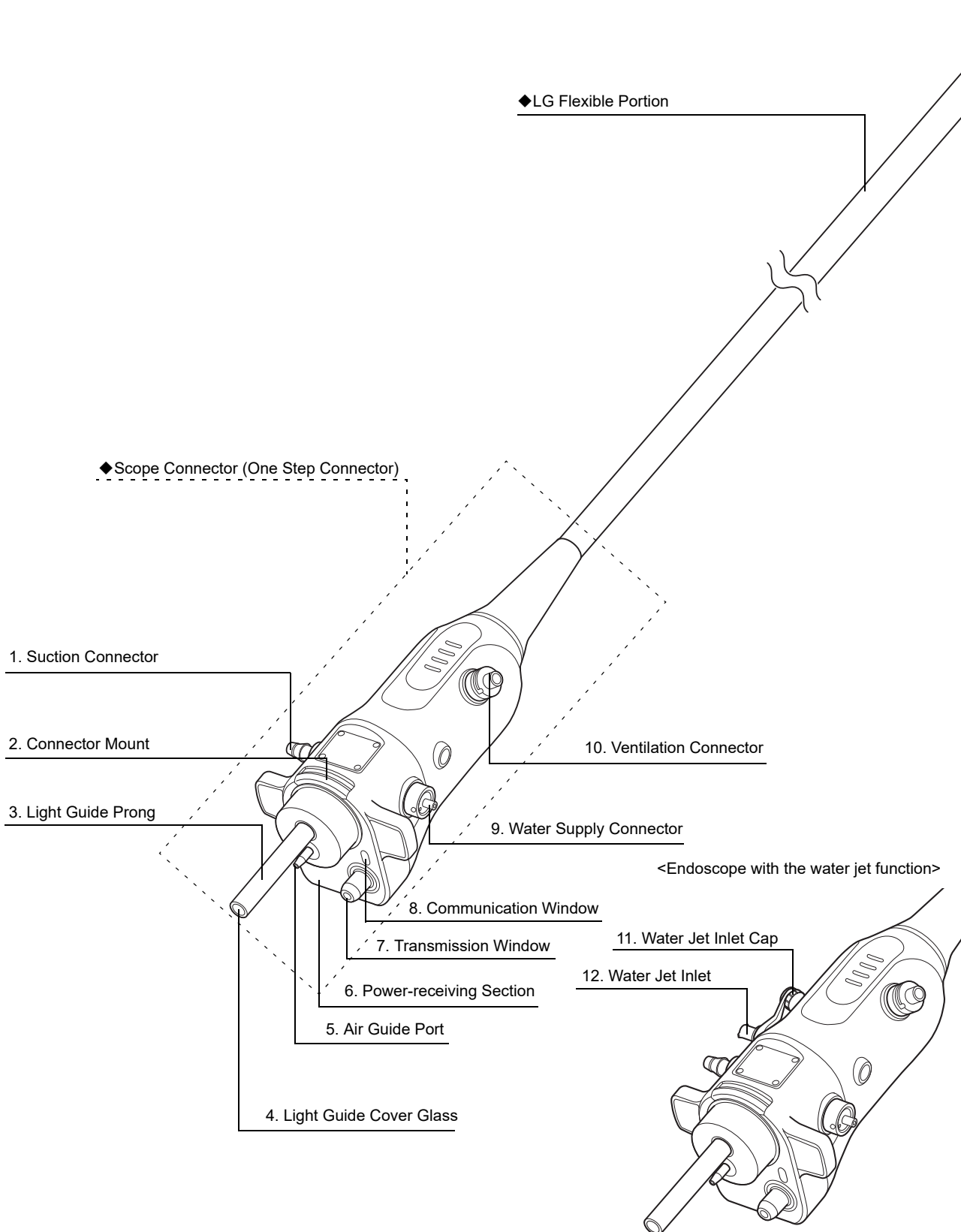

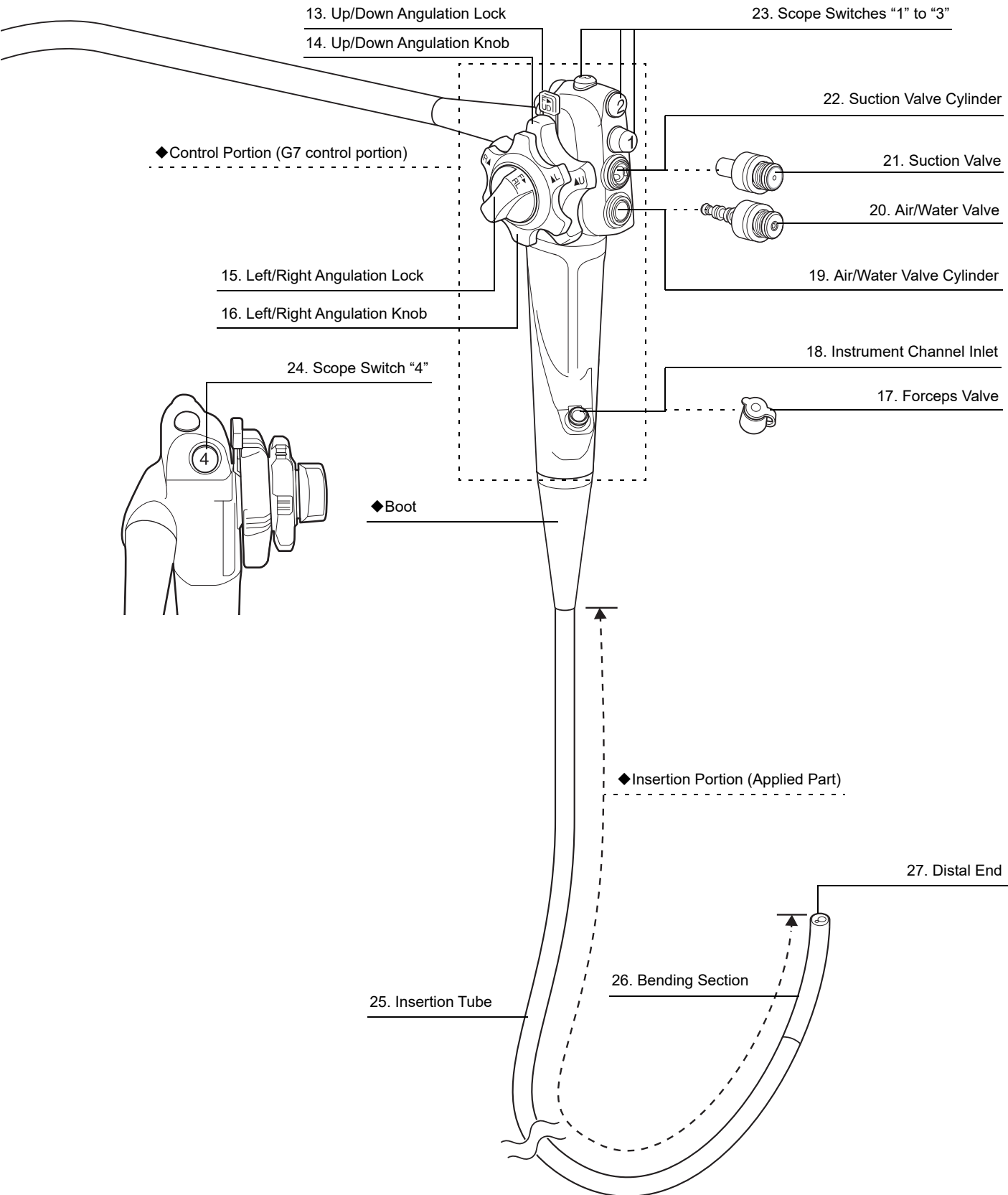

◆ Scope Connector (One Step Connector)

The scope connector is connected to the processor (light source).

No.	Name	Function
1	Suction Connector	Accepts the tube from the suction unit.
2	Connector Mount	Secures the connection of the scope connector to the processor (light source).
3	Light Guide Prong	Transmits the light from the processor (light source) to the distal end.
4	Light Guide Cover Glass	
5	Air Guide Port	Supplies air from the pump of the processor (light source) to the endoscope.
6	Power-receiving Section	Receives power from the processor (light source).
7	Transmission Window	Transmits data to the processor (light source).
8	Communication Window	Exchanges information between the endoscope and the processor (light source).
9	Water Supply Connector	Connects to the water tank.
10	Ventilation Connector	Connects to the air leak tester or ventilation adapter.
11	Water Jet Inlet Cap	Only the endoscope with the water jet function is equipped with this mechanism to block the water jet inlet while the water jet inlet is not used.
12	Water Jet Inlet	Only the endoscope with the water jet function is equipped with this mechanism. A syringe or water pump is connected to this inlet to supply sterile water to the water jet nozzle at the distal end. When the water jet function is used, the J tube is connected. → "4.4.4 J Tube"

◆ LG Flexible Portion

The LG flexible portion connects the scope connector and the control portion. This portion contains various internal channels, electrical wires and light guide.

◆ Control Portion (G7 control portion)

The control portion is used for operating each function of the endoscope. Hold this portion during a procedure.

No.	Name	Function
13	Up/Down Angulation Lock	Maintains the up/down angle of the bending section. Moving this lock in the direction of F (Free) unlocks the up/down movement of the bending section, allowing external force to angulate the bending section freely. Moving this lock in the direction opposite to F locks the up/down movement and maintains the up/down angle of the bending section.

No.	Name	Function
14	Up/Down Angulation Knob	Angulates the bending section upward or downward. Turning this knob in the direction of U angulates the bending section upward. Turning this knob in the direction of D angulates the bending section downward.
15	Left/Right Angulation Lock	Maintains the right/left angle of the bending section. Moving this lock in the direction of F (Free) unlocks the left/right movement of the bending section, allowing external force to angulate the bending section freely. Moving this lock in the direction opposite to F locks the right/left movement and maintains the right/left angle of the bending section.
16	Left/Right Angulation Knob	Angulates the bending section to the right or left. Turning this knob in the direction of L angulates the bending section to the left. Turning this knob in the direction of R angulates the bending section to the right.
17	Forceps Valve	One of the accessories for the endoscope. This valve is attached to the instrument channel inlet to prevent leak or backflow of air and/or fluids. In addition, an endotherapy device is inserted into or a syringe is attached to this valve.
18	Instrument Channel Inlet	Each endotherapy device is inserted from this inlet. An endotherapy device or fluid injected with a syringe passes through the instrument channel and comes out of the instrument channel outlet in the distal end of endoscope.
19	Air/Water Valve Cylinder	The air/water valve is attached to this cylinder.
20	Air/Water Valve	One of the accessories for the endoscope. Pressing this valve supplies water and covering the hole in this valve with one's finger supplies air to the air/water nozzle in the distal end of the endoscope.
21	Suction Valve	One of the accessories for the endoscope. When this valve is pressed, suction is performed from the instrument channel outlet at the distal end through the instrument channel.
22	Suction Valve Cylinder	The suction valve is attached to this cylinder.
23 24	Scope Switches "1" to "4"	Functions of the processor are assigned to these switches. Use the processor to assign functions to these switches. → Operation Manual of the processor

◆ Boot

This portion connects the control portion and the insertion portion.

◆ Insertion Portion (Applied Part)

The insertion portion contains various components of the angulation system, internal channels, optical and illumination systems. The endoscope can be inserted into the body cavity up to the boot.

No.	Name	Function
25	Insertion Tube	Connects the bending section and the control portion. The index showing the distance from the distal end (Insertion Scale mark) is printed.
26	Bending Section	This section is bendable in any of the up, down, left and right directions by operating the up/down and left/right angulation knobs on the control portion. The distal end can be directed in any direction by moving this section.
27	Distal End	Contains the objective lens, light guide, air/water nozzle, instrument channel outlet, etc. The shape and function vary depending on the model. → "2.3 Nomenclature and Functions of Distal End of Endoscope"

2.3 Nomenclature and Functions of Distal End of Endoscope

<EG-720R>

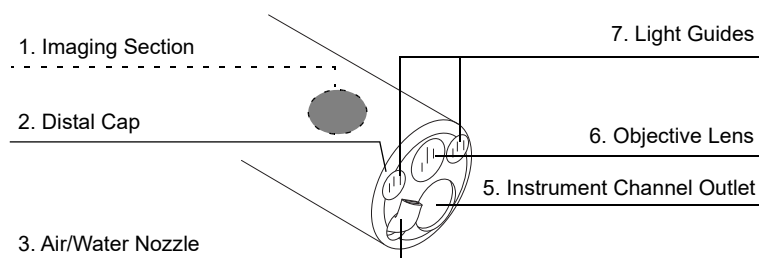

<Direction of Forceps>

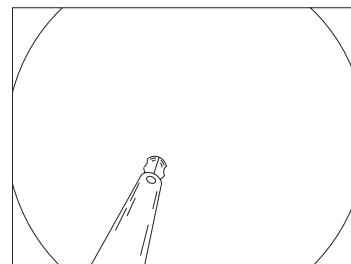

<EC-720R/M, EC-720R/I, EC-720R/L>

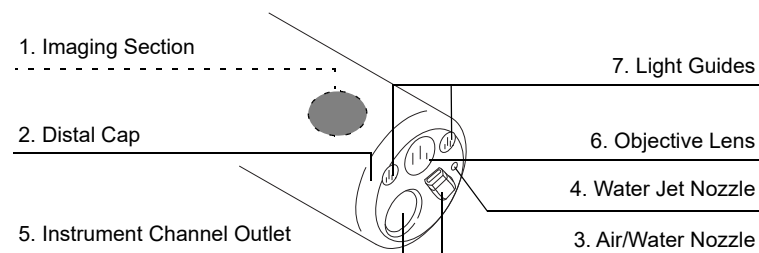

<Direction of Forceps>

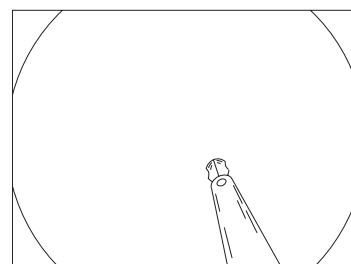

No.	Name	Function
1	Imaging Section	This section receives an image focused on its surface by the distal objective lens. This sensor is actually located within the distal portion of the endoscope in the illustrated position.
2	Distal Cap	This cap fixes the parts to the distal end of endoscope.
3	Air/Water Nozzle	This nozzle directs air or water onto the objective lens with the air/water valve operation.
4	Water Jet Nozzle	This mechanism is only for the endoscope with the water jet function. This nozzle delivers a forward stream of water when water is injected through the water jet inlet.
5	Instrument Channel Outlet	Endotherapy devices exit from this opening when inserted from the instrument channel inlet. During operation of the suction valve, this opening serves as an entrance for suctioning of fluids into the instrument/suction channel.
6	Objective Lens	This lens focuses an image onto the imaging section which in turn is displayed on the monitor.
7	Light Guides	The light from the light guide cover glass is emitted from these windows.

2.4 Location of Each Label

The positions where the labels are affixed on this product are shown below.

2.4.1 Location of Labels

<Control Portion>

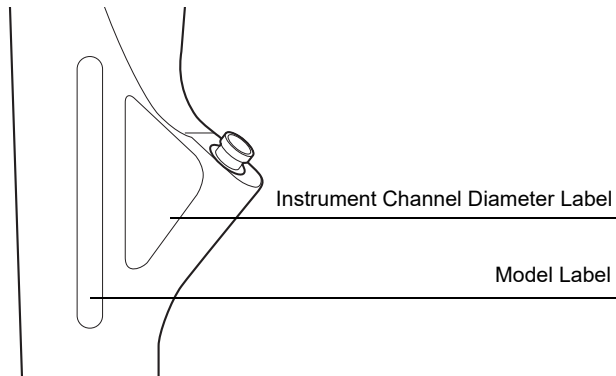

<Scope Connector>

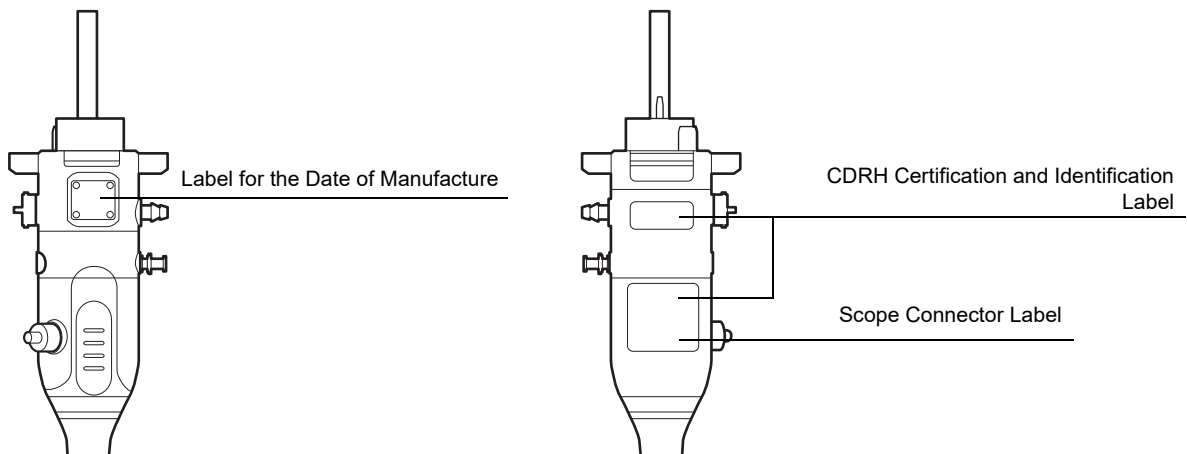

2.5 System Configuration

This product is used in combination with related equipment. The recommended combination of related equipment that can be used with this product is listed below. Related equipment is optional.

WARNING

- Use this product only in combination with related equipment described in this manual. Otherwise, it is unable to ensure its functionality, and may cause severe harm to patient or end-users.

CAUTION

- Use this product only in combination with related equipment described in this manual. Otherwise, it creates a risk of equipment malfunction.

2.5.1 System Configuration (Combination with EP-6000)

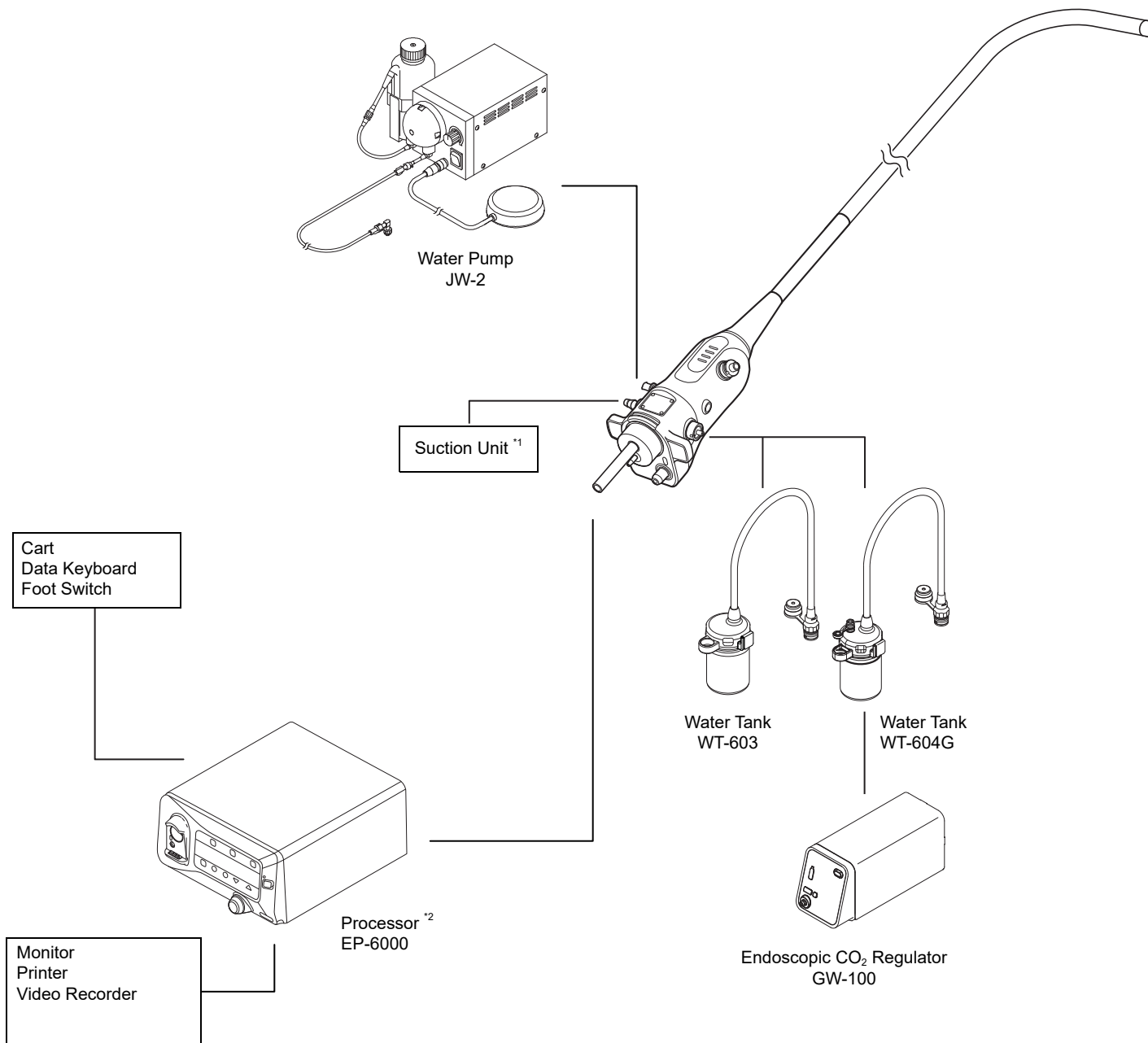

*1 Use a suction unit which complies with EN 60601-1 (IEC 60601-1) and can set suction pressure to 40 to 53 kPa.

*2 The system version must be V1.7 or later.

Note

- In addition to the related equipment described here, products that can be used in combination with this product may be added. In addition, the related equipment described here may have already been discontinued or not marketed depending on the country or region. For details on the devices used in combination with this product, contact your local FUJIFILM dealer.

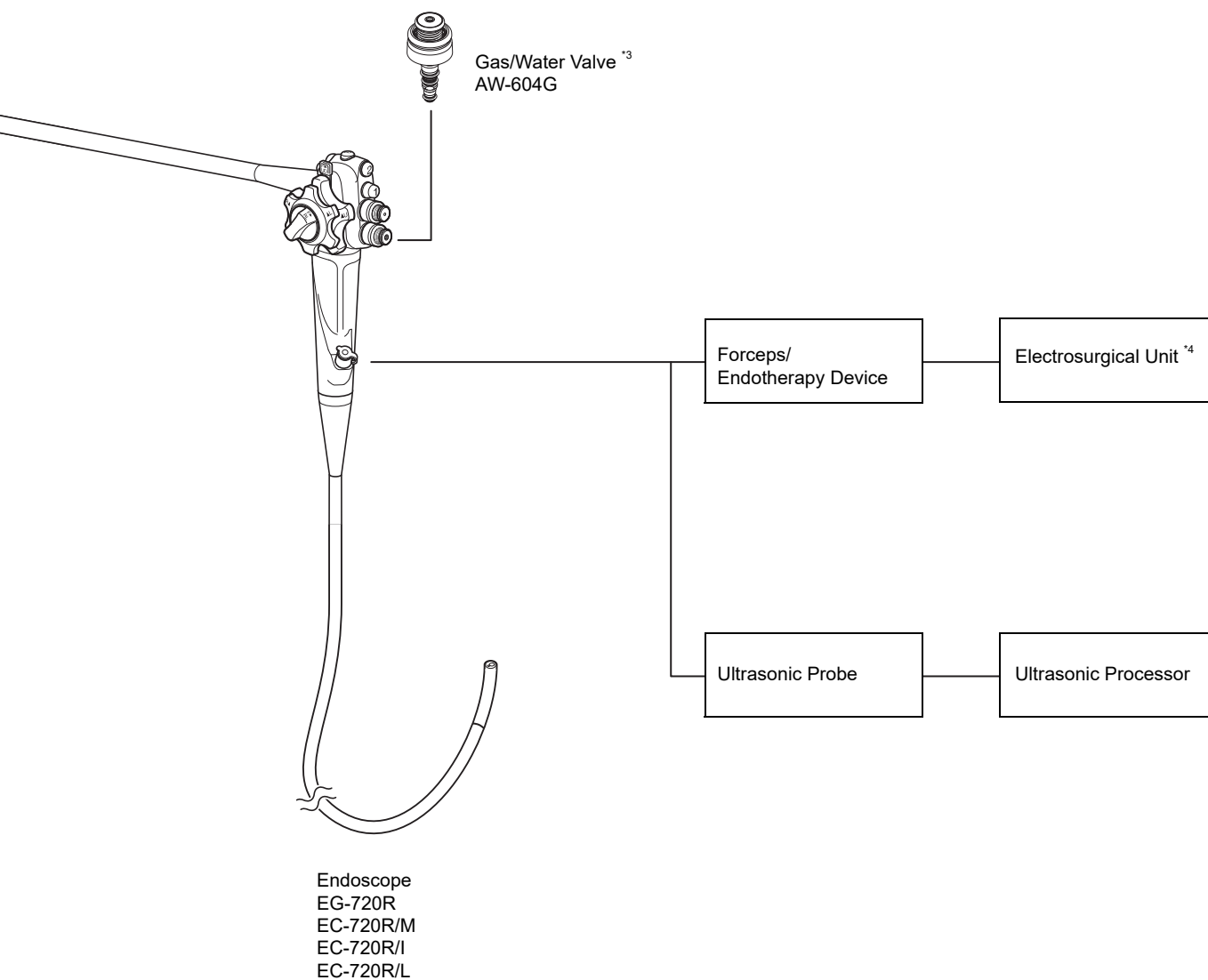

*3 Used in combination with the endoscopic CO₂ regulator GW-100.

*4 For details, refer to the manual of the electrosurgical unit.

2.5.2 System Configuration (Combination with VP-7000 and BL-7000)

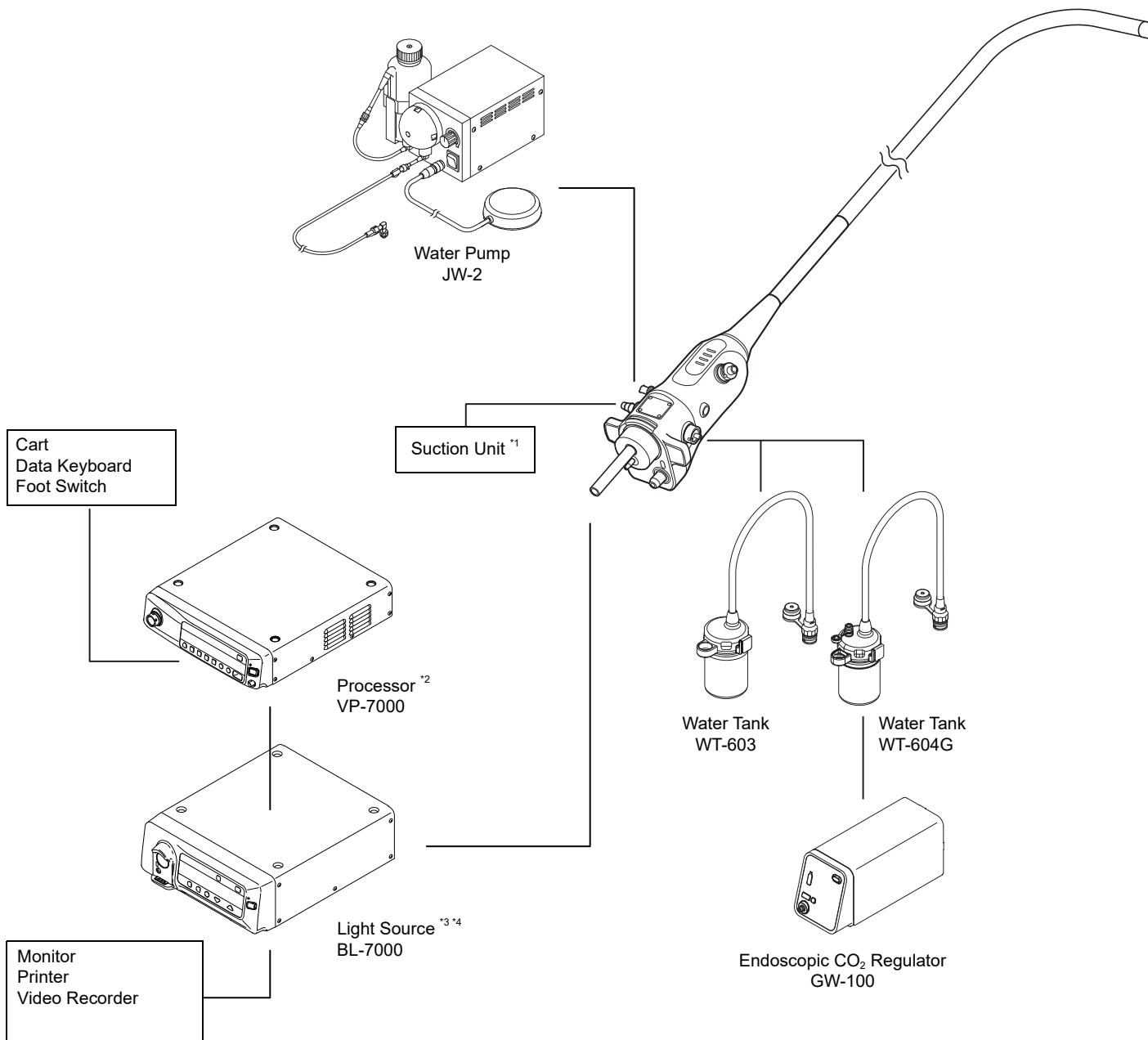

- *1 Use a suction unit which complies with EN 60601-1 (IEC 60601-1) and can set suction pressure to 40 to 53 kPa.
- *2 The system version must be Ver.1.022 or later.
- *3 The software version must be Ver.1.16 or later.
- *4 The VP-7000 can only be used in combination with the BL-7000, and the BL-7000 with the VP-7000.

Note

- In addition to the related equipment described here, products that can be used in combination with this product may be added. In addition, the related equipment described here may have already been discontinued or not marketed depending on the country or region. For details on the devices used in combination with this product, contact your local FUJIFILM dealer.

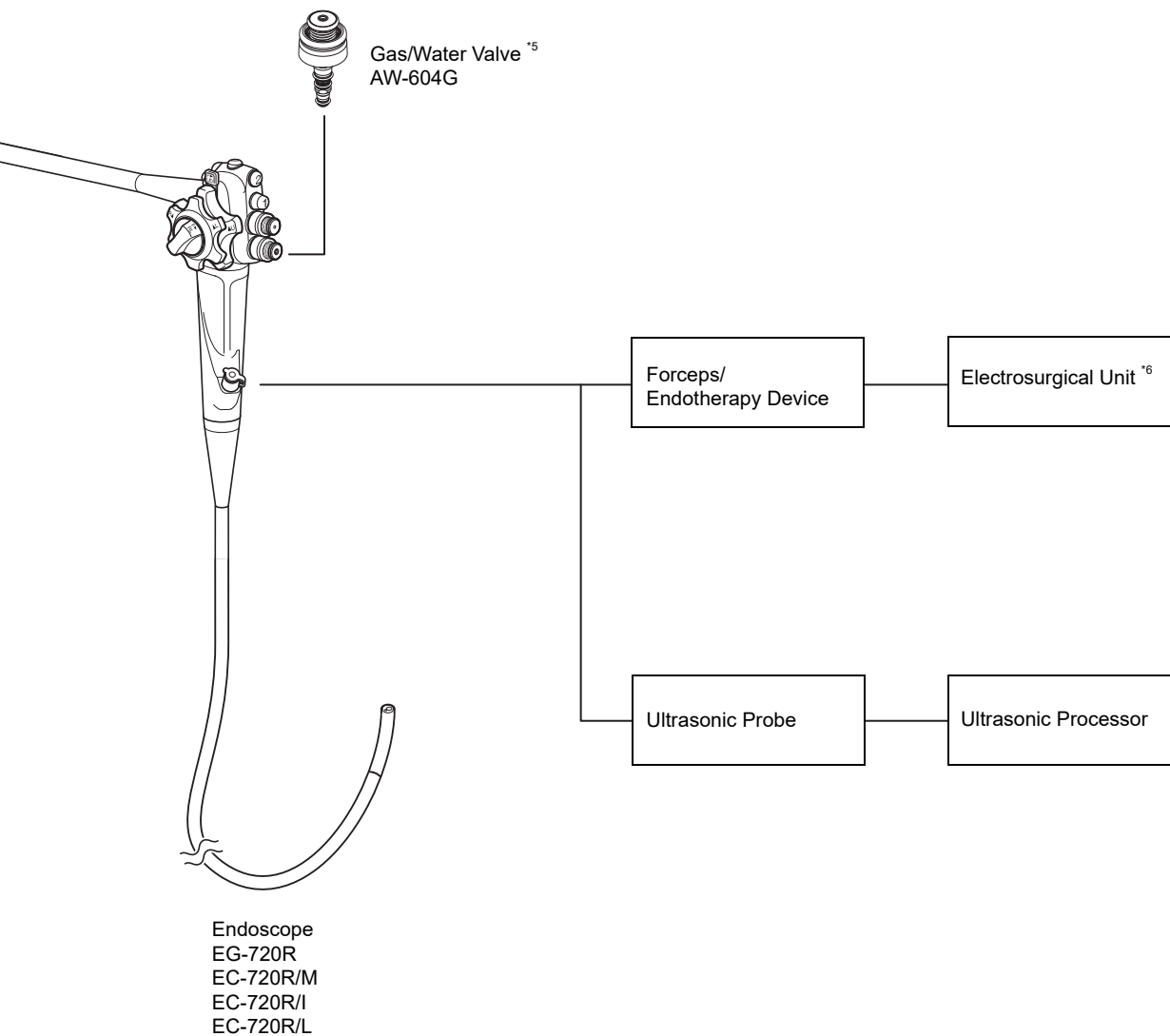

*5 Used in combination with the endoscopic CO₂ regulator GW-100.

*6 For details, refer to the manual of the electrosurgical unit.

This chapter describes the workflow of endoscopy, which differs depending on the type of endoscope and accessories to be used.

The workflow of endoscopy differs depending on the available functions of the endoscope or the functions to be used.

Confirm the workflow applicable to the endoscope to be used by referring to “Table 3.1 Function of each model and applicable workflow.” Have an understanding about the workflow and read the relevant sections thoroughly before use.

Table 3.1 Function of each model and applicable workflow

Model	Function	Applicable Workflow
	Water Jet	
EG-720R	-	“3.1 When Using Standard Functions”
EC-720R/M EC-720R/I EC-720R/L	○	“3.2 When Using Water Jet Function”

3.1 When Using Standard Functions

Inspecting Endoscope	Inspecting and Attaching Accessories	Connecting Related Equipment	Inspecting Each Function
4.3.1 Inspecting Control Portion	4.4.1 Forceps Valve	4.5 Preparing Related Equipment	4.7.1 Inspecting Endoscopic Images
4.3.2 Inspecting Insertion Portion	4.4.2 Suction Valve	4.6.1 Connecting to Processor (Light Source)	4.7.2 Inspecting Scope Switch
4.3.3 Inspecting Distal End	4.4.3 Air/Water Valve	4.6.2 Attaching Water Tank	4.7.3 Inspecting Air/Water Supply Function
4.3.4 Inspecting Bending Section		4.6.3 Attaching Suction Unit	4.7.4 Inspecting Suction Function
4.3.5 Inspecting Scope Connector			4.7.5 Inspecting Instrument Channel

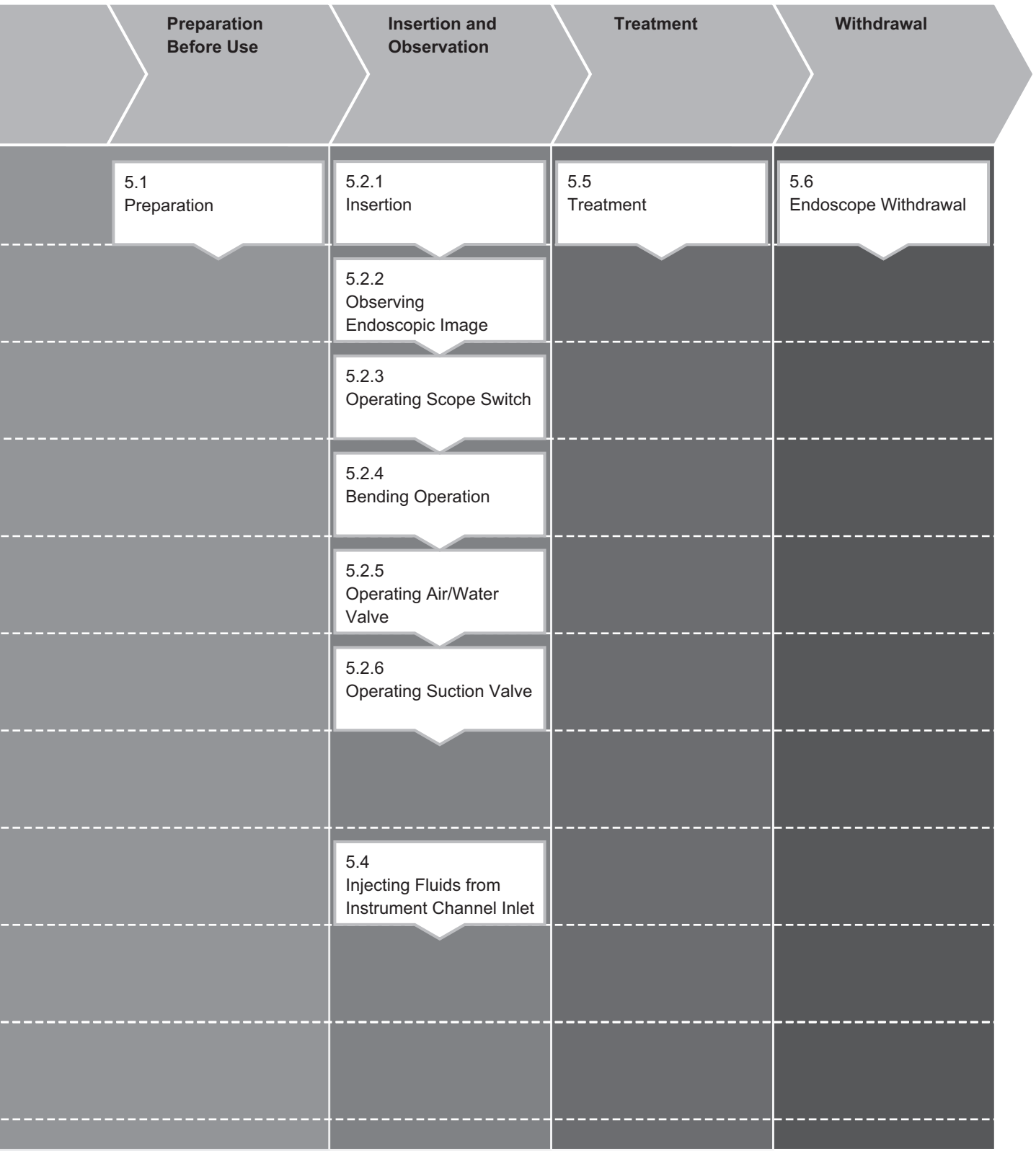

3.2 When Using Water Jet Function

Inspecting Endoscope	Inspecting and Attaching Accessories	Connecting Related Equipment	Inspecting Each Function
4.3.1 Inspecting Control Portion	4.4.1 Forceps Valve	4.5 Preparing Related Equipment	4.7.1 Inspecting Endoscopic Images
4.3.2 Inspecting Insertion Portion	4.4.2 Suction Valve	4.6.1 Connecting to Processor (Light Source)	4.7.2 Inspecting Scope Switch
4.3.3 Inspecting Distal End	4.4.3 Air/Water Valve	4.6.2 Attaching Water Tank	4.7.3 Inspecting Air/Water Supply Function
4.3.4 Inspecting Bending Section	4.4.4 J Tube	4.6.3 Attaching Suction Unit	4.7.4 Inspecting Suction Function
4.3.5 Inspecting Scope Connector		4.6.4 Attaching J Tube	4.7.5 Inspecting Instrument Channel
		4.6.5 Attaching Water Pump	4.7.6 Inspecting Water Jet Channel

Note

- When the water jet function is used, be sure to read the sections with gray background ().

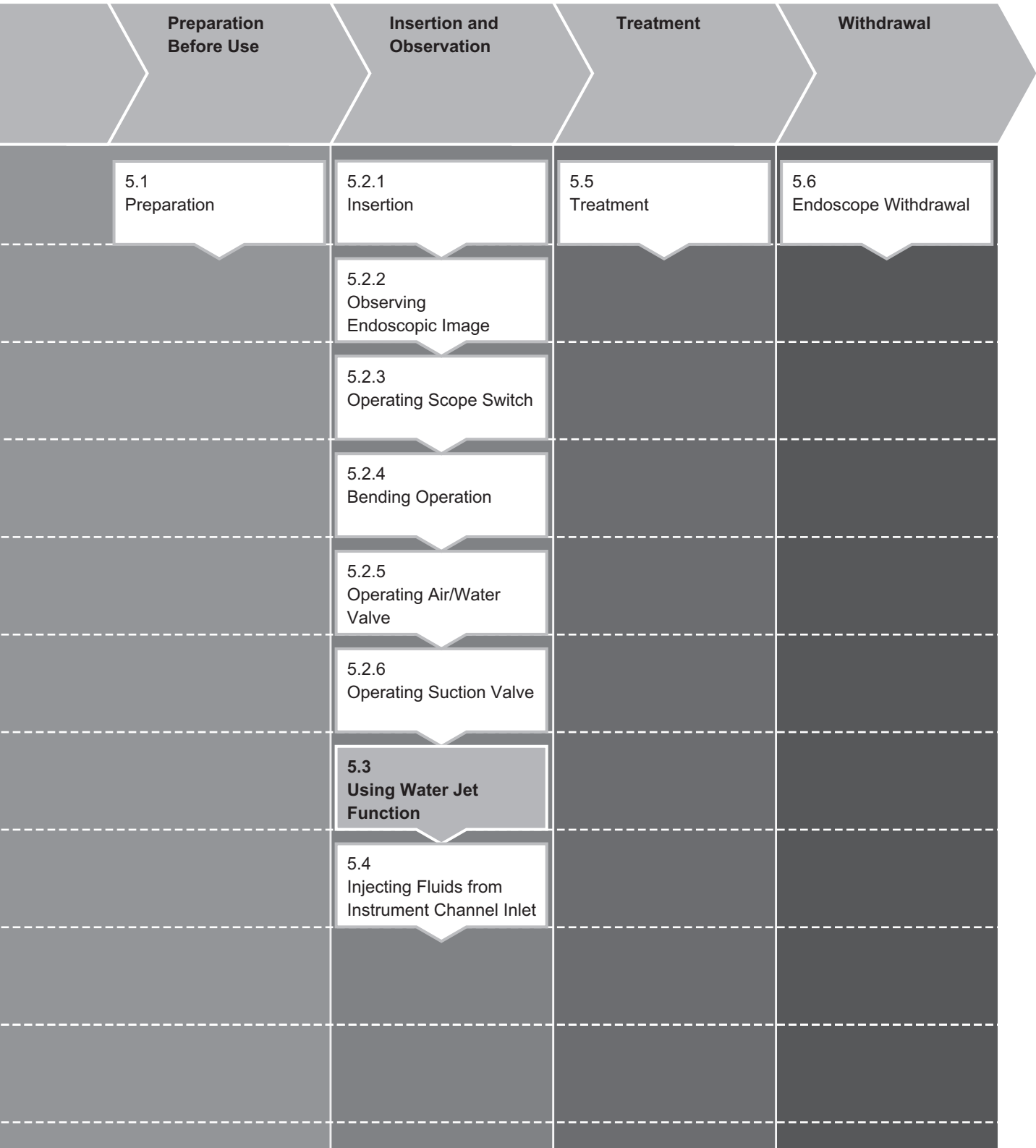

Preparation and Inspection

This chapter describes the inspection and preparation methods to be performed before using the endoscope, its accessories and related equipment.

Before using this product, perform preparation and inspection as per instructions provided in this chapter. In addition, inspect related products used in combination with this product as per instructions provided in respective operation manuals. If the inspection result shows any abnormality, refer to “Chapter 6 Troubleshooting.” If the problem persists, or if any failure is found, stop using the equipment and return it for repair according to “6.4 Returning Endoscope for Repair.”

WARNING

- The entire surface and each channel of the endoscope and the accessories must be reprocessed prior to first use, after any servicing, after any subsequent use, and after storage as per instructions provided in the Reprocessing Manual, even if the accessories were not used during a procedure. In addition, store this product as per instructions provided in the Reprocessing Manual. Inadequate reprocessing or storage may cause infection.
- Make sure to inspect the endoscope and accessories before use according to the procedures provided in this manual. Do not use the equipment that shows any signs of abnormality or irregularity. Use of abnormal equipment may lead to misdiagnosis or increase risks to patient safety.
- During an inspection or procedure, use sterile water. If sterile water is not used, it can create a risk of infection.

CAUTION

- Make sure to inspect the endoscope and accessories before use according to the procedures provided in this manual. Do not use the equipment that shows any signs of abnormality or irregularity. Use of abnormal equipment may cause equipment malfunction.
- If abnormalities and/or material changes including but not limited to cracking, flaking, pitting, corrosion, etc. which can create rough surfaces or sharp edges, holes/depressions, compromise sealed surfaces and/or negatively affect device functionality are found, contact your local FUJIFILM dealer.

Note

- The endoscope and accessories are not reprocessed before shipping from FUJIFILM. Reprocess them according to the instructions given in the Reprocessing Manual before using them in a procedure.

4.1 Preparation of the Equipment

Prepare the endoscope, accessories, related equipment and personal protective equipment. Related equipment not supplied with this product is optional. Also refer to the operation manual of related equipment and personal protective equipment.

◆ Endoscope

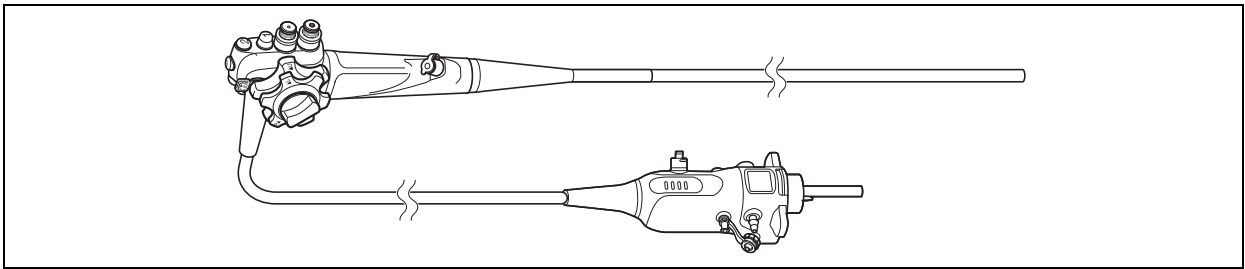

Note

- Prepare the endoscope that has been reprocessed as per instructions provided in the Reprocessing Manual.

◆ Accessories

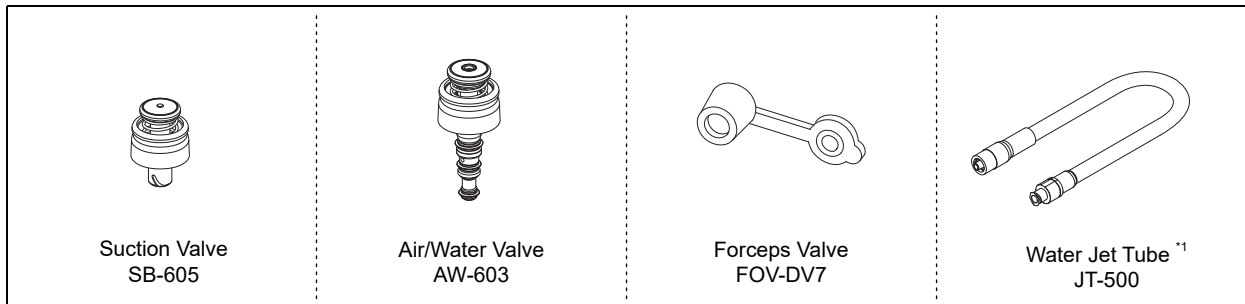

*1 Accessory for the endoscope with the water jet function

→ “Table 3.1 Function of each model and applicable workflow”

Note

- Prepare accessories that have been reprocessed as per instructions provided in the Reprocessing Manual.

◆ Related Equipment (Essential)

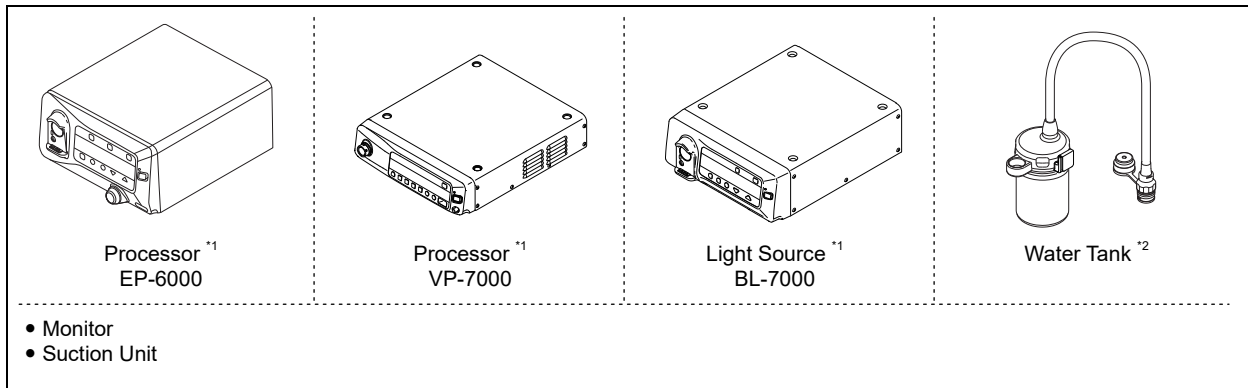

*1 The endoscope is used in combination with the EP-6000 processor or with the VP-7000 processor and the BL-7000 light source.

*2 Prepare the water tank that has been reprocessed as per instructions provided in the operation manual of the water tank.

◆ Related Equipment (To be Prepared when Necessary)

Note

- In addition to the devices described here, products that can be used in combination with this product may be added. In addition, the devices described here may have already been discontinued or not marketed depending on the country or region. For details on the devices used in combination with this product, contact your local FUJIFILM dealer.

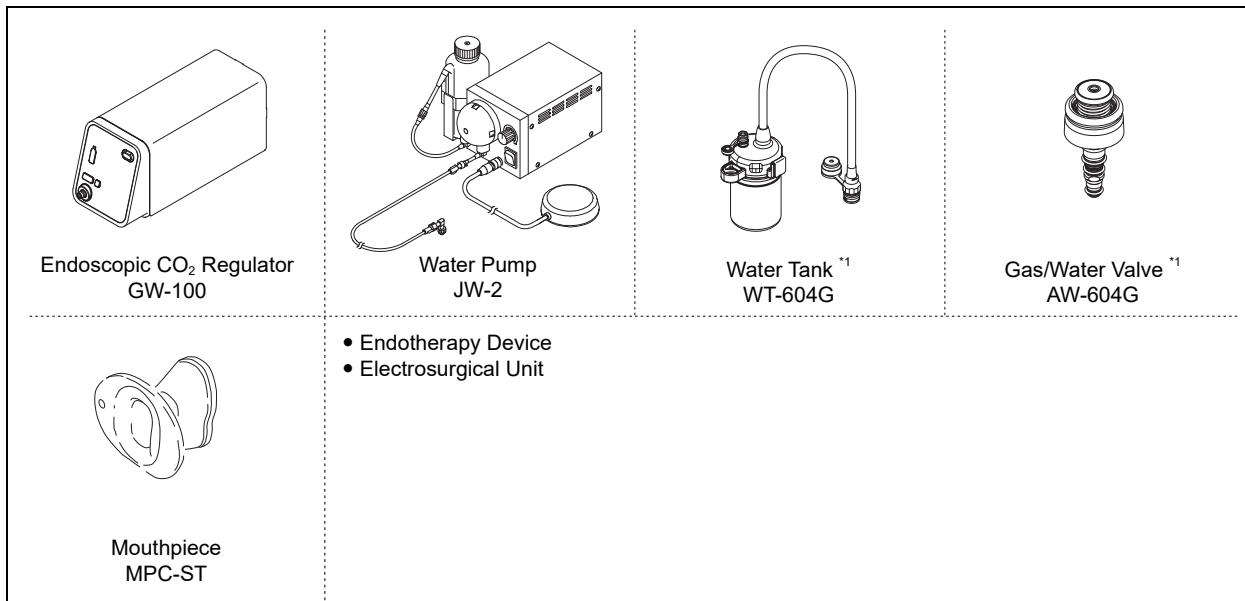

*1 Used in combination with the endoscopic CO₂ regulator GW-100.

*2 Accessory for the upper gastrointestinal endoscope.

Note

- Prepare related equipment that has been reprocessed as per instructions provided in the operation manual of related equipment.

◆ Personal Protective Equipment

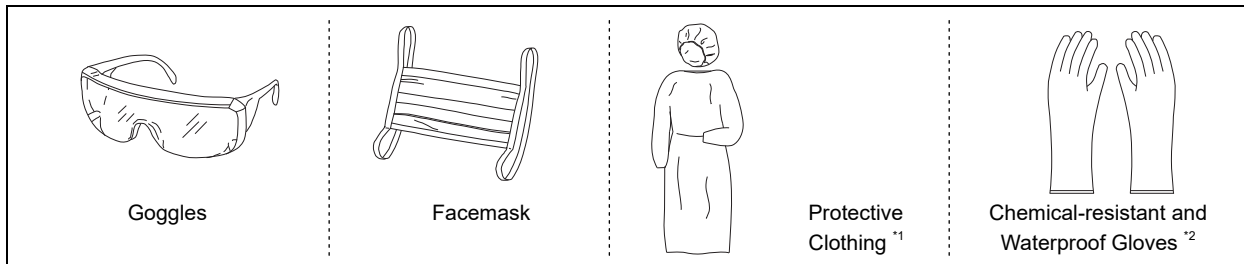

*1 It is also recommended to use shoes that can be disinfected and/or a single-use shoe covers.

*2 Chemical-resistant and waterproof gloves are recommended to be long enough to prevent your skin from being exposed.

◆ Others

- Sterile gauze
- Sterile water
- Sterile basin

4.2 Transporting Endoscope

This section explains how to transport the reprocessed endoscope. When transporting the endoscope that has been pre-cleaned after use, refer to the Reprocessing Manual.

→ “Reprocessing Manual”

WARNING

- Carry a reprocessed endoscope in a clean manner. If personal protective equipment such as gloves is contaminated, the contaminants adhere to the endoscope and it can be a source of infection.

CAUTION

- When transporting a reprocessed endoscope, firmly grasp the control portion and scope connector. If only the LG flexible portion or the boot is grasped, it may damage the endoscope.
- When transporting a reprocessed endoscope, do not coil the insertion tube or the LG flexible portion of the endoscope with a small diameter. Doing so may cause endoscope failure.

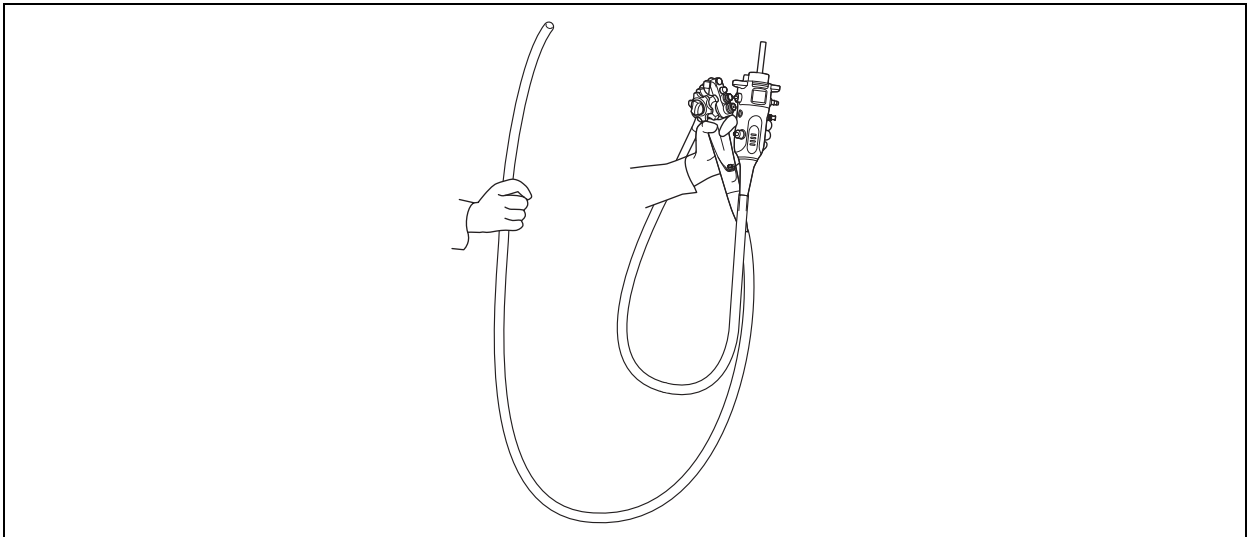

- (1) Prepare a reprocessed endoscope for transportation.
- (2) When carrying the endoscope by hand, loop the LG flexible portion, hold the scope connector with the control portion in one hand, and hold the distal end of the insertion tube gently in the other hand.

4.3 Inspecting Endoscope

Prior to inspection, make sure that dirt does not adhere to the endoscope. If dirt adheres to the endoscope, reprocess it according to the instructions given in the Reprocessing Manual.

4.3.1 Inspecting Control Portion

- (1) Visually and manually inspect the control portion for excessive scratches, deformation, cracks, residue, loose parts, or other irregularities.

4.3.2 Inspecting Insertion Portion

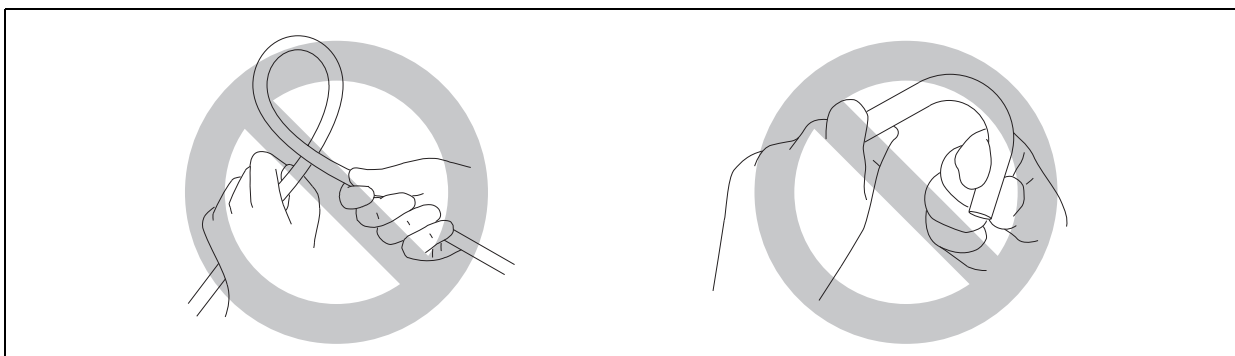

CAUTION

- Do not forcibly twist or bend the insertion tube of the endoscope. It could damage the endoscope.

- (1) Visually inspect the boot and the insertion portion near the boot for bends, twists, swelling or other irregularities.

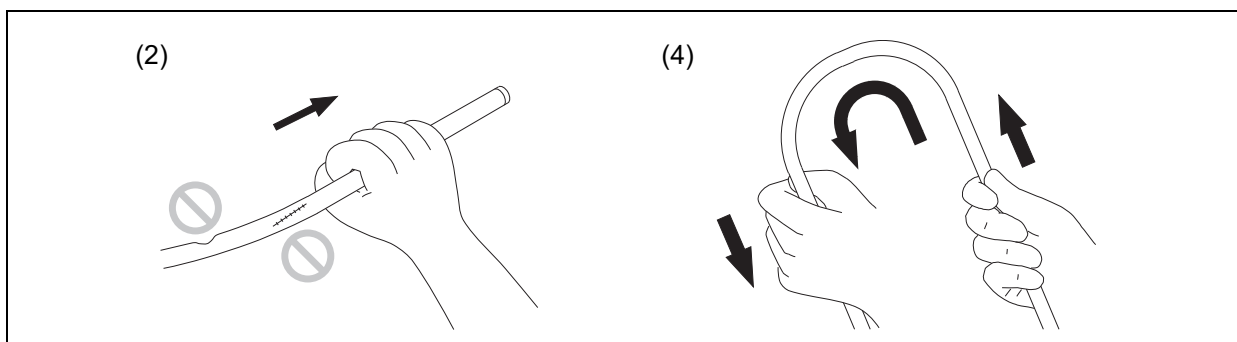

- (2) Visually and manually check the insertion portion (distal end, bending section and insertion tube) for abnormalities such as indentations, bumps, peeling, sharp edges or protrusions, etc. In addition, confirm that the insertion tube is not abnormally rigid.
- (3) Visually and manually check the bending section sheath and adhesives at each end of the bending section for abnormalities such as missing epoxy, roughness, pitting or flaking.
- (4) Hold the insertion tube with both hands to make a semicircle with a diameter of approximately 200 mm. Then, move the apex of semicircle sliding insertion tube for full length. Check that the tube bends fully and there are no areas of excessive rigidity or stiffness.

4.3.3 Inspecting Distal End

WARNING

- Turn off the light of the processor (light source) before inspecting the objective lens. Viewing the light from the light guide directly may damage your eyes.

- (1) Make sure that the light of the processor (light source) is turned off.
- (2) Visually and manually check the following points.
 - The objective lens is free from scratches, cracks or disengagement.
 - The areas around the objective lens are free from cracks or gaps.
 - The light guides are free from scratches, cracks or disengagement.
 - The areas around the light guides are free from abnormalities such as gaps.
 - The distal cap is free from abnormalities such as cracks or disengagement.
 - The air/water nozzle is free from abnormalities such as cracks, abnormal protrusion, disengagement, crushes, dents or deformation.
 - The side surface of the distal end is free from abnormalities such as scratches, peeling or abnormal bulging.
 - The distal adhesives are free from abnormalities such as loss, peeling or deterioration.
 - All distal end surfaces are free from foreign residues, debris or sharp edges.

Note

- If the distal adhesives are lost, peeled or deteriorated, or if the lens is damaged or disengaged, contact your local FUJIFILM dealer.

4.3.4 Inspecting Bending Section

WARNING

- Turn the up/down and left/right angulation knobs slowly in each direction until they stop. Repeat this operation several times to confirm that the bending section angulates smoothly and correctly. If the endoscope with an abnormal angulation knob is used, the bending section does not return to its neutral position, causing patient injury.

CAUTION

- Do not forcibly turn the angulation knob further after turning the knob until it stops. If the angulation knob is forcibly turned, it may cause malfunction of the endoscope.

◆ Inspection for Smooth Operation

- (1) Straighten the bending section.
- (2) Turn the up/down and left/right angulation locks in the direction of F (Free) until they stop to unlock the up/down and left/right angulation knobs and confirm that the up/down and left/right angulation knobs move smoothly.

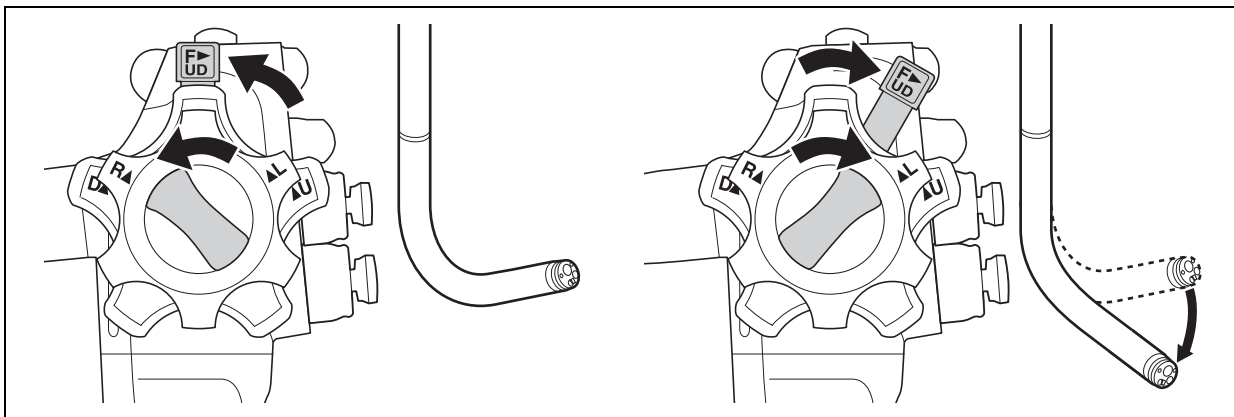

- (3) Slowly turn the up/down angulation knob in the directions of U and D and the left/right angulation knob in the directions of L and R. Ensure the distal tip moves to the desired direction, and then return them to their neutral position. Repeat this operation several times to confirm that the bending section angulates and returns to its neutral position smoothly and correctly.

<When the up/down and left/right angulation knobs are in the neutral positions>

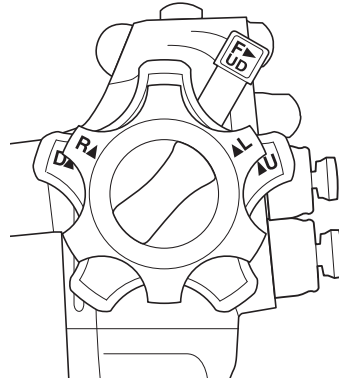

- (4) When the up/down and left/right angulation knobs are turned to their respective neutral positions, visually check that the bending section returns smoothly to an approximately straight condition.

◆ Inspecting Up/Down Angulation

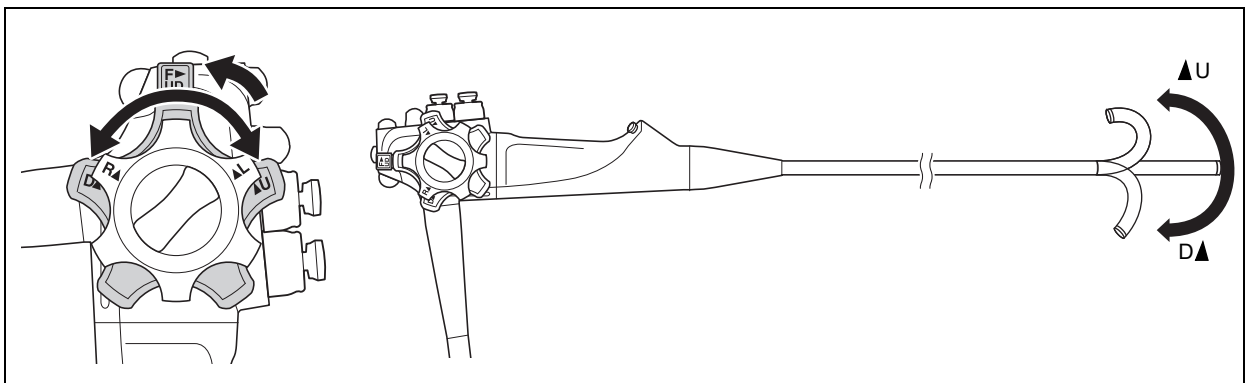

- (1) Move the up/down angulation lock all the way in the opposite direction of F (Free) to lock the up/down angulation knob.

Note

- When the up/down or left/right angulation lock is moved in the opposite direction of F (Free), the rotation of the up/down or left/right angulation knob becomes harder, and even when fully locked the angulation knob and the distal bending section still can be moved.
- (2) Turn the up/down angulation knob in the directions of U and D until it stops. Confirm that the angle of the bending section is roughly stabilized when the up/down angulation knob is released.
- (3) Move the up/down angulation lock all the way in the direction of F (Free) to unlock the up/down angulation knob. Confirm that the bending section moves back toward its neutral position when the up/down angulation knob is released.

◆ Inspecting Left/Right Angulation

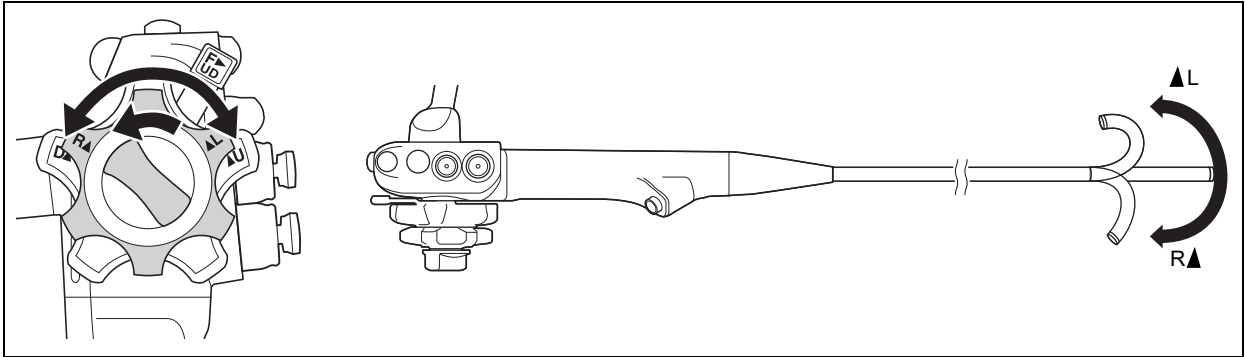

- (1) Move the left/right angulation lock all the way in the opposite direction of F (Free) to lock the left/right angulation knob.

Note

- When the up/down or left/right angulation lock is moved in the opposite direction of F (Free), the rotation of the up/down or left/right angulation knob becomes harder, and even when fully locked the angulation knob and the distal bending section still can be moved.

- (2) Turn the left/right angulation knob in the directions of L and R until it stops.
Confirm that the angle of the bending section is roughly stabilized when the left/right angulation knob is released.
- (3) Move the left/right angulation lock all the way in the direction of F (Free) to unlock the left/right angulation knob.
Confirm that the bending section moves back toward its neutral position when the left/right angulation knob is released.

4.3.5 Inspecting Scope Connector

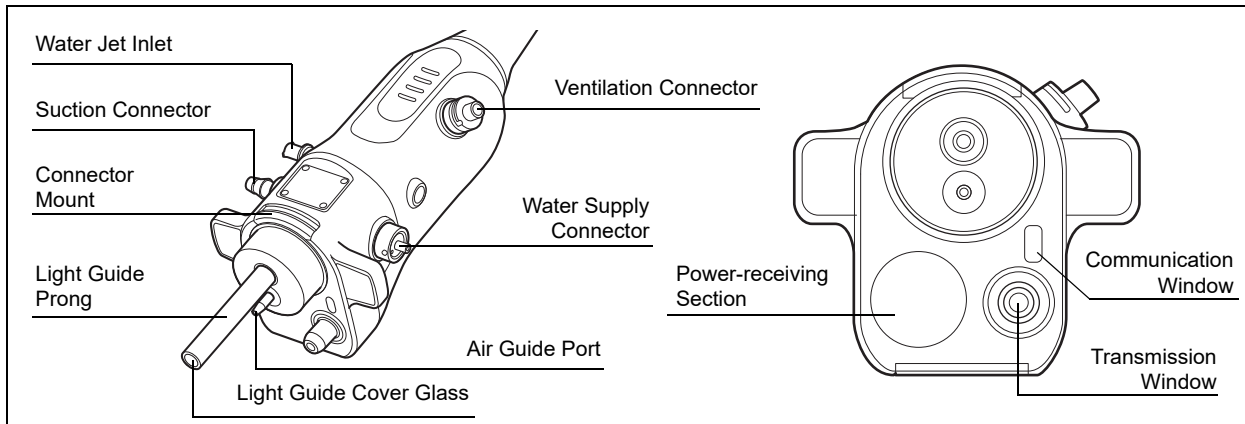

CAUTION

- Make sure that no moisture or foreign matter (such as dust, gauze fibers, metallic fragments) adheres to the scope connector before connecting it to the processor (light source). If the scope connector with moisture or foreign matter (such as dust, gauze fibers, metallic fragments) is connected, it may cause malfunction or failure of the devices.
- Do not attach anything to the power-receiving section. In addition, make sure that no foreign matter such as metallic fragments adheres to the power-receiving section. Adhesion of foreign matter may cause thermal injury, or malfunction or failure of the devices.

- (1) Visually and manually inspect the scope connector for abnormalities such as excessive scratching, dents, deformation or loose parts.
- (2) Before attaching the scope connector to the processor (light source), make sure that no moisture or foreign matter (such as dust, gauze fibers, metallic fragments) adheres to the connector mount, light guide cover glass, air guide port, power-receiving section, communication window, transmission window, ventilation connector, water supply connector, suction connector, or water jet inlet of the scope connector.
If any foreign matter is found, wipe it off with soft, sterile gauze moistened with alcohol.

4.4 Inspecting and Attaching Accessories

Prior to inspection, make sure that dirt does not adhere to the accessories. If dirt adheres to the accessories, reprocess them according to the instructions given in the Reprocessing Manual.

4.4.1 Forceps Valve

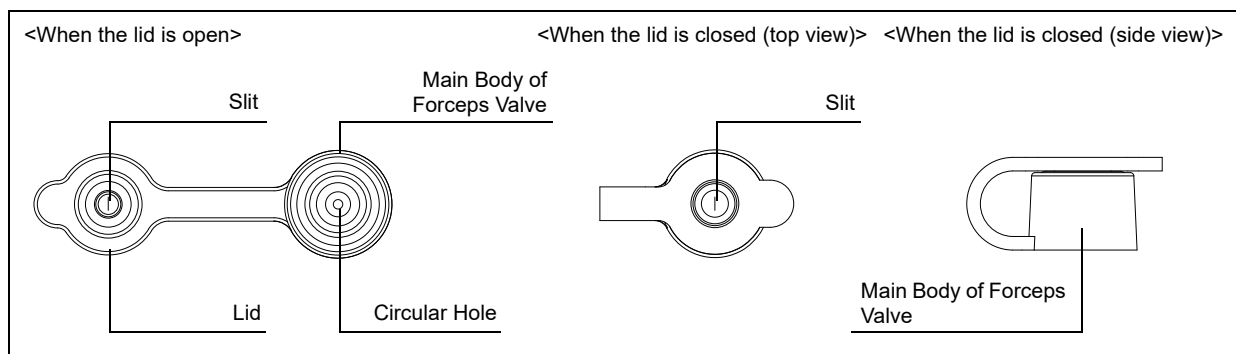

WARNING

- The forceps valve is intended for single use. Discard it after use. If a deteriorated forceps valve is used, body fluids may leak, causing infection.
- Reprocess the forceps valve before use. Use of an improperly reprocessed forceps valve can create a risk of infection.
- Make sure to check the forceps valve before use. If the inspection result shows any sign of abnormality or irregularity, replace the forceps valve with a new one already reprocessed. Use of an abnormal forceps valve may cause the leakage of body fluid, posing an infection risk.
- Ensure that the forceps valve is properly attached to the instrument channel inlet. If this product is used without the forceps valve attached, body fluid may leak and it could be a source of infection.

<Preparation>

The forceps valve is not reprocessed before shipping from FUJIFILM. Reprocess it according to the instructions given in the Reprocessing Manual before using it in a procedure.

→ Reprocessing Manual

<Inspection>

- (1) Confirm that the slit and circular hole on the forceps valve are free from abnormalities such as splits, cracks, deformations or discoloration.
- (2) Close the lid and visually check that there is no clearance between the lid and the main body of the forceps valve.

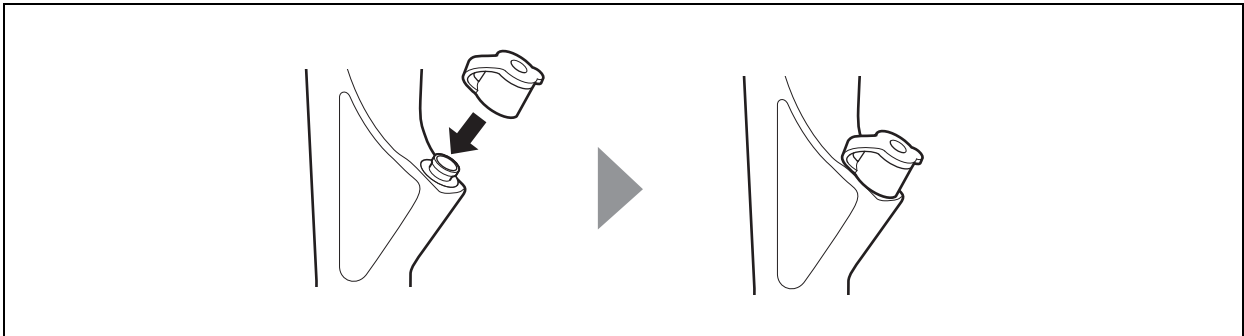
<Attachment>

- (1) Attach the forceps valve to the instrument channel inlet of the endoscope.

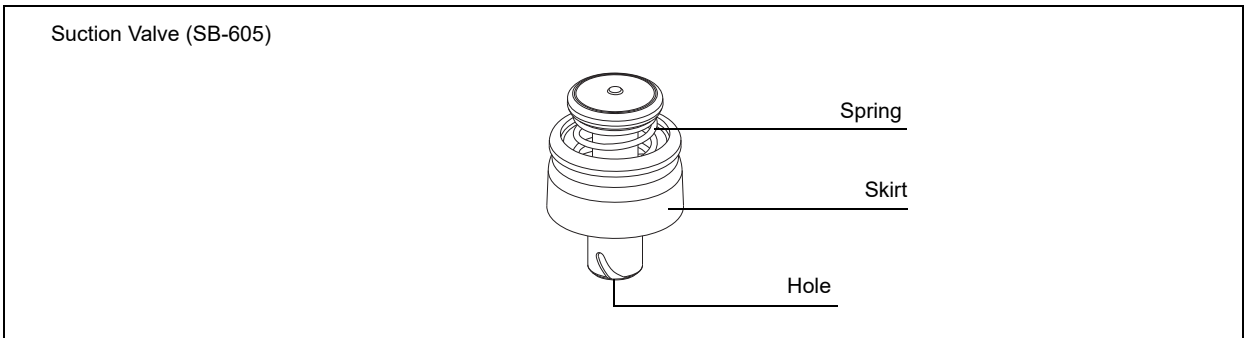
4.4.2 Suction Valve**WARNING**

- Use a properly reprocessed suction valve. Use of an improperly reprocessed suction valve could be a source of infection.

CAUTION

- When attaching the suction valve to the suction valve cylinder of the endoscope, align the recessed and projecting portions and slowly insert the suction valve straight into the suction valve cylinder of the endoscope. If the suction valve is attached forcibly, it may be damaged.

<Preparation>

The suction valve is not reprocessed before shipping from FUJIFILM. Reprocess it according to the instructions given in the Reprocessing Manual before using it in a procedure.

- Reprocessing Manual

<Inspection>

Visually check that the suction valve is free from abnormalities such as tears, distortions, cracks, indentations, etc.

Note

- The suction valve is a consumable item. If any abnormality is found, use a reprocessed spare valve.

<Attachment>**Note**

- The suction valve and the suction valve cylinder have an orange marking. Check the marking on the suction valve and that on the suction valve cylinder to prevent an error in attachment.

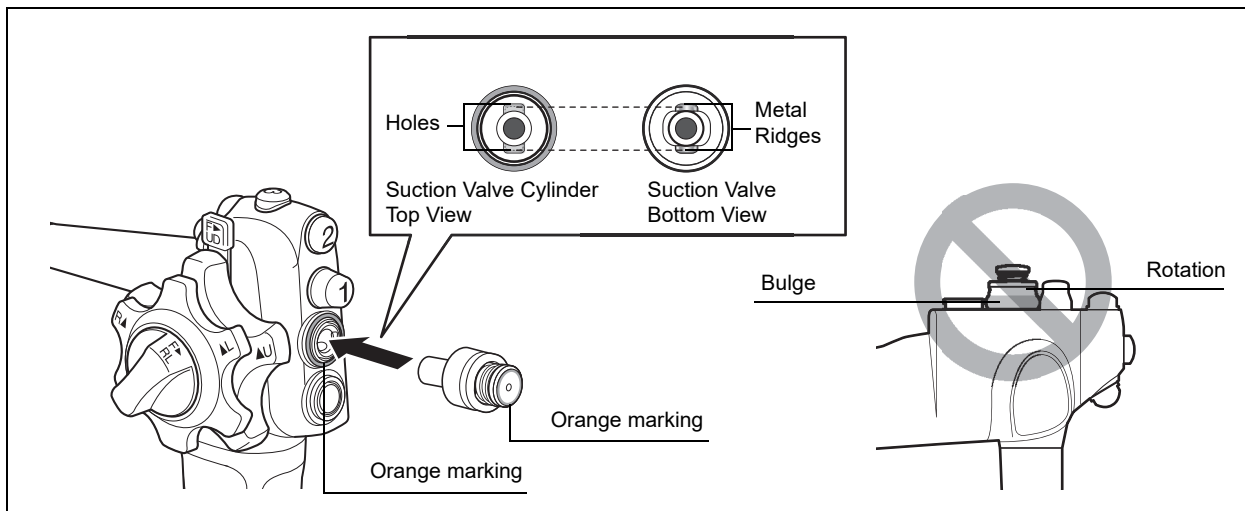

- (1) Attach the suction valve to the endoscope's suction valve cylinder, align the two metal ridges of the suction valve with the two holes in the suction valve cylinder, and push in the valve firmly.
- (2) Visually and manually check that the valve fits properly without any bulging of the skirt. Also confirm that the valve cannot be rotated.

4.4.3 Air/Water Valve

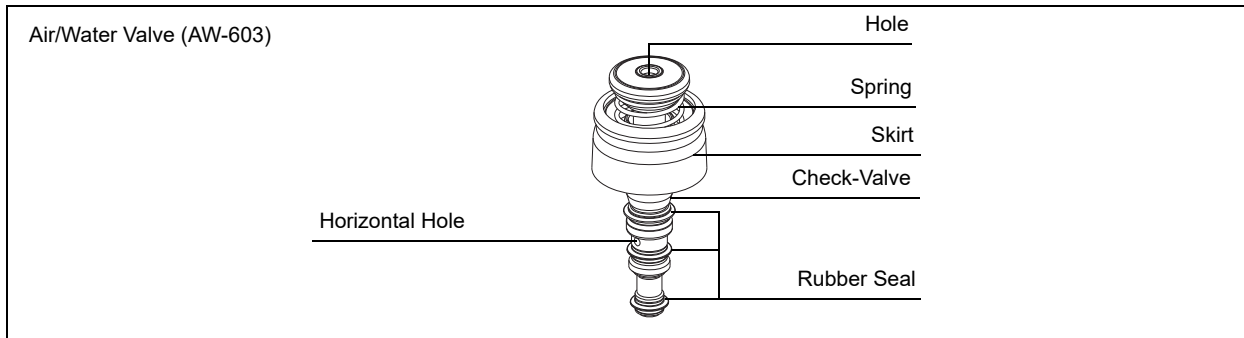

WARNING

- Use a properly reprocessed air/water valve. Use of an improperly reprocessed air/water valve could be a source of infection.
- Use the air/water channel cleaning adapter only for pre-cleaning of the air/water channel. If it is used during a procedure, continuous air supply may occur and cause patient injury.

CAUTION

- Do not use any lubricants to the air/water valve. It may impair the functionality of the valve or may clog the channel, diminishing functionality of air/water supply.

<Preparation>

The air/water valve is not reprocessed before shipping from FUJIFILM. Reprocess it according to the instructions given in the Reprocessing Manual before using it in a procedure.

→ Reprocessing Manual

<Inspection>

- (1) Visually check that the hole of the air/water valve is not blocked.
- (2) Visually check that the air/water valve is not deformed or cracked.
- (3) Visually check the air/water valve for excessive scratching or tears in the valve's seals.

Note

- The air/water valve is a consumable item. If any abnormality is found, use a reprocessed spare valve. The rubber seals, which show signs of abnormality or irregularity, may be able to be repaired.

<Attachment>

CAUTION

- Slowly insert the air/water valve straight into the air/water valve cylinder of the endoscope. If the air/water valve is attached forcibly, it may be damaged.

Note

- The air/water valve and the air/water valve cylinder have a blue marking. Check the marking on the air/water valve and that on the air/water valve cylinder to prevent an error in attachment.

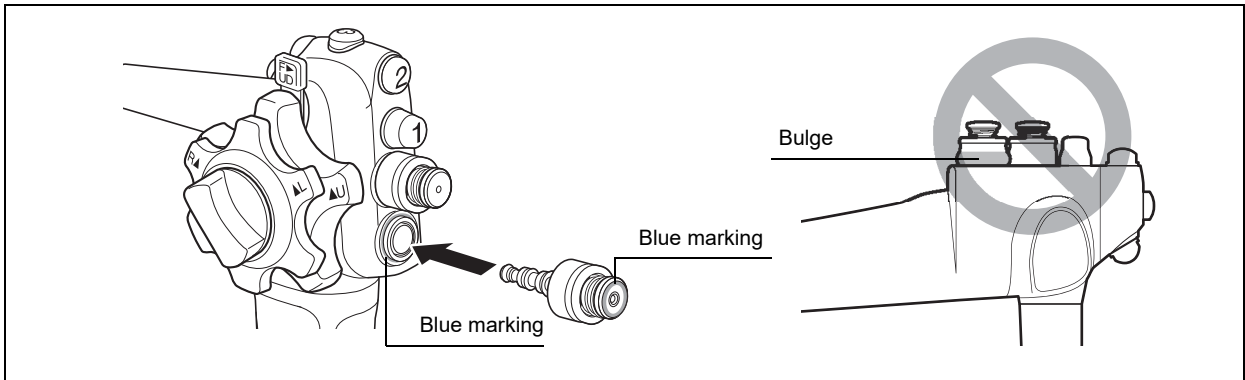

- (1) Attach the air/water valve to the endoscope's air/water valve cylinder, and push in the valve firmly.
- (2) Visually and manually check that the valve fits properly without any bulging of the skirt.

4.4.4 J Tube

The J tube is an accessory for the endoscopes with the water jet function.

→ “Table 3.1 Function of each model and applicable workflow”

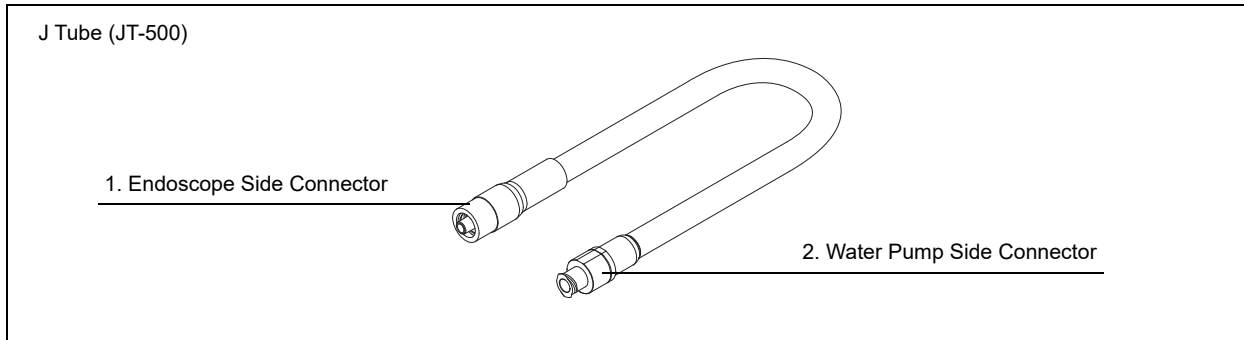

No.	Name	Function
1	Endoscope Side Connector	Connects to water jet inlet of endoscope.
2	Water Pump Side Connector	Accepts water pump or syringe.

WARNING

- When using a J tube, ensure that it has been properly reprocessed. Use of an improperly reprocessed J tube could be a source of infection.

CAUTION

- When using the water jet function, be sure to use the FUJIFILM J tube model JT-500 regardless of irrigation or water source. If the specified J tube is not used, water may leak from the water jet channel and it may come into contact with related equipment, causing a failure of related equipment.

<Preparation>

The J tube is not reprocessed before shipping from FUJIFILM. Reprocess it according to the instructions given in the Reprocessing Manual before using it in a procedure.

→ Reprocessing Manual

<Inspection>

Visually check that the connector is attached to the J tube and that the J tube is free from abnormalities such as tears, cracks, indentations, etc.

Note

- The J tube is a consumable item. If any abnormality is found, use a reprocessed spare J tube.

<Attachment>

Attach the J tube to the endoscope after connecting the endoscope to the processor (light source).

For details on how to attach the J tube, refer to “4.6.4 Attaching J Tube.”

➔ “4.6.4 Attaching J Tube”

4.5 Preparing Related Equipment

Prepare related equipment such as the following as per instructions provided in each operation manual.

- Processor *1 (Processor and Light Source *1)
- Monitor
- Water tank
- Suction unit
- Endotherapy device
- Mouthpiece
- Hood
- Water pump
- Endoscopic CO₂ regulator
- Electrosurgical unit

*1 The endoscope is used in combination with the EP-6000 processor or with the VP-7000 processor and the BL-7000 light source.

4.5.1 Inspecting Related Equipment

Inspect related equipment as per instructions provided in each operation manual.

Note

- Some pieces of related equipment are not reprocessed before shipping from FUJIFILM or the manufacturer. Reprocess them for the first time prior to use as per instructions provided in respective operation manuals.

4.5.2 Preparing System

WARNING

- When the hood is used, wear protective clothing when detaching the hood from the distal end of the endoscope. Otherwise, it may pose an infection risk.

CAUTION

- Secure the distal hood using medical grade tape with no twist or peeling. Do not press the hood against the digestive tract wall with undue force. It may damage mucous membrane.
- Fix the hood securely to the endoscope before use. Otherwise, the hood may fall off during a patient procedure.
- Do not grasp the bending section forcefully when attaching or detaching the hood. It may damage the endoscope.

CAUTION

- With regard to the amount of sterile water in the water tank, follow the instructions provided in the operation manual of the water tank. If the amount of sterile water in the water tank exceeds the limit, the air/water supply function may be disabled or it may cause equipment failure due to contact with spilled water.
- Use the endoscopic CO₂ regulator described in this manual. If another insufflation device is connected, the air/water supply function lessens and may result in improper cleaning of the lens.

- (1) Move the cart with the processor (and light source) and other related equipment to the place where endoscope is to be used.

Note

- In order to install related equipment onto the cart, refer to the Operation Manual of the EP-6000 processor if the EP-6000 processor is used or those of the VP-7000 processor and the BL-7000 light source if the VP-7000 processor is used.
- When multiple foot switches are used, check the position of the corresponding foot switch in advance, so as not to use the wrong foot switch by mistake.

- (2) After turning the main switch on the cart to OFF position, insert the AC plug of the cart into a hospital grade receptacle.

- (3) Prepare the suction unit.

Note

- For details on the suction unit, refer to the “manual” of the suction unit.

- (4) Mount the water tank, 80% filled with sterile water, on the cart or processor (light source).

Note

- The water in the water tank should be changed at least daily using sterile water.
- Use a reprocessed water tank.
- FUJIFILM water tanks must be reprocessed at least daily. These water containers are 24-hour multiple patient use devices which should not be used longer than 24 hours without additional reprocessing.

4.6 Connecting Endoscope to Processor (Light Source) and Related Equipment

This section explains how to connect the endoscope to the processor (light source) and related equipment.

4.6.1 Connecting to Processor (Light Source)

WARNING

- Firmly connect the scope connector of the endoscope and the processor (light source). If the scope connector is not connected properly, the endoscopic image may flicker or be lost, which may cause patient injury, bleeding and/or perforation.

CAUTION

- Firmly connect the scope connector of the endoscope and the processor (light source). Do not look into the connecting part between the endoscope and the processor (light source). Light leaking from the connecting part may cause damage to the eyes.
- Immediately after detaching the scope connector from the processor (light source), do not touch the light guide prong with hands since it may be extremely hot. There is a risk of burn injury.

- (1) Make sure that the processor (and light source) and related equipment are turned off.

Note

- The endoscope can be connected or disconnected when the EXAM. indicator lamp on the processor is set to "STANDBY." For details, refer to the operation manual of the processor.
- (2) Make sure that no moisture or foreign matter (such as dust, gauze fibers, metallic fragments) adheres to the power-receiving section, communication window or transmission window of the scope connector.

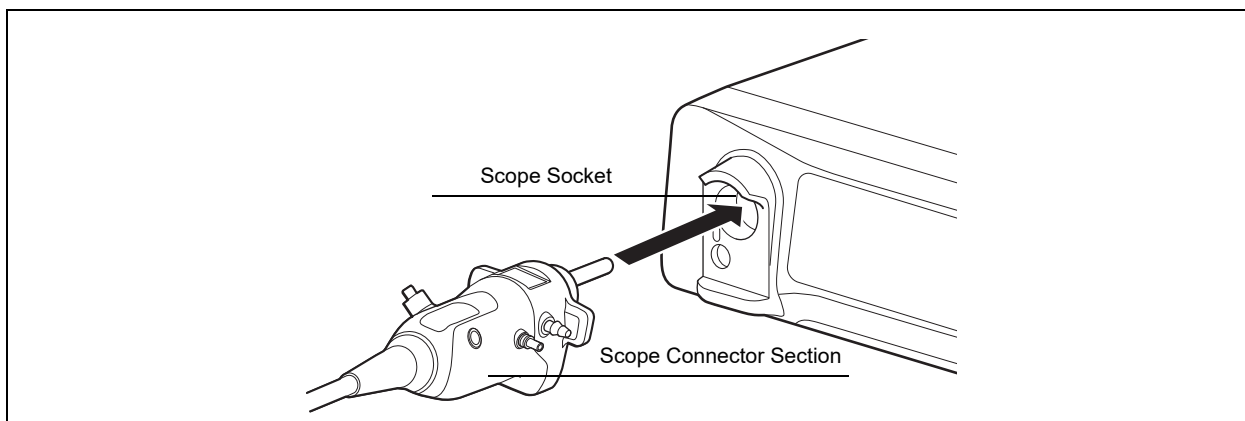

- (3) Insert the scope connector into the scope socket of the processor (light source) with the label on which the model name is printed facing upward.
- (4) Fully insert the scope connector until it clicks.
- (5) Visually check that the scope connector is fully inserted.

4.6.2 Attaching Water Tank

CAUTION

- Attach the water tank to the specified position of the cart or processor (light source). Otherwise, fluid may leak from the connector of the water tank and it may come into contact with related equipment, causing equipment failure.

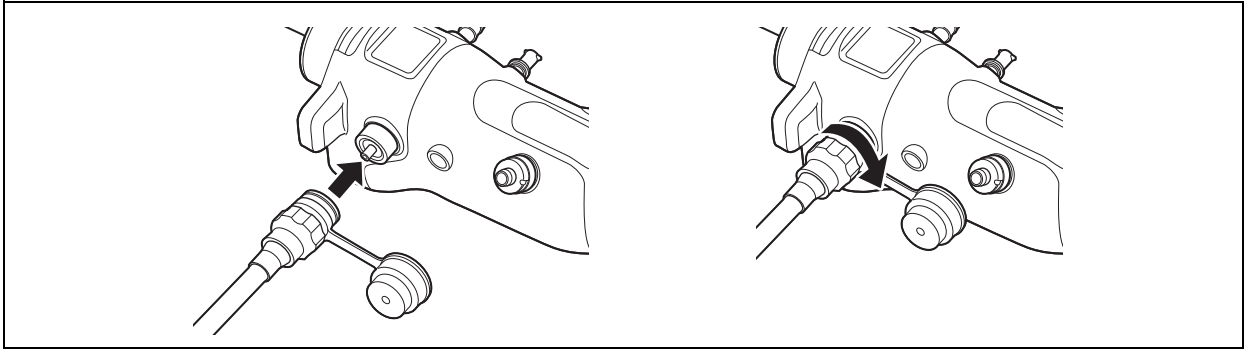

- (1) Align the pin of the water supply connector of the endoscope to the groove in the connector of the water tank.
- (2) Insert the connector of the water tank straight into the water supply connector and attach it firmly by turning the connector clockwise until it stops.
- (3) Visually check that the water supply connector of the endoscope and the connector of the water tank are connected properly.

4.6.3 Attaching Suction Unit

WARNING

- Firmly connect the suction tube from the suction unit to the suction connector on the scope connector. If the suction tube is not attached properly, body fluid may drip from the tube and can pose an infection control risk.

CAUTION

- Firmly connect the suction tube from the suction unit to the suction connector on the scope connector. If the suction tube is not attached properly, body fluid may drip from the tube and come into contact with related equipment, causing equipment failure.

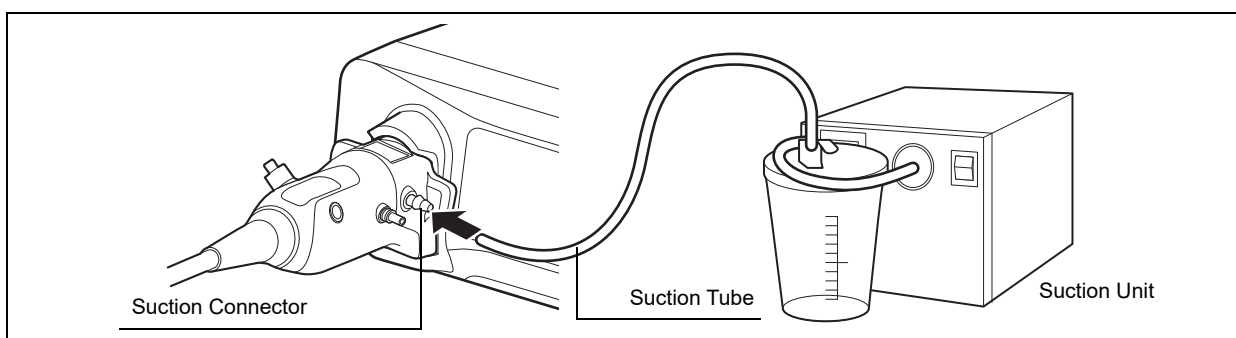

- (1) Firmly connect the suction tube from the suction unit to the suction connector of the endoscope.

4.6.4 Attaching J Tube

The J tube is an accessory for the endoscopes with the water jet function.

→ “Table 3.1 Function of each model and applicable workflow”

WARNING

- Regardless of irrigation or water source, the FUJIFILM J tube (JT-500) must be used with the water jet channel. If the specified J tube is not used, body fluids may leak, posing infection risks to patients and/or end-users.

CAUTION

- When connecting the J tube to the endoscope, do not overtighten the endoscope side connector of the J tube. Doing so may damage the connector of the J tube or make it impossible to detach.

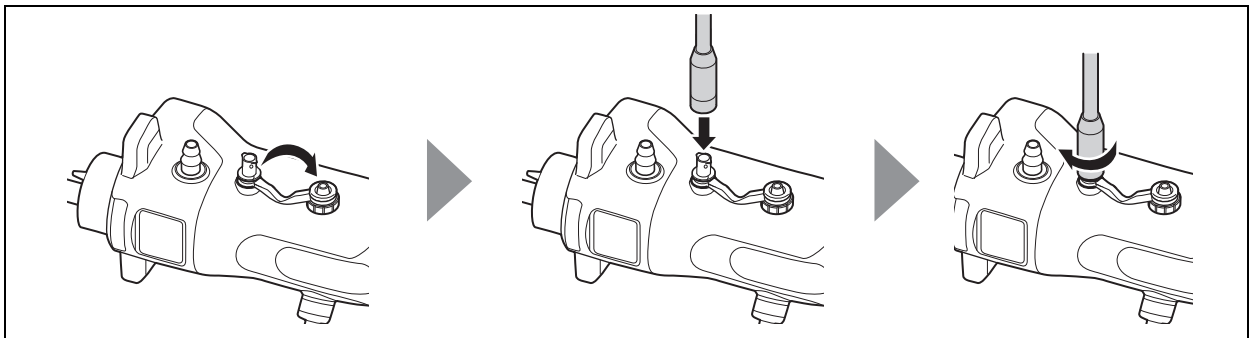

- (1) Ensure that the water jet inlet cap is open.
- (2) Connect the endoscope side connector of the J tube to the water jet inlet and rotate it clockwise to secure it.

Note

- Do not apply excessive force to the connected part of the J tube and water jet inlet.

4.6.5 Attaching Water Pump

Reprocess the water pump and its components according to the instructions given in respective operation manuals or use sterile, single-use components before using them in a procedure.

WARNING

- Confirm that all components of the water pump (irrigation source) have been reprocessed or are sterile, single patient use items. The components of the FUJIFILM water pump (irrigation source) have not been reprocessed. Before using irrigation components for a procedure for the first time, reprocess them as per the instructions described in the manual of the water pump. Use of an improperly reprocessed water pump can be a source of infection.
- Inspect the reusable components of the water pump. If any abnormal part is found, replace it with a new one. If any abnormal component is used, it could be a source of infection.
- After the water pump is used in a procedure, reprocess it for each case according to the instructions of the operation manual of the water pump. Use of improperly reprocessed water pump could be a source of infection.

CAUTION

- When connecting the J tube to the endoscope and/or other components, do not overtighten the connector of the J tube. Doing so may damage the connector of the J tube or that of the endoscope.
- (1) Connect the tubing of a water pump filled with sterile water to the J tube. When supplying water during a procedure, use sterile water.

4.7 Inspecting Functions Used in Combination with Related Equipment

4.7.1 Inspecting Endoscopic Images

Confirm that endoscopic images are normally displayed on the monitor and that the images are clear, sharp, of appropriate color and accuracy of observed target sites.

WARNING

- Do not look directly into the light coming from the light guide at the distal end of the endoscope. Viewing the light from the light guide directly may damage your eyes.

CAUTION

- If the endoscope is used in combination with the processor VP-7000 and the light source BL-7000, when turning off VP-7000, also turn off BL-7000. If the light source BL-7000 remains on after turning off the processor, the ALC (automatic light control) does not function and the maximum amount of light is emitted. As a result, the distal end of the endoscope and its surroundings may become hot, causing burn injury to the patient or end-user.
- Turn off the light of the processor (light source) except during an inspection or procedure, etc., when necessary. If the light of the processor (light source) is left on, the distal end of the endoscope and its surroundings may become hot, causing burn injury to the patient or end-user.

Note

- Use the processor to assign functions on each scope switch. For details, see the operation manual of the processor.

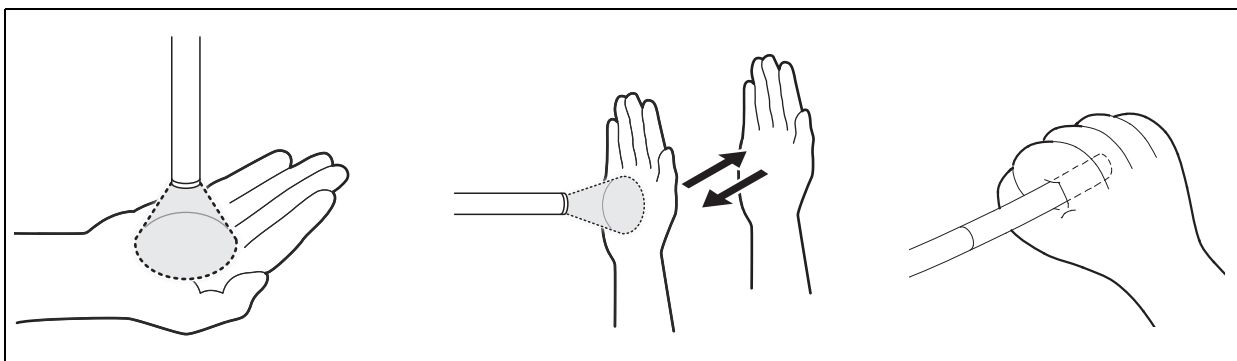

- (1) Turn on the cart, processor (and light source) and monitor.
- (2) Turn on the light of the processor (light source) and make sure that the light is emitted from the light guide of the distal end.

- (3) Observe the endoscopic image while moving your palm toward and away from the objective lens or lightly grasping the distal end. Confirm that the endoscopic image is free from noise, blur, fog, or other irregularities.

Note

- If the endoscopic image cannot be seen clearly, wipe the objective lens with sterile gauze moistened with alcohol.

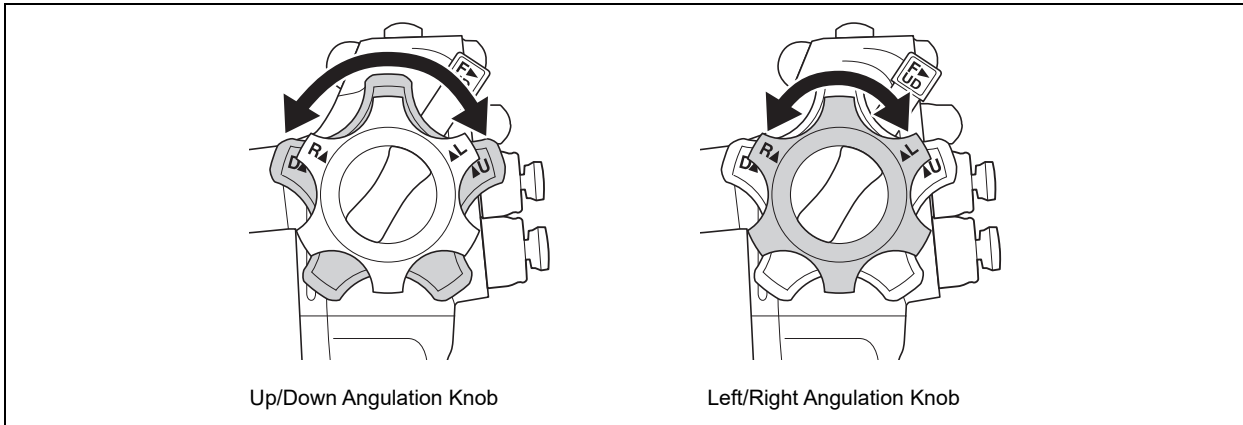

- (4) Angulate the bending section by operating the up/down or left/right angulation knob of the endoscope and confirm that the endoscopic image is free from momentary disappearing or other irregularities.

4.7.2 Inspecting Scope Switch

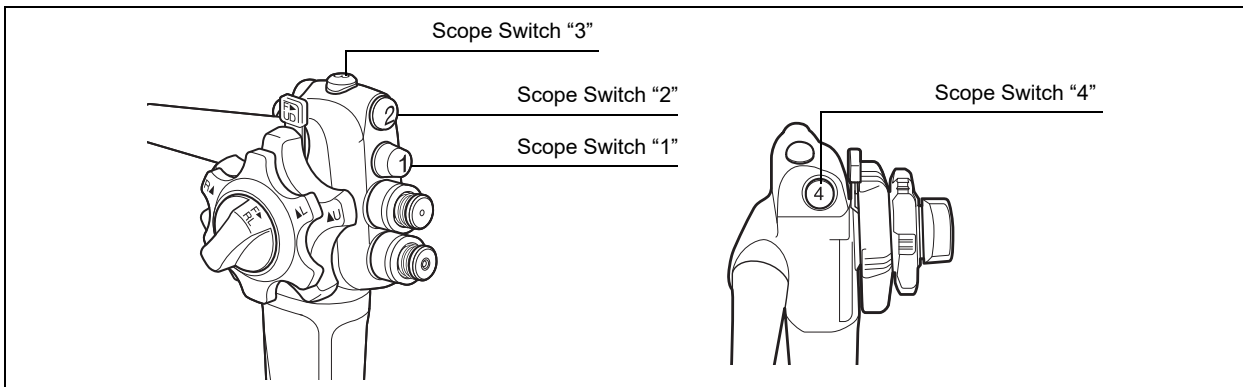

- (1) Confirm that the assigned function is executed by pressing each scope switch.

Note

- Use the processor to assign functions on each scope switch. For details, see the operation manual of the processor.
- (2) Turn off the light of the light source.

4.7.3 Inspecting Air/Water Supply Function

WARNING

- If water leaks from the air/water valve during the inspection of the air/water supply function, replace it with a reprocessed spare one. A leaking air/water valve may cause backflow of body fluid, posing an infection control risk.

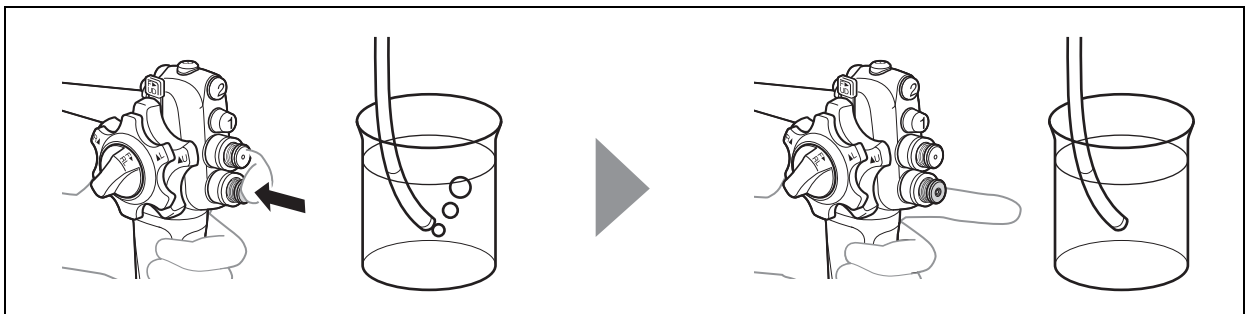

- (1) Turn on the suction unit. Keep the light of the processor (light source) off.
- (2) Prepare a container of sterile water.
- (3) Immerse the distal end of the endoscope in sterile water to a depth of about 60 mm and confirm that no air bubbles come out of the air/water nozzle.

Note

- When the distal end of the endoscope is immersed less than 60 mm below the surface of the sterile water, a small amount of air bubbles may come out from the air/water nozzle even when the hole in the air/water valve is not covered. This does not indicate a malfunction.

- (4) Cover the center hole of the air/water valve with your finger, and be sure that air comes out of the air/water nozzle. Release your finger from the hole and check that air does not come out of the nozzle.

Note

- Manipulation method differs when a gas/water valve for an endoscopic CO₂ regulator is used. For details on how to use, refer to the operation manual of the endoscopic CO₂ regulator.

- (5) While still within the container, withdraw the scope tip to just above the fluid, then press the air/water valve, and check that sterile water comes out of the air/water nozzle.

Note

- Note the direction in which sterile water comes out. Water should flow directly over the objective lens.

- (6) Release the air/water valve. Confirm that water supply stops and the valve returns to its original position.
- (7) Set the air supply pump's operation of the processor (light source) to "OFF."

4.7.4 Inspecting Suction Function

WARNING

- If water leaks from the forceps valve or suction valve during the inspection of the suction function, replace the forceps valve with a new reprocessed forceps valve or the suction valve with a reprocessed spare suction valve. A leaking forceps valve or suction valve may cause backflow of body fluid, posing an infection control risk.

- (1) Confirm that the suction unit is turned on and the suction pressure is set to 40 to 53 kPa.
- (2) Immerse the distal end of endoscope in sterile water, and check that pressing the suction valve aspirates sterile water.

Note

- Check that the forceps valve has been properly attached to the instrument channel inlet of the endoscope. If it is not attached properly, water cannot be aspirated.
- (3) Release the suction valve. Confirm that suction stops and the valve returns to its original position.

4.7.5 Inspecting Instrument Channel

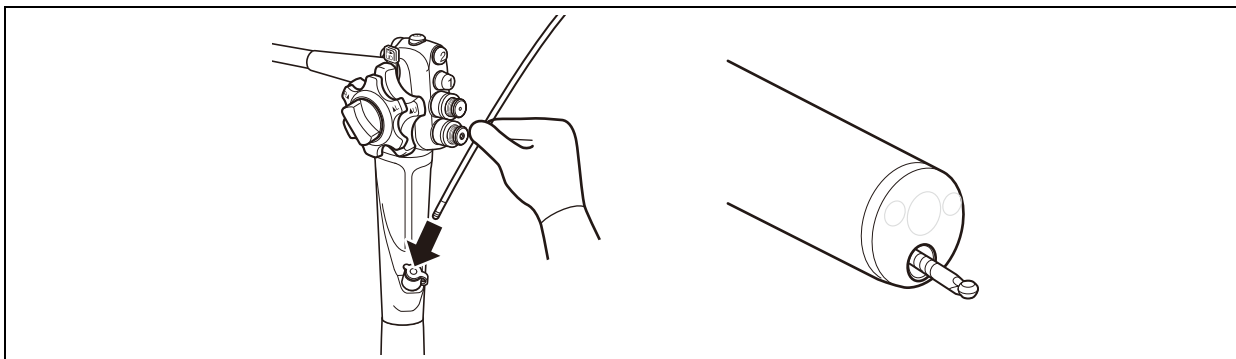

- (1) Insert an endotherapy device from the instrument channel inlet with the forceps valve attached and check that the endotherapy device comes smoothly out of the instrument channel outlet in the distal end of the endoscope.
- (2) Confirm that the endotherapy device is withdrawn easily from the forceps valve.

4.7.6 Inspecting Water Jet Channel

This section is applicable only to the endoscopes with the water jet function.

→ “Table 3.1 Function of each model and applicable workflow”

WARNING

- Regardless of irrigation or water source, the FUJIFILM J tube (JT-500) must be used with the water jet channel. If the specified J tube is not used, body fluids may leak, posing infection risks to patients and/or end-users.
- Use a sterile syringe or reprocessed water pump and irrigation components for supplying water to the water jet nozzle. Use of a non-sterile or inadequately reprocessed device may pose an infection risk.

CAUTION

- When using the water jet function, be sure to use the FUJIFILM J tube model JT-500 regardless of irrigation or water source. If the specified J tube is not used, water may leak from the water jet channel and it may come into contact with related equipment, causing a failure of related equipment.

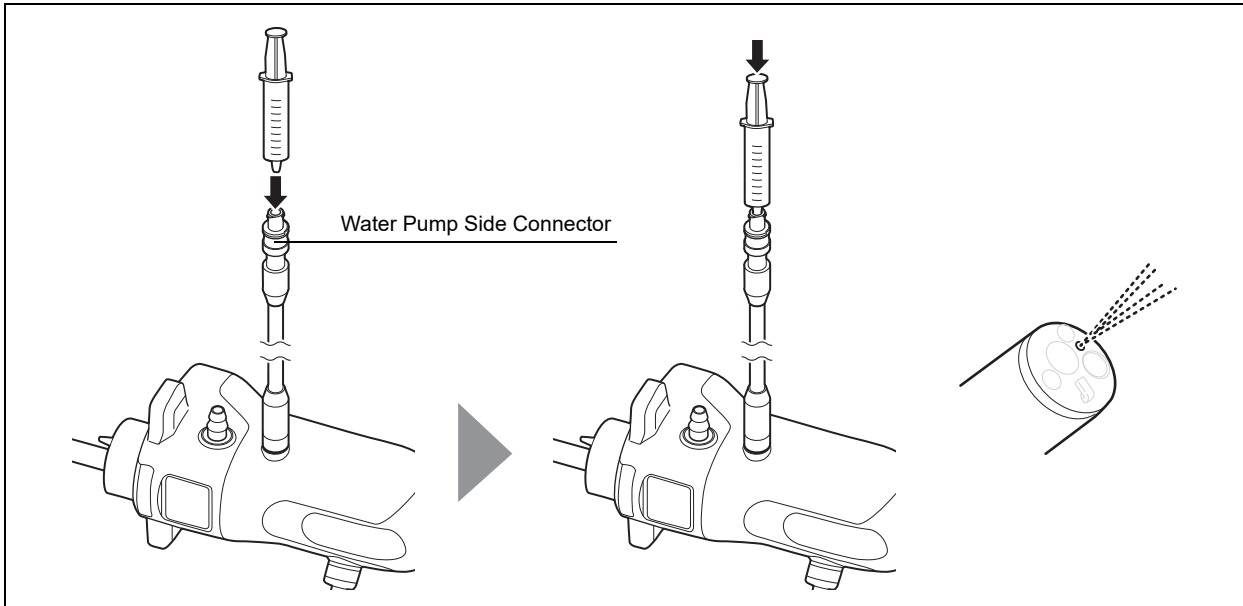

- (1) If a water (irrigation) pump is not connected, attach a sterile syringe filled with sterile water to the J tube.
- (2) Feed sterile water from the water pump or sterile syringe and check that sterile water comes out from the water jet nozzle.

Note

- Note the direction in which sterile water comes out. Water should flow directly over the objective lens.
- Be sure that no abnormalities such as swelling of J tube are found and that no sterile water leaks out from the connecting parts.

- (3) Stop feeding sterile water, and detach the tubing of the water pump or sterile syringe.

Note

- Do not detach the J tube.

- (4) Be sure that no sterile water drips out of the J tube.

Note

- When inspected before use, if more than one drop of water drips from the tube during a 15-second check, replace the J tube with a reprocessed spare one, and repeat above procedures (1) through (4).
- The J tube is equipped with a check-valve to prevent water from dripping out of the water jet channel after detachment of the single-use irrigation system. Use the J tube only with a single-use check-valve or irrigation system which includes a check-valve to prevent backflow to the irrigation components and water source.
- Follow the instructions provided by the manufacturer of water pump regarding the frequency of changing sterile water and all components (tubing, connectors, water tank, etc.).

- (5) Connect the tubing of the water pump to the J tube.

This chapter describes the basic operation procedures of this product and precautions to observe.

This product is intended for use by medical professionals who have received proper training in endoscopic procedures at medical facilities under the management of physicians. This manual does not provide information about procedures or any aspects of endoscopic techniques.

WARNING

- Make sure to inspect the endoscope and accessories before use according to the procedures provided in this manual. Do not use the equipment that shows any signs of abnormality or irregularity. Use of abnormal equipment may lead to misdiagnosis or increase risks to patient safety.
- Wear personal protective equipment (such as goggles, facemask, chemical-resistant and waterproof gloves, antifouling protective clothing, cap and shoe covers) during a procedure as well as during reprocessing to protect your eye and skin and to prevent infection. Not doing so may cause infection.
- Do not supply an excessive amount of air or gas during a procedure. Doing so may cause patient pain, injury to tissues in the body cavity, bleeding, perforation and/or embolism.
- During an inspection or procedure, use sterile water. If sterile water is not used, it can create a risk of infection.
- Never use endotherapy devices, operate, insert or withdraw the endoscope, or operate the related equipment without viewing or while freezing the endoscopic image on the monitor. Otherwise, injury to tissues in the body cavity, bleeding and/or perforation may result.

Note

- Always observe the patient closely. If the patient has symptoms suggestive of an embolism, discontinue the endoscopic procedure immediately and give proper medical treatment.
- Ensure that all related equipment has been properly prepared and processed as per instructions provided with each item.

CAUTION

- Do not subject the scope connector to strong impact. Install the processor (light source) away from obstacles to prevent the scope connector connected to the processor (light source) from accidental impact damage. During the operation of an electric bed, etc., ensure that the scope connector connected to the processor (light source) does not hit the bed. Otherwise, the scope connector of the endoscope and the processor (light source) may malfunction.

CAUTION

- Do not push the boot of the control portion against the bed, etc. during a procedure. Doing so may cause endoscope failure.

5.1 Preparation

5.1.1 Preparing Related Equipment

Prepare related equipment to be used, including back-up or spare endoscope, scope components (valves, hoods, etc.) and accessories (ex. water tank, endotherapy devices, irrigation tubing, etc.).

5.1.2 Pretreatment of Patient

Prepare the patient in the normal endoscopy regimen.

5.1.3 Preparing Mouthpiece

For oral insertion of the endoscope, prepare a mouthpiece per manufacturer's instructions.

WARNING

- Use an appropriate mouthpiece as per manufacturer's instructions, including specific reprocessing recommendations.

CAUTION

- Do not use a mouthpiece that is damaged, deformed, or reveals other irregularities. Doing so may cause injury in the oral cavity and/or equipment failure.

Note

- Reusable mouthpieces are considered consumable items. If any abnormality is found, use a reprocessed spare mouthpiece.

- (1) Before oral insertion, have the patient hold the mouthpiece in his/her mouth.

Note

- If you choose to have the patient hold the mouthpiece after insertion, attach the mouthpiece to the insertion portion in advance. Have the patient hold it promptly after insertion.

5.2 Insertion and Observation

5.2.1 Insertion

WARNING

- Do not forcibly advance or withdraw the endoscope into/from the patient, angulate the bending section forcibly or operate it quickly. It may cause patient injury, bleeding or perforation.
- If a patient sneezes or moves abruptly during the procedure, malfunction of the endoscope and patient bleeding or trauma may occur. Depending on the degree of malfunction, safe endoscope withdrawal may be difficult or impossible, causing severe harm to patient and/or end-users.

CAUTION

- Do not directly apply Xylocaine spray to the insertion portion. Do not use olive oil as a lubricant for insertion. It may cause deterioration of the outer surface.
- If you encounter any resistance during a procedure, insert the endoscope slowly. Do not force it in. Do not insert or bend the endoscope without securing the view on the monitor. Not following the recommendations above may cause endoscope failure or patient injury.

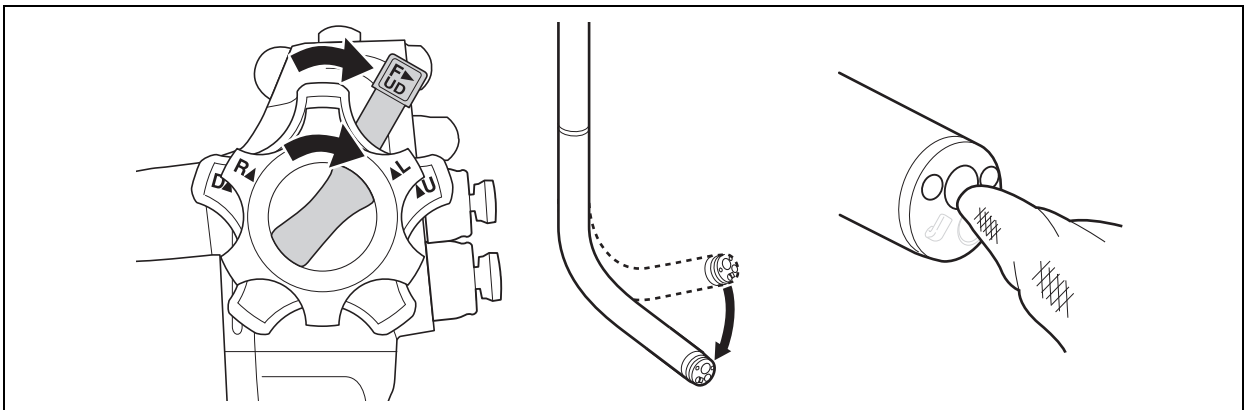

- (1) Patients should lie on examining table in an appropriate position as required for the specific type of endoscopy procedure to be performed.
- (2) Unlock the bending section by turning the up/down and left/right angulation locks in the direction of F (Free) until they stop.

Note

- The procedure described above is recommended. However, other techniques are also available: you can insert endoscope by locking the bending section only in the left-right direction and unlocking it in the up-down direction.

- (3) When necessary, wipe the objective lens and light guides with sterile gauze moistened with alcohol.

Note

- Use lint-free sterile gauze to prevent fibers from entering the air/water nozzle.

- (4) Apply clean lubricant (Xylocaine jelly or the like) to the insertion portion.
- (5) Turn on the light of the processor (light source).

Note

- If the processor (light source) is off, press the power button to turn it on.

- (6) Set the air supply pump's operation of the processor (light source) to "H" (high), "M" (middle) or "L" (low).
- (7) When the upper gastrointestinal endoscope is used, insert the distal end of endoscope into the oral cavity and then move it down to the pharynx while under constant observation.
When the lower gastrointestinal endoscope is used, insert the distal end of endoscope from the anus to the rectum while under constant observation.

5.2.2 Observing Endoscopic Image

Refer to the operation manual of the processor (and light source) for instructions on how to adjust the brightness, color, etc.

WARNING

- When using special light observation mode, use it after sufficiently understanding the difference between the color tone and brightness of normal light observation mode and those of special light observation mode. Use images displayed in special light observation mode as reference information only. Always use the standard endoscopic image in normal light observation mode when performing a diagnosis. Otherwise, it may cause misdiagnosis.
- The endoscopic image may flicker while switching between normal light observation mode and special light observation mode. Therefore, do not perform any endoscopic operation or treatment while switching between normal light observation mode and special light observation mode. Otherwise, injury to tissues in the body cavity, bleeding and/or perforation may result.
- Never use endotherapy devices, insert or withdraw the endoscope, or perform water jet operation while viewing an image in special light observation mode. Otherwise, injury to tissues in the body cavity, bleeding and/or perforation may result.

CAUTION

- During an observation, do not perform close observation for an extended period of time. Use the endoscope with a minimum necessary amount of brightness and time while maintaining an appropriate distance. Thermal energy created by illumination may cause burn injury.
- When the shutter speed is set to “HIGH”, take care not to set the brightness level too high. Thermal energy created by illumination may cause burn injury.
- If the brightness level of the processor (light source) is high, the surface temperature at and around the distal end of the endoscope may exceed 41°C. Do not allow the distal end to remain in contact with the same site for an extended period of time. It may cause burn injury.
- When observing the oral cavity, shield this product from extraneous light as far as possible by darkening the room, etc. Otherwise, a clear endoscopic image may not be obtained.

Note

- In cases with bleeding, use the light save function of the processor (light source). Patient's blood adhering to the light guide at the distal end of the endoscope may be coagulated by the energy of illumination. For details on how to use the light save function, refer to the operation manual of the processor (light source).
- If any steam-like smoke appears in the endoscopic image, or if the endoscopic image becomes dark, blood or other substances may adhere to the light guide at the distal end of the endoscope. Withdraw the endoscope from the patient immediately, remove foreign matter, make sure that the light guide has no abnormality, and then use the endoscope again. If foreign matter is not removed, the temperature at the distal end of endoscope may rise, causing damage to the endoscope or burn injury to the patient or operator.

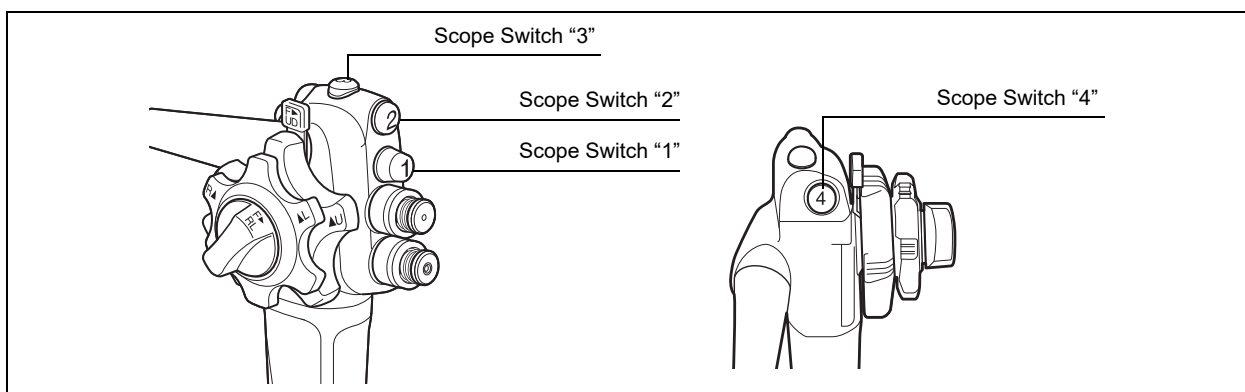
5.2.3 Operating Scope Switch**Note**

- Use the processor to assign functions on each scope switch. For details, see the operation manual of the processor.

(1) When a scope switch is pressed, the function assigned to the switch is activated.

5.2.4 Bending Operation

WARNING

- Do not forcibly turn the angulation knob further after turning the knob until it stops. If the angulation knob is forcibly turned, the angulation mechanism may malfunction and the bending section may not return to its neutral position, making it difficult to withdraw the endoscope.
- If the bending section does not return to its neutral position during a procedure, do not withdraw the endoscope forcibly. Consult your local FUJIFILM dealer. If the endoscope is withdrawn forcibly, injury to tissues in the body cavity, bleeding and/or perforation may result.
- Be extremely careful when performing retroflexed observation in a narrow lumen. Do not perform retroflexed observation forcibly. Otherwise, it may become impossible to straighten the angle of the bending section and/or withdraw the endoscope from the patient.

CAUTION

- Avoid forcible or excessive angulation as this may impose a severely heavy load on the wire controlling the bending section. This may cause stretching or tearing of the wire.

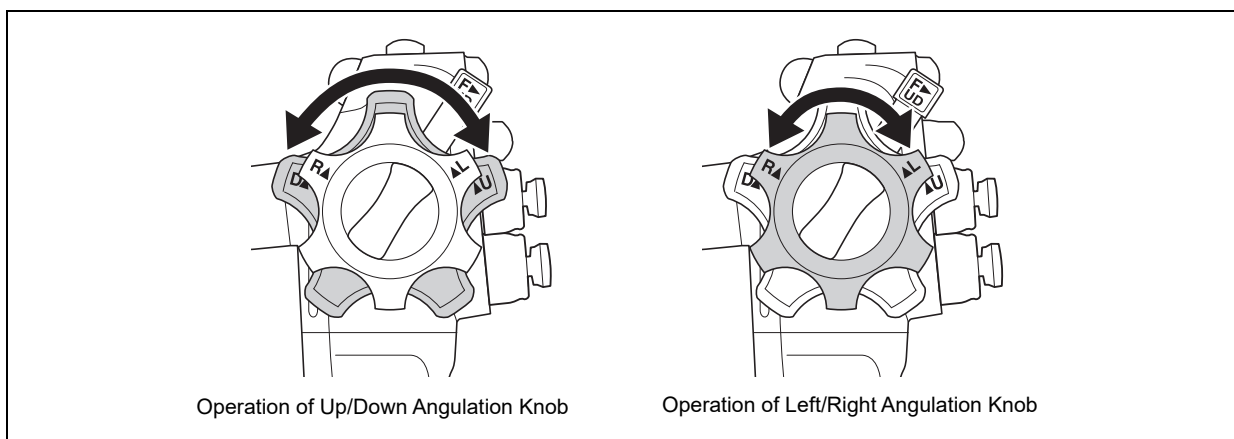

- (1) Steer the distal end of the endoscope to the region of interest by turning the up/down and left/right angulation knobs.

Note

- To retain the bending angle securely, hold the up/down and left/right angulation knobs by hand. When the up/down and left/right angulation knobs are not held, even if the up/down and left/right angulation knobs are locked with the up/down and left/right angulation locks, the bending angle at the distal end may change due to advancement or withdrawal of the endoscope or insertion of an endotherapy device into the instrument channel.

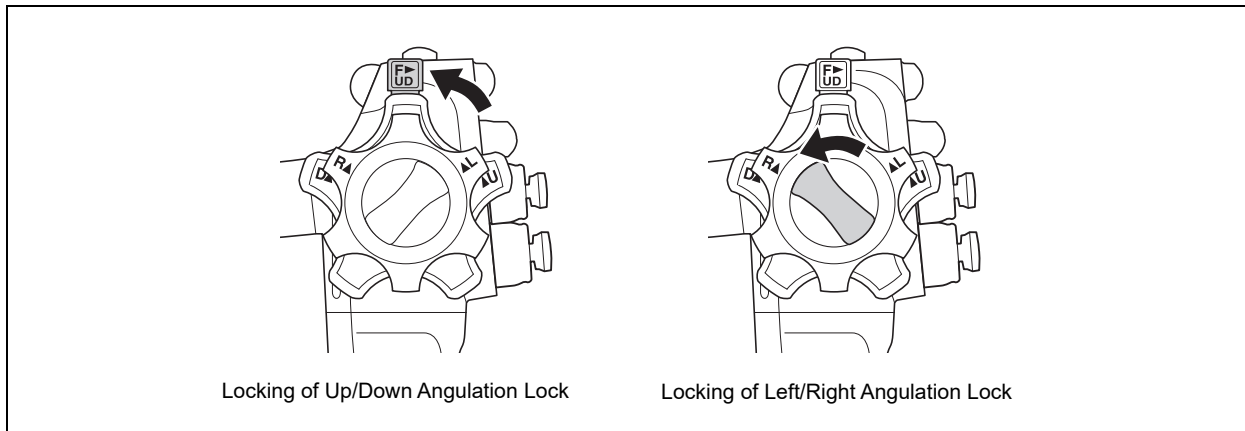

- (2) When necessary, retain the bending angle of the distal end by moving the up/down and left/right angulation locks in the opposite direction of F (Free).

Note

- When moving the up/down and left/right angulation locks, hold the up/down and left/right angulation knobs by hand. When the up/down and left/right angulation knobs are not held, the bending angle at the distal end may change.

5.2.5 Operating Air/Water Valve

Operate the air/water valve to supply air or water from the air/water nozzle in the distal end during a procedure.

Note

- Do not operate the air/water valve under the following conditions while the endoscope is inserted in the body cavity. Doing so may cause the backflow of body fluid and contaminate the sterile water in the water tank.
 - The air supply pump of the light source is set to "OFF".
 - The connector of the water tank is not attached to the water supply connector of the endoscope.
 - The scope connector of the endoscope is not connected to the scope socket of the processor. (single-connector model)

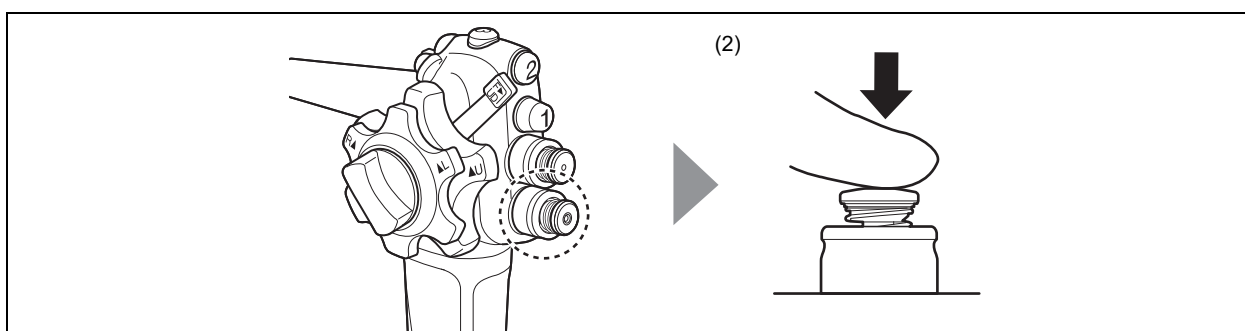

- (1) When the hole in the air/water valve is covered with one's finger, air is supplied to the air/water nozzle in the distal end.

(2) When the air/water valve is pressed, water is supplied to the air/water nozzle in the distal end.

Note

- If patient material adheres to the distal objective lens or if the image is obscured, clean the surface of the lens by operating the air/water valve and supplying water.
- If any debris such as mucus is left adhered, or if air is supplied without supplying water, the debris may become hard to remove due to drying or fixation.
- After operating the air/water valve, if the endoscopic image is unclear due to the light reflected off the water droplets remaining on the objective lens or distal cap, it may be improved by performing suction.

5.2.6 Operating Suction Valve

WARNING

- Set the suction pressure between 40 and 53 kPa. If the suction pressure is too high, patient debris or fluids may leak or splash from the forceps valve, posing infection control risks to patient or operator.
- Do not quickly release one's finger from the suction valve during aspiration. Doing so may cause a splattering of body fluids from the suction valve and increase a risk of infection.
- The lid of the forceps valve must be closed when using the endoscope. Not doing so may cause leak of body fluids and increase a risk of infection.
- Avoid aspirating solid materials or thick fluids. If the suction valve does not return to its original position, stop aspiration immediately and slowly withdraw the endoscope. If any solid materials or thick fluids adhere to or clog the suction valve, suction may not stop, causing damage to mucous membrane.

CAUTION

- Set the suction pressure between 40 and 53 kPa. If the suction pressure is too high, the endoscope may adhere to mucous membrane, resulting in damage to the mucous membrane.
- The lid of the forceps valve must be closed when using the endoscope. Not doing so can reduce the efficacy of the endoscope's suction system, making it impossible to perform aspiration.

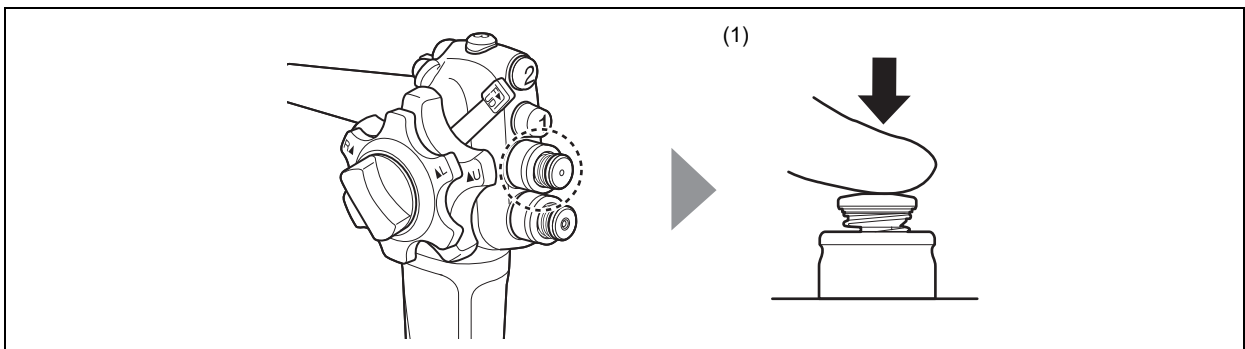

- (1) Press the suction valve to aspirate fluids in the body cavity or patient materials adhering to the distal end from the instrument channel outlet.

5.3 Using Water Jet Function

The procedure described in this section is applicable only to the endoscopes with a water jet function.

→ “Table 3.1 Function of each model and applicable workflow”

WARNING

- Use a sterile syringe or reprocessed water pump and irrigation components for supplying water to the water jet nozzle. Use of a non-sterile or inadequately reprocessed device may pose an infection risk.
- Regardless of irrigation or water source, the FUJIFILM J tube (JT-500) must be used with the water jet channel. If the specified J tube is not used, body fluids may leak, posing infection risks to patients and/or end-users.
- When an endoscope is used but the water jet function is not used, close the water jet inlet cap to block the water jet inlet. If the endoscope is used with the water jet inlet cap left open, it may cause leak of body fluids, posing infection risks to patients and/or end-users.
- Avoid direct contact of the mucosal surface with the distal end of endoscope while washing the target site using the water jet function. Not doing so may cause damage to the mucous membrane.
- Never perform water jet operation while viewing an image in special light observation mode. Otherwise, injury to tissues in the body cavity, bleeding and/or perforation may result.

CAUTION

- When an endoscope is used but the water jet function is not used, close the water jet inlet cap to block the water jet inlet. If the water jet inlet cap is open, it can reduce the effectiveness of the endoscope's suction system and/or allow insufflated air to escape from an unsealed pathway.
- When using the water jet function, be sure to use the FUJIFILM J tube model JT-500 regardless of irrigation or water source. If the specified J tube is not used, water may leak from the water jet channel and it may come into contact with related equipment, causing a failure of related equipment.
- Do not detach the J tube until the endoscope is transported to the location where reprocessing is performed after a procedure. Otherwise, fluid may drip from the water jet channel and it may come into contact with related equipment, causing equipment failure.

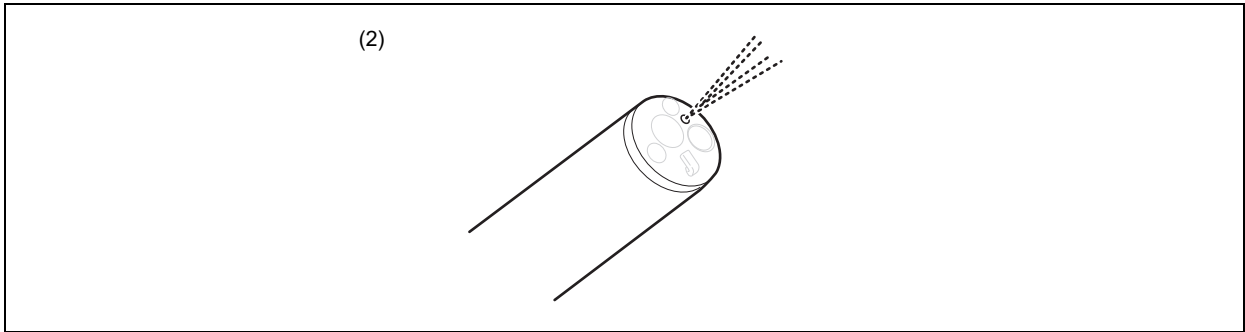

- (1) Operate the up/down and left/right angulation knobs to steer the distal end of the endoscope to the location to be cleaned by the water jet function.
- (2) Using a sterile syringe or an irrigation/water pump system, inject sterile water through the water jet inlet to spray an area of interest.

Note

- If you use the water pump for water feeding, refer to the manual of the water pump.
- When using the water pump, supply water with the minimum flow rate, and then slowly increase the flow rate as necessary while observing the status of mucous membrane.
- Ensure that the water tank of the water pump is filled with sterile water. If not, do not use the water pump.

5.4 Injecting Fluids from Instrument Channel Inlet

WARNING

- When injecting fluids by attaching a syringe to the forceps valve, open the lid of the forceps valve and insert the syringe straight into the forceps valve. Otherwise, the forceps valve may be damaged or the syringe may be accidentally detached during fluid injection and body fluids may leak or splash from the forceps valve, posing an infection control risk to the patient or end-user.
- When the lid of the forceps valve needs to be opened during a procedure, place a piece of gauze, etc. over it to prevent leakage. Otherwise, body fluids may leak or splash from the forceps valve, posing an infection control risk to the patient or end-user.

Note

- The lid of the forceps valve should normally be kept closed. When attaching the syringe to supply water or fluid, remove this lid.

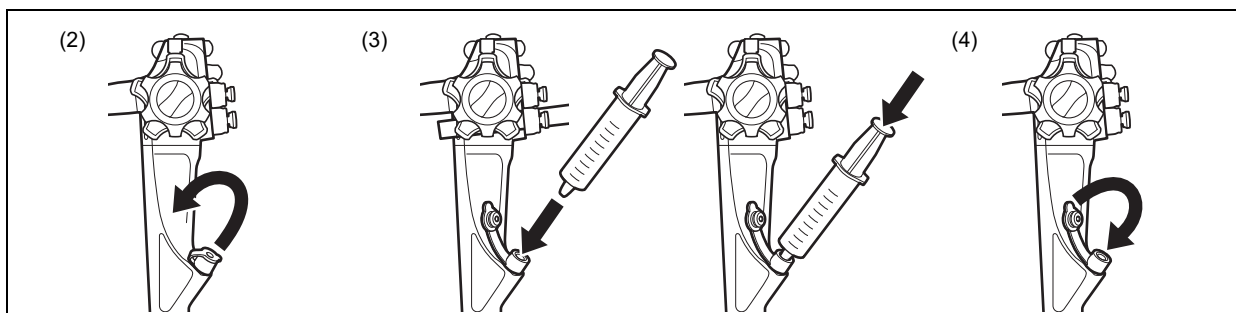

- (1) Fill a syringe with water or fluid.
- (2) Open the lid of the forceps valve.
- (3) Attach the syringe straight to the forceps valve and inject water or fluid.
- (4) Detach the syringe from the forceps valve and close the lid of the forceps valve.

5.5 Treatment

Prior to performing endoscopic electrosurgery, one should have a thorough understanding of the manufacturers' instructions for all equipment involved and one should be familiar with the specific safety and usage aspects of each endotherapy device.

5.5.1 Using Endotherapy Devices

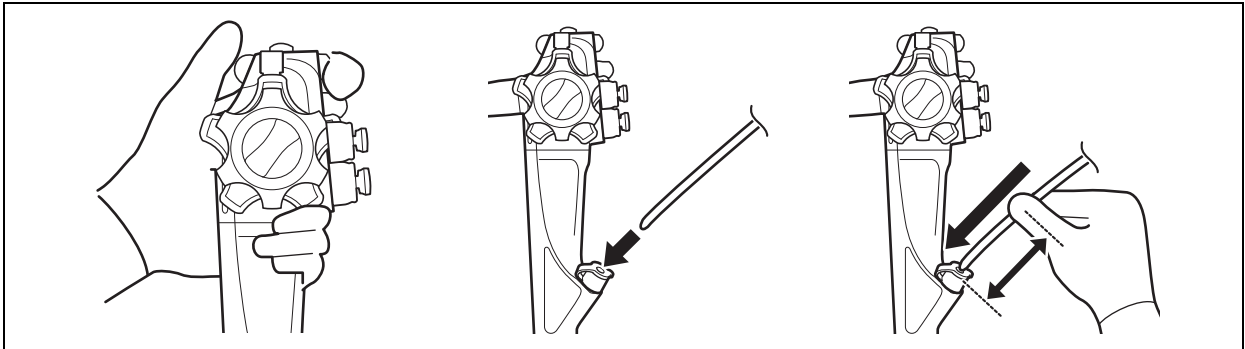

WARNING

- Use sterile or reprocessed endotherapy devices. Non-sterile or inadequately reprocessed endotherapy devices may pose an infection risk.
- Do not use endotherapy devices, operate, insert or withdraw the endoscope, perform bending, air supply, suction or water jet operation, or operate the related equipment whenever the endoscopic image is compromised, unclear, blurry, etc. due to any reason or condition including loss of image, power interruption, water droplets or dirt/debris adhering to the objective lens, etc. Doing so may cause injury to tissues in the body cavity, bleeding and/or perforation.
- Do not apply excessive force of the endoscope or endotherapy device against mucosal surfaces. Doing so may cause injury to tissues in the body cavity, bleeding and/or perforation.
- When inserting an endotherapy device into the endoscope, or when injecting fluids by attaching a syringe to the instrument channel inlet, slowly insert the endotherapy device or syringe straight into the endoscope. Also, when withdrawing it, slowly pull straight out. If an endotherapy device or syringe is inserted or withdrawn quickly, or if it is inserted or withdrawn obliquely against the forceps valve, the forceps valve may be damaged or accidentally detached, or a clearance may be generated between the lid and the main body of the forceps valve. As a result, body fluid may be splattered around leading to infection to the patient or end-user.
- Do not perform a procedure with an endotherapy device hung over the forceps valve. Doing so may cause leakage of body fluids and increase a risk of infection.
- Do not bend or insert the endoscope while an endotherapy device protrudes from the distal end. Excessive force of the endotherapy device may be unintentionally applied against mucosal surfaces, causing injury to tissues in the body cavity, bleeding and/or perforation.
- When the endoscope is used for the pharynx or larynx, ensure that any fluid or excised tissue sample does not enter the trachea, as doing so can create breathing difficulty and/or risk of asphyxiation.

CAUTION

- If resistance is encountered while advancing an endotherapy device within the instrument channel, do not forcibly advance the endotherapy device. Otherwise, it may cause malfunction of the endoscope.
- When inserting an endotherapy device, close the lid of the forceps valve. If the lid is open, it can reduce the efficacy of the endoscope's suction system, making it impossible to perform aspiration.

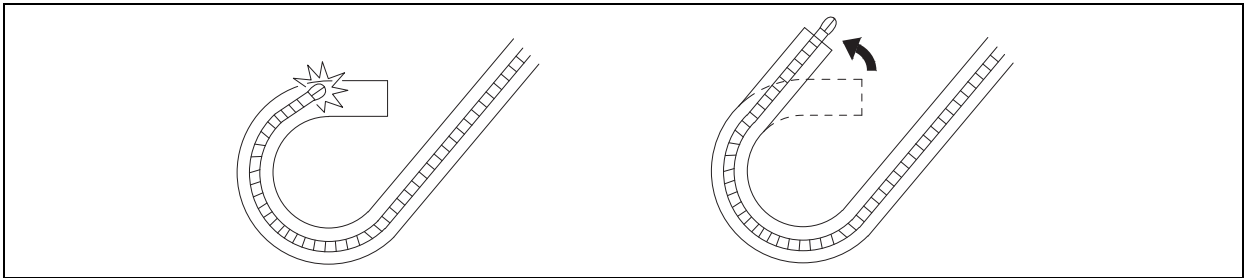

Note

- Occasionally, an endotherapy device can encounter difficulty while attempting to pass through an angulated bending section. In such case, reduce the angulation in the bending section a little and try to advance the endotherapy device again.
- If the handle of an endotherapy device is held tightly, the endotherapy device may not be inserted smoothly or the maximum bending angle may decrease. If this happens, decrease the holding force.

For information on handling an endotherapy device, refer to the manual of the endotherapy device. Use an endotherapy device given in this manual.

→ “Appendix - Related Equipment Used in Combination”

Note

- Do not open the distal end of an endotherapy device with a distal opening/closing function while it is being inserted into the endoscope.
- Do not insert an endotherapy device with a distal needle into the endoscope while the needle's unprotected sharp tip is protruding from the distal end.
- Do not protrude the unprotected sharp needle tip of an endotherapy device while it is being inserted into the endoscope.
- Do not detach the stopper of a clip before or while a clipping device is being inserted into the endoscope.
- Do not open the clip while a clipping device is being inserted into the endoscope.

5.5.2 Use of Non-Flammable Gases

If the intestines contain a flammable gas, replace it with air or a non-flammable gas such as air or CO₂ before performing high-frequency treatment.

WARNING

- If the intestines contain a flammable gas, replace it with air or a non-flammable gas such as air or CO₂ before performing high-frequency treatment. Performing high-frequency treatment while the intestines are filled with a flammable gas could result in an explosion and/or fire.

Note

- When using the endoscopic CO₂ regulator, refer to the operation manual of the endoscopic CO₂ regulator.

5.5.3 High-Frequency Treatment

If the intestines contain a flammable gas, replace it with air or a non-flammable gas such as air or CO₂ before performing high-frequency treatment.

WARNING

- This product is not intended for use with the laser cauterization system. Do not use this product in combination with the laser cauterization system.
- Set the minimum required output power of the electrosurgical unit and high-frequency endotherapy device within the specified output range as per instructions provided in the operation manual of the electrosurgical unit and high-frequency endotherapy device. If the output power is inappropriate, it may cause injury to tissues in the body cavity, thermal injury, bleeding or perforation.
- Wear chemical-resistant and waterproof gloves when performing high-frequency treatment. If not worn, there is a risk of thermal injury or electric shock.
- Always keep pacemaker users away from the electrosurgical unit. The pacemaker may malfunction.
- When performing high-frequency treatment, maintain enough distance between the distal end of endoscope and the tip of the electrosurgical unit. Energize the electrosurgical unit after bringing the tip of the endotherapy device into the field of view. When the high-frequency endotherapy device or energizing part makes contact with the distal end of the endoscope, do not energize the electrosurgical unit. When performing high-frequency treatment, suck mucus adhering to the tissues in the body cavity first and then energize the electrosurgical unit. If the unit is energized when the endotherapy device in contact with the distal end of the endoscope or mucus, it may cause thermal injury.
- Before performing high-frequency treatment, basic in vitro experiments must be performed sufficiently by the user to acquire proper skills for high-frequency treatment.
- In the case of high-frequency treatment on the larynx, ensure that the endoscope or endotherapy device does not make contact with the vocal cords. There is a risk of damaging the vocal cords.
- Use an electrosurgical unit conforming to EN 60601-2-2 (IEC 60601-2-2). If any other electrosurgical unit is used, it may cause severe harm to patient and/or end-users.

WARNING

- Use the electro-surgical unit and related endotherapy devices per instructions provided in the operation manual for each respective device. Otherwise, device failure, electric shock and/or burns may occur.
- Prior to performing endoscopic electro-surgery, one should have a thorough understanding of the manufacturers' instructions for all equipment involved and one should be familiar with the specific safety and usage aspects of each endotherapy device.

CAUTION

- Prevent patient's body from touching electric conductor such as metal part of bed while performing high-frequency treatment. It could cause thermal injury to a patient due to energization via the conductive part.
 - When performing high-frequency treatment, take care that patient's vomitus or body fluids do not make contact with the conductive parts such as a metal part of the bed. It could cause thermal injury to a patient due to energization via vomitus or body fluids.
 - While performing high-frequency treatment, ensure that the end-user does not touch the patient. It could cause thermal injury to a patient and/or end-user.
 - Operate the electro-surgical unit within specified output range as per instructions provided in the operation manual of the electro-surgical unit. Leakage current may cause thermal injury.
 - Do not energize the electro-surgical unit when the high-frequency endotherapy device or electrically active portion is in contact with the distal end of endoscope. Thermal injury to a patient or endoscope failure may occur.
 - Do not apply the current under the circumstance that patient's clothing is wet when performing high-frequency treatment. Doing so may cause thermal injury.
- (1) Prepare, inspect and connect the electro-surgical unit and high-frequency endotherapy device as per instructions provided in respective manuals.
 - (2) Perform high-frequency treatment as per instructions provided in the manual of the electro-surgical unit and high-frequency endotherapy device.

5.6 Endoscope Withdrawal

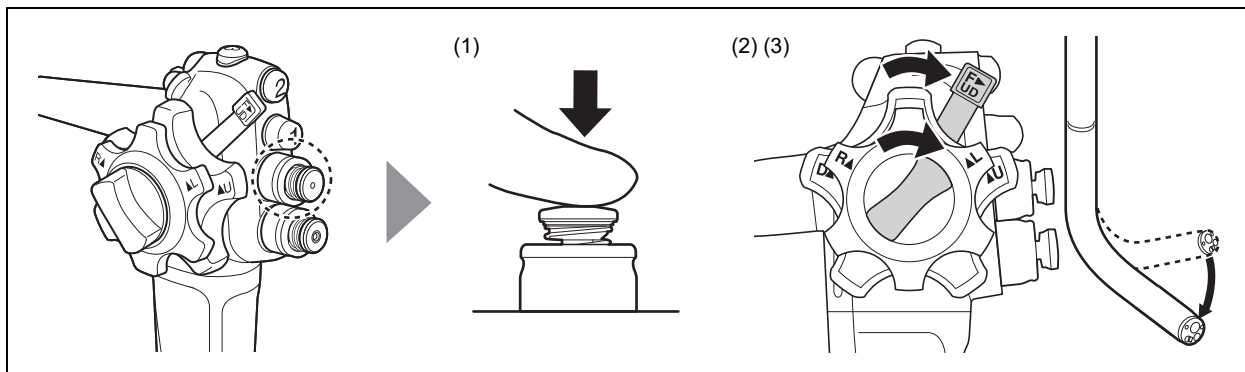

WARNING

- Unless the endoscope's bending section is in a neutral position (essentially "straight"), do not withdraw the endoscope whenever the endoscopic image is compromised, unclear, blurry, etc. due to any reason or condition including loss of image, power interruption, water droplets or dirt/debris adhering to the objective lens, etc. Doing so may cause injury to tissues in the body cavity, bleeding and/or perforation.

- (1) Prior to withdrawal, press the suction valve to apply suction to remove insufflated air (or CO₂ gas) from the body.
- (2) Prior to withdrawal, operate the up/down and left/right angulation locks in the direction of F (Free) until they stop.
- (3) Prior to withdrawal, operate the up/down and left/right angulation knobs to straighten the bending section to its neutral position.
- (4) Slowly withdraw the endoscope under constant visualization.
- (5) Turn off the light of the processor (light source).

5.7 Reprocessing Endoscope

After withdrawing the endoscope and discarding single-use components/accessories consistent with manufacturers' recommendations, reprocess the endoscope and its accessories as per instructions provided in the Reprocessing Manual.

→ Reprocessing Manual

WARNING

- Immediately upon completion of the procedure, it is imperative that pre-cleaning is performed as per instructions provided in the Reprocessing Manual. Otherwise, residual organic debris may begin to dry and solidify and hinder effective removal and reprocessing, causing infection.

This chapter describes actions which should be taken if problems occur while inspecting or using the endoscope.

If any abnormality is found during inspection, take appropriate measures by following the instructions described in “6.1 Troubleshooting.”

If the problem persists even after following troubleshooting chart in “6.1 Troubleshooting”, consult your local FUJIFILM dealer and return the product for evaluation and/or repair according to “6.4 Returning Endoscope for Repair.”

If any abnormality occurs during a procedure, immediately stop using the product and withdraw the endoscope from the patient according to “6.2 Withdrawal of Endoscope with Abnormality.”

WARNING

- Make sure to inspect the endoscope and accessories before use according to the procedures provided in this manual. Do not use the equipment that shows any signs of abnormality or irregularity. Use of abnormal equipment may lead to misdiagnosis or increase risks to patient safety.
- If any abnormality occurs during use, carry out safety checks such as checking the patient's condition and discontinue use immediately. Not doing so may seriously affect patient safety.

Note

- Accessories including but not limited to air/water valves, suction valves, forceps valves, cleaning brushes, cleaning adapters, hoods, J tubes, etc. are consumable items. If any deterioration or abnormality is found in accessories, they need to be replaced.

6.1 Troubleshooting

6.1.1 Problem with Displayed Images

Problem	Cause	Remedy
No images	The cart, monitor or processor (or light source) is unplugged from the outlet.	Plug the cart, monitor or processor (or light source) into the main outlet.
	The cart, monitor or processor (or light source) is OFF.	Power ON the cart, monitor or processor (or light source).
	The endoscope is not connected correctly to the processor.	Connect the endoscope properly to the processor. → “4.6 Connecting Endoscope to Processor (Light Source) and Related Equipment”
	Foreign substances such as metallic fragments adhere to the power-receiving section of the scope connector.	Wipe off foreign substances with soft, sterile gauze moistened with alcohol.
Dark image ^{*1}	The endoscope is not connected to the processor (light source) correctly.	Connect the endoscope to the processor (light source) correctly. → “4.6 Connecting Endoscope to Processor (Light Source) and Related Equipment”
	The brightness level is set around “MIN.”	Set the brightness level around 0. → Operation manual of the processor (light source)
	The iris mode is set to “PEAK.”	Set iris mode to “AVE.” → Operation manual of the processor (or light source)
	Moisture or foreign matter (such as dust, gauze fibers, metallic fragments) adheres to the light guide cover glass of the scope connector.	Wipe off foreign matter on the light guide cover glass of the scope connector with soft, sterile gauze moistened with alcohol.
	Moisture or foreign matter (such as dust, gauze fibers, metallic fragments) adheres to the objective lens or light guide.	Wipe off foreign matter on the objective lens or light guides with soft, sterile gauze moistened with alcohol.
Halation	The brightness level is set around “MAX.”	Set the brightness level around 0. → Operation manual of the processor (light source)
	The iris mode is set to “AVE.”	Set iris mode to “PEAK.” → Operation manual of the processor (or light source)

*1 When argon plasma coagulation (APC) is performed, some areas in the live image may become dark due to luminous beam of argon plasma.

Problem	Cause	Remedy
Distorted image	High-frequency interference.	Stop power supply to the high-frequency endotherapy device to restore image output. The endoscope is working properly.
	The endoscope is not connected correctly to the processor (light source).	Connect the endoscope properly to the processor (light source). → “4.6 Connecting Endoscope to Processor (Light Source) and Related Equipment”

6.1.2 Problem with Scope Switch

Problem	Cause	Remedy
The intended function is not executed even if the scope switch is pressed.	The intended function is not assigned to the scope switch.	Assign the function to the scope switch as per instructions provided in the Operation Manual of the processor. → Operation Manual of the processor

6.1.3 Problem with Bending Section

Problem	Cause	Remedy
Bending section cannot return to neutral position.	The up/down and left/right angulation knobs are locked.	Turn the up/down and left/right angulation locks in the direction of F (Free) until they stop to unlock the up/down and left/right angulation knobs.

6.1.4 Problem with Air/Water Supply

Problem	Cause	Remedy
No air/water supply	The operation of the air pump in the processor (light source) is set to off.	Select the operation of the air pump from among "H" (high), "M" (middle) and "L" (low) by following the instructions described in the operation manual of the processor (light source). → Operation manual of the processor (light source)
	The air/water valve has an abnormality.	Replace with a reprocessed spare air/water valve.
	The air/water valve is not pressed firmly when supplying water.	Press the air/water valve firmly.
	Water tank cap is loose.	Close the cap firmly.
	Water tank is filled with too much sterile water.	Reduce the water level in the water tank to about 80% of its capacity.
	Water tank is empty.	Fill the water tank with sterile water.
	Water tank is not connected.	Connect the water tank.
	Clogged air/water nozzle or air/water channel.	Reprocess the air/water nozzle or air/water channel according to the instructions given in the Reprocessing Manual.
Low air/water supply amount	Foreign matters have adhered to the air/water channel.	Reprocess the air/water channel according to the instructions given in the Reprocessing Manual.
	The rubber seals of the air/water valve are damaged.	Replace with a reprocessed spare air/water valve. The rubber seals may be able to be repaired. For details on repair, contact your local FUJIFILM dealer.
Air/water supply does not stop.	Foreign matters have adhered to the air/water valve.	Reprocess the air/water valve according to the instructions given in the Reprocessing Manual.
	The air/water valve is damaged.	Replace with a reprocessed spare air/water valve.
	The air/water valve has been degraded.	Replace with a reprocessed spare air/water valve.
	The rubber seals of the air/water valve are damaged.	Replace with a reprocessed spare air/water valve. The rubber seals may be able to be repaired. For details on repair, contact your local FUJIFILM dealer.
Operation of the air/water valve is heavy.	The friction resistance between the air/water valve and the air/water valve cylinder has increased.	Detach the air/water valve and moisten the rubber seal with sterile water.

6.1.5 Problem with Suction

Problem	Cause	Remedy
No suction	Suction unit is switched off.	Switch on the suction unit.
	Suction unit is not connected.	Connect the suction unit.
	No forceps valve is attached.	Attach a forceps valve.
Low suction volume	The suction valve has been damaged.	Replace with a reprocessed spare suction valve.
	The forceps valve has been damaged.	Replace with a new reprocessed forceps valve.
	The suction tube is not attached properly.	Reattach the suction tube.
	The forceps valve is not attached properly.	Attach the forceps valve properly and close the lid.
	The water jet inlet cap is open.	Close the water jet inlet cap to block the water jet inlet.
Suction valve does not return to the original position.	Solid materials or thick fluids have adhered to the suction valve.	Detach the suction tube from the suction unit. Detach the suction valve and replace with a reprocessed spare suction valve.
	Suction valve is damaged.	Replace with a reprocessed spare suction valve.
Suction valve cannot be detached.	The suction valve or the control portion of the endoscope has been damaged.	Contact your local FUJIFILM dealer.
Fluid leaks from forceps valve during suction.	The forceps valve is not attached correctly.	Attach the forceps valve properly and close the lid.
	The forceps valve is damaged.	Replace with a new reprocessed forceps valve.

6.1.6 Problem with Water Jet Function

Problem	Cause	Remedy
No sterile water comes out of water jet nozzle.	J tube or water jet channel is clogged with foreign matter.	Reprocess the J tube or water jet channel according to the instructions given in the Reprocessing Manual.
	J tube is not connected.	Connect J tube.
	J tube is damaged.	Replace with a reprocessed spare J tube.
	Water pump does not work correctly.	Re-check all components of the water pump per manufacturer's instructions.

6.1.7 Problem with Related Equipment

◆ Problem with Endotherapy Devices

Problem	Cause	Remedy
Endotherapy device cannot be inserted.	The endotherapy device (such as biopsy forceps) is left open.	Close the endotherapy device for insertion.
	The handle of endotherapy device (such as biopsy forceps) is held firmly.	Loosen the grip to insert the endotherapy device.
	The endotherapy device has difficulty being inserted due to bending.	Reduce the angle of the bending section slightly and then insert it.
	The endotherapy device has an abnormality.	Withdraw the endotherapy device and replace it with a new one.
	An endotherapy device which is not compatible with this product is used.	Use an endotherapy device compatible with this product.
Endotherapy device cannot be withdrawn.	The endotherapy device (such as biopsy forceps) is left open.	Close the endotherapy device and pull it out from the endoscope.
	The handle of the endotherapy device (such as biopsy forceps) is held firmly.	Loosen the grip and pull out the endotherapy device from the endoscope.
	The endotherapy device has difficulty being pulled out due to bending.	Reduce the angle of the bending section slightly and then pull out the endotherapy device from the endoscope.
	An abnormality occurs in the endotherapy device.	Withdraw the tip of the endotherapy device to the instrument channel outlet of the endoscope, and then slowly pull out the endoscope and endotherapy device together.
	An endotherapy device which is not compatible with this product is used.	Withdraw the tip of the endotherapy device to the instrument channel outlet of the endoscope, and then slowly pull out the endoscope and endotherapy device together.

◆ Problem with Image Recorder

Problem	Cause	Remedy
Images cannot be captured on image recorder.	Image recorder is not connected.	Connect the image recorder.
	Image recorder is not connected properly.	Connect the image recorder correctly.

6.2 Withdrawal of Endoscope with Abnormality

When the endoscope needs to be withdrawn due to an abnormality during a procedure, take appropriate measures as described in either “6.2.1 When Endoscopic Images Appear on the Monitor”, “6.2.2 When Either Normal Observation Mode or Special Light Observation Mode is Not Available” or “6.2.3 When Endoscopic Images Do Not Appear on the Monitor or a Frozen Image Cannot be Restored.”

If abnormalities of the withdrawn endoscope are not described in “6.3 Handling of Endoscope with Abnormality”, contact your local FUJIFILM dealer and return the endoscope for repair as described in “6.4 Returning Endoscope for Repair.”

In addition, if the endoscope cannot be withdrawn smoothly, do not withdraw the endoscope forcibly and consult your local FUJIFILM dealer.

WARNING

- If an abnormality occurs during a treatment, stop the treatment immediately and slowly pull out the endotherapy device from the endoscope. If the endotherapy device cannot be pulled out from the endoscope, withdraw the tip of the endotherapy device to the instrument channel outlet of the endoscope, and then slowly pull out the endoscope and endotherapy device together. If the treatment is not stopped or the endotherapy device is forcibly pulled out, it may cause injury to tissues in the patient’s body cavity, bleeding and/or perforation.
- During a procedure, if any abnormality (loss of image, dark image, bright image, etc.) is found in the endoscopic image, the imaging section may have malfunctioned. If this happens, stop the treatment immediately and slowly pull out the endoscope. If the endoscope is used as it is, it may cause overheating of the distal end, possibly resulting in mucosal burns or other injury.

Note

- Use spare or back-up equipment to complete the procedure as necessary.

6.2.1 When Endoscopic Images Appear on the Monitor

- (1) Turn off all related equipment except the processor (processor, light source), monitor, and suction pump.
- (2) When the image is displayed in special light observation mode, switch to normal observation mode before withdrawing the endoscope.
- (3) When using an endotherapy device, slowly withdraw the endotherapy device from the endoscope.
- (4) Aspirate accumulated air (or CO₂ gas) by pressing the suction valve.
- (5) Turn the up/down and left/right angulation locks in the direction of F (Free) until they stop to unlock the up/down and left/right angulation knobs.
- (6) Operate the up/down and left/right angulation knobs to straighten the bending section before withdrawing the endoscope.
- (7) Slowly withdraw the endoscope.

6.2.2 When Either Normal Observation Mode or Special Light Observation Mode is Not Available

- (1) Turn off all related equipment except the processor (processor, light source), monitor, and suction pump.
- (2) Operate the processor to switch to available observation mode.
- (3) When using an endotherapy device, slowly withdraw the endotherapy device from the endoscope.
- (4) Aspirate accumulated air (or CO₂ gas) by pressing the suction valve.
- (5) Turn the up/down and left/right angulation locks in the direction of F (Free) until they stop to unlock the up/down and left/right angulation knobs.
- (6) Operate the up/down and left/right angulation knobs to straighten the bending section.
- (7) Slowly withdraw the endoscope.

6.2.3 When Endoscopic Images Do Not Appear on the Monitor or a Frozen Image Cannot be Restored

- (1) Turn off the processor (processor, light source), monitor, suction pump and other related equipment.
- (2) When using an endotherapy device, slowly withdraw the endotherapy device from the endoscope.
- (3) Turn the up/down and left/right angulation locks in the direction of F (Free) until they stop to unlock the up/down and left/right angulation knobs.
- (4) Operate the up/down and left/right angulation knobs to straighten the bending section and release one's hand from the up/down and left/right angulation knobs.
- (5) Slowly withdraw the endoscope.

6.3 Handling of Endoscope with Abnormality

If the problem persists even after following “6.3.1 When Suction Valve Does Not Return to Its Original Position”, contact your local FUJIFILM dealer.

6.3.1 When Suction Valve Does Not Return to Its Original Position

WARNING

- If it is necessary to supply air or water from the suction connector when an abnormality is found in the suction valve during a procedure, do so while pressing the suction valve. If air or water is supplied without pressing the suction valve, body fluids may leak or splash from the suction valve, posing an infection control risk.

- (1) Turn off all related equipment except the processor (processor, light source), monitor, and suction pump.
- (2) When the image is displayed in special light observation mode, switch to normal observation mode before withdrawing the endoscope.
- (3) When using an endotherapy device, slowly withdraw the endotherapy device from the endoscope.
- (4) Aspirate accumulated air (or CO₂ gas) by pressing the suction valve.
- (5) Turn off the suction pump.
- (6) Turn the up/down and left/right angulation locks in the direction of F (Free) until they stop to unlock the up/down and left/right angulation knobs.
- (7) Operate the up/down and left/right angulation knobs to straighten the bending section before withdrawing the endoscope.
- (8) Slowly withdraw the endoscope.
- (9) Prepare the reprocessed injection tube and two clean basins filled with sterile water.
- (10) Straighten the insertion portion of the endoscope, and immerse the distal end in a clean basin filled with sterile water.
- (11) Disconnect the suction tube from the suction connector on the scope connector.
- (12) Attach the tube for instrument/suction channel of the injection tube to the suction connector on the scope connector.
- (13) Immerse the weight of the injection tube in the other clean basin filled with sterile water.
- (14) Attach a sterile syringe to the suction channel side of the injection tube and aspirate sterile water with the syringe. While pressing the suction valve, flush sterile water into the instrument/suction channel until the solid materials clogging the channel are removed.
- (15) Remove the weight of the injection tube from the clean basin filled with sterile water.
- (16) Aspirate air with the syringe. While pressing the suction valve, inject air into instrument/suction channel until the sterile water inside the channel is discharged completely.
- (17) Detach the sterile syringe from the suction channel side of the injection tube.

- (18)** Detach the tube for instrument/suction channel of the injection tube from the suction connector on the scope connector.
- (19)** Inspect the endoscope to check that it is free from abnormalities.
 - ➔ “Chapter 4 Preparation and Inspection”

6.4 Returning Endoscope for Repair

When returning the endoscope, provide a detailed description of the concern, malfunction or device failure.

→ “Chapter 7 Service”

WARNING

- Contact your local FUJIFILM dealer when this product is returned for repair. Be sure to reprocess this product before returning for repair. If a product which is not reprocessed is returned, it can create a risk of infection to users, service personnel or other persons in contact with it.

CAUTION

- When transporting the endoscope to the outside of the hospital, store the endoscope in a FUJIFILM-specified carrying case. Not doing so may cause product failure.

Chapter 7 Service

This chapter explains the services regarding this product.

7.1 Service

If this product does not work properly, check it first by reading this manual again and follow all instructions and troubleshooting tips.

If this product is still not working well, contact your local FUJIFILM dealer.

7.2 After-Sales Service

Contact your local FUJIFILM dealer when this product is returned for repair.

Be sure to clean and disinfect (or sterilize) this product before returning for repair.

The product which is not cleaned and disinfected (or sterilized) may increase infection control risks to users, service personnel or other persons in contact with it.

When contacting your local FUJIFILM dealer, provide the following information.

Model name :

Serial number :

Description of failure : Provide as much details as possible:

Date of purchase :

Reprocessing method (Automated Endoscope Reprocessor, disinfectant solution, etc.):

◆ Repairs during the warranty period

This product will be repaired free of charge within warranty guidelines.

The warranty period for the endoscope, excluding accessories, is one year after date of purchase.

Note that the warranty is void in the following cases:

- Damage caused by fire or natural disaster such as storms or floods.
- Problem caused by careless handling or misuse including use of non-compatible reprocessing systems or agents.
- Malfunctions or damages due to products of other manufacturers not supplied by FUJIFILM.
- Remodeling, maintenance, and repair using repair parts other than those specified by FUJIFILM.

◆ Repairs after the warranty period

This product will be repaired with charge at your request.

Appendix

This chapter describes main specifications, related equipment used in combination with this product, electromagnetic compatibility (EMC), etc.

Main Specification

◆ Classification of Medical Electrical Equipment

1. Type of protection against electric shock:
Class I equipment (power supply: protected ground fault receptacle)
2. Degree of protection against electric shock:
Type BF applied part
3. Degree of explosion protection:
Use is prohibited in an oxygen-rich environment or in a flammable gas atmosphere.

Note

- Use in combination with EP-6000 or with VP-7000 and BL-7000.

◆ Electromagnetic Compatibility (EMC) Related Standard

This product has been tested and confirmed to comply with the limits for medical devices defined in EN 60601-1-2:2015.

These limits are designed to provide reasonable protection against harmful electromagnetic interference in a typical installation at professional healthcare facilities such as hospitals and clinics.

There is no guarantee that interference will not occur in a particular installation.

◆ Applied Part

Insertion portion

◆ Specifications

<Upper Gastrointestinal Endoscope>

	EG-720R
Optical system:	
Viewing direction	0° (Forward)
Field of view	140°
Observation range (mm)	2 to 100
Method of illumination	Light guide method
Image size	Super image
Distal end diameter (mm)	9.2
Insertion tube diameter (mm)	9.3
Maximum diameter of insertion portion (mm)	11.4
Minimum diameter of instrument channel (mm) *1	2.8
Bending capability:	
Up/Down	210°/90°
Left/Right	100°/100°
Working length (mm) *2	1100
Total length (mm)	1400
Insertion route	Peroral
Power-reception frequency	110 to 205 kHz
Laser	
Class	Class 1 laser product *3 *4
Medium	Semiconductor laser
Wavelength (nm)	1310
Maximum output (mW)	7
Maximum output under Fault condition (mW)	12.3
Beam divergence (parallel)	11° (Type)
Beam divergence (perpendicular)	11° (Type)
LED class	Class 1 LED product *5 *6

*1 Channel size should not be used as the sole consideration for compatibility of an accessory.

*2 Use an endotherapy device with working length of 1600 mm or longer.

*3 This product conforms to IEC 60825-1:1993+A1:1997+A2:2001, IEC 60825-1:2007 and IEC 60825-1:2014.

*4 The transmission window of the scope connector falls under the category of Class 1 laser product.

→ “2.2 Nomenclature and Functions of Endoscope - 7. Transmission Window”

*5 This product conforms to IEC 60825-1:1993+A1:1997+A2:2001.

*6 The communication window of the scope connector falls under the category of Class 1 LED product.

→ “2.2 Nomenclature and Functions of Endoscope - 8. Communication Window”

<Lower Gastrointestinal Endoscope>

	EC-720R/M EC-720R/I EC-720R/L
Optical system:	
Viewing direction	0° (Forward)
Field of view	170°
Observation range (mm)	2 to 100
Method of illumination	Light guide method
Image size	Super image
Distal end diameter (mm)	12.8
Insertion tube diameter (mm)	12.8
Maximum diameter of insertion portion (mm)	14.3
Minimum diameter of instrument channel (mm) ^{*1}	3.8
Bending capability:	
Up/Down	180°/180°
Left/Right	160°/160°
Working length (mm) ^{*2}	EC-720R/M: 1330 EC-720R/I: 1520 EC-720R/L: 1690
Total length (mm)	EC-720R/M: 1630 EC-720R/I: 1820 EC-720R/L: 1990
Insertion route	Transanal
Power-reception frequency	110 to 205 kHz
Laser	
Class	Class 1 laser product ^{*3 *4}
Medium	Semiconductor laser
Wavelength (nm)	1310
Maximum output (mW)	7
Maximum output under Fault condition (mW)	12.3
Beam divergence (parallel)	11° (Type)
Beam divergence (perpendicular)	11° (Type)
LED class	Class 1 LED product ^{*5 *6}

*1 Channel size should not be used as the sole consideration for compatibility of an accessory.

- *2 For EC-720R/M, use an endotherapy device with working length of 1800 mm or longer.
For EC-720R/I and EC-720R/L, use an endotherapy device with working length of 2000 mm or longer.
- *3 This product conforms to IEC 60825-1:1993+A1:1997+A2:2001, IEC 60825-1:2007 and IEC 60825-1:2014.
- *4 The transmission window of the scope connector falls under the category of Class 1 laser product.
 - ➔ “2.2 Nomenclature and Functions of Endoscope - 7. Transmission Window”
- *5 This product conforms to IEC 60825-1:1993+A1:1997+A2:2001.
- *6 The communication window of the scope connector falls under the category of Class 1 LED product.
 - ➔ “2.2 Nomenclature and Functions of Endoscope - 8. Communication Window”

Operating Environment, Transport Environment and Storage Environment

◆ Operating Environment

Temperature	+10 to +40°C
Humidity	30 to 85%RH (no dew condensation)
Pressure	70 to 106 kPa (within range of atmospheric pressure)

◆ Transport Environment

Temperature	-20 to +60°C
Humidity	10 to 85%RH (no dew condensation)
Pressure	70 to 106 kPa (within range of atmospheric pressure)

◆ Storage Environment

Temperature	-20 to +60°C
Humidity	10 to 85%RH (no dew condensation)
Pressure	70 to 106 kPa (within range of atmospheric pressure)

◆ Term of Validity/Period for Use (Durability)

The term of validity (durability) is 6 years ^{*1} from first use of the endoscope, providing that the endoscope undergoes periodic servicing. "Based on our company's criteria"

*1 Except consumable supplies

Accessories

Accessories in the following tables are items whose life expectancy is limited and will require replacement once they show signs of wear or irregularity. Such accessories cannot be repaired or refurbished and should be replaced after any irregularity is observed.

◆ Accessories Common to All Models

Name	Model
Forceps valve	FOV-DV7*1
Air/water valve	AW-603
Suction valve	SB-605
Suction channel brush	WB7024FW
Cylinder/inlet brush	WB11003FW
Cleaning adapter	CA-610 CA-613
Air/water channel cleaning adapter	CA-611
Ventilation adapter	AD-7

*1 Single use item

◆ Accessories for Endoscopes with Specific Functions

<Optional Accessory for Endoscopes with Water Jet Function>

Name	Model
J tube	JT-500

Related Equipment Used in Combination

Note

- In addition to the devices described here, new products that can be used in combination with this product may be added. Note that the devices described here may have already been discontinued. For details on the devices used in combination with this product, contact your local FUJIFILM dealer.

◆ Compatible Processor and Light Source

Name	Model
Processor	EP-6000 ^{*1} VP-7000 ^{*2}
Light source	BL-7000 ^{*3}

*1 The system version must be V1.7 or later.

*2 The system version must be Ver.1.022 or later.

*3 The software version must be Ver.1.16 or later.

Note

- For details on the monitors, printers and video recorders that can be used in combination with this product, refer to the operation manual of the processor (and light source).

◆ Water Tank

Name	Model
Water tank	WT-603

◆ Suction Unit

Use a suction unit which complies with EN 60601-1 (IEC 60601-1) and can set suction pressure to 40 to 53 kPa.

Note

- For details on the suction unit that can be used in combination with this product, refer to the operation manual of the suction unit.

◆ Endoscopic CO₂ Regulator and Accessories

Name	Model
Endoscopic CO ₂ regulator	GW-100
Water tank	WT-604G
Gas/water valve	AW-604G

◆ **Water Pump**

Name	Model
Water Pump	JW-2

◆ **Electrosurgical Unit**

Use an electrosurgical unit which complies with EN 60601-2-2 (IEC 60601-2-2).

Note

- For details on the electrosurgical unit that can be used in combination with this product, refer to the operation manual of the diathermic slitter.

◆ **Ultrasonic Processor**

Name	Model
Ultrasonic processor	SP-900

Note

- For details on the probes that can be used in combination with this product, refer to the operation manual of the SP-900.

◆ **Mouthpiece**

<Upper Gastrointestinal Endoscope>

Name	Model
Mouthpiece	MPC-ST

◆ **Hood**

<Lower Gastrointestinal Endoscope>

	Model
Hood	DH-30CR

◆ Compatible Endotherapy Devices

Endotherapy devices have a use-by date. If any deterioration or abnormality is found in them, they need to be replaced. Endotherapy devices cannot be repaired or refurbished. Thus, if any abnormality is found, replace with a new one.

Note

- For the combination of endotherapy devices other than those described in this manual, consult your local FUJIFILM dealer.

<Upper Gastrointestinal Endoscope>

	EG-720R
Disposable diathermic slitter	DK2618J -B15- DK2618J -B20- DK2618J -B25- DK2618J -B30- DK2618J -N10- DK2618J -N15- DK2618J -N20- DK2618J -N25- DK2618J -N30- DP2618DT -35- DP2618DT -50-

<Lower Gastrointestinal Endoscope>

	EC-720R/M	EC-720R/I	EC-720R/L
Disposable diathermic slitter	DK2618J -B15- DK2618J -B20- DK2618J -B25- DK2618J -B30- DK2618J -N10- DK2618J -N15- DK2618J -N20- DK2618J -N25- DK2618J -N30- DP2618DT -35- DP2618DT -50-	DK2623J -B15- DK2623J -B20- DK2623J -N15- DK2623J -N20-	DK2623J -B15- DK2623J -B20- DK2623J -N15- DK2623J -N20-

◆ Medical Device Directive

This product complies with the requirements of
European Directive 93/42/EEC.
Classification : Class II a



Electromagnetic Compatibility (EMC) Information

Medical electronic equipment requires special care with regards to EMC. This product must be installed and used according to the EMC information provided in Table 1 through Table 4 if both this product and the processor and light source ^{*1}, which are used in combination, comply with the requirements of EN 60601-1-2:2015 or that provided in Table 5 through Table 8 if the processor and light source ^{*1} comply with the requirements of EN 60601-1-2:2007.

*1 Refer to the operation manual of the processor and light source.

<Electromagnetic emission compliance information and guidance>

Table 1

Guidance and Manufacturer Declaration - Electromagnetic Emission -		
This device is intended for use in the following prescribed electromagnetic environments. Customers and users of this product are advised to check that it is being used in such environments.		
Emission standard	Compliance	Guidance
RF emissions CISPR 11/EN 55011	Group I	This product uses RF (Radio Frequency) energy only for its internal function. Therefore, its RF emissions are very low and are not likely to cause any interference in nearby electric equipment.
Radiated emissions CISPR 11/EN 55011	Class B	This product is suitable for use in all establishments, including domestic establishments and those directly connected to the public low-voltage power supply network that supplies buildings used for domestic purposes.
Harmonic emissions IEC/EN 61000-3-2	Class A	
Voltage fluctuations/ flicker emissions IEC/EN 61000-3-3	Applicable	

<Electromagnetic Immunity Compliance Information and Guidance>

Table 2

Guidance and Manufacturer Declaration - Electromagnetic Immunity -			
This device is intended for use in the following prescribed electromagnetic environments. Customers and users of this product are advised to check that it is being used in such environments.			
Immunity test	IEC 60601 Test level	Compliance level	Guidance
Electrostatic discharge (ESD) IEC/EN 61000-4-2	Distal end: ±6 kV contact ±2 kV, ±4 kV, ±8 kV air Other parts: ±8 kV contact ±2 kV, ±4 kV, ±8 kV, ±15 kV air	Distal end: ±6 kV contact ±2 kV, ±4 kV, ±8 kV air Other parts: ±8 kV contact ±2 kV, ±4 kV, ±8 kV, ±15 kV air	Floors should be wood, concrete, or ceramic tile. If floors are covered with synthetic material, the relative humidity should be at least 30%.
Electrical fast transient/burst IEC/EN 61000-4-4	±2 kV for power supply lines ±1 kV for input/output lines	±2 kV for power supply lines ±1 kV for input/output lines	Main power quality should be that of a typical commercial or hospital environment.
Surge IEC/EN 61000-4-5	±0.5 kV, ±1.0 kV line to line ±0.5 kV, ±1.0 kV, ±2.0 kV line to earth	±0.5 kV, ±1.0 kV line to line ±0.5 kV, ±1.0 kV, ±2.0 kV line to earth	Main power quality should be that of a typical commercial or hospital environment.
Voltage dips, short interruptions and voltage variations on power supply input lines IEC/EN 61000-4-11	0% U_T for 0.5 cycles and 1 cycles 70% U_T for 0.5 second 0% U_T for 5 seconds	0% U_T for 0.5 cycles and 1 cycles 70% U_T for 0.5 second 0% U_T for 5 seconds	Main power quality should be that of a typical commercial or hospital environment. If the user of this product requires continued operation during power mains interruptions, it is recommended that this product is powered from an uninterruptible power supply or battery.
Power frequency (50/60 Hz) magnetic field IEC/EN 61000-4-8	30 A/m	30 A/m	The power frequency magnetic field should have the same level of characteristics as a common location in standard business and hospital environments.

Note

- U_T is the a.c. mains voltage prior to application of the test level.

<Portable and Mobile RF Communications Equipment Compliance Information and Guidance>

Table 3

Guidance and Manufacturer Declaration - Electromagnetic Immunity -

This device is intended for use in the following prescribed electromagnetic environments. Customers and users of this product are advised to check that it is being used in such environments.

Immunity test	IEC 60601 Test level	Compliance level	Guidance
Conducted RF IEC/EN 61000-4-6	3 Vrms 150 kHz to 80 MHz 6 Vrms ISM Frequency Band ^c	3 Vrms 150 kHz to 80 MHz 6 Vrms ISM Frequency Band ^c	Portable and mobile RF communications equipment should be used no closer to any part of this product, including cables, than the recommended separation distance calculated from the equation applicable to the frequency of the transmitter. Recommended separation distance $d = 1.2 \sqrt{P}$
Radiated RF IEC/EN 61000-4-3	3 V/m 80 MHz to 2.7 GHz	3 V/m	$d = 1.2 \sqrt{P}$ 80 MHz to 800 MHz $d = 2.3 \sqrt{P}$ 800 MHz to 2.7 GHz Where "P" is the maximum output power rating of the transmitter in watts (W) according to the transmitter manufacturer and "d" is the recommended separation distance in metres (m). The electric field intensity from a fixed RF transmitter determined by an electromagnetic field study ^a should be lower than the compliance level in each frequency range ^b . Interference may occur near devices that display the following symbol. 

Immunity test	IEC 60601 Test level	Compliance level	Guidance
Immunity to proximity fields from RF wireless communications equipment IEC/EN 61000-4-3	380 - 390 MHz, 27 V/m 430 - 470 MHz, 28 V/m 704 - 787 MHz, 9 V/m 800 - 960 MHz, 28 V/m 1422 - 1512 MHz, 10 V/m 1700 - 1990 MHz, 28 V/m 2400 - 2570 MHz, 28 V/m 3480 - 3600 MHz, 10 V/m 5100 - 5800 MHz, 9 V/m	380 - 390 MHz, 27 V/m 430 - 470 MHz, 28 V/m 704 - 787 MHz, 9 V/m 800 - 960 MHz, 28 V/m 1422 - 1512 MHz, 10 V/m 1700 - 1990 MHz, 28 V/m 2400 - 2570 MHz, 28 V/m 3480 - 3600 MHz, 10 V/m 5100 - 5800 MHz, 9 V/m	Degradation of the performance of this product could result if portable RF communications equipment is used closer than 30 cm to any part of this product.

Note

- At 80 MHz and 800 MHz, the higher frequency range applies.
- These guidelines may not apply in all situations. Electromagnetic propagation is affected by absorption and reflection from structures, objects and people.

a. Field strengths from fixed transmitters, such as base stations for radio (cellular/cordless) telephones and land mobile radios, amateur radio, AM and FM radio broadcast and TV broadcast cannot be predicted theoretically with accuracy. To assess the electromagnetic environment due to fixed RF transmitters, an electromagnetic site survey should be considered. If the measured field strength in the location in which this product is used exceeds the applicable RF compliance level above, this product should be observed to verify normal operation. If abnormal performance is observed, additional measures may be necessary, such as re-orienting or relocating this product.

b. Over the frequency range 150 kHz to 80 MHz, field strengths should be less than 3 V/m.

c. Frequency bands of 6.765 MHz to 6.795 MHz, 13.553 MHz to 13.567 MHz, 26.957 MHz to 27.283 MHz, or 40.66 MHz to 40.70 MHz

<Recommended Separation Distance Between Portable and Mobile RF Communications Equipment and this Product>

Table 4

Recommended separation distance between portable and mobile RF communications equipment and this product.

This product is intended for use in an electromagnetic environment in which radiated RF disturbances are controlled. The customer or the user of this product can help prevent electromagnetic interference by maintaining a minimum distance between portable and mobile RF communications equipment (transmitters) and this product as recommended below, according to the maximum output power of the communications equipment.

Rated maximum output power of transmitter P (W)	Separation distance related to frequency of the transmitter (m)		
	150 kHz to 80 MHz $d = 1.2 \sqrt{P}$	80 MHz to 800 MHz $d = 1.2 \sqrt{P}$	800 MHz to 2.7 GHz $d = 2.3 \sqrt{P}$
0.01	0.12	0.12	0.23
0.1	0.38	0.38	0.73
1	1.2	1.2	2.3
10	3.8	3.8	7.3
100	12	12	23

For transmitters rated at a maximum output power not listed above, the recommended separation distance d in metres (m) can be estimated using the equation applicable to the frequency of the transmitter, where P is the maximum output power rating of the transmitter in watts (W) according to the transmitter manufacturer.

Note

- At 80 MHz and 800 MHz, the separation distance for the higher frequency range applies.
- These guidelines may not apply in all situations. Electromagnetic propagation is affected by absorption and reflection from structures, objects and people.

<Electromagnetic emission compliance information and guidance>

Table 5

Guidance and Manufacturer Declaration - Electromagnetic Emission -		
This device is intended for use in the following prescribed electromagnetic environments. Customers and users of this product are advised to check that it is being used in such environments.		
Emission standard	Compliance	Guidance
RF emissions CISPR 11/EN 55011	Group I	This product uses RF (Radio Frequency) energy only for its internal function. Therefore, its RF emissions are very low and are not likely to cause any interference in nearby electric equipment.
Radiated emissions CISPR 11/EN 55011	Class B	This product is suitable for use in all establishments, including domestic establishments and those directly connected to the public low-voltage power supply network that supplies buildings used for domestic purposes.
Harmonic emissions IEC/EN 61000-3-2	Class A	
Voltage fluctuations/flicker emissions IEC/EN 61000-3-3	Applicable	

<Electromagnetic Immunity Compliance Information and Guidance>

Table 6

Guidance and Manufacturer Declaration - Electromagnetic Immunity -			
This device is intended for use in the following prescribed electromagnetic environments. Customers and users of this product are advised to check that it is being used in such environments.			
Immunity test	IEC 60601 Test level	Compliance level	Guidance
Electrostatic discharge (ESD) IEC/EN 61000-4-2	±2 kV contact ±4 kV contact ±6 kV contact ±2 kV air ±4 kV air ±8 kV air	±2 kV contact ±4 kV contact ±6 kV contact ±2 kV air ±4 kV air ±8 kV air	Floors should be wood, concrete, or ceramic tile. If floors are covered with synthetic material, the relative humidity should be at least 30%.
Electrical fast transient/burst IEC/EN 61000-4-4	±2 kV for power supply lines ±1 kV for input/output lines	±2 kV for power supply lines ±1 kV for input/output lines	Main power quality should be that of a typical commercial or hospital environment.
Surge IEC/EN 61000-4-5	±0.5 kV, ±1.0 kV line to line ±0.5 kV, ±1.0 kV, ±2.0 kV line to earth	±0.5 kV, ±1.0 kV line to line ±0.5 kV, ±1.0 kV, ±2.0 kV line to earth	Main power quality should be that of a typical commercial or hospital environment.
Voltage dips, short interruptions and voltage variations on power supply input lines IEC/EN 61000-4-11	<5% U_T (>95% dip in U_T) for 0.5 cycle 40% U_T (60% dip in U_T) for 5 cycles 70% U_T (30% dip in U_T) for 25 cycles <5% U_T (>95% dip in U_T) for 5 s	<5% U_T (>95% dip in U_T) for 0.5 cycle 40% U_T (60% dip in U_T) for 5 cycles 70% U_T (30% dip in U_T) for 25 cycles <5% U_T (>95% dip in U_T) for 5 s	Main power quality should be that of a typical commercial or hospital environment. If the user of this product requires continued operation during power mains interruptions, it is recommended that this product is powered from an uninterruptible power supply or battery.
Power frequency (50/60 Hz) magnetic field IEC/EN 61000-4-8	3 A/m	3 A/m	The power frequency magnetic field should have the same level of characteristics as a common location in standard business and hospital environments.

Note

- U_T is the a.c. mains voltage prior to application of the test level.

<Portable and Mobile RF Communications Equipment Compliance Information and Guidance>

Table 7

Guidance and Manufacturer Declaration - Electromagnetic Immunity -

This device is intended for use in the following prescribed electromagnetic environments. Customers and users of this product are advised to check that it is being used in such environments.

Immunity test	IEC 60601 Test level	Compliance level	Guidance
Conducted RF IEC/EN 61000-4-6	3 Vrms 150 kHz to 80 MHz	3 Vrms	Portable and mobile RF communications equipment should be used no closer to any part of this product, including cables, than the recommended separation distance calculated from the equation applicable to the frequency of the transmitter. Recommended separation distance $d = 1.2 \sqrt{P}$
Radiated RF IEC/EN 61000-4-3	3 V/m 80 MHz to 2.5 GHz	3 V/m	$d = 1.2 \sqrt{P}$ 80 MHz to 800 MHz $d = 2.3 \sqrt{P}$ 800 MHz to 2.5 GHz Where "P" is the maximum output power rating of the transmitter in watts (W) according to the transmitter manufacturer and "d" is the recommended separation distance in metres (m). The electric field intensity from a fixed RF transmitter determined by an electromagnetic field study ^a should be lower than the compliance level in each frequency range ^b . Interference may occur near devices that display the following symbol. 

Note

- At 80 MHz and 800 MHz, the higher frequency range applies.
- These guidelines may not apply in all situations. Electromagnetic propagation is affected by absorption and reflection from structures, objects and people.

-
- a. Field strengths from fixed transmitters, such as base stations for radio (cellular/cordless) telephones and land mobile radios, amateur radio, AM and FM radio broadcast and TV broadcast cannot be predicted theoretically with accuracy. To assess the electromagnetic environment due to fixed RF transmitters, an electromagnetic site survey should be considered. If the measured field strength in the location in which this product is used exceeds the applicable RF compliance level above, this product should be observed to verify normal operation. If abnormal performance is observed, additional measures may be necessary, such as re-orienting or relocating this product.
- b. Over the frequency range 150 kHz to 80 MHz, field strengths should be less than 3 V/m.
-

<Recommended Separation Distance Between Portable and Mobile RF Communications Equipment and this Product>

Table 8

Recommended separation distance between portable and mobile RF communications equipment and this product.

This product is intended for use in an electromagnetic environment in which radiated RF disturbances are controlled. The customer or the user of this product can help prevent electromagnetic interference by maintaining a minimum distance between portable and mobile RF communications equipment (transmitters) and this product as recommended below, according to the maximum output power of the communications equipment.

Rated maximum output power of transmitter P (W)	Separation distance related to frequency of the transmitter (m)		
	150 kHz to 80 MHz $d = 1.2 \sqrt{P}$	80 MHz to 800 MHz $d = 1.2 \sqrt{P}$	800 MHz to 2.5 GHz $d = 2.3 \sqrt{P}$
0.01	0.12	0.12	0.23
0.1	0.38	0.38	0.73
1	1.2	1.2	2.3
10	3.8	3.8	7.3
100	12	12	23

For transmitters rated at a maximum output power not listed above, the recommended separation distance d in metres (m) can be estimated using the equation applicable to the frequency of the transmitter, where P is the maximum output power rating of the transmitter in watts (W) according to the transmitter manufacturer.

Note

- At 80 MHz and 800 MHz, the separation distance for the higher frequency range applies.
- These guidelines may not apply in all situations. Electromagnetic propagation is affected by absorption and reflection from structures, objects and people.

Disposal of Electric and Electronic Equipment



Disposal of Used Electrical and Electronic Equipment (Applicable in the European Union and other European countries with separate collection systems)

This symbol on the product, or in the manual and/or on this packaging, indicates that this product shall not be treated as household waste.

Instead it should be taken to an applicable collection point for the recycling of electrical and electronic equipment.

By ensuring this product is disposed of correctly, you will help prevent potential negative consequences to the environment and human health, which could otherwise be caused by inappropriate waste handling of this product.

The recycling of materials will help to conserve natural resources. For more detailed information about recycling of this product, contact your local FUJIFILM dealer.

In Countries outside the EU: If you wish to discard this product, contact your local authorities and ask for the correct way of disposal.

Index

A

Air Guide Port	2-4
Air/Water Nozzle	2-9
Air/Water Valve	2-5
Air/Water Valve Cylinder	2-5

B

Bending Section	2-5
Boot	2-5

C

Communication Window	2-4
Connector Mount	2-4
Control Portion	2-5

D

Distal Cap	2-9
Distal End	2-5

F

Forceps Valve	2-5
---------------------	-----

G

G7 control portion	2-5
--------------------------	-----

I

Imaging Section	2-9
Insertion Portion	2-5
Insertion Tube	2-5
Instrument Channel Inlet	2-5
Instrument Channel Outlet	2-9

L

Left/Right Angulation Lock	2-5
Left-Right Angulation Knob	2-5
LG Flexible Portion	2-4
Light Guide Cover Glass	2-4
Light Guide Prong	2-4
Light Guides	2-9

O

Objective Lens	2-9
----------------------	-----

One Step Connector	2-4
--------------------------	-----

P

Power-receiving Section	2-4
-------------------------------	-----

S

Scope Connector	2-4
Scope Switches	2-5
Suction Connector	2-4
Suction Valve	2-5
Suction Valve Cylinder	2-5

T

Transmission Window	2-4
---------------------------	-----

U

Up/Down Angulation Knob	2-5
Up/Down Angulation Lock	2-5

V

Ventilation Connector	2-4
-----------------------------	-----

W

Water Jet Inlet	2-4
Water Jet Inlet Cap	2-4
Water Jet Nozzle	2-9
Water Supply Connector	2-4

Service Centers

Contact our regional representative below or the distributor from which you purchased the product.

<Europe>

FUJIFILM Europe GmbH

<http://www.fujifilm.eu/eu/>

See our website to locate our representative in your country.

<USA>

FUJIFILM Healthcare Americas Corporation

<http://www.fujifilmendoscopy.com/>

(800) 385-4666

<Australia>

FUJIFILM Australia Pty Ltd

<http://www.fujifilm.com.au/>

1800 060 209

<Asia>

FUJIFILM Asia Pacific Pte. Ltd.

<http://www.fujifilm.com.sg/>

6380-5540

If you are not a resident of the regions above, contact the distributor from which you purchased the product.



FUJIFILM Corporation

26-30, Nishiazabu 2-chome, Minato-ku, Tokyo 106-8620, Japan



FUJIFILM Europe GmbH

Balcke-Duerr-Allee 6, 40882 Ratingen, Germany

EU Importer:

FUJIFILM Europe B.V.

Oudenstaart 1, 5047 TK Tilburg, The Netherlands