

OXYGEN CONCENTRATOR

Product Manual

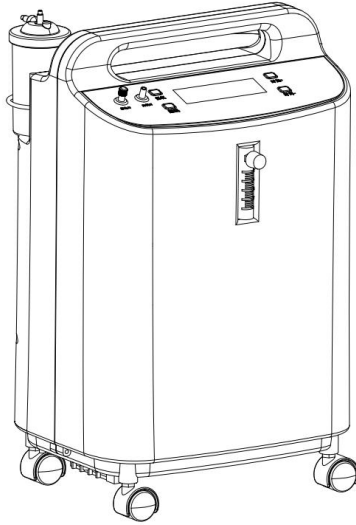

Model: XY-6, XY-6S-5I

Manual

Please read this instruction manual carefully before using this product.

The company reserves the right to interpret the instructions

The appearance of the product is subject to the actual product

TABLE OF CONTENTS

Foreword	2
Important safety precautions	3
Related usage symbols	7
Product packing List	8
Product operation	8
Product introduction	10
Structure and composition	11
Scope of application	11
Contraindications	11
Product use environment requirements	12
Transportation and storage conditions	12
Additional explanations	12
Oxygen Concentration Value and Flow Function Charts	13
Product Specifications	14
Product part name and function description	16
Product Cleaning and Maintenance Instructions	19
Product Warranty	20
Fault and repair checklist	21
Product return step requirements	23
Period of use / Date of manufacture	24
Environmental Protection	24
List of components	25
Product Warranty Card/Qualification Certificate	27

FOREWORD

Respected user:

Thank you for purchasing our product! I hope that you will become a satisfied user of our products.

This manual describes the product's precautions, operating procedures, basic functions and technical parameters, as well as basic troubleshooting, returning service instructions, etc., will make you familiar with the product and the operation of the product.

In order to ensure the effective use of this machine, please be sure to read the instructions in this manual carefully before use. Before you operate the machine, please confirm that you have read and understood the basic operation of this product, please pay special attention to all the "Important Safety Notices".

If the product needs to be returned to the factory for repair, please refer to the "Product Return Step Requirements" on the following page, and return the product according to the required content.

Please note that some of the illustrations in this manual may not be exactly the same as what you see on the machine. Please refer to the actual product.

For the random components such as the humidification bottle, oxygen pipe/oxygen mask, filter, etc. mentioned in this manual, the products that meet the specifications of the supporting products should be selected.

If you have any questions or other inquiries, please contact the supplier or the manufacturer's after-sales service.

Version: V0 Date of preparation: July 2019

IMPORTANT SAFETY PRECAUTIONS



DANGER (The following items may cause serious injury or death if they violate the operation)

- ◆ Measures to reduce the risk of burns, electric shock, fire or human injury. Avoid using an oxygen concentrator when taking a bath. If you need to use it, please follow the doctor's instructions, and the oxygen concentrator must be used in another room 2.5 meters away.

The recommended oxygen pipe should be no more than 11 meters long and cannot be folded.

Do not place or store the oxygen concentrator in a location where it is easy to drip into water or other liquids.

Oxygen has a combustion-supporting effect, and the oxygen concentrator should be kept away from open flames and fire sources when working. When there are objects with high temperature, sparks or open flame within 1.6 meters, please do not use the oxygen concentrator. Do not look after the machine after the oxygen concentrator is energized.

- ◆ Do not smoke while inhaling oxygen. It is strictly forbidden to smoke or ignite an open flame near oxygen inhalers.
- ◆ Before cleaning the dust of the oxygen concentrator casing, the power plug must be removed to prevent electric shock.
- ◆ When the machine is running, do not open the outer casing and inner casing of the machine at will, to prevent injury caused by touching the running parts.



Warning (The following items must be strictly enforced, otherwise it may cause serious consequences)

- ◆ In order to prevent the oxygen concentrator from malfunctioning or encountering power outages, oxygen users (such as those in need of oxygen and critically ill patients) need to be equipped with other spare oxygen supply devices (such as oxygen cylinders, oxygen bags, etc.).
- ◆ This product cannot be used to maintain any life. It is recommended that patients with

aerobic therapy follow the instructions of your physician when using this machine for flow and oxygen inhalation time.

- ◆ If the patient develops or exhibits an uncomfortable or abnormal reaction while inhaling oxygen, stop using the product immediately and contact the device supplier or doctor.
- ◆ Patients with severe illnesses need to be equipped with additional pointing devices when using this product, or need to be administered separately. Please consult a doctor before use and follow the doctor's advice. If you have an adverse reaction, please let your doctor know immediately.
- ◆ If the product is used in places where the sea level is more than 2000 meters, the oxygen concentration output will be lower than 90% at the rated maximum flow rate.
- ◆ Do not share the same oxygen breathing tube or oxygen mask for many people, so as to avoid cross-infection of viruses or bacteria between users.
- ◆ Wet bottles should be used in accordance with the specifications of the supporting products. Do not replace them at will, otherwise it may cause harm to oxygen or oxygen.
- ◆ Do not press the oxygen connection tube under the bed cover or the seat cushion during oxygen absorption. Do not sit on the oxygen connection tube to prevent oxygen from passing through the connection tube properly, resulting in the inability to absorb oxygen.
- ◆ When the product is operated by no oxygen, the oxygen generated will help combustion. When no one is breathing oxygen, it is recommended to turn off the power switch and disconnect the plug.
- ◆ When using this product, pay attention to whether the power cord is too long to interfere with the passage of people. It is recommended that the machine be placed next to the nearest power outlet.
- ◆ This product cannot be used with non-designated humidification bottles or drug delivery accessories to avoid affecting product performance.



Be careful (please note the following to prevent damage to the product)

- ◇ Do not open the casing and chassis of the machine for maintenance. If the user finds any

quality problems or finds an **alarm**, etc., please do not disassemble and repair it. Please contact the dealer or manufacturer of this product immediately.

- ◇ The oxygen concentrator should be placed in an environment free of dust, smoke, and corrosion and poisonous gases. Do not use this product under strong magnetic field conditions.
- ◇ The air inlet of the oxygen concentrator should be located in a well ventilated area, and the air source inlet should be in the place with the least amount of pollutants (contaminants / including: burning exhaust gas, anesthesia other discharge systems, vents and vacuum exhaust ports, etc.).
- ◇ Please use a separate (wall mounted) AC power outlet to use this product. Do not connect the power strip to the board. Do not use an additional power outlet with other appliances.
- ◇ This machine is strictly prohibited from contact with oil and grease. If you need to connect other pipes, valves and joints as needed, this type of connection should be cleaned before installation to ensure clean and oil-free (fat). During the connection process, be careful to keep the parts clean. The connected whole machine must not touch any flammable oily liquid.
- ◇ When using the machine, ensure that the bottom exhaust is unblocked. Do not place the back on the wall at least 30 cm away from the wall. Otherwise, the machine will be overheated and the casing will be damaged.
- ◇ The machine can not be turned on and off frequently, and then turned on after turning off. The interval should not be less than 5 minutes, so as not to affect the life of the compressor. The manufacturer recommends that the oxygen concentrator should run no less than 30 minutes each time.
- ◇ This machine is only used for medical oxygen supply. When the output gas is at rated flow rate, the oxygen concentration is up to 90%.
- ◇ Do not use excessive force when rotating the flow adjustment knob, otherwise the valve plug may be damaged. When the flow adjustment knob is turned on to the highest, but the flow indication is zero, shut down immediately and check the fault.
- ◇ Before receiving the product, you need to cut off the cable tie at the bottom of the machine and turn it on again. Otherwise, the machine will be damaged.















Note (you must pay special attention to the information)

- ◇ When the machine is turned on, the machine maintains the rated flow rate for 10 minutes and the oxygen concentration reaches 90% or more.
- ◇ The oxygen inhalation tube and oxygen mask that are in contact with the patient need to be cleaned, disinfected and sterilized when used repeatedly.
- ◇ Among the components of the oxygen concentrator, the humidification bottle needs to be cleaned every 2 to 3 days. The air intake filter is recommended to be replaced after 1500 hours of use. If the dust or smoke of the product is large, reduce the interval between replacement parts. In order to ensure the use of the effect, it is recommended to replace the above parts early.
- ◇ Diluted water or cold boiled water can be used for the humidification bottle. Do not inject untreated tap water directly. The water in the humidification bottle should be replaced once every 2~3 days. It is recommended to replace it every day in summer. If the product is not used for several days after use, please pour off the water and dry the wet bottle for use.
- ◇ Oxygen pipe or oxygen mask should be selected for the specifications of the matching products. If you use other types of oxygen or oxygen mask, please consult a professional doctor or supplier of this product.
- ◇ Do not discard the humidification bottle, oxygen pipe or oxygen mask, and the matching parts, and send them to a nearby medical waste disposal facility for disposal.
- ◇ Please use the humidification bottle that is compatible with this machine and fix it on the body as required. Please do not use it under the state of disassembly.
- ◇ When using a humidified bottle, pay attention to the water at the highest and lowest water level of the bottle.
- ◇ When the unit is scrapped, please contact your local supplier or manufacturer.
- ◇ Please refer to the "Related Symbols" for instructions on the symbols in the machine, package and manual.
- ◇ When you receive the product to open the packaging equipment, please refer to the "Unpacking Inspection Package and Product Packing List" to check the accessories that

are delivered randomly, and follow the “Product Operation Procedure”.

RELATED USAGE SYMBOL DESCRIPTION

OFF/ON	Off / on	220v50Hz/110v60Hz	AC 220V/110V
	No smoking		Date of manufacture
	Safety instructions	SN	Serial number
	Precautions		Reference instructions
	Class II equipment		No open flames
	Type b application part		This item cannot be discarded after use.
	Place up		Avoid rain Keep dry
	Fragile items		Stacking layer limit

UNPACKING INSPECTION PACKAGE AND PRODUCT PACKING LIST

When you receive the product, please open and check the package carefully. This product is equipped with an upper and lower foam cover. If the cover is damaged, please check the product immediately. Then, check the product packing list to see if there are missing accessories.

Product packing List			
Serial	Product Name / Accessories Name	Quantity	unit
1	Medical oxygen concentrator	1	station
2	humidification bottle	1	One
3	humidification bottle connection tube	1	article
4	Intake filter	2	One
5	Nasal tube	1	article
6	Atomization kit (for atomizer models only)	1	set
7	Product manual (including warranty card,	1	this

PRODUCT USE STEPS

- 1、 When using the product, the back should be at least 30 cm away from the wall. At the same time, the foam board and other things must be removed, and the bottom must be kept free of debris to keep the air circulation of the machine and the normal heat dissipation of the machine.(The new machine is used for the first time, please loosen or cut off the fixing strap at the bottom of the machine)
- 2、 Remove the humidification bottle, unscrew the bottle cap counterclockwise, and inst all cold water or distilled water. The water level must be as indicated. Do not Abo ve/ below the height/low indicator line of the bottle. Close the bottle and screw the bottle clockwise. As shown in Figure 1;



← Maximum water level (maximum)

← Minimum water level (minimum)

Figure 1

2. Put the humidification bottle into the fixed seat on the back of the machine, connect one end of the wet bottle connection tube to the humidification bottle inlet port, and the other end to the oxygen outlet of the oxygen concentrator, as shown in Figure 2.

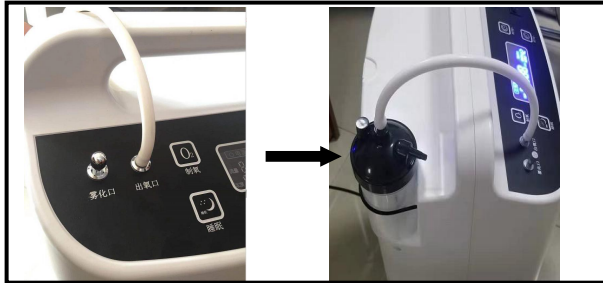

Figure 2

- 3、 Plug the AC power cord of the machine into the indoor power socket, turn on the power, and turn on the power switch on the operation panel to enter the standby mode. Press the "Oxygen" button on the operation panel of the machine, and the machine will start with a slight nitrogen discharge and slight jitter. .
- 4、 Adjust the flow meter according to the required oxygen output. The flow adjustment knob is turned counterclockwise to increase the flow rate, and clockwise to decrease.

ase the flow rate.(Oxygen concentration is 90% at rated flow rate)

- 5、 For the medical oxygen concentrator, we have equipped a monitoring device that outputs oxygen concentration. Each time the machine is turned on, the power light on the display lights up normally. After a few minutes, if the oxygen concentration of the output does not meet the standard requirements (at rated flow rate) , yellow hypoxic warning light on the display  Will light up.
- 6、 Insert the inlet end of the nasal oxygen tube (the shape of the bell mouth) into the oxygen outlet of the humidification bottle, as shown in Figure 3. Then place the oxygen suction tube on the ear of the oxygen inhaler and insert the nasal plug on the oxygen inhalation tube. Oxygen is absorbed in the nostrils of oxygen, see Figure 4.



Figure 3



Figure 4

- 7、 When the machine is running, press the “Sleep” button, the machine will enter into sleep state with the current set flow rate and timing time, and the display will be off, so as to avoid the blue light that affects the user’s sleep. Press the “Sleep” button again,the machine display is on and the status is back to normal.
- 8、 When the machine is running, the machine running time can be set through the operation panel “Time+” and “Time-” keys. The single operation timing time is accumulated or decremented by 15 minutes.

- 9、 When the machine is running, if an **alarm** sounds, check if the power connection is loose or if the external power supply has been interrupted.
10. When the oxygen is finished, press the “Oxygen” button on the operation panel and turn the power switch after three minutes. Follow the prompts to clean the oxygen pipe or oxygen mask. When not in use frequently, tie the AC power cord to the strap and place the unit.

PRODUCT INTRODUCTION

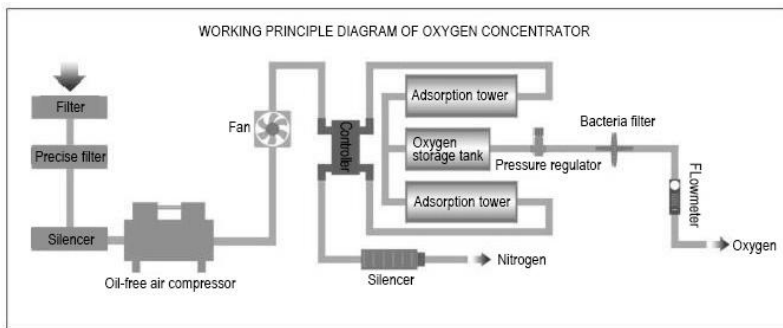

Figure 5

A medical oxygen concentrator is a machine that provides low-flow oxygen therapy at home, in a nursing home, or at a patient care center. The Portable medical oxygen concentrator adopts the principle of pressure swing adsorption to pressurize and transform air. The molecular sieve separates the nitrogen and oxygen molecules in the air, and the oxygen is retained and the nitrogen is discharged. When the power is turned on at normal temperature, oxygen that meets medical standards can be continuously separated from the air.

Structure and composition

This product consists of oxygen concentrator, flow meter and humidification bottle.

Scope of application

This device is mainly suitable for the preparation of medical oxygen.

Contraindications

no

Product use environment requirements

1. Ambient temperature: 5 ° C ~ 40 ° C;
2. Relative humidity: ≤ 80%;
3. Atmospheric pressure: 86 kpa~106 kpa;
4. The surrounding environment is free of corrosive gases and strong magnetic fields.

Transport and storage conditions

Ambient temperature range: - 20 ° C ~ +55 ° C;

Relative humidity range: ≤ 93%, and no condensation phenomenon;

Atmospheric pressure range: 50 kPa~106 kPa;



Note: When the storage temperature is lower than 5 °C, the equipment should be placed in the normal working temperature environment for more than four hours before use.

Supplementary explanation

Classification of electric shock prevention types: Class II equipment;

Classified according to the degree of protection against electric shock: b-type application part;

Classified according to the degree of protection of the incoming liquid: ipx0 equipment;

Classification according to the degree of safety when using flammable anesthetic gas mixed with air or flammable anesthetic gas mixed with oxygen or nitrous oxide: not flammable anesthetic gas mixed with air or with oxygen or nitrous oxide Equipment used in the case of mixed flammable anesthetic gases;

Classified by operating mode: continuous operation;

No signal output and signal input part;

Use voltage: ~110V, 60Hz;

Working system: This machine is a continuous operation system;

The oxygen concentrator has no application part that protects against defibrillation discharge effects;

Oxygen concentrators are non-permanent installation equipment.

OXYGEN CONCENTRATION VALUE AND FLOW FUNCTION CHART

Oxygen concentration value and flow function chart when the nominal pressure of the Portable medical oxygen concentrator is zero (see Figure 6)

This function table is for models with model XY-6 rated flow rate of 3L/min.

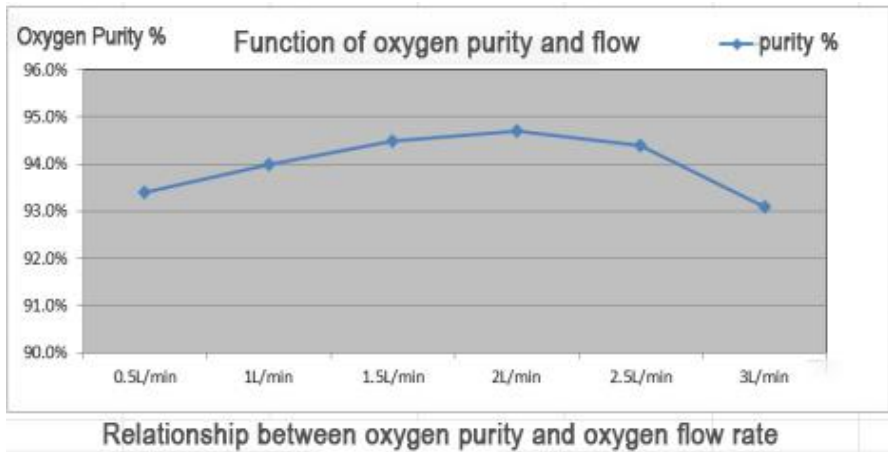

This function table is for models with model XY-6S rated flow rate of 5L/min.

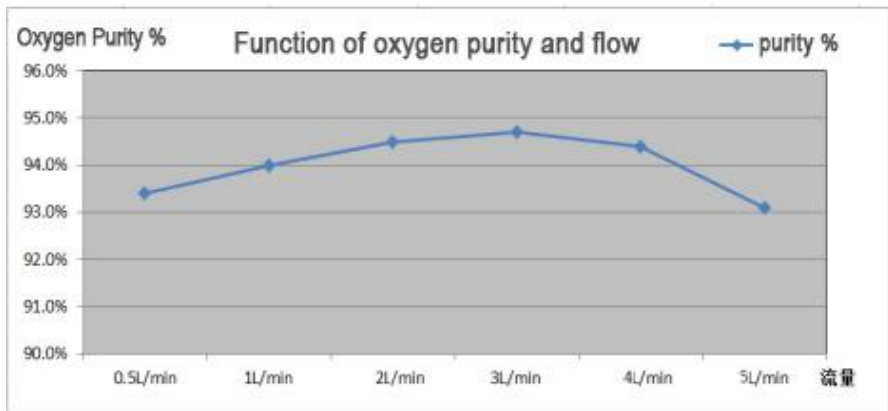

Relationship between oxygen purity and oxygen flow rate

Figure 6

PRODUCT SPECIFICATIONS

model	XY-6	XY-6S
Working voltage (V/Hz)	~220 ± 10% / 50 ± 1 / 110 ± 10% / 60 ± 1	
Rated power (w)	250	360
Flow range at nominal pressures of zero and 7 kPa (L/min)	0.5~3	0.5~5
Oxygen concentration at the nominal zero pressure of the outlet (within the initial start-up within 10 min, the specified concentration level is reached)	When the oxygen flow rate is 0.5~3L/min, the oxygen concentration is ≥93%+/-3%	When the oxygen flow rate is 0.5~5L/min, the oxygen concentration is ≥90%+/-3%

Maximum recommended flow rate (rated flow rate)	3 L/min	5 L/min
At the maximum recommended flow rate, a back pressure of 7 kPa is applied and the flow rate changes.	≤0.5 L/min	
Oxygen concentration at the recommended maximum flow rate (within the initial start-up within 10 min, the specified concentration level is reached)	≥93%+/-3%	
Flow adjustment range	Continuously adjustable from 0~3L/min	Continuously adjustable from 0~5L/min
Stand-alone net weight (Kg)	14	18
Machine noise dB(A)	≤50	
Dimensions (mm)	Length 380* wide 330* high 600	
Oxygen output pressure	40-60kPa	
Hypoxic indicator	At rated flow rate, when the oxygen concentration is ≤82% (± 3%), the yellow hypoxic indicator light is displayed. Please turn off the machine immediately, use the spare oxygen, and contact the supplier or manufacturer immediately.	

Compressor safety valve release pressure: 250kPa ± 50 kPa

Oxygen outlet temperature: ≤46°C

When the altitude is between 0 and 2000 meters, the oxygen concentration is ≥90%, and the efficiency is less than 90% from 2001 meters to 4,000 meters.

PRODUCT AND COMPONENT NAME AND FUNCTION DESCRIPTION

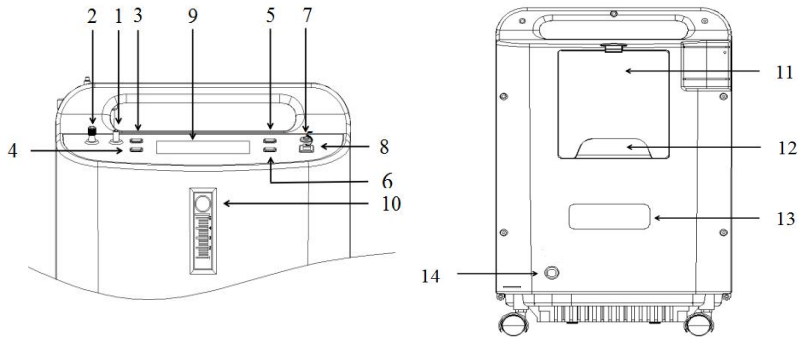

* Description of the following parts*

1. Oxygen outlet: Connect to the humidification bottle or nasal oxygen tube with a humidification bottle connection tube
2. Atomizing port: use of atomizing function (only for atomizing machine type): Add appropriate amount of liquid to the atomizing cup (according to the doctor's advice), do not exceed the maximum scale line. Before starting the machine, unscrew the atomizing port plug and connect the connecting pipe to the atomizing port of the main machine and the air inlet of the atomizing cup. Turn on the power, adjust the flow rate of the oxygen flow meter to 1.5L/min, and follow the doctor's instructions for atomization treatment. After the atomization is finished, close the oxygen concentrator, screw the atomization port plug into the atomization port and tighten. To continue to breathe oxygen, turn the oxygen concentrator back on.
3. Oxygen button: machine start / standby mode
4. Sleep button: When the machine is started, the display goes out;
5. Timing +: Timing time increment setting
6. Timing -: Timing time decrement setting
7. Current overload protector: protect the whole circuit
8. Switch: whole machine power switch
9. Display:

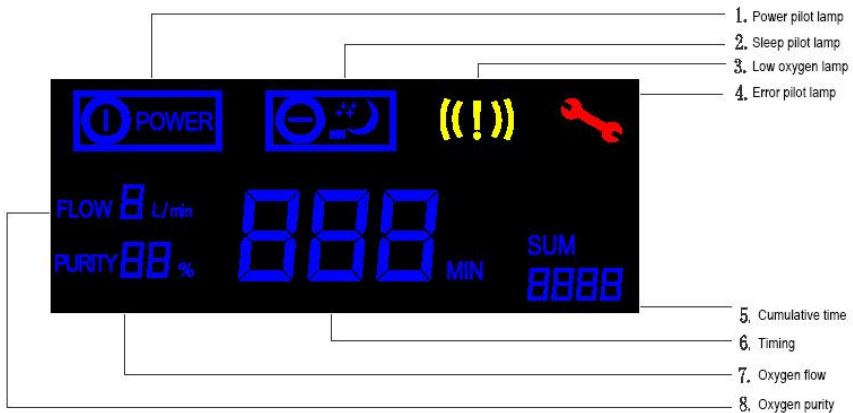

Figure 8

- 9.1. Power indicator light--The machine is in standby mode when it is in the flashing state, and it is in the working state when it is on.
- 9.2. Sleep Breathing Light--The machine is in sleep mode when the light is in the state, the display is off, sleep breathing
Open
- 9.3. Low-oxygen indicator light--The machine oxygen concentration is lower than 82% when it is on; (When the actual flow exceeds the designed flow of the machine, the oxygen concentration may be lower than 82%)
- 9.4. Fault indicator light--The machine parts are faulty, please contact the after-sales service;
- 9.5. Accumulated time--the cumulative use time of the machine;
- 9.6. Timing time--the working time of the machine, the unit is min (minutes);
- 9.7. Oxygen concentration--Display the current oxygen concentration value in L/min (L/min);
- 9.8. Oxygen flow rate--Display the current flow rate value in units of l (liter);

Remarks: The medical oxygen concentrator has the following fault detection functions: low oxygen alarm and component failure alarm;

When the oxygen machine works normally for 10 minutes, the oxygen concentration detection (low oxygen alarm) function of the oxygen machine starts the real-time detection of the

working state of the oxygen machine. When the oxygen concentration is $\leq 82\%$ ($\pm 3\%$), the yellow hypoxia alarm icon lights up. (When the actual flow exceeds the rated flow, the oxygen concentration may be less than 82%), please shut down immediately when the low oxygen alarm is encountered; when the machine parts are abnormal and cannot work normally, the red fault alarm icon lights up. And continue to alarm, the whole machine stops running, please shut down immediately;

10. Oxygen flow meter (refer to Figure 9)

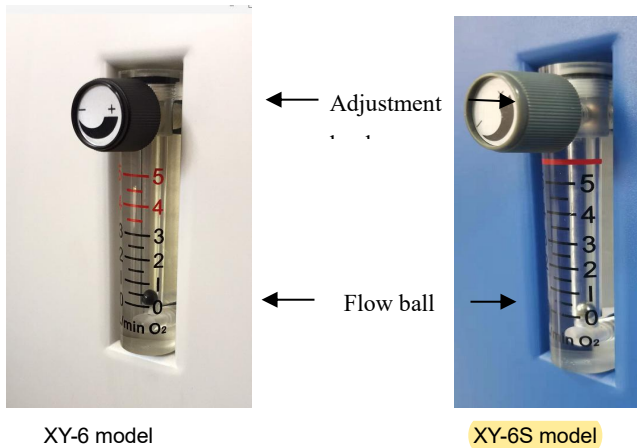



Figure 9

Flow meter adjustment knob: Oxygen flow meter switch knob to regulate and control the output oxygen flow

The level of the flow ball in the oxygen flow meter corresponds to the flowmeter scale, indicating the flow rate (L/min)

 Note: Check the oxygen flow meter and confirm that the flow ball is centered under the tick mark specified by your oxygen flow meter (the maximum flow rate of the XY-6 model oxygen machine is 3L/min, please do not let the flow ball be higher than 3L, XY-6S model oxygen machine maximum flow rate For 5L/min, please do not let the flow ball be higher than 5L).

The flow in the oxygen prescription is very important. Do not increase or decrease the

reference flow of oxygen provided by your doctor.

If the meter's regulator valve rotates clockwise, the flow will decrease (and eventually the oxygen flow will be turned off). If it is rotated counterclockwise, the flow will increase.

11. Intake filter cover: The intake filter can be replaced after the cover is removed:
12. Machine air inlet: machine oxygen source and machine cooling air source, ensure that the air port is 30cm away from debris or wall during normal use, so as not to affect the normal air intake of the machine;
13. Product nameplate/factory number label: product performance label, label product serial number.
14. AC power cord.

MACHINE USE PRECAUTIONS

- When the oxygen concentrator is working, there must be no other items (including walls) within 30 cm of the back of the machine; objects with high temperature, sparks or open flames should not be present within 1.6 m.
- Smoking is prohibited during oxygen inhalation. When working in an oxygen concentrator, it is strictly forbidden to smoke next to or near it.
- Do not use in dust, smoke, corrosion, poisonous or polluting gases and strong magnetic fields.
- The oxygen concentrator is strictly prohibited from coming into contact with flammable oils (including lubricants/oils).
- The air intake filter is recommended to be replaced after 1500 hours of use.
- Please do not use a mobile socket or share the same socket with other appliances.
- If you feel uncomfortable or abnormal, stop using the product immediately.
- Be sure to read the instructions in the instruction manual carefully before use.
- Unauthorized personnel must not disassemble the oxygen concentrator casing.

Product cleaning and maintenance instructions

- 1、 Clean the whole machine casing: 1~2 times a month, please wipe the outside of the fuselage with a clean soft towel with a little detergent, and then dry it with a dry towel.

- 2、 Cleaning the humidification bottle: The humidification bottle can be cleaned separately with detergent and hot water, or mixed with white vinegar and water in a ratio of 1:3 as a bactericide, and the separated humidification bottle is placed in the solution for 30 minutes. Then wipe the humidification bottle.
- 3、 Replacing the air intake filter: Intake filter cotton is an important part of the cleaning oxygen machine air source. In order to ensure that the machine continues to provide fresh and sufficient oxygen, it is recommended to replace the air intake filter every 1500 hours.



Note: replacement of the oxygen pipe

In view of the fact that the oxygen pipe is a one-time use product, the company does not recommend reusing the oxygen pipe to prevent the disease from causing disease. Each bag has a separate oxygen tube that can be purchased at the dealer. The company is not responsible for the adverse consequences arising from repeated use.

PRODUCT WARRANTY

Within 12 months from the date of purchase, it is a quality guarantee period. If the product is not artificial and cannot operate normally, Oxygen should repair or replace the parts for the user without charge.

- 1、 During the warranty period, under normal use conditions, due to the quality problems caused by the purchased product itself and the warranty conditions, please return the completed warranty card to the company for repair, or carry it. The warranty card and the purchase ticket are repaired free of charge at the point of sale of the purchased product. If the warranty card is lost, the warranty period of the product you purchased will be based on the results of the database query, or the date of purchase on the 30th day of the fuselage code.
- 2、 Machines that fail due to unauthorized modifications or additional functions are not accepted.
- 3、 Save the warranty card and the purchase ticket as the warranty certificate for the product,

please keep it in a safe place and lose it.

The following conditions are not free of charge:

- 1、 The product is out of warranty;
- 2、 No warranty certificate;
- 3、 Failure caused by operation in accordance with the instructions;
- 4、 Damage caused by the dismantling of maintenance personnel of the company;
- 5、 Malfunction, scratch or breakage caused by movement;
- 6、 The user's own failure to repair, disassemble, and assemble the product;
- 7、 Normal damage to consumables and consumables;
- 8、 Failure and damage caused by force majeure (such as fire, flood, earthquake, etc.).

Fault and repair checklist



To avoid electric shock, do not open the case by yourself. Opening the enclosure can only be carried out by a specialist authorized by the oxygen concentrator manufacturer.

The [Fault and Repair Checklist] attached below will help you analyze and properly repair the malfunction of the oxygen concentrator. If the suggested procedure does not help, use an alternate oxygen concentrator and notify the supplier of the oxygen concentrator for repair. Please do not try to try any other repairs.

Malfunction symptoms	Possible cause	Maintenance method
When the switch is turned on, the machine does not run, the power indicator does not light, the alarm sounds, and the alarm light is on.	The power cord plug is not properly plugged into the power outlet.	Check the connection between the power cord and the wall outlet. Check the connection between the power cord and the wall outlet after the 220v voltage checker is installed.
	The power outlet is not powered.	Check the home circuit breaker and restart if necessary. If the same problem occurs again, use another AC outlet.

When the switch is turned on, after the machine is running for 1 minute, the power indicator light is on, the red alarm light is on, and an alarm sound may be heard.	The intake filter is clogged.	Check the air filter cotton and if it is dirty, clean it according to item 3 of the “Product Cleaning and Maintenance Instructions”.
	The exhaust port is blocked.	Check the base exhaust port and make sure the exhaust port is not blocked.
	The oxygen tube, catheter, mask or oxygen connection tube is blocked or defective.	Separate the oxygen tube, catheter or mask and if the flow is restored, it needs to be cleaned or replaced. Take the oxygen pipe out of the oxygen outlet. If the flow rate rises, replace the oxygen pipe and use it.
When the switch is turned on, the power indicator lights up and a low frequency vibration is heard.	The cable tie that fastens the compressor at the bottom of the machine is not cut and pulled out.	Turn off the machine, unplug the power cord, place the side of the machine on the ground, cut the tie that fastens the compressor, and pull it out.
The red fault alarm indicator lights up and the alarm sounds.	The machine part is faulty.	Contact your supplier.
The yellow hypoxia indicator lights up.	The flow meter is not adjusted	Confirm that the flowmeter is adjusted to the specified position.
	Intake filter cotton blockage	Check the air filter cotton and if it is dirty, clean it according to item 3 of the “Product Cleaning and Maintenance Instructions”.
	The exhaust port is blocked.	Check the base exhaust port and make sure the exhaust port is not blocked.
If the machine still does not work properly after the above method, or if there are any other problems with the machine, please contact the product supplier or service point.		

* If there is no special explanation, please follow the above instructions.

Product return step requirements

Dear Customer:

Hello! First of all, thank you very much for your trust and support to Oxygen. We will wholeheartedly strive to provide you with satisfactory after-sales service. We apologize for the abnormal use of your products and promise that they will solve them as soon as possible. Please follow the steps below to return the products to our company for repair or return:

- 1、 Complete the product warranty card that came with the end of this manual and return it with the product.
 - Please fill in the reason why the product must be returned to the factory for maintenance. If the machine received by our after-sales personnel does not have any fault description, it will take time to re-test and confirm the return to the machine state, which will increase the time for solving the problem.
 - Please indicate your contact details. If necessary, our sales staff may call you to confirm the machine again.
- 2、 The description of the accessory parts of the product is as follows:
 - For repaired machines, accessories such as oxygen users and humidification bottles are disposable consumables and do not need to be returned at the same time as the machine.
 - For the returned machine, it is necessary to ensure that the attached parts are sealed and packaged intact and will not affect the secondary sales, otherwise the price of such accessories may be deducted when returning.
 - If you want to add accessories that come with the purchase, you can also fill in the instructions on the repair order.
- 3、 Please remove the product's humidification bottle and do not have water in the bottle.
 - If the returned product has a humidified bottle and the water in the bottle is not cleaned, the water will be injected back into the machine, causing secondary damage to the product.
 - Since such damage occurs as a result of failure to follow the instructions, not the quality

of our products, it should be carried out in accordance with the paid warranty terms that you need to pay for repairs.

4. When returning to the factory, please use the matching box of our products.
 - The packaging of our products is designed according to the overall rationality of the products to ensure the safety of the transportation process. If you use other packaging, there may be damage to the transportation of the products.
 - This kind of damage occurs, it is not the quality problem of our products, it should be implemented according to the paid warranty clause that you need to pay for repair; and in order to ensure the safety when the repair machine is sent back again, our company will replace the original packaging, the cost will also be listed in the list you need to pay.
5. (If necessary) The product is sterilized before being issued.
 - Since some users have infectious diseases, if your machine is used by such patients, please wipe the outer casing with alcohol before packaging the machine, or (under the guidance of medical staff) for other more professional Disinfection, so as not to infect people and people who will come back to the machine again.

Please refer to our recommendations after the product manual to return to the machine.

If you have any questions, please call us! Finally, thank you for your support!

Term of use / date of manufacture

1. The period of use: 5 years.
2. Date of manufacture: See product performance label.

Environmental protection

1. Disposal of waste and residue

When the oxygen pipe, humidification bottle and supporting components are used, do not discard them and send them to a nearby medical waste disposal facility for disposal.

2. When the machine is scrapped, please contact your local supplier or manufacturer.
3. The disposal of waste and residue should comply with the corresponding national laws and regulations.

List of components

Serial number	Component name	Quantity
1	Main control board	1 block
2	display board	1 block
3	Oxygen Sensor	1
4	Oxygen system solenoid valve	1
5	compressor	1 set
6	DC fan	1
7	switch	1
8	Overload protector	1

Portable medical oxygen concentrator
Product warranty card (user association)

Customer Name: _____

Phone: _____

Contact address: _____

Zip code: _____

Product Name: Portable medical oxygen concentrator

Model: _____

Body number: _____

Dealer: _____

Address: _____

Phone: _____

Zip code: _____

Purchase date: _____

CERTIFICATE

Product Name: Portable medical oxygen concentrator

Product model: XY-6, XY-6S

Medical Device Production License No.: Guangdong Food and Drug
Administration Production No. 20112047

Registration Certificate Number / Product Technical Requirements No.:
Guangdong Machinery Note 20162541548

The product inspection meets the technical requirements and the
product is qualified.

inspector:

Inspection date:

Shenzhen Hongxinyuan Electronics Co., Ltd.