

Perform-X F100–F400 / C100–C400 Radiographic System

Operating Instructions

CE
1011



Manufacturer:
Control-X Medical Zrt.
Öv street 29.
1141 Budapest
www.cxmed.com

68 pages
Document ID: 4788 / 10
© Control-X Medical

CONTENTS

1	IMPORTANT SAFETY INFORMATION	4
1.1	AREAS OF DANGER	5
2	GENERAL INFORMATION	8
2.1	INTENDED USE, APPLICATION	8
2.2	COUNTERINDICATIONS	9
2.3	SYSTEM CONFIGURATIONS	9
2.4	COMPATIBILITY	11
2.5	SYMBOLS AND MARKINGS	13
2.6	OPERATORS	16
2.7	SERVICE PERSONNEL, INSTALLATION	16
2.8	ENVIRONMENT, FREQUENCY OF USE AND MOBILITY	16
2.9	DOSIMETRIC INFORMATION	16
2.10	INTERCHANGEABLE OR DETACHABLE PARTS	16
3	SPECIFICATIONS	17
3.1	MECHANICAL DATA, MOTION RANGE	17
3.2	X-RAY PARAMETERS	20
3.3	POWER SUPPLY	20
3.4	ENVIRONMENTAL DATA	20
3.5	USAGE CONDITIONS	21
3.6	APPLIED PARTS	21
3.7	CLASSIFICATION	21
3.8	ELECTROMAGNETIC COMPATIBILITY	22
4	OPERATOR CONTROLS	25
4.1	SYSTEM CONTROL BOX	25
4.2	TUBE STAND MANUAL MEMBRANE CONSOLES	25
4.3	PXIM CONSOLE TUBE STAND LCD TOUCHSCREEN	29
4.4	WS99N WALL BUCKY STAND	45
4.5	REMOTE CONTROLLER	47
4.6	RADIOGRAPHIC TABLE	48
4.7	SIGNIFICANT ZONE OF OCCUPANCY	49
5	USING THE PERFORM-X SYSTEM	51
5.1	TURNING ON/OFF	51
5.2	USING THE WALL STAND	51
5.3	USING THE RADIOGRAPHIC TABLE	53
5.4	WORKING WITH FIXED AND PORTABLE RECEPTORS	54
5.5	USING THE TUBE STAND	55
5.6	TRACKING FUNCTIONS AND AUTOMATIC POSITIONING	58
5.7	POSITIONING THE PATIENT	62
5.8	TAKING EXPOSURES	63
5.9	EXPOSURE INTERLOCKS	64
5.10	ERROR MESSAGES AND ERROR CONDITIONS	64
6	MAINTENANCE	65
6.1	DAILY ROUTINE CHECK	65
6.2	WEEKLY CHECK	65
6.3	PERIODIC MAINTENANCE	65

6.4	CALIBRATION	65
6.5	CLEANING AND DISINFECTION	65
7	DISPOSAL AND DECOMMISSIONING	67

1 IMPORTANT SAFETY INFORMATION



CAUTION!

This equipment may be used only if the operator is familiar with its operation and safety features. The operating instructions (present document) must be carefully studied before operation.

ELECTRICAL SAFETY

Only trained service personnel are permitted to remove covers & panels from the equipment. The provisions of the local standards and electrical codes shall be observed at all times.

To avoid the risk of fire and electric shock, this equipment shall only be connected to a supply main with protective earth.

MECHANICAL SAFETY

It is the operator's responsibility to ensure patient safety during positioning and usage.

X-RAY PROTECTION

- This equipment in itself does not have any control, which can trigger radiation. Exposure can be initiated only from a radiation-protected area, from the generator control console. Any person present in the room during radiographic examinations shall comply with applicable local radiation protection regulations. To protect the patient and the operator against unnecessary radiation exposure, additional radiation safety devices shall be installed and used, including personal wearable protection devices.
- **Set safe exposure factors, limit radiation field, keep safe distance and provide radiation protection for the patient.**

DANGER OF INJURY

- Do not reach into the operating device. It may cause injury or the moving part may catch your cloth.
- Positioning the X-ray tube may cause injury to persons in the area of danger.
- Do not reach behind the X-ray tube stand control. The X-ray tube assembly may be hot and could cause injury.

PROTECTION AGAINST EXPLOSION AND FIRE

- Do not use the equipment in the presence of flammable anesthetics – explosion may occur.
- Before disinfecting or cleaning the unit, the power shall be turned off and kept off until the disinfecting or cleaning material has evaporated.



ATTENTION!

Do not use electronic devices in the x-ray room that emit **high RF energy**, such as radio transmitters and therapeutic equipment operating with electromagnetic radiation.

1.1 AREAS OF DANGER

The following areas of danger are present while operating the Perform-X System:

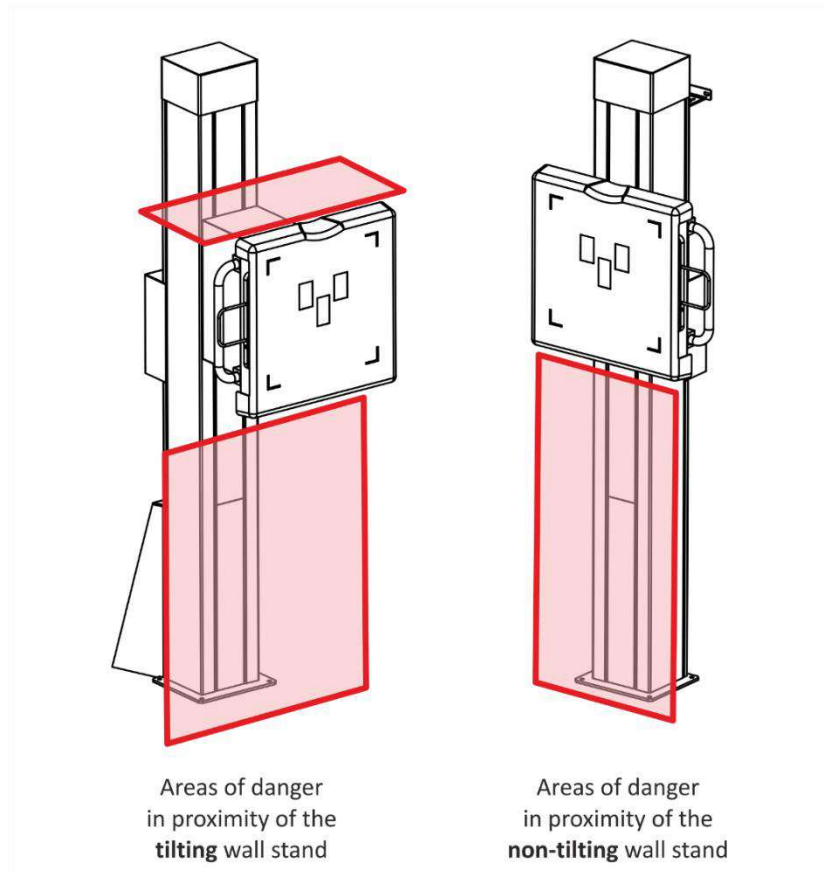

F100 F200 F300 F400 C100 C200 C300 C400

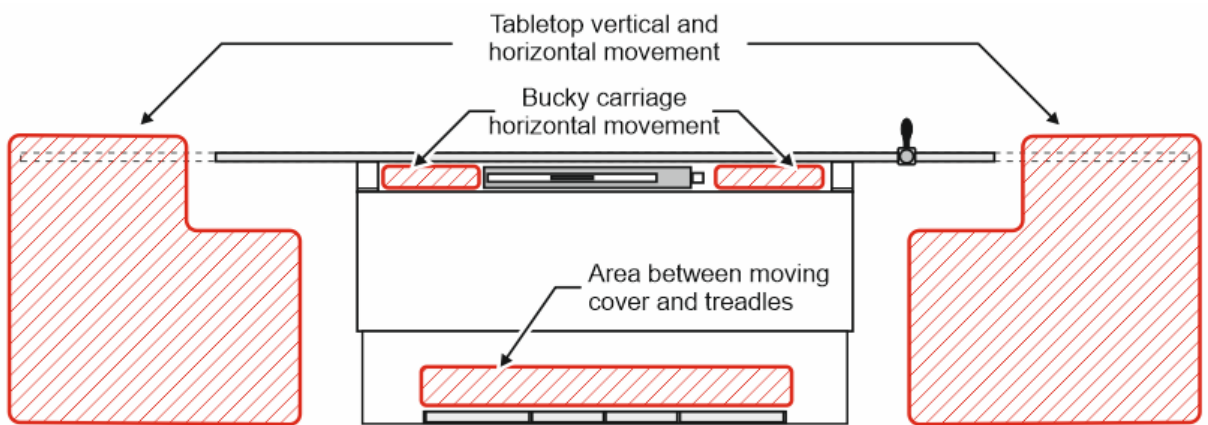

1758-07

F100 F200 F300 F400 C100 C200 C300 C400

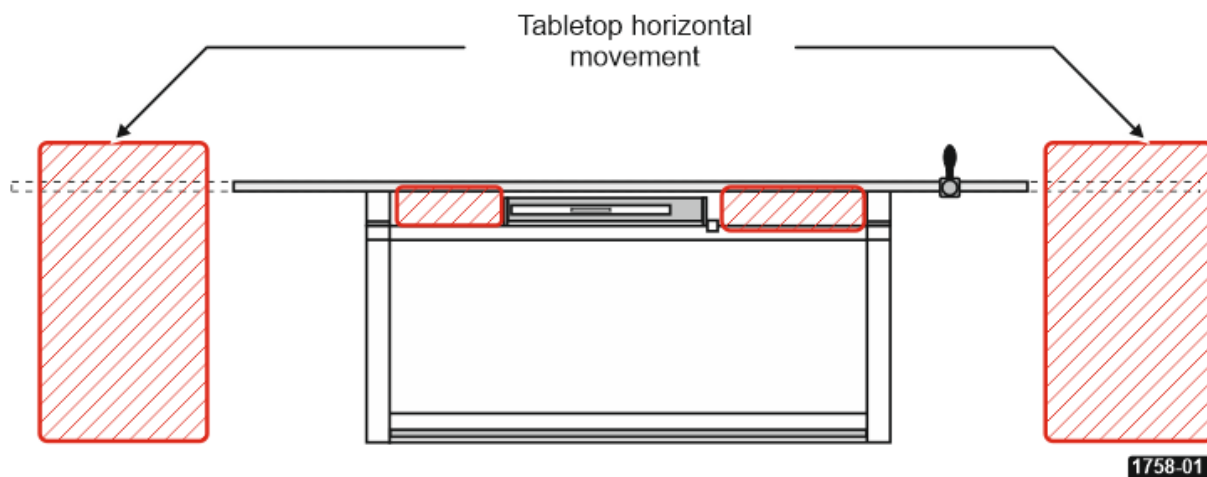

Areas of danger in proximity of the **fixed height table**

- F100
- F200
- F300
- F400
- C100**
- C200
- C300
- C400

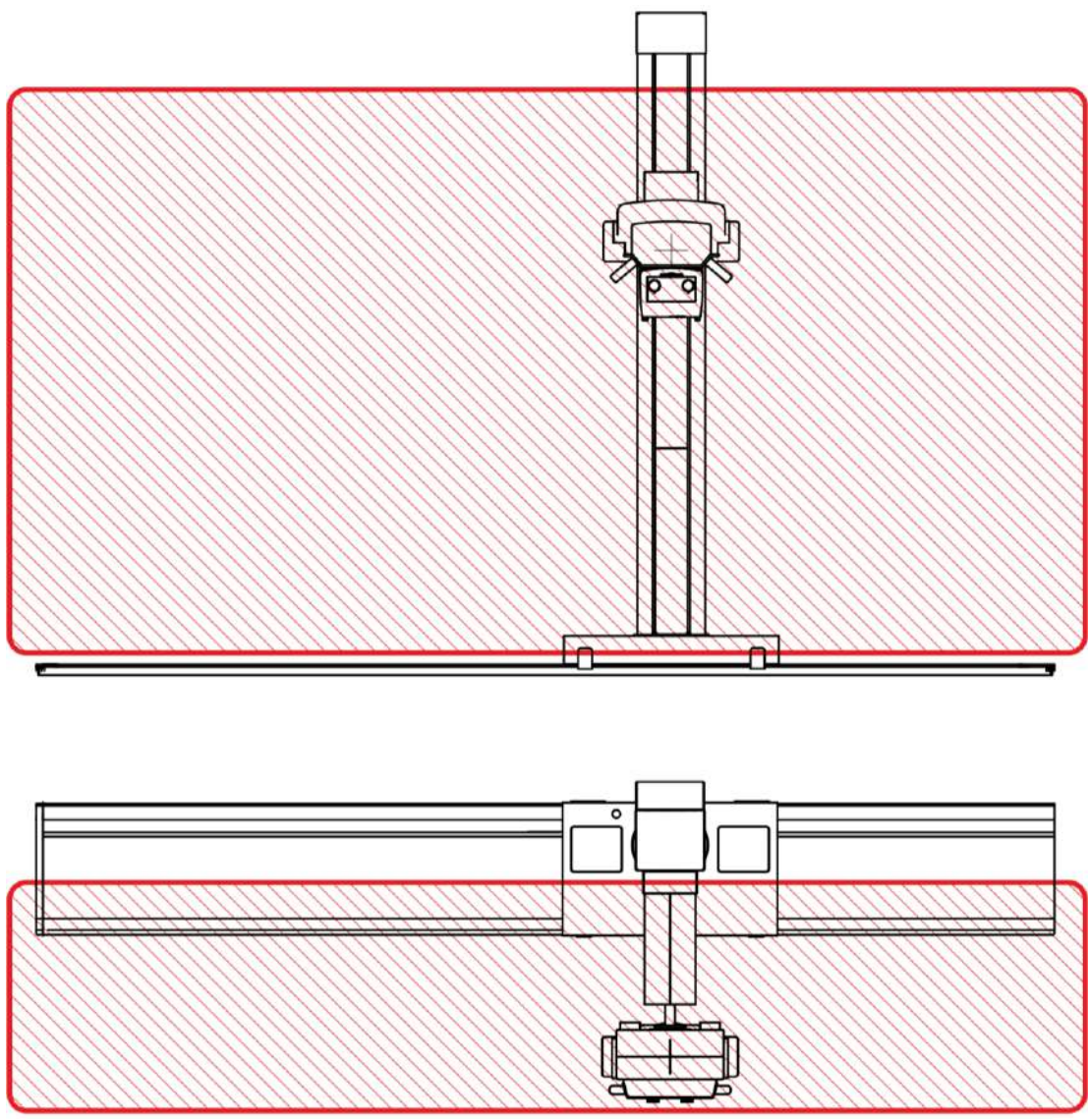

Areas of danger in proximity of the **floor-mounted tube stand**

- F100
- F200
- F300
- F400
- C100
- C200
- C300
- C400

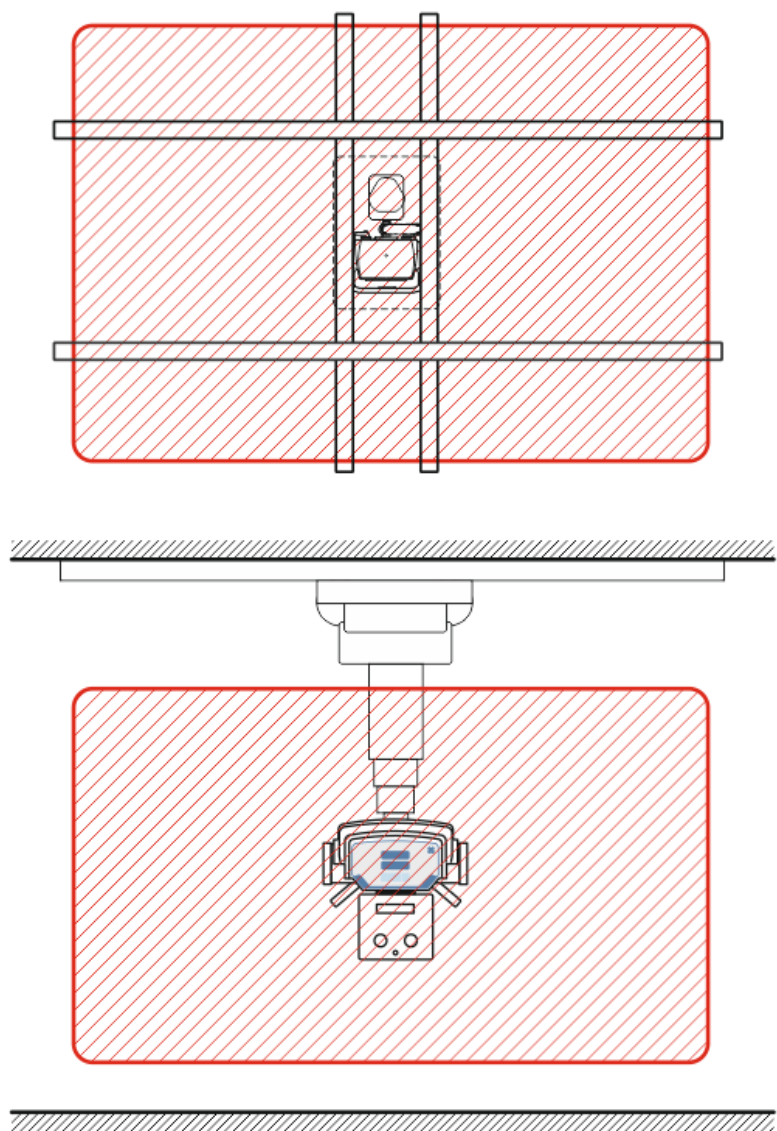

Areas of danger in proximity of the **ceiling tube stand**

- F100
- F200
- F300
- F400
- C100
- C200
- C300
- C400

2 GENERAL INFORMATION

2.1 INTENDED USE, APPLICATION

This document describes the usage of the devices of the **Perform-X F100 to F400 and C100 to C400 Radiographic Systems** (hereinafter *Perform-X*). The devices such as table and stands form a complete diagnostic system when equipped with other medical devices (e.g. X-ray generator, digital acquisition software, DR detector, etc.).

As part of a complete diagnostic radiographic room, the Perform-X is intended to hold and position the radiation source, the beam limiting device, the X-ray receptor and associated devices as well as the patient during general radiographic procedures such as

- Chest and spine examinations
- General gastrointestinal radiograms
- Extremities procedures
- Lateral and oblique projections
- Ambulatory / emergency radiograms.

The Perform-X system **cannot be used for fluoroscopic applications**.

There is no need for particular limitation of patients in regards to age, gender or physical condition. General guidelines used in radiography apply:

- Pregnant patients or patients where pregnancy cannot be ruled out must be informed of the potential adverse effects of the ionizing radiation;
- The system can be used for infants and children utilizing proper exposure parameters (but it is not specifically designed for pediatric applications);
- The elevating table is helpful when examining disabled, frail and/or elderly patients;
- Optional overhead stretch grips on the wall stand may be used to make patient positioning easier and safer.



ATTENTION!

The Perform-X system may contain a **sensitive flat panel detector** (indirect radiography). To avoid property damage and maintain image quality / performance, observe at all times the handling and maintenance instructions set forth in the flat panel detector's user manual.



ATTENTION!

If the Perform-X system is used for **pediatric diagnostic procedures**, at least 0.1 mm Cu or 3.5 mm Al **additional filter** is mandatory.

If the system is equipped with a DAP (Dose Area Product) meter, the collimator exit dose is measured and can be recorded in one of two ways:

- automatically if the DAP is compatible with the image acquisition system or the generator;
- manually if using a DAP with built-in or remote display.

Refer to the image acquisition software or the X-ray generator user manual for further details.

2.2 COUNTERINDICATIONS

2.2.1 Adverse Effect of X-ray Radiation

There are no short-term adverse effects. Generally speaking, the benefit of the X-ray procedure far outweighs the small associated risks. At the dose levels that are utilized in diagnostic radiography there is little or no evidence of health effects.

For standard radiograms made with the Perform-X radiographic system, the radiation dose is no more than the ionizing radiation from normal environmental background over a period of one year.

However, the minimal risk of exposure to any type of medical ionizing radiation needs to be weighed against the potential gain from the diagnostic information provided by the X-ray radiogram.

For further details, please refer to document *D-3633 - Information on the Effects of X-ray Radiation*.

2.2.2 Absolute Counterindications



NONE



2.2.3 Relative Counterindications

- **Pregnant patients** or patients where pregnancy cannot be ruled out **must be informed** of the potential adverse effects of the ionizing radiation. The potential **risks of health effects and benefits** of the diagnostic procedure **must be weighed** individually.
- Patients weighing more than the radiographic table weight rating may not be examined on the patient table. The potential risks of equipment damage and benefits of the diagnostic procedure must be weighed individually.

2.3 SYSTEM CONFIGURATIONS

The Perform-X is available in several different configurations.

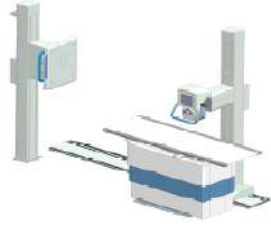
Conf.	Example	S Mount	Manual movem.	Auto-track	Auto-stitch	Auto-position
F100		Floor	YES	NO	NO	NO
F200		Floor	YES	YES	NO	NO

Conf.	Example	S Mount	Manual movem.	Auto-track	Auto-stitch	Auto-position
F300		Floor	YES	YES	YES	NO
F400		Floor	YES	YES	YES	YES
C100		Ceiling	YES	NO	NO	NO
C200		Ceiling	YES	YES	NO	NO
C300		Ceiling	YES	YES	YES	NO
C400		Ceiling	YES	YES	YES	YES

The Perform-X system may consist of a combination of the following devices:

Device	Description	F100
TS99N	Floor-mounted X-ray tube stand	Optional
CTM-200	Ceiling- mounted X-ray tube stand	Optional
WS99N	Wall bucky stand	Default
Phoenix 2	6-way float top elevating radiographic table	Default
Phoenix 1	6-way float top elevating radiographic table	Optional
Stylix	4-way float top fixed height radiographic table	Optional

2.4 COMPATIBILITY

The Perform-X Radiographic system is compatible with a number of certified diagnostic X-ray devices. To verify compatibility with a particular device, please contact your service partner or the manufacturer. The following is an inexhaustive list of devices compatible with the Perform-X:

Device type	Manufacturer	Model	Comments
X-ray tube	Varex Imaging	RAD-XX / A and G series	Diamond, Leo, Sapphire, B-130 and B-130H housing rotating anode dual focus RAD X-ray tubes
X-ray tube	Toshiba	E72XX series	Rotating anode dual focus RAD X-ray tubes
X-ray tube	IAE	RTM782HS, RTM101HS, RTC600HS; C352 and C52S housings	Rotating anode dual focus RAD X-ray tubes
Collimator	Ralco	R-225	Automatic motorized collimator (including with optional camera)
Collimator	Ralco	R-302F/A	Manual collimator with selectable filters
Collimator	Varex Imaging	Optica 10 / 20	Manual collimator with optional manual filter
Collimator	Ralco	R-108	Manual collimator
HV cables	Varex Imaging	L3 / X3	L3 and X3 series HV cables rated 150 kV er pair (75kV each)
AEC detector	Varex Imaging	ICX-1153	3-field ion AEC detector
Bucky	Control-X Medical	CXB-17	Oscillating bucky
Grid cabinet	Control-X Medical	SGC	Non-oscillating, removable grid
Cassette tray	Control-X Medical	TLI -1417 TLI-1717	43x43 cm / 35x43 cassette size tray for CXB-17 bucky
Cassette tray	Control-X Medical	T-1717 T-1417 T-1717 Fixing kit	43x43 cm / 35x43 cm cassette size tray for SGC grid cabinet
Cassette tray	Control-X Medical	QKCX	43x43 cm cassette size tray for CXB-17
Flat panel detector	Varex	PaxScan Series	CsI A-Si fixed flat panel detectors
Flat panel detector	Rayence	Xmaru Series	Fixed and portable flat panel detectors (select models)

Device type	Manufacturer	Model	Comments
Flat panel detector	CareRay	1500 & 1800 series	Fixed and portable flat panel detectors (select models)
Flat panel detector	Vieworks	Vivix series	Fixed and portable flat panel detectors (select models)
Flat panel detector	iRay	Venu series	Fixed flat panel detectors (select models)
Flat panel detector	iRay	Mars series	Portable flat panel detectors (select models)
Flat panel detector	Canon CETD	FDXA-4343R	43x43 cm Csl A-Si fixed flat panel detector
Flat panel detector	Canon CETD	FDX-3543RP	35x43 cm Csl A-Si tethered portable flat panel detector
Flat panel detector	Canon CETD	FDXA-3543RPW	35x43 cm Csl A-Si wifi portable flat panel detector
Flat panel detector	DRTech	EVS Series	Fixed and portable flat panel detectors (select models)
X-ray generator	Innomed Medical	TOP-X 100LC series	100 kHz 32-50kW three or single phase, single tube RAD generator family
X-ray generator	CPI Inc.	CMP-200 series	200 kHz 32-80kW three phase, single tube RAD generator family
X-ray generator	CPI Inc.	CMP-150 series	150 kHz 32kW single phase, single tube RAD generator family
X-ray generator	CPI Inc.	Indico IQ series	65/80kW three phase, single/dual tube RAD generator family
X-ray generator	Spellman HV Electronics GmbH	Editor HFe series	100kHz 40-80 kW three phase RAD generator family
X-ray generator	Suzhou Powersite	PSG HR 50, 60, 80	100kHz 50, 65, 80kW three phase RAD generator
Anti-scatter grid	UMI	high density grids	Full size Al spacing focused grids
Anti-scatter grid	JPI	high density grids	Full size Al spacing focused grids
Dose Area Product Meter	IBA Dosimetry	KermaX Plus	Display and non-display version: compatible with collimators and the DX-R image acquisition software

Device type	Manufacturer	Model	Comments
Dose Area Product Meter	VacuTec Meßtechnik GmbH	VacuDAP	Measuring chambers with serial data interface
Image Acquisition Software	OR Technology	dicomPACS DX-R	DICOM 3.0 compatible open architecture image acquisition software

2.5 SYMBOLS AND MARKINGS

All devices of the Perform-X system have a product label with the following information:

- name and address of the manufacturer;
- model number, serial number and manufacturing date of the device / system;
- power supply requirements.

The location of the system and product labels are as specified below:

- **Product label:**
 - TS99N tube stand: right side of column, near the horizontal carriage
 - CTM-200 tube stand: front side of column
 - WS99N wall bucky stand: right side of the column, near the floor
 - Stylix and Phoenix tables: on the side cover
- **System label:** always above the respective product label on the stands



TS99(N product label sample (F100)



TS 99N product label sample (F200)



T99N product label sample (F300)



TS99N product label sample (F400)



CTM-200 product label sample (C100 system)



CTM-200 product label sample (C200 system)



CTM-200 product label sample (C300 system)



CTM-200 product label sample (C400 system)



WS99N product label sample
(F100 system)

WS99N product label sample
(C200 system)



Stylix table product label
sample (F100 system)

Phoenix table product label
sample (F100 system)



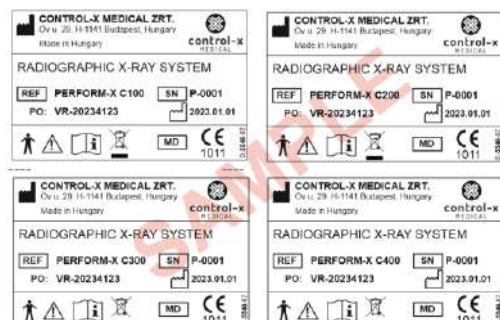







Phoenix 2 table product label
sample (C100 system)



F100-F400 system label samples

C100-C400 system label samples

The following is a list of symbols used on the product and the system labels:

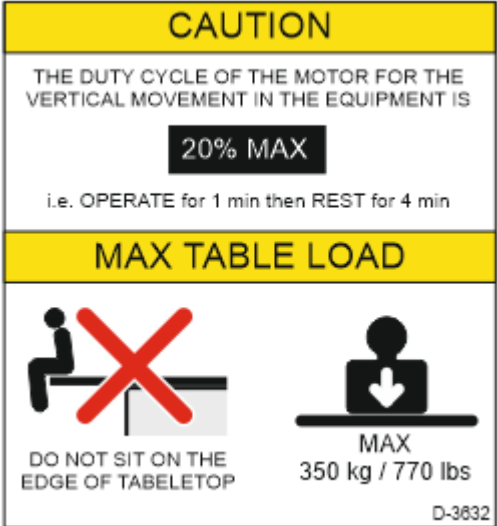
	ISO 15223 - 5.1.3	Date of manufacture – located on the labels.
	ISO 15223 - 5.1.1	Name and address of manufacturer – located on the product labels.
	ISO 15223 - 5.1.7	Serial Number of products – located on the labels.
	ISO 60417 - 5032	Single-phase AC main supply – located on the labels.
	ISO 15223 - 5.4.4	Caution – Refer to manual for additional safety information – located on the labels
	ISO 15223 - 5.4.3	Consult instruction for use – located on the labels
	ISO 7010 - M002	Refer to instruction manual – located on the product. (ISO 7010 M002)
	IEC 60417 - 5840	Type B applied part equipment – located on the labels
	IEC 60417 - 5019	Protective earth ground – located inside the equipment at the main grounding terminal
	ISO 7010 W024	Warning: crushing of hands. Avoid injury to hands when in the vicinity of equipment with closing mechanical parts – located on the product. (ISO 7010 W024)
	EN 50419	This product should not be disposed of in a landfill; the black bar indicates that the device was manufactured after 2005 – located on the labels.
		<p>Located on the side of the Phoenix table.</p> <ol style="list-style-type: none"> (1) The Phoenix elevating table is not designed for continuous vertical movement operation. To prevent damage to the equipment and to reduce risk of fire, the table can only be moved for a maximum of 60 seconds every 5 minutes. (There must be a 4-minute pause after each 60 second movement, giving a 20% duty cycle.) (2) Do not sit on or load at tabletop ends! The table may tip over. (3) Warning stating the maximum distributed table load.

2.6 OPERATORS

The Perform-X System is only to be operated by qualified radiology personnel authorized by local authorities to use radiographic diagnostic equipment.

Operators must have clear understanding of the hazard associated with taking X-ray radiograms and of working with patient positioning medical devices.

Operators' training is recommended for each operator before first using the equipment. For operator's training, please contact your local authorized distributor or Control-X Medical.

2.7 SERVICE PERSONNEL, INSTALLATION

The installation instructions (along with all the system documentation, including these operating instructions) are located in the packaging / crate marked with the following label:

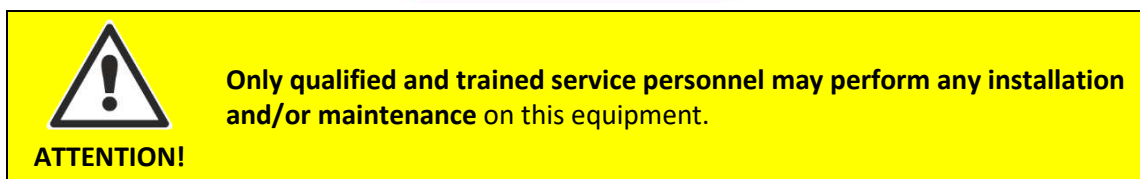

2.8 ENVIRONMENT, FREQUENCY OF USE AND MOBILITY

The Perform-X System is designed and manufactured to be used as a fixed equipment permanently installed in a professional hospital or clinical environment. The **patient environment** is the 1.5m proximity of the patient during the upright, table or special procedures and includes the radiographic stand and tables. The system control box is not part of the patient environment.

2.9 DOSIMETRIC INFORMATION

The Perform-X System is equipped with certified X-ray generators. For detailed and quantitative dosimetric information, please refer to the generator operating instructions.

2.9.1 Repetition of exposures

Pay attention to (local) skin dose levels under intended use in case of **repetitive** or **prolonged** exposure as it may cause tissue reactions.

2.10 INTERCHANGEABLE OR DETACHABLE PARTS

The Perform-X system does not contain any parts that are interchangeable or detachable by the operator or the service personnel.

3 SPECIFICATIONS

3.1 MECHANICAL DATA, MOTION RANGE

TS99N TUBE STAND MECHANICAL PARAMETER				CONDITION	VALUE				
F100	F200	F300	F400						
				C100	C200	C300	C400		
Recommended minimum floor-to-ceiling distance (room height)								standard TS99N	2400 mm
Recommended minimum floor-to-ceiling distance (room height) with EXTENDED stand height								extended TS99N-EXT	2600 mm
Minimum floor space (without generator)									8 m ² (2.5 x 3.2 m)
X-ray tube vertical travel								standard TS99N	1545 mm
								extended TS99N-EXT	1745 mm
X-ray tube focus-to-floor distance								standard TS99N	335 ... 1880 mm
								extended (TS99N-EXT)	335 ... 2080 mm
Tube stand floor rail length								standard rail length (PFX-R247)	2470 mm
								extended rail length (PFX-R360)	3600 mm
X-ray tube longitudinal movement								with standard FIXED column (P-type or M-type floor carriage)	1770 mm <i>(2900 mm with extended rail option)</i>
								with ROTATING column option (R-type or X-type floor carriage)	1590 mm <i>(2740 mm with extended rail option)</i>
X-ray tube column rotation for lateral exposures								with ROTATING column option (R-type or X-type floor carriage)	-180° ... +180° with -90° / 0° / 90° detents
X-ray tube transverse travel								with TRANSVERSE arm option (T-type tube arm)	+/- 106 mm
X-ray tube rotation (around horizontal axis)									+/- 180°
CTM-200 TUBE STAND MECHANICAL PARAMETER				CONDITIONS	VALUE				
F100	F200	F300	F400						
				C100	C200	C300	C400		
X-Ray tube vertical travel (CTM)									150 cm <i>(optionally 180 cm or 135 cm)</i>
X-Ray tube vertical movement speed								for C200 and higher models	15 cm/sec
Minimum X-Ray tube focus-to-floor distance									30 cm
Max. X-Ray tube focus to floor distance								depends on vertical travel and ceiling height	180 cm
X-Ray tube longitudinal travel								Manual longitudinal movement	357 cm
								Motorized longitudinal travel	343 cm
								<i>Optional extended movement with PX-2116</i>	<i>+140 cm</i>

X-Ray tube longitudinal rail length		440 cm <i>(Extendable in 70 cm increments with PX-2116)</i>
X-Ray tube longitudinal movement speed	for C300 and higher models	25 cm/sec
X-ray tube transversal travel	Manual transversal movement	207 cm
	Motorized transversal movement	203 cm with
	<i>Optional extended movement with PX-2116</i>	<i>+80 cm</i>
X-Ray tube transversal rail length		300 cm <i>(Option: 380 cm with PX-2117)</i>
X-Ray tube transversal movement speed	for C400 model	13 cm/sec
X-ray tube rotation (around horizontal axis)	total rotation: 334°	120° / -214°
X-ray tube rotation (around vertical axis)	total rotation: 360°	180° / -180°
WALL STAND MECHANICAL PARAMETER		
	<div style="display: flex; justify-content: space-between; align-items: center;"> <div style="display: flex; gap: 5px;"> F100 F200 F300 F400 C100 C200 C300 C400 </div> <div style="text-align: center;"> CONDITIONS </div> <div style="text-align: center;"> VALUE </div> </div>	
Mounting	standard	Floor-to-wall
	with option PFX-2035	Floor only
Detector STANDARD vertical travel	with bucky CXB-17 (TS99N)	1450 mm
	with grid cabinet SGC (TS99N)	1530 mm
Detector EXTENDED vertical travel	with bucky CXB-17 (TS99N-EXT)	1650 mm
	with grid cabinet SGC (TS99N-EXT)	1730 mm
STANDARD detector center-to-floor distance	with bucky CXB-17 (TS99N)	380 ... 1830 mm
	with grid cabinet SGC (TS99N)	300 ... 1830 mm
EXTENDED detector center-to-floor distance	with bucky CXB-17 (TS99N-EXT)	380 ... 2030 mm
	with grid cabinet SGC (TS99N-EXT)	300 ... 2030 mm
Detector tilt range	(manual or motorized tilting device)	-25 ... +90°

PATIENT TABLE MECHANICAL PARAMETER								CONDITIONS	VALUE
F100	F200	F300	F400	C100	C200	C300	C400		
Tabletop surface									810 x 2200 mm, 810 x 200 mm (optional) 810 x 1850 mm (optional) 810 x 2000 mm (optional)
Tabletop transverse movement									+ / - 125 mm
Tabletop longitudinal movement								left / right direction	560 mm / 470 mm
Tabletop height								Stylix fixed height table	fixed at 750 mm
								Phoenix 1 elevating table	550 ... 850 mm
								Phoenix 2 elevating table	450 ... 900 mm
Tabletop vertical movement								Stylix fixed height table	N/A
								Phoenix 1 elevating table	300 mm
								Phoenix 2 elevating table	450 mm
Table top vertical movement speed:								Stylix fixed height table	N/A
								Phoenix 1 & 2 table	approx. 22 mm / sec
Vertical exposure position (distance from floor)								Stylix fixed height table	750 mm, fixed
								Phoenix 1 & 2 only	750 mm (adjustable during installation)
Elevating table safety functions								Phoenix 1 / 2 table	Double-kick (optional) Crash-guard Audible warning
								Phoenix 2 table ONLY	Crash-guard with automatic upward movement upon touching an obstruction
Table detector horizontal movement								with bucky CXB-17	550 mm
								with grid cabinet SGC	610 mm
Tabletop maximum distributed load (equivalent to maximum patient weight)								no additional accessories for table procedures	350 kg
Maximum tabletop-to-image receptor distance									70 mm

3.2 X-RAY PARAMETERS

Wall bucky and tabletop Al equivalency		< 0.3 mm Al
Cassette size		According to ISO 4090
Bucky grid type	with CXB-17	Fixed, oscillating grid
Grid cabinet grid type	with SGC WALL/TABLE	Removable, non-oscillating grid
AEC detector	optional	3-field ion chamber or solid-state detector with preamp (optional 5-field ion chamber)
Shortest irradiation time	with AEC (recommended)	10 ms
	without AEC	1 ms
Longest possible exposure	limited by flat panel	Typically 2.5 sec
	limited by X-ray generator	Maximum 6 sec

For detailed X-ray parameter ranges and accuracy, please refer to the X-ray generator accompanying documents.

For the following specifications please refer to the X-ray tube datasheet:

- maximum symmetrical radiation field size
- focal spot size
- target angle.

3.3 POWER SUPPLY

WS99N wall bucky stand and	24VDC, 100VA (powered from system control box)
TS99N X-ray tube stand (including collimator light field)	24VDC, 140VA (powered from system control Box)
CTM-200 X-ray tube stand (including collimator light field)	: 1 x 110-240V AC 50/60 Hz / 640 VA (powered from system control Box)
Stylix fixed height radiographic table	24V AC 50/60 Hz / 50 VA
Phoenix elevating radiographic table	1 x 230V AC 50/60 Hz / 850 VA
Supply mains internal impedance	<i>Refer to the generator and flat panel display documentation (0.2 Ohms if otherwise not specified by the generator or flat panel)</i>

3.4 ENVIRONMENTAL DATA

Storage and transport temperature	-20°C – 55°C
Operating temperature	10°C – 40°C
Maximum relative humidity (operation)	80%
Maximum relative humidity (storage)	90%
Environmental protection	IP20

3.5 USAGE CONDITIONS

Exposure cycle time without positioning	Typically 10 sec depending on DR components
Exposure cycle time including positioning	Approx. 1 min. depending on previous system position and DR components
Useful expected life time	10 years (with proper maintenance and average case load of 30 positioning cycles per day)

3.6 APPLIED PARTS

The Perform-X Radiographic System contains the following applied parts that may come into contact with the patient:

1. Wall detector / cassette holder cover
2. Wall detector overhead patient grip
3. Tabletop (if applicable).



Do not touch the unused (unplugged) electrical sockets / connections on the equipment, e.g. the RJ45 (Ethernet) socket on the back of the WS99N.

WARNING!



No additional MULTIPLE SOCKET plus OUTLET or extension cord shall be connected to the Perform-X System.

WARNING!



Connect only the items that have been specified as part of the Perform-X System or that have been specified as being compatible with the Perform-X System

WARNING!

3.7 CLASSIFICATION

Protection against electric shock	 Type B equipment
Safety classification as a medical device / radiographic system <i>(classification is based on MDD annex IX rule 10)</i>	Class II/b medical equipment

3.8 ELECTROMAGNETIC COMPATIBILITY

Guidance and manufacturer's declaration – electromagnetic emissions		
The Perform-X Radiographic System is intended for use in the electromagnetic environment specified below. The owner or operator of the Perform-X Radiographic System should assure that it is used in such an environment.		
Emissions test	Compliance	Electromagnetic environment – guidance
RF emissions CISPR 11	Group 1	The Perform-X Radiographic System uses RF energy only for its internal function. Therefore, its RF emissions are very low and are not likely to cause any interference with nearby electronic equipment.
RF emissions CISPR 11	Class A+20dB	The Perform-X Radiographic System is suitable for use in all establishments other than domestic. It may however be used in domestic establishments and those directly connected to the public low-voltage power supply network that supplies buildings used for domestic purposes, provided the following warning is heeded:
Harmonic emissions IEC 61000-3-2	not applicable	
Voltage fluctuations / flicker emissions IEC 61000-3-3	not applicable	
<ul style="list-style-type: none"> This equipment/system is intended for use by healthcare professionals only. This equipment/ system may cause radio interference or may disrupt the operation of nearby equipment. It may be necessary to take mitigation measures, such as re-orienting or relocating the Perform-X Radiographic System or shielding the location; The Perform-X Radiographic System must be used only in a shielded location with a minimum RF shielding effectiveness and, for each cable that exits the shielded location, a minimum RF filter attenuation of 20dB for radio signals between 30MHz ... 1000MHz. 		

Guidance and manufacturer's declaration – electromagnetic immunity			
The Perform-X Radiographic System is intended for use in electromagnetic environment specified below. The owner or operator of the Perform-X Radiographic System should assure that it is used in such an environment.			
Immunity test	IEC 60601 test level	Compliance level	Electromagnetic environment – guidance
Electrostatic discharge (ESD) IEC 61000-4-2	± 6 kV contact ± 8 kV air	± 6 kV contact ± 8 kV air	Floors should be wood, concrete or ceramic tile. If floors are covered with synthetic material, the relative humidity should be at least 30%.
Electrical fast transients/ bursts IEC 61000-4-4	± 2 kV for power supply lines ± 1 kV for input/ output lines	± 2 kV for power supply lines ± 1 kV for input/ output lines	Mains power quality should be that of a typical commercial or hospital environment.
Surge IEC 61000-4-5	± 1 kV differential mode ± 2 kV common mode	± 1 kV differential mode ± 2 kV common mode	Mains power quality should be that of a typical commercial or hospital environment.

Guidance and manufacturer's declaration – electromagnetic immunity			
Voltage dips, short interruptions and voltage variations on power supply input lines IEC 61000-4-11	< 5% U _T (>95% dip in U _T) for 0.5 cycle 40% U _T (60% dip in U _T) for 5 cycles 70% U _T (30% dip in U _T) for 25 cycles < 5% U _T (>95% dip in U _T) for 5 sec	< 5% U _T (>95% dip in U _T) for 0.5 cycle 40% U _T (60% dip in U _T) for 5 cycles 70% U _T (30% dip in U _T) for 25 cycles < 5% U _T (>95% dip in U _T) for 5 sec	Mains power quality should be that of a typical commercial or hospital environment. If the operator of the Perform-X Radiographic System requires continued operation during power mains interruptions, it is recommended that the Perform-X Radiographic System be powered from an uninterruptible power supply.
Power frequency (50/60 Hz) magnetic field IEC 61000-4-8	3 A/m	3 A/m	Power frequency magnetic fields should be at levels characteristics of a typical location in a typical commercial or hospital environment.
Note: U _T is the AC mains voltage prior to application of the test level.			

Guidance and manufacturer's declaration – electromagnetic immunity			
The Perform-X System is suitable for use in the electromagnetic environment specified below. The owner or the operator of the Perform-X System should assure that it is used in such an electromagnetic environment.			
IMMUNITY test	IEC 60601 TEST LEVEL	Compliance level	Electromagnetic environment – guidance
Conducted RF IEC 61000-4-6	3 Vrms 150 kHz to 80 MHz outside ISM bands ^a 10 Vrms 150 kHz to 80 MHz in ISM bands ^a		The Perform-X System must be used only in a shielded location with a minimum RF shielding effectiveness and, for each cable that enters the shielded location, a minimum RF filter attenuation of 20 dB. See <i>Perform-X Radiographic System Technical Manuals, Section 4.4</i> . Field strengths outside the shielded location from fixed RF transmitters, as determined by an electromagnetic site survey, should be less than 3 V/m. ^b Interference may occur in the vicinity of equipment marked with the following symbol:
Radiated RF IEC 61000-4-3	10 V/m 80 MHz to 2,5 GHz		
Note 1: These guidelines may not apply in all situations. Electromagnetic propagation is affected by absorption and reflection from structures, objects and people. Note 2: It is essential that the actual shielding effectiveness and filter attenuation of the shielded location be verified to assure that they meet the minimum specification.			

^a The ISM (industrial, scientific and medical) bands between 150 kHz and 80 MHz are 6,765 MHz to 6,795 MHz; 13,553 MHz to 13,567 MHz; 26,957 MHz to 27,283 MHz; and 40,66 MHz to 40,70 MHz.

^b Field strengths from fixed transmitters, such as base stations for radio (cellular/cordless) telephones and land mobile radios, amateur radio, AM and FM radio broadcast and TV broadcast cannot be predicted theoretically with accuracy. To assess the electromagnetic environment due to fixed RF transmitters, an electromagnetic site survey should be considered. If the measured field strength outside the shielded location in which the Perform-X System is used exceeds 3 V/m, observe the Perform-X System to verify normal operation. If abnormal performance is observed, additional measures may be necessary, such as relocating the Perform-X System or using a shielded location with a higher RF shielding effectiveness and filter attenuation.

Guidance and manufacturer’s declaration – electromagnetic immunity

The Perform-X System is suitable for use in the electromagnetic environment specified below. The customer or the user of the Perform-X System should assure that it is used in such an electromagnetic environment.

IMMUNITY test	IEC 60601 TEST LEVEL	Compliance level	Electromagnetic environment – guidance
Conducted RF IEC 61000-4-6	3 Vrms 150 kHz to 80 MHz		The Perform-X System must be used only in a shielded location with a minimum RF shielding effectiveness and, for each cable that enters the shielded location, a minimum RF filter attenuation of 20 dB. See <i>Perform-X Radiographic System Technical Manuals, Section 4.4</i> . Field strengths outside the shielded location from fixed RF transmitters, as determined by an electromagnetic site survey, should be less than 3 V/m. ^a Interference may occur in the vicinity of equipment marked with the following symbol: 
Radiated RF IEC 61000-4-3	3 V/m 80 MHz to 2,5 GHz		



Note 1: These guidelines may not apply in all situations. Electromagnetic propagation is affected by absorption and reflection from structures, objects and people.

Note 2: It is essential that the actual shielding effectiveness and filter attenuation of the shielded location be verified to assure that they meet the minimum specification.

^a Field strengths from fixed transmitters, such as base stations for radio (cellular/cordless) telephones and land mobile radios, amateur radio, AM and FM radio broadcast and TV broadcast cannot be predicted theoretically with accuracy. To assess the electromagnetic environment due to fixed RF transmitters, an electromagnetic site survey should be considered. If the measured field strength outside the shielded location in which the Perform-X System is used exceeds 3 V/m, the Perform-X System should be observed to verify normal operation. If abnormal performance is observed, additional measures may be necessary, such as relocating the Perform-X System or using a shielded location with a higher RF shielding effectiveness and filter attenuation.

4 OPERATOR CONTROLS

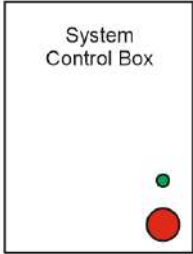
4.1 SYSTEM CONTROL BOX

Symbol / Control	Operation
	 <p>SYSTEM POWER indicator. When lit green, the system is powered up.</p>
	 <p>EMERGENCY STOP Switch Push it to fully power off the system. Turn the knob to the right to switch the system back on again.</p>

4.2 TUBE STAND MANUAL MEMBRANE CONSOLES

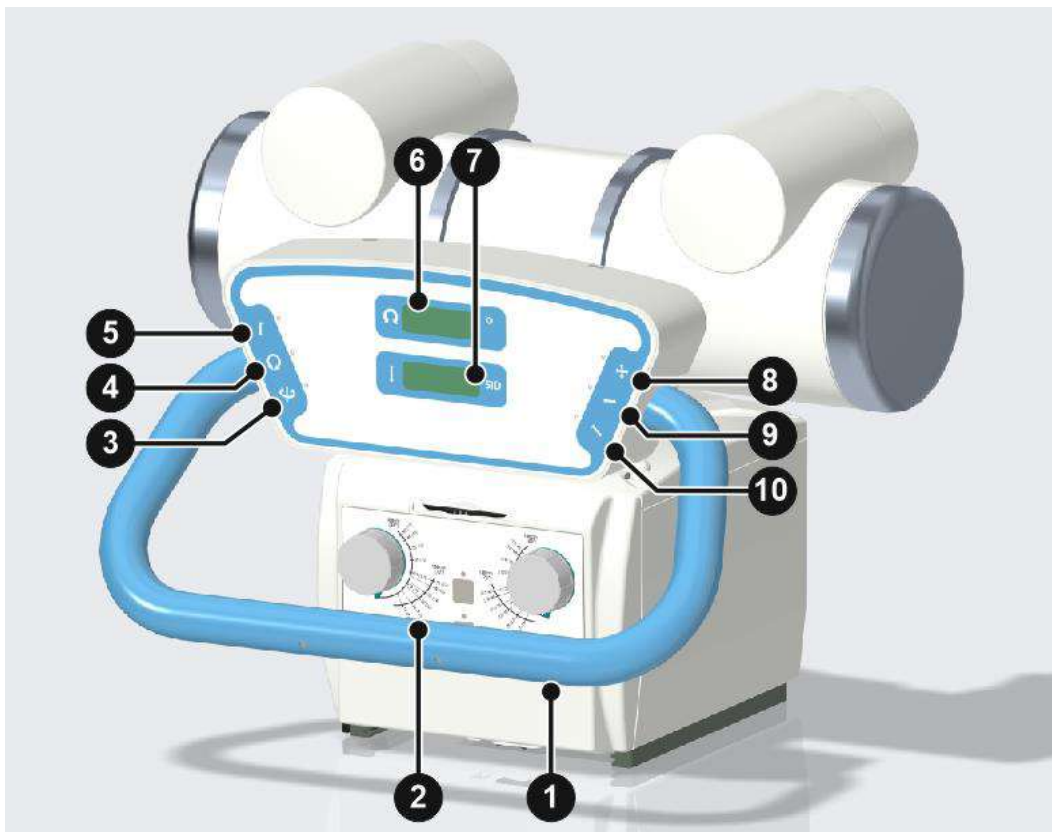

F100 / C100 Membrane Console with SID Display

- F100
- F200
- F300
- F400
- C100
- C200
- C300
- C400

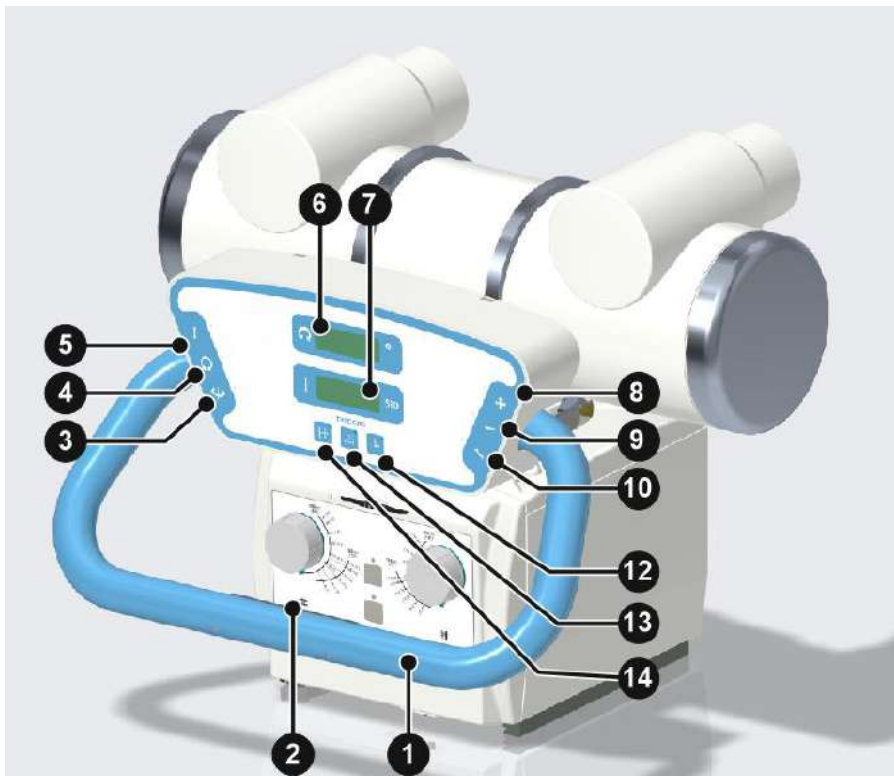

F200 / C200 Membrane Console with SID Display

- F100
- F200
- F300
- F400
- C100
- C200
- C300
- C400

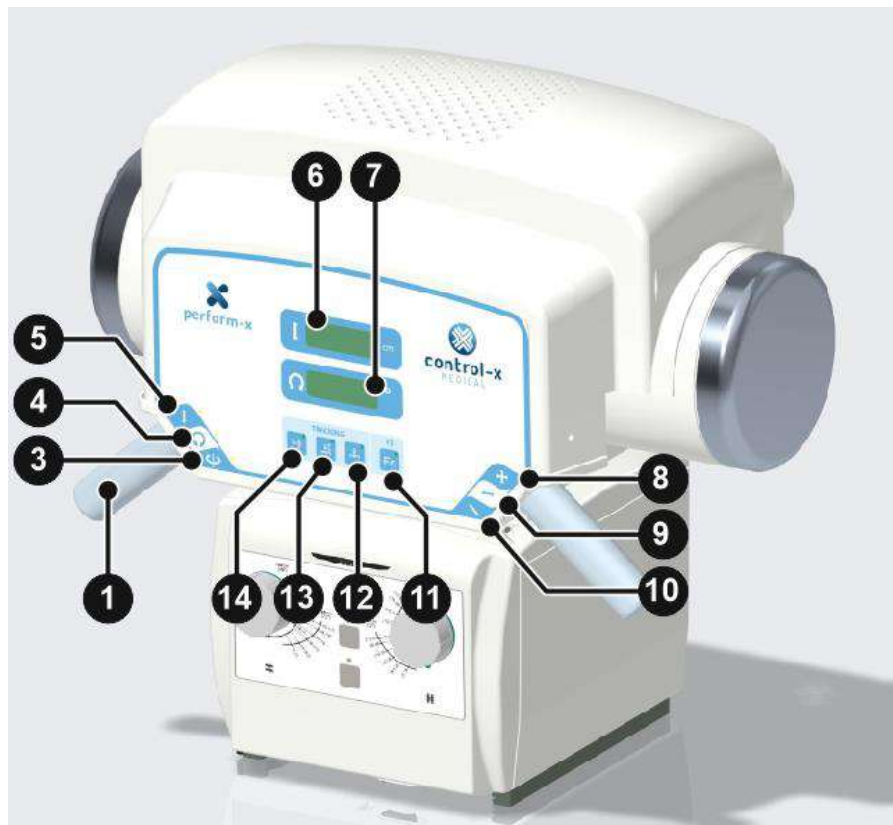

F200 / C200 Membrane Console for plastic X-ray tube covers

1		Console grip
2		Linear movement brake release for manual tube movement in longitudinal (left-right), transversal (backwards-forwards) and vertical directions.
3		Brake release for COLUMN or TELESCOPE ROTATION (pivot)
4		Brake release for X-ray TUBE ROTATION
5		Brake release for VERTICAL movement
6		X-ray TUBE ROTATION display
7		SID (source image distance) display
8		Brake release for VERTICAL and LONGITUDINAL (horizontal) movement
9		Brake release for LONGITUDINAL (horizontal) movement
10		Brake release for TRANSVERSAL manual movement
11		Turn the table receptor auto-centering on or off. When turned on, the green LED indicator next to the button turns on and the receptor starts moving until centered with the X-ray tube. When the auto-centering function is on, any manual tube movement or tube rotation will cause the table receptor to start moving to find the beam center. Similarly, any manual receptor movement will cause the X-ray tube to start moving to find the receptor center.
12		Turn the constant vertical SID to the table detector on or off. When turned on, the green LED indicator next to the button turns on and the table starts moving vertically until the original vertical SID is reached. When the constant vertical SID function is on, any manual tube vertical movement will cause the table to start moving vertically to find the original SID. Similarly, any manual table vertical movement will cause the X-ray tube to start moving vertically to find the original vertical SID.
13		Turn on the vertical auto-tracking function of the wall receptor . When turned on, the green LED indicator next to the button turns on and the wall receptor starts moving vertically to find the beam center. When the auto-tracking function is on, any manual tube vertical movement will cause the wall receptor table to start moving vertically to find the beam center. Similarly, any manual wall receptor vertical movement will cause the X-ray tube to start moving vertically to find the wall receptor center.

14		
-----------	---	--

Note: the LEDs next to each brake release buttons are lit when the corresponding brake is

4.3 PXIM CONSOLE TUBE STAND LCD TOUCHSCREEN

F100 F200 F300 F400 C100 C200 C300 C400



Depending on configuration, the PXIM (Perform-X Integrated Modulars) console provides control for a full range of functions:

- manual device positioning, including 3 modes (vertical with wall stand and table and horizontal with table receptor) of auto-tracking,
- freely programmable and APR-based device positioning,
- vertical and horizontal stitching,
- X-ray (generator) parameter control,
- image preview and study list,
- collimator camera view,
- positioning guide.

4.3.1 Physical Buttons and Controls



ATTENTION! In order to ensure proper functioning of the touchscreen and avoid false input or unintended parameter changes, always make sure that your **hands are dry** and there are **no waterdrops, dirt or other residue** on the surface of the screen.

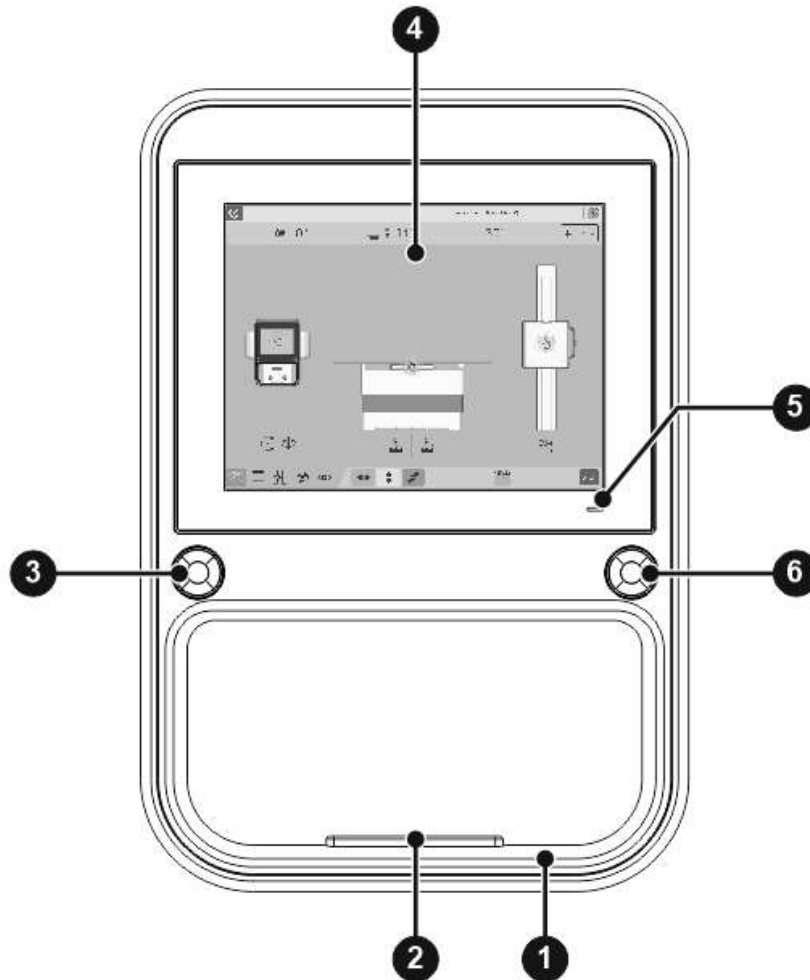

1	Console grip
2	Linear movement brake release for manual tube movement in longitudinal (left-right), transversal (backwards-forwards) and vertical directions. The three linear directions can be individually disabled for precise and selective positioning. For details refer to <i>section 4.6.2 / (13)-(15)</i> .
3	RIGHT side multi-directional buttons <i>See default operation below</i>
4	LCD touch screen area – for details see sections below
5	PXIM console power on indicator
6	LEFT side multi-directional buttons <i>See default operation below</i>

FLOOR MOUNTED SYSTEMS
MULTI-FUNCTION BUTTONS
DEFAULT OPERATION

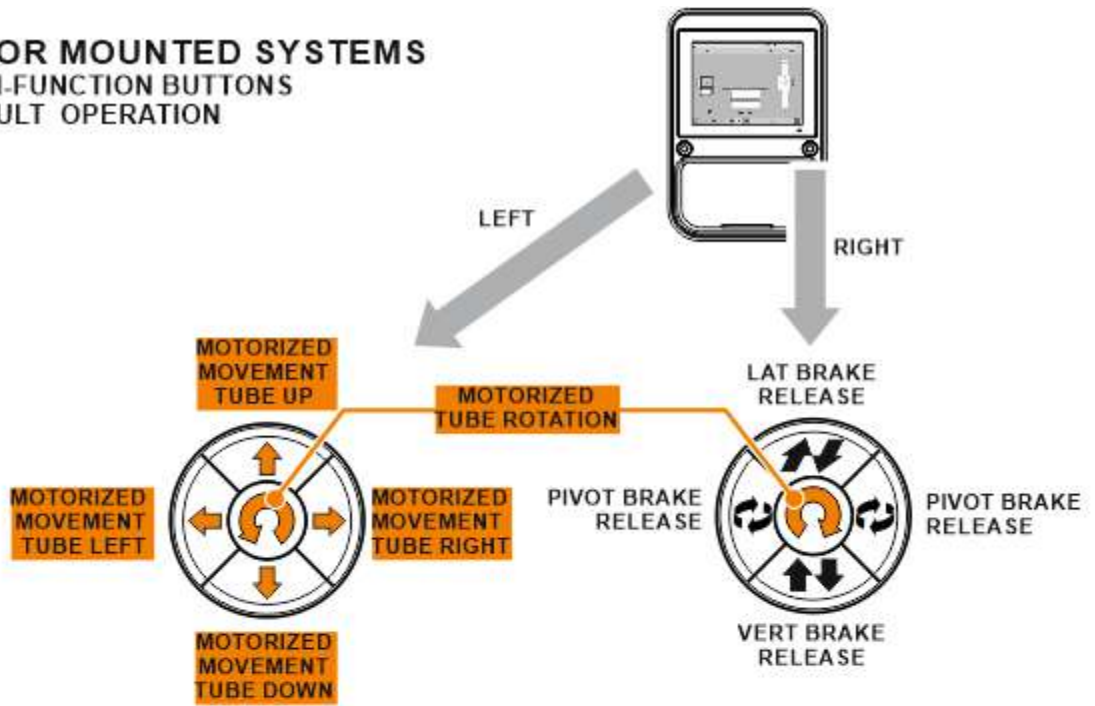

CEILING MOUNTED SYSTEMS
MULTI-FUNCTION BUTTONS
DEFAULT OPERATION

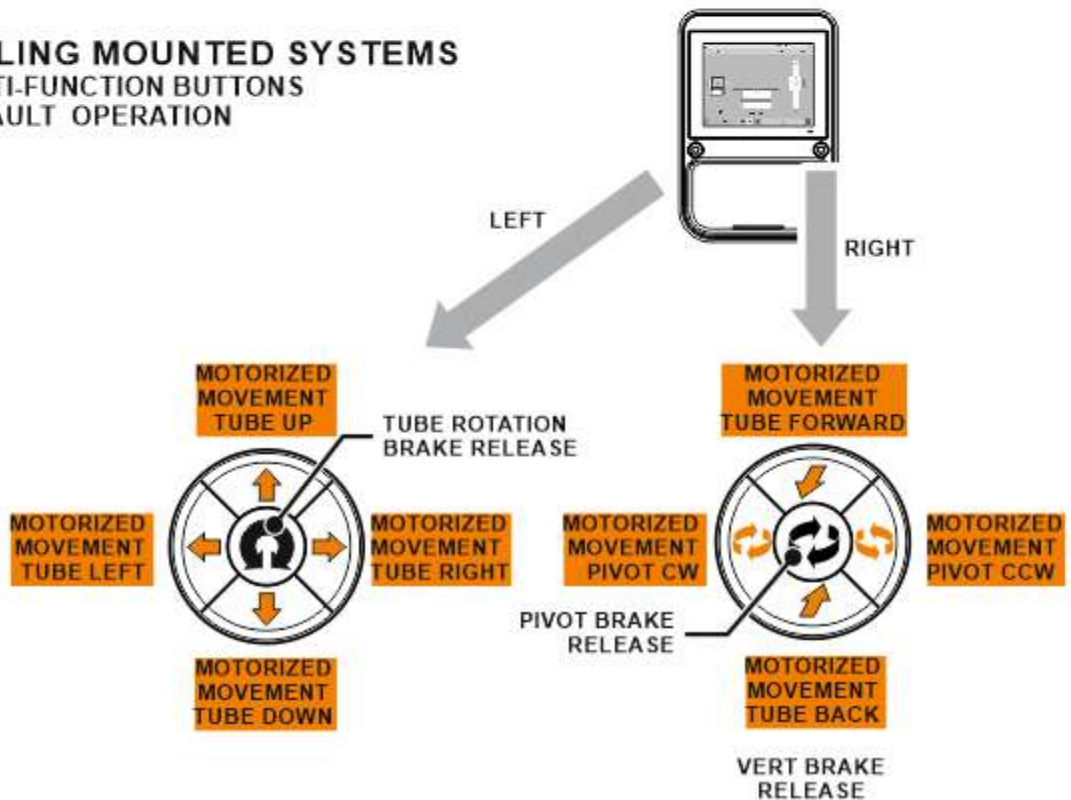

To customize the functions of the multi-function buttons using the PXIM Service Application, please contact your service partner.

Note the multi-function button groups are orientation-sensitive. Movement directions will follow the natural orientation of the directional button. For example, when buttons are configured for vertical and horizontal movement control, their functions adapt to console orientation:

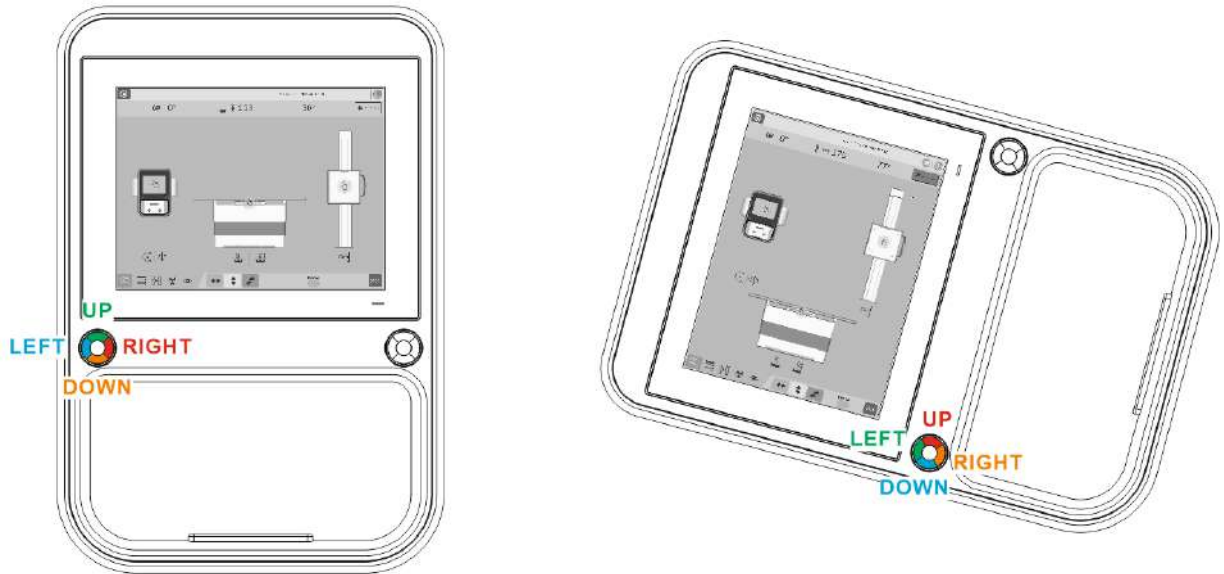

4.3.2 PXIM Console Main Screen Areas

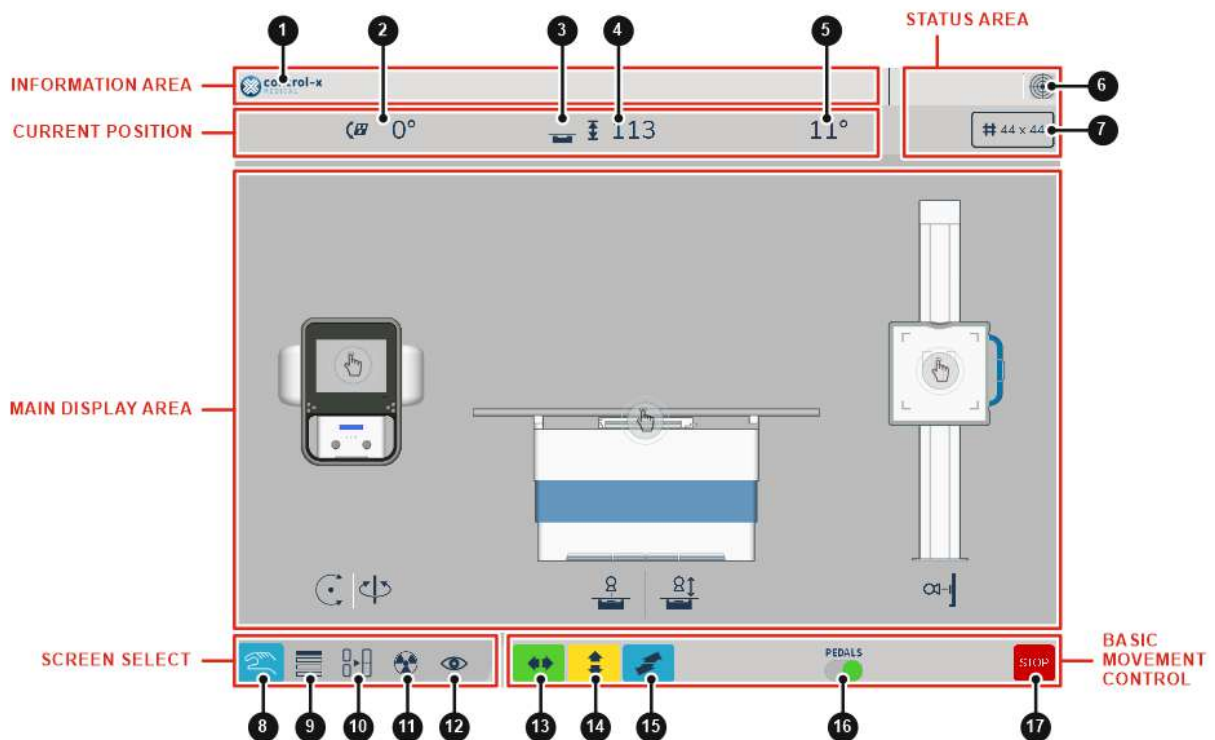

INFORMATION AREA

Depending on the operating mode and error status, different messages appear in this area.

1	Context-sensitive area to provide information on the current mode: <ul style="list-style-type: none"> • Name of the selected preset or APR position • Error message • Patient information
----------	--

CURRENT POSITION

The most important parameters of the current position of the device is always visible on the screen.

2	Wall receptor tilt angle
3	Selected / active workstation (receptor). The workstation is automatically selected based on device position (beam direction).
4	SID value (vertical or horizontal depending on currently selected workstation)
5	Tube rotation value

STATUS AREA

6	'In target position' indicator. Green lines across the bulls-eye icon indicate that: <ul style="list-style-type: none"> • the X-ray tube and table or wall receptor are centered and the auto-tracking movement is completed or • the device is in the preprogrammed position and motorized movement is completed.
7	Collimator light field status. Tap this button to swap between manual and automatic light field mode. <ul style="list-style-type: none"> • Orange background: manual light field mode. The light field does not adjust with SID change. • Gray background: automatic mode. The light field does not adjust with SID change. Light field is also limited to the size of the receptor. • Red background: the light field is currently being adjusted. Motorized movement of the shutters is in progress.

MAIN DISPLAY AREA

The main screen area displays screen- and mode-specific content (see *sections 4.6.3 – 4.6.9* below for details on each screen).

SCREEN SELECT

The information and controls on the PXIM touch-screen console are organized into **screens**. Tapping on a tab in the bottom left corner selects one of the main screens of the PXIM console.

8	Select the manual positioning screen
9	Select the preprogrammed and APR positions screen
10	Select the stitching screen
11	Select the generator control (X-ray parameters) screen
12	Select the image preview, study list and positioning guide screen

BASIC MOVEMENT CONTROL

The basic movement controls are always visible on the screen to provide quick and safe positioning control by hand or foot.

13	Enable the brake release pushbutton in the console grip for longitudinal (left-right) manual movement by hand
14	Enable the brake release pushbutton in the console grip for vertical (up-down) manual movement by hand
15	Enable the brake release pushbutton in the console grip for transverse (back-front) manual movement by hand
16	Enable or disable elevating table vertical movement when stepping on the table foot pedals .
17	STOP all motorized movements immediately.

4.3.3 Automatic screen rotation

The screen automatically changes between portrait and landscape orientation based on the X-ray tube angle for readability.

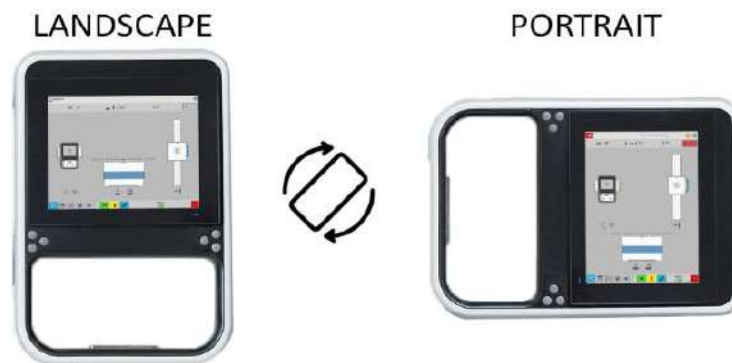







Landscape and portrait orientation

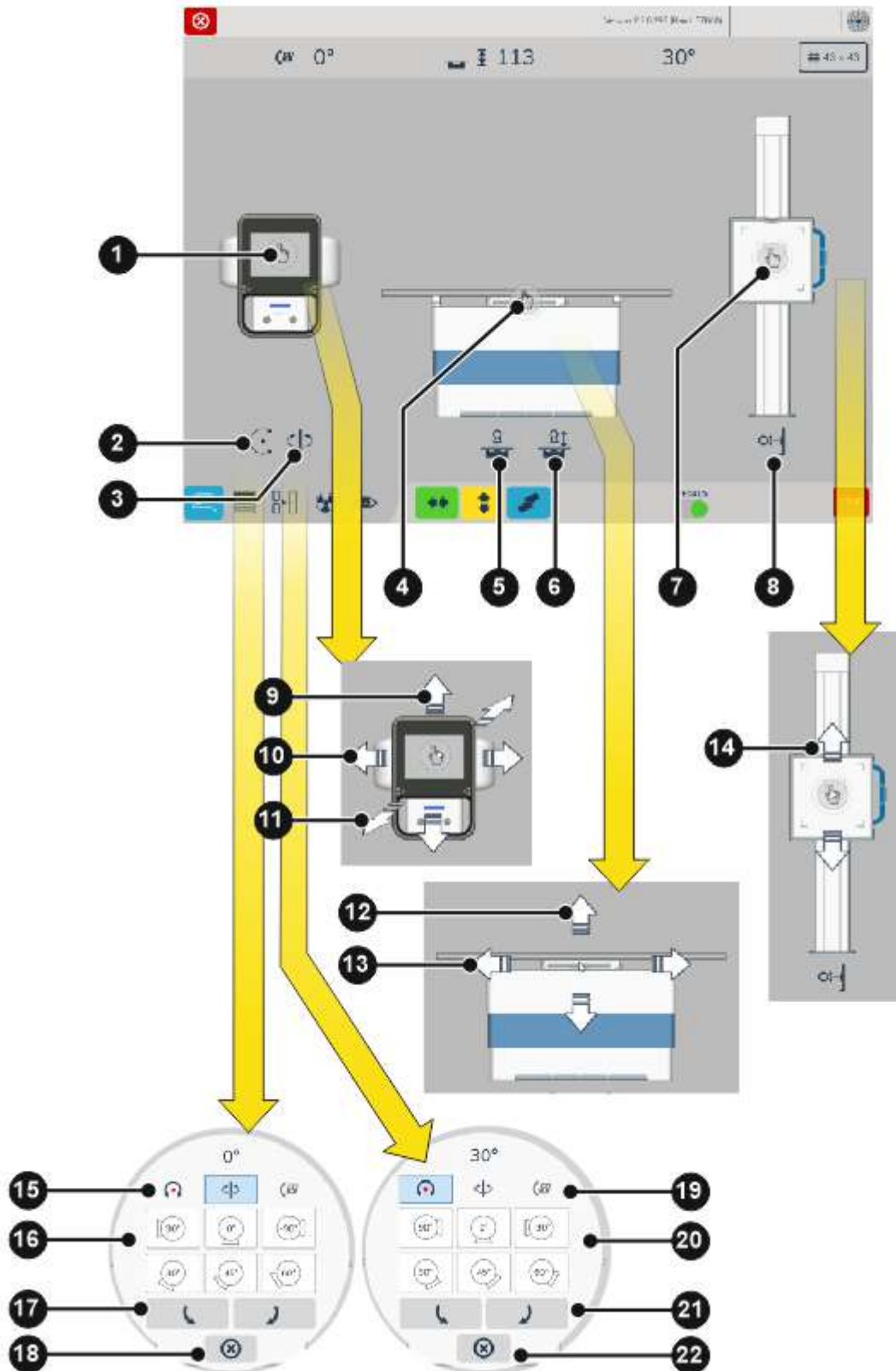



Please note that when tube rotation is performed using the touch screen (clockwise or counter-clockwise), the screen does not change orientation until the touch screen is released.

4.3.4 Manual positioning screen

As an alternative to the control buttons, use the manual positioning screen to move the X-ray tube, the table receptor or the wall receptor to any position using motorized movements. It also provides controls to turn the auto-tracing functions on or off.



<p>1</p>		<p>Tap to move the X-ray tube. After tapping the icon, up to six arrows appear to start motorized movement:</p> <ul style="list-style-type: none"> • Tap UP or DOWN (8) for vertical movement • Tap LEFT or RIGHT (9) longitudinal movement • Tap BACK or FRONT (10) for transversal movement
<p>2</p>		<p>Tap the rotation icon to rotate the X-ray tube around the horizontal axis using motorized movements.</p> <p>When tapping the icon, additional controls appear in a circular area in the center of the screen with the following functions:</p> <ul style="list-style-type: none"> • TAP one of the buttons on the top (15) to select which rotational movement to adjust. For tube rotation, keep the default selection. • TAP one of the 6 preset tube rotation positions (16) to accurately rotate the X-ray tube into the desired position. Contact your service partner to change the rotational preset positions according to your frequently used projections. • TAP and HOLD (17) to rotate the X-ray tube into an arbitrary position. • TAP (18) to cancel tube rotation and dismiss the circular rotation control.
<p>3</p>		<p>Tap the pivot icon to rotate the X-ray tube around the vertical axis using motorized movements.</p> <p>When tapping the icon, additional controls appear in a circular area in the center of the screen with the following functions:</p> <ul style="list-style-type: none"> • TAP one of the buttons on the top (19) to select which rotational movement you'd like to adjust. For tube pivot, keep the default selection. • TAP one of the 6 preset tube rotation positions (20) to accurately pivot the X-ray tube into the desired position. Contact your service partner to change the pivot preset positions according to your frequently used projections. • TAP and HOLD (21) to pivot the X-ray tube into a freely selected position. • TAP (22) to cancel tube rotation and dismiss the circular rotation control. <p>PLEASE NOTE THAT THIS FUNCTION IS ONLY AVAILABLE FOR CEILING TUBE STANDS WITH MOTORIZED PIVOT FUNCTION.</p>
<p>4</p>		<p>Tap to move the table receptor.</p> <p>After tapping the icon, up to four arrows appear to start motorized movement:</p> <ul style="list-style-type: none"> • Tap UP or DOWN (12) for vertical tabletop movement • Tap LEFT or RIGHT (13) longitudinal receptor movement
<p>5</p>		<p>Tap to turn on the table receptor auto-centering. Once turned on, the icon background changes to green and the receptor starts moving until centered with the X-ray tube. When the auto-centering function is on, any manual tube movement or tube rotation will cause the table receptor to start moving to find the beam center. Similarly, any manual receptor movement will cause the X-ray tube to start moving to find the receptor center.</p> <p>Tapping the icon, a second time will turn off the table receptor auto-centering function (toggle function).</p>

<p>6</p>  	<p>Tap to turn on the constant vertical SID. Once turned on, the icon background changes to green and the table starts moving vertically until the original vertical SID is reached. When the constant vertical SID function is on, any manual tube vertical movement will cause the table to start moving vertically to find the original vertical SID. Similarly, any manual table vertical movement will cause the X-ray tube to start moving vertically to find the original vertical SID.</p> <p>Tapping the icon, a second time will turn off the constant vertical SID function (toggle function).</p>
<p>7</p> 	<p>Tap to move the wall receptor. After tapping the icon, two arrows appear to start motorized movement:</p> <ul style="list-style-type: none"> • Tap UP or DOWN (14) for vertical movement.
<p>8</p>  	<p>Tap to turn on the vertical auto-tracking function of the wall receptor. Once turned on, the icon background changes to green and the wall receptor starts moving vertically to find the beam center. When the auto-tracking function is on, any manual tube vertical movement will cause the wall receptor table to start moving vertically to find the beam center. Similarly, any manual wall receptor vertical movement will cause the X-ray tube to start moving vertically to find the wall receptor center.</p> <p>Tapping the icon, a second time will turn off the vertical auto-tracking function of the wall receptor (toggle function).</p>

4.3.5 Preprogrammed positions



<p>1</p>	<p>The list of preprogrammed positions. Positions can be programmed directly on the PXIM console or using the PXIM Service Application. Contact your service partner for information on editing the preset positions using the Service Application.</p> <p>The maximum number of preset positions is 255. If there are more presets configured than can fit on one screen, swipe the list for more presets on the next screen.</p>
----------	---

2	Each favorite position (e.g. frequently used projections) is indicated with a star. For faster workflow, positions may be filtered for favorites only for a quick selection of a projection for the current patient. See also control (6) of this section.
3	Selected preset. The selected position is indicated with blue highlight. When selecting a preset position, the devices do not automatically start moving into the prescribed position. After selecting the preset, verify that the target position is correct and tap Go to position (9) to initiate movement.
4	Add a new preset position. Adds the current device position to the preset list. You will be prompted to optionally give a descriptive name for the new preset position.
5	Edit (rename) the currently selected preset position.
6	Save the current true device position to the selected preset. Use the device memory selectors (7) to enable or disable movements to certain devices (X-ray tube, table or wall stand).
7	Tap on this icon to show favorite positions only . Tap a second time to show all positions . The color of the icon indicates whether all positions or only favorites are shown.
8	Workstation selectors. When saving (updating) a preset position, device movements for that particular position may be enabled or disabled. For example, when initiating an upright position for a wall receptor exposure, the table height and table receptor horizontal position can be disabled to optimize workflow and to avoid unnecessary table receptor movement.
9	Go to preset position. When tapped, the device will start to move into the selected preset position. The schematic of the position shows the target position of the selected preset. The animation also shows what motorized movements will be made when tapping the Go button.
10	Text label indicates whether the position schematic shows the target position or the animation of the upcoming movement.

4.3.6 APR Positioning

F100 F200 F300 **F400** C100 C200 C300 C400

When connected to a compatible image acquisition workstation, the PXIM console is aware which APR is selected in the acquisition application. It is possible to save and recall a default position to each APR selected in the modality software. The APR positioning function is activated on the preprogrammed positioning screen.

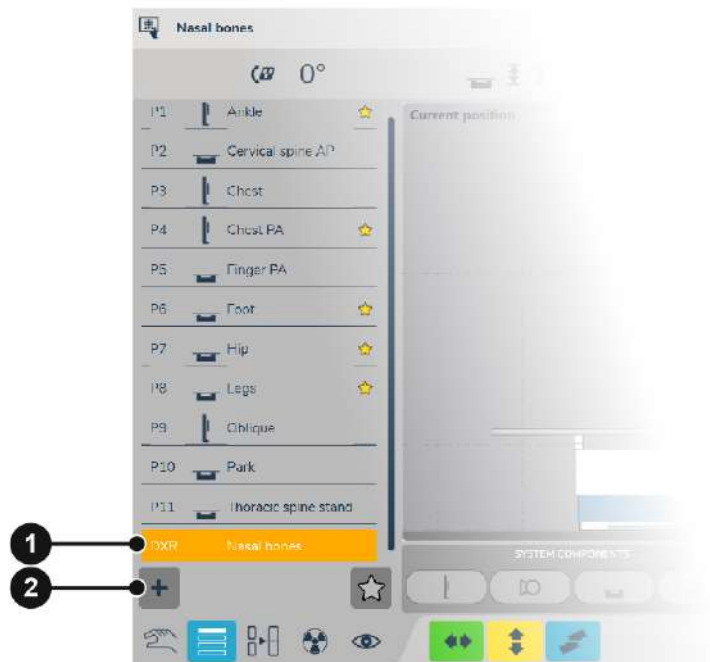

<p>1</p>	<p>When selecting an APR in the acquisition workstation, a special 'DXR' preset appears at the end of the preset list. If a device position has not been saved for a particular APR, the list item is displayed with an orange background. Once a device position is saved for an APR, the preset is displayed with normal (grey) background color. The name of the APR position is the same as the name of the APR in the acquisition workstation. (Please note that it is not possible to rename APR positions on the console.)</p>
<p>2</p>	<p>To save or update an APR position to the current device position, tap on the save icon.</p>

4.3.7 Stitching Mode Screen

The Perform-X system may be configured during installation for both **standard** and **smart** stitching functionality. Smart stitching is most effective in combination with an automatic collimator.

4.3.7.1 Standard Stitching Mode

In standard stitching mode the operator must set the number of exposures to be performed and initiate the procedure.

4.3.7.2 Smart Stitching Mode

The Perform-X **Smart Stitching** feature uses the PXIM console software to ensure optimal image stitching outcome – irrespective patient size – with the minimum necessary radiation dose.

Smart Stitching works with taking 2-5 individual overlapping images¹ and combining them into one seamless study. The procedure is performed with constant focus, rotating X-ray tube. Both horizontal and vertical stitching procedures are supported by the respective Perform-X models². A stitching stand is available to assist frail patients for vertical procedures.

The Stitching process consists of 3 phases

Start by selecting the receptor (wall stand or patient table) on the tube head display.



1	Tap the wall stand icon to select vertical stitching on the wall receptor.
2	Tap the table icon to select horizontal stitching on the table receptor.

¹ 2-3 in horizontal stitching on the patient table and 2-5 in vertical stitching at the wall stand.

² Vertical stitching (only) is available on Perform-X C300 and F300 systems. Additional horizontal stitching on the patient table requires Auto-Positioning features available on Perform-X C400 and F400 systems.



3	Tap the SID icon to adjust the desired SID. Longer SID provides less distortion at the edge of the stitched image, but requires mode dose.
4	Set start position of stitching process by moving the receptor to the start position. Tap the Start icon to mark the current detector position as the first frame (start of the ROI – region of interest).
5	Set end position of stitching process by moving the receptor to the end position. Tap the End icon to mark the current detector position as the last frame (end of the ROI – region of interest).
6	Tap the SET X-RAY TUBE (lock) icon to finalize the SID and ROI settings.

Stitching can be configured top to bottom or bottom to top as well as left to right or right to left. On this basis PXIM system software calculates the number of exposures to be made to achieve the necessary overlap and ideal stitched image and configures the collimator settings.

When the corresponding button changes its colour (from yellow) to green the system is ready to start the necessary exposures. Although the Smart Stitching process is fully automated in relation to system positioning, in accordance with mandatory safety rules each exposure must be made manually by the operator.

For **horizontal stitching** procedures where the table receptor is used, the stitching process may be composed of **up to 3 images**.

For **vertical stitching** procedures where the wall receptor is used, the stitching process may be composed of **up to 5 images**.

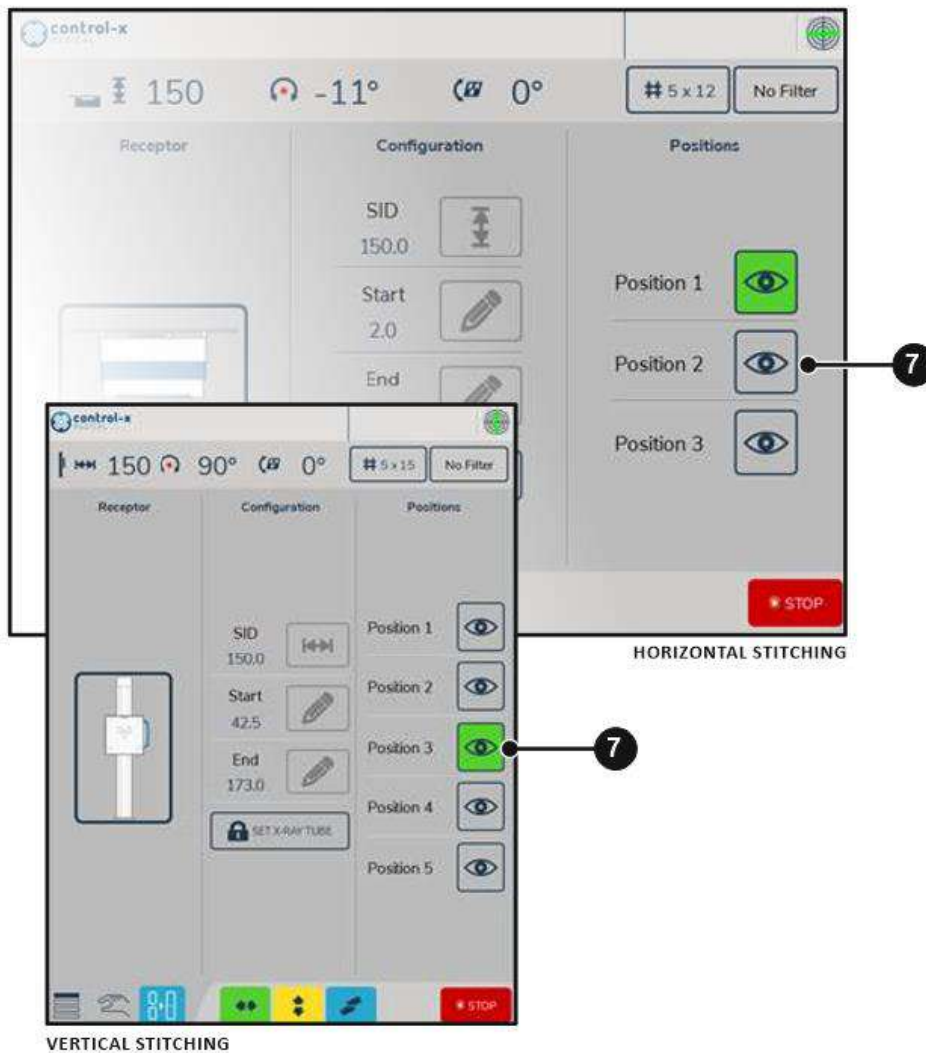

7	Stitching frames for horizontal and vertical stitching.
----------	---

How to perform the procedure

- Make sure to limit the light field in the transversal direction to minimize patient dose
- Make sure to properly mark the start and of the region of interest.
- Tube moves automatically into next pre-set position but the exposure button must be pressed for each individual shot
- in case a re-take is deemed necessary (e.g., on the basis of the image preview on the tube-head display) the following controls are available
 - All remote controls (wired remote at the table, wired remote at wall stand, wireless remote) can select next/previous shot
 - User interface allows for a direct selection of any specific shot

4.3.8 Generator Control screen

Perform-X systems with integrated generator controls can display and modify X-ray parameters using the generator control screen of the PXIM console.

All APRs appear with their default parameters and for most exposures, using the default values is recommended. However, depending on patient anatomy or other circumstances, the parameters can be changed at tube side.

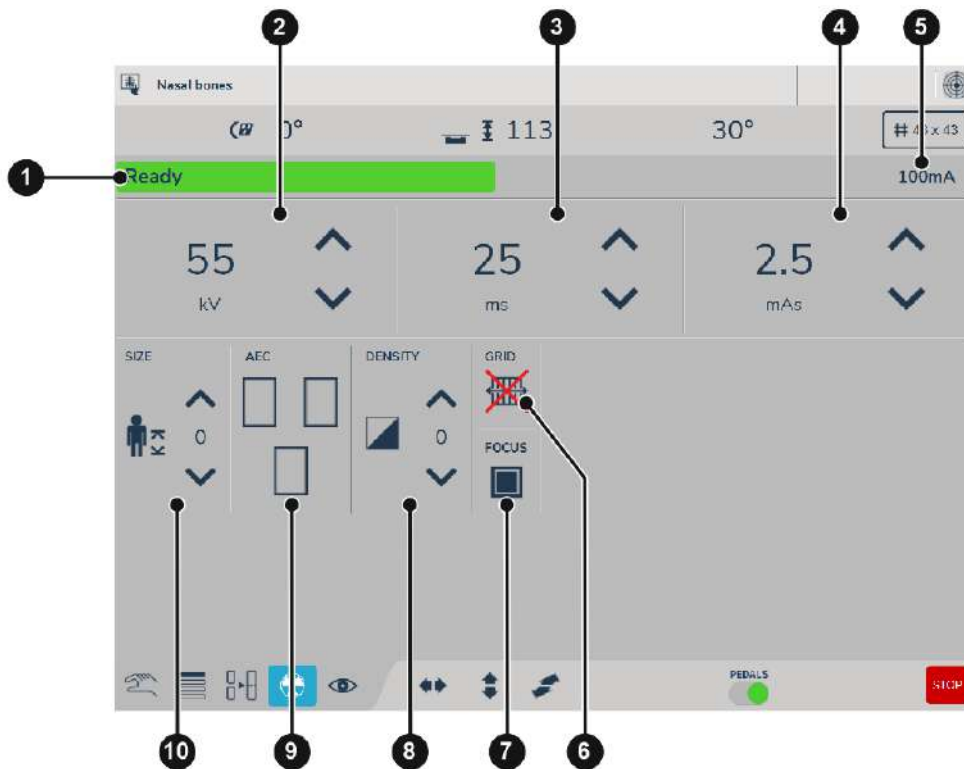

1	Generator status or error message.
2	kV (anode kVp) value and up / down controls
3	ms (exposure time) value and up / down controls
4	Primary mAs or mA controls. In mAs priority mode: mAs value and / down controls. In mA priority mode: mA value and / up / down controls. <i>To change mAs / mA priority mode, please contact your service partner.</i>
5	Calculated (secondary) parameter display. In mAs priority mode: calculated mA. In mA priority mode: calculated mAs. <i>To change mAs / mA priority mode, please contact your service partner.</i>
6	Anti-scatter grid on / off. Changing the grid setting may affect the main X-ray parameters (kV and mAs).
7	Small/ large focus select.
8	Optical density (exposure). The density control darkens or lightens by increasing or decreasing the exposure cut-off dose.
9	AEC field selectors. Select one or more AEC fields for exposures with Automatic Exposure Control. Switching off all field disables the AEC function.
10	Patient size control. Changing the patient size will automatically adjust the kV and mAs for optimal results.

4.3.9 Image preview and positioning guide screen

When connected to a compatible image acquisition workstation, the PXIM console is capable of displaying the following information related to the current study:

- Patient name and date of birth,
- Number of completed exposures (exposures already taken) in the study,
- List of incomplete exposures (exposure yet to be taken) in the study,
- List of completed exposures with thumbnails,
- Positioning guide to help prepare exposures,
- Preview of completed exposures.

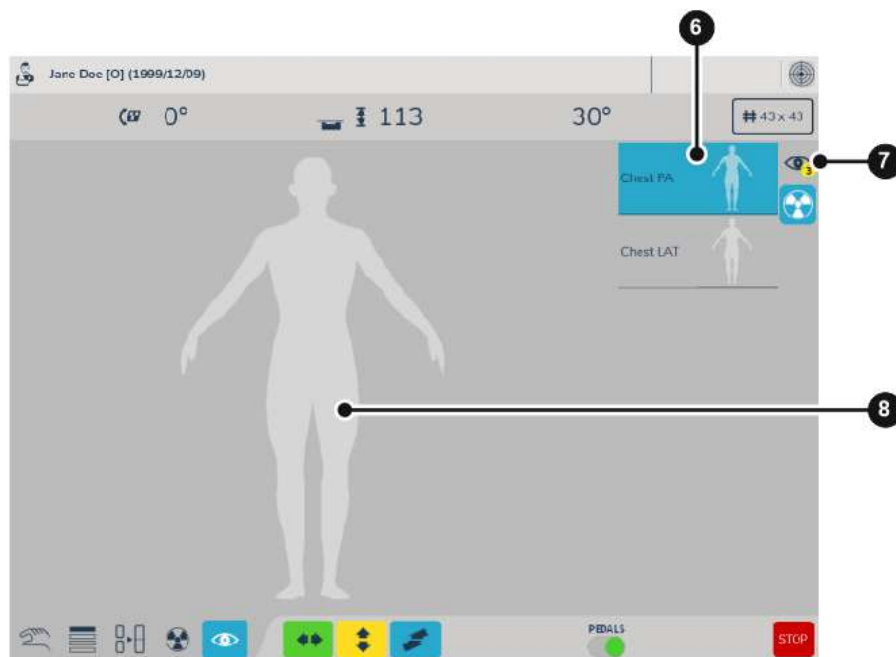

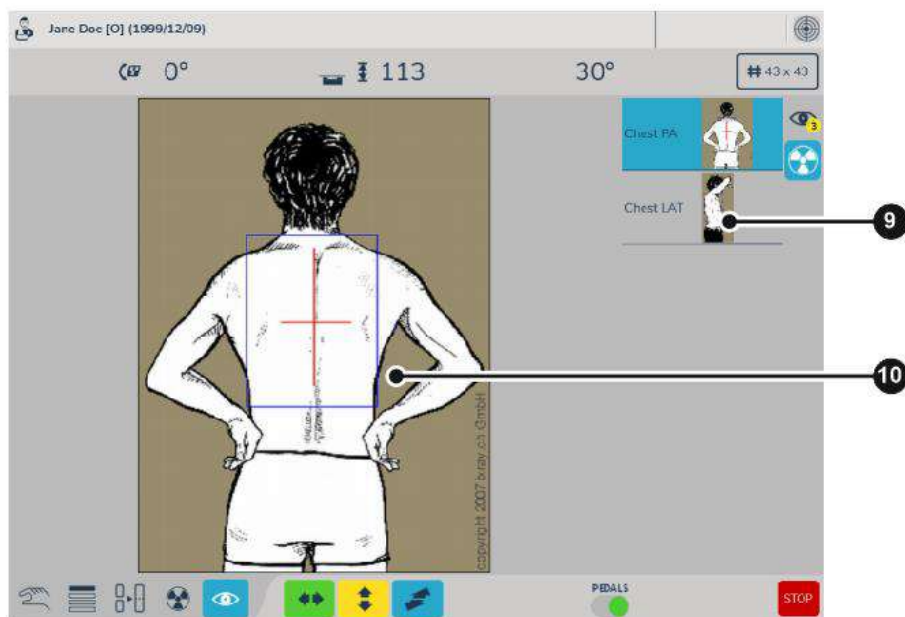

1	Patient information
2	List of completed exposure with thumbnails
3	Tap to select list of completed exposures for preview
4	Tap to select positioning guide for scheduled exposures
5	Image preview of the selected completed exposure
6	List of scheduled exposures. APRs with positioning guidance will display a generic human figure. If positioning guidance is available for the APR, a schematic drawing of the patient positioning is displayed.
7	Completed exposures list selector with number of completed exposures.
8	Generic human figure – for APRs with no patient positioning guidance.
9	For APRs with patient positioning guidance, a schematic drawing of the patient positioning is displayed.
10	Full size schematic drawing of the patient positioning for the selected APR.

4.4 WS99N WALL BUCKY STAND



The wall bucky stand operator controls:

- vertical brake release pushbutton
- bucky tilt mechanical fastener (with option T-type and M-type tilting device)
- the handle of the cassette tray

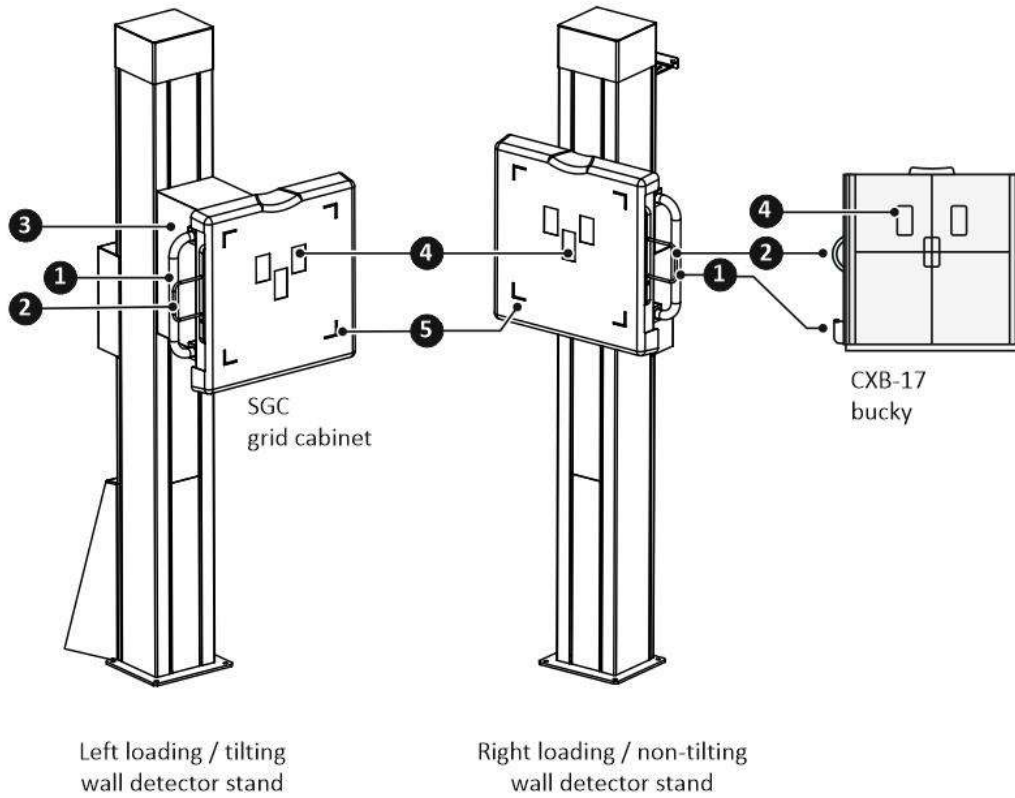

- 1 VERTICAL brake release pushbutton
- 2 Detector CASSETTE HANDLE
- 3 Detector TILT release – *ONLY* with option T-type tilting device (manual)
- 4 AEC field markers
- 5 IMAGE edge indicators

4.5 REMOTE CONTROLLER



The Perform-X system may be equipped with a wired or wireless remote control. Wireless remote controls are factory paired

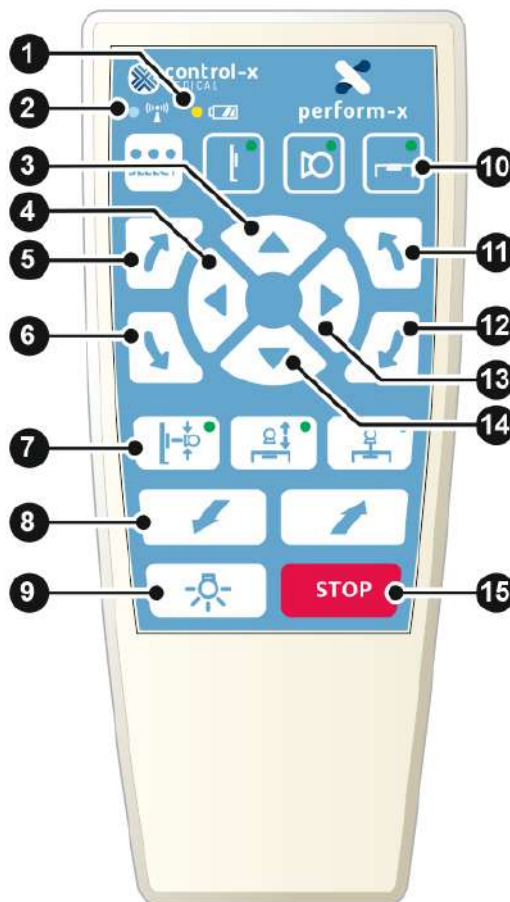

- 1 **Low battery** indicator (*wireless type only*)
- 2 **Connection status** (*wireless type only*)
A blinking blue connection status LED (2) indicated data transmission between the remote controller and the Perform-X system.
- 3 **Vertical movement** control (UP) for tabletop / X-ray tube / wall receptor
- 4 X-ray tube or table receptor **longitudinal movement** control (LEFT)
- 5 X-ray **tube rotation** around the horizontal axis (CLOCKWISE)
- 6 X-ray **tube rotation** around the horizontal axis (COUNTERCLOCKWISE)
- 7 **Auto-tracking** functions enabled/disabled
 - Wall stand auto-tracking
 - Table auto-tracking (Constant SID over the table receptor)
 - Table receptor auto-centering
- 8 **Transversal movement** controls (FORWARD / BACK) for the X-ray tube (for ceiling-mounted systems only)
- 9 Collimator **light field on / off**
- 10 Active device selection button with indicators (wall receptor / X-ray tube / table receptor)

- 11 WHEN TUBE STAND IS SELECTED:
X-ray **tube pivot** around the vertical axis (for ceiling-mounted systems only – COUNTERCLOCKWISE)
WHEN WALL STAND ISSELECTED:
Detector tilt COUNTERCLOCKWISE (if applicable)
- 12 WHEN TUBE STAND IS SELECTED:
X-ray **tube pivot** around the vertical axis (CLOCKWISE – for ceiling-mounted systems only)
WHEN WALL STAND IS SELECTED:
Detector tilt CLOCKWISE (if applicable)
- 13 X-ray tube or table receptor **longitudinal movement** control (RIGHT)
- 14 **Vertical movement** control (DOWN) for tabletop / X-ray tube / wall receptor
- 15 **STOP** (cancels all motorized movement)

4.5.1 Wireless Remote Operation

- Power source: 2 x AA batteries
- Battery life: 6 months (normal use)
- Battery shelf life: 2-3 years (sleep mode)
- Wireless control range: Approx. 20m
- Sleep mode indication: All device select LEDs are OFF
- Awake mode indication: One of the device LEDs are ON

To wake up the wireless remote controller from sleep mode, press any button on the remote. For safety reasons, no action will be performed on the wake-up button press. Press the same button a second time for the desired action (e.g., selecting a device or initiating a motorized movement).

4.6 RADIOGRAPHIC TABLE

4.6.1 Stylix fixed height radiographic table:

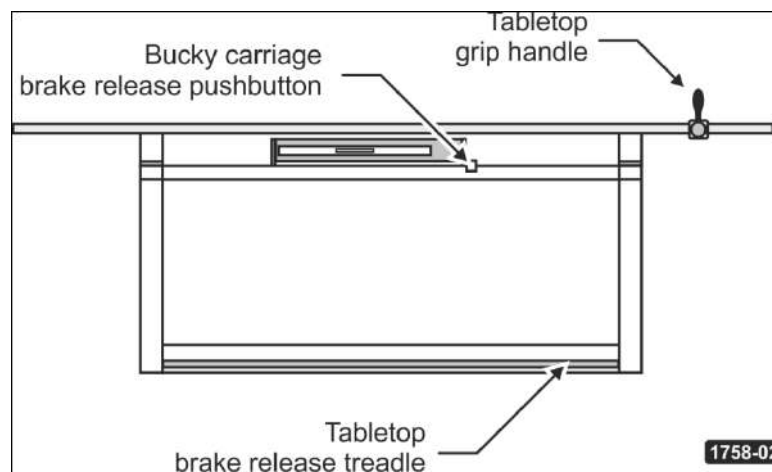

4.6.2 Phoenix (1 and 2) elevating radiographic table:

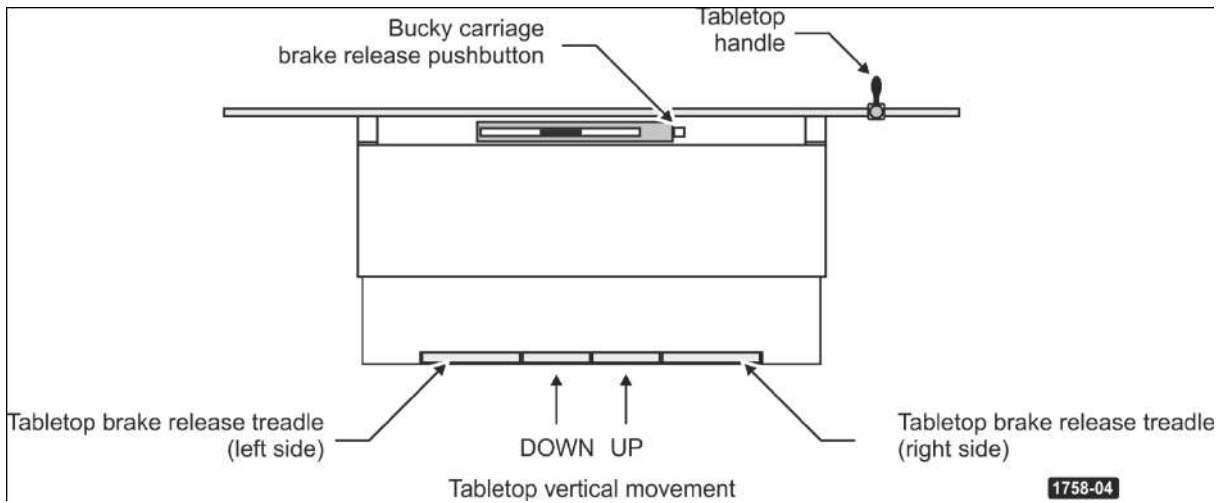

Symbol	Operation
	Foot pedal for tabletop LONGITUDINAL and TRANSVERSAL movement
	Foot pedal for UPWARD table motion
	Foot pedal for DOWNWARD table motion
	EMERGENCY STOP Switch Push it to fully switch off the table. Turn the knob to the right to switch the table back again.

4.7 SIGNIFICANT ZONE OF OCCUPANCY

During operation, the significant zones of occupancy for the floor and ceiling mounted systems are as follows:

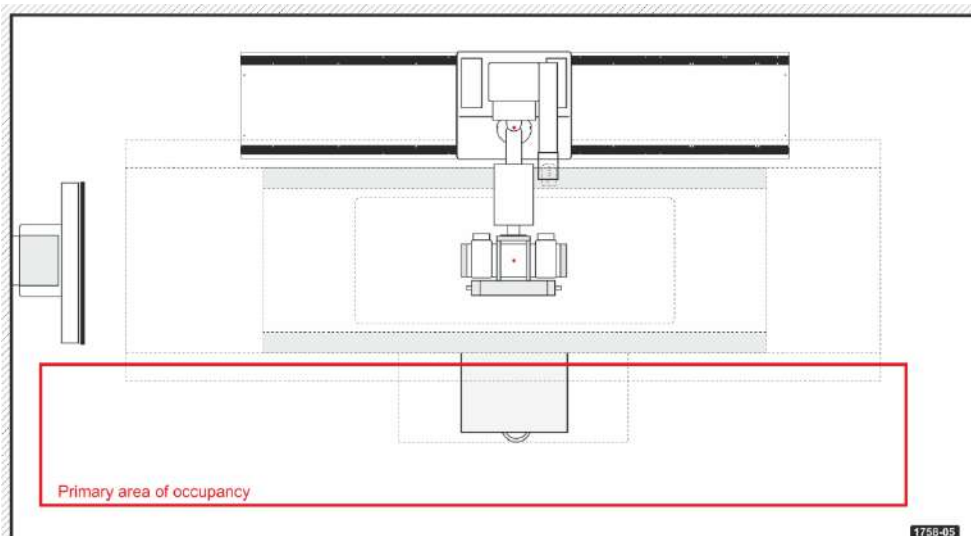

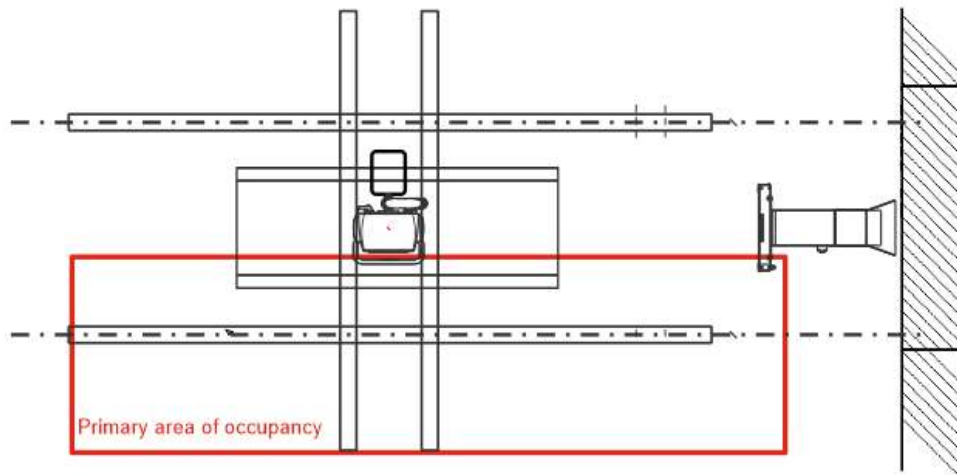

The following operations are performed in the significant zone of occupancy:

- Patient positioning;
- Radiation source and receptor positioning;
- Beam limiting;
- Removing / inserting grid and / or cassette as needed.

Exposure initiation is to be performed from a protected area at the X-ray generator console (this area is not shown – refer to the X-ray generator user manual for further information).

5 USING THE PERFORM-X SYSTEM

5.1 TURNING ON/OFF

The system must be powered up using the system control box.



CAUTION! With the power turned OFF the tabletop is not fixed by the electromagnetic brakes and **may move without operating the movement controls**, including as a result of unintentional movements (e.g. when the device is leaned on).

The powered-ON state is indicated on the:

1. System control box;
2. generator console or acquisition software;
3. tube stand console, including – for membrane consoles – SID / inclination displays and brake ON LEDs.

The Perform-X System does not need to be powered OFF between exposures. Following the general practice in radiology, the system is to be powered ON at the start of day and is powered OFF at the end of the day.

The system is usable immediately after power-up, there is no need for warm-up or special initialization / calibration procedure.



WARNING! Reconnect (power ON) the mains only after safe usage conditions are ensured.

Most moving / movable parts, like the detector holders and X-ray tube (with the exception of the tabletop) are secured with permanent electromagnetic brakes. These brakes will hold the moving parts securely in place when the Perform-X system is powered OFF.

5.2 USING THE WALL STAND

5.2.1 Vertical Receptor Movement

The wall bucky is equipped with an electromagnetic brake to fix the receptor in the desired position. For vertical position adjustment, press the brake release pushbutton located on the side of the bucky or in the bucky handle. Release the pushbutton once the bucky is in the desired position.



CAUTION! Use caution when releasing the brake as **counter-balancing** of the wall detector holder **may be off** and the detector holder or the X-ray tube may suddenly start moving up or down. Counter-balancing will also be different with the **portable receptor and / removable grid in and out** of the holder.

5.2.2 Wall Bucky Tilting (with option T-type and M-type tilting device)

The tilt of the detector can be adjusted between +90 and -25 degrees.

- +90°: receptor is horizontal;

- 0°: receptor is vertical;
- -20°: receptor lower edge closer to column (oblique position).

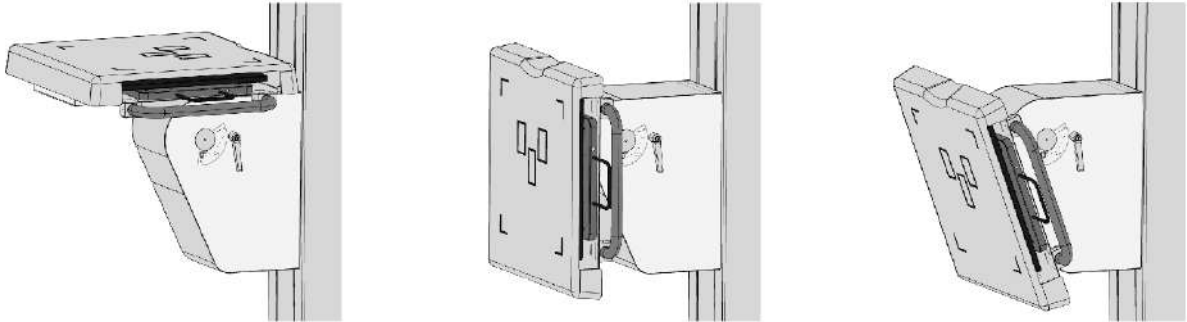

Wall stand receptor tilt positions: +90° / 0° / -20° (manual version shown)

Manual tilting mechanism operation (with option T-type)

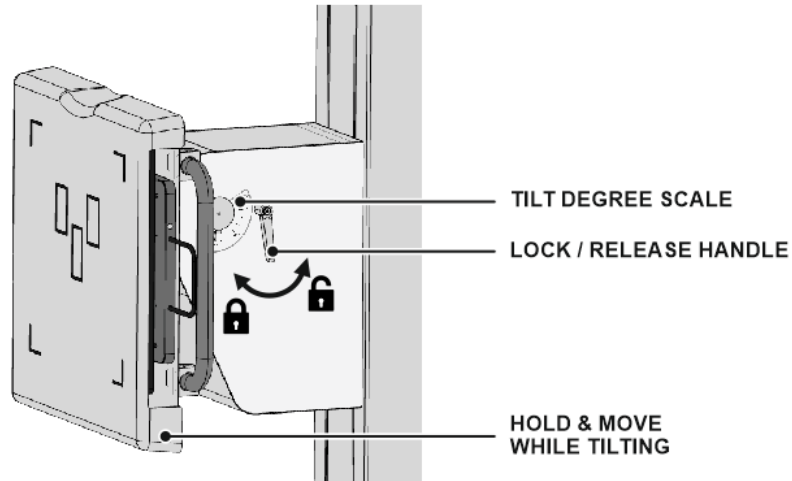

Manual tilt mechanism

1. Release the handle by turning it counter-clockwise while holding the receptor holder at the bottom. The receptor holder is counterbalanced in the entire tilt range, but the presence or lack of the grid and cassette may result in slight imbalance.
2. Tilt the receptor holder. The degree of tilt can be read on the tilt scale next to the handle. The +90°, 0° and -20° positions of the receptor holder are marked with mechanical detents.
3. Fasten the handle by turning it clockwise once the desired tilt is adjusted.

5.3 USING THE RADIOGRAPHIC TABLE

5.3.1 Tabletop Positioning

The radiographic table is equipped with electromagnetic locks, which hold the tabletop in the required position. To release the locks for repositioning a patient, activate the foot pedal marked with the four-way arrow (Phoenix elevating table) or on the single foot treadle (Stylix fixed height table).

While moving, the tabletop automatically stops in its transversal center position. After about three seconds you can move the tabletop further if you desire. For easier positioning, use the handgrip inserted in the tabletop accessory rail. The location of the handgrip can be adjusted by releasing the grip with the knob and sliding to position in the rail.



ATTENTION! To prevent accidental movement, the Phoenix table can be configured to release the brakes **only after stepping on the foot pedals twice** (double-tap feature). Please contact your service partner to activate / deactivate this feature.

5.3.2 Vertical Tabletop Positioning (*Phoenix elevating table only*)

 To control the vertical movement, press one of the vertical foot control pedals to move the table up or down. The table moves in the desired direction until it reaches the

 radiographic position where it stops automatically for approximately 3 seconds. If you do not desire to move the table further, simply remove your foot from the foot pedal. Otherwise, the table will resume moving after the three seconds elapse.

The radiographic position is an optimal height where radiographic exposures can be conveniently taken.



WARNING! To prevent accidental movement, the Phoenix elevating table can be configured to release the brakes **only after stepping on the foot pedals twice** (double-kick feature). Please contact your service partner to activate / deactivate this feature.

The Phoenix elevating table features a safety mechanism to stop vertical (downward) movement when the tabletop touches with an object in its path (e.g. wheelchair).

NOTE (PHOENIX 2 elevating table ONLY):

Upon touching an obstruction while moving downward, the Phoenix 2 table will automatically stop and move upwards about 2 centimeters for additional safety.

By default, exposures can be initiated at any table height. Upon request, the Phoenix table (*PHOENIX 1 table ONLY*) can be configured to provide an interlock to allow exposures only at a specific height (radiographic position), which is selectable during installation. The recommended tabletop-floor distance for the radiographic position is 750 mm.

Please note that the vertical travel is disabled if activating both up and down direction pedals at the same time.



WARNING! The Phoenix elevating table is not designed for continuous vertical movement operation. To prevent damage to the device and to reduce risk of fire, the table can only be moved for a **maximum of 60 seconds every 5 minutes**. (There must be a 4-minute pause after each 1-minute movement,

giving a 20% duty cycle.). See warning label located on the side of the Phoenix radiographic table.



WARNING!

When driving the table down, the front cover of the table will approach the operator's foot to 55 mm. The Phoenix table provides a **loud audible warning sound** (beeping) when the table is within 100 mm of the foot pedal while moving down.

5.3.3 Positioning the Table Receptor

The Phoenix table is shipped with a cassette tray for portable or fixed detectors built in the bucky or grid cabinet. When using a tray (TLI-1417, TLI-1717, T1417 or T1717, use the release push-button to disengage the magnetic lock and move the receptor to the desired position. The release pushbutton is a momentary switch – to lock the receptor in the required position, release the button.

5.3.4 Removing or Replacing the Grid (optional)

In the default Perform-X system configurations with the SGC grid cabinet, the anti-scatter grid may be removed (e.g. for hand / wrist and similar studies). To remove the grid, slightly lift the grid frame and pull it out. To insert the grid, slowly slide in the grid frame and once it is completely inserted, push it down to lock it in place.



WARNING!

Note that **when removing the anti-scatter grid, the patient dose is increased** and the image quality may degrade due to the scattered radiation.

The absence of the grid is clearly visible in the grid slot of either the wall stand or the table receptor assembly.

5.4 WORKING WITH FIXED AND PORTABLE RECEPTORS

5.4.1 Fixed Receptors

FIXED, non-removable DR detectors / flat panels are typically used in wall stands. The active (image) area of most fixed receptors is 43 x 43 cm. Rotation of the receptor between portrait and landscape orientation is not necessary and not possible. *Please contact your service partner about manually or automatically rotating the acquired images using the image acquisition software.*

5.4.2 Cassette Trays

For portable / removable receptors, the receptor holders (bucky or grid cabinet) on the wall stand and in the table may be equipped with a versatile CASSETTE TRAY, which can hold 35 x 43 cm or 43 x 43 cm DR panels. To insert the cassette, pull it out, open the cassette locks and place the cassette in the center of the tray. The cassette is fixed in position once the locks are released.

For certain DR panels – currently Careray and iRay – we offer an in-grid cabinet charging facility to avoid having to remove the wireless DR panel between or after shifts.

5.4.3 Docking Stations

For 35 x 43 cm active area wireless DR flat panel detectors the grid cabinet on the wall stand and in the table may be equipped with a DOCKING STATION. To insert the cassette, pull it out, and push the far edge of the cassette against the 2 plastic retainers with springs and insert the opposite edge to the single fixed plastic holder in the center. The docking station tray can be rotated 90 degrees to allow portrait and landscape orientation. The portrait and landscape

positions are locked in place with mechanical detents.



ATTENTION! The docking station **tray shall only be pushed when locked in the landscape or portrait position**. Forcing the tray in any other position may result in damaging the receptor.



CAUTION! Use caution when connecting the optional **charging cable** to a portable receptor **while in the cassette tray or docking station**. Make sure the cable does not obstruct device movement and is away from operator / patient traffic.

5.5 USING THE TUBE STAND

5.5.1 Adjusting the Beam Direction

Adjustment of the X-ray tube stand is performed in three steps:

- directing the X-ray beam to the required image receptor;
- centering the X-ray beam to the image receptor;
- setting the appropriate SID (source-to image-distance).

Directing the X-ray beam into vertical, horizontal and the optional transversal positions are the most frequently performed adjustments. The beam pointing vertically to the table receptor is the basic position of the X-ray tube.

The X-ray tube position is secured by electromagnetic brakes. To perform any positioning, press the appropriate brake release pushbutton. The brake release pushbuttons are located on the two sides of the tube stand console near to the handles within reach. The LED lights next to each brake release button are lit when the corresponding brake is ON (engaged).

5.5.2 X-ray Tube Rotation



The X-ray tube can be rotated around the horizontal axis. The rotating axis is perpendicular to the axis of the X-ray tube and crosses its focus point, when the tube is rotated around this axis the focus will not be set off.

The rotation of the X-ray tube can be fixed in any position by releasing the membrane switch (with an electromagnetic lock). Additionally, mechanical detents help to position the tube precisely in vertical and horizontal directions. The tube inclination is always available on the LED display of the tube stand console.

The mechanical detents of the arm rotation provide accurate main beam direction (0 and 90 degree) positioning. Contact your service partner for calibration in case the readouts are inaccurate in these positions.

5.5.3 Vertical and Horizontal Movement



The vertical and the horizontal position of the X-ray tube can be adjusted by pressing either of the three brake release buttons. The switches release, respectively, the horizontal, vertical or both brakes.

Upon reaching the desired position, release the switch to lock the tube stand and the vertical carriage.

The SID (source image distance) for both vertical and horizontal beam direction is displayed on the upper LED display of the tube stand console. The vertical / horizontal SID is automatically selected based on the tube rotation between 40...50°.

Please note that:

*For systems with option R or X type floor carriage – ROTATING COLUMN: The **SID measurement is not available for lateral exposures** (whenever the column is rotated from its default position over the table).*

*The **SID is always calculated horizontally or vertically** in perpendicular projection for oblique procedures. In such positions, the collimator tape measure used in the line of X-ray beam may yield a value different from the digital SID display.*

5.5.4 Transversal Movement (with T-type tube arm)



The transversal position of the X-ray source is adjustable by pressing the button marked with a diagonal arrow.

Upon reaching the desired position, release the switch and the movement will stop.

A mechanical detent helps to position properly the X-ray tube to the center of the table and wall detector. Be sure the receptor installed in the radiographic table is aligned with the center of the table. Under table exposures should be taken in the center position of the cross-arm (tube centered over the table).

5.5.5 Column Rotation (with R and X type floor carriage)

The column rotation of the tube stand allows taking lateral exposures on the table or even (when rotated 180°) vertical exposure on a stretcher or mobile X-ray table.

To rotate the tube stand, release the COLUMN ROTATION lock release and turn the X-ray tube stand column in the desired direction. Mechanical detents are located at 0, left 90° and right 90°. Once the column is out of the detent position and is between two detents, disengage the brake release button. Slowly turn the column towards the detent position. The column will automatically lock into position at the detent.

To direct the X-ray beam in the required position, the tube can be rotated independently of the position of the column and the vertical and longitudinal travel can be activated at any time as well.

*Please note that after activating the column lock release, the **column stays unlocked for 3 seconds**. After 3 seconds, the locks will automatically activate for safety reasons and to protect the locking mechanism.*

5.6 TRACKING FUNCTIONS AND AUTOMATIC POSITIONING

F100 F200 F300 F400 C100 C200 C300 C400





WARNING!



In order to avoid injuries and damage, before initiating any automatic movement on the system always make sure the movement area is clear (e.g. there is no risk of collision with patient or any object).

In case of emergency any system movement can be stopped by pushing the following buttons:

- Brake release buttons on the tube stand handle
- Stop button on the LCD display (if applicable)
- Stop button on the remote control (if applicable)
- Emergency button on the Remote Box (if applicable)

Based on configuration, the Perform-X system is equipped with a number of automatic tracking and positioning functions:

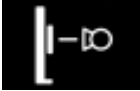
Function	Operation	System requirements
Wall detector: vertical auto-tracking 	The tube immediately follows the wall detector upon vertical movement. The X-ray beam is automatically centered with the detector center. <i>Works with horizontal X-ray beam only – not suitable for oblique projection centering.</i>	<ul style="list-style-type: none"> • Auto Tracking or higher
Wall detector: two-way vertical auto-tracking 	a) The tube immediately follows the wall detector upon vertical movement. The X-ray beam is automatically centered with the detector center. b) The wall detector immediately follows the tube upon vertical movement. The detector is automatically centered with the X-ray beam center. The two devices are equivalent, the functions can be simultaneously used (the manually controlled device is the temporary 'Master'). <i>Works with horizontal X-ray beam only – not suitable for oblique projection centering.</i>	<ul style="list-style-type: none"> • Auto Tracking or higher • Motorized vertical wall detector movement

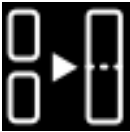
Function	Operation	System requirements
<p>Wall detector: 3D vertical auto-tracking</p> 	<p>a) The tube immediately follows the wall detector upon vertical movement. The X-ray beam is automatically centered with the detector center.</p> <p>b) The wall detector immediately follows the tube upon vertical movement. The detector is automatically centered with the X-ray beam center.</p> <p>c) When in oblique projection, changing the horizontal SID the X-ray tube centers with the detector</p> <p>The two devices are equivalent, the functions can be simultaneously used (the manually controlled device is the temporary 'Master').</p> <p>This tracking function can be used with any arbitrary beam-detector angle.</p>	<ul style="list-style-type: none"> • Auto Tracking or higher • Motorized vertical wall detector movement
<p>Table detector: vertical auto-tracking (constant vertical SID)</p> 	<p>While adjusting the table height, the X-ray tube follows the table top and keeps the original vertical SID constant. Can be used with both vertical and oblique beam directions.</p>	<ul style="list-style-type: none"> • Auto Tracking or higher • Elevating radiographic table
<p>Table detector: automatic detector centering</p> 	<p>When moving or rotating the X-ray tube, the motorized table detector automatically follows the beam center. Can be used with both vertical and oblique beam directions.</p>	<ul style="list-style-type: none"> • Auto Tracking or higher • Elevating radiographic table • Bucky Auto Centering
<p>Automatic horizontal stitching</p> 	<p>The horizontal auto-stitching positioning supports stitching together 3 images taken on the table receptor. The systems automatically position the individual frames with an overlap. To achieve ideal stitched output, the frames are taken with a constant focal point.</p> <ol style="list-style-type: none"> 1. Select the stitching screen tab 2. Make sure the desired SID is set 3. Select the Table detector as device 4. Select the position of the first image to be take (F1 / F3) (the button pushed will turn green) 5. At this point it is still possible to change SID with the footswitch of the table. If the SID is changed the previously selected frame button will turn gray again, so it is needed to be pushed again. 6. Make the first exposure. Once the exposure is taken, push F2 to move the system to the next position. 7. Make the second exposure. Once the exposure is taken, push F3. Wait for the system to position itself then make the last exposure. 	<ul style="list-style-type: none"> • Motorized table detector • Motorized tube rotation • Stitching SW option • <i>Recommended: automatic motorized collimator</i>

Function	Operation	System requirements
----------	-----------	---------------------

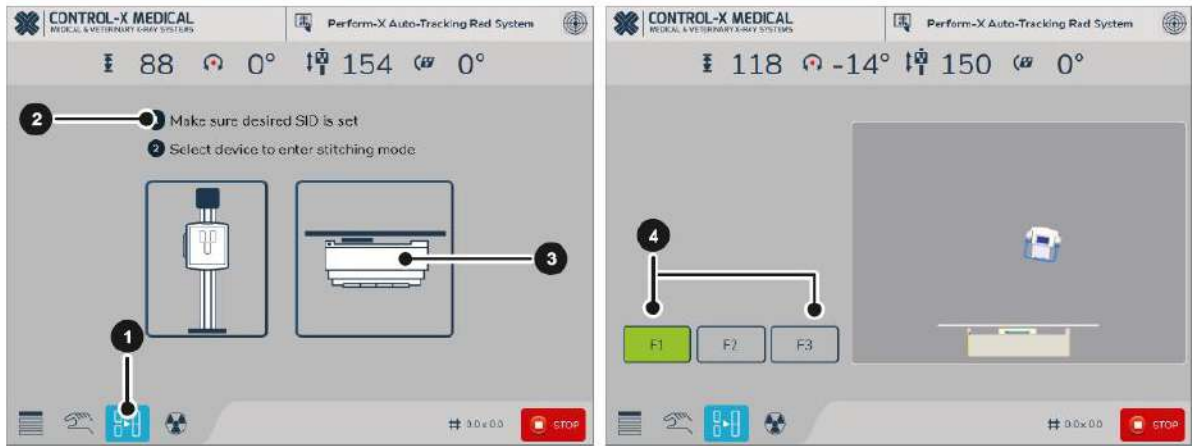

Automatic vertical stitching



The vertical auto-stitching positioning supports stitching together 3 images taken on the wall receptor. The systems automatically position the individual frames with an overlap. To achieve ideal stitched output, the frames are taken with a constant focal point.

1. Select the stitching screen tab
2. Make sure the desired SID is set
3. Select the Wall stand as device
4. Set the height of WS for the first frame according to patient height
5. If needed, SID distance also can be adjusted
6. Select the position of the first image to be taken (F1 / F3) (when pushed, the button turns blue)
7. Push Lock position button. After this button is pushed, it is not possible to change height or SID (the button for the actual frame turns green).

Note: If the setting is not correct for the desired examination, click on any icon (other than stitching screen) on the bottom left corner then start again from step 1.

8. Make the first exposure. Once the exposure is taken, push F2 to move the system to the next position.
9. Make the second exposure. Once the exposure is taken, push F3. Wait for the system to position itself then make the last exposure.

- Auto Stitching or higher
- Motorized tube rotation
- Wall Detector movement
- Auto Stitching SW option
- *Recommended: stitching stand*
- *Recommended: automatic motorized collimator*

Function	Operation	System requirements
APR Auto Positioning		

APR Auto Positioning

The X-ray tube and the detector moves into a default position according to the APR selected inside the generator control software on the workstation. When using an automatic collimator, the light field size is also programmable.

In case this function is enabled, the P8 position on the preferred position screen becomes an APR position. The APR position has three states:

- Until there is no new APR selection after the startup the APR row is disabled (gray coloured)
- If an APR program was selected on the workstation, the APR position will get the same name as the APR program inside the APEX software. Until it is not saved, the name will be displayed in blue colour. After saving it will become red.
- In case an already saved APR is selected inside APEX, the APR name will automatically display in red, so there is no need to save it again.

In order to move the system components to the position that is determined by the APR, click on the triangle in the device position display

- APEX (v18.1 or later) software with CXGI interface enabled
- Remote APR Option
- *Recommended: automatic motorized collimator*



5.7 POSITIONING THE PATIENT



During positioning the patient, always **wear appropriate protective devices** according to procedures prescribed by your healthcare institution.

WARNING!

Adjust the position of the patient / body part according to the exposure and projection.

5.7.1 Wall Bucky Exposures

Recommended procedure:

1. Adjust the film-focus (source-image) distance;
2. Release the wall receptor brake using the brake release pushbutton and move the receptor vertically into the approximate exposure height;
3. (In case of tilting receptor) adjust the tilt angle of the receptor if necessary. The tilt angle is indicated on the inclination scale located on the tilting mechanism;
4. Adjust the patient into the desired position and set the final receptor height. Make sure that the region of interest is centered on the receptor;
5. When performing chest studies / screening, use the chin rest located on the top of the bucky or grid cabinet;
6. After positioning the patient, adjust the center and the size of the beam using the collimator.

5.7.2 Table Exposures

Recommended procedure for table exposures:

1. If necessary, move the X-ray tube aside so that the patient can easily and safely climb onto the table;
2. In case of Phoenix table, adjust the table height for convenient patient transfer onto the table (especially for elderly and disabled patients);
3. (*Phoenix only*) After positioning the patient, move the tabletop into the vertical exposure position (the tabletop automatically stops for convenient default exposure height);
4. Adjust the SID, the beam center and light field size. Use the tabletop longitudinal and transverse movements as necessary;
5. Make sure that the receptor is centered using the centering line of the collimator.

When working with portable digital detectors or film / CR cassettes, it is possible to take exposures directly on the tabletop (e.g. extremities studies). In this case, the SID scale located higher on the tube stand column must be observed for SID distances (except for special procedures).

The recommended procedure for on-the-tabletop exposures:

1. If necessary, move the X-ray tube aside so that the patient can easily and safely climb onto the table;
2. In case of Phoenix table, adjust the table height for convenient patient transfer onto the table (especially for elderly and disable patients);
3. (*Phoenix only*) After position the patient, move the tabletop into the vertical exposure position (the tabletop automatically stops for convenient default exposure height);
4. Position the cassette / detector under the region of interest as desired;

- Adjust the SID, the beam center and size. Use the tabletop longitudinal and transverse movements as necessary.

5.8 TAKING EXPOSURES

Depending on system configuration, the X-ray parameters can be monitored and adjusted:

- on the image acquisition workstation screen (in exposure mode);
- on the dedicated generator control console (e.g. Milestone or CMP-200 desktop console) or
- on the tube stand LCD touch screen display (*requires PXIM Console and integrated generator control sw. module*).

Please refer to the generator operating instructions for details on APR selection and adjusting X-ray parameters.

The exposure can only be initiated using the 2-step exposure hand switch or the built-in PREP / EXP buttons on the dedicated generator control console.

- Press the 2-step exposure hand- or footswitch. The first step prepares the generator and the X-ray tube for the exposure. The preparation ready state will be indicated by a visual and/or audible READY signal. Any final positioning (instructions to patient, controlling breathing etc.) should be done at this time.
- Press the second step of the exposure switch to take an exposure. During the exposure, the yellow exposure symbol will light up on the console(s) and an audible signal will also be heard. **Make sure you do not release the exposure switch prematurely!**
- Alternatively, if patient position is not required right before the exposure, the 2-step exposure switch can be pushed all the way at once, without pausing between the steps.
- After the exposure, the measured feedback values and a termination (or error) message will be displayed on the generator console. The feedback message will be on display depending on generator type and setup. In case of any errors during the exposures, the error message will appear on the generator console. Contact your service partner and be prepared to give details on the error conditions and messages.
- On DR systems, the image appears on the image acquisition workstation in a few seconds after a successful exposure. On CR and conventional X-ray systems, follow the CR / film processing protocol to develop the image.

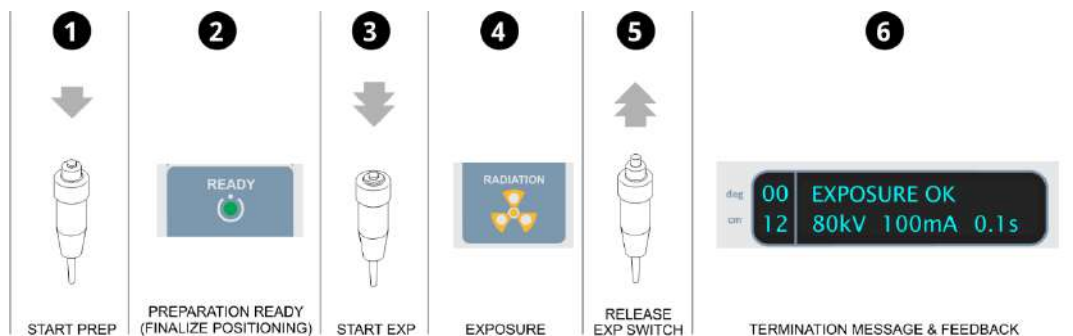

Exposure sequence (Milestone generator control console indicators shown)



WARNING! The exposure sequence can be interrupted immediately at any time in case of an emergency, when patient movement is detected or if other problem occurs.

5.9 EXPOSURE INTERLOCKS

In certain situations, exposures may be disabled by an external interlock (e.g. tube overheat, door switch etc.). Refer to the X-ray generator user manual for further information.

5.10 ERROR MESSAGES AND ERROR CONDITIONS

The stands and radiographic table components of the Perform-X system do not have error message displays. For error messages and conditions related to the X-ray generator, please refer to the operating instruction shipped with the X-ray generator.

6 MAINTENANCE

The Perform-X radiographic system requires regular maintenance to ensure safe operation and to increase the operating life of the equipment. The operator shall check the equipment for functional defects or any deviation from the normal operation. In case of deviation, the unit shall be turned off and your service partner must be notified. The equipment shall not be used until the defect is repaired.

6.1 DAILY ROUTINE CHECK

Check the operating elements (X-ray tube, receptor, tabletop, brakes etc.) for proper functioning. In case of unusual noises or sounds while positioning or slower elevating speed (Phoenix table), contact your service company immediately.

6.2 WEEKLY CHECK

The floor rails must be clean for proper operation and smooth horizontal travel. If necessary, clean the rails with a lint-free cloth.

6.3 PERIODIC MAINTENANCE

To ensure safe and trouble-free operation the system shall be checked by your service partner, at least annually. Please refer to the *Maintenance* section of the Technical Manual.



ATTENTION! Each failing component which effects the safe operation of the equipment, shall be replaced with **original spare parts**.

Parts of the equipment are treated with anti-corrosion agents. To prevent wear, the manufacturer applied lubricants and under normal circumstances there is no need for further lubrication. Contact your service partner if lubrication becomes necessary.

6.4 CALIBRATION

Some of the components require periodic calibration:

- The X-ray tube must be calibrated every 12 months to compensate for tube aging and ensure accurate operation (refer to the X-ray generator technical manual for calibration instructions);
- If the system is shipped with a DAP (dose area product) meter, the DAP meter is factory calibrated. The calibration certificate is included in the DAP packaging. Recommended frequency of recalibration is 5 years and must be carried out based on the included DAP user manual.

For detailed information, please refer to the Technical Manual.

6.5 CLEANING AND DISINFECTION

The Perform-X System does not require special cleaning or sterilization. However, it is recommended to clean from time to time:

- the tube stand console and its handles;
- the tabletop;
- wall bucky / grid cabinet cover and brake release handles.

For cleaning without disinfecting, you may use mild soapy water or an equivalent cleaning solution. Apply some solution with lint free cloth or paper towel and wipe down the surface. If

for some reason, the handles or other surfaces require disinfection, you may use Actichlor (contains Sodium Dichloroisocyanurate, a form of chlorine) or equivalent with a 3 to 5% Hypochlorite concentration.

Method of disinfection:

1. Turn OFF the system completely (using the wall disconnect switch);
2. Use 50/50 disinfectant / water solution;
3. Apply (e.g. spray) the disinfectant on a lint free cloth. Make sure the **cloth is only damp and not wet**;
4. **Do NOT apply the disinfectant directly** on the surfaces as the substance may get into the equipment;
5. Wipe the surfaces carefully with the cloth;
6. Before turning the equipment on again, make sure that the disinfectant has evaporated.



WARNING!

To clean / treat the surfaces, only **acid-free, non-corrosive, non-abrasive** substances shall be used.

Only such disinfecting methods shall be used that correspond to the relevant regulations and rules as well as the protection from explosion.

The use of disinfecting spray is not recommended because it can get inside the equipment.



WARNING!

Make sure that **no water or other liquids** enter any component of the Perform-X system. Such liquids may cause short circuit in electrical components and / or corrosion on surfaces.

7 DISPOSAL AND DECOMMISSIONING

X-ray machines do not present a radiation hazard when they are not in operation. However, many structural components are built with materials that may be considered hazardous (e.g., lead, tungsten) for disposal purposes. These materials must be segregated and disposed of according to the regulatory agency having jurisdiction.

Dismantling and disposing the X-ray equipment may be subject to **clearance by a radiological survey**.



WARNING! All dismantling and decommissioning activities related to the Perform-X system must be performed by **organizations authorized** to perform such tasks.



WARNING! During decommissioning and disposal, **serious injury may occur** when dismantling:

- The **glass inside the X-ray tube** may break and can cause injuries;
- Skin may come into contact with **hazardous substances** (lead, tungsten);
- **Weights and heavy parts** can become loose when disassembling.



WARNING! The Perform-X is a permanently installed equipment with material that may contain **hazardous materials**. These include but are not limited to:

- Lead (in the X-ray tube and the collimator);
- Tungsten (in the X-ray tube);
- X-ray film and film processing agents (not supplied by the manufacturer).

REVISION HISTORY

Version	Date	Change	Pages
01	2020.07.03	Original version	Entire document
02	2020.09.11	Corrected typos and updated wording to 'receptor'	Several pages
03	2020.10.28	Added information for F200-400 and C100-C400	Several pages
04	2020.05.12	Added compatibility information on IAE X-ray tubes and Varex HV cables	11
05	2022.03.08	Update labels	13
06	2022.03.10	CAPA-5183: update references of standards and regulations	
07	2023.01.20	Change of business structure + label sample update	1 st page, 2.5
08	2023.07.21	Technical parameters updated	17
09	2023.10.25	Added compatible X-ray generators and flat panel	12

10	2024.02.01	Update with PXIM console LCD touchscreen functions, device compatibility table	Several pages
----	------------	--	---------------