

Pediatric Bronchoscopes

with proximal illumination

Special Features:

- Absence of distal light carrier does not restrict inner diameter
- Prismatic Light Deflector 10101 FA inserted proximally ensures best illumination and enables full use of lumen through operating instruments
- Excellent view of operation area
- Lateral channel for introducing suction catheters and fine instruments

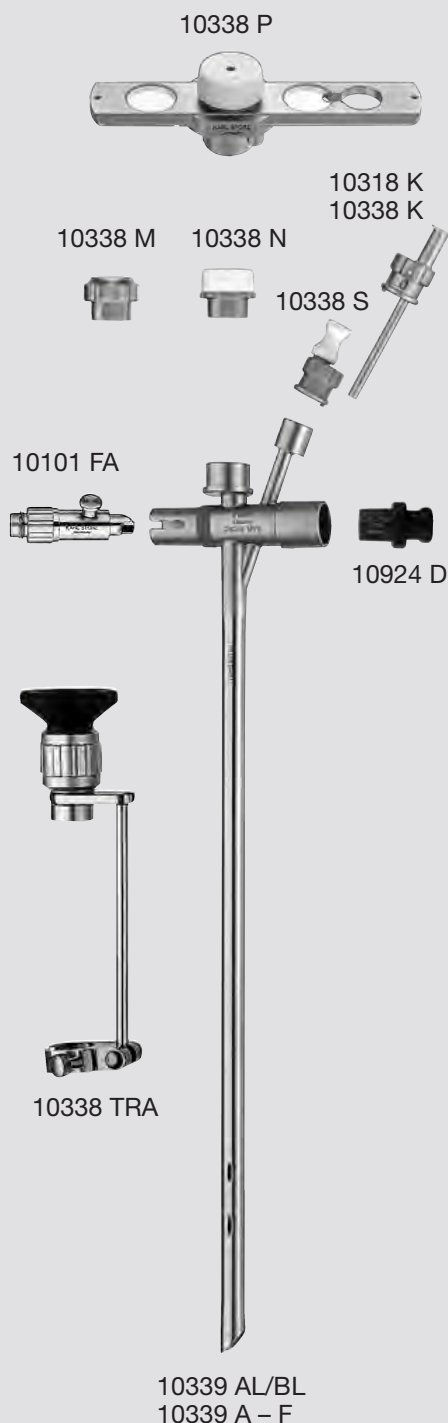

- | | |
|---------------------|---|
| 10339 AL | DOESEL-HUZLY Bronchoscope , size 6, length 40 cm |
| 10339 BL | Same , size 5 |
| 10339 A | DOESEL-HUZLY Bronchoscope , size 6, length 30 cm |
| 10339 B | Same , size 5 |
| 10339 BB | Same , size 4.5 |
| 10339 C | Same , size 4 |
| 10339 G | Same , size 3.7 |
| 10339 CD | Same , size 3.5 |
| 10339 EEE | Same , size 3 |
| 10339 CC | DOESEL-HUZLY Bronchoscope , size 4, length 26 cm |
| 10339 GG | Same , size 3.7 |
| 10339 DD | Same , size 3.5 |
| 10339 EE | Same , size 3 |
| 10339 D | DOESEL-HUZLY Bronchoscope , size 3.5, length 18.5 cm |
| 10339 E | Same , size 3 |
| 10339 F | Same , size 2.5 |
| 10101 FA | Prismatic Light Deflector , autoclavable, with connection to fiber optic light cable |
| 10338 M | Glass Window Plug |
| 10338 N | Rubber Telescope Guide , for use with telescopes and optical forceps |
| 10338 P | FLUVOG Adaptor , with sliding glass window plug, sealing cap, notched lens and keyhole opening, movable |
| 10338 S | Guide Piece , for suction catheter, short, bronchoscope for children and infants |
| 10338 TRA | Adjustable Magnifier , autoclavable, swing-away type, with ring adaption |
| 10924 D | Adaptor , for respirator |
| NEW 10924 DL | Adaptor , for respirator, long version |
| 10318 K | Injection Cannula , for positive pressure assisted ventilation system, LUER-Lock, outer diameter 3.5 mm |
| 10338 K | Injection Cannula , for positive pressure assisted ventilation system, LUER-Lock, outer diameter 2.7 mm, for use with Bronchoscopes 10339 E/EE/F |

Cysto-Urethroscope

HOPKINS® Telescope

11 / 13 / 14.5 Fr.,
for use with Cystoscope-Urethroscope Sheaths 27032KK and 27032LK

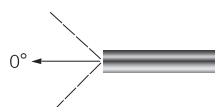

27018AA

HOPKINS® Straight Forward Telescope 0°,
diameter 2.7 mm, length 18 cm, **autoclavable**,
fiber optic light transmission incorporated,
color code: green

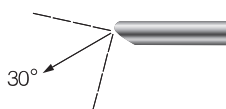

27018BA

HOPKINS® Forward-Oblique Telescope 30°,
diameter 2.7 mm, length 18 cm, **autoclavable**,
fiber optic light transmission incorporated,
color code: red

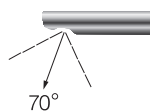

27018CA

HOPKINS® Lateral Telescope 70°,
diameter 2.7 mm, length 18 cm, **autoclavable**,
fiber optic light transmission incorporated,
color code: yellow

Full Lumen Operating Tracheoscope

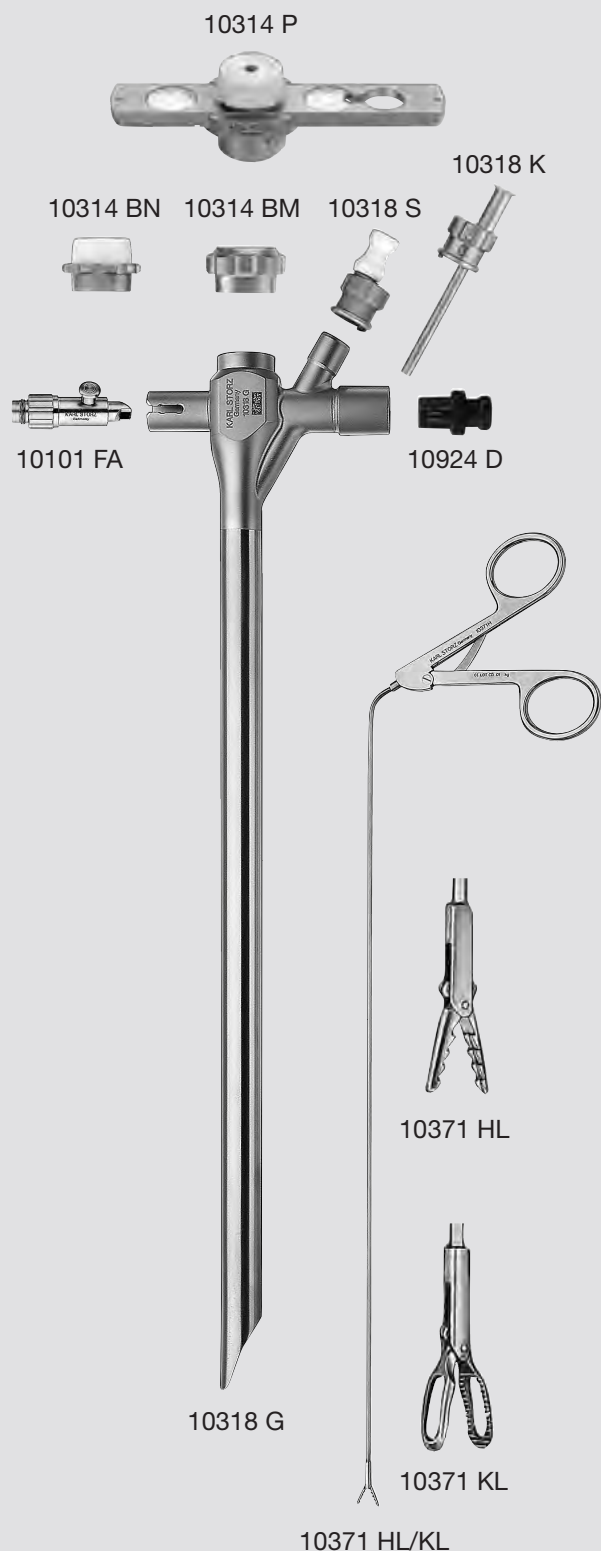









- 10318 G **Full Lumen Operating Tracheoscope**, size 14 mm, length 33 cm
- 10101 FA **Prismatic Light Deflector**, autoclavable, with connection to fiber optic light cable
- 10314 BM **Sealing Cap**, with window
- 10314 BN **Sealing Cap**, with rubber seal
- 10314 P **FLUVOG Adaptor**, with observation window, sealing cap with rubber seal and a window with opening, adjustable
- 10318 K **Injection Cannula**, LUER-Lock, outer diameter 3.5 mm
- 10318 S **Instrument Guide**, for suction catheter
- 10924 D **Adaptor**, for respirator
- 10371 HL **Forceps**, with alligator jaws, serrated, width of jaws 3.5 mm, double action jaws, sheath diameter 2 mm, working length 45 cm, with LUER-Lock irrigation connector for cleaning
- 10371 KL **Forceps**, bean jaws, blunt grooved, width of jaws 5 mm, double action jaws, sheath diameter 2 mm, working length 45 cm, with LUER-Lock irrigation connector for cleaning

More Forceps see chapter 10-11, ESOPHAGOSCOPY – BRONCHOSCOPY

MINIATURE OPTICAL FORCEPS FOR PREMATURE & NEONATE PATIENTS

Continuously improving our products so you can better care for your patients

Ordering Information		
	10030 AA	Miniature semi-rigid telescope , 1.3 mm X 30.6 cm
	10374 HF	Miniature optical forceps with alligator jaws , for the controlled grasping of hard foreign bodies, with force-limited handle, incl. cleaning adaptor, for use with miniature straight forward telescope 10030 AA
	10374 L	Miniature optical forceps, spoon-shaped , round, for biopsy, incl. cleaning adaptor, for use with miniature straight forward telescope 10030 AA

For Use With		
	10339 F	Bronchoscope tube , size 2.5, O.D. 4.2 mm, I.D. 3.5 mm, length 18.5 cm
	10339 E	Bronchoscope tube , size 3, O.D. 5 mm, I.D. 4.3 mm, length 18.5 cm
	10339 D	Bronchoscope tube , size 3.5, O.D. 5.7 mm, I.D. 5 mm, length 18.5 cm
	10339 EE	Bronchoscope tube , size 3, O.D. 5 mm, I.D. 4.3 mm, length 26 cm
	10339 DD	Bronchoscope tube , size 3.5, O.D. 5.7 mm, I.D. 5 mm, length 26 cm

Contact your local KARL STORZ representative for more information about these or other KARL STORZ products, or call 800-421-0837.

It is recommended to check the suitability of the product for the intended procedure prior to use.

KARL STORZ SE & Co. KG
 Dr.-Karl-Storz-Straße 34, 78532 Tuttlingen/Germany
 Postbox 230, 78503 Tuttlingen/Germany
 Phone: +49 (0)7461 708-0
 Fax: +49 (0)7461 708-105
 E-Mail: info@karlstorz.com

www.karlstorz.com



KARL STORZ Endoscopy-America, Inc.
 2151 East Grand Avenue
 El Segundo, CA 90245-5017, USA
 Phone: +1 424 218-8100
 Phone toll free: 800 421-0837 (US only)
 Fax: +1 424 218-8525
 Fax toll free: 800 321-1304 (US only)
 E-Mail: communications@karlstorz.com