

## ASTRA specifications

Model	ASTRA biological microscope
Optical system	Infinity color corrected optical system
Viewing head	30° gemel binocular, 360° rotatable, adjustable eye-point height can adapt to operators of different heights.
	30° gemel trinocular tube , 360° rotatable, spectroscopical ratio R:T=50:50 or 80:20, adjustable eye-point height can adapt to operators of different heights.
	30° gemel trinocular tube, built-in gemel digital viewing head, 360° rotatable, adjustable eye-point height can adapt to operators of different heights. built-in 6.3M, 12M, 20M digital modules for choice, USB 3.0 output.
Eyepiece	30° inclined, built-in gemel digital head, 360° rotatable, adjustable eye-point height can adapt to operators of different heights. Built-in and 20M digital camera for optional, WIFI or RJ45 network port output. Support remote full resolution photo, support Hotspot/Client mode switch, support multi-viewer.
	Wide field plan eyepiece PL10X/20mm, with reticle, diopter adjustable.
Objective	Wide field plan eyepiece PL10X/22mm, with reticle or grid plate, diopter adjustable.
	infinity plan achromatic objective (2X, 4X, 10X, 20X, 40X, 60X, 100X)
	Infinity plan achromatic phase contrast objective (10X, 20X, 40X, 100X)
Nosepiece	Infinity semi-apochromatic fluorescence objective (4X, 10X, 20X, 40X, 100X)
	Quintuple nosepiece
Stage	Quintuple nosepiece (Brightness memory)
	Double layers mechanical ceramic paint stage, precision: 0.1mm [X-axis rackless]; Clips for double sliders, moving range 78mm×51mm.
Condenser	N.A.1.25 Abbe condenser (with socket for phase contrast and dark field accessories) with aperture diaphragm.
single-band LED fluorescent reflection illumination system	B4 TB- LED fluorescent module for TB, with intensity adjust knob, BF/FL switching knob, central wavelength 455nm.
	B1 band pass filter LED fluorescent module, with intensity adjust knob, BF/FL switching knob, central wavelength 470nm.
	B2 long pass filter LED fluorescent module, with intensity adjust knob, BF/FL switching knob, central wavelength 470nm.
	G1 band pass filter LED fluorescent module, intensity adjust knob, BF/FL switching knob, central wavelength 560nm.
	UV2 long pass filter LED fluorescent module, with intensity adjust knob, BF/FL switching knob, central wavelength 385nm.
Illumination system	UV4 long pass filter LED fluorescent module, with intensity adjust knob, BF/FL switching knob, central wavelength 365nm.
	100V-240V External transformer, 3W LED with continuous intensity control. Type-c interface allows portable battery as a power source. USB port supports the microscope to charge a phone or tablet. With ECO function. The body can supply power to fluorescent illuminator and Wi-Fi camera module.
camera accessories	100V-240V External transformer, 3W or 5W LED with continuous intensity control. Type-c interface allows portable battery as a power source. USB port supports the microscope to charge a phone or tablet. With ECO energy saving function, LCD display, objective brightness memory and color temperature adjustment function, the adjustment range: 3000K-7000K. The body can supply power to fluorescent illuminator and Wi-Fi camera module.
Other accessories	0.35X, 0.5X, 0.65X, 1X camera adapter, focusing adjustable.
	Frosted glass accessories, Dark-field accessories, phase contrast accessories, color filter, telescope (Φ30), high precision type/general type micrometer with 0.01mm scale value.

## ASTRA Series Biological Microscope



LABWAY.SL  
www.labwayinternational.com

ADD: Poeta Navarro Cabanes15,46018,Valencia,Spain.

TEL: + 34 961 529 388

WHATSAPP: + 34 961 529 388

E-mail: info@labwayinternational.com

# ASTRA

Intelligent, convenient,  
comfortable and efficient

**S1** The new **ASTRA** biological microscope, designed for universities or laboratories of biomedicine and other fields, can be used for teaching experiments and medical testing.

Innovative design style, high quality and convenient, to bring you a simple and comfortable use experience;

Excellent optical system and complete accessories, you can achieve a variety of observation such as light and dark field and phase contrast, to presenting you with wonderful images beyond your expectations. With intelligent lighting management system and ECO function, make your work easy and efficient.

# Excellent optical performance and practical design

## Outstanding Infinity color corrected optical system

Infinity color corrected system, professional plan achromatic objectives and cutting-edge microscopy technology, provide microscopic images with high resolution, high definition and high contrast.

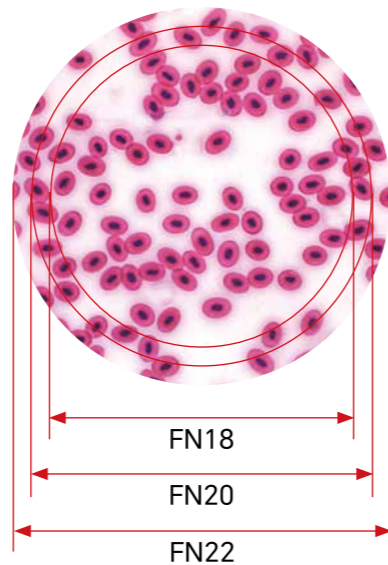

## 22mm wide-field

- The ASTRA biological microscope can achieve a wide field of view range of 22mm under 10X eyepiece, which is more efficient and perfect for observation.
- Professional high eye point and wide field plan eyepiece can effectively correct edge distortion and chromatic aberration.



## Rotatable viewing tube

ASTRA viewing tube with gemel group 360° rotation function, adjustable pupil distance, eye point height, for different height of the operator to provide a more flexible and comfortable experience.



## Super large ceramic rackless stage

Double-layer mechanical stage, large arc shape, no angular design; the stage surface adopts ceramic paint process, high hardness, corrosion resistance; Damping-type double clips can be placed two slices at the same time, for inspection and comparative analysis.



## Super endurance function

The body is equipped with a Type-c interface, which allows the microscope to use a portable battery as a power source. The microscope thus frees itself from dependence on power outlets, enabling easy use outdoors or in power outages. The body comes with a standard USB port, that allows the microscope to charge a phone or tablet.



Charge the microscope by the portable battery.



Charge cell phones and tablets by the microscope.

# Intelligent management of light intensity and ergonomic design

## With ECO energy-saving working mode

Build-in ECO function, no operation for 30 minutes, the system will automatically turn off and into the standby mode. Users can automatically wake up the light source by touching the dimming knob.



The ASTRA has a front LCD display, which displays the current lighting brightness, color temperature and magnification, so that the user can intuitively judge the working status and improve working efficiency.

At the same time, the ASTRA has ECO function which gives a prompt whether to hibernate. Users can manually cancel, saving energy and improving user experience.

The hibernation waiting time is 5-60 minutes.



ECO duration, lighting brightness, objective magnification, and color temperature are displayed on the working screen.

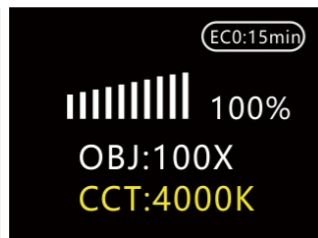

Long press the dimming hand wheel to adjust the color temperature interface 3000K-7000K.

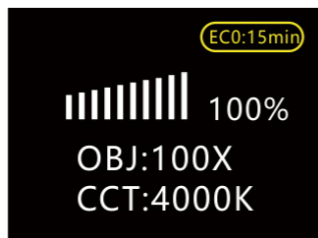

Short press the dimmer hand wheel to enter ECO mode. You can set the ECO duration.



In standby mode, "Coffee cup" will appear one minute ahead of time to remind you of standby state.



## Brightness memory function

ASTRA can be equipped with code nosepiece, able to remember the illumination brightness of each objective. Users can freely adjust the light source brightness of each objective and the system automatically remembers, not only to improve efficiency, but also to reduce visual fatigue.

## User-friendly design increases comfort and safety

- The ASTRA is equipped with a secure handle for moving;
- Fully concealed locking design eliminates all sharp edges;
- Low hand coarse and fine coaxial focus system is ergonomically designed to give the user maximum comfort;
- There is a storage device at the back of the

body to ensure the cleanliness, , saving storage space and improving portability.



# Various observations such as bright field, dark field and phase contrast can meet the needs of routine teaching and experimental observation.

## bright field observation

The professional plan achromatic objective, with the use of the Kohler illumination system, adjusts the image to the best condition by adjusting the aperture diaphragm and the field diaphragm. High-resolution, high-contrast microscopic images can be obtained whether at low or high magnification.

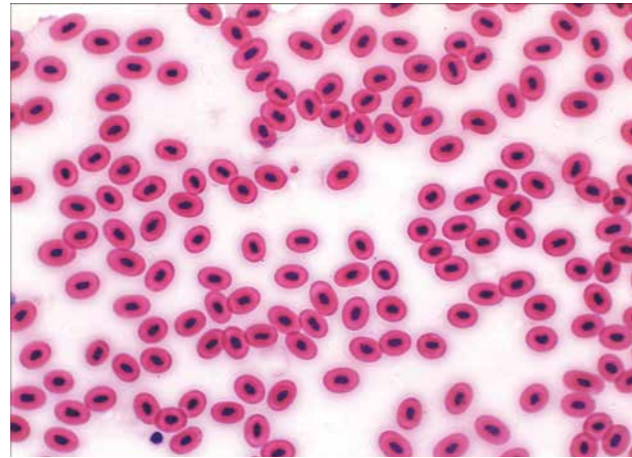

Blood cell 20X bright field

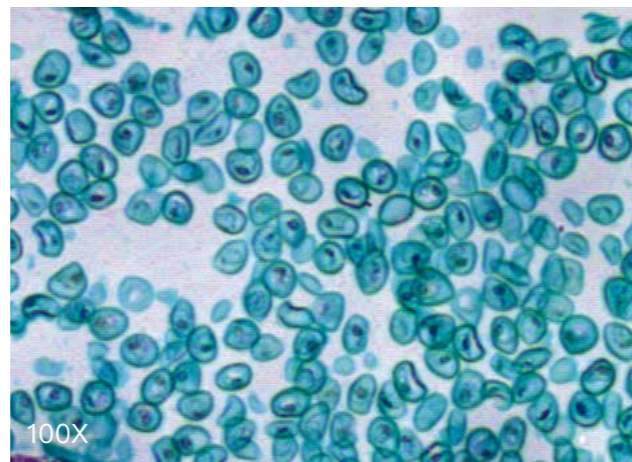
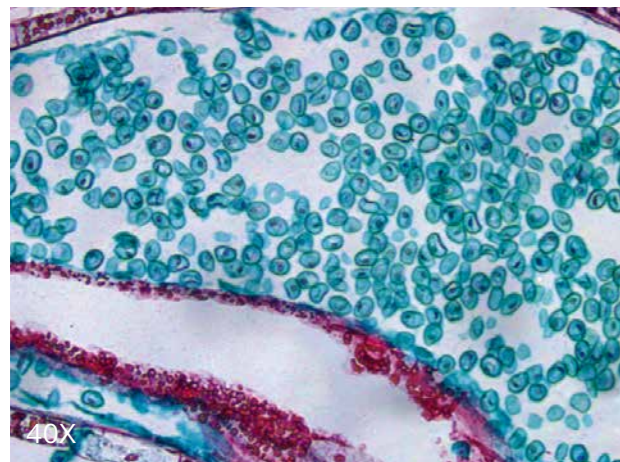
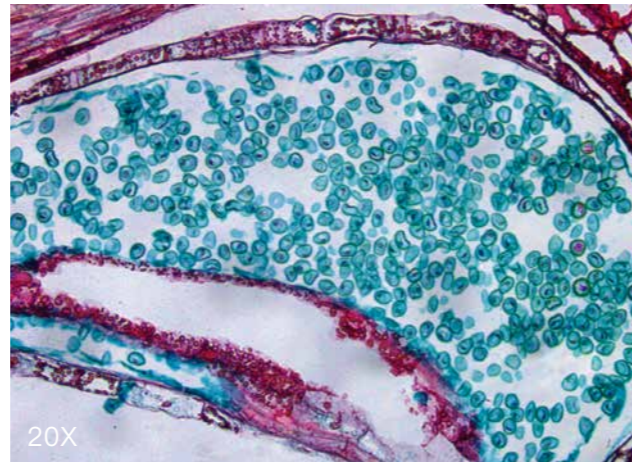
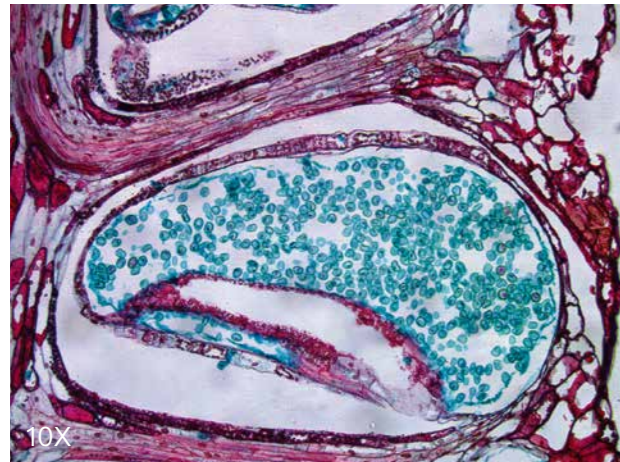

Male tapeworm transverse cleavage bright field

## phase contrast observation

It is suitable for observing samples with high transparency, such as cells, bacteria and other tiny, transparent objects in biological specimens.

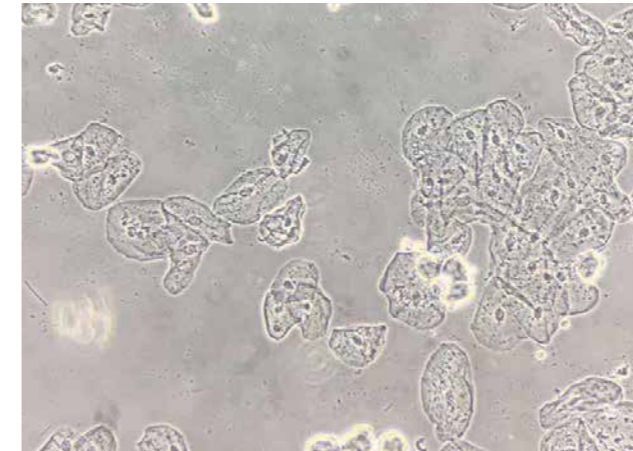

Oral epithelial cells 40X phase contrast

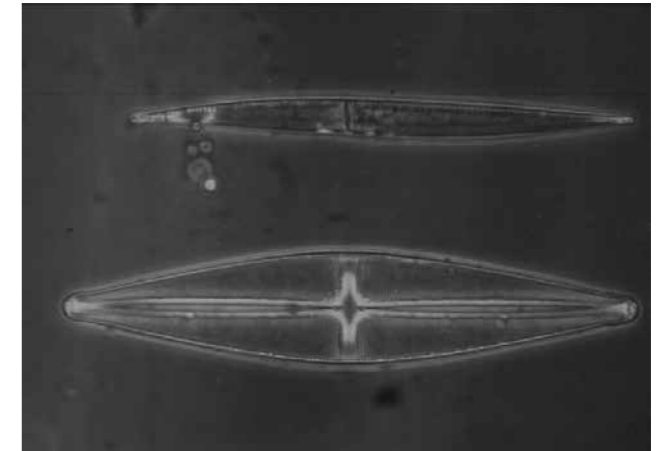

Diatom 20X phase contrast

## dark field observation

Insert the dark field kit into the socket of the condenser and push the dark field diaphragm into the optical path to achieve simple dark field observation. Without replacing the special dark field condenser, dark field observation can be performed on any magnification objective in the range of 4X-40X, which can be used to observe protozoa, bacterial flagella, spirochetes and other substances.

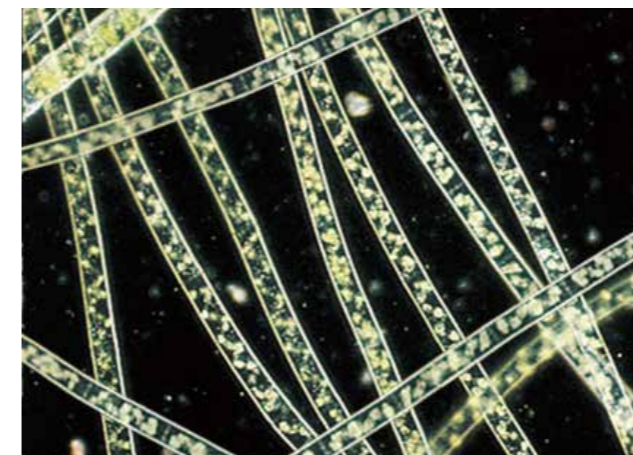

Watermill 20X dark field



**Provide you with highly stable, low-radiation, ultra-long-life fluorescent modules to help you output efficient and professional diagnostic solutions.**

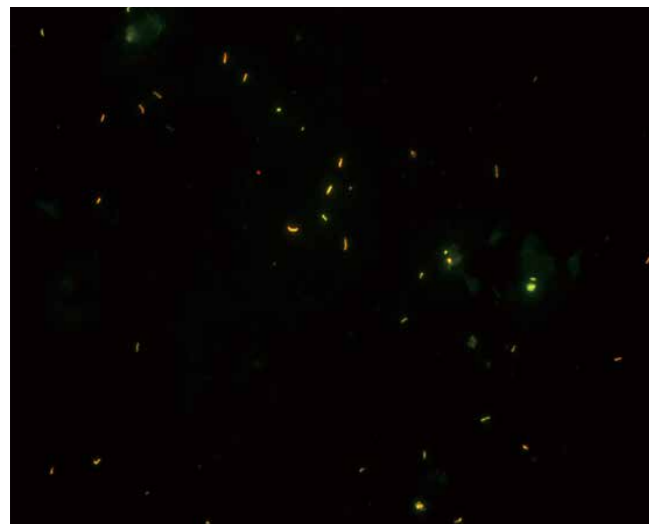

### Flexible manipulation of the LED fluorescent module

The innovative reflected LED fluorescence device greatly simplifies the operation process of the fluorescence microscope, making the microscopy experiment more simple, safe and efficient.

With light source brightness adjustment knob, according to the characteristics of different specimens to set the appropriate illumination brightness; Rotating bright field / fluorescence switch knob, convenient for users to achieve easy conversion between transmitted light illumination and reflected fluorescence illumination.

Name	central wavelength	application
UV4 long pass type LED fluorescent	385nm	module for DAPI/Hoechst 33342
B4 TB-specific module LED fluorescent	455nm	module for AuramineO/wtGFP
B1 band pass type LED fluorescent intermediate	470nm	module for GFP/FITC
G1 band pass type LED fluorescent intermediate	560nm	module for TexasRED/Cy3.5

Other types of intermediate LED modules can be selected according to customer requirements.

### Simple brightness adjustment knob

By adjusting the knob, you can adjust the intensity of LED fluorescent lighting to get the required light.

### Easy switching of bright field / fluorescent

According to the application needs, rotate the bright field / fluorescent switch knob, you can instantly achieve two kinds of observation switchover.

Switch to the fluorescence channel and use the LED fluorescence intermediate module to perform fluorescence observation for TB detection or immunofluorescence analysis and in vivo cell observation.

Switching to the bright field channel allows the use of transmitted light for routine pathological testing or laboratory observation.

### Body power supply function

Built in 12V1A transformer can directly charges the fluorescent illumination, easy to connect and safe to use.



# Powerful, practical and convenient digital microscope



## Multifunctional digital camera module

ASTRA digital module contains USB3.0 output and WIFI output two modes which can realize progressive scanning and high quality microscopic images output. The WIFI camera module supports remote full-resolution photography and multiple terminal connections for multi-viewing; it also provides a contact-type digital power supply device for convenient use and enhanced user experience.

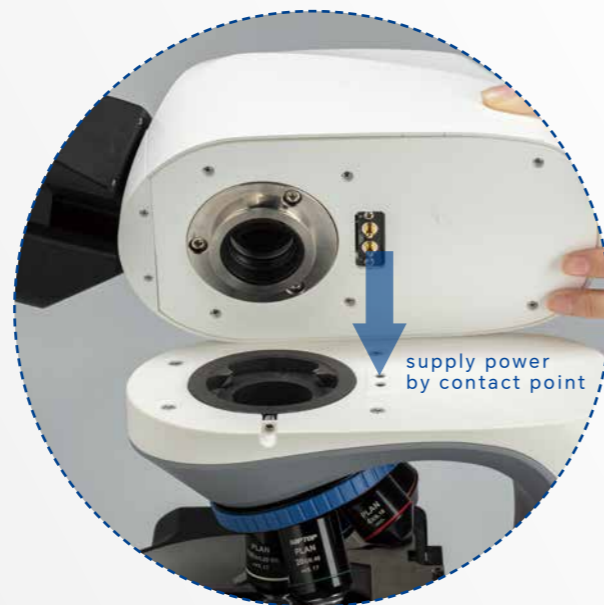

## other accessories



### Trinocular tube

the trinocular tube can be equipped with a camera device which can output the image of binocular observation to a monitor or computer for image analysis, processing, preservation or transmission.



### digital viewing head

Digital viewing tube, can be built-in camera module or external camera module, providing Wi-Fi or image output interface, can support remote full resolution photography and multi-viewer.



### photograph accessories

Using the special C-mount and Photo tube, it can be connected to a digital camera to quickly take pictures and acquire images.



Infinity plan semi-apochromatic objective designed for fluorescence observation. The image is vivid and clear, the background is pure black, and the UV fluorescence has outstanding performance, which is the best choice for professional fluorescence observation of various cells and pathological sections.



Infinity plan achromatic objectives, improve the plan and contrast, perfect correction of all kinds of chromatic aberration. Large numerical aperture design provides high definition and high contrast microscopic images.



Infinity plan achromatic phase contrast objective adds phase contrast observation function on the basis of bright field observation, providing high definition, high contrast microscopic images. It is especially suitable for the observation of colorless transparent or light-colored cells.

ASTRA Dimension Chart: mm

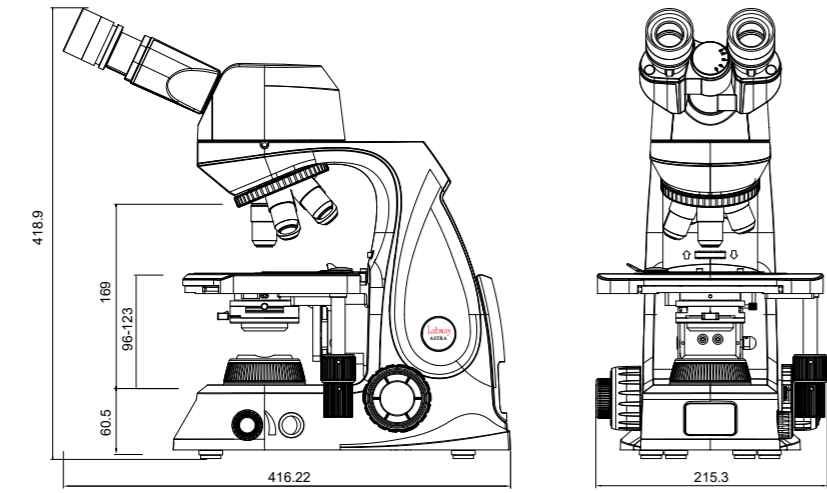

Biological microscope

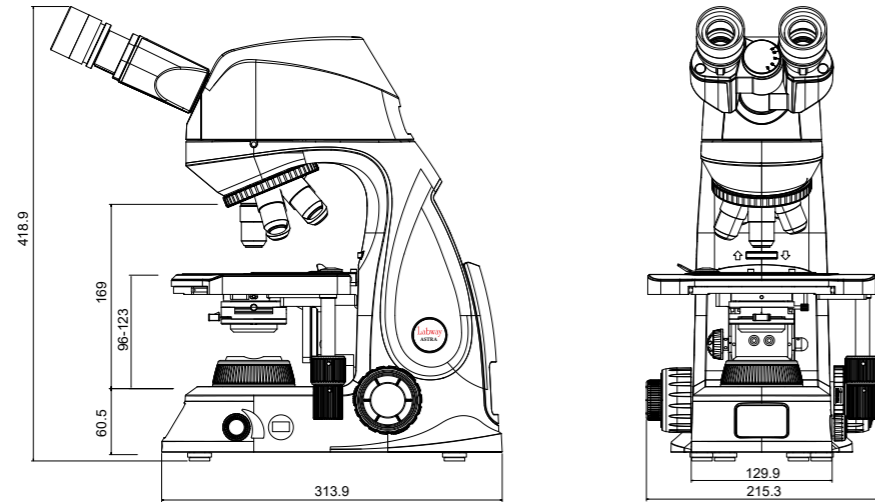

Digital microscope

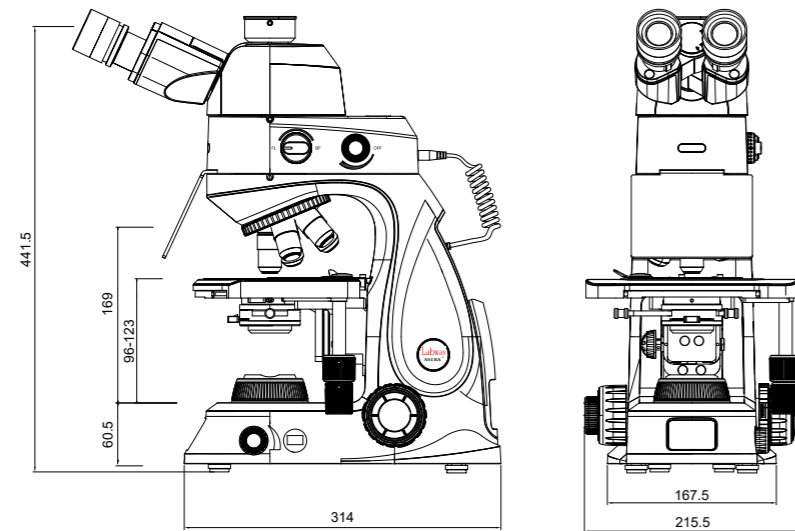

Fluorescent microscope

ASTRA System Configuration Chart

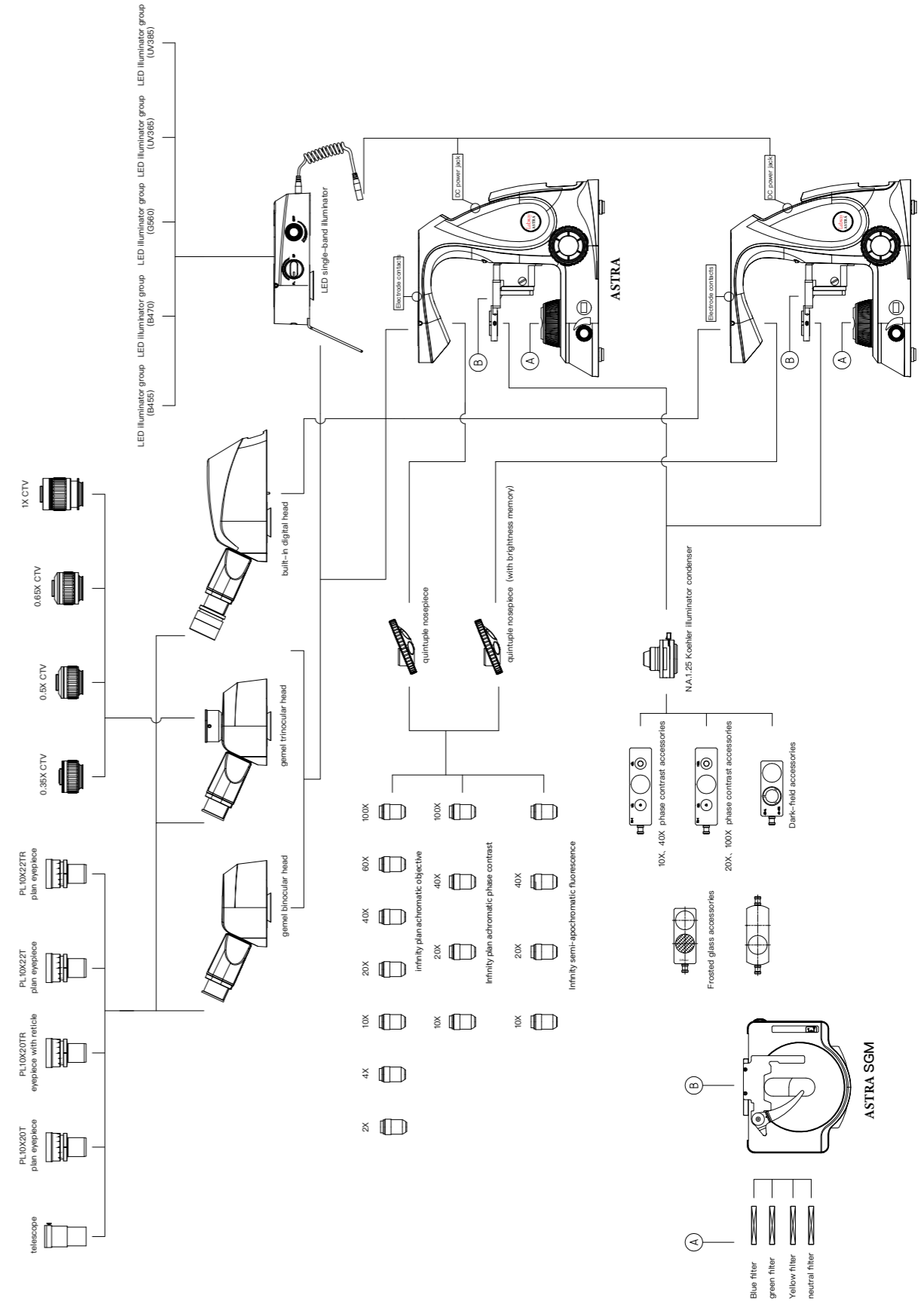

ASTRA-S Digital display, multiplier recognition, brightness memory, color temperature adjustable