

CHM[®]

CHARFIX*system*

INTRAMEDULLARY OSTEOSYNTHESIS OF FEMUR

- *IMPLANTS*
- *INSTRUMENT SET 40.5390.500*
- *SURGICAL TECHNIQUE*



SYMBOLS DESCRIPTION



Caution - pay attention to a special procedure.



Perform the activity under X-Ray control.



Information about the next stages of a procedure.



Proceed to the next stage.



Return to the specified stage and repeat the activity.

www.chm.eu

Document No ST/24-2
Date of issue 02.11.2016
Review date P-004-01.12.2020

*The manufacturer reserves the right to introduce design changes.
Updated INSTRUCTIONS FOR USE are available at the following website: ifu.chm.eu*

I. INTRODUCTION	4
I.1. RECONSTRUCTION, PERTROCHANTERIC METHOD	4
I.2. COMPRESSION, DYNAMIC AND STATIC METHOD	5
I.3. RETROGRADE (CONDYLAR) APPROACH	6
II. IMPLANTS	7
II.1. IMPLANTS FOR RECONSTRUCTION, COMPRESSION AND RETROGRADE METHOD	7
III. INSTRUMENT SET	12
III.1. INTRODUCTION	12
III.2. INSTRUMENT SET FOR FEMORAL NAILS [40.5390.500]	12
IV. SURGICAL TECHNIQUE	15
IV.1. METHODS: RECONSTRUCTION, COMPRESSION, DYNAMIC, STATIC	15
<i>IV.1.1. Introduction</i>	15
<i>IV.1.2. Preparation of medullary canal and nail insertion</i>	17
IV.2. RECONSTRUCTION METHOD	20
<i>IV.2.1. Proximal locking of the nail</i>	20
<i>IV.2.1.A. OPTION I: Locking with reconstruction screws</i>	20
<i>IV.2.1.B. OPTION II: Locking with reconstruction cannulated screws</i>	23
<i>IV.2.2. Distal locking of the nail</i>	25
<i>IV.2.3. Targeter removal, end cap insertion</i>	28
<i>IV.2.4. Distal locking of the nail using "freehand technique"</i>	29
IV.3. DYNAMIC AND COMPRESSION METHODS	31
<i>IV.3.1. Distal locking of the nail</i>	31
<i>IV.3.2. Proximal locking of the nail</i>	32
<i>IV.3.3. Targeter removal</i>	34
<i>IV.3.4. Compression screw insertion</i>	34
<i>IV.3.5. End cap insertion (dynamic method only)</i>	34
IV.4. STATIC METHOD	35
<i>IV.4.1. Distal locking of the nail</i>	35
<i>IV.4.2. Proximal locking of the nail</i>	35
<i>IV.4.3. Targeter removal, end cap insertion</i>	38
IV.5. STATIC METHOD WITH USE OF RECONSTRUCTION NAIL	39
<i>IV.5.1. Proximal locking of the nail</i>	39
<i>IV.5.2. Distal locking of the nail</i>	40
<i>IV.5.3. Targeter removal, end cap insertion</i>	41
IV.6. NAIL EXTRACTION	41
IV.7. SURGICAL TECHNIQUE - RETROGRADE METHOD (CONDYLAR APPROACH)	42
<i>IV.7.1. Implants for retrograde method</i>	42
<i>IV.7.2. Introduction</i>	43
<i>IV.7.3. Nail assembling to the targeter, nail insertion into the medullary canal</i>	46
<i>IV.7.4. Locking the nail in the condyle of femur</i>	47
<i>IV.7.4.A. OPTION I: Locking with a screw</i>	47
<i>IV.7.4.B. OPTION II: Locking with locking set (bolt - 2 washers - locking screw)</i>	48
<i>IV.7.5. Nail locking in the shaft part</i>	49
<i>IV.7.6. Targeter removal, end cap insertion</i>	51
<i>IV.7.7. Nail extraction</i>	51

I. INTRODUCTION

- **CHARFIX** system provides the following methods of intramedullary fixation, depending on the femur fracture type:
 - reconstruction,
 - compression, dynamic, static,
 - retrograde (*condylar approach*).
- Each fixation method of **CHARFIX** system comes with:
 - adequate selection of implants (*intramedullary nails, screws, locking screws*),
 - instrument sets for implants insertion and removal,
 - Instructions for Use (*surgical technique*).

The presented range of implants is made of titanium and its alloys and implantable steel in accordance with ISO 5832 standard. Compliance with the requirements of Quality Management Systems and the requirements of Directive 93/42/EEC concerning medical devices guarantee high quality of the offered implants.

I.1. RECONSTRUCTION, PERTROCHANTERIC METHOD

Reconstruction nails are used for intramedullary fixation of proximal femur, neck and near trochanter fractures. Angular position of reconstruction screws ensures anatomical position of the head and trochanteric region against the femoral shaft.

The nail comes in two versions: right nail for right femur, left nail for left femur.

Position of the implants in femur:

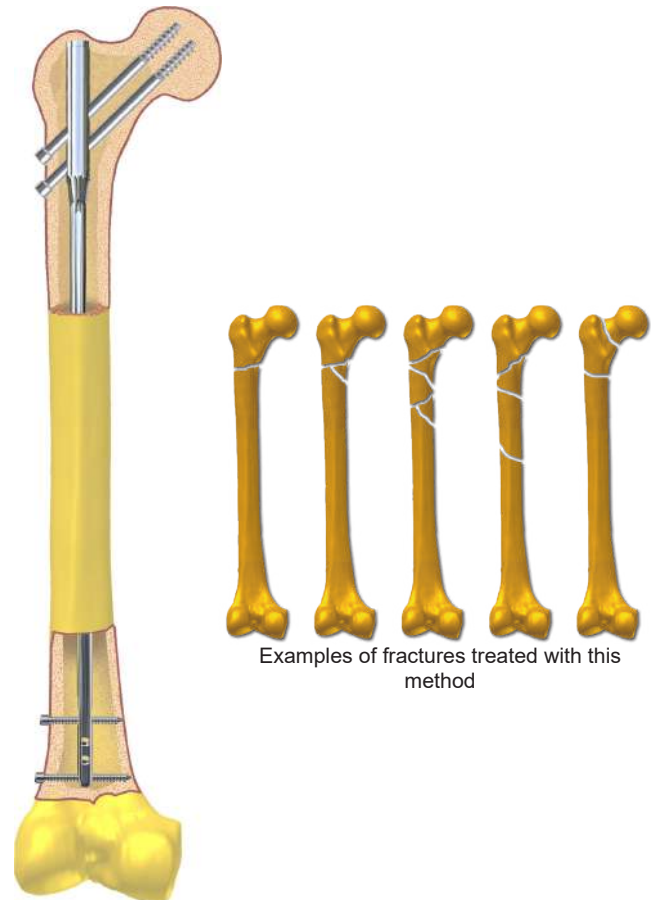

To fix the femoral fracture fragments with pertrochanteric method use:

- right nail for fixation of the left femur fractures,
- left nail for fixation of the right femur fractures.

Position of implants in femur:

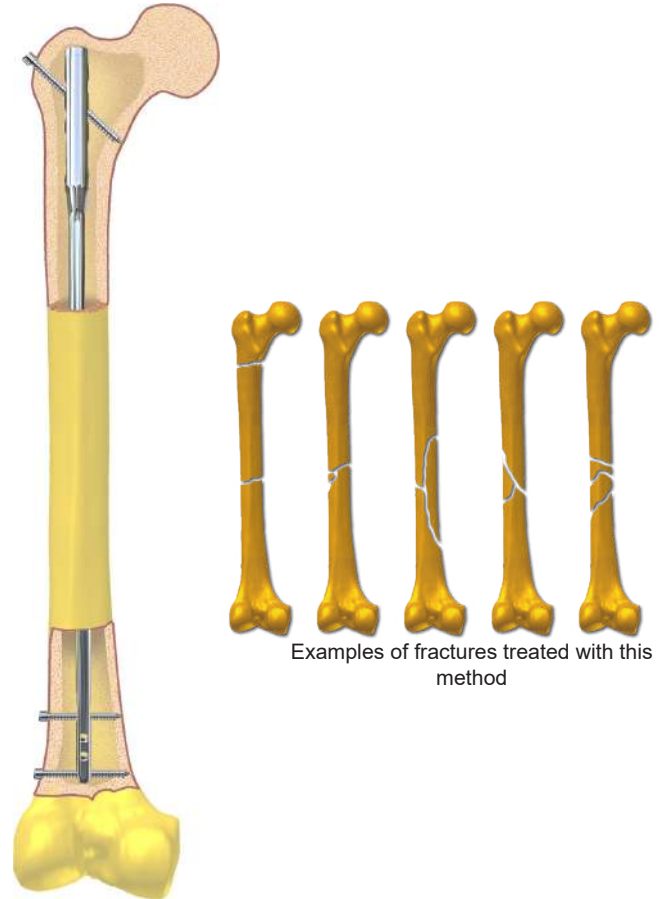

I.2. COMPRESSION, DYNAMIC AND STATIC METHOD

Compressive locking is used in the intramedullary fixations of femoral shaft fractures, providing that fractures are not closer than 3cm from a locking screw.

Nail design allows for treatment with the compression, dynamic and static method.

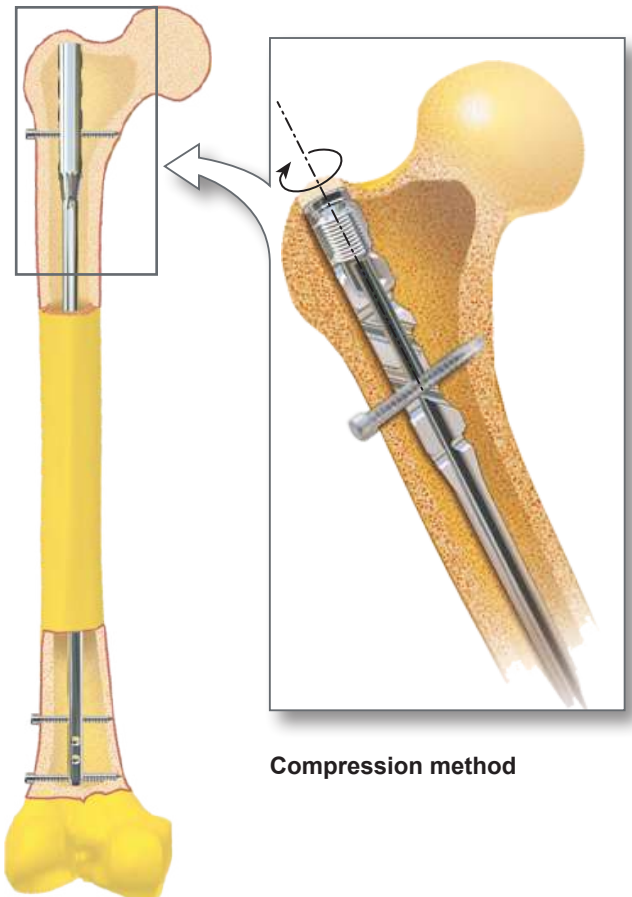

Static locking
 Position of implants in femur:

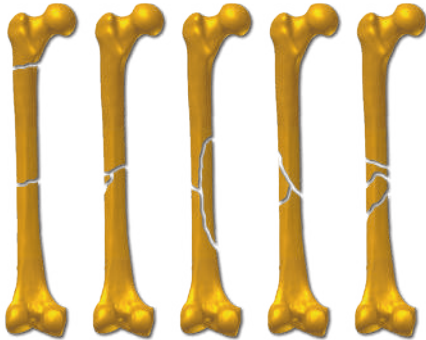

Examples of femoral shaft fractures treated with this method

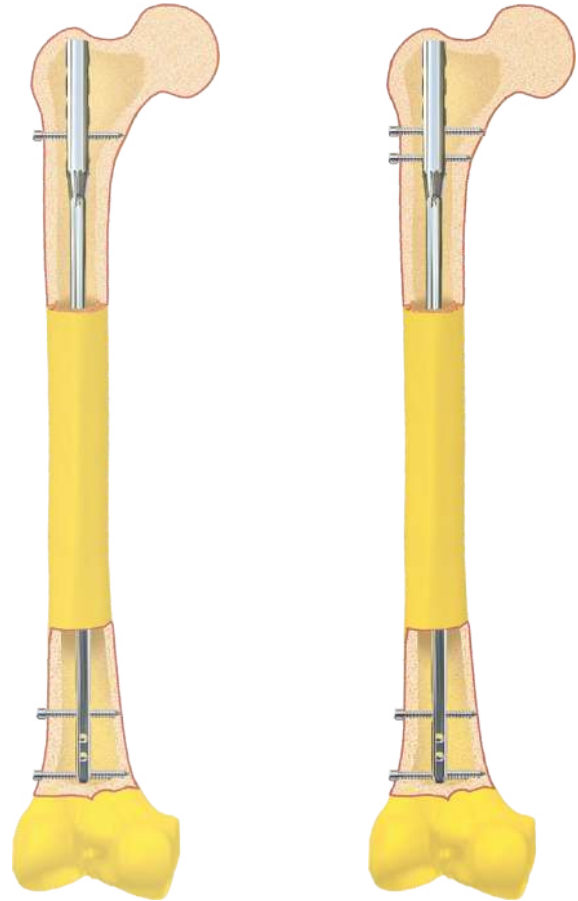

I.3. RETROGRADE (CONDYLAR) APPROACH

Intramedullary nails with condylar approach enable fracture fixation in the distal part of femur when any other fixation method (*reconstruction, compression, dynamic, static*) cannot be used. The reversed method can be used if prosthesis or other implant is located in the proximal femur or in case of multifragmental fracture of the condyle.

Position of the implants in femur

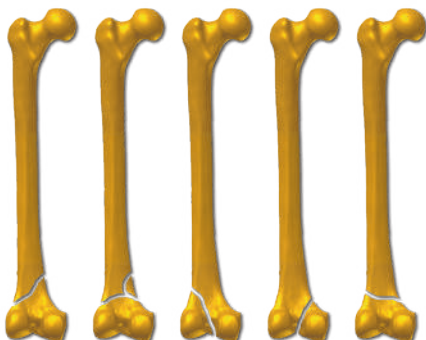

Examples of femoral shaft fractures treated with this method

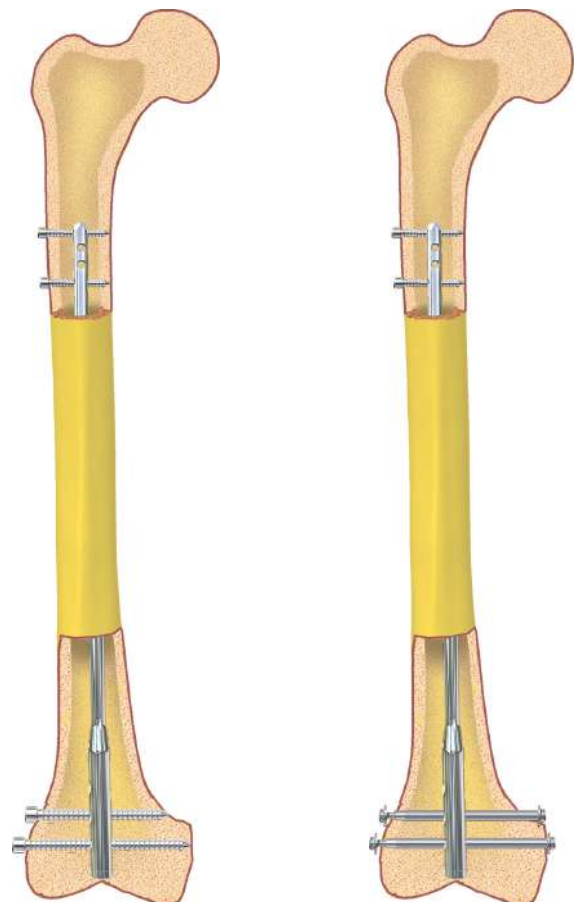

II. IMPLANTS

II.1. IMPLANTS FOR RECONSTRUCTION, COMPRESSION AND RETROGRADE METHOD

FEMORAL NAIL

Reconstruction Method:

- Steel: 1.2104.300-315, Titanium: 3.2104.300-315
- Steel: 1.1651.040-110, Titanium: 3.1651.040-110
- Steel: 1.1652.060-120, Titanium: 3.1652.060-120

Compression Method:

- Steel: 1.2106.007, Titanium: 3.2106.007

Retrograde Method:

- Steel: 1.1654.030-090, Titanium: 3.1654.030-090
- Steel: 1.2109.050-090, Titanium: 3.2109.050-090

Locking Pins:

- Steel: 1.1654.030-090, Titanium: 3.1654.030-090
- Steel: 1.2104.002, Titanium: 3.2104.002

Locking Screws:

- Steel: 1.1651.040-110, Titanium: 3.1651.040-110

Labels: cannulated, solid, left, right, reconstruction method, compression method, retrograde method.

FEMORAL NAIL

		Steel		Titanium				Steel		Titanium	
L [mm]	Ø	left	right	left	right	L [mm]	Ø	left	right	left	right
200	9	1.2855.200	1.2854.200	3.2855.200	3.2854.200	200	12	1.2861.200	1.2860.200	3.2861.200	3.2860.200
220		1.2855.220	1.2854.220	3.2855.220	3.2854.220	220		1.2861.220	1.2860.220	3.2861.220	3.2860.220
240		1.2855.240	1.2854.240	3.2855.240	3.2854.240	240		1.2861.240	1.2860.240	3.2861.240	3.2860.240
260		1.2855.260	1.2854.260	3.2855.260	3.2854.260	260		1.2861.260	1.2860.260	3.2861.260	3.2860.260
280		1.2855.280	1.2854.280	3.2855.280	3.2854.280	280		1.2861.280	1.2860.280	3.2861.280	3.2860.280
300		1.2855.300	1.2854.300	3.2855.300	3.2854.300	300		1.2861.300	1.2860.300	3.2861.300	3.2860.300
320		1.2855.320	1.2854.320	3.2855.320	3.2854.320	320		1.2861.320	1.2860.320	3.2861.320	3.2860.320
340		1.2855.340	1.2854.340	3.2855.340	3.2854.340	340		1.2861.340	1.2860.340	3.2861.340	3.2860.340
360		1.2855.360	1.2854.360	3.2855.360	3.2854.360	360		1.2861.360	1.2860.360	3.2861.360	3.2860.360
380		1.2855.380	1.2854.380	3.2855.380	3.2854.380	380		1.2861.380	1.2860.380	3.2861.380	3.2860.380
400		1.2855.400	1.2854.400	3.2855.400	3.2854.400	400		1.2861.400	1.2860.400	3.2861.400	3.2860.400
420		1.2855.420	1.2854.420	3.2855.420	3.2854.420	420		1.2861.420	1.2860.420	3.2861.420	3.2860.420
440		1.2855.440	1.2854.440	3.2855.440	3.2854.440	440		1.2861.440	1.2860.440	3.2861.440	3.2860.440
460		1.2855.460	1.2854.460	3.2855.460	3.2854.460	460		1.2861.460	1.2860.460	3.2861.460	3.2860.460
480		1.2855.480	1.2854.480	3.2855.480	3.2854.480	480		1.2861.480	1.2860.480	3.2861.480	3.2860.480
200		10	1.2857.200	1.2856.200	3.2857.200	3.2856.200		200	13	1.2863.200	1.2862.200
220	1.2857.220		1.2856.220	3.2857.220	3.2856.220	220	1.2863.220	1.2862.220		3.2863.220	3.2862.220
240	1.2857.240		1.2856.240	3.2857.240	3.2856.240	240	1.2863.240	1.2862.240		3.2863.240	3.2862.240
260	1.2857.260		1.2856.260	3.2857.260	3.2856.260	260	1.2863.260	1.2862.260		3.2863.260	3.2862.260
280	1.2857.280		1.2856.280	3.2857.280	3.2856.280	280	1.2863.280	1.2862.280		3.2863.280	3.2862.280
300	1.2857.300		1.2856.300	3.2857.300	3.2856.300	300	1.2863.300	1.2862.300		3.2863.300	3.2862.300
320	1.2857.320		1.2856.320	3.2857.320	3.2856.320	320	1.2863.320	1.2862.320		3.2863.320	3.2862.320
340	1.2857.340		1.2856.340	3.2857.340	3.2856.340	340	1.2863.340	1.2862.340		3.2863.340	3.2862.340
360	1.2857.360		1.2856.360	3.2857.360	3.2856.360	360	1.2863.360	1.2862.360		3.2863.360	3.2862.360
380	1.2857.380		1.2856.380	3.2857.380	3.2856.380	380	1.2863.380	1.2862.380		3.2863.380	3.2862.380
400	1.2857.400		1.2856.400	3.2857.400	3.2856.400	400	1.2863.400	1.2862.400		3.2863.400	3.2862.400
420	1.2857.420		1.2856.420	3.2857.420	3.2856.420	420	1.2863.420	1.2862.420		3.2863.420	3.2862.420
440	1.2857.440		1.2856.440	3.2857.440	3.2856.440	440	1.2863.440	1.2862.440		3.2863.440	3.2862.440
460	1.2857.460		1.2856.460	3.2857.460	3.2856.460	460	1.2863.460	1.2862.460		3.2863.460	3.2862.460
480	1.2857.480		1.2856.480	3.2857.480	3.2856.480	480	1.2863.480	1.2862.480		3.2863.480	3.2862.480
200	11		1.2859.200	1.2858.200	3.2859.200	3.2858.200	200	14		1.2865.200	1.2864.200
220		1.2859.220	1.2858.220	3.2859.220	3.2858.220	220	1.2865.220		1.2864.220	3.2865.220	3.2864.220
240		1.2859.240	1.2858.240	3.2859.240	3.2858.240	240	1.2865.240		1.2864.240	3.2865.240	3.2864.240
260		1.2859.260	1.2858.260	3.2859.260	3.2858.260	260	1.2865.260		1.2864.260	3.2865.260	3.2864.260
280		1.2859.280	1.2858.280	3.2859.280	3.2858.280	280	1.2865.280		1.2864.280	3.2865.280	3.2864.280
300		1.2859.300	1.2858.300	3.2859.300	3.2858.300	300	1.2865.300		1.2864.300	3.2865.300	3.2864.300
320		1.2859.320	1.2858.320	3.2859.320	3.2858.320	320	1.2865.320		1.2864.320	3.2865.320	3.2864.320
340		1.2859.340	1.2858.340	3.2859.340	3.2858.340	340	1.2865.340		1.2864.340	3.2865.340	3.2864.340
360		1.2859.360	1.2858.360	3.2859.360	3.2858.360	360	1.2865.360		1.2864.360	3.2865.360	3.2864.360
380		1.2859.380	1.2858.380	3.2859.380	3.2858.380	380	1.2865.380		1.2864.380	3.2865.380	3.2864.380
400		1.2859.400	1.2858.400	3.2859.400	3.2858.400	400	1.2865.400		1.2864.400	3.2865.400	3.2864.400
420		1.2859.420	1.2858.420	3.2859.420	3.2858.420	420	1.2865.420		1.2864.420	3.2865.420	3.2864.420
440		1.2859.440	1.2858.440	3.2859.440	3.2858.440	440	1.2865.440		1.2864.440	3.2865.440	3.2864.440
460		1.2859.460	1.2858.460	3.2859.460	3.2858.460	460	1.2865.460		1.2864.460	3.2865.460	3.2864.460
480		1.2859.480	1.2858.480	3.2859.480	3.2858.480	480	1.2865.480		1.2864.480	3.2865.480	3.2864.480

FEMORAL NAIL

L [mm]	Ø	Steel				Titanium				L [mm]	Ø	Steel				Titanium			
		left	right	left	right	left	right	left	right			left	right	left	right				
200	8	1.2877.200	1.2876.200	3.2877.200	3.2876.200	200	11	1.2883.200	1.2882.200	3.2883.200	3.2882.200								
220		1.2877.220	1.2876.220	3.2877.220	3.2876.220	220		1.2883.220	1.2882.220	3.2883.220	3.2882.220								
240		1.2877.240	1.2876.240	3.2877.240	3.2876.240	240		1.2883.240	1.2882.240	3.2883.240	3.2882.240								
260		1.2877.260	1.2876.260	3.2877.260	3.2876.260	260		1.2883.260	1.2882.260	3.2883.260	3.2882.260								
280		1.2877.280	1.2876.280	3.2877.280	3.2876.280	280		1.2883.280	1.2882.280	3.2883.280	3.2882.280								
300		1.2877.300	1.2876.300	3.2877.300	3.2876.300	300		1.2883.300	1.2882.300	3.2883.300	3.2882.300								
320		1.2877.320	1.2876.320	3.2877.320	3.2876.320	320		1.2883.320	1.2882.320	3.2883.320	3.2882.320								
340		1.2877.340	1.2876.340	3.2877.340	3.2876.340	340		1.2883.340	1.2882.340	3.2883.340	3.2882.340								
360		1.2877.360	1.2876.360	3.2877.360	3.2876.360	360		1.2883.360	1.2882.360	3.2883.360	3.2882.360								
380		1.2877.380	1.2876.380	3.2877.380	3.2876.380	380		1.2883.380	1.2882.380	3.2883.380	3.2882.380								
400		1.2877.400	1.2876.400	3.2877.400	3.2876.400	400		1.2883.400	1.2882.400	3.2883.400	3.2882.400								
420		1.2877.420	1.2876.420	3.2877.420	3.2876.420	420		1.2883.420	1.2882.420	3.2883.420	3.2882.420								
440		1.2877.440	1.2876.440	3.2877.440	3.2876.440	440		1.2883.440	1.2882.440	3.2883.440	3.2882.440								
460		1.2877.460	1.2876.460	3.2877.460	3.2876.460	460		1.2883.460	1.2882.460	3.2883.460	3.2882.460								
480		1.2877.480	1.2876.480	3.2877.480	3.2876.480	480		1.2883.480	1.2882.480	3.2883.480	3.2882.480								
200		9	1.2879.200	1.2878.200	3.2879.200	3.2878.200		200	12	1.2885.200	1.2884.200	3.2885.200	3.2884.200						
220	1.2879.220		1.2878.220	3.2879.220	3.2878.220	220	1.2885.220	1.2884.220		3.2885.220	3.2884.220								
240	1.2879.240		1.2878.240	3.2879.240	3.2878.240	240	1.2885.240	1.2884.240		3.2885.240	3.2884.240								
260	1.2879.260		1.2878.260	3.2879.260	3.2878.260	260	1.2885.260	1.2884.260		3.2885.260	3.2884.260								
280	1.2879.280		1.2878.280	3.2879.280	3.2878.280	280	1.2885.280	1.2884.280		3.2885.280	3.2884.280								
300	1.2879.300		1.2878.300	3.2879.300	3.2878.300	300	1.2885.300	1.2884.300		3.2885.300	3.2884.300								
320	1.2879.320		1.2878.320	3.2879.320	3.2878.320	320	1.2885.320	1.2884.320		3.2885.320	3.2884.320								
340	1.2879.340		1.2878.340	3.2879.340	3.2878.340	340	1.2885.340	1.2884.340		3.2885.340	3.2884.340								
360	1.2879.360		1.2878.360	3.2879.360	3.2878.360	360	1.2885.360	1.2884.360		3.2885.360	3.2884.360								
380	1.2879.380		1.2878.380	3.2879.380	3.2878.380	380	1.2885.380	1.2884.380		3.2885.380	3.2884.380								
400	1.2879.400		1.2878.400	3.2879.400	3.2878.400	400	1.2885.400	1.2884.400		3.2885.400	3.2884.400								
420	1.2879.420		1.2878.420	3.2879.420	3.2878.420	420	1.2885.420	1.2884.420		3.2885.420	3.2884.420								
440	1.2879.440		1.2878.440	3.2879.440	3.2878.440	440	1.2885.440	1.2884.440		3.2885.440	3.2884.440								
460	1.2879.460		1.2878.460	3.2879.460	3.2878.460	460	1.2885.460	1.2884.460		3.2885.460	3.2884.460								
480	1.2879.480		1.2878.480	3.2879.480	3.2878.480	480	1.2885.480	1.2884.480		3.2885.480	3.2884.480								
200	10		1.2881.200	1.2880.200	3.2881.200	3.2880.200	200	13		1.2887.200	1.2886.200	3.2887.200	3.2886.200						
220		1.2881.220	1.2880.220	3.2881.220	3.2880.220	220	1.2887.220		1.2886.220	3.2887.220	3.2886.220								
240		1.2881.240	1.2880.240	3.2881.240	3.2880.240	240	1.2887.240		1.2886.240	3.2887.240	3.2886.240								
260		1.2881.260	1.2880.260	3.2881.260	3.2880.260	260	1.2887.260		1.2886.260	3.2887.260	3.2886.260								
280		1.2881.280	1.2880.280	3.2881.280	3.2880.280	280	1.2887.280		1.2886.280	3.2887.280	3.2886.280								
300		1.2881.300	1.2880.300	3.2881.300	3.2880.300	300	1.2887.300		1.2886.300	3.2887.300	3.2886.300								
320		1.2881.320	1.2880.320	3.2881.320	3.2880.320	320	1.2887.320		1.2886.320	3.2887.320	3.2886.320								
340		1.2881.340	1.2880.340	3.2881.340	3.2880.340	340	1.2887.340		1.2886.340	3.2887.340	3.2886.340								
360		1.2881.360	1.2880.360	3.2881.360	3.2880.360	360	1.2887.360		1.2886.360	3.2887.360	3.2886.360								
380		1.2881.380	1.2880.380	3.2881.380	3.2880.380	380	1.2887.380		1.2886.380	3.2887.380	3.2886.380								
400		1.2881.400	1.2880.400	3.2881.400	3.2880.400	400	1.2887.400		1.2886.400	3.2887.400	3.2886.400								
420		1.2881.420	1.2880.420	3.2881.420	3.2880.420	420	1.2887.420		1.2886.420	3.2887.420	3.2886.420								
440		1.2881.440	1.2880.440	3.2881.440	3.2880.440	440	1.2887.440		1.2886.440	3.2887.440	3.2886.440								
460		1.2881.460	1.2880.460	3.2881.460	3.2880.460	460	1.2887.460		1.2886.460	3.2887.460	3.2886.460								
480		1.2881.480	1.2880.480	3.2881.480	3.2880.480	480	1.2887.480		1.2886.480	3.2887.480	3.2886.480								

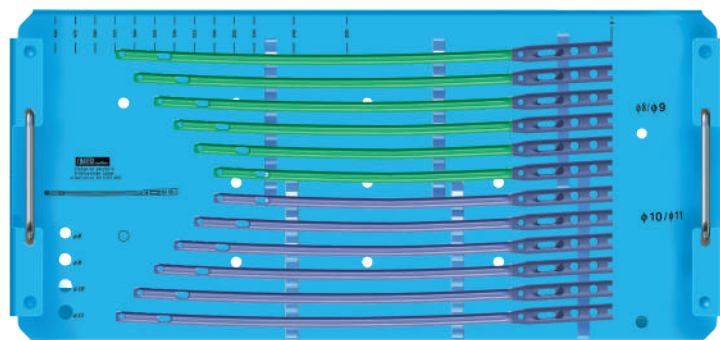

40.5753.000
Stand for universal femoral nails (implants not included)

available						
Ø [mm] pitch 1 mm	8+15	8+10	11+15			
L [mm] pitch 5 mm	160+600	160+600	160+600			
Titanium	Ø8	Ø9	Ø10	Ø11	Ø12	Ø13
left						
right						
	colours					

LOCKING ELEMENTS



Catalogue no.			
A	Steel	Titanium	
0	1.2104.300	3.2104.300	
+5	1.2104.305	3.2104.305	
+10	1.2104.310	3.2104.310	
+15	1.2104.315	3.2104.315	



Catalogue no.			
A	Steel	Titanium	
2	1.2104.002	3.2104.002	



Catalogue no.			
		Steel	Titanium
		1.2106.007	3.2106.007

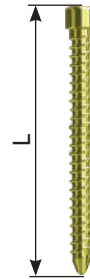
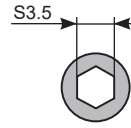

CHARFIX Distal screw 4.5

Catalogue no.			
L [mm]	Steel	Titanium	
30	1.1654.030	3.1654.030	
35	1.1654.035	3.1654.035	
40	1.1654.040	3.1654.040	
45	1.1654.045	3.1654.045	
50	1.1654.050	3.1654.050	
55	1.1654.055	3.1654.055	
60	1.1654.060	3.1654.060	
65	1.1654.065	3.1654.065	
70	1.1654.070	3.1654.070	
75	1.1654.075	3.1654.075	
80	1.1654.080	3.1654.080	
85	1.1654.085	3.1654.085	
90	1.1654.090	3.1654.090	

available

L [mm]	16 ÷ 100
--------	----------

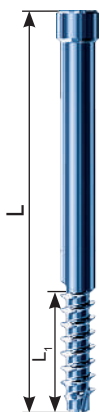
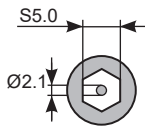

CHARFIX Reconstruction cannulated screw 6.5

Catalogue no.				
L [mm]	L ₁ [mm]	Steel	Titanium	
60	25	1.1652.060	3.1652.060	
65	25	1.1652.065	3.1652.065	
70	25	1.1652.070	3.1652.070	
75	25	1.1652.075	3.1652.075	
80	25	1.1652.080	3.1652.080	
85	25	1.1652.085	3.1652.085	
90	25	1.1652.090	3.1652.090	
95	32	1.1652.095	3.1652.095	
100	32	1.1652.100	3.1652.100	
105	32	1.1652.105	3.1652.105	
110	32	1.1652.110	3.1652.110	
115	32	1.1652.115	3.1652.115	
120	32	1.1652.120	3.1652.120	

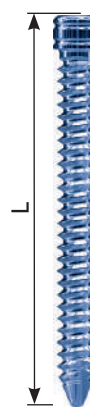
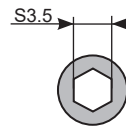

CHARFIX Distal screw 6.5

Catalogue no.			
L [mm]	Steel	Titanium	
40	1.1651.040	3.1651.040	
45	1.1651.045	3.1651.045	
50	1.1651.050	3.1651.050	
55	1.1651.055	3.1651.055	
60	1.1651.060	3.1651.060	
65	1.1651.065	3.1651.065	
70	1.1651.070	3.1651.070	
75	1.1651.075	3.1651.075	
80	1.1651.080	3.1651.080	
85	1.1651.085	3.1651.085	
90	1.1651.090	3.1651.090	
95	1.1651.095	3.1651.095	
100	1.1651.100	3.1651.100	
105	1.1651.105	3.1651.105	
110	1.1651.110	3.1651.110	

available

L [mm]	30 ÷ 110
--------	----------

CHARFIX Locking set



Catalogue no.			
L [mm]	Range	Steel	Titanium
50	50-65[mm]	1.2109.050	3.2109.050
60	60-75[mm]	1.2109.060	3.2109.060
70	70-85[mm]	1.2109.070	3.2109.070
80	80-95[mm]	1.2109.080	3.2109.080
90	90-105[mm]	1.2109.090	3.2109.090

LOCKING ELEMENTS

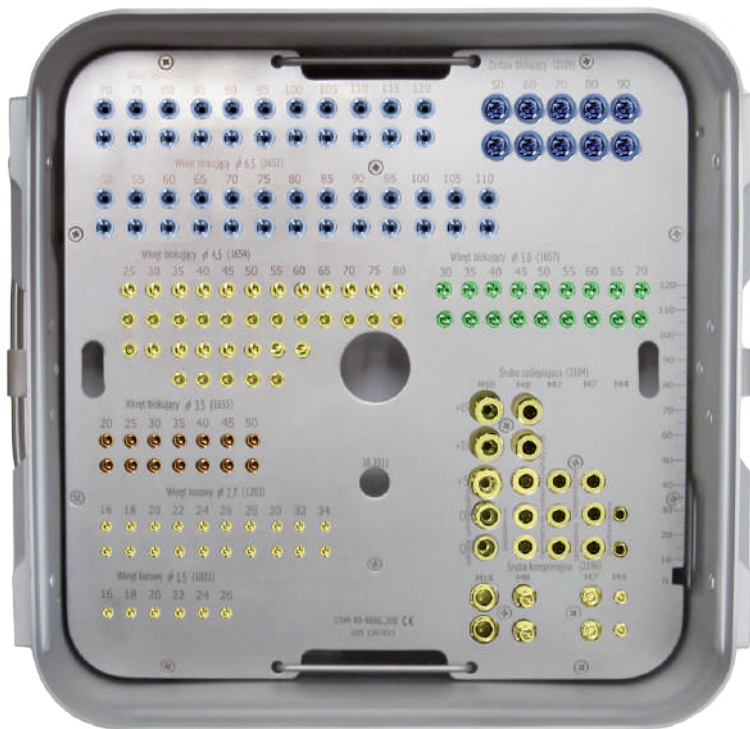

40.4686.200
Stand for CHARFIX nail locking elements (set with a box
without implants)

















III. INSTRUMENT SET











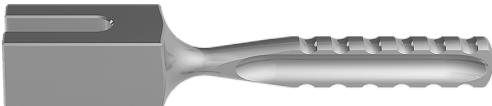











III.1. INTRODUCTION

For the fixation of the femoral fractures with reconstruction, compression, dynamic or static method and implants removal when the treatment has been complete, a single instrument set [40.5390.500] is used.

III.2. INSTRUMENT SET FOR FEMORAL NAILS [40.5390.500]

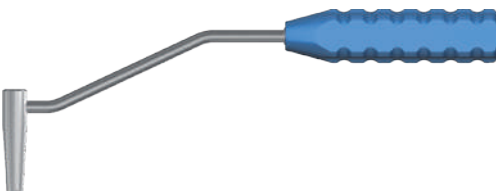
The set of instruments and devices is placed on a stand with a lid to enable sterilization and transportation to the operating suite.

No.		Name	Catalogue no.	Pcs.
1		Targeter arm	40.5091.000	1
2		Targeter 135	40.5092.000	1
3		Distal targeter D	40.5093.000	1
4		Connecting screw M10x1 L=55	40.5094.000	1
5		Connecting screw M10x1 L=66	40.5095.000	1
6		Compression screw	40.5096.000	1
7		Nail length measure	40.5098.000	1
8		Trocar 9	40.3327.000	1
9		Protective guide 11/9	40.3328.000	2
10		Drill guide 9/6.5	40.3329.000	1
11		Drill guide 9/4.5	40.3330.000	1
12		Kirschner guide	40.3331.000	1
13		Reconstruction screw length measure	40.3332.000	1
14		Kirschner wire 2.0/380	40.3333.000	4
15		Protective guide 9/6.5	40.3614.000	2
16		Drill guide 6.5/3.5	40.3615.000	2
17		Set block 9/4.5	40.3616.000	2
18		Trocar 6.5	40.3617.000	1
19		Drill guide 6.5/4.5	40.3696.000	1
20		Screw length measure	40.1374.000	1
21		Curved awl 8.0	40.5523.000	1
22		Impactor-extractor	40.5507.000	1

No.		Name	Catalogue no.	Pcs.
23		Mallet	40.3667.000	1
24		Connector M10x1/M12	40.5071.000	1
25		Wrench S10	40.5526.100	1
26		Teflon pipe guide	40.1348.000	1
27		Guide rod 3.0/580	40.3925.580	1
28		Guide rod handle	40.1351.000	1
29		Screwdriver S3.5	40.3604.000	1
30		Drill with scale 4.5/370	40.5333.001	1
31		Drill with scale 3.5/270	40.5330.001	2
32		Drill 6.5/370	40.2068.371	1
33		Cannulated drill 6.5/2/300	40.3674.000	1
34		Cannulated screwdriver S5.0/2.2	40.3675.000	1
35		Cannulated screw length measure	40.3676.000	1
36		Aiming insert 9.0	40.5065.009	2
37		Aiming insert 11.0	40.5065.011	2
38		Screwdriver S3.5	40.5074.000	1
39		Bolt guide	40.5075.000	1
40		Drill 4.5/270	40.1387.001	1
41		Targeter D	40.1344.000	1
42		Drill guide short 7/3.5	40.1358.000	1
43		Trocar short 7	40.1354.000	1
44		Protective guide 11/9	40.3662.000	1

No.		Name	Catalogue no.	Pcs.
45		Stand	40.5391.500	1

Additionally, to carry out the procedure, the basic equipment for any orthopedic procedure is required, such as:

- drive,
- set of flexible intramedullary reamers with guide and handle,
- set of awls (*standard and cannulated*),
- set of drill bits,
- Kirschner wires,
- mallets,
- other.

IV. SURGICAL TECHNIQUE

IV.1. METHODS: RECONSTRUCTION, COMPRESSION, DYNAMIC, STATIC

IV.1.1. Introduction

Thanks to the possibility of locking the nail with screws, there is no need to exactly fit the medullary canal. Nail insertion may be performed with and without reaming the medullary canal. In both cases, the diameter of the canal has to be wider than the diameter of the chosen nail. It should be noticed that the diameter of reamed hole should be about 1,5-2 mm greater than the nail diameter. Proximal part of the femur should be widened to the diameter of 13mm or 14mm to the depth of 8cm. It enables an easier insertion of a thicker proximal part of the nail into the medullary canal. Decision about possible reaming after verifying the shape of canal and type of fracture shall be made by the surgeon.

Reaming of medullary canal is not recommended for patients with chest injuries due to the risk of fat embolism.

When the patient cannot be operated at the day of femoral fracture, it is recommended to apply strong traction for 2 to 3 days to spread the fragments. This considerably facilitates fracture reduction and nail insertion.

Patient positioning on an operating table is the integral part of surgical procedure. Presented method of intramedullary osteosynthesis requires radiological examination.

Each surgical procedure must be carefully planned. X-Ray image of the entire femur is essential as to make sure no injuries in its proximal or distal part are overlooked. It is especially important in the cases of nailing the pathological subtrochanteric fractures. Special attention is to be paid to concurrent femoral neck fractures or proximal epiphysis multi-fragmental fractures, and to the possibility of their occurrence during the procedure of nail insertion. During the operation, secondary fractures of main fragments may occur. In such cases, the dynamic stabilization has to be replaced by a static one.

The condition of the hip joint is also very important. In advanced arthrosis or contracture, fixation may be difficult or even impossible to be performed. In addition, it should be verified whether alloplasty of hip or knee has ever been performed on the fractured bone. The procedure has to be carried out on the operating table with traction with the patient placed supine or on the side. The side position enables the approach to the greater trochanter which is especially important with overweight patients.

The supine position provides less favorable access to the greater trochanter, but makes all other stages of the operation considerably easier (*especially rotary corrections*).

In the presented method the supine position is recommended with traction applied behind the condyles of the operated femur.

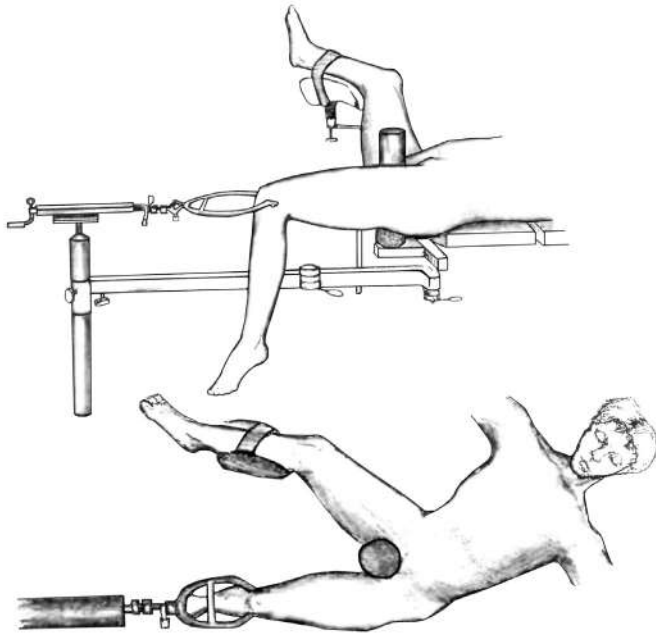
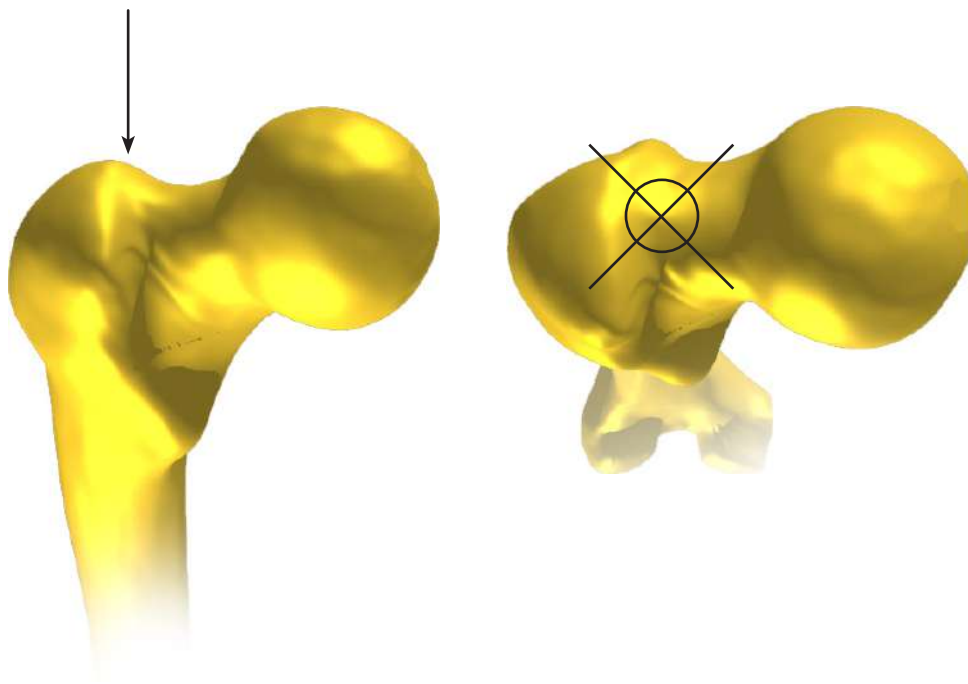

FIG. 1. Supine position for intramedullary osteosynthesis of femur.

Lateral surgical approach shall be applied, starting the incision near the tip of greater trochanter in line with the femoral shaft axis for 8cm. The incision should be longer for overweight patients. The fascia should be cut in the same direction as the performed incision. Fibers of gluteus maximus muscle are then split, as to provide an approach to the tip of greater trochanter from gluteus medius muscle site. The entry point for the nail should be located in line with the axis of medullary canal. It can be found in practice in the following way. If one finds the tip of greater trochanter with their index finger, the entry point for the nail is located “a little bit medially” (*in the direction to the base of the femoral neck*) and “slightly anteriorly”, in a place where one should feel small dale (*fossa piriformis*) with their index finger (see Fig. 2).

FIG. 2 Entry point for femoral nail.





ATTENTION! The following paragraphs describe the most important steps during insertion of intramedullary locking femoral nails; nevertheless, it is not a detailed instructions for use. The surgeon decides about choosing the surgical technique and its application in each individual case.

The physician uses images of both fractured and healthy femur to determine the length, type and diameter of the nail.

IV.1.2. Preparation of medullary canal and nail insertion.

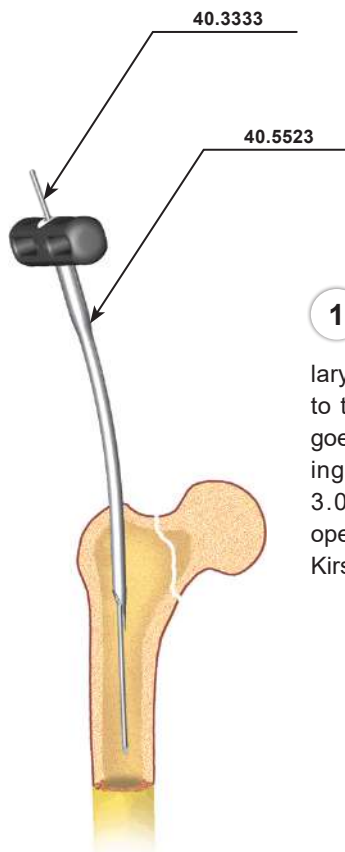

- 1 Using Kirschner wire 2.0/380 [40.3333], insert into the medullary canal curved awl 8.0 [40.5523] to the depth at which the awl blade goes along the medullary canal, allowing proper insertion of guide rod 3.0/580 [40.3925.580]. Having opened the medullary canal, remove Kirschner wire 2.0/380 [40.3333].

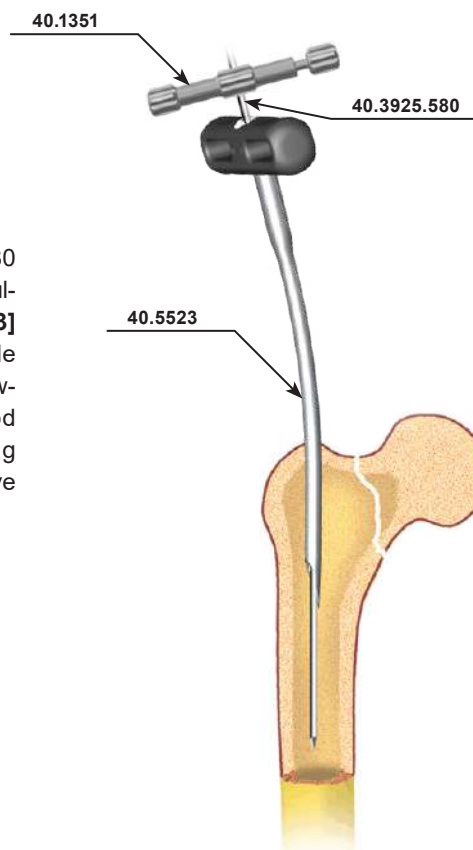

- 2 Mount guide rod 3.0/580 [40.3925.580] to guide rod handle [40.1351] and enter the guide into the medullary canal through curved awl 8.0 [40.5523] cannulated hole to the depth required for the proper fixation of bone fragments. While guide rod insertion, control the fracture reduction and make sure the guide rod passes through all the bone fragments.

Remove guide rod handle [40.1351] and curved awl 8.0 [40.5523]. Leave guide rod 3.0/580 [40.3925.580] in place.



- 3 In the case medullary canal is reamed, gradually increase the diameter with steps of 0.5mm, until the diameter of 1.5 to 2.0mm wider than the diameter of the femoral nail is reached, for the depth at least equal to the nail length (*but not lesser*). In both cases, when the medullary canal was reamed or not, the canal should be reamed using reamer 13 or 14 to the depth of approx. 8 cm.

Remove the flexible reamer.



NOTE! Steps 4 and 5 are applicable only if the medullary canal has been reamed or if another reamer guide (not provided in the instrument set) has been used. Otherwise, go directly to the step 6.



- 4 When using a guide wire which is not included in the instrument set provided, replace it with a guide wire [40.3925.580]. Insert the teflon pipe guide [40.1348] onto the flexible reamer guide until it reaches the end of medullary canal in distal femur.

Remove the reamer guide.



- 5 Mount the guide rod handle [40.1351] on the guide rod 3.0/580 [40.3925.580] and advance into the teflon pipe guide until its tip reaches the distal femur epiphysis.

Remove the guide rod handle [40.1351].
Remove the teflon pipe guide [40.1348].

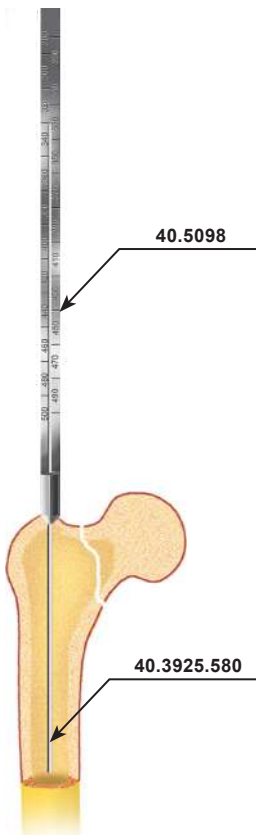

- 6 Insert the nail length measure [40.5098] via the guide rod until it rests on the bone. Read the length on the nail measure to assess the length of intramedullary nail. Remove the nail length measure from the guide rod. In the case of using the solid nail, remove the guide rod. Medullary canal is ready for nail insertion.

- 7 Use the connecting screw:
- M10x1 L=66 [40.5095] in the case of using reconstruction and compression nail,
 - M10x1 L=55 [40.5094] in the case of using universal nail and the wrench S10 [40.5526.100], to fix the intramedullary nail to the targeter arm [40.5091].

Fix the distal targeter D [40.5093] to the targeter arm. Using a pair of the set blocks 9/4.5 [40.3616], place the slider of the distal targeter D in line with distal locking holes of intramedullary nail. Secure the slider of the distal targeter D using the screwdriver S3.5 [40.3604].

**CHECK:**

Properly set and secured slider of the distal targeter D makes it possible to set the set blocks 9/4.5 so that they can pass through the holes of the nail easily.

Remove the set blocks 9/4.5 from the targeter.

Dismount the distal targeter D [40.5093] from the targeter arm [40.5091].



- 8 Mount the impactor-extractor [40.5507] on the targeter arm [40.5091] with already fixed nail. Insert the nail onto the guide rod 3.0/580 [40.3925.580] and in medullary canal. Advance the nail by pushing and maneuvering it until it reaches adequate depth.

Remove the guide rod 3.0/580 [40.3925.580].

Dismount the impactor-extractor [40.5507] from the targeter arm.

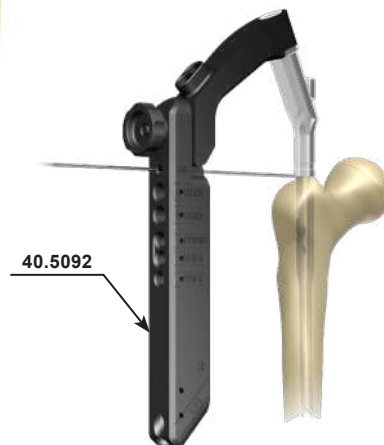

- 8a Mount the targeter 135 [40.5092] on the targeter arm [40.5091].

Use Kirschner wire inserted in the hole of the targeter 135 [40.5092] (marked "0") to verify the correct placement of the nail. The end of the wire shows the beginning of the nail.

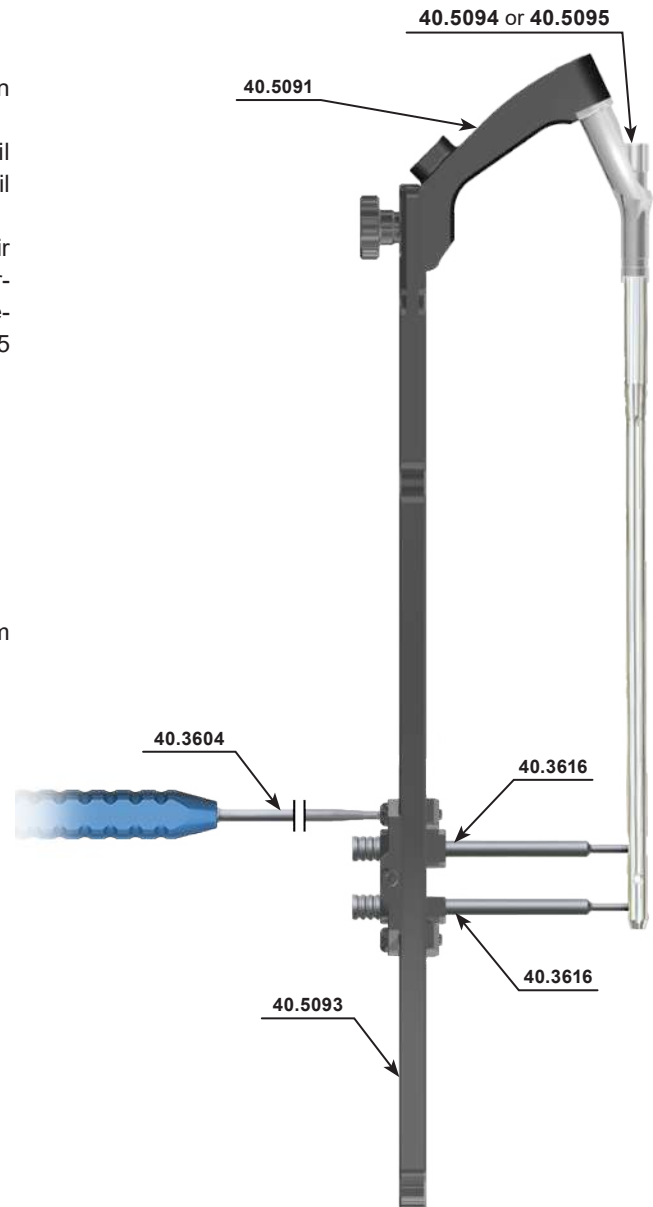

IV.2. RECONSTRUCTION METHOD

IV.2.1. Proximal locking of the nail

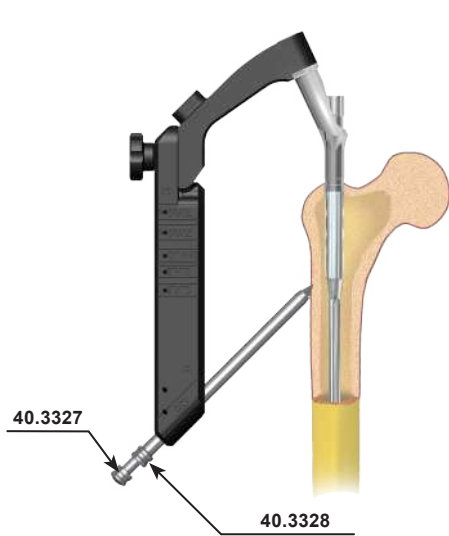
IV.2.1.A. **OPTION I: Locking with reconstruction screws**

- 9 Mount the targeter 135 [40.5092] onto the targeter arm [40.5091]. Insert the protective guide 11/9 [40.3328] with trocar 9 [40.3327] into the most distal hole of the targeter 135 [40.5092]. Mark on the skin the entry point for the screw and make adequate incision of the soft tissues.

Advance the trocar until it reaches the cortex bone and mark the entry point for the drill. Simultaneously advance the protective guide together with trocar until its tip rests on the cortex bone.

Remove the trocar.

Leave the protective guide in the hole.

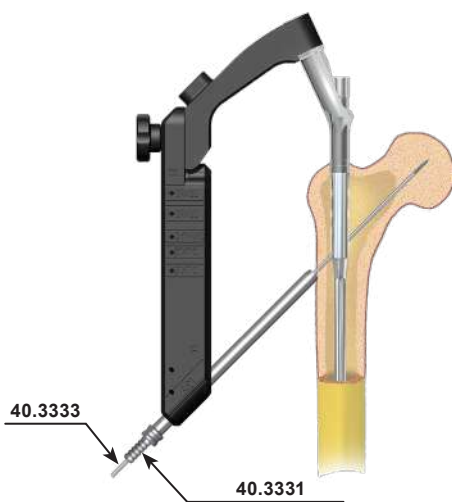

- 10 Insert Kirschner guide [40.3331] into the protective guide. Mount Kirschner wire 2.0/380 [40.3333] to the surgical drive and place the wire into the femoral neck but do not perforate the femoral head. The above steps should be controlled with X-ray imaging (*image in the drawing plane*).

Verify the position of the Kirschner wire in the lateral view. The wire should be located in the middle of the neck; deviation is acceptable if allows the screw insertion without damaging outer cortex of the neck. In the case of mis-positioning of the wire, repeat the step. Leave: Kirschner guide, protective guide and Kirschner wire in place.

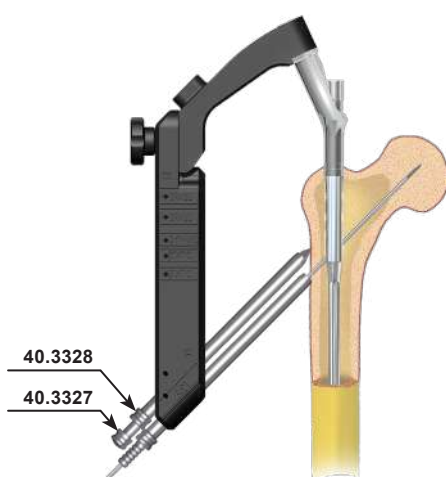

- 11 Insert the protective guide 11/9 [40.3328] with trocar 9 [40.3327] into the second hole of the targeter 135 [40.5092]. Advance the trocar until it reaches the cortex bone and mark the entry point for the drill. Advance the protective guide together with the trocar until it touches the bone.

Remove the trocar.

Leave the protective guide in the hole.

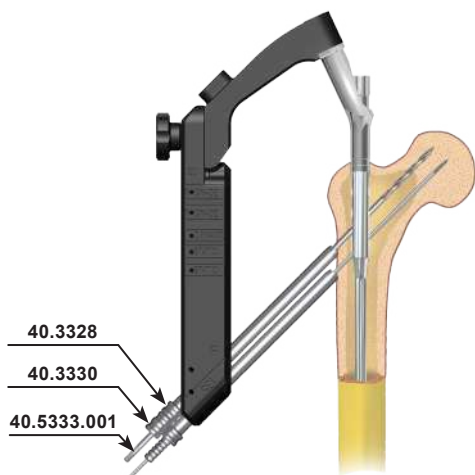

- 12 Insert the drill guide 9/4.5 [40.3330] (with two grooves on the handle) into the protective guide 11/9 [40.3328] located in the second hole of the targeter. Mount the drill with scale 4.5/370 [40.5333.001] to the surgical drive and advance it through the drill guide. Drill the hole in the femoral neck (through the nail hole) until it reaches adequate depth, but do not perforate the head. The scale on the drill shows the length of the locking element. Control the drilling process with the X-Ray image intensifier.

Remove the drill and drill guide.
Leave the protective guide in the hole of targeter.

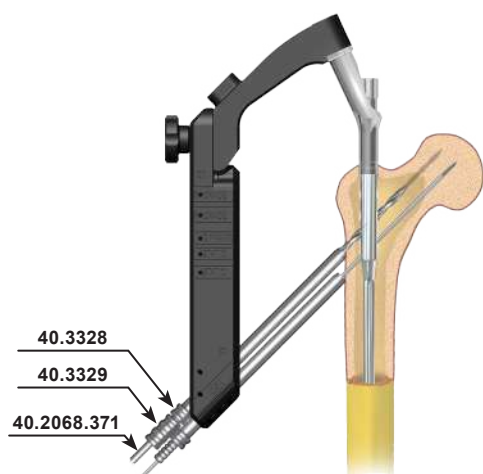

- 13 Insert the drill guide 9/6.5 [40.3329] (with three grooves) into the protective guide 11/9 [40.3328]. Mount the drill 6.5/370 [40.2068.371] to the surgical drive and advance it through the drill guide. Ream the hole in the femoral neck shallower approx. 30mm than before drilled hole with 4.5 drill (due to the length of the thread of the reconstruction screw).



Control the drilling process with the X-Ray image intensifier.

Remove the drill and the drill guide.
Leave the protective guide in the hole of the targeter.

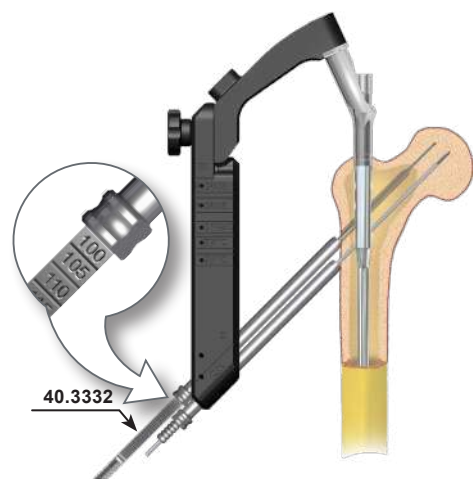

- 14 Insert the reconstruction screw length measure [40.3332] through the protective guide into the drilled hole until it reaches its end. Read the length of the reconstruction screw on the measure. During the measurement the end of the protective guide should rest on the cortex bone.

Remove the reconstruction screw length measure.
Leave the protective guide in the hole of the targeter.

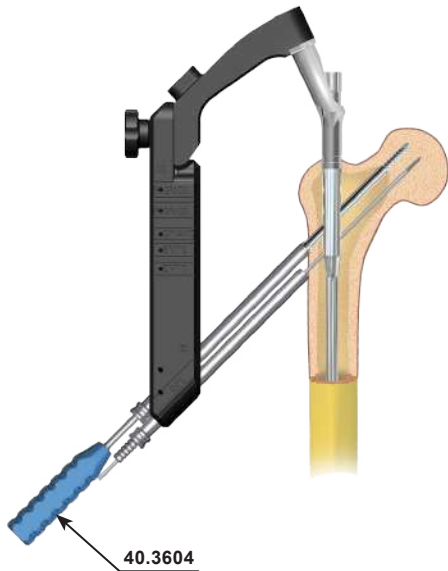

- 15 Insert the tip of the screwdriver S3.5 [40.3604] into the socket of the selected reconstruction screw. Then advance both into the protective guide. Insert the reconstruction screw into the prepared hole until the head of the screw reaches the cortex bone (*the groove on the screwdriver shaft matches the edge of protective guide*).

Remove the screwdriver.

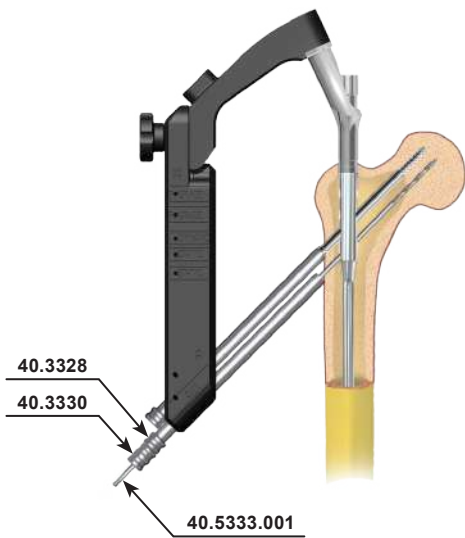

- 16 Remove Kirschner wire and Kirschner guide from the protective guide 11/9 [40.3328] located in the first hole of the targeter. Insert drill guide 9/4.5 [40.3330] (with two grooves) into the protective guide 11/9 [40.3328] (with one groove) left in hole of the targeter. Mount the drill with scale 4.5/370 [40.5333.001] (long) to the surgical drive and advance it through the drill guide. Drill the hole in the femoral neck (*through the hole in the nail*) until it reaches adequate depth, but do not perforate the head. The scale on the drill shows the length of the locking element.



Control the drilling process with the X-Ray image intensifier.

Remove the drill and drill guide.

Leave the protective guide in the hole of the targeter.

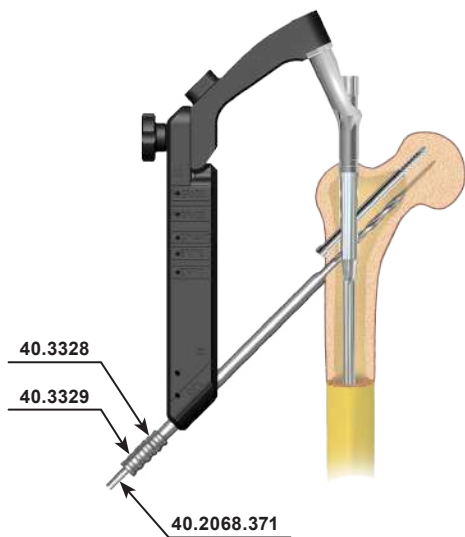

- 17 Insert the drill guide 9/6.5 [40.3329] (with three grooves) into the protective guide 11/9 [40.3328]. Mount the drill 6.5/370 [40.2068.371] to the surgical drive and advance it through the drill guide. Ream the hole in the femoral neck shallower approx. 30mm than before drilled hole with 4.5 drill (*due to the length of the thread of the reconstruction screw*).



Control the drilling process with the X-Ray image intensifier.

Remove the drill and drill guide.

Leave the protective guide in the hole of the targeter.

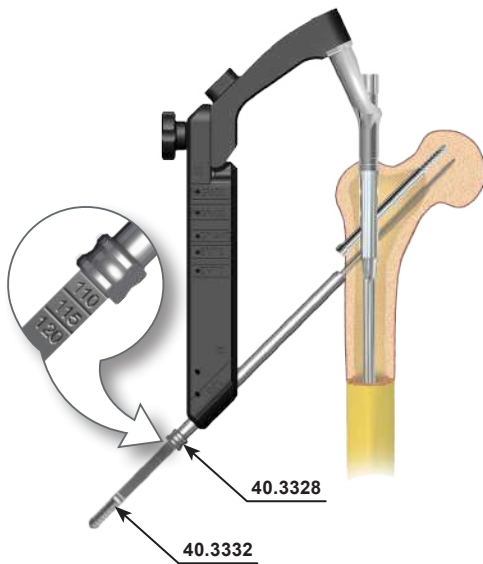

- 18** Insert the reconstruction screw length measure [40.3332] through the protective guide into the drilled hole until it reaches its end. Read the length of the reconstruction screw on the measure. During the measurement the end of the protective guide should rest on the cortex bone.

Remove the reconstruction screw length measure.
Leave the protective guide in the hole of the targeter.

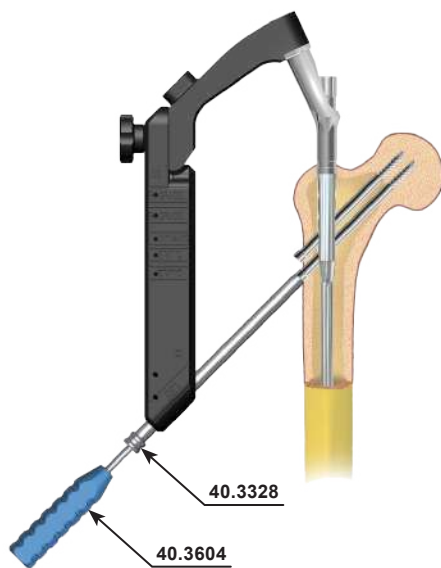

- 19** Insert the tip of the screwdriver S3.5 [40.3604] into the socket of the selected reconstruction screw. Then advance both into the protective guide. Insert the reconstruction screw into the prepared hole until the head of the screw reaches the cortex bone (*the groove on the screwdriver shaft matches the edge of protective guide*).

Remove the screwdriver and protective guide.

IV.2.1.B. **OPTION II: Locking with reconstruction cannulated screws**

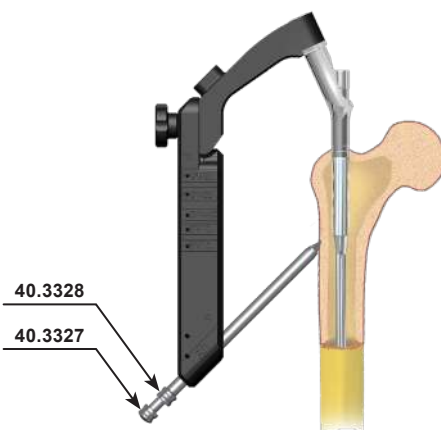

- 20** Insert the protective guide 11/9 [40.3328] with trocar 9 [40.3327] into the most distal hole in the targeter 135 [40.5092]. Mark the entry point for the screw and make adequate incision of the soft tissues. Advance the trocar until it reaches the cortex bone and mark the entry point for the drill. Advance the protective guide together with the trocar until it touches the bone.

Remove the trocar.
Leave the protective guide in the hole.

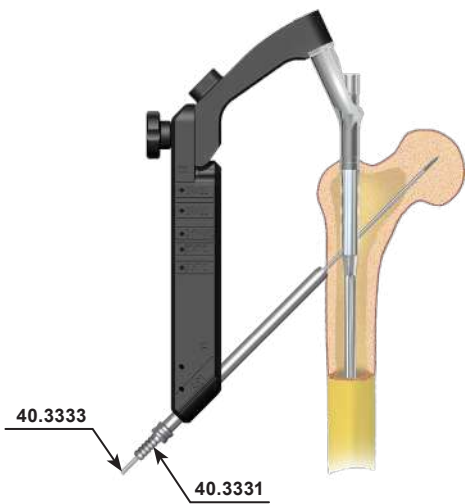

21 Insert Kirschner guide [40.3331] and Kirschner wire 2.0/380 [40.3333] into the protective guide 11/9 [40.3328]. Mount Kirschner wire to the surgical drive and place the wire into the femoral neck but do not perforate the femoral head. The above steps should be controlled with X-Ray (*image in the drawing plane*). Verify the position of the Kirschner wire in the lateral view. The wire should be located in the middle of the neck; deviation is acceptable if allows the screw insertion without damaging outer cortex of the neck. Use only Kirschner wires 2.0/380 [40.3333] with diameter 2.0mm and length 380mm. In the case of mis-positioning of the wire, repeat the step.

Remove Kirschner guide.
Leave Kirschner wire in place.

22 Insert the cannulated screw length measure [40.3676] onto Kirschner wire placed in the femoral neck until its tip touches the protective guide. Read the length of the reconstruction cannulated screw defined by the end of the Kirschner wire. During the measurement the end of the measure should rest on the cortex bone.

Remove the cannulated screw length measure.
Leave Kirschner wire.

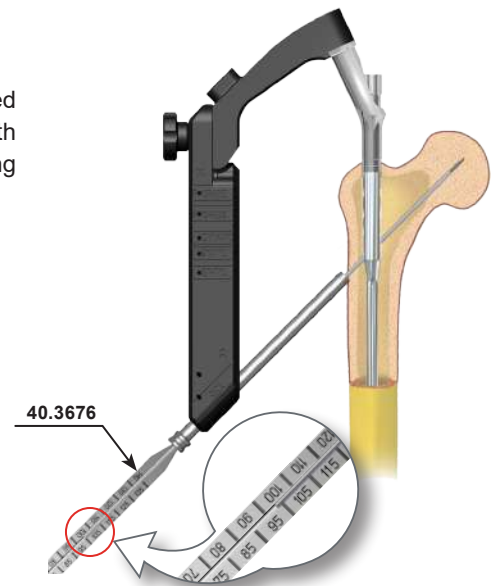

23 Mount the cannulated drill 6.5/2/300 [40.3674] to the surgical drive and advance it via Kirschner wire mounted in the femoral neck. Drill the hole through the first cortex (*up to the nail placed in medullary canal*).

Remove the cannulated drill.
Leave Kirschner wire.

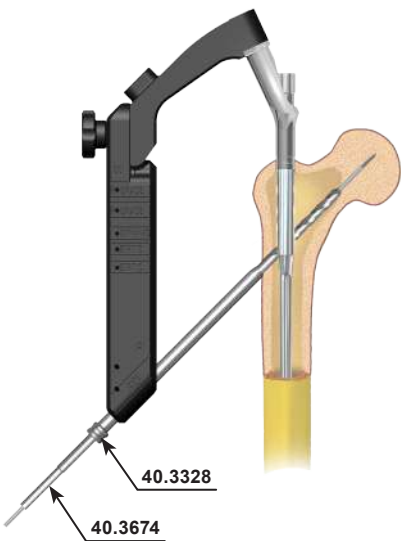

24 Insert the selected reconstruction cannulated screw onto Kirschner wire. Advance the cannulated screwdriver S5.0/2.2 [40.3675] onto Kirschner wire and insert the reconstruction cannulated screw until screw's head reaches cortex bone.

Remove the screwdriver and Kirschner wire.
Kirschner wire is a single use instrument.

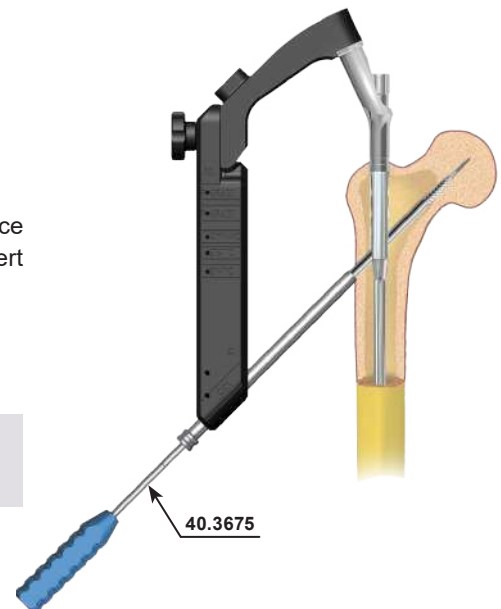

NOTE! For the nail locking in the second hole - repeat steps 21 to 24.

Correctness of femoral neck fixation should be verified by taking X-Ray images in two projections. Small overall dimensions of the targeter 135 which is additionally angled at antetorsion angle allows for taking X-Ray images in lateral position (*C-arm is then positioned at small angle in relation to targeter position*). Nail with its locking elements both seen at radiological image can be helpful in confirming the correctness of the locking performed.

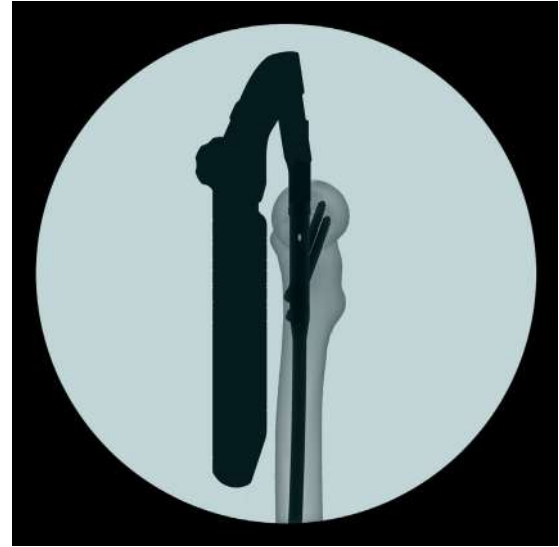

IV.2.2. Distal locking of the nail

Before performing distal locking of the nail, do the following:

1. Mount the distal targeter D [40.5093] on the targeter arm [40.5091]. If properly installed, the signs RIGHT or LEFT on both targeters should comply.
2. Verify, with the X-Ray imaging, the position of holes in the nail and in the targeter. The centers of the holes in nail and targeter have to be in line.

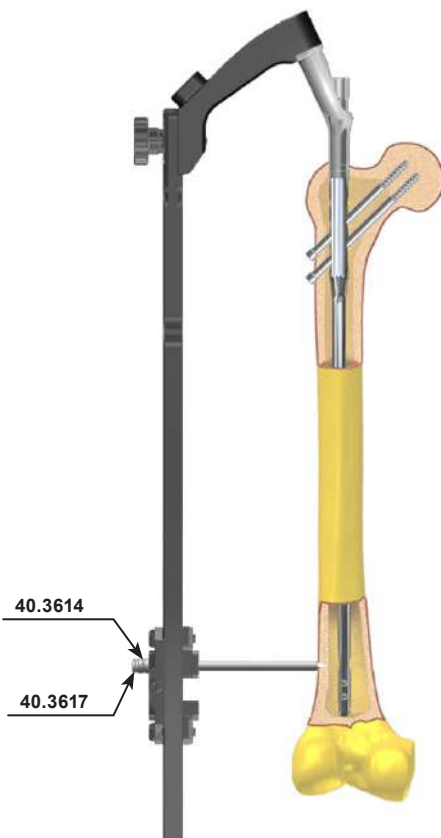

- 25** Insert the protective guide 9/6.5 [40.3614] (with one groove on the handle) with trocar 6.5 [40.3617] into the proximal hole of distal targeter. Mark the entry point for the screw insertion and make adequate incision of the soft tissues. Advance the trocar until it reaches the cortex bone and mark the entry point for the drill. Advance the protective guide together with trocar until it touches the bone.

Remove the trocar.

Leave the protective guide in the hole of the targeter.

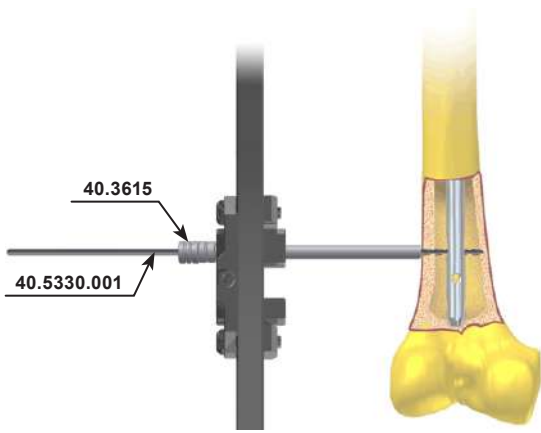

- 26 Insert the drill guide 6.5/3.5 [40.3615] (with two grooves) into the protective guide. Mount the drill with scale 3.5/270 [40.5330.001] to the surgical drive and advance it through the drill guide. Drill the hole in the femur through both cortex layers and the hole in the nail. The scale on the drill shows the length of the locking element.

Disconnect the drive off the drill and leave the system: protective guide-drill guide-drill in place.

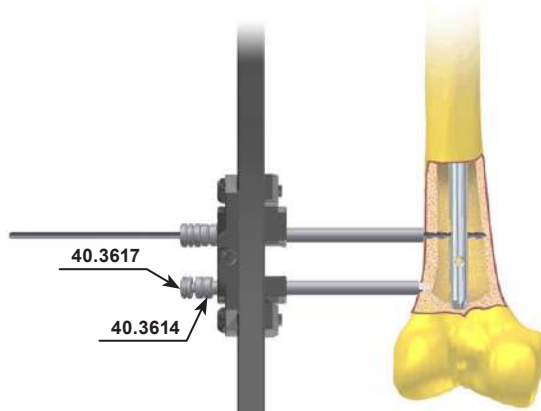

- 27 Insert the protective guide 9/6.5 [40.3614] (with one groove) with trocar 6.5 [40.3617] into the second hole of distal targeter. Advance the trocar until it reaches the cortex bone and mark the entry point for the drill. Advance the protective guide together with the trocar until it touches the bone.

Remove the trocar.
Leave the protective guide in the hole.

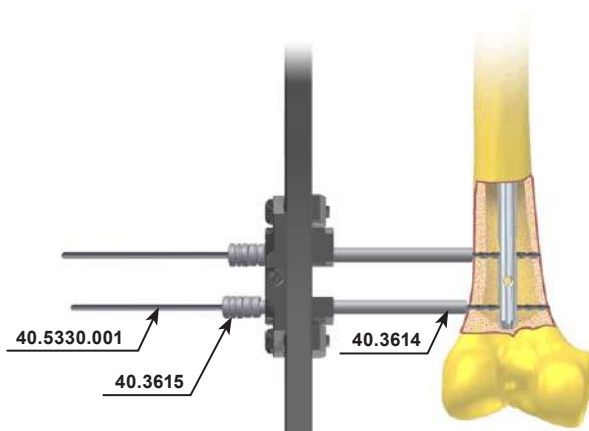

- 28 Insert the drill guide 6.5/3.5 [40.3615] (with two grooves) into the protective guide. Mount the drill with scale 3.5/270 [40.5330.001] to the surgical drive and advance it through the drill guide. Drill the hole in the femur through both cortex layers and the hole in the nail. The scale on the drill shows the length of the locking element.

Remove the drill and drill guide.
Leave the protective guide in the targeter hole.

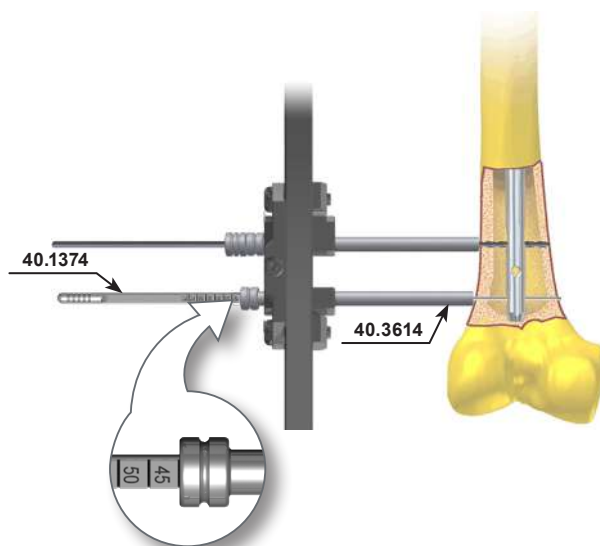

- 29 Insert the screw length measure [40.1374] through the protective guide into the drilled hole until its hook reaches the "exit" plane of the hole. Read the length of the locking screw on the measure. During the measurement, the tip of protective guide should rest on the cortex bone.

Remove the screw length measure.
Leave the protective guide in place.

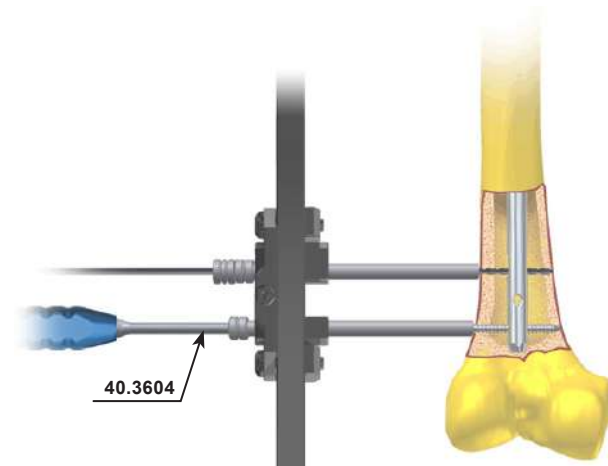

- 30** Insert the tip of the screwdriver S3.5 [40.3604] into the socket of the selected locking screw. Then advance both into the protective guide. Insert the locking screw into prepared hole until the head of the screw reaches the cortex bone (*the groove on the screwdriver shaft matches the edge of the protective guide*).

Remove the screwdriver and protective guide.

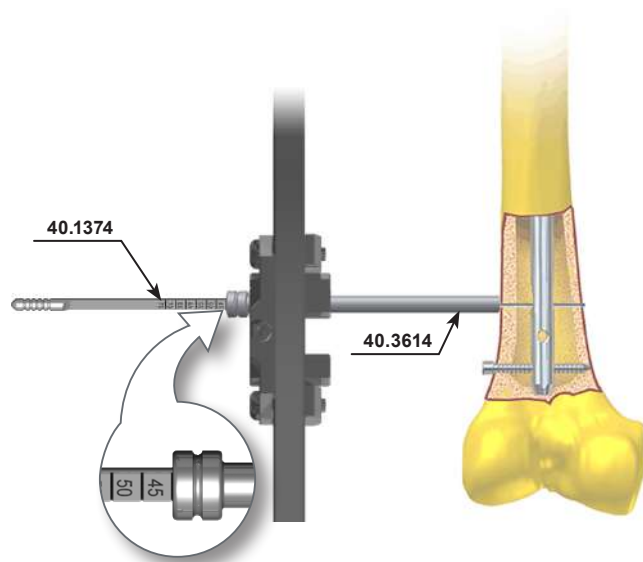

- 31** Remove the drill and drill guide from the proximal hole of the targeter. Leave the protective guide in the hole of the targeter. Insert the screw length measure [40.1374] through the protective guide into the drilled hole until its hook reaches the “exit” plane of the hole. Read the length of the locking screw on the measure. During the measurement the protective guide should rest on the cortex bone.

Remove the screw length measure.

Leave the protective guide in hole of the targeter.

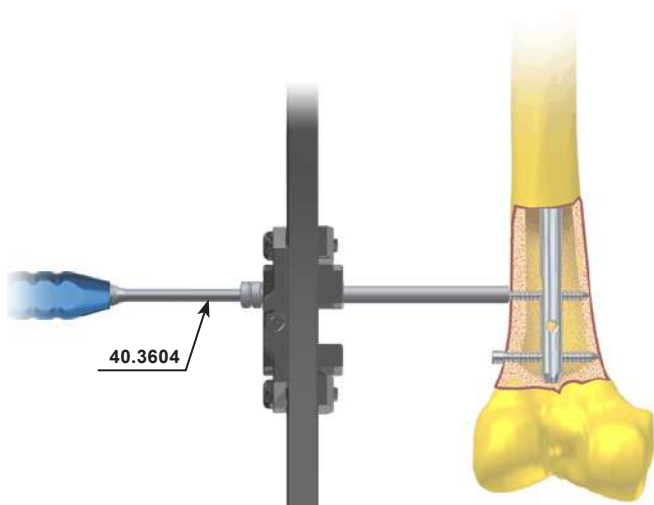

- 32** Insert the tip of the screwdriver S3.5 [40.3604] into the socket of the selected locking screw. Then advance both into the protective guide. Insert the locking screw into prepared hole until the head of the screw reaches the cortex bone (*the groove on the screwdriver shaft matches the edge of the protective guide*).

Remove the screwdriver and protective guide.

IV.2.3. Targeter removal, end cap insertion

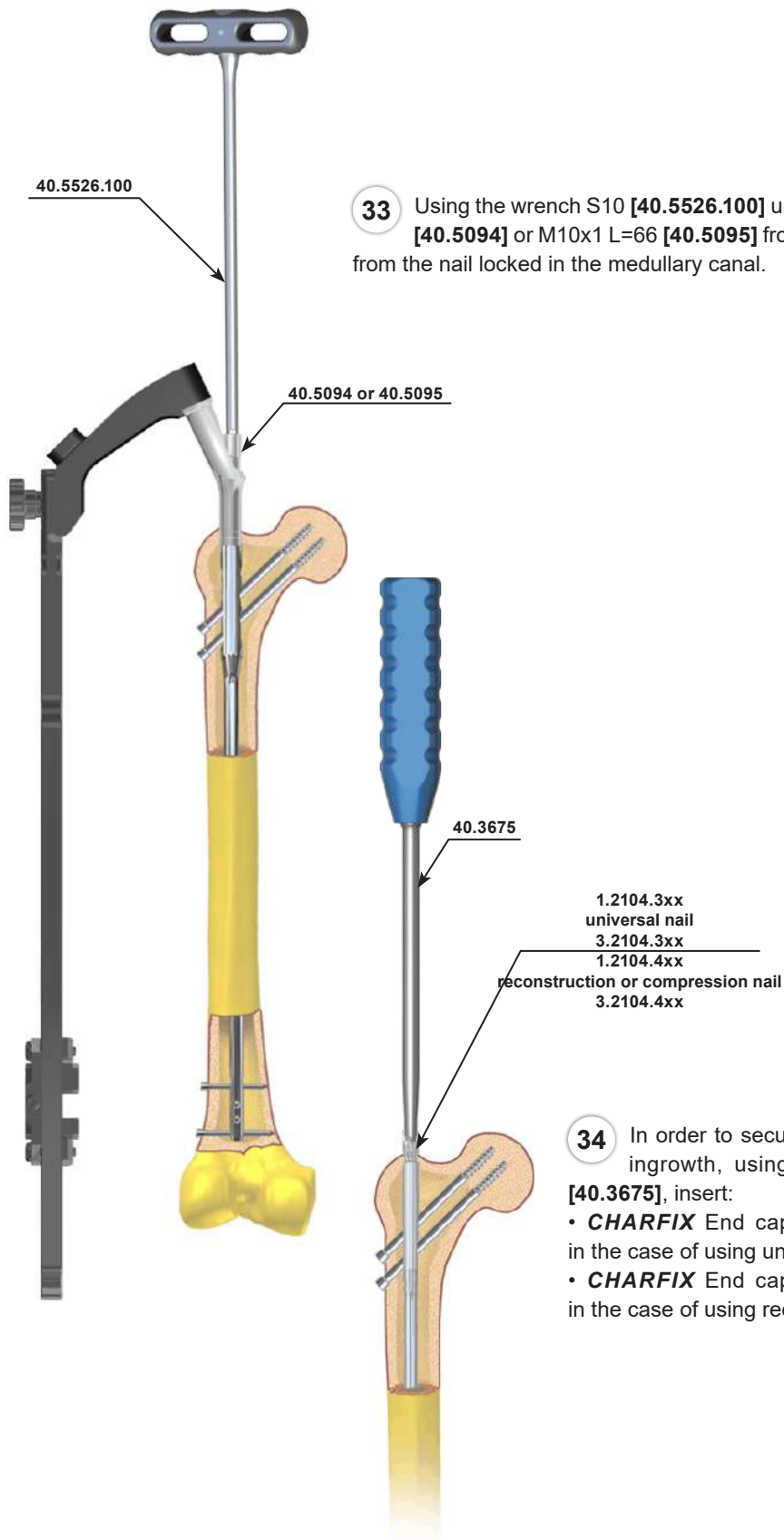

33 Using the wrench S10 [40.5526.100] unscrew the connecting screw M10x1 L=55 [40.5094] or M10x1 L=66 [40.5095] from the nail shaft and dismount the targeter from the nail locked in the medullary canal.

34 In order to secure the inner thread of the nail from bone ingrowth, using the cannulated screwdriver S5.0/2.2 [40.3675], insert:

- **CHARFIX** End cap M10x1 [1.2104.3xx] or [3.2104.3xx] in the case of using universal nail.
- **CHARFIX** End cap M10x1 [1.2104.4xx] or [3.2104.4xx] in the case of using reconstruction or compression nail.

IV.2.4. Distal locking of the nail using “freehand technique”

With this technique, the X-Ray imaging control is used to identify the entry points for the drills and to control the drilling process. It is recommended to use angular attachment with the surgical drive while drilling, so that surgeon's hands are not directly exposed to X-Rays. After marking the entry points on the skin, incisions shall be made in the marked places through the soft tissues, each about 1.5cm in length.

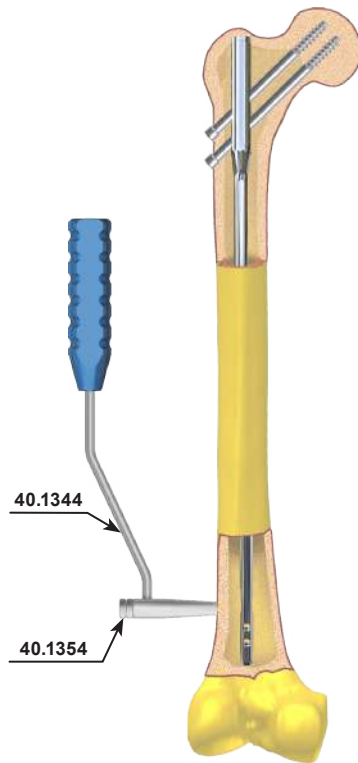

- 35** Using X-Ray imaging, place the targeter D [40.1344] in the line with the nail hole. The centers of the holes in the targeter and nail have to match. The teeth of the targeter D have to be merged in the cortex.

Insert the short trocar 7 [40.1354] into the hole in the targeter, then advance until it reaches cortex and mark the entry point for the drill.

Remove the trocar.
Leave the targeter D in place.

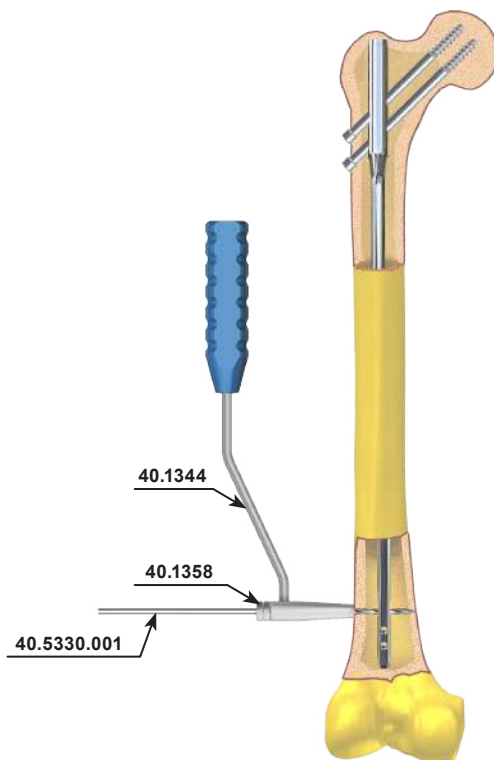

- 36** Insert the drill guide short 7/3.5 [40.1358] into the targeter hole. Mount the drill with scale 3.5/270 [40.5330.001] to the surgical drive and advance it through the drill guide. Drill the hole in the femur through both cortex layers and the nail hole. The scale on the drill shows the length of the locking element.

Remove the drill and drill guide.
Leave the targeter.

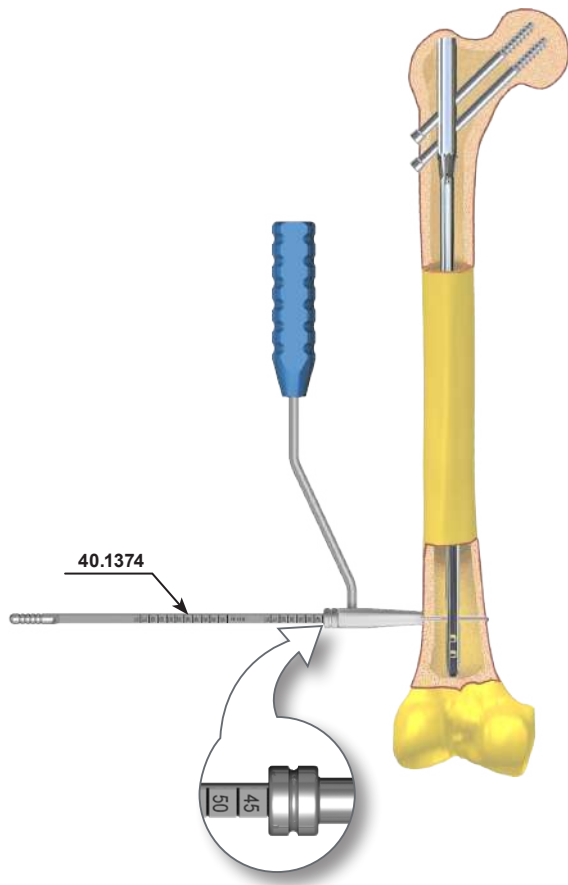

- 37** Insert the screw length measure [40.1374] through the targeter hole into the drilled hole until its hook reaches the "exit" plane of the hole. Read the length of the locking screw on the scale D.

Remove the screw length measure.
Leave the targeter in place.

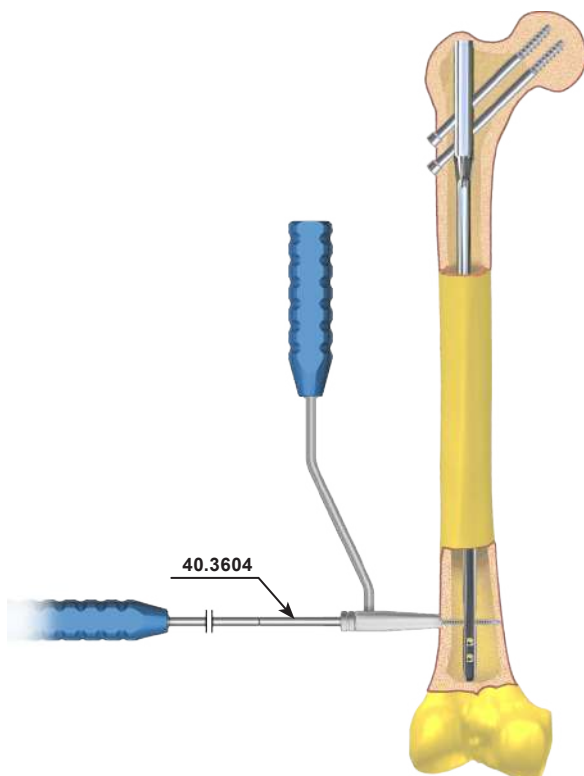

- 38** Insert the tip of the screwdriver S3.5 [40.3604] into the socket of the selected locking screw. Then advance both into hole of the targeter. Insert the locking screw until its head reaches the cortex bone.

Remove the screwdriver S3.5 and the targeter.

IV.3. DYNAMIC AND COMPRESSION METHODS

IV.3.1. Distal locking of the nail

Before performing distal locking of the nail, do the following:

1. Mount the distal targeter D [40.5093] on the targeter arm [40.5091]. If properly installed, the signs RIGHT or LEFT on both targeters should comply.
2. Verify, with the X-Ray imaging, the position of holes in the nail and in the targeter. The centers of the holes in nail and targeter have to be in line.

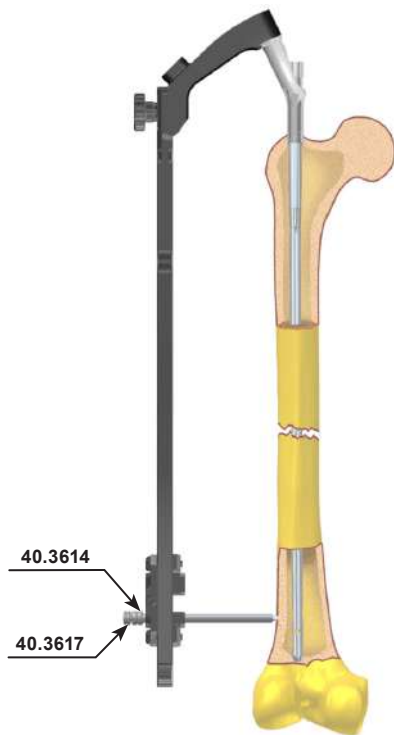

- 39** Insert the protective guide 9/6.5 [40.3614] (with one groove on the handle) with trocar 6.5 [40.3617] into the distal hole in the distal targeter D. Mark the entry point for the locking screw insertion on the skin and make adequate incision through the soft tissues. Advance the trocar until it reaches cortex and mark the drill entry point. Advance the protective guide together with the trocar until it touches the cortex bone.

Remove the trocar.

Leave the protective guide in the hole of the targeter.



NOTE! For the rest of the procedure follow the steps 26-32.

- 40** It is possible to make reduction of fracture after locking the nail in distal part by slightly knocking the nail up and then locking the nail in proximal part.

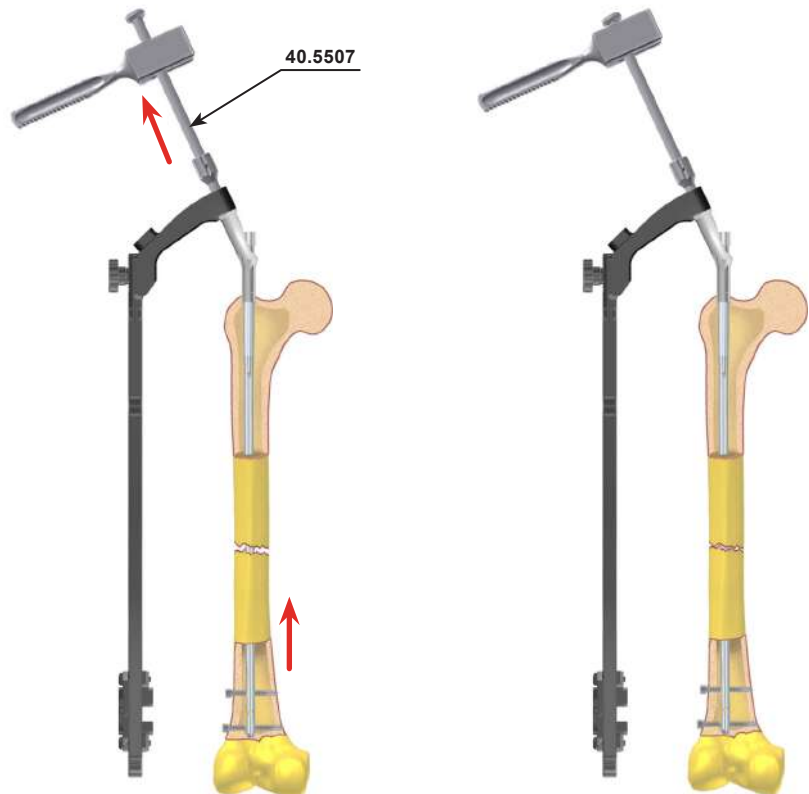

IV.3.2. Proximal locking of the nail



NOTE! In compression and dynamic methods, screw insertion shall be done into the hole of the targeter 135 [40.5092] marked DYNAMIC.

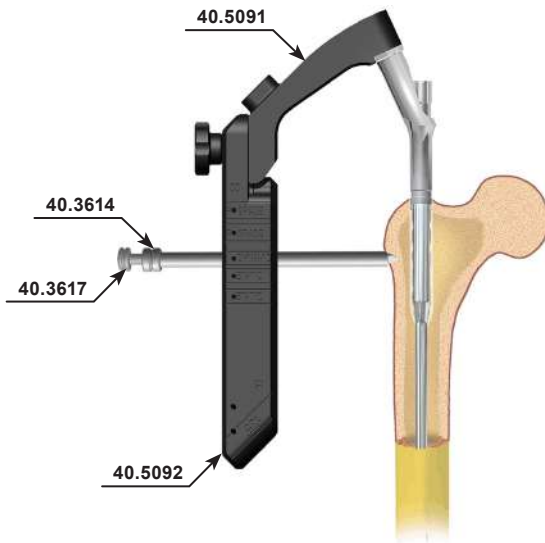

- 41** Mount the targeter 135 [40.5092] on the targeter arm [40.5091]. Insert the protective guide 9/6.5 [40.3614] (with one groove on the handle) with trocar 6.5 [40.3617] into the proximal hole in the targeter 135 [40.5092]. Mark on the skin the entry point for the locking screw and make adequate incision through soft tissues 1.5cm in length. Advance the trocar until it reaches cortex and mark the drill entry point. Advance the protective guide together with trocar until it touches the cortex.

Remove the trocar.
Leave the protective guide in the hole of the targeter.

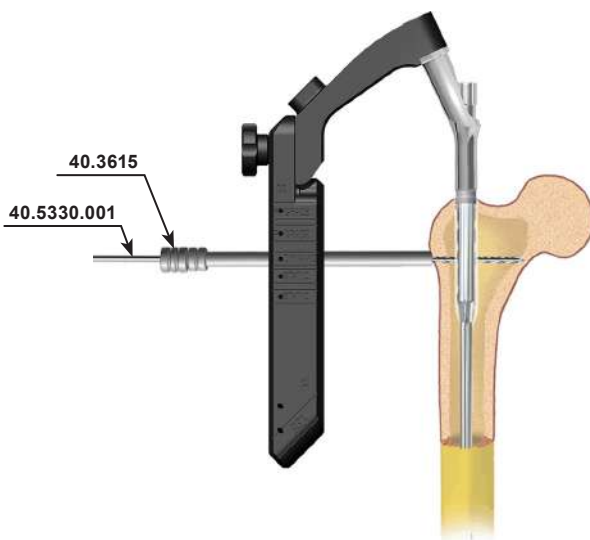

- 42** Insert the drill guide 6.5/3.5 [40.3615] (with two grooves) into the protective guide. Mount the drill with scale 3.5/270 [40.5330.001] to the surgical drive and advance it through the drill guide. Drill the hole in the femur through both cortex layers and the hole in the nail. The scale on the drill shows the length of the locking element.

Remove the drill and drill guide.
Leave the protective guide in the hole of the targeter.

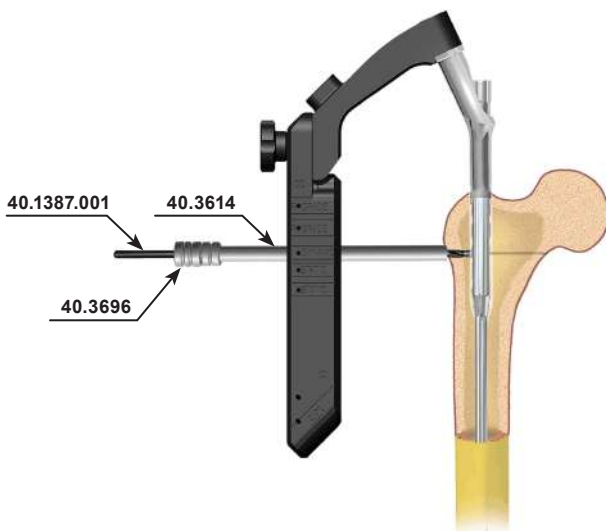

- 43** Insert the drill guide 6.5/4.5 [40.3696] into the protective guide 9/6.5 [40.3614]. Mount the drill 4.5/270 [40.1387.001] to the surgical drive and advance it through the drill guide. Drill the hole in the femur through first cortex only, up to the nail hole.

Remove the drill and drill guide.
Leave the protective guide in the hole of the targeter.

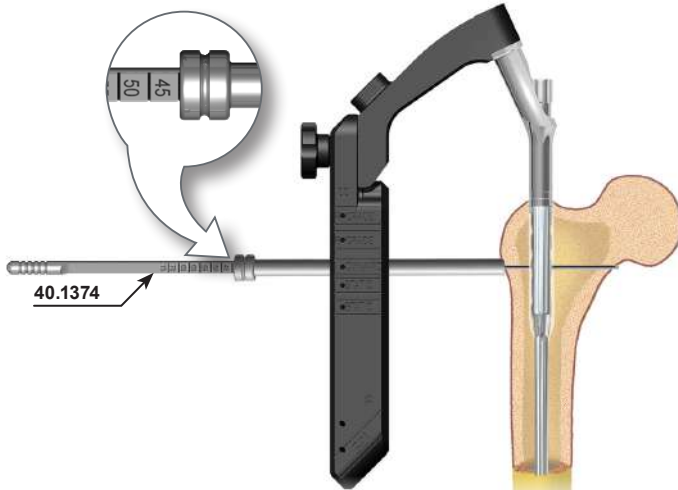

- 44 Insert the screw length measure [40.1374] through the protective guide into the drilled hole until its hook reaches the "exit" plane of the hole. Read the length of the locking screw on the B-D measure scale. During the measurement the end of the protective guide should rest on the cortex.

Remove the screw length measure.
Leave the protective guide in the hole of the targeter.

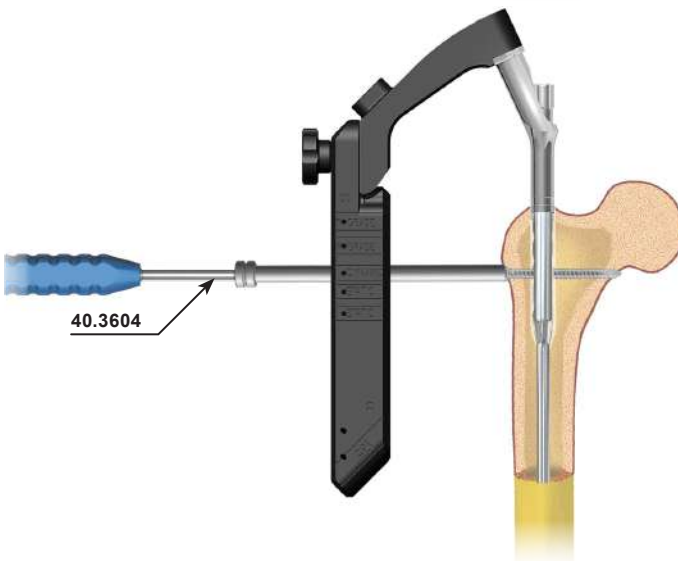

- 45 Insert the tip of the screwdriver S3.5 [40.3604] into the socket of the selected locking screw. Then advance both into the protective guide. Insert the locking screw into the prepared hole until the head of the screw reaches the cortex of the bone (the groove on the screwdriver shaft matches the edge of the protective guide).

Remove the screwdriver and protective guide.

- 45a In order to make the intraoperative compression, using the screwdriver S3.5 [40.3604], insert the compression screw [40.5096] into the connecting screw M10x1 L=55 [40.5094] or connecting screw M10x1 L=66 [40.5095] that connects intramedullary nail to the targeter arm. When front of the screw reaches the shaft of locking screw, the further screw insertion will cause the compression of bone fragments. The above steps should be controlled with X-Ray image intensifier to observe the interfragmental slot.

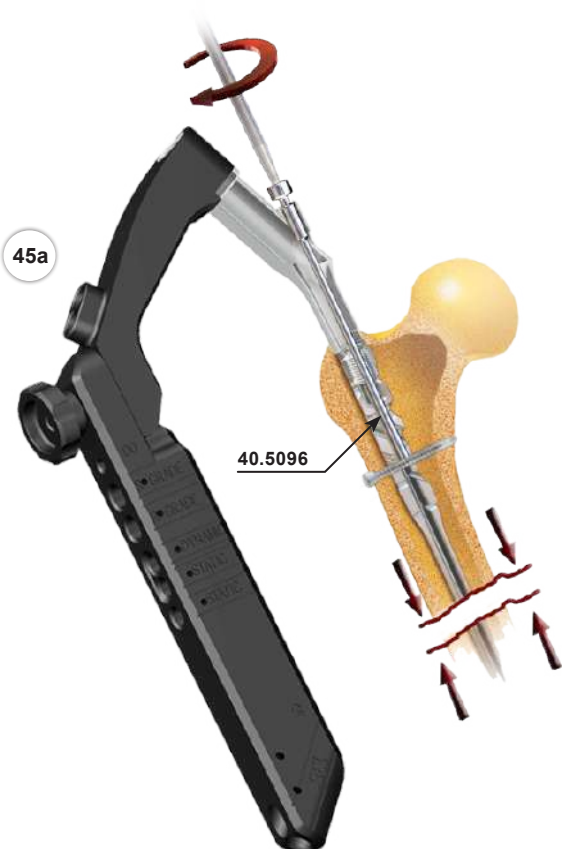
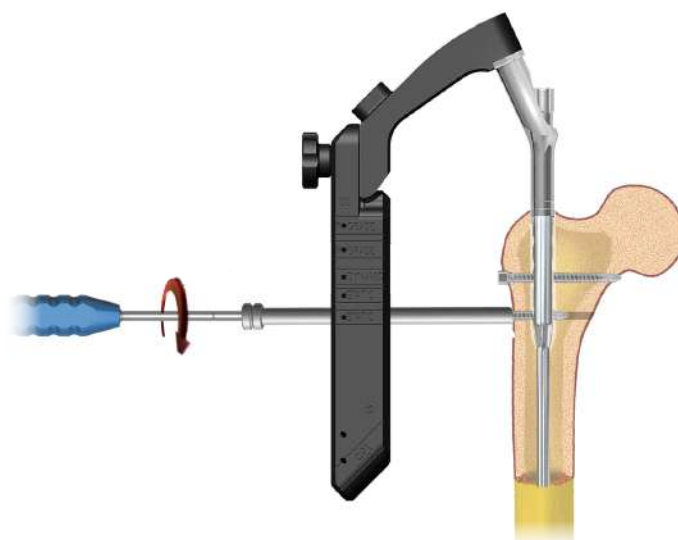

- 45b In order to maintain the bone fragments compression, lock the screw by using hole STATIC placed further from DYNAMIC hole. Repeat steps 41-45.

IV.3.3. Targeter removal

- 46 Using the wrench S10 [40.5526.100], unscrew the connecting screw [40.5094] or [40.5095] from the nail shaft and dismount the targeter from the nail locked in the medullary canal.



IV.3.4. Compression screw insertion

- 47 Using the screwdriver S3.5 [40.3604] insert the compression screw into the threaded hole in the nail shaft. The surgeon decides about the level of compression.

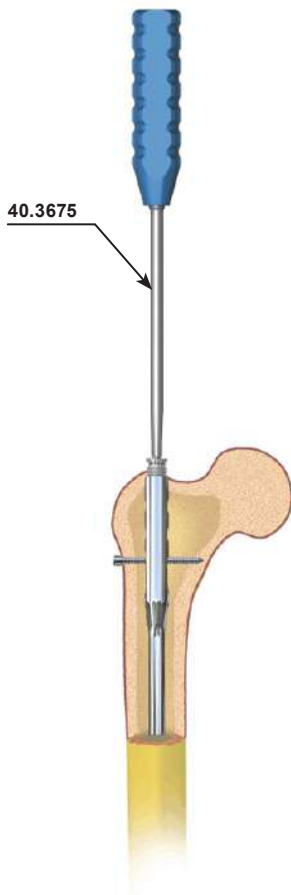
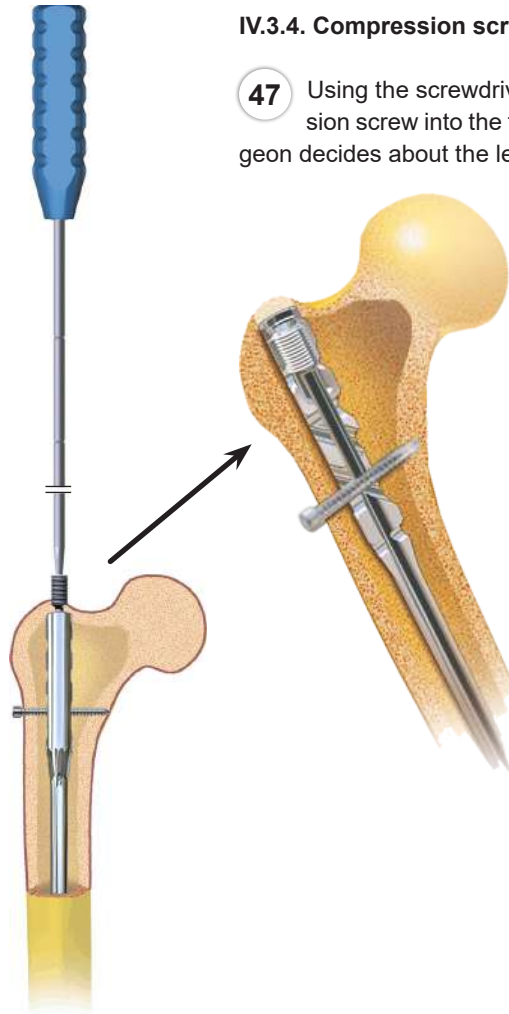

IV.3.5. End cap insertion (dynamic method only)

- 48 In order to secure the inner thread of the nail from bone ingrowth, using the cannulated screwdriver S5.0/2.2 [40.3675] insert:
- **CHARFIX** End cap M10 [1.2104.3xx] or [3.2104.3xx] in the case of using universal nail,
 - **CHARFIX** End cap M10 [1.2104.4xx] or [3.2104.4xx] in the case of using compression nail.

IV.4. STATIC METHOD

IV.4.1. Distal locking of the nail

Before performing distal locking of the nail, do the following:

1. Mount the distal targeter D [40.5093] on the targeter arm [40.5091]. If properly installed, the signs RIGHT or LEFT on both targeters should comply.
2. Verify, with the X-Ray imaging, the position of holes in the nail and in the targeter. The centers of the holes in nail and targeter have to be in line.

49 Insert the protective guide 9/6.5 [40.3614] (with one groove on the handle) with trocar 6.5 [40.3617] into the proximal hole in the distal targeter D. Mark the entry point for the locking screw insertion on the skin and make adequate incision through the soft tissues. Advance the trocar until it reaches cortex and mark the drill entry point. Advance the protective guide together with the trocar until it touches the cortex bone.

Remove the trocar.

Leave the protective guide in the hole of the targeter.



NOTE! For the rest of the procedure follow the steps 26-32.

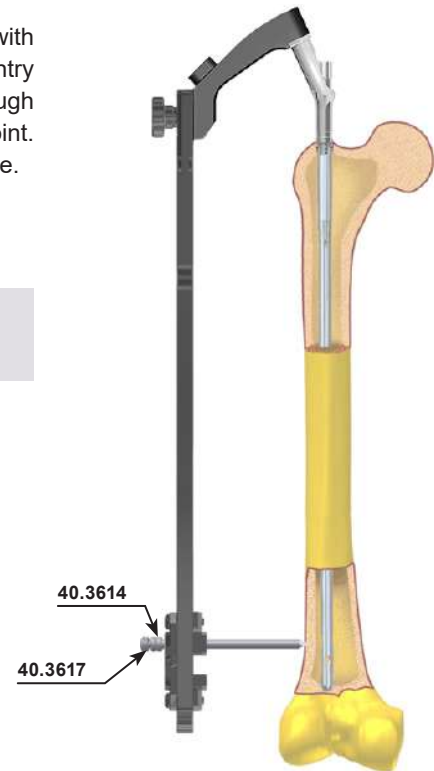

IV.4.2. Proximal locking of the nail



NOTE! In static method of femoral fixation to lock the intramedullary nail, distal hole in targeter 135 [40.5092] marked STATIC shall be used. The second hole (proximal) may be used for locking with second locking screw.

50 Insert the protective guide 9/6.5 [40.3614] (with one groove) with trocar 6.5 [40.3617] into the distal hole in targeter 135.

Mark the entry point for the locking screw on the skin and make adequate 1.5cm long incision through the soft tissues. Advance the trocar until it reaches cortex and mark the entry point for the drill. Advance the protective guide together with trocar until it touches the cortex.

Remove the trocar.

Leave the protective guide in the hole of the targeter.

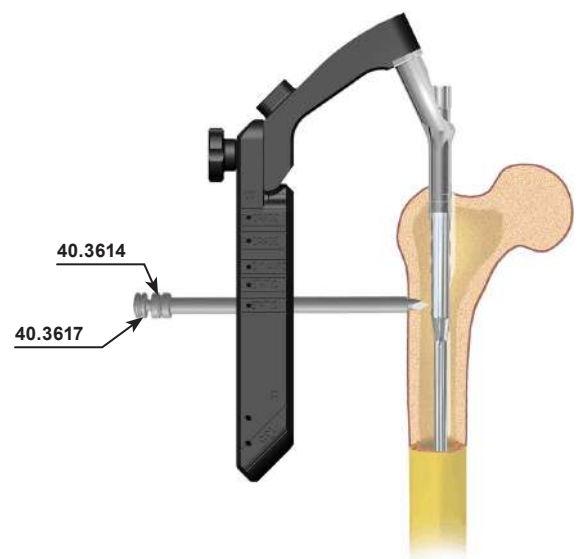

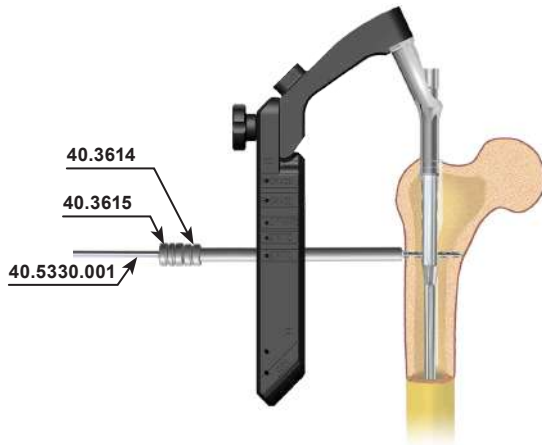

51 Insert the drill guide 6.5/3.5 [40.3615] (with two grooves) into the protective guide 9/6.5 [40.3614]. Mount the drill with scale 3.5/270 [40.5330.001] to the surgical drive and advance it through the drill guide. Drill the hole in the femur through both cortex layers and the hole in the nail. The scale on the drill shows the length of the locking element.

Remove the drill and drill guide.
Leave the protective guide in the hole of the targeter.

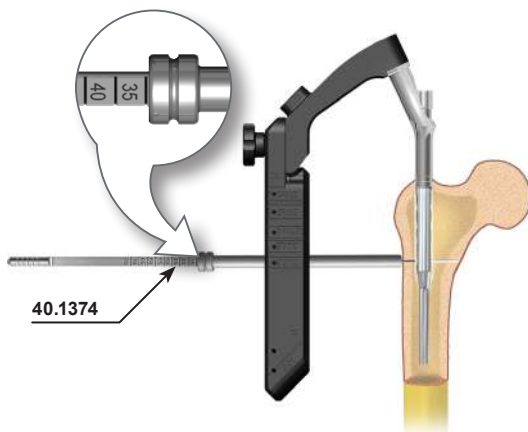

52 Insert the screw length measure [40.1374] through the protective guide into the drilled hole until its hook reaches the “exit” plane of the hole. Read the length of the locking screw on the B-D measure scale. During the measurement the end of the protective guide should rest on the cortex.

Remove the screw length measure.
Leave the protective guide in the hole of the targeter.

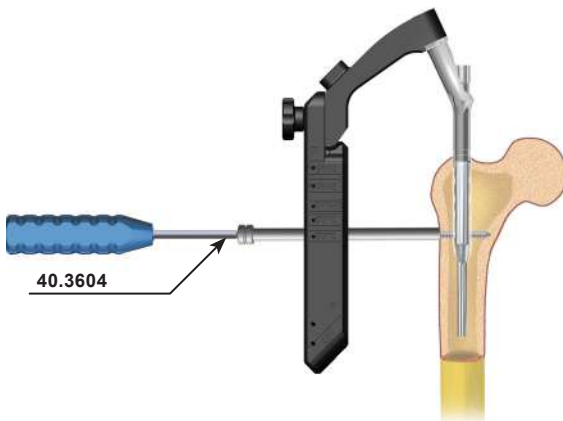

53 Insert the tip of the screwdriver S3.5 [40.3604] into the socket of the selected locking screw. Then advance both into the protective guide. Insert the locking screw into the prepared hole until the head of the screw reaches the cortex of the bone (the groove on the screwdriver shaft matches the edge of the protective guide).

Remove the screwdriver and protective guide.



NOTE! If the surgeon decides to lock the nail in the proximal part with two screws, insertion of the other screw should be performed as shown in steps 50 to 53. Otherwise, omit these steps.

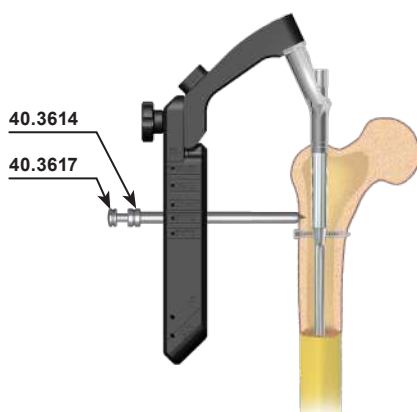

54 Insert the protective guide 9/6.5 [40.3614] (with one groove on the handle) with trocar 6.5 [40.3617] into the proximal hole of targeter 135 [40.5092]. Advance the trocar until it reaches cortex and mark the entry point for the drill. Advance the protective guide together with the trocar until it touches the bone.

Remove the trocar.
Leave the protective guide in the hole of the targeter.

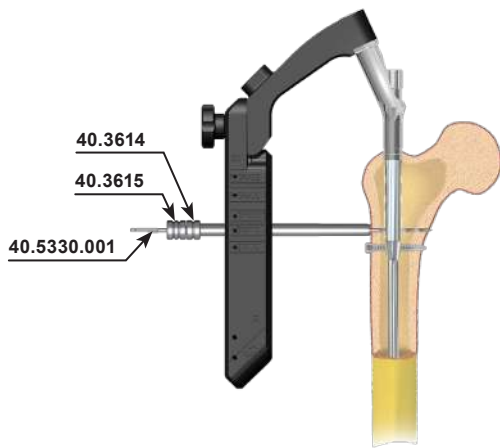

- 55** Insert the drill guide 6.5/3.5 [40.3615] (with two grooves) into the protective guide. Mount the drill with scale 3.5/270 [40.5330.001] to the surgical drive and advance it through the drill guide. Drill the hole in the femur through both cortex layers and the hole in the nail. The scale on the drill shows the length of the locking element.

Remove the drill and drill guide.
Leave the protective guide in the hole of the targeter.

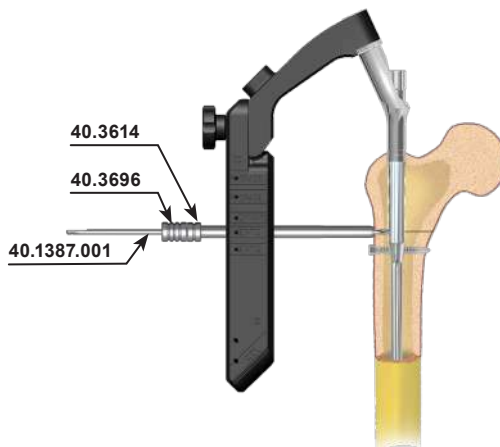

- 56** Insert the drill guide 6.5/4.5 [40.3696] into the protective guide 9/6.5 [40.3614]. Mount the drill 4.5/270 [40.1387.001] to the surgical drive and advance it through the drill guide. Drill the hole in the femur through the first cortex only, up to the nail hole.

Remove the drill and drill guide.
Leave the protective guide in the hole of the targeter.

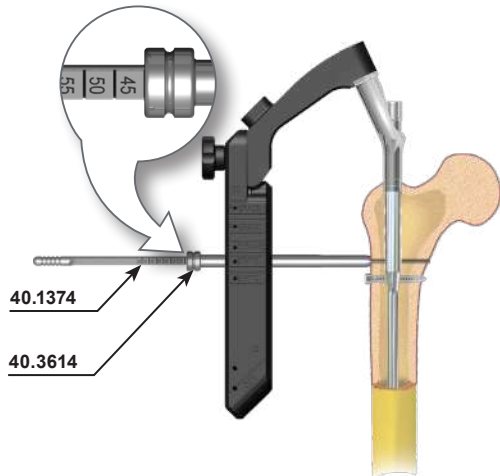

- 57** Insert the screw length measure [40.1374] through the protective guide into the drilled hole until its hook reaches the "exit" plane of the hole. Read the length of the locking screw on the B-D measure scale. During the measurement the end of the protective guide should rest on the cortex.

Remove the screw length measure.
Leave the protective guide in the hole of the targeter.

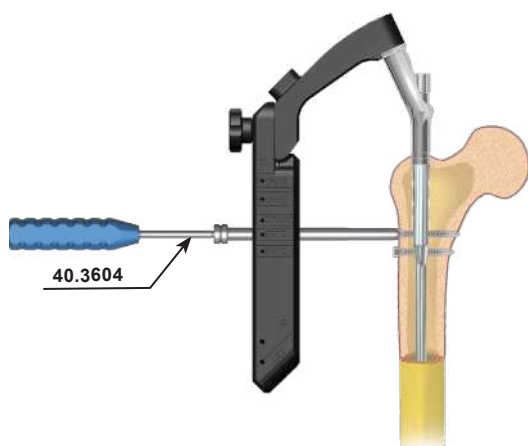

- 58** Insert the tip of the screwdriver S3.5 [40.3604] into the socket of the selected locking screw. Then advance both into the protective guide. Insert the locking screw into the prepared hole until the head of the screw reaches the cortex of the bone (the groove on the screwdriver shaft matches the edge of the protective guide).

Remove the screwdriver and protective guide.

IV.4.3. Targeter removal, end cap insertion

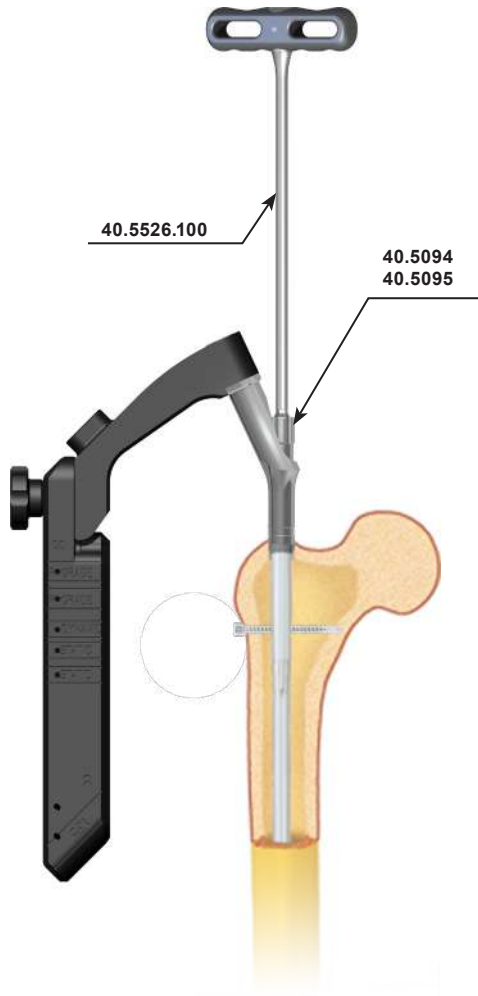

59 Using the wrench S10 [40.5526.100] unscrew the connecting screw [40.5094] or [40.5095] from the nail shaft and dismount the targeter from the nail locked in the medullary canal.

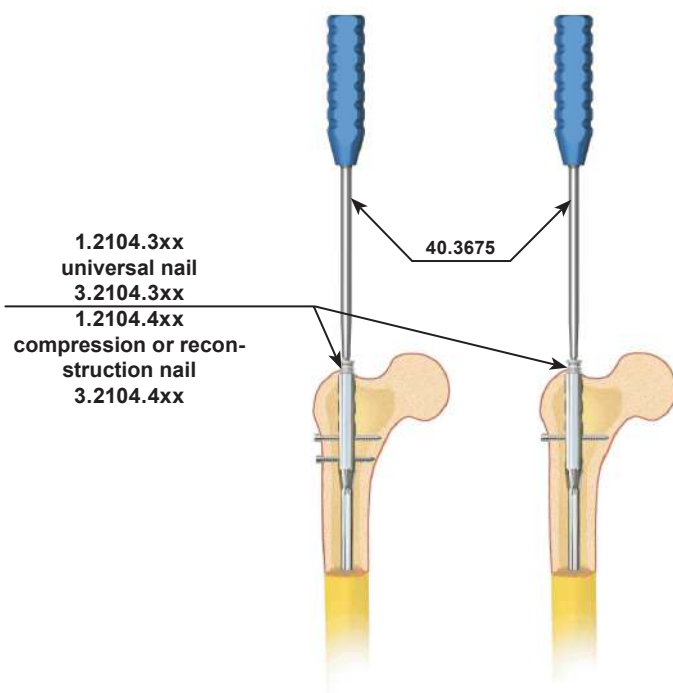

60 In order to secure the inner thread of the nail from bone ingrowth, using the cannulated screwdriver S5.0/2.2 [40.3675] insert:

- **CHARFIX** End cap M10X1 [1.2104.3xx] or [3.2104.3xx] in case of using the universal nail;
- **CHARFIX** End cap M10X1 [1.2104.4xx] or [3.2104.4xx] in case of using the compression or reconstruction nail.

IV.5. STATIC METHOD WITH USE OF RECONSTRUCTION NAIL

IV.5.1. Proximal locking of the nail

In the static method, the intramedullary reconstruction nails for fixation of femoral fragments may be used:

- right nail (*market RIGHT*) should be used for fixation of the left femur,
- left nail (*market LEFT*) should be used for fixation of the right femur.

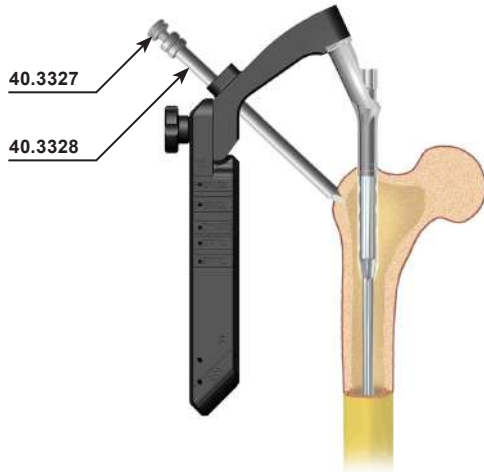

- 61** Insert the protective guide 11/9 [40.3328] (*with one groove on the handle*) with trocar 9 [40.3327] into the hole in the targeter arm [40.5091]. Mark the entry point for the locking screw and make an adequate incision of the soft tissues. Advance the trocar until it reaches the cortex bone and mark the entry point for the drill. Advance the protective guide together with the trocar until it touches the bone.

Remove the trocar.

Leave the protective guide in the hole of the targeter.

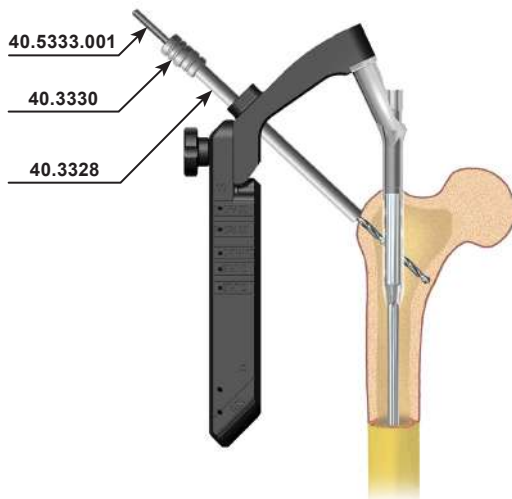

- 62** Insert the drill guide 9/4.5 [40.3330] (*with two grooves*) into the protective guide. Mount the drill with scale 4.5/370 [40.5333.001] to the surgical drive and advance it through the drill guide. Drill the hole in the femur through both cortex layers and the hole in the nail. The scale on the drill shows the length of the locking element.

Remove the drill and the drill guide.

Leave the protective guide in the hole of the targeter.

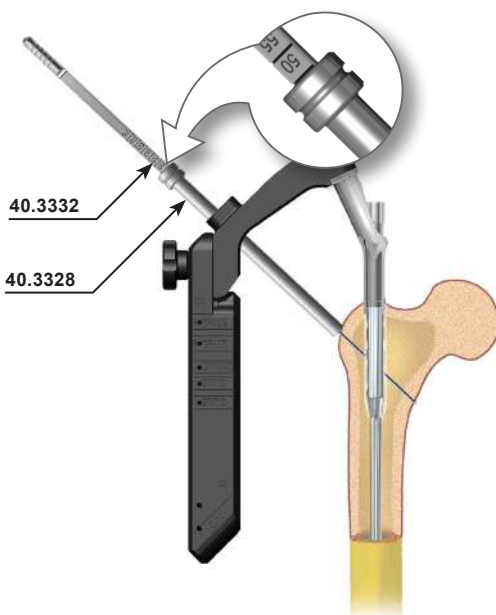

- 63** Insert the reconstruction screw length measure [40.3332] through the protective guide into the drilled hole until its hook reaches the "exit" plane of the hole. Read the length of the reconstruction screw on the measure. During the measurement the end of the protective guide should rest on the cortex bone.

Remove the reconstruction screw length measure.

Leave the protective guide in the hole of the targeter.

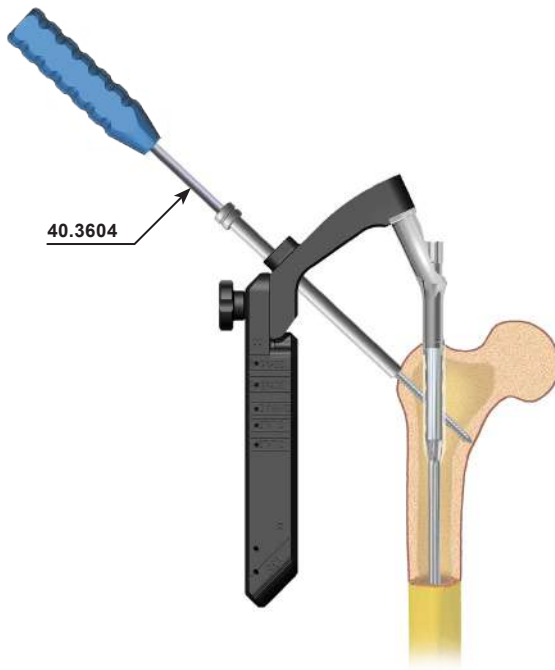

- 64** Insert the tip of the screwdriver S3.5 [40.3604] into the hexagonal socket of the selected locking screw. For the nail locking use the screw with 6.5mm diameter and length determined in previous step. Then advance both into the protective guide. Insert the reconstruction screw into the prepared hole until the head of the screw reaches the cortex of the bone (*the groove on the screwdriver shaft matches the edge of protective guide*).

Remove the screwdriver S3.5 and protective guide.

IV.5.2. Distal locking of the nail

Before performing distal locking of the nail, do the following:

1. Mount the distal targeter D [40.5093] on the targeter arm [40.5091]. If properly installed, the signs RIGHT or LEFT on both targeters should comply.
2. Verify, with the X-Ray imaging, the position of holes in the nail and in the targeter. The centers of the holes in nail and targeter have to be in line.

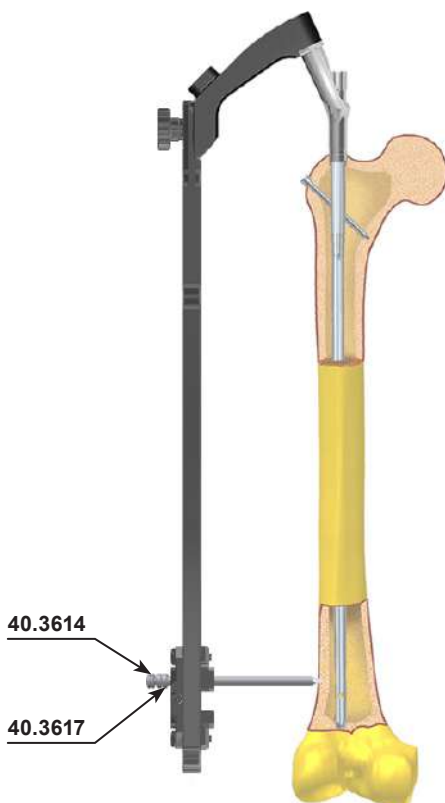

- 65** Insert the protective guide 9/6.5 [40.3614] (with one groove on the handle) with trocar 6.5 [40.3617] into the proximal hole in the distal targeter D. Mark the entry point for the locking screw insertion on the skin and make adequate incision through the soft tissues. Advance the trocar until it reaches cortex and mark the drill entry point. Advance the protective guide together with the trocar until it touches the cortex bone.

Remove the trocar.

Leave the protective guide in the hole of the targeter.



NOTE! For the rest of the procedure follow the steps 26-32.

IV.5.3. Targeter removal, end cap insertion

66 Using the wrench S10 [40.5526.100] unscrew the connecting screw [40.5094] or [40.5095] from the nail shaft and dismount the targeter from the nail locked in the medullary canal.

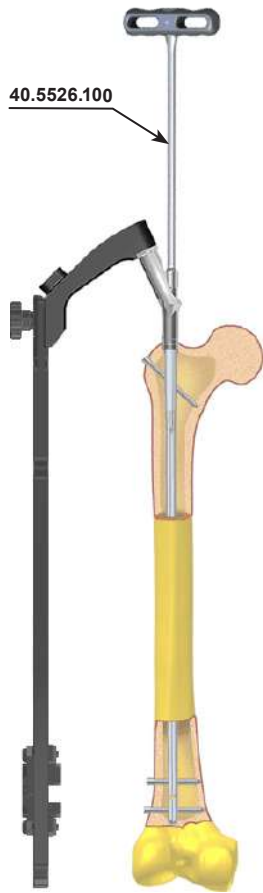

67 In order to secure the inner thread of the nail from bone ingrowth, using the cannulated screwdriver S5.0/2.2 [40.3675] insert:

- CHARFIX End cap M10X1 [1.2104.3xx] or [3.2104.3xx] in case of using the universal nail;
- CHARFIX End cap M10X1 [1.2104.4xx] or [3.2104.4xx] in case of using the compression or reconstruction nail.

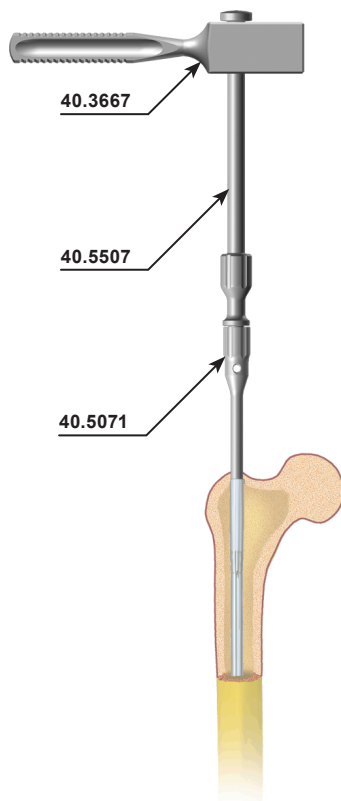
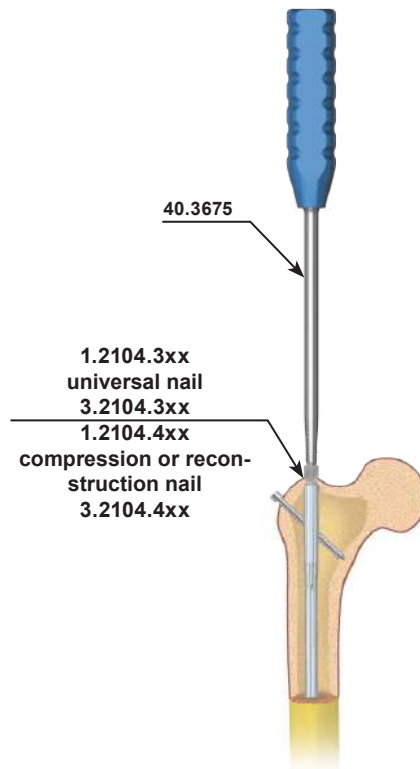

IV.6. NAIL EXTRACTION

68 Use the cannulated screwdriver S5.0/2.2 [40.3675] to remove the CHARFIX End cap M10x1 [1 (3).2104.3xx]; [1 (3).2104.4xx] or screwdriver S3.5 [40.4604] to remove the compression screw from the nail shaft. Insert the connector M10x1/M12 [40.5071] into the threaded hole of the nail. Then, using screwdriver S3.5 [40.3604] unscrew all the locking screws. Attach the impactor-extractor [40.5507] to the connector and with help of the mallet [40.3667], remove the nail from the medullary canal.

IV.7. SURGICAL TECHNIQUE - RETROGRADE METHOD (CONDYLAR APPROACH)

IV.7.1. Implants for retrograde method

available			
Ø [mm]	8+15	8+10	11+15
L [mm]	160+600	160+600	160+600



Steel
1.1654.030-090
Titanium
3.1654.030-090

Steel
1.1654.030-090
Titanium
3.1654.030-090

Steel
1.2109.050-090
Titanium
3.2109.050-090

Steel
1.1651.040-110
Titanium
3.1651.040-110

Steel
1.2104.002
Titanium
3.2104.002

L [mm]	Ø	Steel				Titanium				L [mm]	Ø	Steel		Titanium	
		left		right		left		right				left		right	
		left	right	left	right	left	right	left	right			left	right		
200	9	1.2855.200	1.2854.200	3.2855.200	3.2854.200	12	1.2861.200	1.2860.200	3.2861.200	3.2860.200					
220		1.2855.220	1.2854.220	3.2855.220	3.2854.220		1.2861.220	1.2860.220	3.2861.220	3.2860.220					
240		1.2855.240	1.2854.240	3.2855.240	3.2854.240		1.2861.240	1.2860.240	3.2861.240	3.2860.240					
260		1.2855.260	1.2854.260	3.2855.260	3.2854.260		1.2861.260	1.2860.260	3.2861.260	3.2860.260					
280		1.2855.280	1.2854.280	3.2855.280	3.2854.280		1.2861.280	1.2860.280	3.2861.280	3.2860.280					
300		1.2855.300	1.2854.300	3.2855.300	3.2854.300		1.2861.300	1.2860.300	3.2861.300	3.2860.300					
320		1.2855.320	1.2854.320	3.2855.320	3.2854.320		1.2861.320	1.2860.320	3.2861.320	3.2860.320					
340		1.2855.340	1.2854.340	3.2855.340	3.2854.340		1.2861.340	1.2860.340	3.2861.340	3.2860.340					
360		1.2855.360	1.2854.360	3.2855.360	3.2854.360		1.2861.360	1.2860.360	3.2861.360	3.2860.360					
380		1.2855.380	1.2854.380	3.2855.380	3.2854.380		1.2861.380	1.2860.380	3.2861.380	3.2860.380					
400		1.2855.400	1.2854.400	3.2855.400	3.2854.400		1.2861.400	1.2860.400	3.2861.400	3.2860.400					
420		1.2855.420	1.2854.420	3.2855.420	3.2854.420		1.2861.420	1.2860.420	3.2861.420	3.2860.420					
440		1.2855.440	1.2854.440	3.2855.440	3.2854.440		1.2861.440	1.2860.440	3.2861.440	3.2860.440					
460		1.2855.460	1.2854.460	3.2855.460	3.2854.460		1.2861.460	1.2860.460	3.2861.460	3.2860.460					
480		1.2855.480	1.2854.480	3.2855.480	3.2854.480		1.2861.480	1.2860.480	3.2861.480	3.2860.480					
200		10	1.2857.200	1.2856.200	3.2857.200		3.2856.200	13	1.2863.200	1.2862.200	3.2863.200	3.2862.200			
220			1.2857.220	1.2856.220	3.2857.220		3.2856.220		1.2863.220	1.2862.220	3.2863.220	3.2862.220			
240			1.2857.240	1.2856.240	3.2857.240		3.2856.240		1.2863.240	1.2862.240	3.2863.240	3.2862.240			
260	1.2857.260		1.2856.260	3.2857.260	3.2856.260	1.2863.260	1.2862.260		3.2863.260	3.2862.260					
280	1.2857.280		1.2856.280	3.2857.280	3.2856.280	1.2863.280	1.2862.280		3.2863.280	3.2862.280					
300	1.2857.300		1.2856.300	3.2857.300	3.2856.300	1.2863.300	1.2862.300		3.2863.300	3.2862.300					
320	1.2857.320		1.2856.320	3.2857.320	3.2856.320	1.2863.320	1.2862.320		3.2863.320	3.2862.320					
340	1.2857.340		1.2856.340	3.2857.340	3.2856.340	1.2863.340	1.2862.340		3.2863.340	3.2862.340					
360	1.2857.360		1.2856.360	3.2857.360	3.2856.360	1.2863.360	1.2862.360		3.2863.360	3.2862.360					
380	1.2857.380		1.2856.380	3.2857.380	3.2856.380	1.2863.380	1.2862.380		3.2863.380	3.2862.380					
400	1.2857.400		1.2856.400	3.2857.400	3.2856.400	1.2863.400	1.2862.400		3.2863.400	3.2862.400					
420	1.2857.420		1.2856.420	3.2857.420	3.2856.420	1.2863.420	1.2862.420		3.2863.420	3.2862.420					
440	1.2857.440		1.2856.440	3.2857.440	3.2856.440	1.2863.440	1.2862.440		3.2863.440	3.2862.440					
460	1.2857.460		1.2856.460	3.2857.460	3.2856.460	1.2863.460	1.2862.460		3.2863.460	3.2862.460					
480	1.2857.480		1.2856.480	3.2857.480	3.2856.480	1.2863.480	1.2862.480		3.2863.480	3.2862.480					
200	11		1.2859.200	1.2858.200	3.2859.200	3.2858.200	14		1.2865.200	1.2864.200	3.2865.200	3.2864.200			
220			1.2859.220	1.2858.220	3.2859.220	3.2858.220			1.2865.220	1.2864.220	3.2865.220	3.2864.220			
240			1.2859.240	1.2858.240	3.2859.240	3.2858.240			1.2865.240	1.2864.240	3.2865.240	3.2864.240			
260		1.2859.260	1.2858.260	3.2859.260	3.2858.260	1.2865.260		1.2864.260	3.2865.260	3.2864.260					
280		1.2859.280	1.2858.280	3.2859.280	3.2858.280	1.2865.280		1.2864.280	3.2865.280	3.2864.280					
300		1.2859.300	1.2858.300	3.2859.300	3.2858.300	1.2865.300		1.2864.300	3.2865.300	3.2864.300					
320		1.2859.320	1.2858.320	3.2859.320	3.2858.320	1.2865.320		1.2864.320	3.2865.320	3.2864.320					
340		1.2859.340	1.2858.340	3.2859.340	3.2858.340	1.2865.340		1.2864.340	3.2865.340	3.2864.340					
360		1.2859.360	1.2858.360	3.2859.360	3.2858.360	1.2865.360		1.2864.360	3.2865.360	3.2864.360					
380		1.2859.380	1.2858.380	3.2859.380	3.2858.380	1.2865.380		1.2864.380	3.2865.380	3.2864.380					
400		1.2859.400	1.2858.400	3.2859.400	3.2858.400	1.2865.400		1.2864.400	3.2865.400	3.2864.400					
420		1.2859.420	1.2858.420	3.2859.420	3.2858.420	1.2865.420		1.2864.420	3.2865.420	3.2864.420					
440		1.2859.440	1.2858.440	3.2859.440	3.2858.440	1.2865.440		1.2864.440	3.2865.440	3.2864.440					
460		1.2859.460	1.2858.460	3.2859.460	3.2858.460	1.2865.460		1.2864.460	3.2865.460	3.2864.460					
480		1.2859.480	1.2858.480	3.2859.480	3.2858.480	1.2865.480		1.2864.480	3.2865.480	3.2864.480					

L [mm]	Ø	Steel				Titanium				L [mm]	Ø	Steel		Titanium	
		left		right		left		right				left		right	
		left	right	left	right	left	right	left	right			left	right		
200	8	1.2877.200	1.2876.200	3.2877.200	3.2876.200	11	1.2883.200	1.2882.200	3.2883.200	3.2882.200					
220		1.2877.220	1.2876.220	3.2877.220	3.2876.220		1.2883.220	1.2882.220	3.2883.220	3.2882.220					
240		1.2877.240	1.2876.240	3.2877.240	3.2876.240		1.2883.240	1.2882.240	3.2883.240	3.2882.240					
260		1.2877.260	1.2876.260	3.2877.260	3.2876.260		1.2883.260	1.2882.260	3.2883.260	3.2882.260					
280		1.2877.280	1.2876.280	3.2877.280	3.2876.280		1.2883.280	1.2882.280	3.2883.280	3.2882.280					
300		1.2877.300	1.2876.300	3.2877.300	3.2876.300		1.2883.300	1.2882.300	3.2883.300	3.2882.300					
320		1.2877.320	1.2876.320	3.2877.320	3.2876.320		1.2883.320	1.2882.320	3.2883.320	3.2882.320					
340		1.2877.340	1.2876.340	3.2877.340	3.2876.340		1.2883.340	1.2882.340	3.2883.340	3.2882.340					
360		1.2877.360	1.2876.360	3.2877.360	3.2876.360		1.2883.360	1.2882.360	3.2883.360	3.2882.360					
380		1.2877.380	1.2876.380	3.2877.380	3.2876.380		1.2883.380	1.2882.380	3.2883.380	3.2882.380					
400		1.2877.400	1.2876.400	3.2877.400	3.2876.400		1.2883.400	1.2882.400	3.2883.400	3.2882.400					
420		1.2877.420	1.2876.420	3.2877.420	3.2876.420		1.2883.420	1.2882.420	3.2883.420	3.2882.420					
440		1.2877.440	1.2876.440	3.2877.440	3.2876.440		1.2883.440	1.2882.440	3.2883.440	3.2882.440					
460		1.2877.460	1.2876.460	3.2877.460	3.2876.460		1.2883.460	1.2882.460	3.2883.460	3.2882.460					
480		1.2877.480	1.2876.480	3.2877.480	3.2876.480		1.2883.480	1.2882.480	3.2883.480	3.2882.480					
200		9	1.2879.200	1.2878.200	3.2879.200		3.2878.200	12	1.2885.200	1.2884.200	3.2885.200	3.2884.200			
220			1.2879.220	1.2878.220	3.2879.220		3.2878.220		1.2885.220	1.2884.220	3.2885.220	3.2884.220			
240			1.2879.240	1.2878.240	3.2879.240		3.2878.240		1.2885.240	1.2884.240	3.2885.240	3.2884.240			
260	1.2879.260		1.2878.260	3.2879.260	3.2878.260	1.2885.260	1.2884.260		3.2885.260	3.2884.260					
280	1.2879.280		1.2878.280	3.2879.280	3.2878.280	1.2885.280	1.2884.280		3.2885.280	3.2884.280					
300	1.2879.300		1.2878.300	3.2879.300	3.2878.300	1.2885.300	1.2884.300		3.2885.300	3.2884.300					
320	1.2879.320		1.2878.320	3.2879.320	3.2878.320	1.2885.320	1.2884.320		3.2885.320	3.2884.320					
340	1.2879.340		1.2878.340	3.2879.340	3.2878.340	1.2885.340	1.2884.340		3.2885.340	3.2884.340					
360	1.2879.360		1.2878.360	3.2879.360	3.2878.360	1.2885.360	1.2884.360		3.2885.360	3.2884.360					
380	1.2879.380		1.2878.380	3.2879.380	3.2878.380	1.2885.380	1.2884.380		3.2885.380	3.2884.380					
400	1.2879.400		1.2878.400	3.2879.400	3.2878.400	1.2885.400	1.2884.400		3.2885.400	3.2884.400					
420	1.2879.420		1.2878.420	3.2879.420	3.2878.420	1.2885.420	1.2884.420		3.2885.420	3.2884.420					
440	1.2879.440		1.2878.440	3.2879.440	3.2878.440	1.2885.440	1.2884.440		3.2885.440	3.2884.440					
460	1.2879.460		1.2878.460	3.2879.460	3.2878.460	1.2885.460	1.2884.460		3.2885.460	3.2884.460					
480	1.2879.480		1.2878.480	3.2879.480	3.2878.480	1.2885.480	1.2884.480		3.2885.480	3.2884.480					
200	10		1.2881.200	1.2880.200	3.2881.200	3.2880.200	13		1.2887.200	1.2886.200	3.2887.200	3.2886.200			
220			1.2881.220	1.2880.220	3.2881.220	3.2880.220			1.2887.220	1.2886.220	3.2887.220	3.2886.220			
240			1.2881.240	1.2880.240	3.2881.240	3.2880.240			1.2887.240	1.2886.240	3.2887.240	3.2886.240			
260		1.2881.260	1.2880.260	3.2881.260	3.2880.260	1.2887.260		1.2886.260	3.2887.260	3.2886.260					
280		1.2881.280	1.2880.280	3.2881.280	3.2880.280	1.2887.280		1.2886.280	3.2887.280	3.2886.280					
300		1.2881.300	1.2880.300	3.2881.300	3.2880.300	1.2887.300		1.2886.300	3.2887.300	3.2886.300					

IV.7.2. Introduction

Retrograde nailing of the femur provides fixation option in the cases of fractures above the knee joint (*up to 20cm from distal end of femur*) or multi-fragment fractures of condyle. The reverse nail may also be used when a hip prosthesis or other implant has been already implanted in the proximal femur.

CHARFIX system provides the retrograde nails with diameters 10, 11 or 12mm and length between 160 and 440mm.

To lock the nail distally (*by the knee joint*) depending on the fracture type use:

- two locking screws 6.5mm,
- two locking sets.

There are five sizes of locking sets:

- 50, with range between 50 and 65 mm,
- 60, with range between 60 and 75 mm,
- 70, with range between 70 and 85 mm,
- 80, with range between 80 and 95 mm,
- 90, with range between 90 and 105 mm.

Locking set consists of: bolt, two washers and locking screw. Locking screws are used to lock the nail proximally. The nail features anatomical shape of the femur - its distal end is angled at 5°.

Each surgical procedure has to be carefully planned. Before the operation, adequate X-Ray images have to be taken in order to examine the type of fracture and assess the dimensions of the implant (*diameter and length*) to be used. The operation should be performed on the patient in supine position, with tourniquet on and the knee joint bent at 90°.

Nailing may be performed with or without reaming the medullary canal. In both cases the diameter of medullary canal ought to be bigger than the diameter of the used nail; if the canal is reamed, its final diameter should be 1.5 to 2mm wider than the diameter of the nail. In both cases the canal has to be additionally reamed in distal part (*entry point*) with a 13mm reamer at the depth of 8cm.



The following paragraphs describe most important steps during implantation of intramedullary interlocking femoral nails; nevertheless, it is not a detailed instructions for use. The surgeon decides about choosing the surgical technique and its application in each individual case.

On the basis of X-Ray image of fractured femur and of the healthy one, the surgeon decides about the length and diameter of the nail.

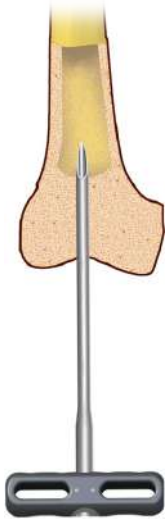

- 1 Make the incision over the middle of patellar ligament or more paracentrally. Expose intercondylar region (*split the fibers of ligament or move it laterally*). Use the curved Awl 8.0 [40.5523] to open the medullary canal to the depth of about 6cm.



Control the procedure with the X-Ray imaging.

- 2 After opening the medullary canal, insert the guide rod 3.0/580 [40.3925.580] with attached guide rod handle [40.1351] until adequate depth is reached.

Remove guide rod handle [40.1351].
Remove curved awl 8.0 [40.5523].

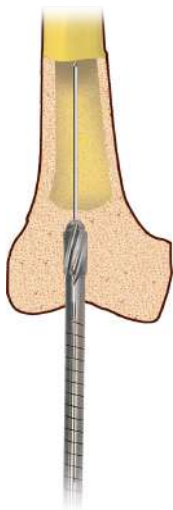
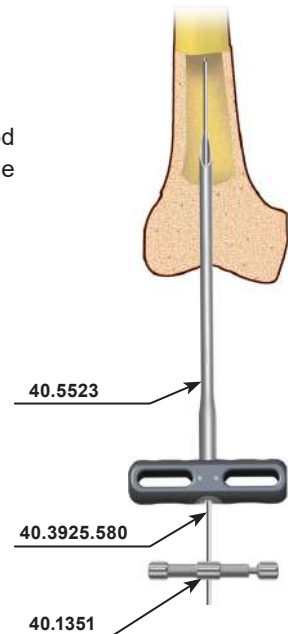

- 3 In case medullary canal is reamed, gradually increase the diameter of the reamer with steps of 0.5 mm, until the diameter of 1.5 to 2.0mm wider than the diameter of the femoral nail is reached, for the depth at least equal to the nail length (*but not lesser*). In both cases, when the medullary canal was reamed or not, the canal should be distally reamed using 13mm reamer to the depth of approx. 8cm.

Remove the flexible reamer.



NOTE! Steps 4 and 5 are applicable only if the medullary canal has been reamed or if another, not provided in the instrument set, reamer guide has been used. Otherwise, go directly to the step 6. If the medullary canal is not reamed, the distal canal in step 3 should be reamed up to the diameter of 13mm to a depth of about 8 cm and proceed directly to step 6, skipping steps 4 and 5.

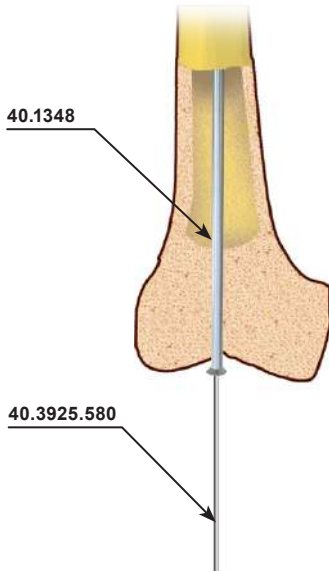

- 4** Insert the teflon pipe guide [40.1348] onto the flexible reamer guide located in the medullary canal.

Remove the reamer guide.

- 5** Mount the guide rod handle [40.1351] on the guide rod 3.0/580 [40.3925.580] and advance the rod into the teflon pipe guide until its tip reaches the proximal epiphysis of the femur. Remove the guide rod handle [40.1351] from the guide rod. Remove the teflon pipe guide [40.1348].

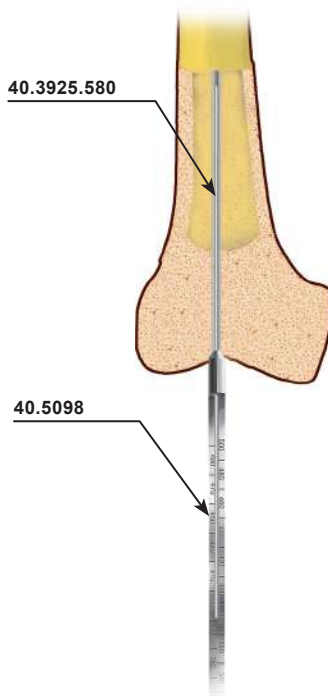
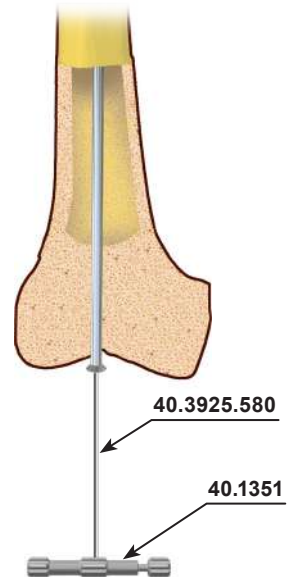

- 6** Insert the nail length measure [40.5098] on the guide rod until it rests on bone. Read the length of the nail on the nail length measure. Remove the measure from the guide rod. In case of using solid nail, remove the guide rod from medullary canal. Medullary canal is ready for nail insertion.

IV.7.3. Nail assembling to the targeter, nail insertion into the medullary canal



- 7 Mount the distal targeter D [40.5093] on the targeter arm [40.5091].



NOTE! When operating right limb, the targeters should be connected in such a way that the RIGHT signs on both targeters are in line. In the case of left limb - the LEFT signs on both targeters shall be in line.

Use the wrench S10 [40.5526.100] to mount the intramedullary nail on the targeter arm with the connecting screw M10x1 L=55 [40.5094]. Use a pair of set blocks 9/4.5 [40.3616] to set the slider of the distal targeter D in line with distal locking holes of intramedullary nail. Secure the slider of the targeter using the screwdriver S3.5 [40.3604].



CHECK! Properly set and secured slider of the targeter allows set blocks to smoothly hit the holes in the nail.

Remove the set blocks from the targeter.
Dismount distal targeter D [40.5093] from targeter arm [40.5091].

- 8 Attach impactor-extractor [40.5507] to the targeter arm [40.5091] with already attached intramedullary nail. Insert the intramedullary nail into the medullary canal through the guide rod 3.0/580 [40.3925.580]. Advance the nail into the medullary canal until adequate depth is reached.

Remove the guide rod 3.0/580 [40.3925.580].
Remove impactor-extractor [40.5507] from the targeter.

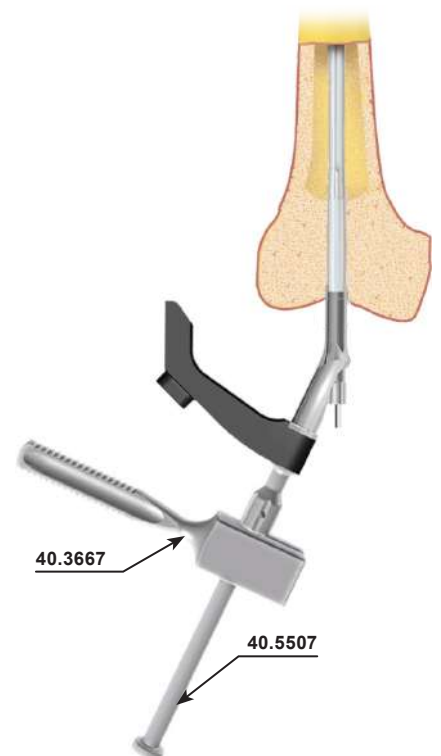

IV.7.4. Locking the nail in the condyle of femur

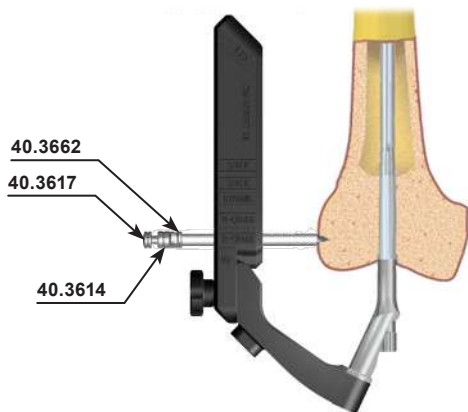

- 9 Attach the targeter 135 [40.5092] to the targeter arm [40.5091]. Insert the protective guide 11/9 [40.3662] and protective guide 9/6.5 [40.3614] and trocar 6.5 [40.3617] into the targeter hole positioned in the most distal part. Mark the entry point for the trocar and make an adequate incision of the soft tissues. Advance the trocar with protective guides until they reach the cortex bone. Mark with the trocar the entry point for drill.

Remove the trocar.
Leave the protective guides in the hole of the targeter.

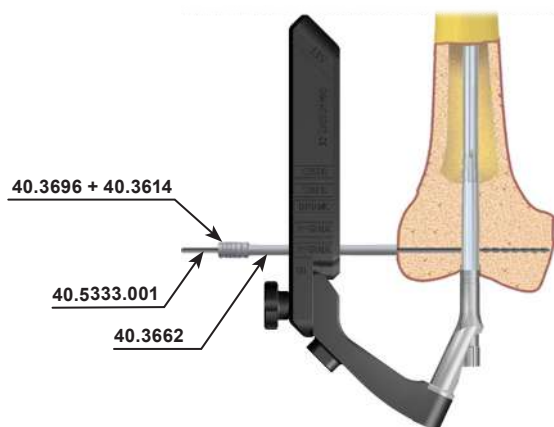

IV.7.4.A. OPTION I: Locking with a screw

- 10 Insert the drill guide 6.5/4.5 [40.3696] into the protective guides [40.3662] and [40.3614]. Mount the drill with scale 4.5/370 [40.5333.001] to the surgical drive and advance it through the drill guide. Drill the hole for a locking screw. The scale on the drill shows the length of the locking element. Control drilling process with X-Ray imaging.

Remove the drill and drill guide.
Leave the protective guides in the hole of the targeter.

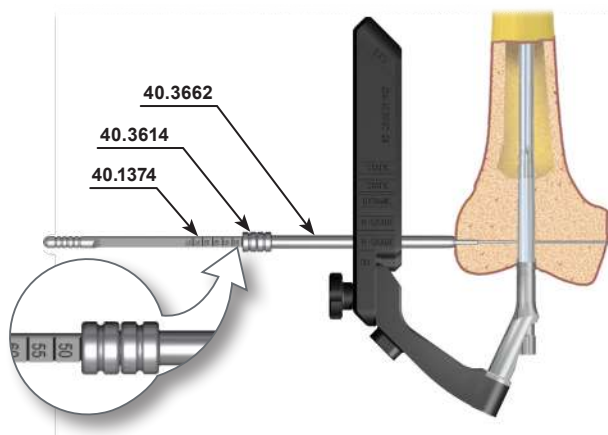

- 11 Insert the screw length measure [40.1374] through the protective guide 9/6.5 [40.3614] into the drilled hole until its hook reaches the "exit" plane of the hole. Read the length of the locking screw on the measure. During the measurement the protective guide should rest on the cortex bone.

Remove the screw length measure.
Leave the protective guides in the hole of the targeter.

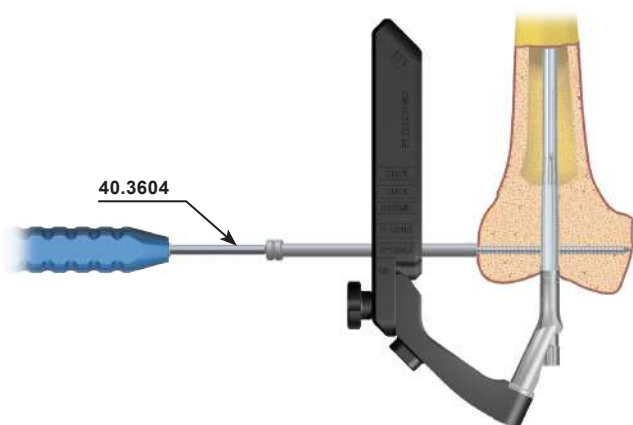

- 12 Insert the tip of the screwdriver S3.5 [40.3604] into the socket of the selected locking screw. Then advance both into the protective guide. Insert the locking screw into the prepared hole until the head of the screw reaches the cortex bone (the groove on the screwdriver shaft matches the edge of protective guide).

Remove the screwdriver and the protective guide.
For distal locking of the nail use locking screws with diameter 6.5mm.

IV.7.4.B. OPTION II: Locking with locking set (bolt - 2 washers - locking screw)

- 13 The drill guide 9/6.5 [40.3614] and the protective guide 11/9 [40.3662] are in the hole of the targeter. Mount the drill 6.5/370 [40.2068.371] to the surgical drive and advance it through the drill guide. Drill the hole through the bone.



Control drilling with X-Ray image intensifier.

With the help of X-Ray image intensifier, make the incision of the soft tissues over the place the drill exits the bone.

Remove the drill.

Leave the protective guides [40.3662] and [40.3614] in targeter hole.

- 14 Insert the screw length measure [40.1374] through the protective guides into the drilled hole until its hook reaches the "exit" plane of the hole. Deduct 10mm from the reading on the measure, to get the characteristics of the locking set required. Select the locking set with adequate range, e.g. with measure reading "75" the locking set parameter is "65", therefore the locking set 60 with range between 60 and 75 mm is adequate. During the measurement the protective guide should rest on the cortex bone.

Remove the screw length measure.

Leave the protective guide in the hole of the targeter.

- 15 Insert the bolt guide [40.5075] into the protective guide. The pilot which is an integral part of the the bolt guide should be attached on the instrument. Advance the bolt guide through the drilled hole until its tip reaches the hole from the other side. Remove the pilot from the the device. Put the bolt (*implant*) through the washer (*implant*) and screw it in onto the the bolt guide using the screwdriver S3.5 [40.5074]. Advance the bolt into the hole in the bone (*head of the bolt should rest on the cortex with the washer in between*).

Remove the bolt guide from the bolt and remove it from the protective guide.

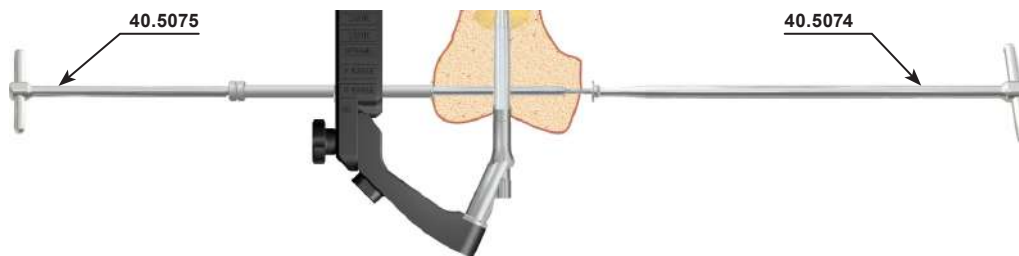

- 16 Leave the protective guide 11/9 [40.3662] in the hole of the targeter. Insert the tip of the screwdriver S3.5 [40.3604] into the hexagonal socket of the locking screw (*implant*) and advance both into the protective guide. Put the washer (*implant*) over the locking screw when it leaves the protective guide. Insert the locking screw in the threaded hole in the bolt (*hold the bolt with the screwdriver*). Two screwdrivers are used to secure the locking set (*locking screw, two washers, bolt*).

Remove the screwdrivers and protective guide.

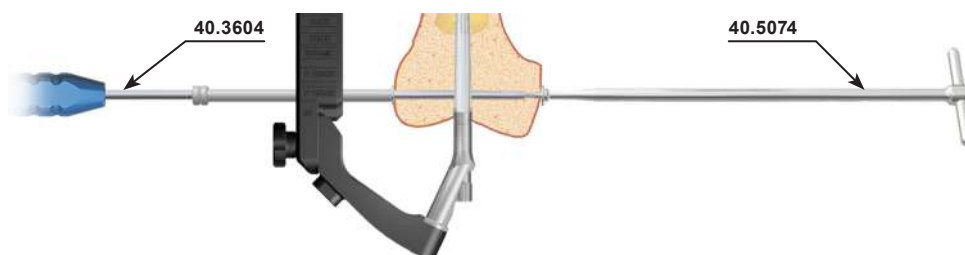

NOTE! To lock the second locking set in the other distal hole, follow steps 13 to 16.

IV.7.5. Nail locking in the shaft part

Before performing locking of the nail, do the following:

1. Mount the distal targeter D [40.5093] on the targeter arm [40.5091]. If properly installed, the signs RIGHT or LEFT on both targeters should comply.
2. Verify, with the X-Ray imaging, the position of holes in the nail and in the targeter. The centers of the holes in nail and targeter have to be in line.

- 17** Insert the protective guide 9/6.5 [40.3614] with trocar 6.5 [40.3617] into the distal hole in the distal targeter D [40.5093]. Mark the entry point for the trocar and make an adequate incision of the soft tissues. Advance the trocar together with protective guide until it reaches the cortex bone. Using the trocar mark the entry point for the drill.

Remove the trocar.

Leave the protective guide in the hole of the targeter.

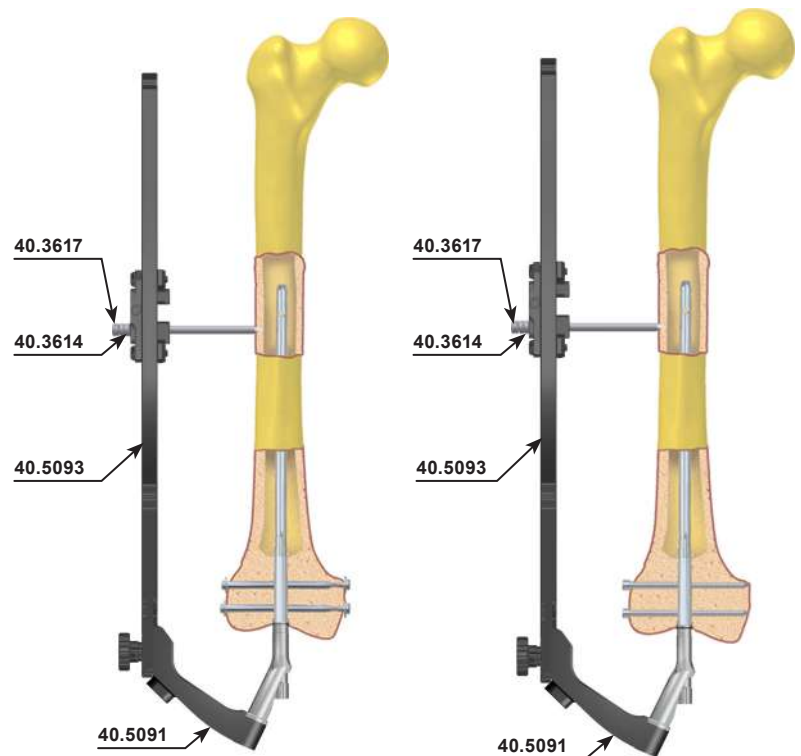

- 18** Insert the drill guide 6.5/3.5 [40.3615] (with two grooves) into the protective guide. Mount the drill with scale 3.5/270 [40.5330.001] to the surgical drive and advance it through the drill guide. Drill the hole in the femur through both cortex layers and the hole in the nail. The scale on the drill shows the length of the locking element.

Disconnect the drive off the drill and leave the system: protective guide-drill guide-drill.

- 19** Insert the protective guide 9/6.5 [40.3614] (with one groove) with

trocar 6.5 [40.3617] into the second hole of distal targeter. Advance the trocar until it reaches the cortex bone and mark the entry point for the drill. Advance the protective guide together with the trocar until it touches the bone.

Remove the trocar.

Leave the protective guide in the hole.

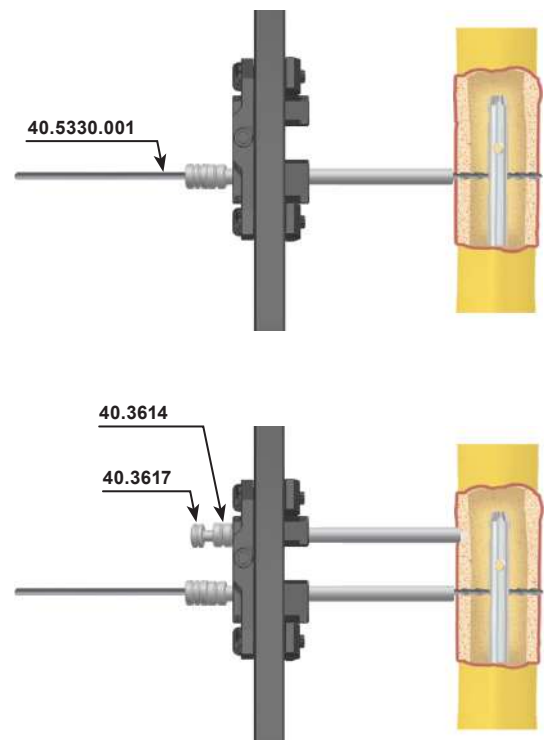

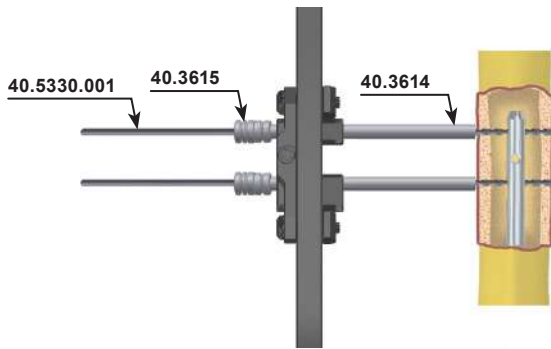

20 Insert the drill guide 6.5/3.5 [40.3615] (with two grooves) into the protective guide. Mount the drill with scale 3.5/270 [40.5330.001] to the surgical drive and advance it through the drill guide. Drill the hole in the femur through both cortex layers and the hole in the nail. The scale on the drill shows the length of the locking element.

Remove the drill and drill guide.
Leave the protective guide in the targeter hole.

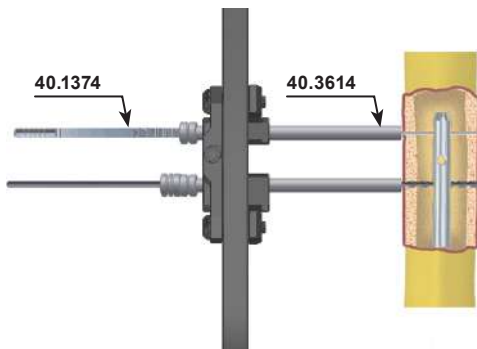

21 Insert the screw length measure [40.1374] through the protective guide into the drilled hole until its hook reaches the "exit" plane of the hole. Read the length of the locking screw on the measure. During the measurement, the tip of the protective guide should rest on the cortex bone.

Remove the screw length measure.
Leave the protective guide in place.

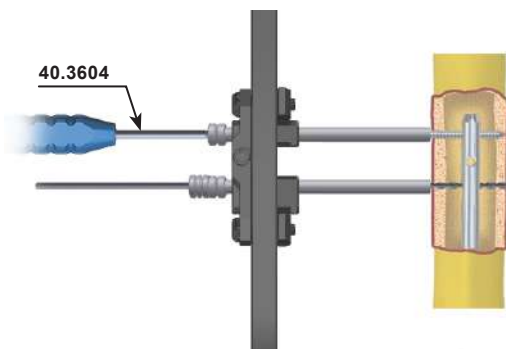

22 Insert the tip of the screwdriver S3.5 [40.3604] into the socket of the selected locking screw. Then advance both into the protective guide. Insert the locking screw into prepared hole until the head of the screw reaches the cortex bone (*the groove on the screwdriver shaft matches the edge of the protective guide*).

Remove the screwdriver.
Leave the protective guide.

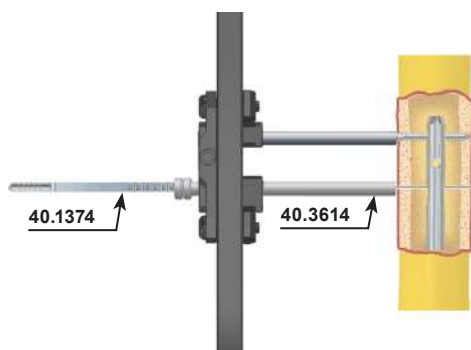

23 Remove the drill and drill guide from the other hole of the targeter. Leave the protective guide in the hole of the targeter. Insert the screw length measure [40.1374] through the protective guide into the drilled hole until its hook reaches the "exit" plane of the hole. Read the length of the locking screw on the measure. During the measurement the protective guide should rest on the cortex bone.

Remove the screw length measure.
Leave the protective guide in hole of the targeter.

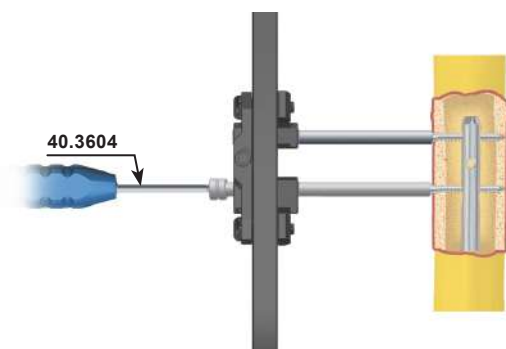

24 Insert the tip of the screwdriver S3.5 [40.3604] into the socket of the selected locking screw. Then advance both into the protective guide. Insert the locking screw into prepared hole until the head of the screw reaches the cortex bone (*the groove on the screwdriver shaft matches the edge of the protective guide*).

Remove the screwdriver and protective guide.



NOTE! Proximal locking of the nail may be also performed using freehand technique. The procedure is described within reconstruction method. Refer to steps 35 to 38.

IV.7.6. Targeter removal, end cap insertion

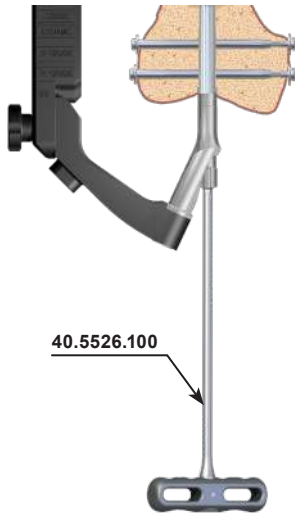

- 25** Using the wrench S10 [40.5526.100] unscrew the connecting screw M10x1 L=55 [40.5094] from the nail shaft and dismount the targeter from the nail locked in the medullary canal.
Dismount the targeters.

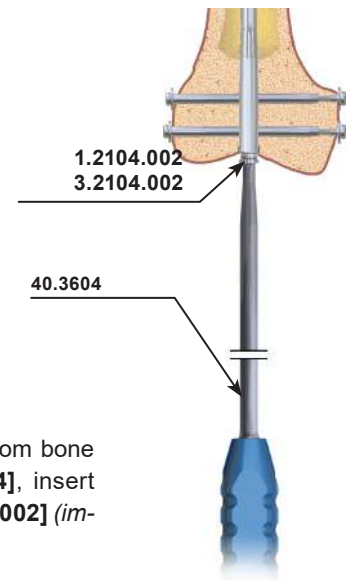

- 26** In order to secure the inner thread of the nail from bone ingrowth, using the screwdriver S3.5 [40.3604], insert the **CHARFIX** End cap M10x1 [1.2104.002] or [3.2104.002] (*implant*) into the nail shaft.

IV.7.7. Nail extraction

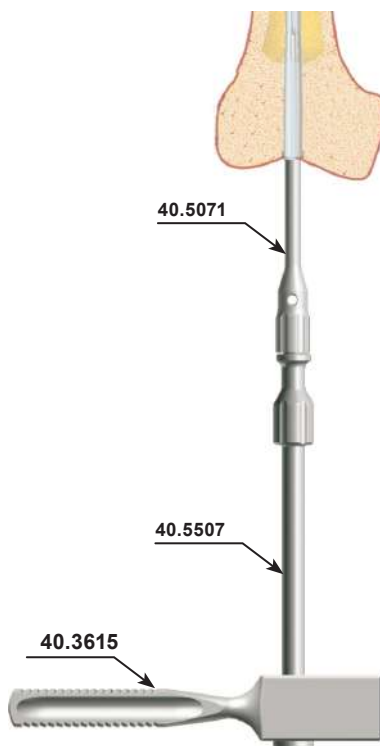

- 27** Use the screwdriver S3.5 [40.3604] to remove the **CHARFIX** End cap M10x1 and all the locking screws (*use 2 screwdrivers to remove the locking set*). Insert the connector M10x1/M12 [40.5071] into the threaded hole of the nail. Then, attach the impactor-extractor [40.5507] to the connector and with help of the mallet [40.3667] remove the nail from the medullary canal.

ChM sp. z o.o.

Lewickie 3b
16-061 Juchnowiec Kościelny
Poland

tel. +48 85 86 86 100

fax +48 85 86 86 101

chm@chm.eu

www.chm.eu



CE 0197