

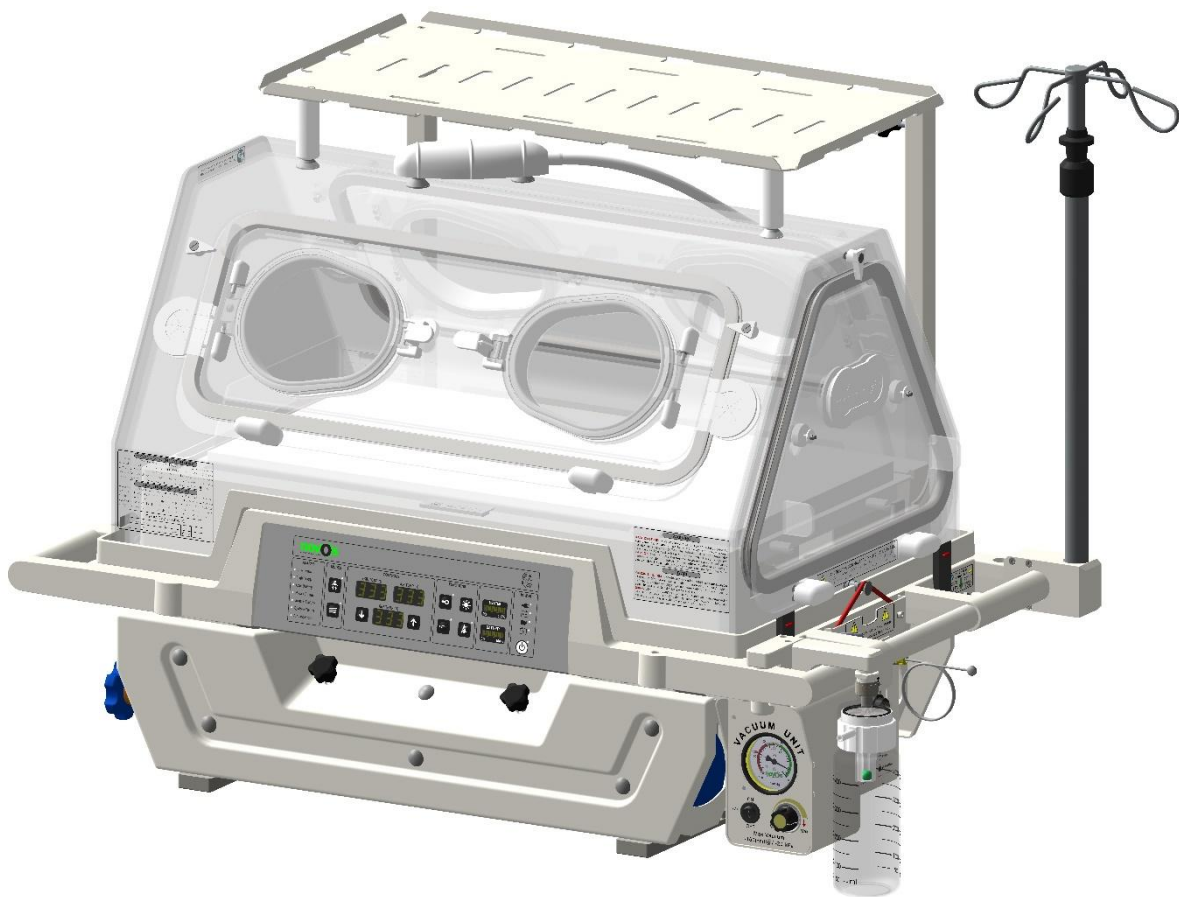

KT-1000 User Manual



WARNING

Registered Information

This document contains information on which NOVOS assumes the property rights. The information may not be reproduced in whole or in part unless authorized in writing by NOVOS. This information are the property of NOVOS, for its intended use only.

Repair/Modifications

Repairs on this device shall only be carried out by NOVOS or Factory Authorized Service Centres. Information on repairs can be obtained from NOVOS or Authorized Resellers. NOVOS shall not assume any responsibility for any injury to persons or damage to property arising directly or indirectly from unauthorized repair or modification of this device. In addition, any unauthorized repair or modification shall void any warranty provided by NOVOS. This document is provided for information purposes only. It cannot be changed or updated at will.

Serious Adverse Event Notification

In case of a serious adverse event that may occur during the use of the device, the user must notify the competent authority of the member state in which the device is located and Novos, the manufacturer. To make this notification, approved organizations within the member states can be accessed using the link below. If there is no notified body in the country of affiliation, the relevant notification must be made to a notified body in Turkey.

<https://webgate.ec.europa.eu/single-market-compliance-space/#/notified-bodies>

Important note

Be sure to read the user manual before using the device. User manuals are given to the user along with the device. If requested, it can also be obtained free of charge from the Novos sales department.

Table of Contents

- 1. Safety Information 9
 - 1.1. Symbols..... 9
 - 1.2. User’s Obligations for Patient Safety 11
 - 1.3. Patient monitoring..... 11
 - 1.4. Limitation of Liabilities..... 11
 - 1.5. Warranty..... 12
- 2. Product Description 13
 - 2.1. Usage Purpose 13
 - 2.5. Precautions for Operation of Device..... 15
 - 2.5.1. Warnings regarding device use 15
 - 2.5.2. Precautions for Ambient Conditions 16
 - 2.5.3 Indications, Contraindication, and Precautions for Potential Physiological Effects 16
- 3. Parts and Controls..... 18
 - 3.1. Front View..... 18
 - 3.2. Right View 20
 - 3.3. Rear View 21
 - 3.4. Control Panel Connections 22
- 4. Overview 23
 - 4.1. Power Panel 23
 - 4.2. Overview of KT-1000 Infant Transport Incubator..... 24
 - 4.3. Description of Operation 24
 - 4.4. Temperature Control 24
 - 4.5. KT-1000 Control Unit 25
 - 4.5.1. Buttons 25
 - 4.5.2. Displays 25
 - 4.5.3. Indicators..... 25
- 5. Preparation 26
 - 5.1. Unpacking and Initial Installation 26
 - 5.2. Installing the Fuses 27
 - 5.3. Fastening Incubator onto Trolley..... 27
 - 5.4. Installation of Gas Cylinders 30
 - 5.5. Pre-start Preparation Check 30
- 6. Operation of Device 40
 - 6.1. General Precautions for Operation..... 40
 - 6.1.1. Preheating 40

- 6.1.2. Self-test 41
- 6.1.3. Temperature setting 42
 - 6.1.3.1. PCLCS operating principle 42
- 6.1.4. Placing the infant 42
- 6.1.5. Placing the skin temperature sensor 43
- 6.1.6. Use of humidity 44
- 6.1.7. Variable height adjustment of trolley 44
- 6.1.8. Operation of examination light 45
- 6.1.9. Use of power supply 46
- 6.1.10. Transport of infant 46
- 6.1.11. Use of accessory shelf 47
 - 6.1.11.1. Lowering the shelf 47
 - 6.1.11.2. Lifting the shelf 47
 - 6.1.11.3. Use of shelf connecting straps 47
- 6.1.12. Adjustable Vacuum Unit (Optional) 48
 - 6.1.12.1. Using the adjustable vacuum unit 49
- 6.1.13. Shut down of system 49
- 7. Routine Cleaning and Maintenance 50
 - 7.1. Cleaning and Disinfection 50
 - 7.2. Post-cleaning Reassembly 56
 - 7.3. Maintenance 57
 - 7.4. Disposal Applications 61
 - 7.4.1. Disposal of KT-1000 61
 - 7.4.2 Clinical thermometers Disposal 61
- 8. Troubleshooting 62
 - 8.1. Alarm Messages 62
 - 8.2. Error Messages 63
- 9. Annexes 65
 - 9.1. Technical Specifications 65
 - 9.1.1. Environmental Requirements 65
 - 9.1.2. Mechanical Features 65
 - 9.1.2.1. Transport Incubator with Ambulance Stretcher 65
 - 9.1.2.2. Transport Incubator with Trolley 65
 - 9.1.3. Electrical Properties 65
 - 9.1.4. Sensor Features 66

- 9.1.5. Humidity Properties 66
- 9.1.6. Other Features 66
- 9.2. Conformity 67
 - 9.2.1. Conformity Directive: 68
 - 9.2.2. Guidance and Manufacture’s Declaration – Electromagnetic Emissions 69
 - 9.2.2.1. *Electromagnetic* Environment 69
 - 9.2.2.2. Electromagnetic Immunity 70
 - 9.2.2.3. Recommended Separation Distance 72
- 9.3. Registration of Trademarks 73
- 9.4. Manufacturer 73

About This Manual

Scope

This manual includes a detailed description of operation and maintenance activities relating to sub-components of KT-1000 Infant Transport Incubator.

Target Users

This device must only be operated by medical personnel who are familiar with any risks and benefits for operation of such devices, and who are trained on the operation of device.

Target users of this manual include end users of device, caregivers working in the delivery rooms and newborn intensive care units, and personnel who are responsible for hospital biomedical and clinical engineering services.

This product is intended for professional use only.





















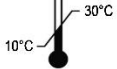

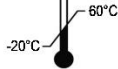
Purpose





This manual provides a guidance for the

- installation
- operation and
- maintenance of KT-1000 Infant Transport Incubator System.

All the specifications and technical data for the device are listed for the benefit of users and to enable efficient operation of device.



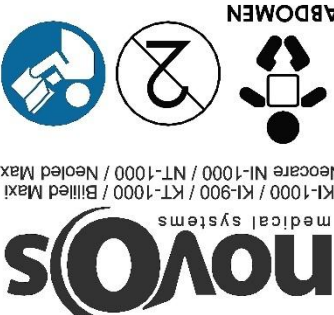







Label Information







 <p>NOVOS TIBBİ CİHAZLAR SANAYİ VE TİCARET İTHALAT VE İHRACAT LİMİTED ŞİRKETİ İvedikösb Mahallesi 1518 Cad. Matbaacılar Sitesi Sit. No:2/39 Yenimahalle, Ankara, Türkiye Tel:+903123841588 e-mail:info@novos.com.tr</p> <p>novos medical systems</p> <p>CE 1984</p> <p>PRODUCT / ÜRÜN : INFANT TRANSPORT INCUBATOR / BEBEK TRANSPORT KUVÖZÜ</p> <p># KT-1000 ID 006 000 SN KT - 12345 - 321</p> <p> 2x4A, 1x15A  350W  110-220 VAC / 3.2A-1.4A / 50/60 Hz</p> <p>  NON STERILE    IP20</p> <p> 2024-09-18   10°C - 30°C  5% - 95%  -20°C - 60°C  5% - 95%</p> <p>Operating / Çalışma Storage / Depolama</p> <p>UDI  (01) 8 6993830 00633 8 (21) KT-12345-321</p> <p><i>ET.3.8.01.14 / Rev.06 / 18.09.2024</i> Made in Türkiye / Türkiye'de üretilmiştir</p>	<p>Device Identification</p>
<p>novos INFANT TRANSPORT INCUBATOR KT-1000 medical systems BEBEK TRANSPORT KUVÖZÜ</p> <hr/> <p>SN KT - 12345 - 321 Order No / Sipariş No:</p> <p>ID 006 000 Package No / Paket No:</p> <p>Customer / Müşteri:</p> <p>Shipping Address / Teslim Adresi:</p> <p> 2024-09-18   MD</p> <p>   Quantity: 1 </p> <p>UDI  (01) 8 6993830 00633 8 (21) KT-12345-321</p>	<p>Label on the Outer Packaging</p>
<p>NOVOS TIBBİ CİHAZLAR SANAYİ VE TİCARET İTHALAT VE İHRACAT LİMİTED ŞİRKETİ İvedikösb Mahallesi 1518 Cad. Matbaacılar Sitesi Sit. No:2/39 Yenimahalle, Ankara, Türkiye Tel:+903123841588 e-mail:info@novos.com.tr</p> <p>novos medical systems</p> <p>CE 1984</p> <p><i>ET.3.8.01.15 / Rev.01 / 18.09.2024</i></p>	

	 <p>ABDOMEN</p> <p>Neocare NI-1000 / NT-1000 / Neoled Maxi KI-1000 / KI-900 / KT-1000 / Billed Maxi</p> <p>NOVOS medical systems</p> <p>SKIN TEMPERATURE PROBE CİLT SICAKLIK PROBU</p> <p>KI-1000 / KI-900 / KT-1000 / Billed Maxi Neocare NI-1000 / NT-1000 / Neoled Maxi</p> <p>REF: 100.161</p> <p>LOT:</p>  <p>ET.3.8.01.36 / Rev.01 / 03.03.2025</p>		<p>Reusable Skin Probe</p>
	 <p>ABDOMEN</p> <p>Neocare NI-1000 / NT-1000 / Neoled Maxi KI-1000 / KI-900 / KT-1000 / Billed Maxi</p> <p>NOVOS medical systems</p> <p>SKIN TEMPERATURE PROBE CİLT SICAKLIK PROBU</p> <p>KI-1000 / KI-900 / KT-1000 / Billed Maxi Neocare NI-1000 / NT-1000 / Neoled Maxi</p> <p>REF :100.377</p> <p>LOT :</p>  <p>ET.3.8.01.37 / Rev.02 / 03.03.2025</p>		<p>Disposable Skin Probe</p>

1. Safety Information

1.1. Symbols

	This symbol means “Please refer to relevant document” and is visible on any hardware component of device.
	This symbol indicates that device is categorized as Class BF.
IP20	Protected against solid objects larger than 12.5 mm
	This symbol is used to provide warning about any potential risk or injury to device users. Warnings are instructions that may result in fatal or severe injuries to any user, engineer, patient or any other person, or wrong treatment if not followed properly.
CAUTION	A caution text is an instruction that may cause to damage to the system described in this document if not followed properly.
NOTE	A NOTE is used where relevant additional information is provided.
ID	Product Identity
	Manufacturer
	Date of manufacture
	Electrical and electronic device waste should not be discarded in municipal rubbish tip, but collected separately
SN	Serial Number
	Power
	Fuse Box
CE 1984	CE Marking Authorized Body
	Refer to user’s manual.
	Protective Grounding
	Alternating Current Supply

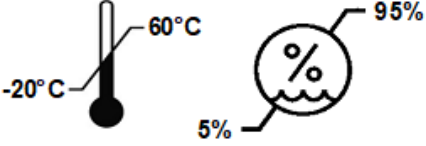
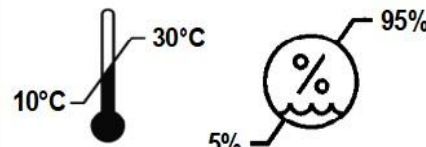
	<p>Direct Current Supply</p>
	<p>General Prohibition Sign</p>
	<p>Maximum Weight Sign</p>
	<p>This sign on the label indicates that packaging must be upright.</p>
	<p>This sign on the label indicates that packaging content is fragile and must be handled carefully.</p>
	<p>This sign on the label indicates that packaging must be protected against the moisture and rain.</p>
<p>Storage / Depolama</p> 	<p>Storage Temperature and Humidity</p>
<p>Operating / Çalışma</p> 	<p>Operating Temperature and Humidity</p>

1.2. User's Obligations for Patient Safety

ATTENTION!

Strictly follow this manual. Any operation of the product requires complete understanding and strict observation of any parts of these instructions. This equipment may only be used for the "Intended Purpose". Please carefully follow all WARNING and CAUTION indications provided in this manual and labels on the device.

The design of this equipment, relevant literature and labeling on the equipment consider that purchasing and operation of this equipment is limited to trained professionals, and that trained operators are familiar with the specific features of this device. Therefore, instructions, warning and caution indications are largely limited to properties of NOVOS design. This document does not contain any references to consequences arising from misuse of device by any medical professional and operator of this device, potential side effects that may be observed in patients with abnormal condition, and various hazards. Modifications to or misuse of product may be hazardous. NOVOS Medical Devices assumes no liability for the consequences of modifications or alterations to product, and for the consequences arising from combination of this product with other products provided by NOVOS or other manufacturers, unless such combination is approved by NOVOS.

1.3. Patient monitoring

The operators of this infant transport incubator system must recognize their responsibilities for choosing an appropriate safety monitoring option that provides sufficient information on the equipment performance and patient condition. Patient safety may be achieved by a wide range of different tools from electronic observation of patient condition and equipment performance to simple and direct observation of clinical symptoms. It is the sole responsibility of equipment operator to choose the optimum patient monitoring level.

1.4. Limitation of Liabilities

NOVOS assumes no liabilities for production of goods, sales of goods (activities), installation, advertising, operation, application and product manufacturing warranty. Such liabilities are subject and limited to special conditions described in this manual. Conditions that render warranty null and void, negligence that may occur independently of NOVOS, infringement to product, etc. limit the liabilities of NOVOS regardless of whether it is the fault of NOVOS, and the way of occurrence of fault. NOVOS assumes no liabilities for recovery of damages that may arise from or in connection with products as well as for obligations of buyer to third parties. The buyer shall not be entitled to make a claim on recovery of such damages.

1.5. Warranty

Any NOVOS product is provided with a warranty for manufacture, workmanship and installation defects for a period of 24 months from the date of invoice. The conditions for the warranty are listed below:

1. The tax and import costs for the returned product are not covered by the warranty.
2. Repairs, modifications and alterations made within the warranty period may not be a reason to extend the given warranty period.
3. The defect must be caused by the workmanship or material.
4. Only in case of problems resulting from workmanship or material, then parts may be replaced, costs may be recovered, or product may be repaired by NOVOS Medical Devices. NOVOS Medical Devices reserves the right to use the appropriate method among the methods mentioned above in regard to a warranty claim.
5. NOVOS Medical Devices shall assume no liability for
 - a. Malfunction, wear or misuse of any component of product,
 - b. Manipulation, misuse, damages caused during the transport, or modifications not approved by NOVOS Medical Devices or its authorized representative,
 - c. Failures resulting from force majeure events and other conditions that are not attributable to manufacturer,
 - d. Failures resulting from voltage fluctuations,
 - e. Failures resulting from insufficient service and maintenance, or service and maintenance not provided by the customer when necessary,
 - f. Normal wear and tear of functional parts.
6. For the warranty claim for repair of damages caused during transport:
 - a. The packaging/crate must always be inspected for any sign of damages.
 - b. On case of any sign of damages found, the damage must be recorded for proof.
 - c. The carrier must be warned and warranty claim for damaged product must be completed.
7. In any case, NOVOS Medical Devices shall not be liable for more than the original sale price.
8. The buyer guarantees that any service and maintenance activities are performed by qualified personnel in timely manner in accordance with NOVOS service manuals.

In case of failure to fulfill such obligations, all the warranty obligations shall be invalid.

The warranty shall be valid if:

1. Any failures that occur in the device or its parts are immediately notified in writing to NOVOS or its authorized representative,
2. Defective device and its parts are returned to NOVOS or authorized factory center in accordance with instructions of NOVOS service personnel,
3. NOVOS or authorized factory center approves that warranty conditions cover such failure as a result of assessment, and
4. The written notice on the failure of device or its part is received by NOVOS or authorized factory center until 2 weeks before expiry of warranty period.

The foregoing provisions concern one valid warranty that is provided by NOVOS. It is not intended to describe or disclose the warranty conditions otherwise.

The dealers and representatives of NOVOS are not authorized to amend such warranty conditions.

NOVOS Medical Devices.

2. Product Description

2.1. Usage Purpose

KT-1000 baby transport incubator; It is used to transport high-risk, premature, low birth weight, or critically ill newborns up to 5 kg (11 lbs) body weight or 55 cm (22 inches) body length. The baby transport incubator includes means for air temperature control, oxygen control and passive relative humidity addition. KT-1000 is designed to be used for between institutions or departments transfer of premature newborn or sick babies who need to be in a temperature-controlled environment. The maximum support of the device bed is 10 kg (22 lb).

The KT-1000 baby transport incubator can be used in any department of hospitals providing newborn and pediatric care, including the Neonatal Intensive Care Unit, Infant Special Care Unit, Intermediate Care Unit, Newborn Care Unit and Pediatrics. It can also be used in inter-hospital transport vehicles.

It is used for the following purposes:

- If a properly isolated air and temperature environment is required for the newborn,
- If the newborn needs to be observed well; transparent canopy,
- When there is a need for a suitable heated environment and proper air circulation for the newborn,
- Passive humidity is applied when humidification is needed.

2.2. Patient Population

Mature, premature and post-term infants, whose information is given below, constitute the patient population:

Babies born normally between 37 and 42 weeks are born mature or term. Babies born before 37 weeks are considered premature, and those born after 42 weeks are considered post-term newborns.

2.3. Life Cycle

Factors affecting lifespan:

- Capacity values of capacitors used in electronic cards may change after a certain period of time due to heat and humidity and the decrease in the insulating liquid inside them.
- The fan motor used may oxidize over time due to heat and humidity. The speed may change or it may make noise.
- As the main heater resistance heats up and cools down over time, the resistance wire inside it may break and it may not provide heating.
- The silicon structure of semiconductor materials (integrated circuits and diodes) on electronic cards may deteriorate over time, causing the semiconductor material to become partially or completely dysfunctional.
- Sensor on the device etc. Its connectors may oxidize over time or their plastic parts may become deformed.
- As a result of cleaning the canopy, body and silicone seals of the device with disinfectant, deformation or deterioration may occur in these parts over time.
- The rechargeable battery in the control panel must change over time due to its charge/discharge status.
- Depending on usage, the device's batteries may not charge over time or may run out of charge in a short time.

Result: The above-mentioned faults or malfunctions partially limit the life of the device. However, with the intervention of authorized technical service, the device can be used functionally for an average of 10 years without being scrapped.

2.4. Main Functions

The main functions of KT-1000 are listed below:

- Safe transfer of premature or sick newborns between institutions or departments under appropriate temperature and humidity conditions,
- Ensuring that the baby remains at the appropriate temperature by controlling the skin temperature and air temperature,
- Providing respiratory support with the vacuum unit optionally available in the device,

Statuses that the user can see from the KT-1000 Control Panel:

- Operating status of the battery (battery is being charged with AC voltage, from the battery, from the device is running on the on-board lighter,
- Target temperature screen,
- Skin temperature display,
- Air temperature display,
- Heater level,
- Battery Level

2.5. Precautions for Operation of Device

2.5.1. Warnings regarding device use

CAUTION

This device may only be operated by specifically trained and experienced personnel in healthcare institutions only. In case of misuse of incubator, harm may be caused to newborns. The incubator may only be operated by properly trained personnel under the observation of a doctor who is aware of currently known risks and benefits. Otherwise, severe injuries or fatalities may occur.

CAUTION

For the high-pressure O₂ cylinders, only use the approved oxygen reducing or control valves that are marked for oxygen service. Do not use these valves for air or gasses other than oxygen, otherwise this may result in hazardous conditions when oxygen service is started. Operate such equipment in accordance with instructions of valve manufacturer. Otherwise, severe injuries or fatalities may occur.

WARNING

Risk for damage to equipment or injuries

Reusing, reprocessing or sterilizing disposable products may result in malfunction of medical device and injury to patient. Do not reuse, reprocess or sterilize the disposable products. Disposable products are only designed, manufactured and tested for single-use.

WARNING

Risk for reduction in safety level

Plugging electrical devices in multi-sockets causes to create a medical electrical system. This may result in a low safety level. Follow IEC 60601-1 standard to generate a medical electrical system.

WARNING

Risk for electrical shock and malfunction of device

Any connected device or a combination of devices that do not meet the requirements set out in this Instructions for Use may cause medical device not to function as intended or designed. Before starting any combinations of medical devices, please refer to, and strictly follow the, Operating Manual of any connected devices and combination of devices.

CAUTION

Delivery of oxygen may increase the level of noise for the INFANT placed in the incubator.

2.5.2. Precautions for Ambient Conditions

WARNING

This medical device is not approved and certified for use in atmospheres where mixture of flammable and explosive gasses may generate.

WARNING

Do not keep matches, glowing cigarettes or similar materials that may ignite near the area where oxygen is used. Textile materials, oils and other flammable substances easily catch on fire and may result in a major fire in an ambient rich in oxygen. Post the signs "DO NOT SMOKE" in visible locations. Do not keep additional equipment that may catch flare in or near the incubator. Otherwise, severe injuries or fatalities may occur.

WARNING

The incubator has an alarm for *High Temperature*, however, this alarm will only be activated by the air temperature. Thermal radiation generated do to sunrays or other sources may cause temperature rise in the hood, and thus overheating of newborn without providing an alarm. Do not allow incubator to be exposed to direct sunlight or other thermal radiation resources for a long period of time. Otherwise, severe injuries or fatalities may occur.

2.5.3 Indications, Contraindication, and Precautions for Potential Physiological Effects

Indications:

- The baby cannot maintain its own warmth despite being dressed and wrapped.
- The baby is severely ill and requires close observation
- The baby is at risk of excessive heat loss
- The baby has a known infection or develops sepsis
- Failure of the baby to complete the pregnancy period
- The baby has respiratory distress
- If there is a disorder in the baby's heart rhythm,
- Lack of development of the baby's sucking reflex,
- The baby has various genetic diseases,

Contraindications:



- There are not known contraindications.

Side effects:

- The infant may be disturbed by the noise from the incubator.
- Irregular Irritability in the baby due to concussion during transfer

Adverse effects:

- There are no known adverse effects.

	Always consider the physiological risks for use of O₂ concentration as well as fire hazard.
	Based on the physiological effects due to O₂ , it is required to use an integrated O₂ measurement and control system or a stand-alone O₂ analyzer, and to continuously monitor O₂ concentration for O₂ management.

3.Parts and Controls

3.1. Front View

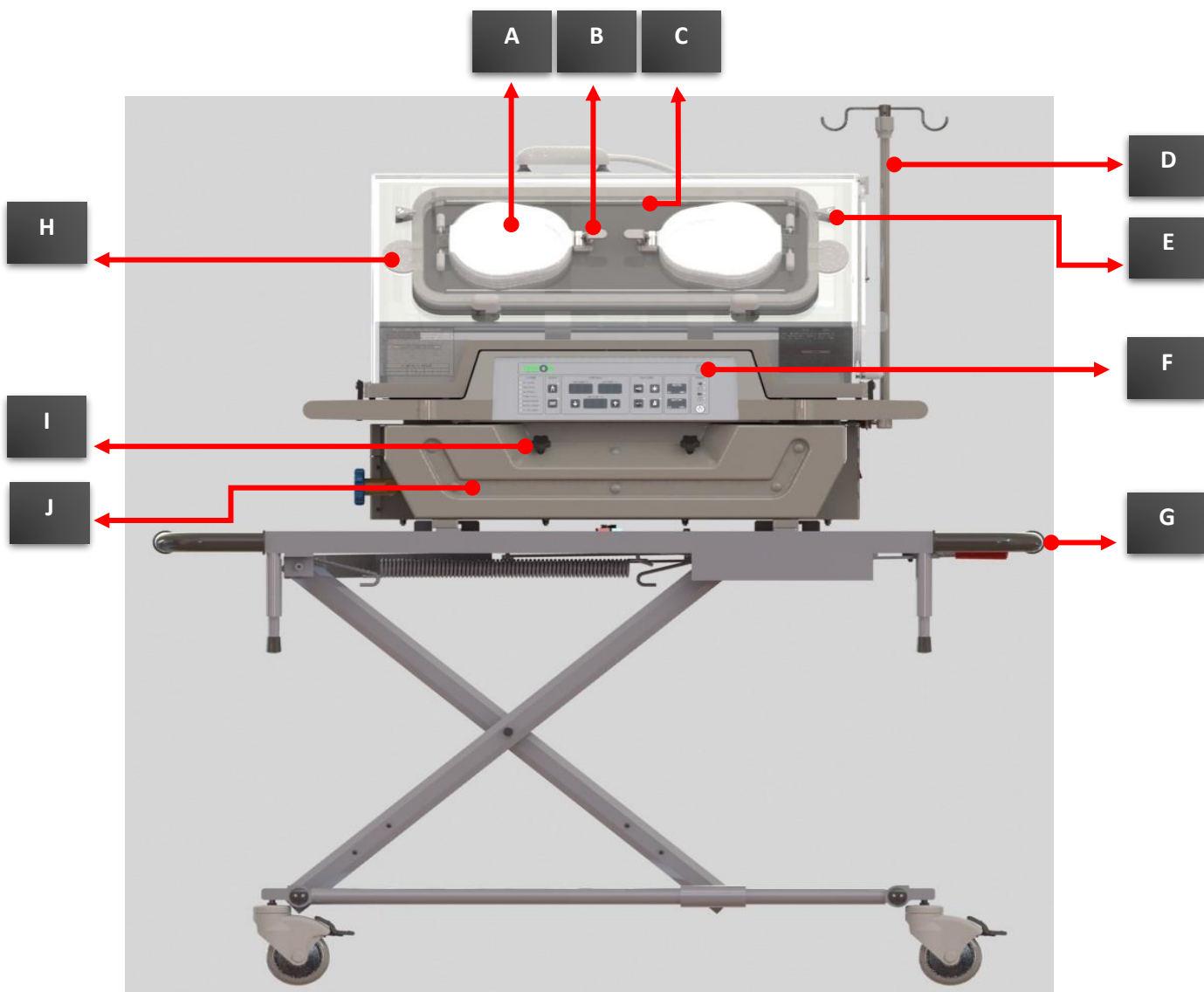

A	Oval window
B	Oval window latch
C	Front access panel
D	IV Pole (optional)
E	Access panel locking latch

F	Control unit
G	Trolley (optional)
H	Grommet
I	Gas cylinder fixing latch
J	Gas cylinder housing

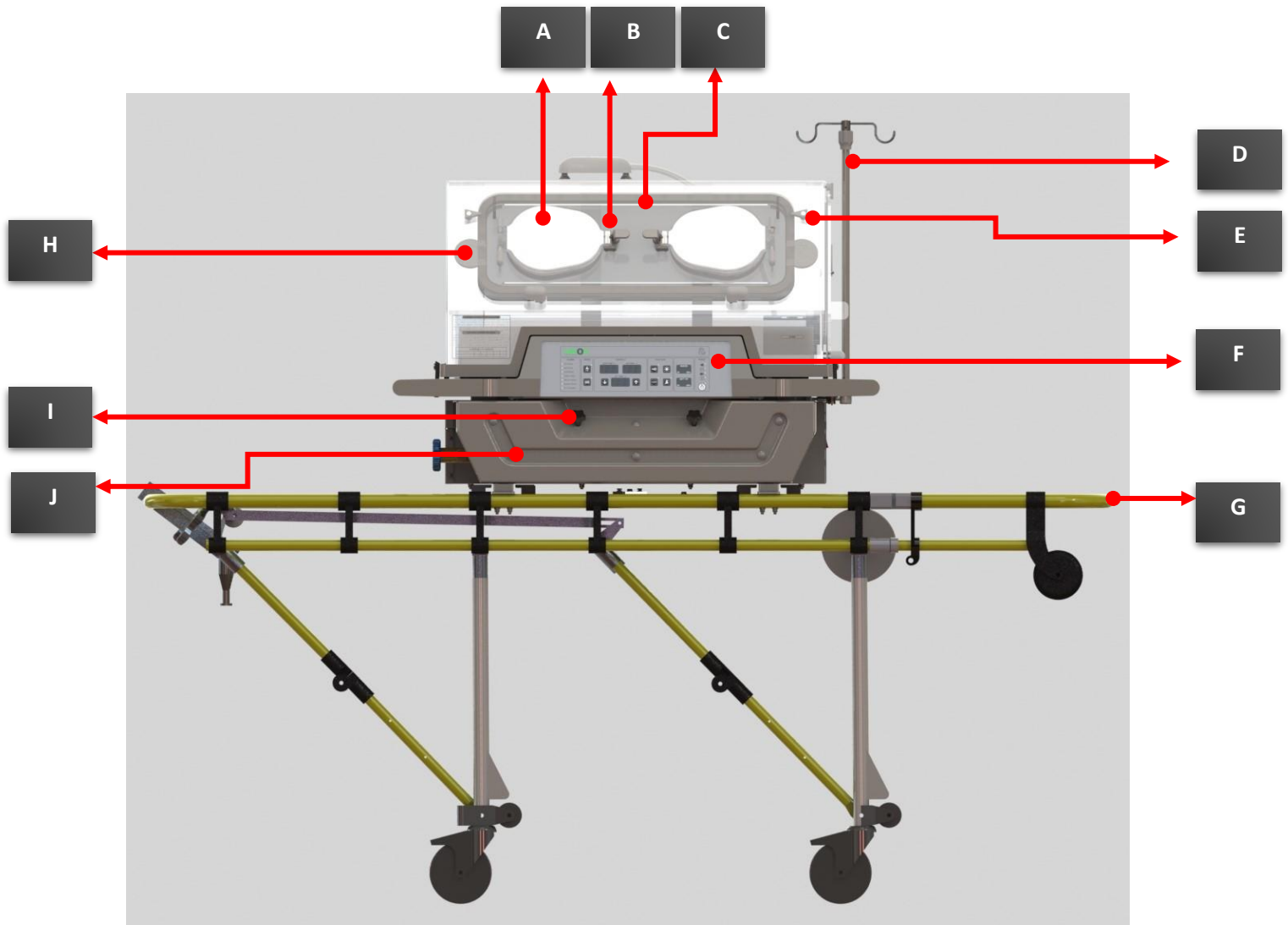

A	Oval window
B	Oval window latch
C	Front access panel
D	IV Pole (optional)
E	Access panel locking latch

F	Control unit
G	Trolley (optional)
H	Grommet
I	Gas cylinder fixing latch
J	Gas cylinder housing

3.2. Right View

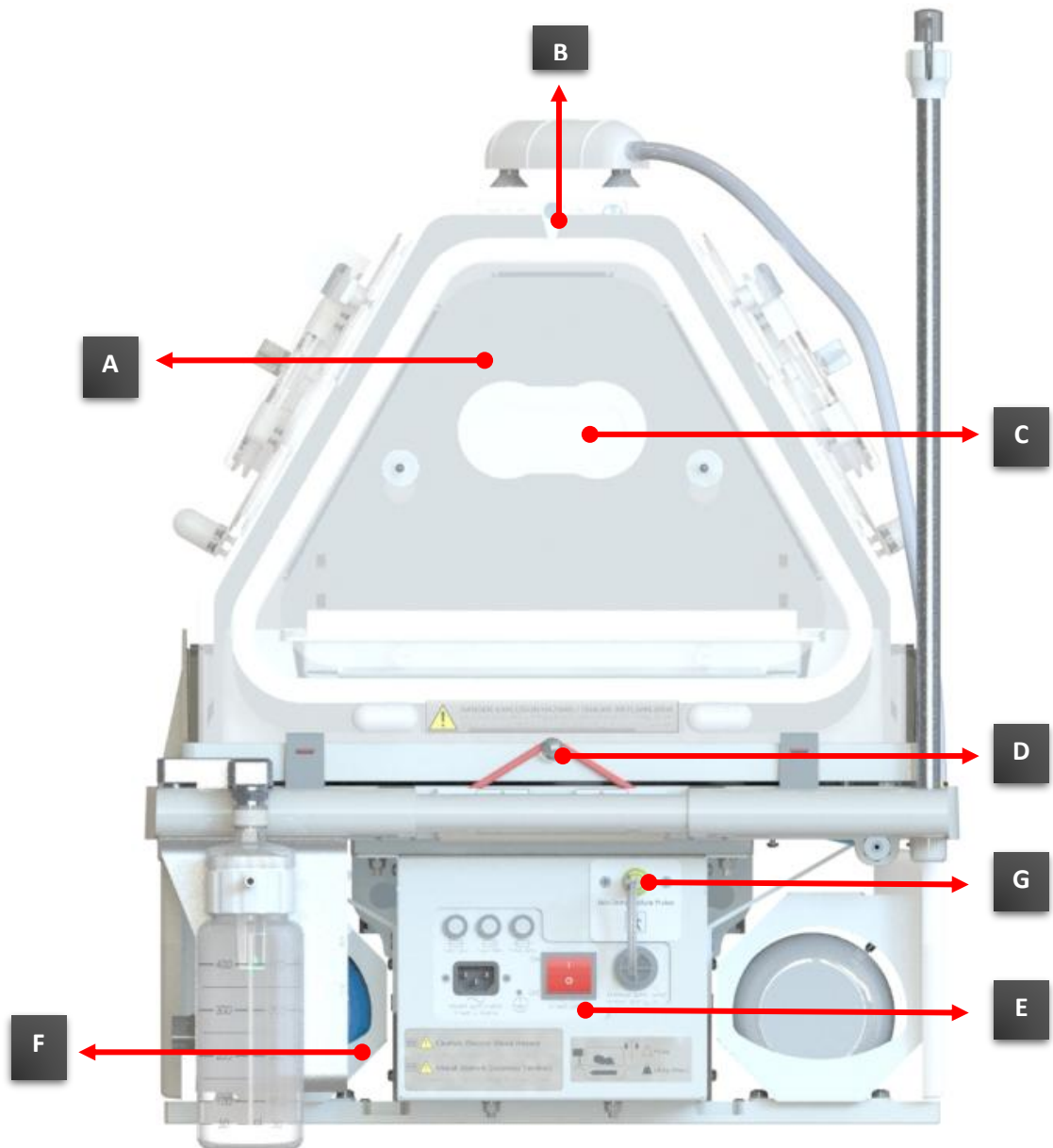

A	Head end access panel
B	Access panel locking latch
C	Grommet
D	Canopy latch

E	Power panel
F	Gas cylinder housing
G	Skin Probe

3.3. Rear View

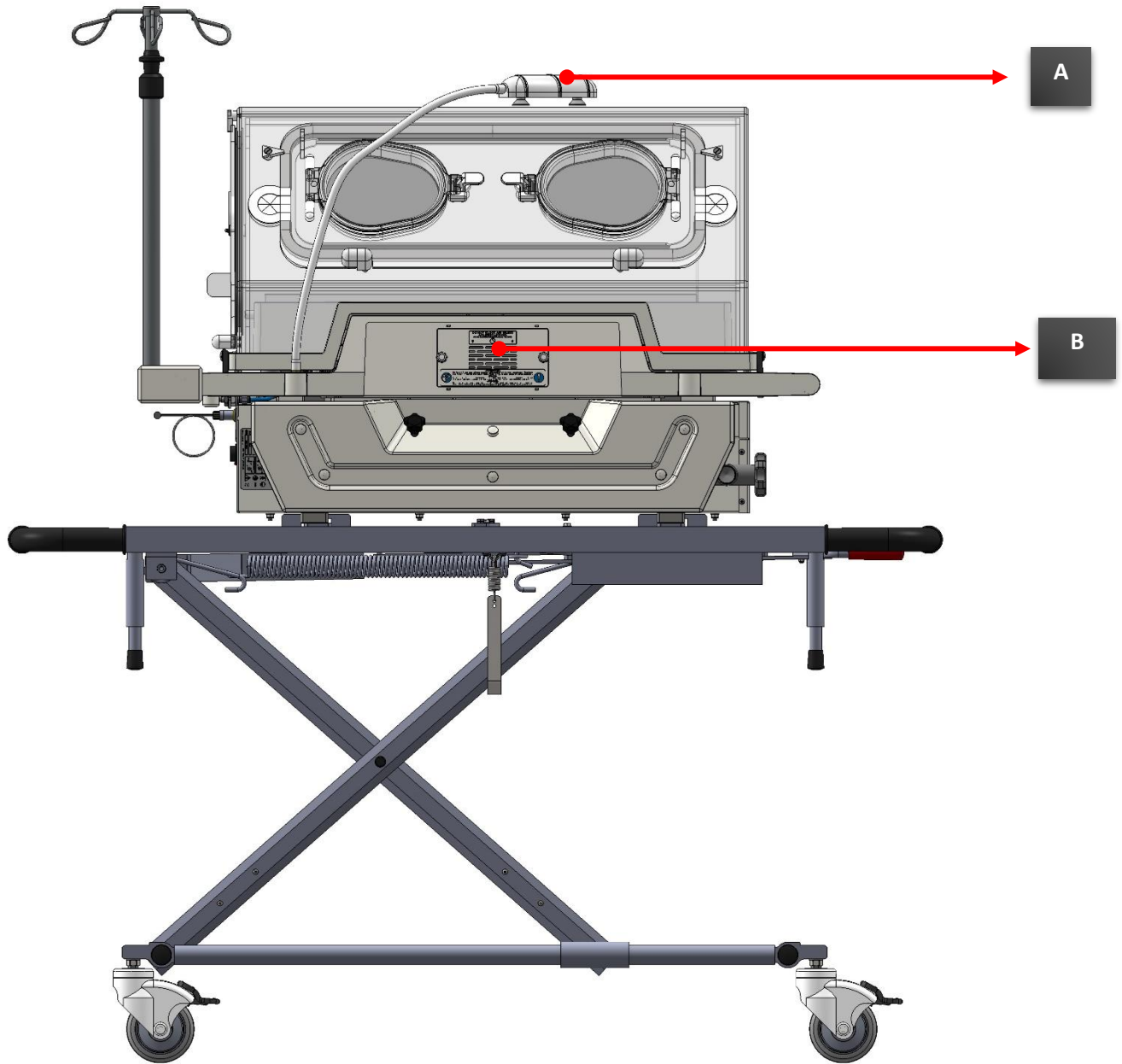

A	Examination light
----------	-------------------

B	Air filter
----------	------------

3.4. Control Panel Connections

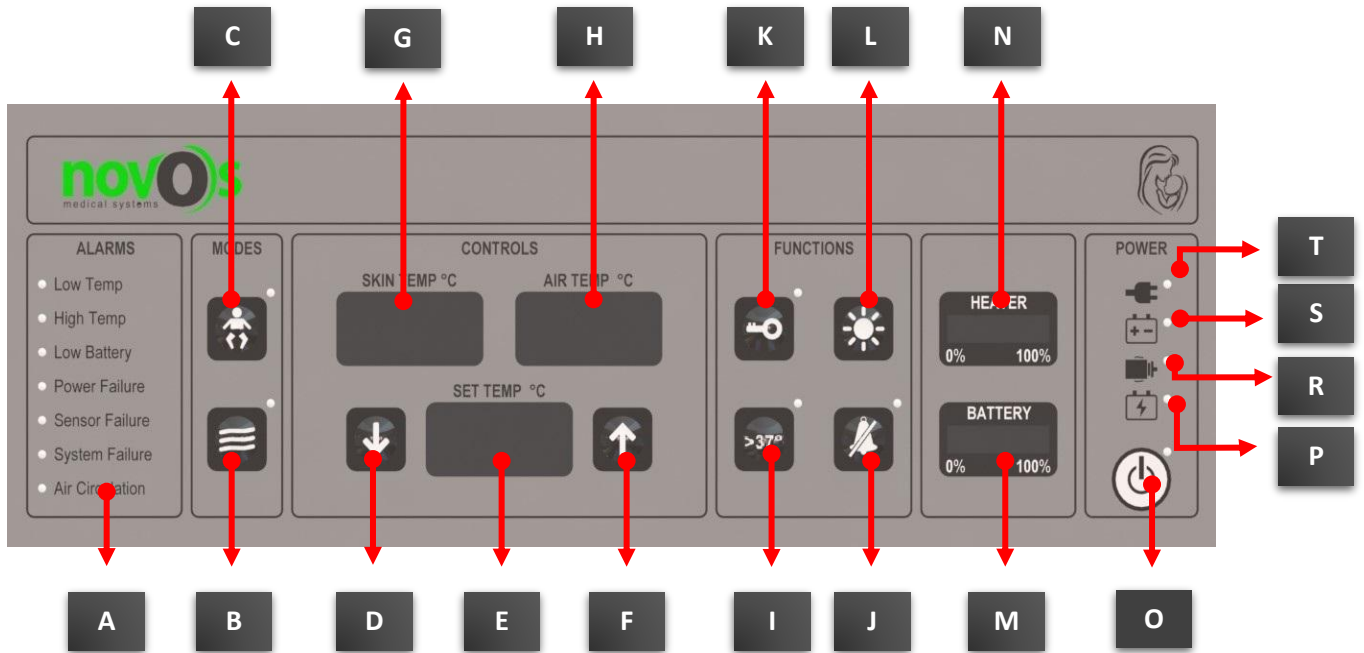

A	Alarms
B	Air Mode Button
C	Skin Mode Button
D	Down Arrow Button
E	Target Temperature Display
F	Up Arrow Button
G	Skin Temperature Display
H	Air Temperature Display
I	>37°C Confirmation Button
J	Silence/Pause Alarm Button

K	Keypad Locker Button
L	Light On/Off Button
M	Battery Level Display Screen
N	Heater Level Display Screen
O	Power on/off Button
P	Battery Recharging
R	Device is running on the on-board lighter
S	Device is running on the battery
T	Device is running on AC voltage

4. Overview

4.1. Power Panel

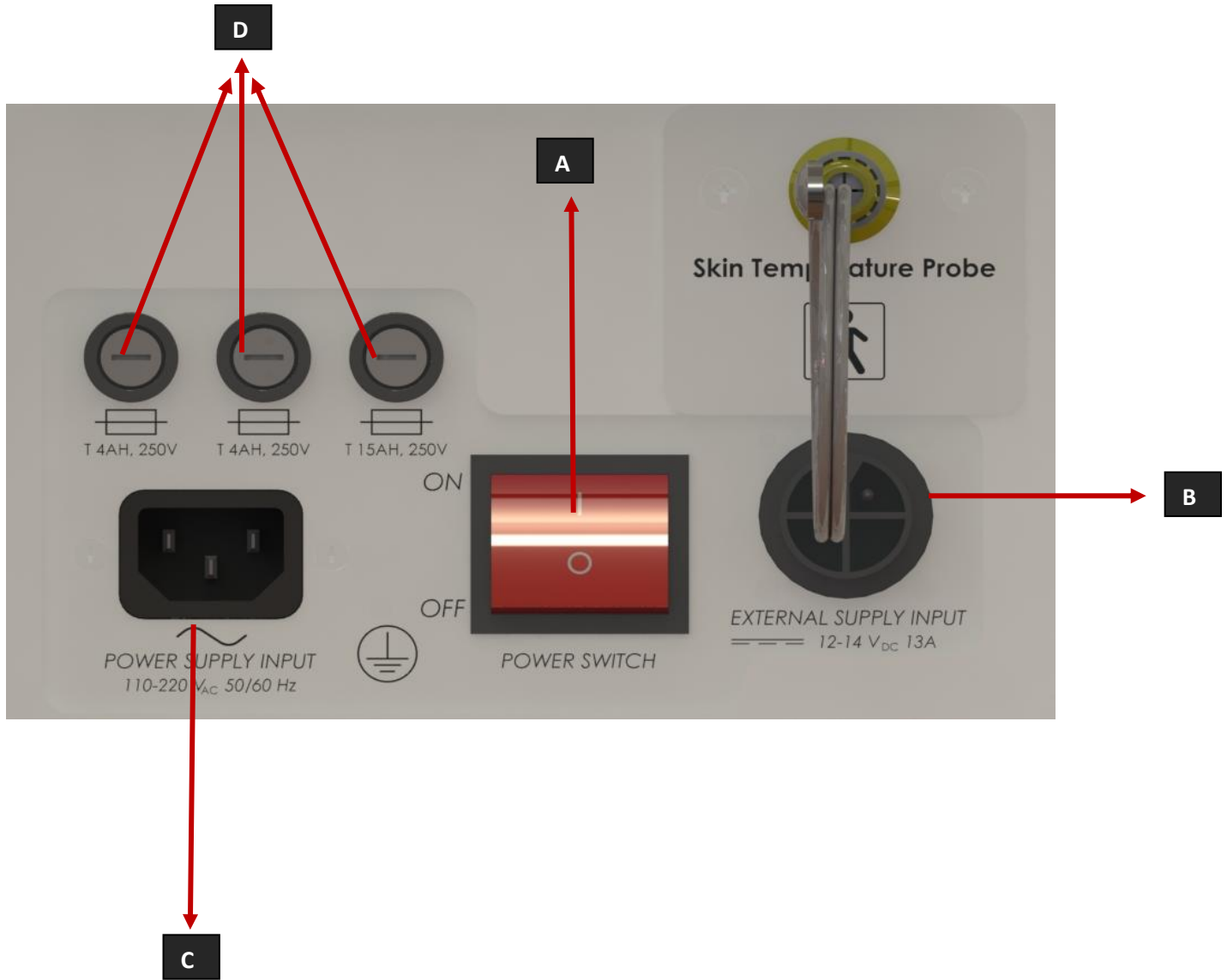

A	Main Power On/Off Switch	C	IEC C14 power input
B	External DC power socket	D	Fuse holders

4.2. Overview of KT-1000 Infant Transport Incubator

KT-1000 Infant Transport Incubator is used to transport newborns that are at high risk, premature, have a low birth weight, or are critically ill. The infant transport incubator contains tools for air temperature control, oxygen supply and addition of relative humidity. The double-walled hood allows full visualization and forms an effective thermal and sound barrier for the environment. Access panels allows access from the front, rear and end sides. The bed can be withdrawn from the head end (left side) to provide a further access to infant. There are tube access grommets at either side of front access panel and at head end access panel. There are two gas cylinder housings for cylinders in E or D length. Furthermore, the system contains an integrated examination light that can be controlled on the control panel. The incubator is designed to be operated on sinus- or square-wave AC power supply / network. In addition, the incubator can be operated by the on-board lighter port with external voltage of 12 V_{DC} or by the battery with internal voltage of 12 V_{DC}. Whenever the device is connected to AC voltage supply and every time the **Main Power On/Off Switch** is set to “**ON (I/ON)**” position, the battery will be automatically recharged. There is a comprehensive visual and acoustic fault alarm system including **Battery Level Display Screen** and a test function that confirms appropriate alarm process. Optionally, the incubator may be attached to a variable height-adjusted trolley. Other optional accessories include the high hood, pressure regulator, flow meter, IV Pole and accessory shelf.

4.3. Description of Operation

A power-operated air circulation system controls the temperature and humidity. A motor-driven propeller draws a limited amount of room air through an air aspiration filter. This propeller draws fresh air that has passed through the filter into the incubator, and performs circulation much faster than the clean gas entry. The air is delivered through the humidity chamber. If humidification is required, the optional humidity pad should be dampened and placed in the humidity chamber. When the access panel is closed, the air enters the patient chamber through the holes located on the left side of patient chamber. After the circulation inside the patient chamber, this air circulates towards the right side of chamber, passes through the temperature sensor and returns to the propeller. The transport incubator is designed to be operated by one of three power supplies. Three power supplies are used in this sequence: If external AC power is not available, the incubator will switch to external DC power. If the external DC power is not available, it will switch to the built-in battery. The battery will only be recharged if the device is operated on an external AC power supply.

4.4. Temperature Control

The incubator temperature is controlled by a temperature sensor located on the circulating airway and by a proportional control circuit that determines the required heater output to maintain incubator temperature. The control unit **Heater Level Display Screen** displays the supplied relative heat amount. The incubator temperature can be maintained between 20 °C and 39 °C via the temperature controls located on the control unit. The temperature is measured by a sensor located inside the housing and the measured temperature is compared with the set value. The control circuit receives information from this sensor to equalize the heater output in order to achieve the set value. The temperature is displayed on the control unit. The set value is set to a temperature of 36 °C ± 0.15 °C, and the incubator will be heated in accordance with this temperature unless the set value is changed. The control “**Adjust Temperature**” located on the control unit sets the set value to the given temperature. An additional sensor located in the housing functions as a support to maintain maximum temperature of incubator at 39 °C ± 0.5 °C. At this limit, the **High Temperature** alarm will be activated and the heater will be switched off.

4.5. KT-1000 Control Unit

The KT-1000 control unit consists of control buttons, displays and indicators.

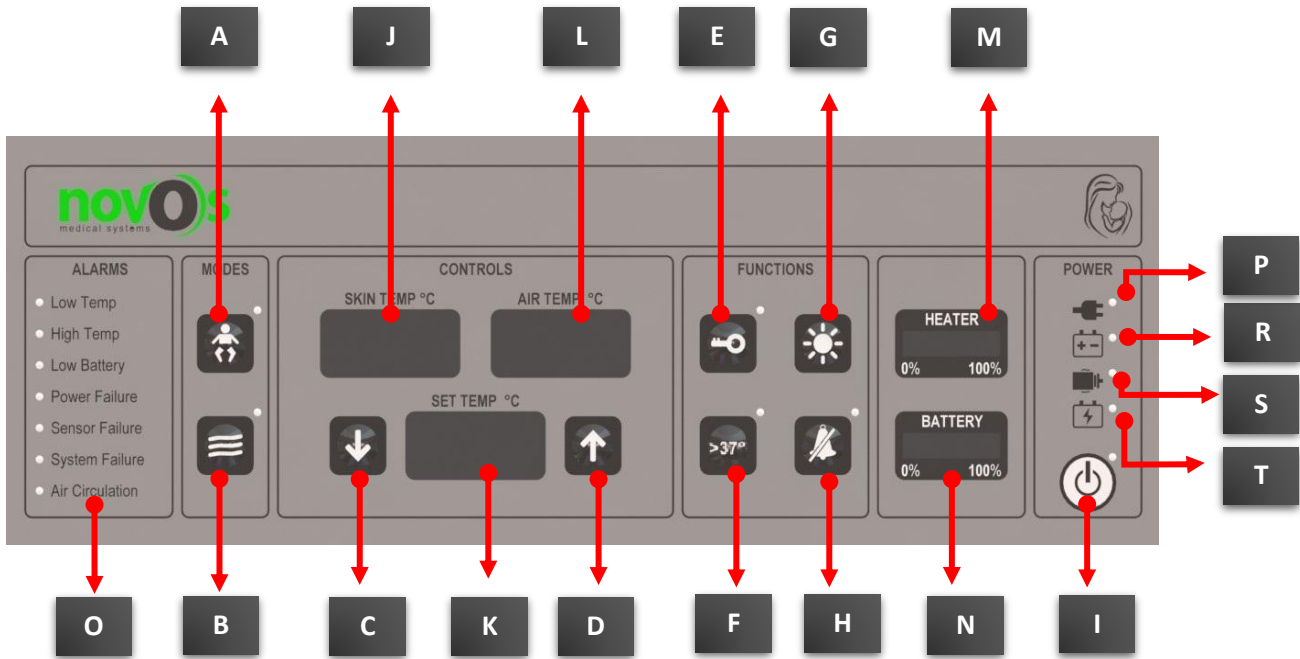

4.5.1. Buttons

A	Skin Mode Button
B	Air Mode Button
C	Down Arrow Button
D	Up Arrow Button
E	Keypad Locker Button
F	>37°C Confirmation Button
G	Light Switch On/Off Button
H	Silence/Pause Alarm Button
I	Power On/Off Button

4.5.2. Displays

J	Skin Temperature Display
K	Target Temperature Display
L	Air Temperature Display
M	Heater Level Display Screen
N	Battery Level Display Screen

4.5.3. Indicators

O	Alarms
P	Device is running on AC Voltage
R	Device is running on battery
S	Device is running on on-board lighter
T	Battery recharging

5. Preparation

5.1. Unpacking and Initial Installation

WARNING

Risk for electric shock and malfunction of device

If the device is assembled incorrectly, or it is not reassembled after the parts/assemblies have been cleaned or serviced, then the basic performance and/or basic safety may be disturbed or device may malfunction. Installation and verification of operation must be performed by qualified personnel.

WARNING

Risk for electric shock and malfunction of device

If the device is plugged in a power socket with wrong network voltage or ungrounded power socket, the user may be injured and the device may be damaged. Plug power cable only in a grounded power socket (see Technical Data).

WARNING

Risk for injury to patient and malfunction of device

If the power supplied to device is interrupted, the patient may be injured or the device may be damaged. The incubator must be connected to an appropriate power supply in case power failure may result in an unacceptable risk.

WARNING

Risk for injury or death

Due to weight and complex structure of device, it must be handled and installed by two persons who are physically fit.

NOTE

Exercise care to avoid scratching and damaging unprotected surfaces when unpacking the equipment.

KT-1000 comes with a single box if requested with a transport trolley. When requested with an ambulance stretcher, it comes with two packages.

- Open shipping boxes and remove all packaging materials. Carefully lift the incubator assembly and optional ambulance stretcher out of their boxes.

NOTE

If the packaging or device is damaged, please contact the authorized Novos Service representative.

- Open the front access panel and remove the components.

5.2. Installing the Fuses

The 15A fuse, which is in the consumables box that comes in the device canopy, is inserted into the fuse slot according to the instructions in the package.

1. Remove the fuse holder cap with the help of a slotted screwdriver.
2. Insert the 15A fuse into the socket.
3. Close the fuse holder cover.



5.3. Fastening Incubator onto Trolley

Follow the following steps to fasten the transport incubator onto optional trolley:

WARNING
Do not release the latches that fix the frame or do not lift the trolley until the incubator is installed onto optional trolley. Otherwise, this may result in severe injuries or death.

WARNING
Keep away your fingers from rotating rails and moving parts to avoid injuries. Otherwise, this may result in severe injuries or death.





1. Pull the incubator locking lever to place it in open position.
2. Rotate the incubator assembly such that the access panel on head side faces the height adjustment lock on the trolley.
3. Place the incubator assembly on the alignment pins and make sure that it is completely seated on the pins.
4. Release the incubator locking lever by rotating the latches and fasten the incubator.

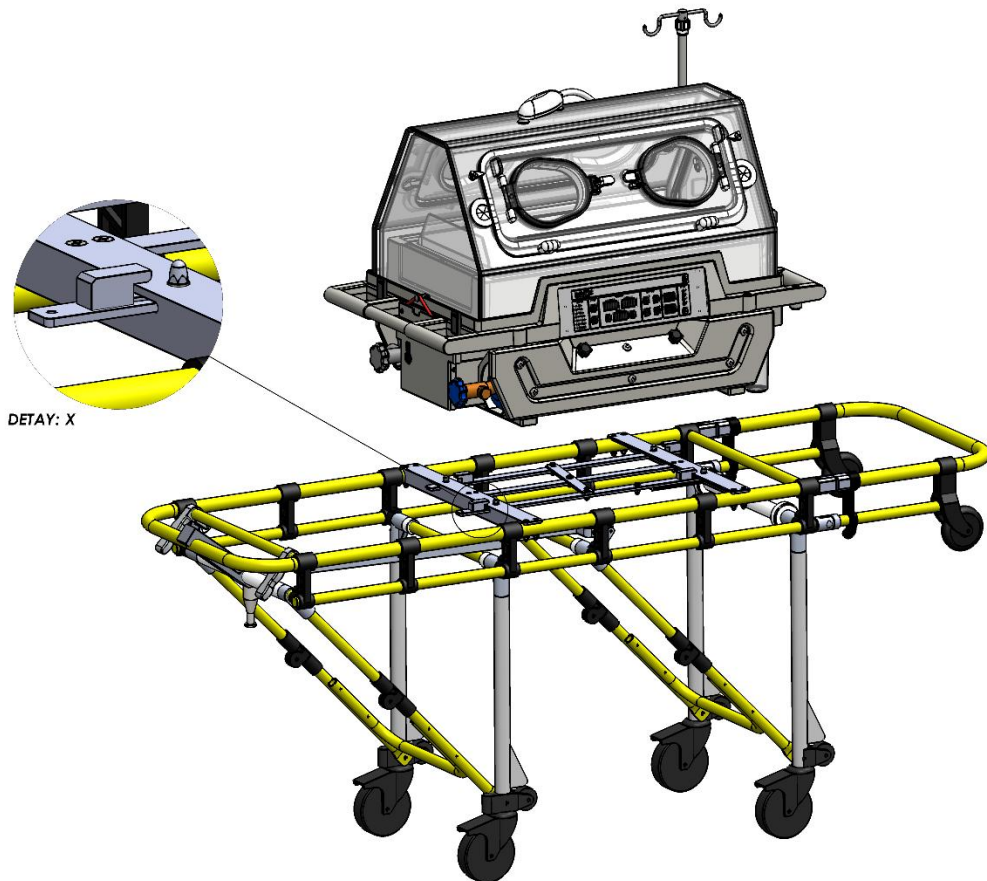

5. Pull the locking levers of frame fixing latches outward to release the frame fixing latches in order to place the locking levers in the locking position as shown in the Figure above.
6. Lift up both ends to make sure that hood/base assembly is firmly fixed.
7. If required, adjust the height of the trolley as described.

CAUTION

To firmly fasten the incubator and the trolley at the lowest position, always engage the frame fixing latches with the locking levers. In addition, properly ground the AC power cable and external DC power cable, wind the cables and hang on the rail using touch and close fastener. Otherwise, this may result in injuries or death.

5.4. Installation of Gas Cylinders

WARNING

A compressed gas cylinder may become a hazardous propelling force if the gas is released quickly due to damage or for other reasons. Firmly tighten the cylinders to avoid movement of or damage to incubator or trolley. Tighten the clamp screw as described to avoid movement of cylinder. Otherwise, this may result in injuries or death.

WARNING

Do not use the cylinders before the vinyl wrap is removed. Never use the E or D length cylinders that do not have a gas output wrap before “slightly tap” on the cylinder valve to remove the residual impurities. For the appropriate method, follow the gas cylinder safety procedures provided by the cylinder supplier. Otherwise, this may result in injuries or death.

1. Before installing the cylinders, make sure that fastening screws have been fully rotated in the counter clockwise direction, and that there are no objects inside the cylinder housing to prevent movement of cylinders.
2. Slide the cylinders into the cylinder housing with valve end positioned on the right side of incubator.
3. Make sure that cylinders are tightly clamped.
4. When adjusting the latch tension, rotate the fastening screw in the clockwise direction to increase the tension, or rotate it in the counter clockwise direction to reduce the tension.
5. Attach an appropriate regulator/flow meter on the cylinder.

5.5. Pre-start Preparation Check

WARNING

Check the continuity of connection between the power panel and the AC plug grounding pin before the device is started. Otherwise, this may result in severe injuries or death.

WARNING

To make sure reliability of grounding, only plug the AC power cord in a properly grounded, hospital-grade three-wire socket that is suitable for use in hospitals. Do not use any extension cable. If there is any problem with the grounding connection, do not operate / start the equipment. Otherwise, this may result in severe injuries or death.

CAUTION

Make sure that building power supply conforms to electrical properties on the device. Otherwise, this may result in injuries or damage to device.

1. Connect the one end of AC cable to the AC power input on the power panel and plug the other end in the wall socket.
2. Set the **Main Power On/Off Switch** to “**OPEN (I/ON)**” position. The indicator “**Device is running on AC Voltage**” will be lit on the control unit. If the battery is not fully charged, the indicator **Battery is recharging** will be lit. The **Switch On/Of Button** is lit red.

NOTE

During operation on DC power, if the device is switched on, the indicator **Device is running on AC Voltage** will not be lit.

3. To switch on the incubator, press the **Switch On/Of Button** on the control unit. Then a self-test will be initiated for 3 seconds. After the self-test is completed, follow the complete functional check procedure.
4. After the functional check procedure has been completed successfully, select the required system settings, parameters and operating modes using the buttons located on the control unit.

Use the functional check procedure before the first start-up of device and after disassembly of device for cleaning or maintenance purposes.

WARNING

During the functional check procedure, under no circumstances operate the device if it is detected that device does not function as designed. Call the authorized personnel when service is required. Otherwise, this may result in severe injuries or death.

NOTE

For devices with accessories attached, remove all the accessories that prevent check procedure and attach them back in position after completion of procedure.

NOTE

Perform the check procedure with incubator connected to AC power supply, an external power supply, or built-in batteries. For the following procedure, the incubator is connected to an AC power supply.

5. Perform the first start-up procedures.

WARNING

The self-test checks the LED indicators and displays by simulating the functional failure of corresponding alarm sensors. At the end of the testing cycle, do not operate the incubator if all of the indicators are not lit or the acoustic alarm does not sound for a short period of time. Otherwise, this may result in severe injuries or death.

6. Press the **Switch On/Off button** on the control unit. The device will run a self-test for around 3 seconds:

- The device will play a start sound.
- The number “eight” [8.8.8.] will be displayed on all of the **Air Temperature, Skin Temperature and Target Temperature** displays.
- All the bars are illuminated on the **Heater Level Display Screen** and **Battery Level Display Screen**.
- All the indicators located on the **Alarm, Mode, Function** and **Power** parts are illuminated.

Then, the information on the software version is displayed on the screen for approximately 2 seconds.

- At the end of the self-test sequence:
 - The indicators **Device is running on AC voltage, Switch On/Off Button (green)**, and the indicator **Battery is recharging** (if the battery is not fully charged) will remain illuminated.
 - One or more bars may remain illuminated on the **Heater Level Display Screen** and **Battery Level Display Screen** depending on the incubator temperature and the level of battery charge. The bars on the **Battery Level Display Screen** that are not illuminated steadily (i.e., blinking) indicate that corresponding part of the battery is recharging.
 - The indicator of one of the **Skin / Air Mode** buttons will be illuminated depending on the last mode in which the device was operated.
 - If there are no alarms/faults other than **Low Temp**, this will be assumed as preheating and the indicator of button **Silence/Pause Alarm** and its function will be activated for 15 minutes in the **Skin Mode** and for 30 minutes in the **Air Mode**.
 - Depending on the selected mode, if the difference between the **Skin / Air Temperature** and the **Target Temperature** is greater than 9°C, the air circulation fan will operate at high speed until these two temperature values are equal, i.e., until the device is ready for operation. Please wait for the completion of preheating to place the patient into device.
 - If there is no Fault status, the device will be put on keypad locker after 60 seconds and the indicator of **Keypad Locker** button will be illuminated.

7. Perform the adjustment procedure for the control set value.

- If the device is put on the keypad locker, press the **Keypad Locker** button and make sure that indicator on the button is off.
- Press the **Skin Mode** button or the **Air Mode** button in order to select the required operating mode.
- Use the **Down Arrow Button** or the **Up Arrow Button** to set the target temperature. The **Target Temperature** can be
Between 34.0°C and 38.0°C for the **Skin Mode**, and between 20.0°C and 39.0°C for the **Air Mode**.
- If it is required to set the target temperature above 37.0 °C for both of the modes, hold down the **Up Arrow** button until 37.0 °C is displayed on the **Target Temperature** indicator. Then, press the **>37°C Confirmation Button** once to continue increase.

8. Review the temperature control.

- With all the access doors closed, allow the incubator to heat up to the set value of 34.0 °C.
- When the Air Temperature indicator is stable, the number of illuminated bars of Heater Level Display Screen will not be more than two in general.
- After the temperature balance is achieved, make sure that Air Temperature indicator remains at set value of 0.5 °C for a period of 15 minutes.

9. Make sure that examination light properly functions.
 - Make sure that examination light is gradually increased by pressing 3 times the Light Switch On/Off button located on the control panel. The light must be off when you press this button for the fourth time.
 - Switch off the light when the device runs on the battery power in order to extend the life of batteries.
10. Inspect the operation of batteries. Disconnect the AC power cable to make sure that incubator switches to battery power from the AC power. Check that device is still running and maintains the set point, and the indicator **Device is running on Battery** is illuminated.
11. Check the **Power Failure** alarm.
 - This indicator will be illuminated when the resistor relay is left withdrawn, when the power board fuse is not available/is tripped, or when the battery voltage falls below 10 VDC at full load.
12. Check the **Low Temp/High Temp** alarms.
 - If the difference between the value of Target Temperature and the temperature value in the selected mode is less than ± 1.0 °C, it is not expected to provide these alarms. Set the value of Target Temperature out of corresponding range using the Down Arrow Button and Up Arrow Button in order to observe and test the Low Temp/High Temp alarms on the control panel.

NOTE

After the **Target Temperature** is set, only the visual alarms will be activated for the first 15 minutes in the **Air Mode** and for the first 5 minutes in the **Skin Mode**, but the acoustic alarms will not be activated

NOTE

During testing, the actual temperature of incubator may not be correlated with the **Air Temperature** indicator.

- Press the Switch On/Off button on the control panel to switch off the incubator, and place the Main Power On/Off Switch on the “Off (O/OFF)” position if it is not required to recharge the battery.

NOTE

The **Switch On/Off Button** on the control unit only interrupts the power supplied to the control unit. Place the **Main Power On/Off Switch** on the “Off (O/OFF)” position to disconnect the incubator and AC power connection.

13. Inspect the latches and grommets on the oval window located on the front access panel.
- Press the latch (A) on each hood and make sure that hood is properly opened.
 - Check that grommets (B) are properly installed on the openings.
 - Close the hoods and make sure that they are properly locked.

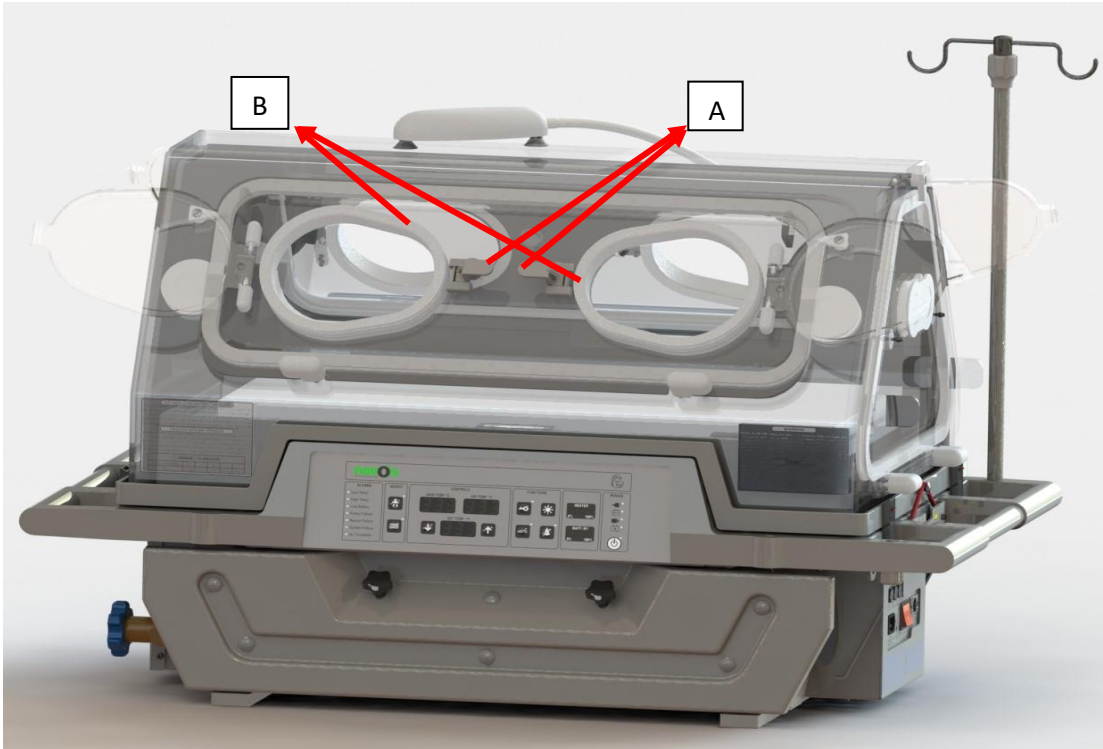

14. Inspect the front access panel.

- Turn the access panel locking knobs upward to completely open the access panel (A).
- Close the access panel (A).
- Rotate the locking knobs until they are completely locked. The locking knobs must be completely locked to prevent access panel (A) from opening accidentally.



15. Inspect the head end access panel and bed.

- Rotate the locking knob on the head end access panel to completely open the access panel.
- Slide the bed out of the incubator until it reaches the mechanical stopping point.
- Make sure that bed is stable when a prolonged partial force is applied.
- Make sure that restraining straps are in good condition and push back the bed into the incubator.
- Close the head end access panel and put the locking knob on vertical position to lock the access panel.

16. Check that four base latches (A) and two canopy latches (B) are properly fastened.

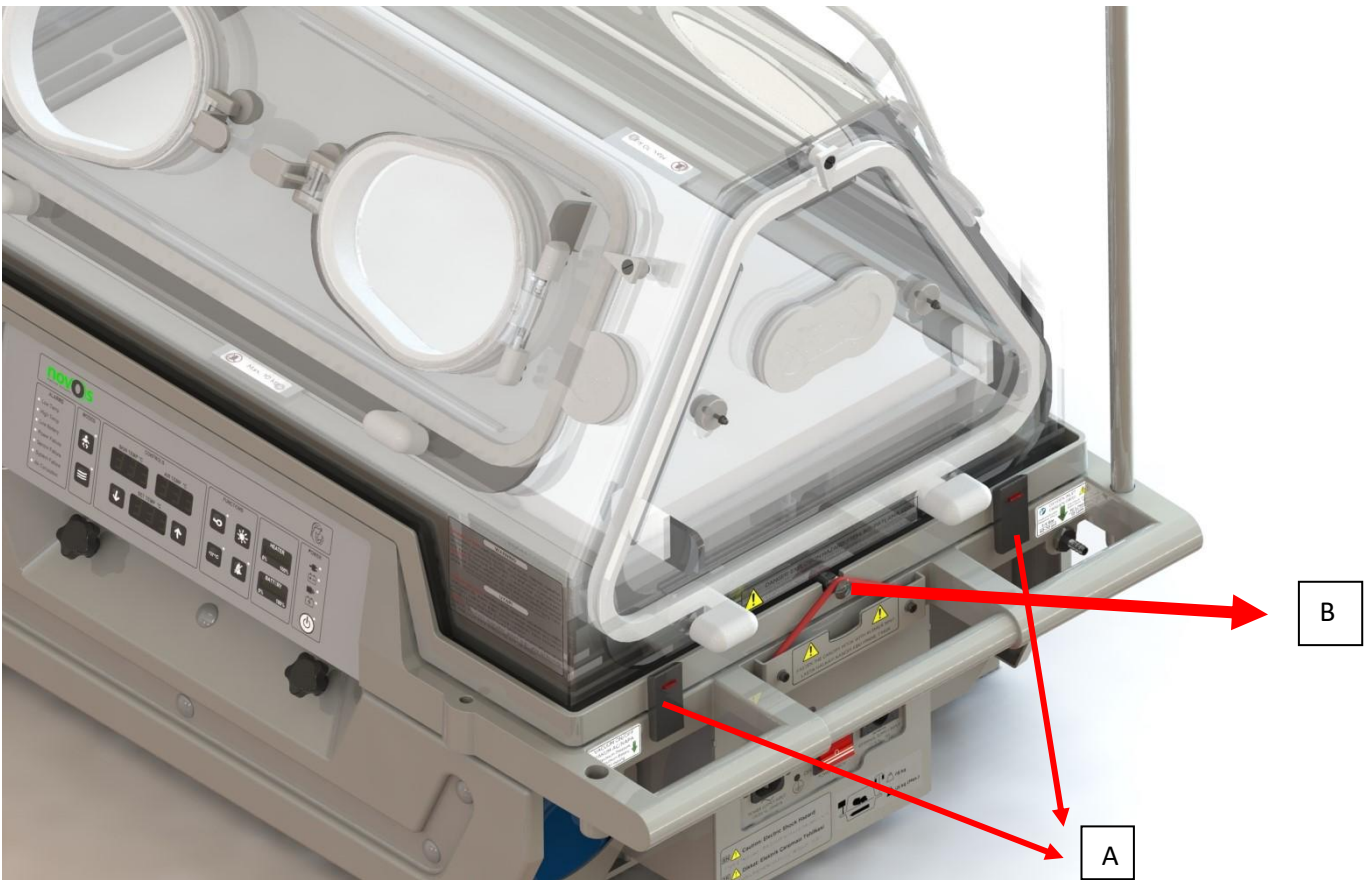

17. Check the condition of air aspiration filter.

- Unscrew the screws (A) on the side of the air intake filter cover and remove the cover.
- Remove the filter.
- If there is visible dirt on the filter, replace the filter.

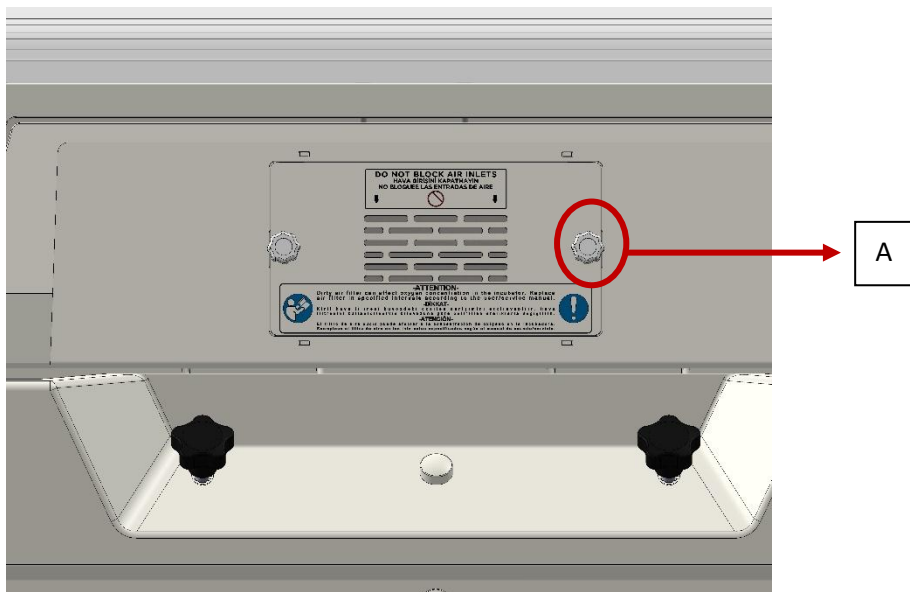

18. After the functional check procedure is completed successfully, connect the transport incubator to an AC power supply and place the **Main Power On/Off Switch** on **“ON (I/ON)”** position on the control panel to fully recharge the battery.

5.6. Functional check procedure for trolley

WARNING

For the safety reasons, two persons must bear the whole weight of incubator when lowering or lifting the trolley. Until the weight is completely supported, do not unlock the height adjusting lock. Otherwise, this may result in severe injuries or death.

WARNING

Do not unlock the frame fixing latches or do not lift the trolley until the incubator is installed onto the optional trolley. Otherwise, this may result in severe injuries or death.

WARNING

Keep away your fingers from rotating rails and moving parts to avoid injuries. Otherwise, this may result in severe injuries or death.

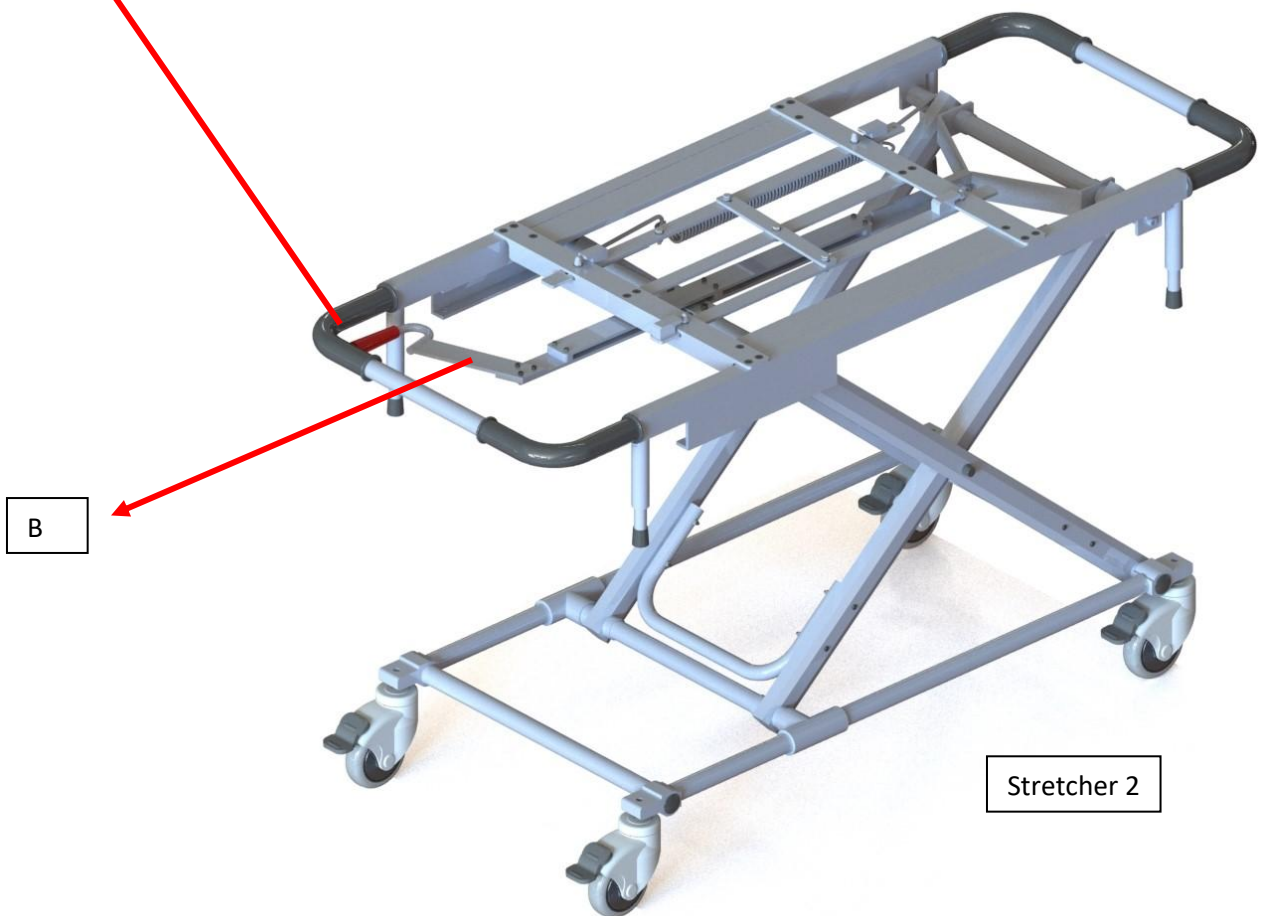
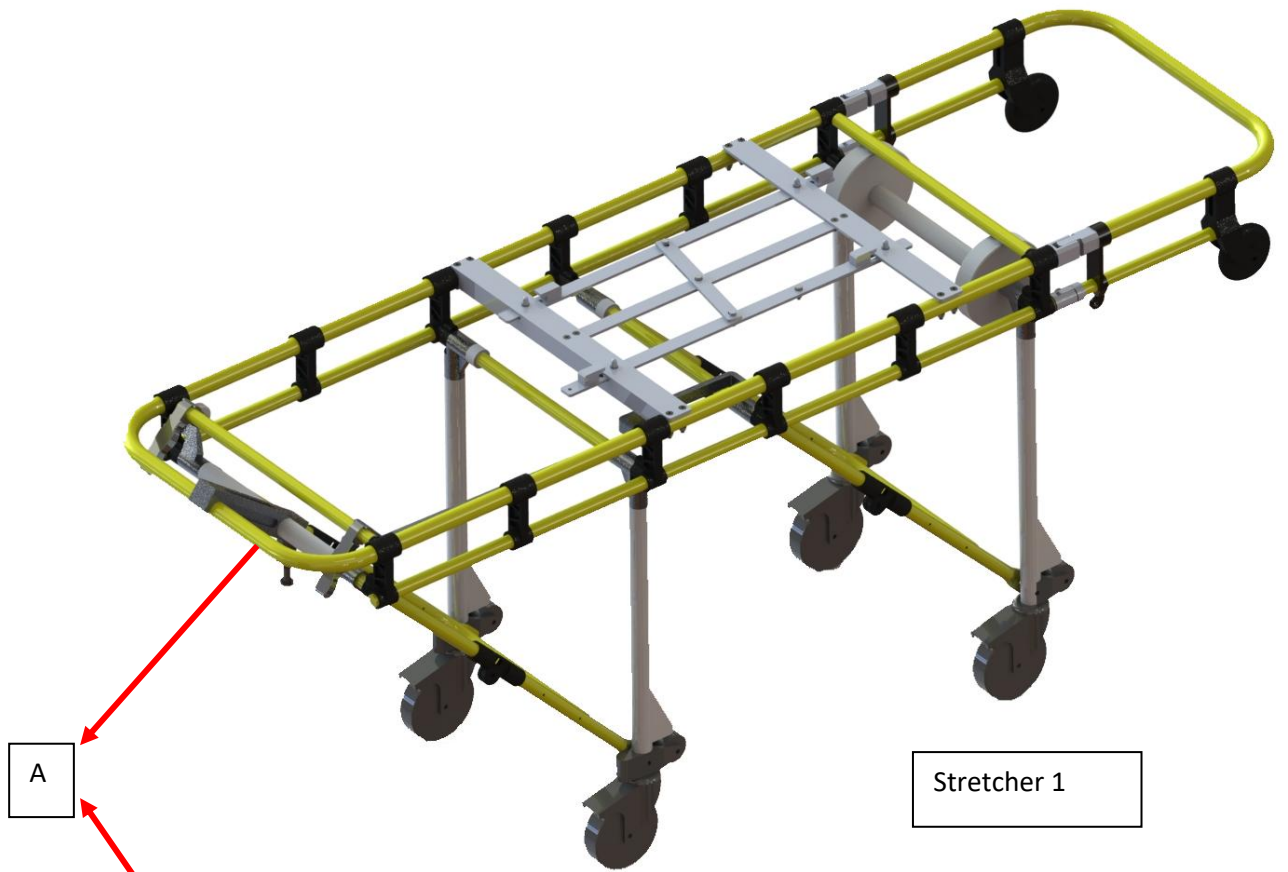

Make sure that optional trolley functions properly and is set to an appropriate height:

1. Use a person at each end and instructs them to firmly hold four corners of trolley's upper frame (A) with palms facing upward.
2. Slightly lift the height adjusting latch (B) to take its weight and then pull the latch outward on the lever by fingers of your left hand to unlock the latch (***Only stretcher 2 has an height adjustment***).
3. Lift or lower the trolley to the desired height.

WARNING

Completely support the weight of incubator until the height adjusting lock is firmly engaged in the desired position. The gas springs located on the trolley will assist when supporting the weight. If you fail to completely support the weight of incubator, this may result in severe injuries or death.

4. Continue to slightly lift / lower the trolley until the height adjusting lock (B) is engaged.

WARNING

For the stretcher 1, pulling the locking lever will cause device to fall down except for loading onto ambulance.

NOTE

You will hear a "click" when the height adjusting lock is engaged.

6. Operation of Device

6.1. General Precautions for Operation

WARNING

Do not start the incubator if functional check procedure is not performed. Do not operate the incubator if the self-test sequence is not performed as described. Otherwise, this may result in severe injuries or death.

WARNING

Do not remove the hood with cables or cylinders connected to newborn to prevent causing harm to newborn. It is not necessary to open the hood at any time when care is delivered to newborn in the incubator. You may use the access panels to access the newborn. Otherwise, this may result in severe injuries or death.

WARNING

The incubator has a *High Temperature* alarm. If the newborn is directly exposed to sunlight or other radiating heat sources, this may result in overheating of newborn before the alarm can sound. Do not position the incubator to directly absorb the sunlight or other radiating heat sources. Otherwise, this may result in severe injuries or death.

WARNING

Misuse of incubator may cause harm to newborn. The incubator may only be operated by properly trained personnel under the observation of a doctor who is aware of currently known risks and benefits. Otherwise, this may result in severe injuries or death.

WARNING

To prevent incubator from toppling over unexpectedly at the time of transport when the trolley is put at a higher position, do not exceed the loading limit of 6.8 kg for the accessory shelf. If an oxygen cylinder is used, attach this cylinder to the chamber under the control unit, and always push and pull the incubator (by the edges) forward/backward on a straight line along the trolley. Lateral or angular movement (along the width) may cause wheels to face any obstacles and this may result in unexpected toppling over. Otherwise, this may result in severe injuries or death.

6.1.1. Preheating

1. Preheat the incubator to the recommended temperature during the treatment as prescribed by the doctor or in accordance with care protocol.
 - Preheat the incubator when the incubator is connected to an external AC power supply before it switches to battery mode in order to ensure maximum use of batteries during transport.
 - Place the **Main Power On/Off Switch** on "**ON (I/ON)**" position on the power panel.
2. Completely recharge the battery before you use the incubator for transport.
3. Unless humidification is recommended, operate the incubator with no water in the humidity pad during the preheating process.

6.1.2. Self-test

WARNING

The self-test checks the LED indicators and displays by simulating the functional failure of corresponding alarm sensors. At the end of the testing cycle, do not operate the incubator if all of the indicators are not illuminated or the acoustic alarm does not sound for a short period of time. Otherwise, this may result in severe injuries or death.

19. Press the **Switch On/Off Button** on the control unit. The device will run a self-test for around 3 seconds:

- The device will play a start sound.
- The number “eight” [8.8.8.] will be displayed on all of the **Air Temperature, Skin Temperature and Target Temperature** displays.
- All the bars are illuminated on the **Heater Level Display Screen** and **Battery Level Display Screen**.
- All the indicators located on the **Alarm, Mode, Function** and **Power** parts are illuminated.
- Then, the information on the software version is displayed on the screen for approximately 2 seconds.
- At the end of the self-test sequence:
 - The indicators **Device is running on AC voltage, Switch On/Off Button (green)**, and the indicator **Battery is recharging** (if the battery is not fully charged) will remain illuminated.
 - One or more bars may remain illuminated on the **Heater Level Display Screen** and **Battery Level Display Screen** depending on the incubator temperature and the level of battery charge. The bars on the **Battery Level Display Screen** that are not illuminated steadily (i.e., blinking) indicate that corresponding part of the battery is recharging.
 - The indicator of one of the **Skin / Air Mode** buttons will be illuminated depending on the last mode in which the device was operated.
 - If there are no alarms/faults other than **Low Temp**, this will be assumed as preheating and the indicator of button **Silence/Pause Alarm** and its function will be activated for 15 minutes in the **Skin Mode** and for 30 minutes in the **Air Mode**.
 - Depending on the selected mode, if the difference between the **Skin / Air Temperature** and the **Target Temperature** is greater than 9°C, the air circulation fan will operate at high speed until these two temperature values are equal, i.e., until the device is ready for operation. Please wait for the completion of preheating to place the patient into device.
 - If there is no Fault status, the device will be put on keypad locker after 60 seconds and the indicator of **Keypad Locker** button will be illuminated.

6.1.3. Temperature setting

WARNING

The temperature setting must always be determined by the authorized doctor. Regularly check the patient temperature in accordance with instructions of authorized doctor or Care Guidelines. Otherwise, this may result in severe injuries or death.

Adjustment of temperature:

- If the device is put on keypad locker, press the **Keypad Locker button** and make sure that indicator on the button is off.
- Use the **Skin Mode / Air Mode** buttons to select the required operating mode.
- Use the **Down Arrow Button** and **Up Arrow Button** to set the target temperature.
- If it is required to set the target temperature above 37.0 °C for both of the modes:
 - Hold down the **Up Arrow** button until 37.0 °C is displayed on the **Target Temperature** indicator. Then, press the **>37°C Confirmation Button** once to continue increase.
- Review the temperature control.
- Allow the incubator to heat up to the **Target Temperature** with all the access doors closed. When the **Air Temperature** indicator is stable, the number of illuminated bars of **Heater Indicator** will not be more than two in general.

6.1.3.1. PCLCS operating principle

A program used in PCLC allows to enter values and to process the difference between the entered value and the read value to maintain the heater, and the heated air heats up the incubator and increases the patient's body temperature to the desired level (the patient's body temperature is maintained constant at that temperature).

After the device is started, skin temperature is set via the buttons on the front panel. The temperature value entered is evaluated by the PCLC located in the Motherboard to process it as necessary. The data from the skin sensor and the entered value will be evaluated by the software to process it as necessary.

If the entered value is greater than the read value because of evaluation, the PCLC will transmit an operating signal to the heater resistor. If the read value is greater than the entered value because of evaluation, the PCLC will switch off the heater resistor. If the read value is +1 greater than the required value, the safety board will be activated as the device is considered to have a problem, and the entire operation will be shut down. Meanwhile, the read value and the entered value will be continuously evaluated in the PCLC and Motherboard. If it is detected that there is a failure in PCLC, the safety board will be activated again, and the entire operation will be shut down. An alarm signal will be activated based on the difference between the read value and the entered value.

6.1.4. Placing the infant

WARNING!

Place a disposable biocompatible cover on the baby mattress before treatment is started.

WARNING

Before the infant is placed in the incubator, preheat the incubator to the recommended temperature as prescribed by the treating doctor or in accordance with care protocol. Otherwise, this may result in severe injuries or death.

1. Preheat the incubator.
2. Rotate the access panel locking knob and open the front access panel.
3. Place the infant in the middle of the bed.
4. Fasten the infant by the restraining straps.
 - Pass the straps over the infant and slightly press the ends against each other.
 - Tighten the straps but pay attention not to tighten them excessively.
5. Close the access panel and make sure that locking knobs are completely seated in position.

WARNING

For the safety of newborn, do not keep the access panels opened longer than necessary. The *Air Temperature* indicator does not reflect the actual temperature of incubator when the access panels are opened. Under these circumstances, the incubator temperature may be significantly lower than the displayed temperature. Failure to observe this warning may result in severe injuries or death.

6.1.5.Placing the skin temperature sensor

WARNING

Never place the skin temperature sensor underneath the infant, or never insert it into the rectum. Otherwise, this may result in severe injuries or death.

CAUTION

Never attempt to clean and reuse the single-use components. Otherwise, this may result in injuries or damage to device.

1. Connect the connector of skin temperature sensor to the skin temperature sensor housing on the power panel. Insert the sensor through the grommets into the canopy.
2. Rotate the access panel locking knobs and open the front access panel.
3. Before the sensor is placed on the skin, thoroughly clean and dry the skin area to place the sensor.
4. Place the sensor on the infant.
 - If the infant lies on its back or is put on its side, place the sensor on the abdominal section in the center of xiphoid and umbilicus.
 - If the infant is placed in prone position, place the sensor on the back of the infant.
5. Attach the sensor to the infant using a retaining washer.
 - Remove the rear part of the retaining washer and attach the sensor.
 - To fasten the attached sensor, place another retaining washer on the sensor lead, 3 cm to 4 cm away from the sensor end.
6. Close the access panel and make sure that locking knobs are completely seated in position.

WARNING

For the safety of newborn, do not keep the access panels opened longer than necessary. The *Air Temperature* indicator does not reflect the actual temperature of incubator when the access panels are opened. Under these circumstances, the incubator temperature may be significantly lower than the displayed temperature. Failure to observe this warning may result in severe injuries or death.

7. To make sure that sensor is correctly attached, check the condition of infant at least every 15 minutes and touch the skin of infant to verify whether there is a sign of overheating.

6.1.6. Use of humidity

If the treating doctor requires further humidification, follow the steps below:

1. Open the head end access panel until it reaches a position to face downward on the guarding rail.
2. Slide the bed out until it reaches the mechanical stopping point.
3. Open the front access panel to pour water on the humidity pad.
4. Dampen the humidity pad with 500 mL of sterile distilled water.

WARNING

Risk for injury and damage to equipment

Do not add more than 500 mL of distilled water to the humidity pad in one go. A soaking process provides minimum 12 hours of humidity.

5. Push back the bed into the incubator and close the head end and front access panels.

NOTE

The same humidity pad may only be used on one patient. The humidity pad is included to increase the relative humidity within the incubator canopy. The level of relative humidity achieved in the incubator is affected by the ambient relative humidity. The humidity in the hood will exceed 50% RH by adding water (500 ml) to the pad and at 23 °C and 35% RH.

NOTE

If the temperature inside the incubator is very higher than the ambient temperature, the inner side of hood may become misty. When there is a very small difference between the incubator and care unit temperature, no mist will be generated. However, this indicates that temperature difference is not high enough to generate mist not that incubator is properly humidified.

6.1.7. Variable height adjustment of trolley

UYARI

For the safety reasons, two persons must bear the whole weight of incubator when lowering or lifting the trolley. Until the weight is completely supported, do not unlock the height adjusting lock. Otherwise, this may result in severe injuries or death.

WARNING

Do not release the latches that fix the frame or do not lift the trolley until the incubator is installed onto optional trolley. Otherwise, this may result in severe injuries or death.

WARNING

Keep away your fingers from rotating rails and moving parts to avoid injuries. Otherwise, this may result in severe injuries or death.



1. Use a person at each end and instructs them to firmly hold four corners of trolley's upper frame (A) with palms facing upward.
2. Slightly lift the height adjusting lock (B) to take its weight and then pull the lock outward on the lever by fingers of your left hand to unlock the lock.
3. Lift or lower the trolley to the desired position.

WARNING

Completely support the weight of incubator until the height adjusting lock is firmly engaged in the desired position. The gas springs located on the trolley will assist when supporting the weight. If you fail to completely support the weight of incubator, this may result in severe injuries or death.

4. Continue to slightly lift/lower the trolley until the height adjusting lock (B) is engaged.

NOTE

You will hear a "click" when the height adjusting lock is engaged.

6.1.8.Operation of examination light

1. Use the **Light Switch On/Off Button** on the control unit to set the examination light to the desired stage of 3 stages. Turn of the light between operations to extend the battery life.

NOTE

The light will not work if the battery tray is not installed and the **On/Off switch** on the controller is not set to the **ON (Green Light)** position. If not set, the light will not work.

2. Turn off the light between operations to extend the life of battery.

6.1.9. Use of power supply

- In order to use maximum capacity of battery during transport, operate the device on an external power supply to bring the incubator temperature to the desired level before you switch to battery power. Operate the incubator using an external power supply as much as possible.
- Please follow the steps below to operate the incubator on battery power:
 - Completely disconnect the external power. In this case, the battery will automatically switch to battery power.
 - The **Low Battery** alarm will be activated when the battery indicator falls below 2 bars (20%). In this case, put the device on an alternative power supply as soon as possible.
 - After the **Low Battery** alarm is activated, use battery power at minimum level unless there is an emergency.

WARNING

After the **Low Battery alarm** is activated, if the battery continues to be used, **Air Circulation and Power Failure alarms** are activated, respectively. In this case, deterioration occurs in the air circulation and heating system of the device. This situation involves risk for the patient. An alternative power source is urgently needed. Otherwise, the responsibility will belong to the user.

NOTE

With a fully charged battery, the device will run at fully charged for at least 240 minutes without the **Low Battery Alarm** triggering. For longer periods of use, the device will not turn itself off until the battery is completely empty, but the battery will not be able to be fully charged again. The full charge time of the battery is 6 hours. It may vary by ± 30 minutes depending on weather conditions and battery life. It offers over 4 hours of battery life when fully charged.

NOTE

Any vehicle used for the transport of incubator must have an appropriate AC or DC power supply.

NOTE

Continued use with the battery after the **Low Battery alarm** will adversely affect battery performance and result in more frequent battery replacement.

NOTE

Novos recommends that incubator remains connected to an AC power supply for the battery to be fully recharged during the transport.

6.1.10. Transport of infant

- 1.1 Continue to heat up the incubator to a temperature of 35 °C as long as AC power supply is on.
- 2.1 Make sure that infant is restrained in the incubator compartment.
- 3.1 Remove the power cable from the power supply. Wind up and fasten the cable.
- 4.1 Fasten the device on the transport vehicle (ambulance) using a method specified for each type of vehicles.
- 5.1 Plug one end of external DC power cable to the external DC power socket located on the KT-1000 power panel and connect the other end to the transport vehicle (ambulance).

Alternatively, if the transport vehicle contains an AC power supply, connect one end of AC power cable to the C14 power port on the KT-1000 power panel, and connect the other end to the wall socket in the transport vehicle.

WARNING

Do not use the on-board lighter in the ambulance as a terminal point for appropriate external DC voltage. The ambulance cable to the terminal point must be minimum 10 AWG (5.27 mm²) and shot as much as possible. Otherwise, this may result in injuries or damage to device.

6.1.11. Use of accessory shelf

WARNING

To ensure that incubator remains stable, total weight of optional accessory shelf must not exceed 6.8 kg. If one oxygen cylinder is used, insert it into the front cylinder housing. Otherwise, this may result in injuries or damage to device.

6.1.11.1. Lowering the shelf

1. Place the shelf on top of the incubator and attach the locking pin to the side of the shelf.
2. Make sure that suction cups are attached to the hood and the shelf is fastened.

6.1.11.2. Lifting the shelf

1. Remove all the equipment on the shelf.
2. Remove the locking pin on the side of the shelf.
3. To release the suction, hold the suction cup straps and lift the shelf.
4. Make sure that shelf can be grabbed by hand.

6.1.11.3. Use of shelf connecting straps

To use the strap:

1. Place the equipment on the shelf ensuring that equipment is visible and easily accessible.
2. Make sure that strap is not twisted and then bring the strap over the equipment (for example, patient monitor).
3. Lift the locking latch and pass the strap end through the hole in the locking latch.
4. Hold the locking latch and pull the corresponding strap tensioner to relief any stress. Pull the lever to tighten the strap.
5. Lock the strap lever in the straight position for the transport purposes.
6. Periodically check the connecting straps to make use that connecting straps are tight and the monitor is not moving.

To release the strap:

- i. Open the lever.
- ii. Push the release rod forward and place the lever in (fully open) position.
- iii. Remove the strap through the hole.

WARNING

Protect the strap from the sharp edges and heat. If the strap is cut or worn, replace it with the new one. Otherwise, this may result in injuries or damage to device.

- iv. If the strap is cut or worn, replace it with the new one.

6.1.12.Adjustable Vacuum Unit (Optional)

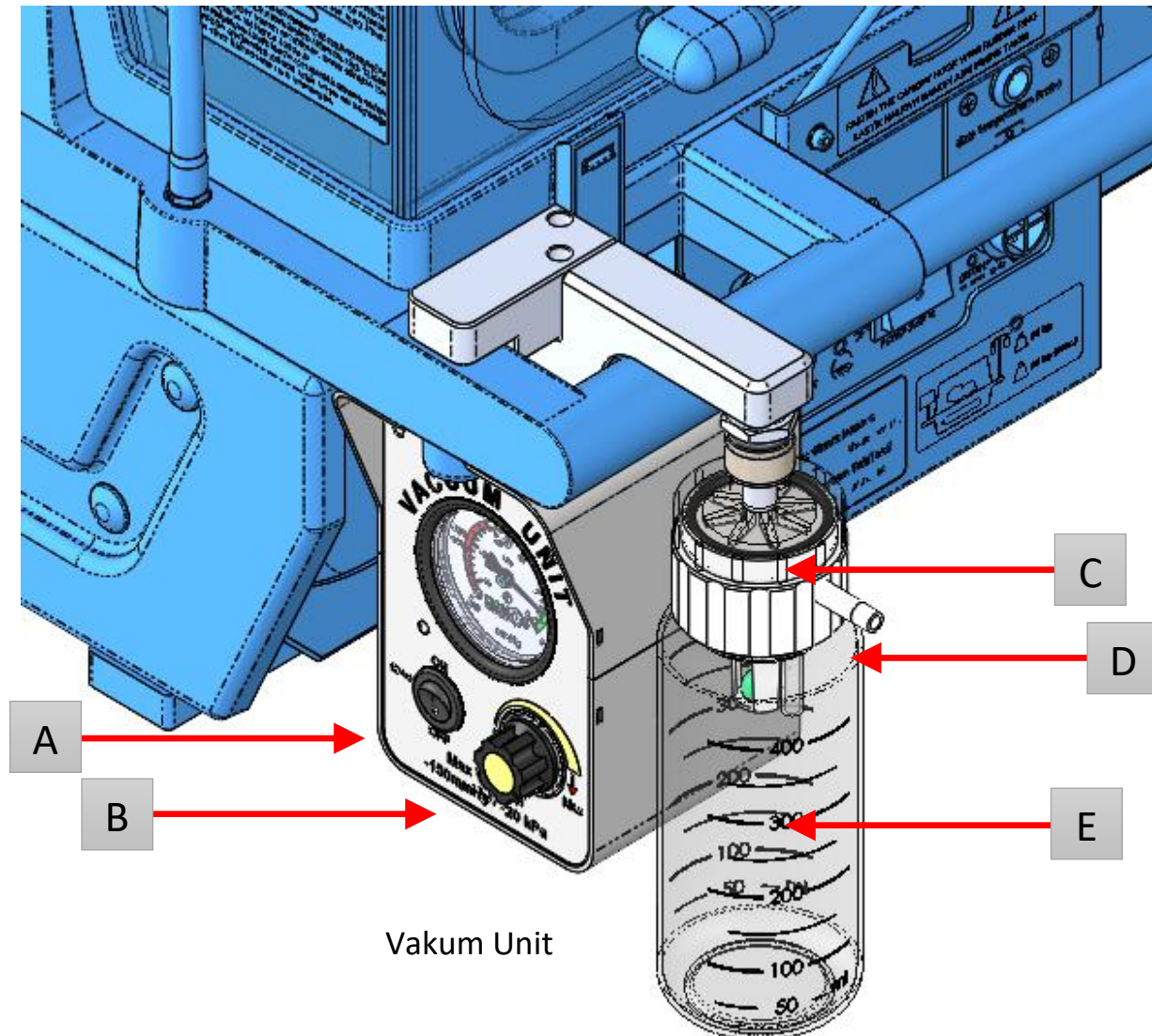

**A: (I/O) Switch On/Off Button, B: Adjustment Knob, C: Filter Lid,
D: Jar (Collection Container), E: Input Connection**

ATTENTION

Suction at vacuum levels higher than -200mbar (-150mmHg) may cause injury.

Suctioning sensitive skin and tissues may cause injury.

6.1.12.1. Using the adjustable vacuum unit

1. Verify that collecting bottle (measuring jar) is connected and it is empty.
2. Check that vacuum circuit is clean and one of its ends is connected to the measuring jar. The hose of vacuum circuit must have an inner diameter of minimum 6mm and length of minimum 1.3 m. The hose must have enough strength to withstand collapse under the vacuum.
3. Check that the filter on the measuring jar is clean and undamaged.
4. Check that connections are made tight.
5. Check that incubator is functional.
6. Press the **Switch On/Off Button (I/O)** of Vacuum Unit to start it.
7. Frequently observe that liquid from the vacuum circuit is collected into the measuring jar.
8. Turn the adjustment knob (in the Min. or Max. direction) to increase or decrease the vacuum power.
9. When the measuring jar is full, the plug in the measuring jar will automatically cover the vacuum hole and suction of liquid will be stopped although pump is in operation.
10. Press the **Switch On/Off Button (I/O)** of Vacuum Unit to switch off the unit. Loosen the nut on the measuring nut by hand and remove the jar together with the filter lid.
11. Twist, loosen and open the lid between the full jar and the filter. Empty the jar and clean it appropriately.
12. Install back the empty jar with filter lid, tighten the upper nut well by hand, and check that connection is made properly.
13. Press the **Switch On/Off Button (I/O)** of Vacuum Unit to restart it and check that liquid from the vacuum circuit is collected into the measuring jar.
14. When the vacuum process is completed, press the **Switch On/Off Button (I/O)** of Vacuum Unit to switch it off.
15. Properly clean the contaminated equipment. The filter is disposable, therefore, replace it with new one.

WARNING

Risk of injury or death

When the collection container is full, the liquid suction stops even if the vacuum pump is running. Check the level of the collection container frequently.

Although the collection container is not fully filled, if the liquid suction is not performed, the hoses may be clogged or displaced. Check hoses and connections frequently.

6.1.13. Shut down of system

1. Set the pressure regulators on the cylinders and flow meter to the close position.
2. Press the **Switch On/Off Button** to switch off the control unit.
3. Set the **Main Power Switch On/Off Button** on the power panel to **OFF (O/OFF)** position.

7. Routine Cleaning and Maintenance

7.1. Cleaning and Disinfection

Safety Information

WARNING

Risk for infection

The users and service personnel may be infected by pathogenic germs. Clean and disinfect the device or the device parts before the maintenance activities, returning the device for repair and restarting device.

WARNING

Risk for injuries or death

Use any cleaning materials as recommended by the manufacturer.

WARNING

Risk for injuries or death

When cleaning and maintenance activities are carried out in an environment that is rich in oxygen, there is a risk for fire and explosion. When performing cleaning and maintenance procedures, make sure that oxygen supply is cut off and equipment is disconnected from the oxygen supply.

CAUTION

Risk for damage to equipment

Do not allow device to be exposed to excessive humidity.

Disassembly

CAUTION

Risk for injury and damage to equipment

Prior to disassembly, remove the accessories attached to device.

CAUTION

Risk for damage to equipment

Do not use strong cleaning materials such as rubbing pads and heavy-duty grease removers, or solutions such as toluene, xylene and acetone.

CAUTION

Risk for damage to equipment

Make sure that metal platform is dry before inserting the bed into the incubator.

For routine cleaning, it is not required to remove the hood/base assembly from the trolley.

- Disconnect the device from the power supply.

Oval window seals and grommets

1. Open the oval window covers (A) on the front access panel and remove the front cover grommets (B).
2. Put cover grommets aside.

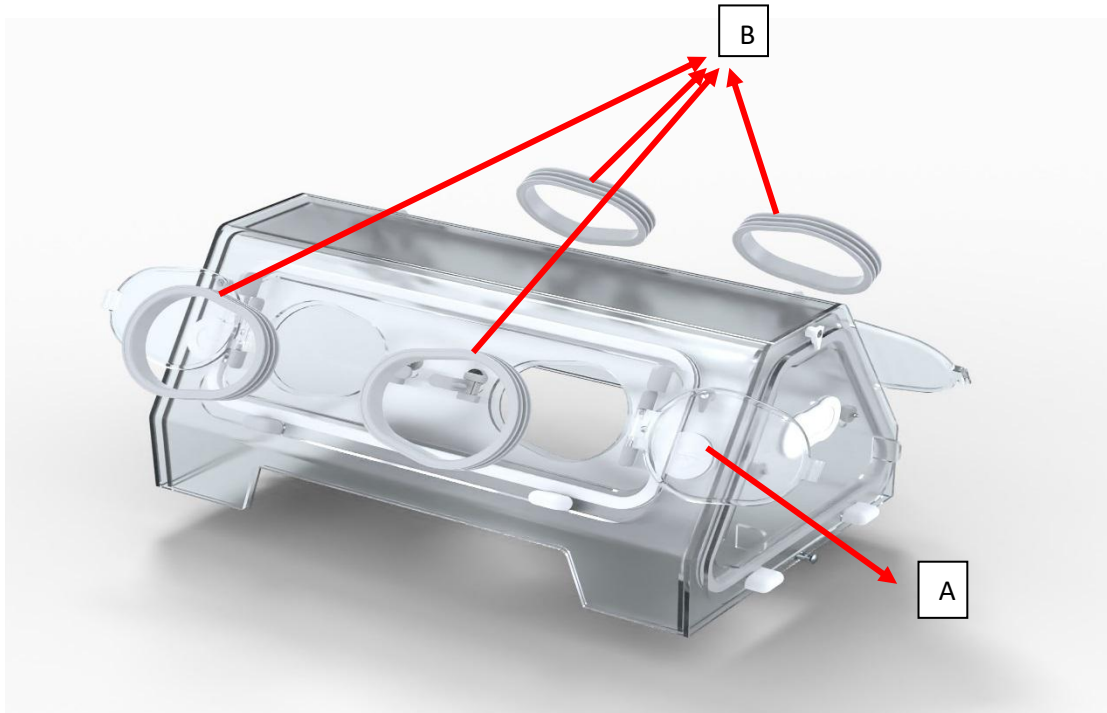

3. Close the oval window covers.
4. Open the front access panel and head end access panel until they reach a position to face downward on the guarding rail.

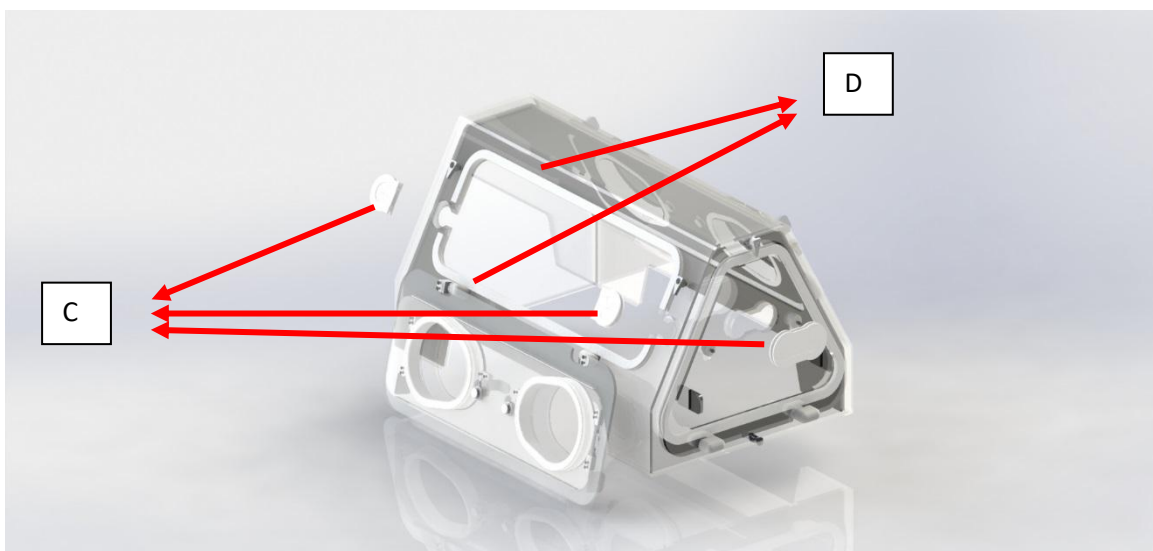

5. Remove all the grommets (C) and edge seals (D) on the front access panel and put them aside.

Bed

1. Open the head end access panel and pull the bed out until it reaches the stopping point.
2. Remove the mattress on the bed.
3. Press the bed stopper (A) and remove the bed from the upper base.
4. Put the bed aside.

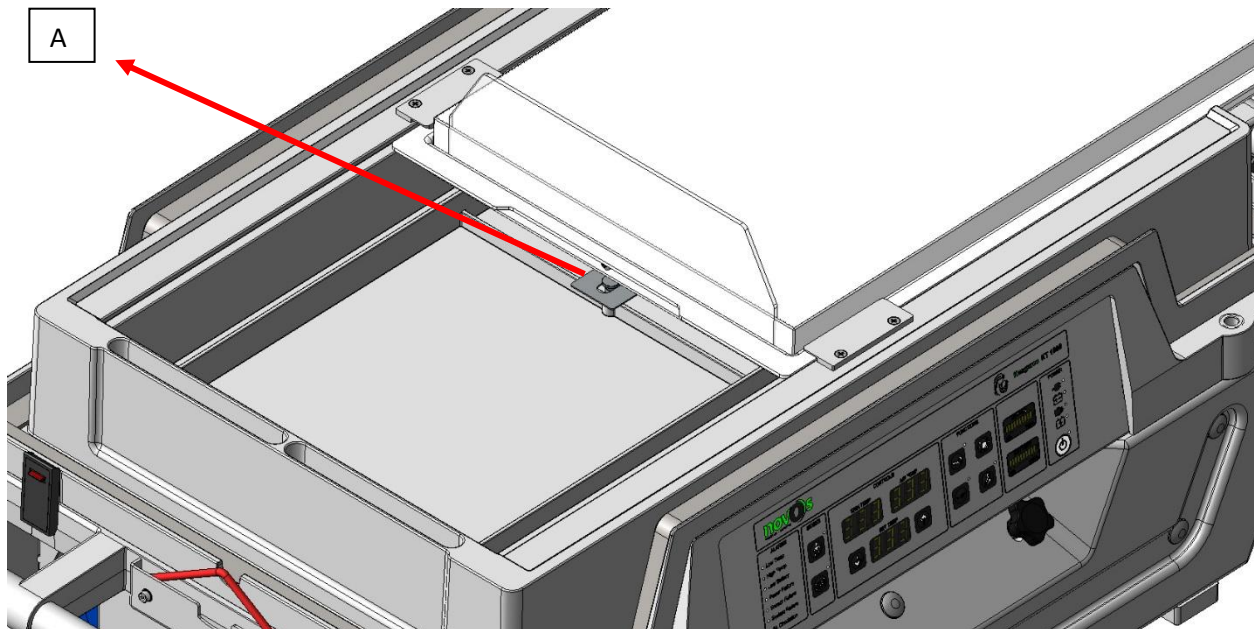

Hood

1. Close and lock the access panels.
2. Loosen the rubbers that hold the canopy and remove the canopy from the housing.
3. Pull the examination light to the side over the canopy.
4. Unlock four hood latches located on the front side and rear side of the incubator.
5. Lift up the outer hood completely and put it aside.

Upper base

CAUTION

Risk for injury or damage to equipment

Unexpected movement of upper base may cause damage to or disturb the air temperature sensor assembly.

1. If possible, unlock and withdraw four base latches on the head end and foot end of the incubator.
2. Lift up the upper base and put it aside.

Reprocessing procedures

Novos recommends cleaning the device with detergent and warm water. Do not use excessively liquid or aggressive cleaning agents. Do not use alcohol-based agents to clean the acrylic materials, otherwise, the surface will be discolored.

Novos recommends using standard domestic cleaning agents and a soft wire brush to remove stains or to clean areas that are difficult to reach. Initially, you may need to soften the dirt to remove the heavy and dried solid dirt.

Generally, it is not necessary or not required to sterilize any component of transport incubator. Cold liquid sterilization may be used.

CAUTION

Risk for damage to equipment
Do not put the device in an autoclave.

After you have cleaned all the solid substances and dirt on the removed parts, refer to cleaning procedures provided for each part.

Classification of medical devices

For reprocessing purposes, the medical devices and components are classified by the types of applications and the risks arising from specific applications:

– Non-critical medical devices: e.g., device surfaces, and surfaces such as cables that are accessible by the user and patient

Testing procedures and materials

–The following procedures and materials are used to test the cleaning and disinfection of medical products: The following procedures and materials have displayed a good material compatibility and efficiency during testing:

Non-critical medical devices

Manual disinfection and simultaneous cleaning

Preferably, use aldehyde or quaternary ammonium compounds-based disinfection agents for the manual disinfection. Follow the country-specific disinfectant list to select the appropriate disinfectant.

Strictly follow the manufacturer’s instructions for use of disinfectants. The composition of disinfectants may vary. Procedure:

1. Immediately wipe off the dirt with a disinfectant-impregnated cloth.

WARNING

Risk for electrical shock or malfunction of device

Any liquid that can penetrate into device may result in malfunction of device or cause damage to device and risk for patient. Disinfect the device surfaces and cables by rubbing and wiping. Avoid penetration of liquids into the device.

2. Disinfect the surfaces (disinfection by rubbing and wiping).
3. Remove the residual disinfectant following contact period.
4. Thoroughly rinse and dry the device before it is restarted.

Lower Base

WARNING

Risk for severe injury

The heating radiators may be so hot that it may cause burns. Avoid touching heating radiators until the device is cooled down for minimum 30 minutes.

- Remove any lint on the heating radiators (A), air temperature sensor (B), fan propeller (C) and adjacent surfaces.

CAUTION

Risk for damage to equipment

Do not allow device to be exposed to excessive humidity

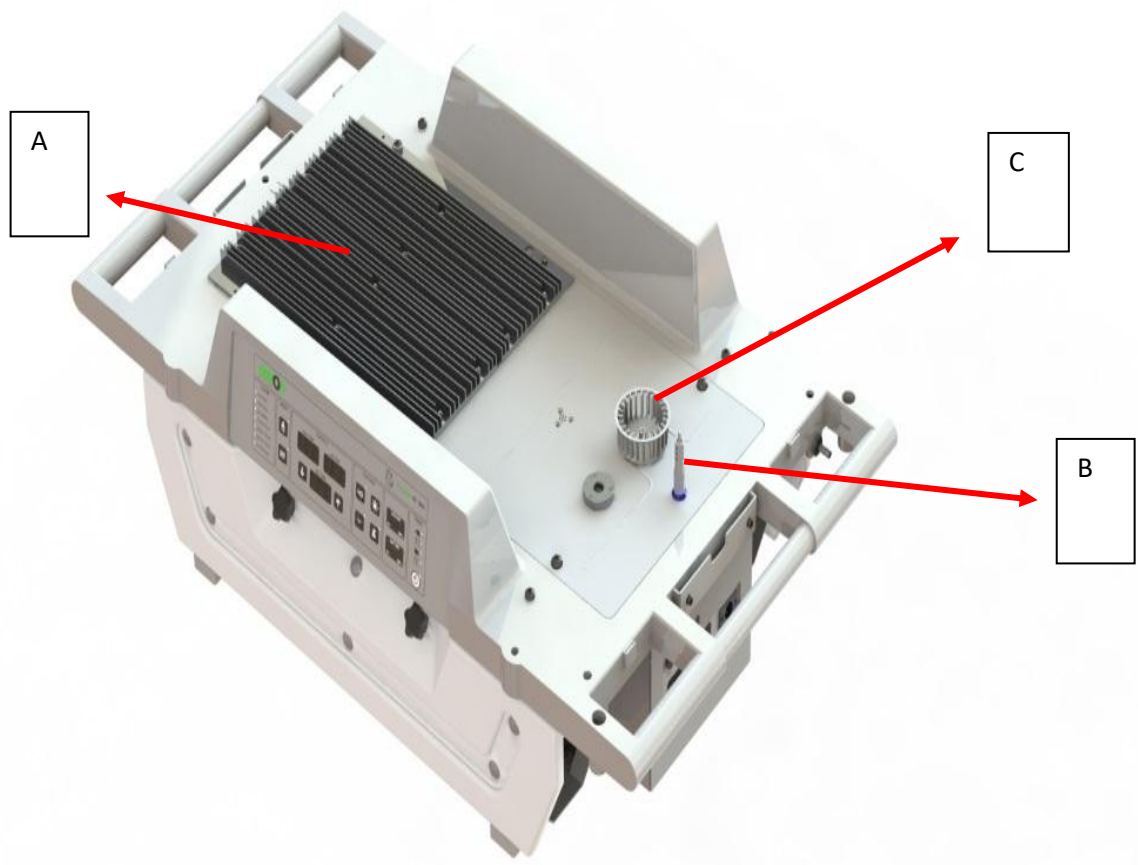

Hood

CAUTION

Risk for damage to equipment

Avoid hood assembly to be directly exposed to the radiation emitted by the germicidal lamp. The ultraviolet radiation emitted by such sources may cause seals to crack, painting to come off and transparent acrylic hood to scratch.

CAUTION

Risk for damage to equipment

The acrylic may be impaired by the alcohol. Do not use alcohol, acetone or any other organic solvents for cleaning.

- Clean all the holes, indents, compartment walls etc. on the hood.

Air inlet filter housing and lid

WARNING

Risk for injury or death of patient

A contaminated Air filter may affect the performance or may result in accumulation of carbon dioxide (CO₂). Make sure that filter is periodically inspected according to local conditions and the "Air aspiration filter" is properly replaced. Especially, if the device is installed in a dusty environment, although this is not likely, it may be required to replace the parts more frequently.

CAUTION

Risk for damage to equipment or injury

Do not attempt to clean the air aspiration filter.

Before installing a new air aspiration filter, clean the filter chamber and lid with cleaning agent/disinfectant.

Visual inspection

Inspect all the parts for damage and wear (for example, cracks, brittle, specific hardening or stains).

Upper base

1. Inspect the white rubber seal located on the lower part of upper base to check whether there is a visible damage. Replace the upper base assembly if necessary.
2. Inspect the gray seals on the upper edge of upper base for any potential damage. Replace the upper base assembly if necessary.

CAUTION

Risk due to defective accessories

The service life of reusable accessories is short. For example, residual disinfectant may corrode the material during autoclave process. Replace the accessories if there are external wear signs such as cracks, deformation, discoloration or peeling-off.

7.2. Post-cleaning Reassembly

Reassemble the incubator in the following sequence.

WARNING

Risk for death or severe injury

If the device is reassembled wrongly, or the parts/assemblies are not reassembled after cleaning or maintenance, the basic performance and/or basic safety or device may be impaired. The assembly and functional check must be performed by the qualified personnel.

CAUTION

Risk for damage to equipment

When lowering the upper base onto the lower base, exercise caution to avoid damage to air temperature sensor.

1. Align the air temperature sensor with the hole on the upper base.
2. Lower the upper base onto the lower base.
3. If possible, secure three base holes located at the head end and foot end of incubator.

WARNING

Risk for injury or death of patient

After cleaning, make sure that you install the fan propeller back to the motor shaft. Otherwise, the heater will be overheated, and this will disable the heater. If the propeller is not installed properly, the oxygen and temperature will be adversely affected. Make sure that fan propeller can be easily rotated.

4. Place the humidity pad (A) (if used) in the humidity chamber.

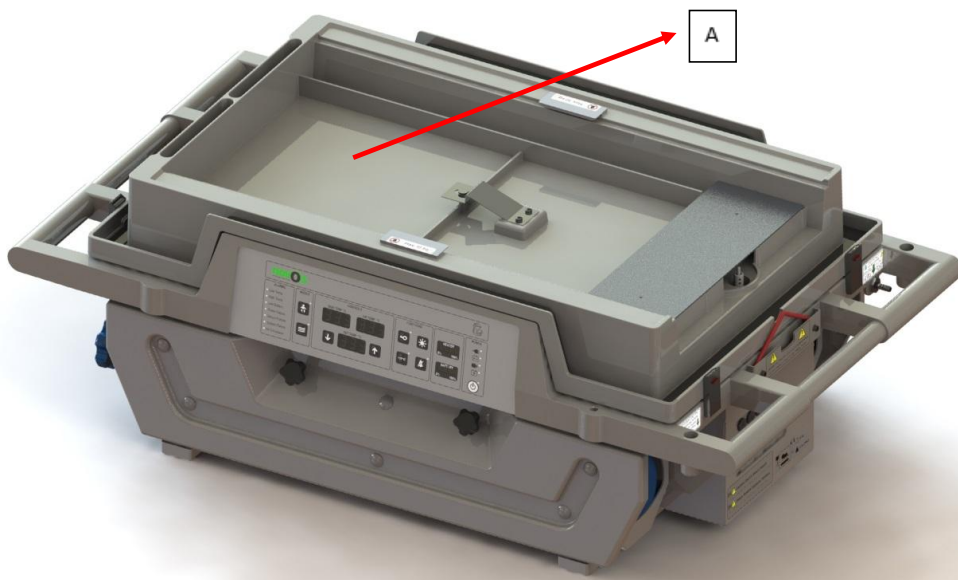

5. Install the inner cover on the upper base and then place the outer cover on the upper base as shown in the Figure.
6. Open the head end access panel.
7. Place the mattress on the bed (mattress cover).
8. Insert the bed through the head (left) side of the upper base.

9. Insert the bed from the underneath of bed retainers and slide it to the right side until it passes the stopping point and stops at the right end of upper base.
10. Lock the hood latches.
11. Open the front and head end access panels of hood.
12. Install an oval window seal on each oval window cover.
13. Pass the strip seals of canopy windows through the ducts on the outer canopy windows depending on the strip length.
14. Place the grommets in the housing on the outer cover.
15. Close and lock the front and head end access panels.
16. Replace the Air filter if it is damaged, visibly contaminated, or has been used for more than three months.
17. Push the Air filter lid until the locking latch is locked.
18. Reinstall the accessories (if any) that were previously removed from the device.
19. Perform the functional check procedure before the first start-up of device, and after disassembly of device for cleaning or maintenance purposes.

7.3. Maintenance

Overview

This section describes the maintenance activities required for the proper operation of medical device. The maintenance activities must be performed by the service personnel.

WARNING

Risk for infection

The users and service personnel may be infected by pathogenic germs. Clean and disinfect the device or the device parts before each maintenance step, and before returning for repair.

Definition of maintenance concepts

Concepts	Definitions
Maintenance	Any activity to maintain the operating condition of medical device and recover (inspection, preventive maintenance, and repair)
Inspection	Any activity to determine and evaluate the actual condition of a medical device
Preventive maintenance	Repeated activities to recover operating condition of a medical device.
Repair	Any activity to recover operating condition of a medical device after a failure

WARNING

Risk for death or severe injury

The patient may be injured if the functional checks are not completed before use. If the incubator is switched off or disabled for cleaning or maintenance purposes, refer to the Functional Checks Procedure and perform functional checks.

NOTE

The patient compartment needs to be inspected periodically by trained personnel to check any sign of failure, and assemblies need to be reinstalled before restarting the device.

WARNING

Risk for electric shock

The components that carry current are located under the hood.

- Do not remove the hood.
- Maintenance activities must be carried out by the service personnel. Novos recommends carrying out such activities by Novos Service.

Inspection

Perform periodic inspections and observe the following technical specifications.

Inspections	Interval	Personnel in charge
Inspection and safety checks	1 year	Service personnel

Safety checks

Safety checks do not replace the maintenance activities prescribed by the manufacturer (including preventive replacement of worn parts).

WARNING

Risk for failure of medical device

If the safety checks are not performed regularly, proper operation of medical device may be negatively affected.

1. Refer to the relevant documents:
 - Operating Manual
2. Test the following functions in accordance with Operating Manual and technical service documents:
 - Holding force of front hand inlets
 - Self-test during start-up of incubator
 - High temperature alarm
3. Check the following functions:
 - Front hand inlets
 - Straps on the cylinders
 - Inner and outer cover
 - Hood clamps
 - Non-approved probes or modifications to device
 - Connection of incubator to trolley

- Battery of incubator
 - Integrity of hood
4. Check that device combination is in good condition:
 - All the labels are complete and readable.
 - There are no visible damages.
 - All the seals and grommets on the patient compartment are in good condition.
 5. Check that all the components and accessories required to operate the device are available using the Operating Manual.
 6. Check the electrical safety according to IEC/EN 60601-1/UL 60601-1 or IEC 62353.
 7. Check the safety functions:
 - Proper operation of all visual and acoustic alarms
 - Incubator temperature monitoring according to IEC/EN 60601-2-20, Section 201.12.1.105

Preventive maintenance

WARNING

Risk for defective components

The device may malfunction because of worn components and material fatigue. To ensure proper operation of all components, it is required to inspect the device and preventive maintenance needs to be performed in specified intervals.

WARNING

Risk for electric shock

Before performing any maintenance activity, disconnect all the electrical connectors and gas connectors from the power supply and gas supply.

The KT-1000 incubator contains a power input module with circuit breakers in the battery and both network lines. The device also contains a three-pole single throw (3PST) that isolates the device from the network when set to "**OFF (O/OFF)**" position. To disconnect the transport system from the network power, completely disconnect the network power cord from the system. Do not place the transport system in a location where it would be difficult to disconnect the network power cord.

Maintenance instructions

Incubator's main batteries

Life of batteries

The factors affecting the service life of a battery include ambient temperature, discharge speed, discharge depth, and how the battery is recharged. In general, the most important factor is the discharge depth. When the battery is recharged 100% on the device, the battery capacity will be reduced by 40% after ~260 recharge/discharge cycle; with 50% discharged after ~550 cycles, and only 30% discharged after ~ 1200 cycles.

When the battery reduces to a voltage of approximately 10.9 Volt (one bar), the system will notify the user of low battery status through the **Low Battery** alarm. If the KT 100 is operated after the **Low Battery** alarm is triggered, the **Power Failure** alarm will be activated at a voltage of 10.0 Volt and the device will fail with error **E6**. The heating power will be shut off, but the air circulation is maintained. If the operation is maintained, the batteries continue to operate until they are unable to supply sufficient power to support the electronic circuit, and then the device will be shut down. The error **E6** will not be removed until the KT-1000 is recharged to a voltage of 11.5 Volt (two bars). The accumulators of battery will be damaged (depth discharge) and may not achieve a full capacity after recharging if the device is still operated after the **Low Battery** alarm. If the system is operated with **Low Battery** alarm activated, perform the battery capacity test. If the battery fails the capacity test, contact Novos Service.

Checking the main battery of incubator

Before the first start-up of incubator and every 3 months thereafter, check the battery condition as described below:

1. If the incubator was not connected to AC power supply for 6 hours before this test, connect the incubator to an AC power supply for full charge with Main **Power On/Off Switch on "ON (I/ON)"** position to recharge the batteries until the indicator **Battery is Recharging** is off.
2. Disconnect the AS power cord when the incubator is in an environment at room temperature, and open all oval window covers.
3. Use the **Light On/Off Button** to turn on the examination light at the brightest level (i.e., the level III).
4. With **Air Mode** selected, press the **Up Arrow Button** to increase the **Target Temperature** to maximum temperature of 39.0°C.
5. If the **Low Battery** alarm is activated before 180 minutes, connect the incubator to AC power supply, recharge the battery for more 6 hours, and repeat the test. If the battery fails the capacity test again, contact the service personnel to replace the accumulators of battery.
6. Recharge the batteries for 6 hours immediately after successful completion of test.

Replacement off incubator battery

1. Lock all the lockable wheels of stretcher or place the device body on another static and nonslip surface to provide protection against toppling over or other hazardous movements.
2. Disconnect the network AC power cord and car lighter cable from the device.
3. Put the **Main Power On/Off Switch on "OFF (O/OFF)"** position.
4. Remove the skin probe from its housing.
5. Remove 4 bolts and washers that hold the power unit cover.
6. Remove the power unit cover.
7. Loosen the screws that fasten all the connectors connected to power card to remove it.

WARNING

Risk for severe injury

Exercise caution when removing the battery compartment due to its weight.

8. Grab the power unit handle and slowly remove the drawer with support of minimum one person.
9. Disconnect the cables from the battery terminals in the following sequence: first from the red (+) and then from the black (-) terminal.
10. Make sure that disconnected cables do not contact the battery.
11. Unscrew the screws to remove the clamp on the battery and tilt it to power panel.
12. Remove the battery. Sort it out according to the local regulations.
13. Install the new battery.
14. Repeat the steps in reverse order.
15. Connect the network AC power cord to the device and set the **Main Power On/Off Switch to "ON (I/ON)"** position on the power panel to start recharging the new battery.
16. Recharge the battery for minimum 6 hours before use.

Air filter

1. Open the Air filter cover by unscrewing the screws.
2. Replace the filter if the air inlet filter is visibly contaminated or it has been more than 3 months after the last replacement.
3. Install the new filter and air inlet filter lid in position and close the hood.

Repair

Novos recommends performing any repair work by Novos Service using only original Novos repair parts.

Calibration

Calibration frequency should be determined by the user according to the frequency of use of the device. Novos recommends that the manometer and control unit in the optional vacuum unit be calibrated once a year.

7.4. Disposal Applications

7.4.1. Disposal of KT-1000

- Consult with certified waste disposal companies for proper waste disposal.
- Follow the applicable laws and regulations.

Battery:

- Consult with certified waste disposal companies for proper disposal and/or recycling of batteries.

7.4.2 Clinical thermometers Disposal

- Dispose of the device according to local waste disposal regulations, or
- Deliver the device to a certified waste disposal company for disposal.

It is your responsibility to ensure recycling of this electronic equipment in accordance with your country's environmental laws and regulations for protection of human health and environment.

8. Troubleshooting

8.1. Alarm Messages

Troubleshooting on the KT-1000 Infant Transport Incubator must only be performed by NOVOS-authorized personnel. Troubleshooting by unauthorized personnel may result in physical injury or damage to equipment. See Table 6-1 to resolve operator problems. If the fault cannot be limited, take the unit out of service and contact the qualified service personnel for service procedures.

Table 6-1

Message	Cause	Action
The indicator “ Device is running on AC Voltage ” is off when connected to AC supply.	The Main Power On/Off Switch is not on “ ON (I/ON) ” position.	Set the Main Power On/Off Switch to “ ON (I/ON) ” position.
	AC power cord is not connected to an appropriate power supply.	Check the external power connection and connect the AC power cord to an appropriate power supply.
	AC fuse is unavailable/tripped.	Insert/replace the corresponding fuse on the power panel.
	Power card fuse is unavailable/ tripped.	Call the service.
The indicator “ Device is running on car lighter ” is off when connected to external DC power supply.	DC power cord is not connected to an appropriate external power supply.	Connect the DC power cord to an appropriate external power supply.
	External DC fuse is unavailable/ tripped.	Insert/replace the corresponding fuse on the power panel.
	Power card fuse is unavailable/ tripped.	Call the service.
Power Failure alarm is activated.	Resistor relay is defective.	Call the service.
	Power card fuse is unavailable/ tripped.	Call the service.
	Battery voltage is unavailable/ insufficient.	Check the battery.
Low Temp alarm is activated.	The target temperature is more than the temperature value in the selected mode by minimum 1° C.	Trained personnel should check the skin temperature/air temperature in the incubator depending on the mode. Make sure that examination windows are closed. Allow for stabilization if they are normal.
High Temp alarm is activated.	The target temperature is less than the temperature value in the selected mode by minimum 1° C.	Trained personnel should check the skin temperature/air temperature in the incubator depending on the mode. Open the examination windows. Allow for stabilization if they are normal.
Low Battery alarm is activated.	Battery voltage is low.	Connect the device to AC power supply.
Air Circulation alarm is activated.	Fan motor is faulty.	Change fan motor.
	Low speed operation of the fan motor due to low voltage (eg Low battery alarm)	Change/check the fan motor wiring.
	Impeller of the fan motor getting stuck or working by rubbing.	Connect the device to an alternative power source.
Sensor Failure alarm is activated.	In the Skin Mode, the Air Probe is removed or short circuit	Correct according to the installation instructions in the technical service manual of the fan motor.
	In the Skin Mode, the Skin Probe short circuit	Check the connection and orientation of Air Probe, replace the probe if they are OK.
	The temperature on the skin probe is less than 1° C or more than 50° C.	Check the connection of skin probe, replace the probe if it is OK.
		Check the skin temperature, open the access panels, if not improved check the

		connection of skin probe, replace the probe if it is OK.
	The temperature on the air probe is less than 1°C or more than 40° C.	Check the air temperature inside the incubator, open the access panels, if not improved check the connection of air probe, replace the probe if it is OK.
	The difference between the values provided by 2 sensors in the air probe is more than ± 1° C.	This may occur during sudden heating and sudden cooling. Use the Main Power On/Off Switch to switch off the device, allow for one minute and restart the device. If not improved, repeat the same steps above.
System Failure alarm is activated.	No communications between the Power Card in the device and the Display Card.	Use the Main Power On/Off Switch to switch off the device, allow for one minute and restart the device, if not improved call the service.

8.2. Error Messages

The following table lists the error codes with prefix “E” in the alphabetical order that may appear on the incubator control unit display. When an error is received, this table helps to find the cause and solution. All the causes and solutions are used in the listed order until the cause of error is completely eliminated. See Table 6-2 for solutions to problems.

NOTE

Press the **Silence/Pause Alarm** button to silence an alarm for 15 minutes in the **Air Mode** and for 5 minutes in the **Skin Mode**. But, error messages cannot be silenced until the error is corrected/device is switched off.

Table 6-2

Error Codes	Cause	Solution
E0	No communications between the Power Card in the device and the Display Card.	Switch off the device first by using the Switch On/Off Button and then by using the Main Power On/Off Switch , allow for one minute and restart the device, if not improved call the service.
E1	Skin probe short circuit or open circuit	Check the connection of skin probe, replace the probe if it is OK.
E2	The difference between the values provided by 2 sensors in the air probe is more than ± 1° C.	Switch off the device first by using the Switch On/Off Button and then by using the Main Power On/Off Switch , allow for one minute and restart the device, if not improved call the service.
	Air probe short circuit or open circuit	Check the connection of air probe, replace the probe if it is OK.
E3	Resistor relay is defective.	Call the service.
	Resistance open circuit	Check resistor wiring and connector. If there is no problem in the connections, measure the resistance omage, if the resistance is open circuit, call the service to change it.

	Thermal open circuit on the resistor	Turn off the device, wait for the resistance to cool down, run it again. Check that the resistor is warming up.
E5	Fuse on the power card is tripped/removed.	Call the service.
POU.FAI.	The device has been switched on by the Switch On/Off Button but has been switched off by the Main Power On/Off Switch .	Switch on the device again by the Main Power On/Off Switch , to properly switch off the device, first press the Switch On/Off Button , and then press the Main Power On/Off Switch .
	When the device is switched on by the Switch On/Off Button , the power connections to Power or Display Card are disconnected/short circuited.	Call the service.

8.3. Alarms

Status	Alarm	Function of Silence/Pause Acoustic Alarm Button	
		In the Air Mode	In the Skin Mode
Low Skin Temperature	Low Temp	Acoustic alarm is silenced for 15 minutes.	Acoustic alarm is silenced for 5 minutes.
Low Air Temperature	Low Temp	Acoustic alarm is silenced for 15 minutes.	Acoustic alarm is silenced for 5 minutes.
High Skin Temperature	High Temp	Acoustic alarm is silenced for 15 minutes.	Acoustic alarm is silenced for 5 minutes.
High Air Temperature	High Temp	Acoustic alarm is silenced for 15 minutes.	Acoustic alarm is silenced for 5 minutes.
Low Battery Level	Low Battery	Acoustic alarm is silenced for 15 minutes.	Acoustic alarm is silenced for 5 minutes.
Supply/power/fuse problem (See Tables 1-6, 1-7)	Power Failure	Acoustic alarm is silenced for 15 minutes.	Acoustic alarm is silenced for 5 minutes.
Air or Skin temperature at critical level (See Tables 1-6, 1-7)	Sensor Failure	Acoustic alarm is silenced for 15 minutes.	Acoustic alarm is silenced for 5 minutes.
Communication/Operational Problem	System Failure	Acoustic alarm cannot be silenced	Acoustic alarm cannot be silenced
Air Circulation Problem	Air Circulation	Acoustic alarm cannot be silenced	Acoustic alarm cannot be silenced
Alarm Limits		±1,0°C	±1,0°C

9. Annexes

9.1. Technical Specifications

9.1.1.Environmental Requirements

Operating Temperature	10°C-30°C
Operating Humidity	5-95% RH, non-condensing
Storage Temperature	-20°C- 60°C
Storage Humidity	5-95% RH, non-condensing

9.1.2.Mechanical Features

9.1.2.1. Transport Incubator with Ambulance Stretcher

Height (with ambulance stretcher)	1430 mm Max. / 850 mm Min.
Bed Height (with ambulance stretcher)	1154 mm Max. / 574 mm Min.
Width (with ambulance stretcher)	1930 mm
Length (with ambulance stretcher)	563 mm
Wheels	2 wheels with brake / 2 wheels without brake
Wheel Diameter	Ø150
Total Weight with Ambulance Stretcher	100 kg
Standard Model Weight	70 kg

9.1.2.2. Transport Incubator with Trolley

Height (with trolley)	1472 mm Max. / 1152 mm Min.
Horizontal Height (with trolley)	1196 mm Max. / 876 mm Min.
Width (with trolley)	550 mm
Length (with trolley)	1380 mm
Wheels	4 wheels with brake
Wheel diameter	Ø125 mm
Total Weight with Trolley	98 kg
Standard Model Weight	70 kg

IP Class	IP 20
Bed Dimensions	322 x 637 x 35 mm
Bed Weight Capacity	10 kg
Canopy Height	380 mm
Canopy Width (Inside)	437 mm
Canopy Depth (Inside)	716 mm
Extendable Bed Platform	It can be opened outwards by 40%.
Number of windows	4 pcs – Front / Back cover
Number of Covers	3 pcs
Dismountable Canopy	Yes
Air Filter Type and Pore Size	Single use, 0.5 µ
Transport Trolley	Ambulance Stretcher / Transfer Stretcher

9.1.3.Electrical Properties

Supply Voltage and Current	110V-220V VAC / 3.2A @110VAC- 1.4A @220VAC
-----------------------------------	--

Applied Parts	Type BF
Protection Class	Class 1
Fuse	2 x 4A, 1 x 15A Porcelain Fuses
Supply Frequency	50 – 60 Hz
Maximum Power Rating	350 W
Noise Level	<47 dBA
Resistor Type	Silicone Resistor
Resistor Power Rating	120 W
Leakage Current Rating	<100 μ A

9.1.4. Sensor Features

Skin Temperature	Skin Probe Type	Single NTC
	Skin Temperature Measurement Range	1,0°C - 50,0°C
	Skin Temperature Display Range	1,0°C - 50,0°C
	Skin Temperature Display Resolution	0,1°C
	Skin Temperature Measurement Precision	\pm 0,2°C
	Target Skin Temperature Range	34°C- 38°C
	Secondary Skin Probe	No
Air Temperature	Air Probe Type	Double NTC
	Air Temperature Measurement Range	1,0°C - 50,0°C
	Air Temperature Display Range	1,0°C - 50,0°C
	Air Temperature Display Resolution	0,1°C
	Air Temperature Measurement Precision	\pm 0,2°C
	Target Air Temperature Range	20°C-39°C

9.1.5. Humidity Properties

Humidification Type	Passive (Soaked Sponge)
----------------------------	-------------------------

9.1.6. Other Features

Display of Heater Power Percentage	In segments of 10%
Warm-up Period	<30 minutes at AC, 25°C to 36°C (at 25°C ambient temperature)
Air Flow Rate	<0,1 m/s, <10 cm/s
Max. CO2 Concentration	<0,5 vol%
>37 °C Confirmation Button	Yes

9.1.7. Aksesuarlar

- Reusable Skin Probe
- Disposable Skin Probe
- Skin Probe Retaining Washer

9.2. Conformity

Publishing Organisation	Date of Acceptance	Document Name / Title
TSE	24.03.2016	TS EN 60601-1-2 Medical electrical equipment - Part 1-2: General requirements for basic safety and essential performance - Collateral Standard: Electromagnetic disturbances - Requirements and tests
TSE	13.07.2010	EN 60601-1-6 Medical electrical equipment - Part 1-6: General requirements for basic safety and essential performance - Collateral standard: Usability
TSE	29.04.2008	TS EN 60601-1-8 Medical electrical equipment - Part 1-8: General requirements for basic safety and essential performance - Collateral standard: General requirements, tests and guidance for alarm systems in medical electrical equipment and medical electrical systems
TSE	15.02.2021	TS EN IEC 60601-2-20 Medical electrical equipment - Part 2-20: Particular requirements for the basic safety and essential performance of infant transport incubators
TSE	19.03.2020	TS EN 13976-1 Rescue systems - transportation of incubators - Part 1: Interface requirements
TSE	3.02.2020	TS EN 13976-2 Rescue systems - Transportation of incubators - Part 2: System requirements
TSE	9.11.2020	TS EN 1789 Medical vehicles and their equipment - Road ambulances
TSE	2.07.2020	TS EN 13718-1/A1 Medical vehicles and their equipment - Air ambulances - Part 1: Requirements for medical devices used in air ambulances
TSE	2.07.2020	TS EN 13718-2/A1 Medical vehicles and their equipment - Air ambulances - Part 2: Operational and technical requirements for air ambulances
TSE	30.09.2021	TS EN ISO 15223-1 Medical devices - Symbols to be used with information to be supplied by the manufacturer - Part 1: General requirements
TSE	6.05.2021	TS EN ISO 20417/ Medical devices - Information to be supplied by the manufacturer
TSE	3.02.2020	TS EN ISO 14971 Medical devices - Application of risk management to medical devices
TSE	15.02.2021	TS EN ISO 10993-1 Biological evaluation of medical devices - Part 1: Evaluation and testing within a risk management process
TSE	12.02.2009	TS EN 62304 Medical device software- Software life-cycle processes
TSE	23.10.2015	TS EN 62366-1 Medical devices - Part 1: Application of usability engineering to medical devices
TSE	30.09.2021	TS EN ISO 13485/A11 /Medical devices - Quality management systems - Requirements for regulatory purposes
TSE	18.04.2016	TS EN ISO 13485 / Medical devices - Quality management systems - Requirements for regulatory purposes
TSE	28.04.2022	TS EN ISO 10079-1 Medical suction equipment - Part 1: Electrically powered suction equipment
European Commission	07.06.2001	93/42/EEC - Medical Device Directive
European Commission	06.2016	MEDDEV 2.7.1 / Clinical evaluation: Guide for manufacturers and notified bodies
European Commission	01.2013	MEDDEV 2.12.1 / Guidelines on a Medical Devices Vigilance System
European Commission	01.2012	MEDDEV 2.12.2 / Post Market Clinical Follow-up studies

9.2.1.Conformity Directive

Council Directive 93/42 / EEC of 14 June 1993 concerning Medical Devices (1993-07-12 OJ L L 169/1)

Medical Devices Directive (Council Directive 93/42 / EEC of 14 June 1993 concerning Medical Devices - 1993-07-12 / OJ L 169/1 [1]) intends to harmonize laws on the medical devices within European Union. The Medical Devices Directive is a “New Approach Directive”, and a manufacturer is obliged to satisfy the requirements of MD Directive in order to legally place a medical device on the European market. The products of a manufacturer that meets the 'Harmonized Standards' [2] are assumed to comply with Directive. The products conforming to MD Directive must bear a CE marking. Directive has been last revised and amended by 2007/47 / EC. Compliance with revised directive was made obligatory on 21 March 2010.



9.2.2.Guidance and Manufacturer’s Declaration – Electromagnetic Emissions

This document is the Guidance and Manufacturer’s Declaration with reference to requirements for Electromagnetic Compatibility of Electrical Medical Device in accordance with EN 60601-1-2.

EMC has been assessed with original components. Use of non-conforming components may result in increased emissions and reduced immunity.

KT-1000 is designed for use in the following conditions and environments.

9.2.2.1. Electromagnetic Environment

Guidance and Manufacturer’s Declaration – Electromagnetic Emissions		
KT-1000 is designed for use in the following electromagnetic environments. The customer or user of the KT-1000 should assure that it is used in an environment as described below.		
Emission test	Compliance	Electromagnetic Environment
RF emissions CISPR 11	Group 1	KT-1000 is suitable for use in all establishments, excluding domestic establishments and those directly connected to the public low-voltage power supply network that supplies buildings used for domestic purpose.
RF emissions CISPR 11	Class B	
Harmonic emissions IEC 61000-3-2	Class A	
Voltage fluctuations / flicker emissions (IEC 61000-3-3)	Class A	

9.2.2.2. Electromagnetic Immunity

Guidance and Manufacturer's Declaration – Electromagnetic Immunity			
KT-1000 is designed for use in the following electromagnetic environments. The customer or user of the KT-1000 should assure that it is used in an environment as described below.			
Immunity test	IEC60601 testing level	Compliance level	Electromagnetic Environment
Conducted RF IEC61000-4-6	3Vrms out of ISM 6Vrms on ISM band 150kHz for 80MHz	V1=3Vrms V2=6Vrms	d=1,2VP
Radiated RF IEC61000-4-3	3V/m 80MHz- 2,5GHz- 2,7 GHz	3V/m	d=1,2VP 80MHz- 1000MHz d=2,3VP1000MHz- 2,5GHz
<p>Note 1: 80 MHz and 800MHz high frequency range applies.</p> <p>Note 2: These guidelines may not apply in all situations. Electromagnetic propagation is affected by the adsorption and reflection from structures, objects and people.</p>			

Guidance and Manufacturer's Declaration – Electromagnetic Immunity			
KT-1000 is designed for use in the following electromagnetic environments. The customer or user of the KT-1000 should assure that it is used in an environment as described below.			
Immunity test	IEC60601 testing level	Compliance level	Electromagnetic Environment
Electrostatic Discharge (ESD) IEC 61000-4-2	±8 kV contact ±15 kV air	±8 kV contact ±15 kV air	The floor on which KT-1000 is installed should be wood, concrete or ceramic tile. If the floor is covered with synthetic material, the relative humidity should be minimum 30%.
Electrical fast transient/ bursts IEC 61000-4-4	± 2 kV Network	± 2 kV Network	
	±1 kV Inputs/ Outputs	Not Applicable	
Surge IEC 61000-4-5	±1 kV differential ±2 kV common	±1 kV differential ±2 kV common	
Network frequency magnetic field (50/60 Hz) IEC 61000-4-8	30 A/M	30 A/M	Power frequency magnetic fields should be that of a typical commercial and/or hospital environment.
<p>¹⁾ Field strengths emitted from fixed transmitters, such as base stations for radio (cellular/cordless) telephones and land mobile radios, amateur radio, AM and FM radio broadcast and TV broadcast cannot be predicted theoretically with accuracy. To assess the electromagnetic environment due to fixed RF transmitters, an electromagnetic site survey should be considered, if the measured field strength in the location in which KT-1000 is used exceeds the applicable RF compliance level above, KT-1000 should be observed, additional measures may be necessary, such as reorienting or relocating KT-1000.</p> <p>²⁾ In a frequency range of 150 kHz to 80 MHz, the field strengths should be less than [V₁] V/m.</p>			

9.2.2.3. Recommended Separation Distance

Rated maximum output power of transmitter (W)	Separation distance according to frequency of transmitter (m)		
	150 kHz – 80 MHz d=1.2√P	80 MHz – 800 MHz d=1.2√P	800 MHz - 2,5 GHz d=2.3√P
0.01	0.12	0.12	0.23
0.1	0.38	0.38	0.73
1.0	1.2	1.2	2.3
10	3.8	3.8	7.3
100	12	12	23

For transmitters rated at a maximum output power not listed above, the recommended separation distance d in meters (m) can be estimated using the equation applicable to the frequency of the transmitter, where P is the maximum output power rating of the transmitter in watts (W) according to the transmitter manufacturer.

Note 1: 80 MHz and 800MHz high frequency range applies.

Note 2: These guidelines may not apply in all situations. Electromagnetic propagation is affected by the adsorption and reflection from structures, objects, and people.

9.3. Registration of Trademarks

Novos KT-1000 is a registered trademark of Novos Tıbbi Cihazlar Sanayi ve Ticaret İthalat ve İhracat Limited Şirketi.

9.4. Manufacturer

Novos Tıbbi Cihazlar Sanayi ve Ticaret İthalat ve İhracat Limited Şirketi

Address: İvedikösb Mahallesi 1518 Cad. Matbaacılar Sitesi Sit. No:2/39
Yenimahalle, Ankara, Turkey

Phone: +90.312.384 15 88

Fax: +90.312.384 15 98

E-mail: info@novos.com.tr

KT-1000 Infant Transport Incubator

Basic UDI-DI Code: 869938300KT-1000LB

Device Serial Number: