

# User manual

## Contents

<b>1 Denomination</b>	<b>3</b>
<b>2 Intended purpose of device «Ampir-01»</b>	<b>3</b>
<b>3 Application of device «Ampir-01»</b>	<b>3</b>
<b>4 Indications for use of the device «Ampir-01»</b>	<b>3</b>
<b>5 Contraindications of using the device «Ampir-01»</b>	<b>3</b>
<b>6 Safety precautions when using the device «Ampir-01»</b>	<b>4</b>
<b>6.1 Safety measures for handling device «Ampir-01»</b>	<b>5</b>
<b>6.1.1 Risk of mechanical damage</b>	<b>5</b>
<b>6.1.2 Risk of ignition</b>	<b>5</b>
<b>6.1.3 Electrical danger</b>	<b>6</b>
<b>6.1.4 Biological danger</b>	<b>7</b>
<b>6.2 Safety measures when you install device «Ampir-01»</b>	<b>7</b>
<b>6.3 The risks of using device «Ampir-01»</b>	<b>8</b>
<b>7 Possible side effects when using the device</b>	<b>8</b>
<b>8 Possible consequences of the use of the device on ability to drive vehicles, machinery</b>	<b>8</b>
<b>9 Possibility of using the device and its features for people with implantable in the human body medical units, pregnant women, women during the period of breastfeeding, children, adults with chronic diseases</b>	<b>8</b>
<b>10 Interactions with other drugs in infusion therapy and nutrients in artificial feeding</b>	<b>9</b>
<b>11 Lifetime of device</b>	<b>9</b>
<b>12 Operating conditions, storage and transport</b>	<b>9</b>
<b>13 Information about manufacturer</b>	<b>10</b>
<b>14 The official representative on the EU territory</b>	<b>10</b>
<b>15 Equipment options</b>	<b>11</b>
<b>15.1 Device composition</b>	<b>11</b>
<b>16 Main parameters and characteristics</b>	<b>11</b>
<b>17 Design and operation of device «Ampir-01»</b>	<b>13</b>
<b>17.1 Appearance</b>	<b>13</b>

<b>17.2 Work principle</b>	<b>14</b>
<b>17.3 Controls and indication</b>	<b>15</b>
<b>17.4 External connectors and connections</b>	<b>18</b>
<b>17.5 Error codes</b>	<b>18</b>
<b>18 Preparing device «Ampir-01» to the work, work with unit and completion of the work.</b>	<b>20</b>
<b>18.1 Device installing on infusion stand</b>	<b>20</b>
<b>18.2 Connection of power cable</b>	<b>21</b>
<b>18.3 Device launch</b>	<b>21</b>
<b>18.4 End of process</b>	<b>22</b>
<b>19 Technical service</b>	<b>23</b>
<b>19.1 General instructions</b>	<b>23</b>
<b>19.2 Cleaning and disinfection</b>	<b>24</b>
<b>19.3 Current technical service</b>	<b>25</b>
<b>19.4 Planned technical service</b>	<b>25</b>
<b>20 Procedure for disposal and destruction</b>	<b>26</b>
<b>21 Marking, sealing and packing of device «Ampir-01»</b>	<b>26</b>
<b>22 Possible faults and methods of their elimination</b>	<b>29</b>
<b>23 The content of precious metals data</b>	<b>31</b>
<b>24 Approval certificate</b>	<b>31</b>
<b>25 Certificate of packaging</b>	<b>31</b>
<b>26 Manufacturer's warranty</b>	<b>32</b>
<b>27 Terms of warranty service</b>	<b>33</b>
<b>28 Information about reclamations</b>	<b>35</b>
<b>29 Accounting for malfunctions during operation</b>	<b>36</b>
<b>30 Electromagnetic compatibility</b>	<b>37</b>
<b>31 Document revision history</b>	<b>42</b>
ANNEX 1.....	43
ANNEX 2 (reference).....	44

## **1 Denomination**

This operation manual (hereinafter - OM) is a document containing information on the design, principle of operation, characteristics of the Blood, blood substitute and infusion solution warming device «Ampir-01» (hereinafter - device), as well as the instructions necessary for proper and safe operation , maintenance, storage and transportation. The staff can work with the device only after studying this guide.

## **2 Intended purpose of device «Ampir-01»**

The device is intended for the prevention and treatment of hypothermia and complications caused by it, in pre-, intra- and postoperative periods and used to heat liquids and solutions during the infusion / transfusion therapy.

Device «Ampir-01» is equipped by microprocessor controller, self-test system, alarms and this is a portable device that provides automatic maintenance of the set temperature of the heat exchanger.

## **3 Application of device «Ampir-01»**

The device is intended for use in ambulatory care, clinics, cardiac centers, medical research institutions and other therapeutic and prophylactic health care facility and medical research institutions.

## **4 Indications for use of the device «Ampir-01»**

Prevention and treatment of hypothermia and complications caused by it.

## **5 Contraindications of using the device «Ampir-01»**

### **An absolute:**

If patient must be at hypothermic condition in the pre-, intra- and postoperative periods.

**An method of using:** do not use the device that has mechanical damage or defect, or indicates its fault.

## 6 Safety precautions when using the device «Ampir-01»

This chapter describes the basic safety precautions that must be performed when user interacts with the device. This information relates generally to safety:

- of Patient,
- of User,
- of Equipment.

The other risks from use of the device are minimal if device used by qualified personnel.

Look packaging and device before use. Do not use the damaged device or damaged connecting cables.

Before using, check the compatibility of the device connectors.

Application of this device must be fully comply with its intended purpose.



*The manufacturer guarantees safe and reliable operation of device only when observed following safety recommendations.*

**WARNING!**



*You can start work only after you have carefully read and fully understood the contents of this manual, especially important recommendations on safety measures.*

**CAUTION!**



*Only specialists who have received special training from the manufacturer can do service of that device.*

**CAUTION!**



*User must acquainted with the safety requirements and avoid situations which can threaten the patient, personnel or equipment.*

**WARNING!**



*Unauthorized changes or modifications of device can cause a change in specifications, which in turn may lead to a decrease the device safety.*

## **6.1 Safety measures for handling device «Ampir-01»**

### **6.1.1 Risk of mechanical damage**

- Be careful when working with device and avoid falling, shocks and other mechanical influences on it.
- Each time before using device, inspect it to detect defects of case and cable.
- Check it for cracks, gaps and holes or other damage that may contribute to fluid penetration into the device.
- Regularly inspect device to detect deformation, sharp edges or irregularities that may cause damage to the protective means.
- Protect the power cord from damage and kinks. When the cable is disconnected from the unit is allowed only to pull the plug housing but not the cable.
- Power cable is designed for permanent connection to the device. If possible, avoid unnecessary reconnections.
- Don't use device, which have damage or defects.

### **6.1.2 Risk of ignition**

Never place the unit close to flammable or explosive, liquid, vapor or gaseous substances. Do not install the unit in a place where it is possible the impact of these adverse factors, such as high salt content, sulfur and dust in the air, and direct sunlight.



**DANGER!**

*To prevent fire, the user must:*

- *Do not switch on the device, if it is located close to flammable and explosive substances;*
- *Remove flammable and explosive materials from the room and ventilate it.*

After completing the above procedures, user can switch the device.

### 6.1.3 Electrical danger

The degree of protection against electric shock device meets the Class I type in accordance with EN 60601-1.



**DANGER!**

*Contact with the some components inside the case of the device creates the risk of electric shock.*

*Do not open the covers, guards and panels, to avoid the danger electric shock of high voltage.*

*Carefully observe safety measures during the inspections, control and prevention and adjustment works.*



**DANGER!**

***DO NOT USE THE DEVICE WITHOUT GROUNDING.***



**WARNING!**

*Do not attempt to repair the device by yourself.*

*If is necessary to repair, contact the customer service of the manufacturer or an authorized dealer.*

- Use only fixed outlet intended for medical equipment;
- When you connect the power cable into device, it must be disconnected from electrical outlet;
- Do not connect extraneous devices to the electrical connector of device and to the power cable;

- Do not use the device in other climatic conditions than required;
- Do not use the device without a ground connection;
- Avoid exposing water drops and splashes on device connectors because contact with the electrical circuit of the unit may cause a short circuit, leading to fire;
- Avoid repeated switching on \ off the device in short time period;
- If device is faulty, turn it off (disconnect the unit from electric power) and contact with customer service.



WARNING!

*The device must be connected to a separate power outlet on the hospital network (230 ± 23) V 50 Hz AC, having a grounding, or a special network for medical devices.*

#### **6.1.4 Biological danger**

For the safety of the patient and the staff (to eliminate the risk of infectious disease) you must comply with all requirements for personnel and equipment to comply with asepsis and antisepsis rules, established in the hospital.



WARNING!

*Always keep device body clean.  
When you clean the device surfaces, do not use solvents or active chemical solutions!*

#### **6.2 Safety measures when you install device «Ampir-01»**

- The device connector should not be exposed to water spray;
- Device must be installed in a room without negative factors such as: excessive pressure, the presence of salts and sulfur in the air, high temperature and humidity, dust and direct sunlight;
- Do not expose the device to excessive vibration or shock;
- Do not use the device in an ambient temperature above +30 or below +10 °C and relative humidity above 80 %;

- Do not install device at places where stored chemicals or harmful gases are present;
- Do not use the device under conditions of strong electric and magnetic fields;
- Do not use the device in conditions not excluding ingress of water jets on device for a long time;
- Make sure that the power supply voltage and frequency correspond to those indicated in the operating manual.

The device is connected to a separate power supply outlet of hospital (230 ± 23V, 50 Hz AC) or special power network for medical devices.

### **6.3 The risks of using device «Ampir-01»**

In accordance with risk management report MR.7.1-01-002-O concluded:

Risk management measures taken at the design stage, through production and safety information, helped to minimize the potential risks from the use of device «Ampir-01» and the possible consequences to an acceptable level. Common residual risk is acceptable according to the criteria DP QMS 7.1-01.

### **7 Possible side effects when using the device**

Possible side effects are not detected, when you use the device.

### **8 Possible consequences of the use of the device on ability to drive vehicles, machinery**

Using the device is not affected, on the ability to drive vehicles, machinery.

### **9 Possibility of using the device and its features for people with implantable in the human body medical units, pregnant women,**



## women during the period of breastfeeding, children, adults with chronic diseases

You can use the device for people with implantable in the human body medical devices, pregnant women, women during the period of breastfeeding, children, adults with chronic diseases.

### **10 Interactions with other drugs in infusion therapy and nutrients in artificial feeding**

Before application of drugs and nutrients read the instructions for use of these drugs and nutrients.

### **11 Lifetime of device**

The warranty period of the unit for **at least 24 months from the date of commissioning**, and no more than **36 months from the date of shipment**.

Average lifetime of device not less than 5 years.

The warranty does not cover power cable, which is a consumable item.

### **12 Operating conditions, storage and transport**

12.1 Operating conditions of device:

- Ambient temperature 10 to 30 °C;
- Ambient air humidity up to 80% at 25 °C;
- Atmospheric pressure from 650 to 800 mm Hg (From 86.0 to 106.7

kPa).

12.2 You may store device (in Part climatic factors) in an unheated storage, where temperatures of -50 to 40, 75% humidity at 15 °C (maximum 98% humidity at 25 °C). You must comply it with fire safety rules.

The presence in the air vapors of acids, alkalis, and other corrosive contaminants is not allowed.

Storage time of the device - 12 months.

12.3 The device should be transported in the package under a roof where the temperature ranges from  $-50\text{ }^{\circ}\text{C}$  to  $+40\text{ }^{\circ}\text{C}$ , the average humidity of 75 % at a temperature of  $15\text{ }^{\circ}\text{C}$  (maximum 100 % humidity at  $25\text{ }^{\circ}\text{C}$ ).

12.4 Keep device out of children.

### **13 Information about manufacturer**

Additional Liability Company "TahatAksi"

Legal address: Republic of Belarus, 220075, Minsk, Selitskogo str., 7, room 4, office 101.

Production location: Republic of Belarus, 220101, Minsk, Rokossovskogo Avenue, 166, room 1N.

### **14 The official representative on the EU territory**

Address of the authorized representative in the Community:  
«Versamedikas» Ltd, LT03109, st. Sevcenko, 18-30, Vilnius, Lithuania,  
VAT: LT100006413810

## 15 Equipment options

### 15.1 Device composition

Variants of the device:

1. Blood, blood substitute and infusion solution warming device «Ampir-01»

The device is supplied with:

- a) Blood, blood substitute and infusion solution warming device «Ampir-01» – 1 pc.;
- b) power cable – 1 pc.,
- c) infusion stand SUIR (in consultation with the customer).

2. Blood, blood substitute and infusion solution warming device «Ampir-01A»

The device is supplied with:

- a) Blood, blood substitute and infusion solution warming device «Ampir-01A» – 1 pc.,
- b) power cable – 1 pc.,
- c) infusion stand SUIR (in consultation with the customer).

## 16 Main parameters and characteristics

Table 1. Main parameters and dimensions

Characteristic	Characteristics value
Voltage and frequency of power supply	230V / 50 Hz
Average power consumption, max	30 W
Maximum power consumption (power consumption)	390W (360W) Ampir-01,01 A
Dimensions, max	225×195×170 mm
Device weight (with power cord), not more than	2,8 kg
Type / class of protection against electric shock	B/I
Heat time, not more than	5 min (Ampir-01, 01 A)

Temperature setting range	34-41,5 °C
Accuracy of temperature adjustment	0,1 °C
Operating conditions:	
Operating temperature, °C	From +10 to +30
Limit operating temperature, °C	From +1 to +40
Relative humidity the lower value, %	60 at 20 °C
Relative humidity high value, %	80 at 25 °C
Accuracy of maintenance of temperature, depending on the operating conditions	From $\pm 2$ to $\pm 5\%$
Ingress Protection Rating, not less	IP 23

## 17 Design and operation of device «Ampir-01»

### 17.1 Appearance

Appearance of device «Ampir-01» presented in Fig.1.



Fig. 1. Appearance of device «Ampir-01»



Fig. 2. Appearance of device «Ampir-01A».



*Allowed delivery device whose appearance differs from that shown in Fig. 1, 2, 3, 4, but with the same composition control, indication and connections.*

## 17.2 Work principle

Principle of work the device is based on a continuous heating of flow fluid. Heat source heats the line and liquid flowing through it. You can use several lines simultaneously.

The temperature of the heating element is installed by using the control panel keys and is adjustable from 34 to 41,5 °C in steps of 0,1 °C.

### 17.3 Controls and indication

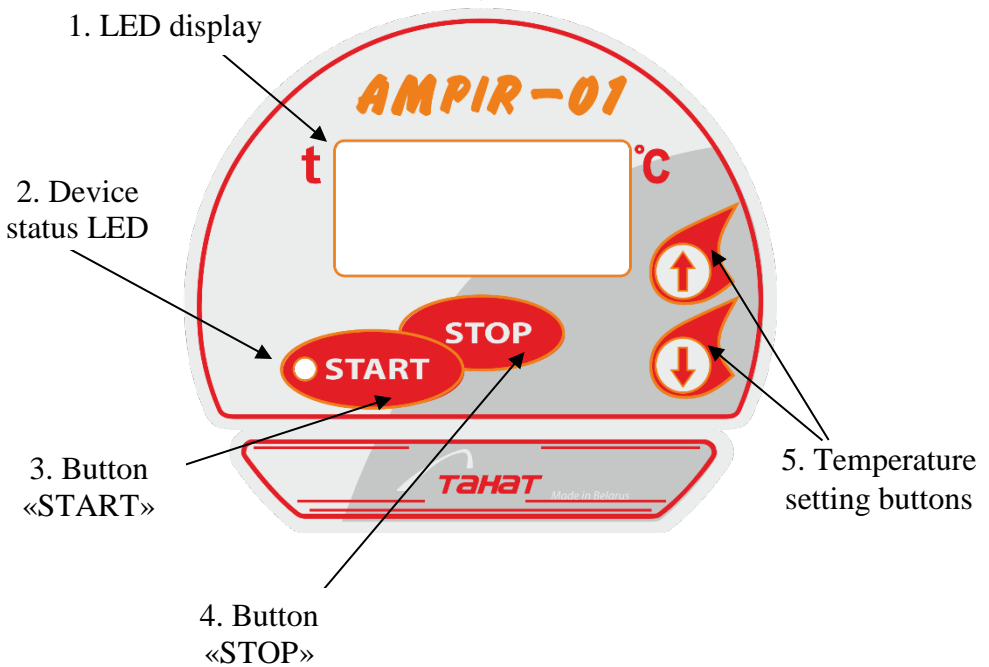

Fig. 3. The control panel of device «Ampir-01».

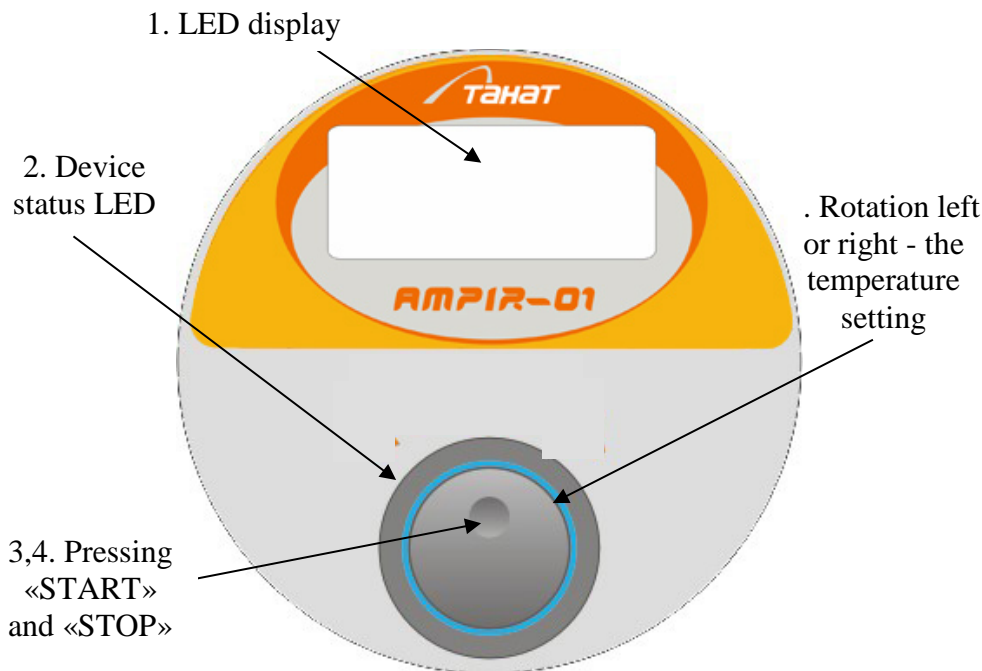

Fig. 4. The control panel of device «Ampir-01A».

1. LED display is located on the front panel provides the following information:

- While pressing the «START button» displays the current temperature of the heat exchanger;
- While pressing the «STOP» button displayed preset temperature heat exchanger;
- In the case of a malfunction displayed an error code (see p.17.5.);
- Two points lights in the temperature setting mode: separation point and point at the end of the temperature value;
- The separation point flashes throughout heating time on temperature indication;
- When it reaches to the set temperature, the separation point is lit.





2. The device status LED shows following information:

- While pressing the «START» button it lights or blink depending on the mode of operation of heating element, it defined by system microcontroller of the device (in version Ampir-01A – it light constantly);

- When you press the button «STOP», device status LED not illuminated.

3. «START» button is located on the front panel and used to start the heating process.

4. «STOP» button is located on the front panel and used to stop the heating process.

5. Buttons «», «» are located on the front panel and used to increase or decrease the heating temperature set by the heat exchanger (in the version Ampir-01A - turn "shuttle" to the left - a decrease temperature, turn right - to temperature increase).



***Please monitor the presence of audio information signal, which sounds each time while you press buttons at control unit! If there is no sound after pressing the buttons, please contact to your service department with speaker failure problem;***

## 17.4 External connectors and connections

1. Electric socket is located at the bottom of device body and used to connect a power cable (Fig. 5).
2. Power switch is located at the bottom of device body (Fig. 5).
3. Fuse block is located at the bottom of device body (Fig. 5).

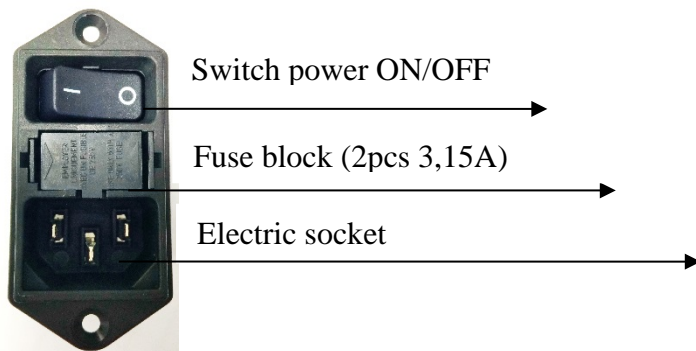

Fig. 5. Electrical connector with integrated switch and fuse block

## 17.5 Error codes

The device has control when turning on and during operation the appearance of malfunctions in the operation, which are accompanied by a sound signaling of two pulses with an interval of 15 seconds. The "EXX" symbol is lit on the temperature indicator, where E - error XX is the error code, which indicates an error in the device work. The failure of the device has a low priority than Dangerous situations.

Sense of error codes see at table 2.

Table 2. Error codes

<b>Code</b>	<b>Sense</b>	<b>When the error occurred</b>
E01	Crash when applying a voltage to internal electrical circuit of device	at startup, during work
E03	Sensors bus connection problem	during work
E04	Not connected or faulty temperature sensors	at startup
E34	The device cannot raise temperature above 32 °C over 10 minutes.	during work
E55	Within 30 minutes after turning on the unit is not pressed "Start" button	during work
E64	Overheating of the heat exchanger (over 42 °C)	during work

**CAUTION!**

*Possible methods eliminate some of the errors described in chapter 22.*

## 18 Preparing device «Ampir-01» to the work, work with unit and completion of the work.

### 18.1 Device installing on infusion stand

Example of installation shown in Fig. 6.

1. Holding the device by the handle set it on the infusion stand.
2. Fix it by screw.
3. While holding handle, check the reliability of fixing by lightly pressing down the front part of device.

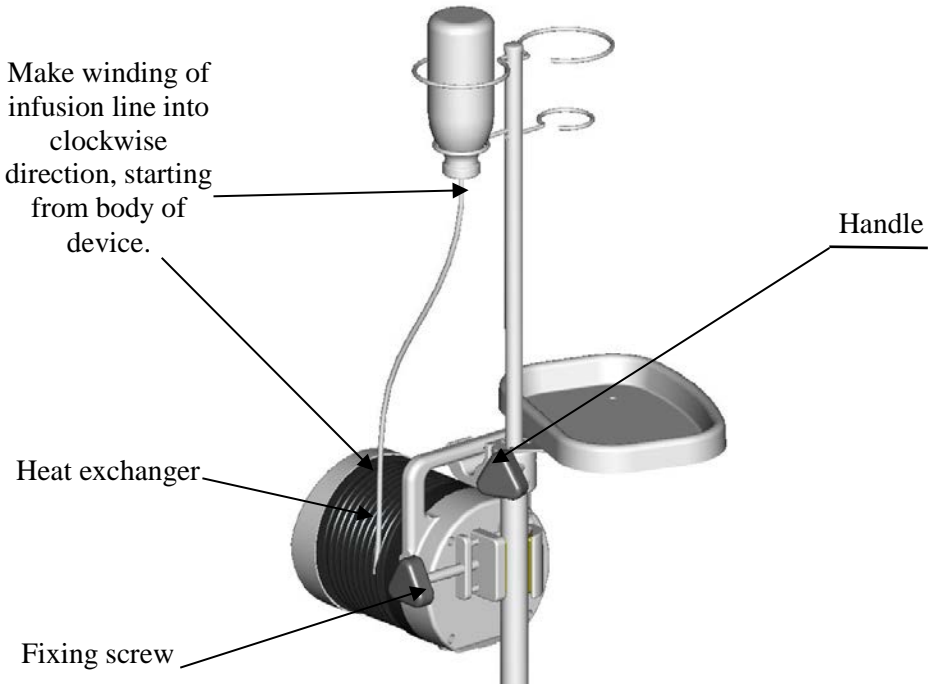

Fig.6. Installing device on infusion stand





*When you install device, carefully read chapter 6 of this OM*

## 18.2 Connection of power cable

When you connect power cable to device, it should be disconnected from the wall outlet.



Power switch on the unit must be in the "OFF" position (O). When you connect the cable is necessary to keep the plug (not wire). Cable must be inserted to the movement stop position.

## 18.3 Device launch

1. Perform winding of infusion line in clockwise direction, starting from the device body and move towards the front part of device. When you winding the line is necessary to slightly pull it, for better placement in the slots of the heat exchanger. It is required to make two or three full turns (optimally three). If necessary, you can reel several lines.
2. Turn on power cable into outlet with grounding.
3. Turn the power switch (at the bottom side of the unit) to "ON" (□) - when voltage applied 230 V, the device will beep and light up with LED indication of the last set temperature.
4. LED display indicates the previously set heating temperature of the heat exchanger. At the end of temperature value will light dot, informing user of the work in the temperature setting mode.
5. Press «» and «» buttons (located on the front panel) and set the required temperature in the range of 34 - 41,5 °C on heat exchanger.

6. To start heating process please press «START» button – device status LED will light near the button. In the heating process, the display panel will show the current temperature of the heat exchanger - depending on the operating mode of the heating element, the device status LED will light or blink; the separation dot will blink (in the temperature value). After reaching the set temperature on the display panel will appear constantly maintained temperature, the separating dot will be constantly illuminated. Next, the microcontrollers system of device automatically monitors the change of the heat exchanger temperature and maintains it at the set level, the device status LED will flash periodically.

7. Press «STOP» if you need to change the temperature of the heat exchanger. On the display will light up the dot (at the end of temperature value) and display will show the installed heat exchanger temperature.

Press «» and «» (at the front panel), to set new required temperature of heat exchanger in range 34 - 41,5 °C. Press «START» to start the heating process.

8. The temperatures of solution, depending on the infusion rate and the length of the line from the heat exchanger to the patient, are shown in Application 2.



*When you decrease previous set temperature, the heat exchanger need time to cool down and reduce its temperature.*

## 18.4 End of process

After work with device do the next actions:

1. When you finish infusion \ transfusion therapy press «STOP» button.

2. Turn off power (set switch at bottom side of device body in “OFF” position, see Fig.5).
3. Disconnect the power cord from the wall outlet.
4. Disconnect the line from device.
5. Move the device to a new place of work or storage.

## 19 Technical service

### 19.1 General instructions

The technical service operations (hereinafter TS) include:

- the current TS which is carried out by personnel using the device; the current TS carried out in preparing the device for its intended use, directly after work completion and before carrying out planned TS.
- the planned TS, which is carried out by qualified technical personnel in the conditions of service (organization) responsible for carrying out these works, who have been authorized by the manufacturer.



**DANGER!**

*To avoid an electric shock all the checks and inspection procedures are carried out only when device is de-energized and switched off.*

*In the event of any damage or faults, not including the device, call for service organization.*



**DANGER!**

*Do not remove protective covers from the device. Only qualified personnel are allowed to perform these service operations. Violation of this requirement may result in electric shock.*

*Always keep the device in cleanliness!*

*When you clean the device surfaces, do not use solvents or active chemical solutions!*



*Do not use solvents, alcohol or abrasive cleaners.*

*Do not expose the power cable autoclaved or boiling process.*



*To avoid static electricity, every month, wipe the electronic unit with a soft cloth moistened with an antistatic agent.*

## 19.2 Cleaning and disinfection

For cleaning contaminated surfaces of device, use a soft cloth dampened with a weak solution of neutral detergent.

Clean it to appropriate means with a low content of alkali and without chlorine.

You can use disinfectants based on alcohols (ethanol, isopropanol, propanol) and disinfectants based on cationic surfactants.

Heat exchanger. To clean grooves of the heat exchanger, do the following steps:

1. Wrap a cotton swab on a rigid rod, for example, on the Lucifer match. Cotton swab soak with detergent or disinfectant.

2. Clean the grooves of heat exchanger over the whole length.

Repeat steps 1-2 to complete cleaning of the heat exchanger from contamination.

*Always keep the device in cleanliness!*

*When you clean the device surfaces, do not use solvents or active chemical solutions!*



*Do not expose the power cable autoclaved or boiling process.*





*When cleaning, be careful not to spill or spray liquid into connectors. After the treatment, it is necessary to wipe dry the heat exchanger.*

### **19.3 Current technical service**

You must check every day:

- Connectors and cables for mechanical damage;
- Electric cables and power cords over the whole length on presence of breaks, cuts and abrasions, which can break isolation;
- That device haven't any mechanical damage, weakening or absence of fasteners;
- That all equipment is OK.

### **19.4 Planned technical service**

Planned TS includes periodic testing, allowing the user to confirm that the device consistently perform it functions. Planned TS allows timely identify of changes in performance that may occur due to normal aging of the device components.

The frequency of inspections depends on the intensity of use, modes of operation and are executed within the period specified in a medical facility. Checks should also be carried out in case of doubt in efficiency.

To obtain a reliable result, planned TS shall be carried out in conditions where the basic parameters have been obtained.

Planned TS shall be held not less than once a year and includes a visual inspection and assaying. In this case, instead of the reference thermometer with a limit of absolute error of temperature measurement  $\pm 1,6\%$ , is permitted to use a thermometer with measure the temperature of the absolute limit of error of  $\pm 2,5\%$ .

## 20 Procedure for disposal and destruction

Dispose of the device and its accessories in accordance with the applicable local regulations.





Unused devices haven't any special precautions for the destruction. It must be disposed of as household waste.

## 21 Marking, sealing and packing of device «Ampir-01»

### 21.1 The marking of control unit, of remote heat exchanger, of stand and UPS

The device has a marking, comprising:

Table 3 Marking products

<b>Designation TCF</b>	TCF 0215
<b>Lettering</b>	«Made in Belarus»
<b>Nominal voltage</b>	~230 V
<b>power consumption</b>	390 W for Ampir-01, 01 A
	The trademark of the manufacturer
	Type of product, depending on the degree of protection against an electric shock (BF type of product)
	Ingress Protection Rating
<b>Ser.№</b>	Serial number
	A single sign of products on the market of the Member States of the Customs Union (EAC)

## 21.2 Sealing

The device is sealed with a self-destruction seal, which is located at the places of fixing the mounting screws.







**CAUTION!**

*Damage of warranty seal deprives customer, from free warranty service and repair.*

### 21.3 Marking of packing (including transport pack)

Explanation of symbols on the packing are shown in Table 4.

Table 4: Marking of packing

	«Protect from moisture»
	«Brittle. Caution.»
	«Top»
	A <b>single</b> sign of products on the market of the Member States of the Customs Union (EAC)

On packing also marked:

- A trademark of the manufacturer;
- The name and address of the manufacturer;
- The name of the device;
- Designation of the technical file;
- Month and year of packing.

### 21.4 Packing

The device, accessories and operating documentation packed in corrugated cardboard box.

The stand wrapped by polyethylene bubble film.

## 22 Possible faults and methods of their elimination

Table 5. Faults and elimination methods

<b>Symptom</b>	<b>Possible reason</b>	<b>Troubleshooting method</b>
the power LED is off	fuses failure	check the fuse condition, replace if necessary
the power LED is off	no power at the AC outlet	check the contacts condition, and power supply level
at power up, beep sounds and on the display panel lights up "E01" error code	there is no voltage on the heating element, device overheating more than 45 ° C	check the condition of environment, if necessary, contact with customer service
at power up, beep sounds and on the display panel lights up "E03" error code	sensor connection bus problem, problem with the electronics	contact with customer service
at power up, beep sounds and on the display panel lights up "E04" error code	temperature sensor not connected or faulty	contact with customer service

<b>Symptom</b>	<b>Possible reason</b>	<b>Troubleshooting method</b>
during work or when the beep sounds at startup and the indicator display lights, "E04" error code	it is impossible to read the data from both sensors. Both sensors out of order.	turn on / off the device, if when you turn on device, the indicator panel glows code "E04" error - contact your service.
during work beep sounds and on the display panel lights up "E34" error code	a problem with the electronics, operating conditions are violated	check the operating environment, supply voltage - in the case of deviations from the required, move the device in appropriate conditions of this manual. Otherwise, contact your service
during work beep sounds and on the display panel lights up "E55" error code	"Start" button isn't pressed during 30 minutes from turning on the device and (or) temperature setting.	push «Start» button
during work beep sounds and on the display panel lights up "E01" error code	the device was heated up above permissible heating temperature of 42 ° C, the electronics failure.	check the condition of environment, disconnect the unit from the 230 V for 4-5 minutes and then turn it on again. In the case of a permanent error occurred, contact to service department.

### 23 The content of precious metals data

Blood, blood substitute and infusion solution warming device AMPIR-01 contains:

- gold – 0,0179 g;
- silver – 0,1768 g;
- platinum - 0, 00 g;
- palladium - 0,0083 g

### 24 Approval certificate

Blood, blood substitute and infusion solution warming device AMPIR-01  
Manufacturing number \_\_\_\_\_.

The device meets the technical conditions and recognized serviceable.  
Technical control department (TCD) of the enterprise

\_\_\_\_\_  
(day, month, year, signature)

### 25 Certificate of packaging

Blood, blood substitute and infusion solution warming device AMPIR-01.

It is packed in accordance with TCF 0215.

Packed by \_\_\_\_\_.  
(day, month, year, signature)

## **26 Manufacturer's warranty**

The manufacturer guarantees accordance of device the TCF 0215 requirements at observance of conditions of use, storage, transportation.

The warranty period of the unit for at least 24 months from the date of commissioning, and no more than 36 months from the date of shipment.

Warranty storage period - 12 months.

The warranty does not cover power cable, which is a consumable item.

During warranty period, the manufacturer free of charge repair or replace the device and its parts upon presentation of the warranty card. After the warranty period, the manufacturer provides repair and replacement of the device and its parts at the prices valid at the time of reference of the consumer. Repair and maintenance of the device by the end of warranty period at established prices is carried out by the manufacturer.



## **27 Terms of warranty service**

1. Warranty service is performed only with undamaged warranty seals on the product.
2. Delivery of product for warranty service, is carried out by the Customer.
3. During the warranty period, in case of malfunction, through the fault of the Seller, the Seller undertakes to free repair or replace the product.
4. Buyer has the right to get information about a product or its rules of operation. To do this, contact a consultant directly or by phone. (8-1037517) -375 5843.
5. Before sending product to repair it is necessary to disinfect, and make acts of disinfection and identified defects. If the fault is not confirmed, or item will without accompanying acts - it will return to the Purchaser without the repair and extension of warranty period.
6. Repair or replacement of defective products is made within a period not exceeding one month from the date of receipt defective products in full set, to the warranty repair.
7. During repair, the warranty period is extended for device repair time.
8. After completing the repair, the goods stored in a warehouse is not more than THREE MONTHS. After this period, a service organization has the right to put the buyer the bill for storage of goods.
9. The warranty service of product is not accepted, and guarantee obligations of the seller terminated with the issuance of the corresponding certificate in the following cases:
  - in cases of incorrect or careless operation, transportation, storage of goods, which resulted in a mechanical, electrical, thermal, chemical, and other damage, or absence of structural elements of products;
  - in the presence of traces of unauthorized repair or alteration;
  - in cases of damage and traces restick of warranty seals, the availability of foreign labels and stickers that cover an existing seals or stickers manufacturer or seller, ajar and damage: of stickers, control and sealing strips, seals;

- in cases of presence traces insects or animal waste (cockroaches, ants, mice, etc.), as well as a dusty products, products with traces of oxidation traces of corrosive media;
- revealed in the repair process of a mismatch terms and conditions of use, requirements for equipment of this type;
- failure caused by the impact of irresistible force factors (power surge) and / or actions of third parties.

10. The warranty does not cover damage caused to other equipment, working in conjunction with this product, software; on the compatibility of this product with the products and software products of third parties;

11. The manufacturer is not responsible for the loss of profits caused by the failure of the delivered goods.

12. When you receive the goods, customer is obliged to verify package contents, integrity and appearance of the product. Claims should be made only with the commissioning of the equipment. If you find these deficiencies after commissioning, for the above reasons, claims will not accepted.

13. For any technical questions, you can consult by phone. (8-1037517) - 375 58 42.

## 28 Information about reclamations

In case of failure or malfunction during the warranty, as well as detection of incomplete shipping in the primary acceptance, the consumer must send the following documents at the company which carrying the warranty:

**a request for repair (replacement);  
defect report.**

All presented reclamations registered by the consumer in a table 6.

Table 6. Reclamations

Date of failure or a malfunction	Number of hours of device operation before a malfunction or failure.	Description of malfunctions	Date of reclamation sending	Measures adopted on customer reclamation	Comment

## 29 Accounting for malfunctions during operation

Table 7. Malfunctions during operation

Date and time of failure, mode of operation	The nature (symptoms) of malfunction	Cause of fault (refusal), the number of hours of work	The measures taken remaining troubleshooting steps and the mark of direction complaint	Position, surname and signature of the person responsible for removal of faults	Comment

### 30 Electromagnetic compatibility

**Attention!** The device «Ampir-01» requires special precautions for electromagnetic compatibility and it should be installed and commissioned in accordance with the EMC information provided in section 18 of this operating manual.

The portable and mobile equipment of radio frequency communication, can affect the operation of the device.

The device «Ampir-01» should not be located near or on another device. If it can not be avoided in advance is necessary to check its performance of device in these conditions.

The use of accessories and cables, other than those recommended ALC "TahatAksi" as spare parts could lead to increased interference emission and reduce noise immunity of the device.

The power cable length should not be exceed 3 m.

Table 8 – Interference emission

<b>Guidance and manufacturer's declaration. Interference emission</b>		
The device is intended for use in the electromagnetic environment specified below. Supplier or user of the device should provide its application in the specified electromagnetic environment.		
Interference emission test	Complies	Electromagnetic environment. Instructions
Radio frequency emission by CISPR IEC 11	Group 1	The device uses RF energy only for its internal functions, so it is very small RF Emission and probably will not have any impact on the nearby electronic equipment.
Radio frequency emission by CISPR IEC 11	Class B	The device is suitable for application in all facilities including residential houses and buildings directly connected to the general-purpose electrical networks which powered houses and vehicles.
Harmonic currents by IEC 61000-3-2	Class A	
Voltage fluctuations and flicker according to IEC 61000-3-3	Complies	

Table 9 – Interference immunity

<b>Guidance and manufacturer's declaration. Interference immunity</b>			
The device is intended for use in the electromagnetic environment specified below. Supplier or user of the device should provide its application in the specified electromagnetic environment.			
Interference immunity test	Test level for IEC 60601	Level of compliance with interference immunity requirements	Electromagnetic environment. Instructions
Electrostatic discharge (ESD) IEC by 61000-4-2	$\pm 8$ kV - contact discharge $\pm 2$ kV, $\pm 4$ kV, $\pm 8$ kV, $\pm 15$ kV - air discharge	$\pm 8$ kV - contact discharge $\pm 15$ kV - air discharge	Floor space should be made of wood, concrete or ceramic tiles. If floors are covered with synthetic material, the relative humidity should be at least 30%
Nanosecond pulse noise according to IEC 61000-4-4	$\pm 2$ kV - for powerline	$\pm 2$ kV - for powerline	The quality of electric energy in the electric network of the building must comply with the conditions of a typical commercial or hospital environment
Microsecond pulse interferences of high energy by IEC 61000-4-5	$\pm 1$ kV supply noise on a "wire-wire" $\pm 2$ kV supply noise on a "wire-to-ground"	$\pm 1$ kV supply noise on a "wire-wire" $\pm 2$ kV supply noise on a "wire-to-ground"	The quality of electric energy in the electric network of the building must comply with the conditions of a typical commercial or hospital environment
Voltage dips, short interruptions and voltage variations on power supply input lines by IEC 61000-4-11	0 % $U_T$ for 0.5 cycle at $0^\circ$ , $45^\circ$ , $90^\circ$ , $135^\circ$ , $180^\circ$ , $225^\circ$ , $270^\circ$ and $315^\circ$ 0 % $U_T$ for 1 cycle at $0^\circ$ 70 % $U_T$ for 25/30 cycles at $0^\circ$	0 % $U_T$ for 0.5 cycle at 8 phase angles 0 % $U_T$ for 1 cycle at $0^\circ$ 70 % $U_T$ for 25/30 cycles at $0^\circ$ 0 % $U_T$ for 250/300 cycles at 0	The quality of electric energy in the electric network of the building must comply with the conditions of a typical commercial or hospital environment. If the user requires uninterrupted operation of device, in conditions of possible interruptions of mains voltage, it's recommended to provide

	0 % $U_T$ for 250/300 cycles at 0		power from the uninterruptible power supply to device
The magnetic field power frequency by IEC 61000-4-8	30 A/m, 50 Hz and 60 Hz	30 A/m	The quality of electric energy in the electric network of the building must comply with the conditions of a typical commercial or hospital environment
Note - $U_n$ - level electric network AC voltage before application of the test level			
<b>Attention!</b> Requirements for immunity to conductive interferences, induced by radio-frequency electromagnetic field is not applied to the input ports of the DC power supply, signal ports, the ports of interconnect connections.			
<b>Attention!</b> The body port should tested on resistance to radiofrequency electromagnetic field			

Table 10 – Interference immunity for the products and systems that are not intended for life support

<b>Guidance and manufacturer's declaration. Interference immunity for the products and systems that are not intended for life support</b>			
The device is intended for use in the electromagnetic environment specified below. Supplier or user of the device should provide its application in the specified electromagnetic environment.			
Interference immunity test	Test level by IEC 60601-1-2	Level of compliance with interference immunity requirements	Electromagnetic environment. Instructions
Conducted interference induced in electromagnetic fields by IEC 61000-4-6 RF	3 Vrms 0.15-80MHz; 6Vrms in ISM bands between 0.15MHz and 80MHz. 80 % AM at 1kHz;		The distance between the used mobile radio communication system and any element of the device, including cables, should not be less than the recommended separation distances, which is calculated in accordance with the above equation applied to frequency of the transmitter. Recommended separation distance is: $d = 1,17 \sqrt{P}$ $d = 1,17 \sqrt{P}$ from 80 MHz to 800 MHz $d = 2,33 \sqrt{P}$ from 800 MHz to 2,5 GHz,

Radiated highfrequency disturbance according to IEC 61000-4-3	3 V/m in a band from 80 MHz to 2.7 GHz  9-28 V/m*** (wireless RF communication)	3 V/m  9-28 V/m***	where P – is maximum nominal value of the transmitter output power, W, in accordance with the value set by the manufacturer of the transmitter; d - the recommended separation distance, m. The field strength of the propagation of radio waves from the stationary radio transmitters on the results of observations electromagnetic environment * should be lower than the compliance level in each frequency band **. Interference can occur near equipment marked with the  following sign:
NOTE 1 - At 80 MHz and 800 MHz, can apply the higher frequency range. NOTE 2 - You can't apply these guidelines in all situations. Electromagnetic propagation is affected by absorption and reflection from structures, objects and people.			
* The field strength in the propagation of radio waves from fixed transmitters, such as base station radio telephone networks (cellular / wireless) telephones and land mobile radios, amateur radio, AM and FM-broadcasting transmitters, television transmitters, can not be determined by calculation with sufficient accuracy. For this should be performed practical measurement of the field strength. If the measured values at the location of the device exceeds the applicable levels of compliance, should be observed for operation of the device in order to verify its normal work. If the detected deviation from normal functioning in the process of observation, additional measures should be taken, such as reorientation or moving the device. ** Outside the frequency range 150 kHz to 80 MHz, the field strength should be less than 3 V / m. *** Wireless RF communication frequencies and levels: 28 V/m: 450 MHz, ±5 kHz FM, 1 kHz sine; 810 MHz, 50% PM at 18 Hz; 870 MHz, 50% PM at 18 Hz; 930 MHz, 50% PM at 18 Hz; 1720 MHz, 50% PM at 217 Hz; 1845 MHz, 50% PM at 217 Hz; 1970 MHz, 50% PM at 217 Hz; 2450 MHz, 50% PM at 217 Hz; 27 V/m: 385 MHz, 50% PM at 18 Hz; 9 V/m: 710 MHz, 50% PM at 217 Hz; 745 MHz, 50% PM at 217 Hz; 780 MHz, 50% PM at 217 Hz; 5240 MHz, 50% PM at 217 Hz; 5500 MHz, 50% PM at 217 Hz; 5785 MHz, 50% PM at 217 Hz;			
<b>Attention!</b> Quasi peak value, and average value of interference voltage at the power clamps is checked on the frequency of 150 kHz to 30 MHz. <b>Attention!</b> Interference voltage measured between the phase conductor clamp and a reference ground of the measuring system (L1) and from the neutral wire between the clamp and the reference ground (N).			



Table 11 – Recommended values of separation distances between portable and mobile RF tools and device

<b>Recommended values of separation distances between portable and mobile RF tools and device</b>			
The device is intended for application in the electromagnetic environment in which monitored levels of emitted interference. Supplier or user of the device can avoid the influence of electromagnetic interference, providing the minimum separation distance between portable and mobile RF communications equipment (transmitters) and the device as recommended below, taking into account the maximum output power of communication equipment			
Rated maximum output power of transmitter, W	Separation distance, depending on the frequency of the transmitter, m		
	From 150 kHz to 80 MHz $d = 1,17 \sqrt{P}$	From 80 MHz to 800 MHz $d = 1,17 \sqrt{P}$	From 800 MHz to 2,5 GHz $d = 2,33 \sqrt{P}$
0,01	0,2 m	0,2 m	0,3 m
0,1	0,4 m	0,4 m	1,6 m
1	1,2 m	1,2 m	2,3 m
10	3,7 m	3,7 m	7,4 m
100	11,7 m	11,7 m	23,3 m
<p>In determining the recommended values of the spatial separation <b>d</b> for transmitters with a nominal maximum output power not listed above, in these equations are substituted rated maximum output power of the P, W, specified in the transmitter manufacturer's documentation.</p> <p><b>Attention!</b> Quasi peak value, and average value of interference voltage at the power clamps is checked on the frequency of 150 kHz to 30 MHz.</p> <p><b>Attention!</b> Interference voltage measured between the phase conductor clamp and a reference ground of the measuring system (L1) and from the neutral wire between the clamp and the reference ground (N).</p>			

### 31 Document revision history

Table 12 Document revision history

Revision	Changes	Date of change
1.0	Create a manual	10.03.2016
1.1	Added claim 6.3 The risks of using device «Ampir-01». Added chapter 30 Electromagnetic compatibility. General stylistic corrections and text formatting.	15.10.2016
1.2	Added Notified Body №1023 to CE-mark	07.08.2017
1.3	Chapter 17.3 Added description of information signal and safety requirements Chapter 17.5 Added information in accordance with EN 60601-1-8	19.10.2017
1.4	Chapter 2 – Corrections and additions added Chapter 4 – Corrections and additions added	12.09.2018
1.5	Chapter 19.2 - Corrections and additions accordance disinfectants	30.11.2018
1.6	Table 1. Main parameters and dimensions - Modification of consumption power	27.11.2020

**ANNEX 1**

"Tahat" company. Medical equipment and devices.

Legal address: Republic of Belarus, 220075, Minsk, ul. Selitskogo, d. 7, office 101.

Production address: Republic of Belarus, 220101, Minsk, Rokossovskogo av, 166, room 1N.

+375 17 375 58 48, +375 17 375 58 46,

service@tahat.by

**WARRANTY CARD № \_\_\_\_\_****Blood, blood substitute and infusion solution warming device AMPIR-01**

\_\_\_\_\_  
(day, month, model year, manufacturing number)

The product is fully complies with the drawings, specifications and requirements of technical normative legal acts.

The warranty period of the unit for at least 24 months from the date of commissioning, and no more than 36 months from the date of shipment.

Technical Control Department of \_\_\_\_\_  
company stamp

\_\_\_\_\_  
(date of receipt of the product at the manufacturer's warehouse)

\_\_\_\_\_  
(post, full name) stamp

\_\_\_\_\_  
(date of sale (supply) product the seller (supplier)

\_\_\_\_\_  
(post, full name) stamp

\_\_\_\_\_  
(date of sale (supply) product the seller (supplier)

\_\_\_\_\_  
(post, full name) stamp

\_\_\_\_\_  
(date of commissioning of device «Ampir-01»)

.....  
FUDI.942312.001 OM 1.6

Blood, blood substitute and infusion solution warming device «Ampir-01»

**ANNEX 2 (REFERENCE)**

Initial conditions:

Type of device Ampir-01\ Ampir-01A

Heat exchanger temperature «t set» =AUTO 36,6°C /MANUAL 41,5°C

The initial temperature of the solution «t sol» = 18 °C

Environment temperature «t env» = 22 °C

Schedule - infusion rate from 0 ml/h up to 6000 ml/h

The distance from the device to the patient 200 mm

The number of turns of line on the heat exchanger - 3

The outlet temperature of the line depending on the length and solution flow rate:

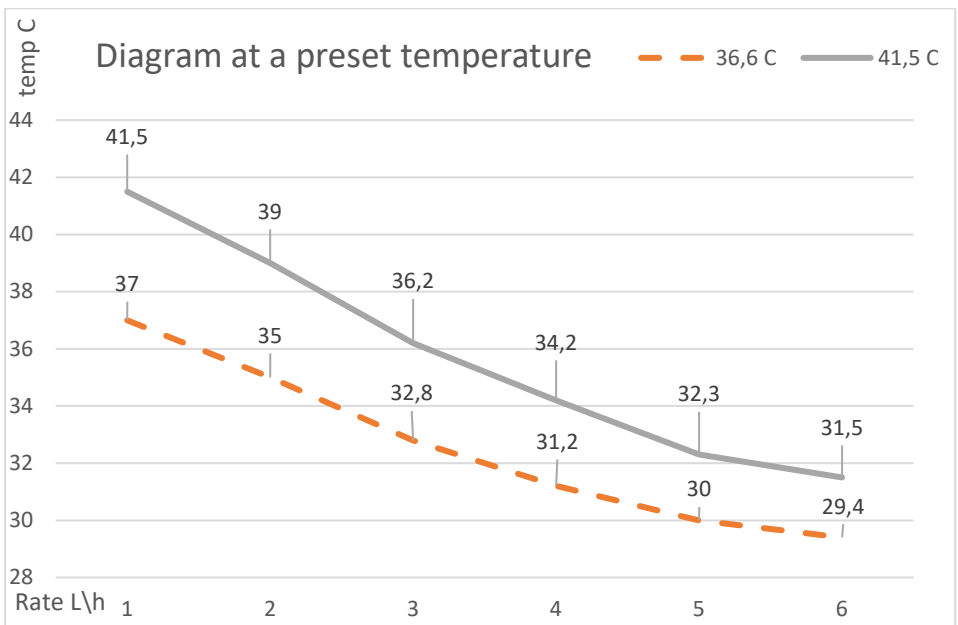

Initial conditions:

Type of device Ampir-01\ Ampir-01A