



PRODUCT DATA SHEET

CREATED ON 27.08.2024 ON WWW.GEISTER.COM

20-0281

Micro Bulldog Clamp (transient use) serrated 47mm 12mm angled 215g Type: Diethrich

Material: 1.4024

GTIN Number: 04057034042595

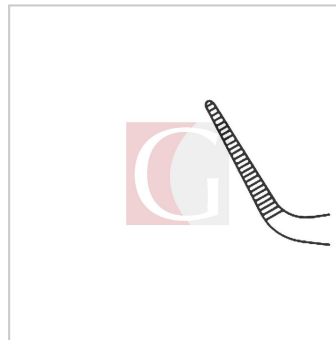

Illustrations, technical changes and the like are subject to product changes and are therefore not binding.



PRODUCT DATA SHEET

CREATED ON 27.08.2024 ON WWW.GEISTER.COM

26-0023

Scissors, TC 17cm curved Type: Mayo

Material: 1.4117/ 1.4305

GTIN Number: 04057034077276

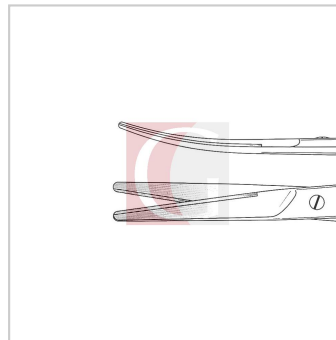

Illustrations, technical changes and the like are subject to product changes and are therefore not binding.



PRODUCT DATA SHEET

CREATED ON 27.08.2024 ON WWW.GEISTER.COM

30-0651

Wound Retractor (transient use) 4x4 19cm sharp 23mm Type: Adson

Material: 1.4021

GTIN Number: 04057034109731



Illustrations, technical changes and the like are subject to product changes and are therefore not binding.



PRODUCT DATA SHEET

CREATED ON 27.08.2024 ON WWW.GEISTER.COM

26-4124.SC

Vascular Scissors 18cm 60° Type: Potts-Smith Supercut

Material: 1.4117/ 1.4305

GTIN Number: 04057034080740

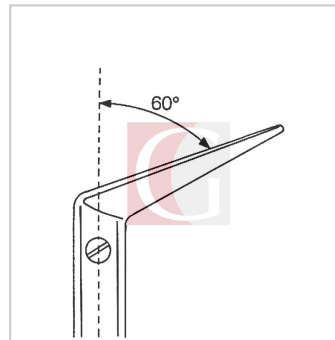

Illustrations, technical changes and the like are subject to product changes and are therefore not binding.



PRODUCT DATA SHEET

CREATED ON 27.08.2024 ON WWW.GEISTER.COM

03-0291

Microsurgical Needle Holder, TC, ratchet flat handle/ratchet 18cm tip 0.9mm TC (Type: Castroviejo-Ryder

Material: ...

GTIN Number: 04057034006757



Illustrations, technical changes and the like are subject to product changes and are therefore not binding.



PRODUCT DATA SHEET

CREATED ON 27.08.2024 ON WWW.GEISTER.COM

22-0492

Atraumatic Clamp (transient use) 17cm angled Type: DeBakey-Derra

Material: 1.4021

GTIN Number: 04057034056363

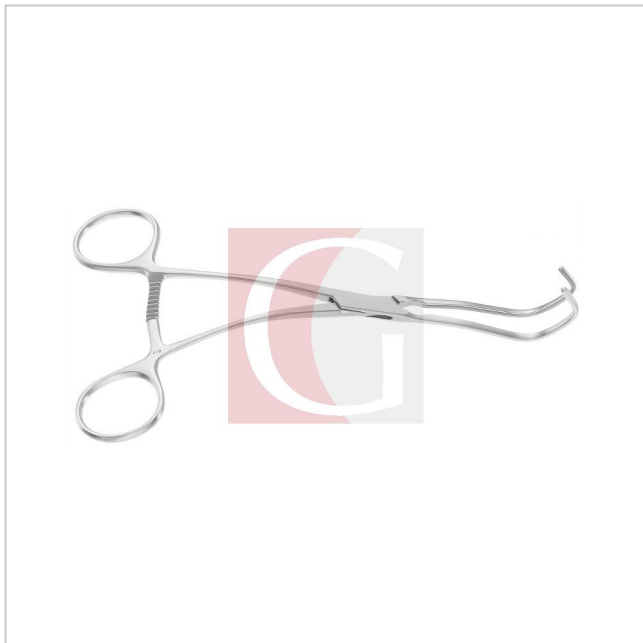

Illustrations, technical changes and the like are subject to product changes and are therefore not binding.



PRODUCT DATA SHEET

CREATED ON 27.08.2024 ON WWW.GEISTER.COM

10-0132

Atraumatic Tissue Forceps 19.5cm tip 3.5mm Type: DeBakey

Material: 1.4024

GTIN Number: 04057034018811

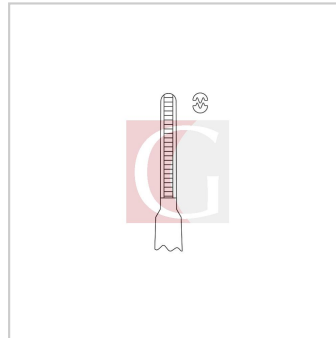

Illustrations, technical changes and the like are subject to product changes and are therefore not binding.



PRODUCT DATA SHEET

CREATED ON 27.08.2024 ON WWW.GEISTER.COM

10-0107

Atraumatic Tissue Forceps 19.5cm tip 1.5mm Type: DeBakey

Material: 1.4024

GTIN Number: 04057034018286

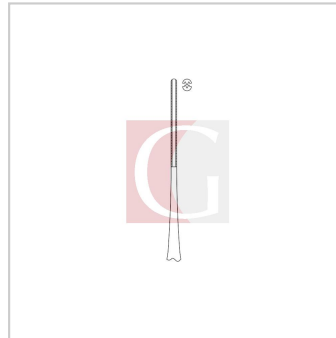

Illustrations, technical changes and the like are subject to product changes and are therefore not binding.



PRODUCT DATA SHEET

CREATED ON 27.08.2024 ON WWW.GEISTER.COM

22-0180

Atraumatic Clamp (transient use) 19cm angled Type: DeBakey

Material: 1.4021

GTIN Number: 04057034053157



Illustrations, technical changes and the like are subject to product changes and are therefore not binding.



PRODUCT DATA SHEET

CREATED ON 27.08.2024 ON WWW.GEISTER.COM

26-0101

Dissecting Scissors, TC 14cm curved Type: Metzenbaum

Material: 1.4117/ 1.4305

GTIN Number: 04057034077559

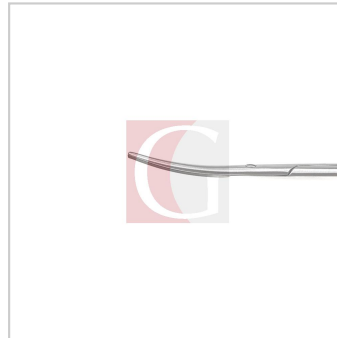

Illustrations, technical changes and the like are subject to product changes and are therefore not binding.



PRODUCT DATA SHEET

CREATED ON 27.08.2024 ON WWW.GEISTER.COM

24-0362

Needle Holder, TC 23cm TC (F) Type: DeBaKey

Material: 1.4021

GTIN Number: 04057034066119

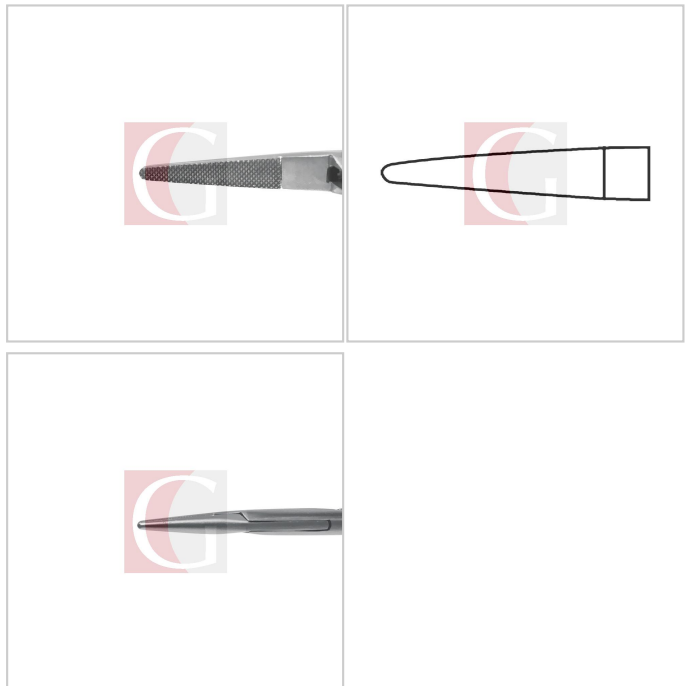
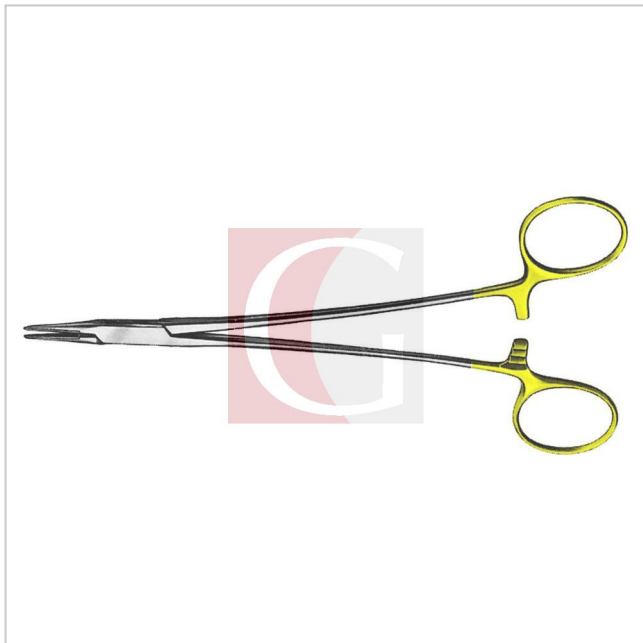

Illustrations, technical changes and the like are subject to product changes and are therefore not binding.



PRODUCT DATA SHEET

CREATED ON 27.08.2024 ON WWW.GEISTER.COM

24-1150

Microsurgical Needle Holder, TC, ratchet round handle 21cm 1.2mm [$\leq 5-0$] TC(M) Type: Streamline Fairgrip™ Ultra

Material: ...

GTIN Number: 04057034068083

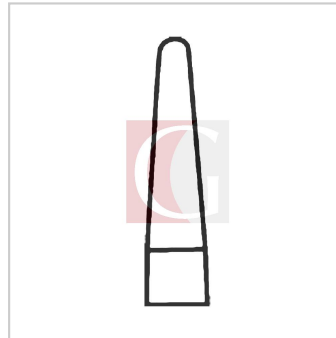

Illustrations, technical changes and the like are subject to product changes and are therefore not binding.