

Hysteroscopy

Endoscopes

*High-Definition, wide angle
Autoclavable, max.134°C/2,3bar/5min*

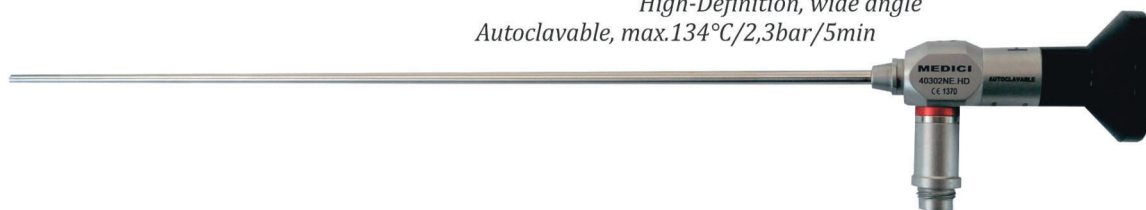

Medici Endoscope-line consists of high quality telescopes which have been developed according to the most modern technology and production standards. A new generation optic system assures a unique color, contrast and highly defined details reproduction, both in the center of the image and at the edges. A particularly true color reproduction and a markable depth of focus guarantee a natural picture. Distal and proximal sapphire windows provide an extremely high level of scratches resistance.

Ordering n°	Ø	Viewing Angle	Working length
40 260 CA.HD	2,0mm	0°	260mm
40 260 CE.HD	2,0mm	30°	260mm

Ordering n°	Ø	Viewing Angle	Working length
40 302 LA.HD	2,9mm	0°	302mm
40 302 LB.HD	2,9mm	12°	302mm
40 302 LE.HD	2,9mm	30°	302mm
40 302 LG.HD	2,9mm	70°	302mm

Ordering n°	Ø	Viewing Angle	Working length
40 302 NA.HD	4,0mm	0°	302mm
40 302 NB.HD	4,0mm	12°	302mm
40 302 ND.HD	4,0mm	25°	302mm
40 302 NE.HD	4,0mm	30°	302mm
40 302 NG.HD	4,0mm	70°	302mm

Hysteroscopy

Fiber Light Cables

Fiber Light Cables, Xenon Safe, Led White Light

Medici Optical Fiber Cable is made to resist and to shield against very high thermic energies especially in the use of **Xenon** light sources due to the fusion of light fibers in the cable itself.

This guarantees **20%** light more in the operating field.

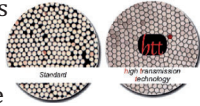

New High Performances White Line-LED Light Cables
New «WhiteLine» LED series Optical Fibers Light Cables have been designed and made up to be used with cutting edge LED Light Sources. By enhancing the transmission effectiveness of an already well-established and first-choice optical fibers light cable, light output and illumination, when operating with a LED light source together with a modern HD telescope, can be visibly and considerably increased.

3,5mm diameter, xenon safe, for Ø 4,0 - 2,9mm scopes

Xenon	LED	Working length	Xenon	LED	Working length
49 180 X	49 180 XL	1800mm	49 300 X	49 300 XL	3000mm
49 230 X	49 230 XL	2300mm	49 400 X	49 400 XL	4000mm
49 250 X	49 250 XL	2500mm	49 500 X	49 500 XL	5000mm

4,9mm diameter, xenon safe, for Ø 10,00mm scopes

Xenon	LED	Working length	Xenon	LED	Working length
49 180 P	49 180 PL	1800mm	49 300 P	49 300 PL	3000mm
49 230 P	49 230 PL	2300mm	49 400 P	49 400 PL	4000mm
49 250 P	49 250 PL	2500mm	49 500 P	49 500 PL	5000mm

Adapters for optic fiber light cable

Ordering n°	Projector end	Description	Ordering n°	Instrument end
49 110 A		Medici/Storz	49 010 A	
49 110 B		Acmi/Stryker	49 010 B	
49 110 C		Wolf/Dyonics	49 010 C	
49 110 D		Olympus/Acme		
49 110 F		Olympus new	49 010 F	

ENDOMED

Hysteroscopy

Monopolar Resectoscope Working Elements



Ordering n°	Description	Scope
4403100	Working Element, passive action, closed handle, 24-26Ch / 27-28,5Ch, Bayonet connection	Ø 4mm, WL302mm, 0°-12°-30°
4401100	Working Element, passive action, closed handle, 24-26Ch / 27-28,5Ch, Quick-Lock connection	Ø 4mm, WL302mm, 0°-12°-30°





Ordering n°	Description	Scope
4403110	Working Element, active action, closed handle, 24-26Ch / 27/28,5Ch, Bayonet	Ø 4mm, WL302mm, 0°-12°-30°
4401110	Working Element, active action, closed handle, 24-26Ch / 27/28,5Ch, Quick-Lock	Ø 4mm, WL302mm, 0°-12°-30°

Hysteroscopy

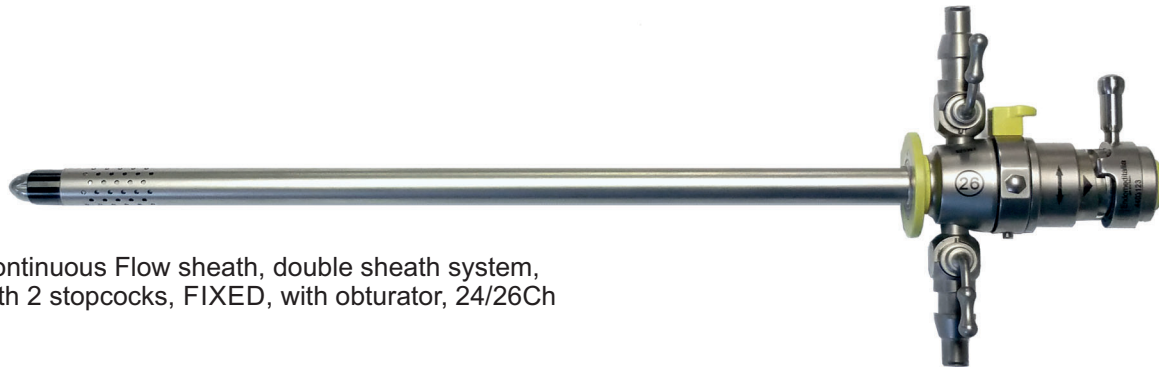
Resectoscope Sheaths





Continuous Flow sheath, double sheath system, with 2 stopcocks, **FIXED**, with obturator, 24/26Ch

System	Inner sheath	Inner Tip	Outer sheath	Outer sheath Model	
4413120	4413121	Oblique	4413122	all around perforation	
4413120A	4413121A	Straight	4413122A	upper/lower perforation	
			4413122B	all around, long holes perforation	

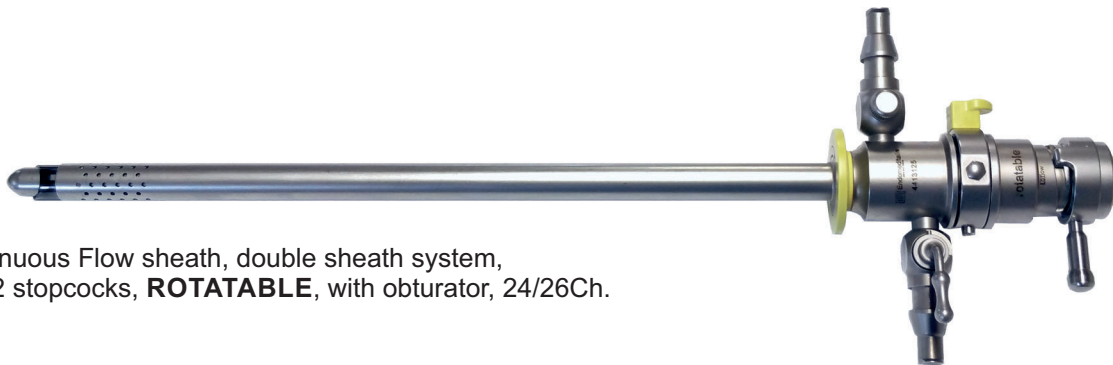
Obturator	4413123
-----------	---------

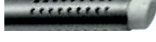

Continuous Flow sheath, double sheath system, with 2 stopcocks, **ROTATABLE**, with obturator, 24/26Ch.

System	Inner sheath	Inner Tip	Outer sheath	Outer sheath Model	
4413125	4413126	Oblique	4413127A	perforation all around	
4413125A	4413126A	Straight	4413127B	perforation all around, long holes	
			4413127C	upper perforation long holes	
			4413127D	upper and lower perforation	
			4413127E	upper perforation	
			4413127F	perforation all around/extra small holes	

Obturator	4413123
-----------	---------

Monopolar Cables



Meters	Ordering n°	Meters	Ordering n°	Meters	Ordering n°	Ordering n°
3mt	2373066	3mt	2373069	3mt	2373067	2370016
5mt	2375066	5mt	2375069	5mt	2375067	

Hysteroscopy

Resectoscope Sheaths / Obturators



Standard sheath, with 1 stopcock, **oblique sheath end**, with obturator.

	System	Sheath	Charr.	Obturator
Standard sheath, with 1 stopcock	4413117	4413115	24Ch	4413123
	4413118	4413116	27Ch	4413123
Standard sheath, with 1 stopcock, with long beak.	4413111	4413112	24Ch	4413156
	4413114	4413113	27Ch	4413157



Ordering n°	Description
4413130	Deflecting tip 24Ch obturator, yellow
4413131	Deflecting tip 27Ch obturator, black



Ordering n°	Description
4413137	24Ch Visual Obturator with 6Ch Instrument channel, yellow
4413138	27Ch Visual Obturator with 9Ch Instrument channel, black



Ordering n°	Description
4413139	24Ch Visual Obturator, yellow
4413134	27Ch Visual Obturator, black

Hysteroscopy

Resectoscope HF Electrodes



Monopolar Resectoscope HF Electrodes

Description	24Ch Yellow	27Ch Brown
 HF 30° angled Loop Electrode, for 30°scope, cutting wire 0,35mm	4423200	4423201
 HF Loop Electrode, straight cutting wire 0,35mm	4423202	4423212
 HF Loop Electrode, 90°angled, for 0° scope, cutting wire 0,35mm	4423213	4423214
 HF Knife Electrode	4423203	4423203A
 HF Ball Electrode, 3mm	4423204	4423204A
 HF Ball Electrode, 5mm	4423205	4423205A
 HF coagulating cylinder Electrode, 3mm	4423206	4423206A
 HF coagulating cylinder Electrode, 5mm	4423207	4423207A
 HF Cone shaped Electrode	4423208	
 HF Spiked Vapor electrode, 3mm	4423215	4423215A
 HF Spiked Vapor electrode, 5mm	4423216	4423216A
 HF Vaporization Electrode, 3mm	4423217	4423217A
 HF Vaporization Electrode, 5mm	4423218	4423218A
 HF Knife Electrode	4423225	
 HF smooth band-Electrode for 0°scope	4423226	
 HF smooth band Electrode for 30°scope	4423230	
 Curette, sharp	4423220	
 Curette, blunt	4423227	
 HF Band-Vaporization Electrode	4423228	
 HF needle, Electrode, angled	4423232	
 Preparation Cold Knife, 90°	4321342	
 Preparation Cold Knife H, 90°	4321345	
 Preparation Cold Knife, Loop straight	4321340	



4423990 Sterilization stainless steel tube for Electrodes and cold knives







ENDOMED

Hysteroscopy

Scissors and Forceps, WL 410mm, semirigid



Hysteroscopy Forceps
Semirigid, WL 410 mm

Description	5 Ch	7 Ch	
Biopsy Forceps, oval cup, sharp	4641116	4641123	
Scissors, pointed tips	4641916	4641923	
Scissors, blunt tips	4641216	4641223	
Cutting Biopsy Punch	4641816	4641823	
Alligator Forceps	4641016	4641023	
Grasping Forceps, cup, serrated	4641716	4641723	
Tenaculum Forceps	4641316	4641323	