



# Technical Publications

5929163-1EN

Rev. 4



LOGIQ Totus™ User Manual

Version R4

Operating Documentation

Copyright 2024 By GE HealthCare.

# ***Regulatory Requirement***

**LOGIQ Totus complies with regulatory requirements of the following European Regulation 2017/745 EU concerning medical devices.**



**This User Manual is a reference for the LOGIQ Totus. It applies to Version R4 software for the LOGIQ Totus ultrasound system.**

GE HealthCare  
P.O. Box 414, Milwaukee, Wisconsin 53201 U.S.A.  
(Asia, Pacific, Latin America, North America)

GE HealthCare GmbH  
Peter-Muller-Strasse 24-26  
40468 Dusseldorf  
Germany  
TEL: 49 211.73.74440; FAX: 49 212.28.02.380

---

# Revision History

## Reason for Change

REV	DATE (YYYY/MM/DD)	REASON FOR CHANGE
Rev. 1	2023/11/18	Initial release
Rev. 2	2023/12/08	Enhancement feedback
Rev. 3	2024/02/14	Enhancement feedback
Rev. 4	2025/05/10	Update Authorized Representative information in Belarus

## List of Effective Pages

PAGE NUMBER	REVISION NUMBER	PAGE NUMBER	REVISION NUMBER
Title Page	Rev. 4	Chapter 6	Rev. 4
Revision History	Rev. 4	Chapter 7	Rev. 4
Regulatory Requirements	Rev. 4	Chapter 8	Rev. 4
Table of Contents	Rev. 4	Chapter 9	Rev. 4
Chapter 1	Rev. 4	Chapter 10	Rev. 4
Chapter 2	Rev. 4	Chapter 11	Rev. 4
Chapter 3	Rev. 4	Chapter 12	Rev. 4
Chapter 4	Rev. 4	Chapter 13	Rev. 4
Chapter 5	Rev. 4	Index	Rev. 4

---

Please verify that you are using the latest revision of this document. Information pertaining to this document is maintained on MyWorkshop. If you need to know the latest revision, contact your distributor, local GE HealthCare Sales Representative or in the USA call the GE HealthCare Ultrasound Clinical Answer Center at 1 800 682 5327 or 1 262 524 5698.

---

---

This page intentionally left blank.

---

# Regulatory Requirements

## Conformance Standards

The following classifications are in accordance with the IEC/EN 60601-1:

- According to 2017/745 Medical Devices Regulation, this is Class IIa Medical Device.
- According to IEC/EN 60601-1,
  - Equipment is Class I, INTERNALLY POWERED ME EQUIPMENT, Type BF or CF Applied Parts.
- According to CISPR 11,
  - Equipment is Group 1, Class A ISM Equipment.
- According to IEC 60529,
  - The footswitch rate IPX8 is suitable for use in surgical rooms.
  - Probe head (immersible portion) and cable are IPX7  
Probe connector is not waterproof.
  - The Vscan Air CL which is wireless probe is classified to IP67, and its charger classified to IP41.

---

## Conformance Standards (continued)

This product complies with the regulatory requirement of the following:

- European Regulation 2017/745 EU concerning medical device: the CE label affixed to the product testifies compliance to the Regulation.

The location of the CE marking is shown in the Safety chapter of this manual.



### **Authorized EU Representative**

European registered place of business:

GE Medical Systems SCS

283 rue de la Minière

78530 BUC, France

Tel: +33 (0) 1 30 70 4040

### **Authorized Swiss Representative**

GE Medical Systems (Schweiz) AG

Europa-Strasse 31

8152 Glattbrugg

Switzerland



- ANSI/AAMI ES 60601-1:2005/A2:2021, CAN/CSA-C22.2 No. 60601-1 (Amendment 2:2022)
- Certified to CSA CAN/CSA-C22.2 No60601-1 :14 General requirements for safety
- CE Marked to European Regulation 2017/745 EU concerning medical device Conforms to the following standards for safety:
- IEC/EN 60601-1 3.2 Edition. Medical electrical equipment - Part 1: General requirements for basic safety and essential performance
- IEC/EN 60601-1-2 Medical electrical equipment - Part 1-2: General requirements for safety - Collateral Standard: Electromagnetic compatibility - requirements and tests
- IEC/EN 60601-1-6 Medical electrical equipment Part 1-6: General requirements basic safety and essential performance - Collateral Standard: Usability

---

## Conformance Standards (continued)

- IEC/EN 60601-2-37 Medical electrical equipment - Part 2-37: Particular requirements for the safety of ultrasonic medical diagnostic and monitoring equipment
- IEC 61157 (Standard means for the reporting of the acoustic output of medical diagnostic ultrasonic equipment)
- IEC/EN 62366 Application of usability engineering to medical devices
- IEC/EN 62304 Software Life Cycle Processes
- IEC/EN 62359 Ultrasonic - Field characterization - Test methods for the determination of thermal and mechanical indices related to medical diagnostic ultrasonic fields
- EN ISO 15223-1 : Symbols to be used with medical device labels, labelling and information to be supplied
- ISO 10993-1 Biological evaluation of medical devices - Part 1 Evaluation and testing
- ISO 14971 : (Medical devices - Application of risk management to medical devices)
- EMC Emissions Group 1, Class A device requirements as per Sub clause 4.2 of CISPR 11
- WEEE (Waste Electrical and Electronic Equipment)
- ROHS according to 2011/65/EU Including national deviations
- Wireless equipment shall be certified to FCC, RED and Japan Radio Law.
- Medical Device Good Manufacturing Practice Manual issued by the FDA (Food and Drug Administration, Department of Health, USA)

---

## Certifications

- GE HealthCare Medical Systems is ISO 13485 certified.

## Original Documentation

- The original document was written in English.

## Importer Information

- Türkiye

GE Medical Systems Türkiye Ltd. Şti.  
I sentepe Mah. Harman Sok. No: 8  
34394 Şişli İstanbul Türkiye

## Kazakhstan - Authorized representative in Kazakhstan

This information is only valid for Kazakhstan

English	Kazakh	Russian
GE HealthCare Kazakhstan LLP 26/41, Zenkova Street, Medeu District, Almaty, 050010, Kazakhstan  T +7 727 3560020	«Джені Хелскае Қазақстан» ЖШС Қазақстан, Алматы қаласы, Медеу ауданы, кәресі ЗЕНКОВ, үй 26/41, пошталық индексі 050010 T +7 727 3560020	ОО «Джені Хелскае Қазақстан» Қазақстан, город Алматы, Медеуский район, улица Зенкова, дом 26/41, почтовый индекс 050010 T +7 727 3560020

## Belarus - Authorized Representative in Belarus

This information is only valid for Belarus

Уполномоченный представитель производителя для получения претензий в Республике Беларусь
ОО «Джені Хелскае» 123113 Российская Федерация, Москва, вн.тер.г. муниципальный округ "Тропарево-Куньинский" Пресненская набережная, д. 10. Тел. справочной службы: 8 800 333 6967 Тел. офиса: +7 495 730 0931, факс: +7 495 730 0932  88003336967@gehealthcare.com <a href="http://www.gehealthcare.ru/">http://www.gehealthcare.ru/</a>



---

# Table of Contents

Conformance Standards	i-3
Certifications	i-6
Original Documentation	i-6
Importer Information	i-6
Kazakhstan - Authorized representative in Kazakhstan	i-6
Belarus - Authorized Representative in Belarus	i-6
<b>Table of Contents</b>	
<b>Chapter 1 — Introduction</b>	
<b>System Overview</b>	
Attention	1-2
Documentation	1-3
Principles of Operation	1-8
Indications for Use	1-9
Contraindication	1-10
Prescription Device	1-10
Patient Population	1-10
Potential additional considerations of use environment	1-11
<b>Contact Information</b>	
Contacting GE HealthCare Ultrasound	1-12
Manufacturer	1-17
<b>Chapter 2 — Safety</b>	
<b>Owner Responsibility</b>	
Owner requirements	2-2
Notice against user modification	2-2
Reporting	2-3
<b>Safety Precautions</b>	
Precaution Levels	2-4
Hazard Symbols	2-5
Patient Safety	2-7
Equipment and Personnel Safety	2-11
Classifications	2-18
EMC (Electromagnetic Compatibility)	2-19
Patient Environmental Devices (LCD monitor)	2-38
Acoustic Output	2-41
WEEE Passport	2-45
RoHS LOGIQ Totus Hazardous Substances	2-46
India Battery Waste Management	2-47
Safe Product and Packaging Disposal	2-47

---

<b>Device Labels</b>	
Label Icon Description- - - - -	2-49
Label on the packing box- - - - -	2-59
Probe Labeling - - - - -	2-60
<b>Chapter 3 — Preparing the System for Use</b>	
<b>Site Requirements</b>	
Introduction - - - - -	3-2
Before the system arrives - - - - -	3-3
Environmental Requirements- - - - -	3-4
<b>Console Overview</b>	
Console Graphics (LCD monitor) - - - - -	3-6
Peripheral/Accessory Connection- - - - -	3-13
<b>Powering the System</b>	
Connecting the System - - - - -	3-19
Circuit breaker - - - - -	3-21
Power On - - - - -	3-22
<b>System Language Configuration</b>	
Select the System Language and Date/Time Format - - - - -	3-40
<b>Connecting the Probe</b>	
Connecting the Probe - - - - -	3-46
Unpacking - - - - -	3-47
Chirping noise - - - - -	3-48
Cable Handling - - - - -	3-48
Selecting probes- - - - -	3-49
Deactivating the Probe - - - - -	3-50
Disconnecting the Probe - - - - -	3-50
Storing the Probe - - - - -	3-51
Storage/Transportation - - - - -	3-51
<b>Operator Controls</b>	
Control Panel Map - - - - -	3-52
Control panel adjustment- - - - -	3-53
Keyboard - - - - -	3-55
Touch Panel- - - - -	3-58
Mode, Display and Print - - - - -	3-60
Measurement and Annotation - - - - -	3-61
<b>Monitor</b>	
Adjusting the Monitor Position - - - - -	3-62
Locking/unlocking the Monitor - - - - -	3-65
Adjusting the Monitor - - - - -	3-66
Wide Screen Monitor Display Settings - - - - -	3-68
Test Patterns - - - - -	3-72
<b>Monitor Display</b>	
Monitor Display- - - - -	3-74
Monitor Display Layout - - - - -	3-76
Using the Monitor Display Controls to Manage Images- - - - -	3-81
<b>System Positioning/Transporting</b>	
Moving the System - - - - -	3-82

---

Wheels	3-86
Transporting the System	3-89
Acclimation Time	3-90
<b>Chapter 4 — Preparing for an Exam</b>	
<b>Beginning an Exam</b>	
Introduction	4-2
Patient Screen	4-3
OB Exam	4-7
<b>Starting an examination</b>	
Cautions and Warnings	4-10
Creating a new patient record	4-12
Perform an exam	4-13
Ending an exam	4-14
Scanning without entering any patient data	4-14
Starting a new exam on an existing patient	4-15
Retrieve Patient/Exam Information from Worklist	4-16
Sending Multiple Exams and Patients with Single Click to PACS	4-17
Change Patient Information except Patient ID and scan	4-17
Change Patient ID of the existing patient (Edit & Copy)	4-18
<b>Retrieving and editing archived information</b>	
Searching for an existing patient	4-21
Changing Patient Information or an Exam	4-24
Deleting the existing patient/exam/image	4-25
<b>MyPreset</b>	
Overview	4-27
Activating MyPreset	4-27
Arranging MyPreset Tab	4-29
<b>Chapter 5 — Optimizing the Image</b>	
<b>Optimizing B-Mode</b>	
Intended Uses	5-2
B-Mode Scanning Hints	5-3
B-Mode Controls	5-4
Auto Optimize	5-8
Continuous Tissue Optimization (CTO)	5-10
SRI-HD (High Detection Speckle Reduction Imaging)	5-11
CrossXBeam	5-14
B-Flow	5-15
LOGIQView	5-19
B Steer+ (Option)	5-21
Preset	5-25
Touch TGC	5-26
Speed of Sound (SoS) Tissue Imaging	5-28
Minimizing Grating Lobe/Side Lobe Artifacts	5-29
<b>Optimizing M-Mode</b>	
Intended Use	5-31
Introduction	5-31
Typical exam protocol	5-32

---

M-Mode Controls	5-32
Anatomical M-Mode (AMM) and Anatomical Color M-Mode (ACMM)	5-33
<b>Optimizing Color Flow</b>	
Intended Use	5-35
Introduction	5-35
Activating Color Flow	5-37
Color Flow Mode Controls	5-37
Radiantflow	5-40
Flow Model Shortcuts	5-41
Power Doppler Imaging (PDI)	5-44
<b>Optimizing M Color Flow</b>	
M Color Flow Mode	5-48
<b>Optimizing Spectral Doppler</b>	
Intended Use	5-49
Spectral Doppler Display	5-51
PW Doppler Mode Display	5-52
Doppler Mode Controls	5-53
<b>Using 3D</b>	
Overview	5-57
3D Acquisition	5-58
3D Acquisition Parameter Description	5-60
Manipulating the Volume of Interest	5-62
Easy 3D	5-64
Advanced 3D	5-66
Movie 3D	5-69
Tru3D and Volume Measurement	5-70
<b>Chapter 6 — Scanning/Display Functions</b>	
<b>Freezing an Image</b>	
Introduction	6-2
Freezing an image	6-2
<b>Using CINE</b>	
Introduction	6-3
Using CINE	6-5
Mark CINE	6-7
Preview	6-8
Background Store	6-8
Image Storage Hints	6-9
Cine Capture	6-10
<b>Image Zoom</b>	
Overview	6-14
HD Zoom	6-15
Pan Zoom	6-16
Magnification Zoom	6-17
<b>Split Screen</b>	
Overview	6-18
Dual screen	6-18
Quad screen	6-19

---

Simultaneous mode .....	6-19
Dual Caliper .....	6-19
<b>Annotating an Image</b>	
Introduction .....	6-23
Adding Comments to an Image .....	6-25
Body Patterns.....	6-35
<b>Using the Fast Key</b>	
Overview .....	6-44
Create a Fast Key .....	6-44
Start a Fast Key .....	6-45
Backup and Restore the Fast Key .....	6-45
<b>Chapter 7 — General Measurements and Calculations</b>	
<b>Introduction</b>	
Introduction .....	7-2
Basic Operation .....	7-3
Measurement Controls .....	7-6
Touch Panel.....	7-7
Exam category/Study/Measurement.....	7-11
General Instructions .....	7-12
Measurement Cursor .....	7-14
Copy, move and paste measurement tools .....	7-15
Performing Measurements on Saved Images .....	7-16
<b>Generic Measurements</b>	
Overview .....	7-18
B-Mode Measurements .....	7-19
M-Mode Measurements.....	7-29
Doppler Mode Measurements .....	7-32
Helpful hints .....	7-37
<b>Mode Measurements</b>	
B-Mode Measurements .....	7-38
Doppler Mode Measurements .....	7-45
M-Mode Measurements.....	7-56
<b>Worksheet</b>	
Introduction .....	7-58
To view a worksheet .....	7-59
To edit a worksheet.....	7-60
Recording Worksheet .....	7-64
OB Worksheet .....	7-65
Vascular Worksheet .....	7-67
<b>Anatomical Survey</b>	
Overview .....	7-71
Editing .....	7-72
<b>Measurement and Calculation Setup</b>	
Starting Study and Measurement Setup .....	7-75
Display/hide a folder or a measurement in the Touch Panel .....	7-80
Setting up an automatic measurement flow .....	7-85
Change the tool used to make a measurement .....	7-86

---

Adding Folders and Measurements -----	7-87
M & A Advanced Preset -----	7-100
Doppler tab - Modify Calculation-----	7-105
Application Measurement Preset -----	7-106
<b>Chapter 8 — Application M&amp;A</b>	
<b>General Information</b>	
Overview -----	8-2
General Guidelines -----	8-2
<b>Abdomen</b>	
Overview -----	8-3
<b>Small Parts</b>	
B-Mode Measurements -----	8-4
<b>OB</b>	
Introduction -----	8-6
OB Type change-----	8-7
To Start an Obstetrics Exam -----	8-8
OB Measurements Performed Over Multiple Planes-----	8-12
OB Calculation -----	8-15
OB Graphs-----	8-17
OB-Multigestational-----	8-26
OB Table Editor -----	8-28
<b>GYN</b>	
Introduction -----	8-42
B-Mode Measurements -----	8-42
<b>Cardiac</b>	
Overview -----	8-45
Naming Format for Cardiac Measurements -----	8-45
Cardiac Doppler Measurements-----	8-49
<b>Vascular</b>	
Introduction -----	8-50
IMT Measurement-----	8-55
Auto Vascular Calculation -----	8-65
Manual Vascular Calculation -----	8-69
Intravessel ratio -----	8-70
Bypass Graft Anastomosis Graph -----	8-72
<b>Urology</b>	
Introduction -----	8-75
Bladder Volume -----	8-75
Renal Volume-----	8-76
Prostate Volume-----	8-76
Pelvic Floor Measurements -----	8-78
<b>Pediatrics</b>	
Overview -----	8-81
Pediatrics Hip -----	8-82
<b>Chapter 9 — Recording images</b>	
<b>Getting Set Up to Record Images</b>	
Overview -----	9-2

---

Image Management Guide	9-4
Adding Devices	9-5
Adding a Dataflow	9-5
Adding Devices to a Print Button	9-5
<b>Storing Images and Cineloops</b>	
Storing an image	9-6
Storing a cine loop	9-7
<b>Review images in archive</b>	
Review the patient exam/image	9-10
Active Images	9-11
Image Tags	9-13
Image Reorder	9-18
Image History	9-20
<b>Clipboard</b>	
Clipboard icon	9-22
Saving the image /cine to the Clipboard	9-22
Previewing Clipboard Images	9-23
Recalling Images from the Clipboard	9-23
To delete an image from the clipboard	9-23
<b>Save As</b>	
Overview	9-24
SaveAs	9-24
'SaveAs' Images	9-28
Storing Images with More Resolution	9-28
<b>Unified Background Export</b>	
Export from Patient Screen	9-29
Export from Active Image Screen	9-31
Spooler Screen	9-32
Spooler Status Icons	9-33
<b>DICOM Viewer</b>	
Installing the DICOM Viewer	9-34
Configuring the DICOM Viewer	9-35
<b>Data Transfer</b>	
Overview	9-36
Export/Import	9-36
Worklist (Search and retrieve the Patient/Exam information)	9-38
<b>External drives</b>	
Intended Use	9-39
USB Hard Disk Drive and USB Flash Drive	9-40
USB Quick Save	9-45
<b>Printing Options</b>	
Setting up Digital Peripherals	9-46
External Paper Printer	9-54
<b>Portable Exam</b>	
Perform a Portable Exam (Using the Worklist)	9-58

---

## Chapter 10 — Customizing Your System

### Presets

Overview	10-2
----------	------

### System Presets

Overview	10-6
Changing system parameters	10-7
System/General Preset Menu	10-8
System/System Display Preset Menu	10-12
System/System Imaging Preset Menu	10-15
System/System Measure Preset Menu	10-19
System Backup and Restore Preset Menu	10-22
System/Peripherals Preset Menu	10-24
System/User Configurable Key	10-26
System/About Preset Menu	10-29
Licenses	10-29
System/Scanner Apps Info	10-29

### Imaging Presets

Overview	10-30
Changing imaging presets	10-31
General	10-31

### Comments Libraries Presets

Overview	10-33
Comments Libraries/Libraries Preset Menu	10-33
Comments Libraries/Comments Preset Menu	10-36
Comments Libraries/Applications Preset Menu	10-37
Comments Libraries/Mapping Preset Menu	10-39

### Body Patterns Presets

Overview	10-42
Body Pattern Libraries/Libraries Preset Menu	10-42
Body Pattern Libraries/Body Patterns Preset Menu	10-44
Body Pattern Libraries/Applications Preset Menu	10-45

### Application Presets

Overview	10-47
----------	-------

### User Specific

#### Test Patterns

##### 3D/4D

Overview	10-56
4D Presets	10-56

#### Configuring Connectivity

Connection Manager	10-62
Scanner Page	10-63
Network Page	10-65
Proxy	10-70
Special Devices Page	10-92



---

<b>Measure Reports</b>	
<b>System Administration</b>	
Overview	10-141
Administrator Tasks	10-142
Privacy and Security	10-142
System Admin	10-150
Users	10-153
Logon	10-154
Groups	10-167
System Password	10-170
Disk Encryption	10-171
Audit Report and System Log Server Configuration	10-179
<b>Imaging Preset Manager</b>	
Overview	10-182
Creating a User-Defined Application Preset	10-182
Sharing User Presets between LOGIQ Totus Systems	10-187
Retain Field of View	10-188
<b>Backup and Restore</b>	
Overview	10-189
<b>Search</b>	
Utility Parameter Search	10-194
<b>Chapter 11 — Probes and Biopsy</b>	
<b>Probe Overview</b>	
Ergonomics	11-2
Supported Probes	11-2
Probe orientation	11-10
Probe Naming Conventions	11-10
<b>Probe Safety</b>	
Care and Handling	11-11
Handling precautions	11-12
Electrical shock hazard	11-13
Special handling instructions	11-14
Probe handling and infection control	11-16
<b>Care and Maintenance</b>	
Inspecting probes	11-17
Probe Reprocessing	11-19
Probe Cleaning and Disinfecting Notes	11-38
Probe Disinfectants	11-41
Coupling Gels	11-46
V Nav Cleaning Requirements	11-48
Planned Maintenance	11-49
Automatic Probe Diagnostics	11-50
Probe Check (not available in all countries)	11-51
Probe Care Cards	11-54
Returning/Shipping Probes and Repair Parts	11-56

---

<b>Biopsy Special Concerns</b>	
Precautions Concerning the Use of Biopsy Procedures - - - - -	11-57
Freehand Biopsy - - - - -	11-59
Biopsy Guide Sterilization - - - - -	11-60
<b>Performing a Biopsy</b>	
Displaying the Guidezone - - - - -	11-61
Preparing the Biopsy Guide Attachment - - - - -	11-66
4D Probe Biopsy Needle Path Selection - - - - -	11-86
Biopsy Needle Path Verification - - - - -	11-86
The Biopsy Procedure- - - - -	11-87
Post Biopsy - - - - -	11-88
Probe Biopsy Reprocessing- - - - -	11-89
<b>Chapter 12 — User Maintenance</b>	
<b>System Data</b>	
Features/Specifications - - - - -	12-2
Clinical Measurement Accuracy - - - - -	12-7
<b>Privacy and Security</b>	
Introduction - - - - -	12-14
Privacy & Security Environment - - - - -	12-14
How to contact GE HealthCare - - - - -	12-14
Identity Provisioning - - - - -	12-15
Network Infrastructure - - - - -	12-16
<b>Anti-Virus Software Note</b>	
LOGIQ Totus Security - - - - -	12-17
<b>Loading Windows Patches</b>	
Loading a Windows Patch - - - - -	12-20
Performing Software Patch Verification - - - - -	12-21
Patch Installation Notes - - - - -	12-24
Reloading Software - - - - -	12-24
<b>Software Download</b>	
Overview - - - - -	12-25
<b>Base Image and Software Load</b>	
Base Image and Software Load Procedure - - - - -	12-30
<b>Copyrighted Material</b>	
Viewing Copyrighted Third Party Software License Information - - - - -	12-31
<b>System Care and Maintenance</b>	
Overview - - - - -	12-32
Maintenance Schedule - - - - -	12-33
Cleaning and Disinfecting the System - - - - -	12-34
Other Maintenance - - - - -	12-43
<b>Quality Assurance</b>	
Introduction - - - - -	12-51
Typical Tests to Perform - - - - -	12-52
Baselines - - - - -	12-54
Periodic Checks - - - - -	12-54
Results - - - - -	12-55
System Setup - - - - -	12-55

Test Procedures	12-56
Setting up a Record Keeping System	12-65
Ultrasound Quality Assurance Checklist	12-66
<b>Image Quality Check</b>	
Image Quality Check (IQC)	12-67
<b>Assistance</b>	
Supplies/Accessories	12-68
<b>Chapter 13 — Advanced Features</b>	
<b>Table of Contents</b>	
<b>Using 4D</b>	
4D Introduction	13-4
Features supported with 4D	13-4
4D Principles of Operation	13-5
4D Operational Controls	13-13
4D Presets	13-16
Performing a 4D Scan	13-17
Tomographic Ultrasound Imaging (TUI)	13-41
SonoRenderlive	13-45
OmniView	13-47
STIC (Spatio-Temporal Image Correlation)	13-51
<b>Contrast Imaging</b>	
Overview	13-55
Contrast Imaging Overview	13-57
Mode	13-59
Contrast MVI Mode	13-59
Contrast Presets	13-60
Sonazoid™ Contrast Agent	13-60
Contrast Controls	13-61
Static 3D with Contrast	13-66
Time Intensity Curve (TIC) Analysis	13-68
<b>Strain Elastography</b>	
Description	13-100
Using Strain Elastography	13-101
Clinical Applications	13-103
Strain Elastography Controls	13-103
Application Parameters	13-105
General Imaging Parameters by Application/Probe/Feature	13-105
<b>Elastography Analysis</b>	
Overview	13-106
Using Elastography Analysis	13-106
Elastography Analysis Display Description	13-109
Additional Notes for Elastography Analysis	13-110
<b>Shear Wave Elastography</b>	
Overview	13-111
Intended Uses	13-113
Configuring Shear Wave	13-113
Activating Shear Wave	13-117

Shear Wave Display -----	13-118
Shear Wave Touch Panel -----	13-124
Using Shear Wave (SW) -----	13-129
Typical Exam Protocol (Liver) -----	13-130
Shear Wave Measurements-----	13-132
Scanning Hints -----	13-140
<b>Ultrasound-Guided Attenuation Parameter (UGAP) Option</b>	
Overview -----	13-141
Activation-----	13-142
Measurement and Worksheet -----	13-143
2D Color Map-----	13-146
<b>Continuous Wave Doppler (CWD)</b>	
Overview -----	13-147
Steerable -----	13-147
Non-Imaging -----	13-147
Activating CW Doppler -----	13-148
Exiting CW Doppler-----	13-148
<b>Tissue Velocity Imaging (TVI)</b>	
Intended Use -----	13-149
Activating TVI-----	13-149
Optimizing TVI -----	13-150
TVI and TVD -----	13-151
<b>Quantitative Analysis (QAnalysis)</b>	
Overview -----	13-152
Quantitative Flow Analysis-----	13-152
Selecting QAnalysis Image Range -----	13-158
Activating QAnalysis -----	13-158
Common QAnalysis Function-----	13-159
<b>Stress Echo</b>	
Introduction -----	13-172
Getting started with a stress study -----	13-173
Image acquisition -----	13-176
Continuous Capture mode-----	13-182
Analysis-----	13-194
Editing/Creating template -----	13-198
Wall Motion Segment Setup -----	13-205
Utility Application Settings for Protocol -----	13-205
Report -----	13-206
<b>Cardiac Automated Functional Imaging (Cardiac Strain)</b>	
Cardiac Strain -----	13-208
<b>Auto EF</b>	
Auto EF Measurements -----	13-231
Acquisition -----	13-231
Starting AutoEF -----	13-232
Tracking Validation -----	13-233
Possible causes of poor tracking -----	13-233
<b>ECG</b>	
Overview -----	13-238

---

ECG Cable-----	13-240
Physiological Trace Monitor Display-----	13-241
ECG Touch Panel-----	13-242
<b>Volume Navigation</b>	
Introduction-----	13-244
Load the Volume Dataset-----	13-249
Query/Retrieve-----	13-250
Setting Up V Nav sensors-----	13-258
Activate V-Nav-----	13-262
Using V-Nav-----	13-268
Perform the registration-----	13-270
Advanced GPS Markers-----	13-281
V Nav Trackers-----	13-290
Setting up the V Nav Needle Tip Tracker-----	13-292
V Nav Virtual Tracker (Part of V Nav Option)-----	13-294
Calibrating the V Nav Virtual Tracker-----	13-297
Active Tracker-----	13-298
<b>Breast Productivity Package</b>	
Overview-----	13-302
Breast Lesion M&A-----	13-302
Breast Measure Assistant (Auto Contour)-----	13-305
Breast Assistant, Powered by Koios DS (not available in all countries)-----	13-306
<b>Thyroid Productivity Package</b>	
Overview-----	13-308
Worksheet and Summary Worksheets-----	13-312
Thyroid Assistant, Powered by Koios DS (not available in all countries)-----	13-313
<b>Start Assistant</b>	
Introduction-----	13-315
Start Assistant Mapping Editor-----	13-317
<b>Scan Assistant</b>	
Introduction-----	13-320
Scan Assistant Definitions-----	13-321
Scan Assistant Description-----	13-322
Setting up Scan Assistant-----	13-323
Using Scan Assistant-----	13-325
Exporting Scan Assistant Programs to Another LOGIQ Totus-----	13-329
Scan Assistant Creator-----	13-330
<b>Compare Assistant</b>	
Overview-----	13-358
Workflow example-----	13-360
Setting Up Compare Assistant-----	13-361
<b>OB Measure Assistant</b>	
Overview-----	13-369
<b>Hepatic Assistant</b>	
Overview-----	13-371
Activate Hepatic Assistant-----	13-372

---

Visualization-----	13-374
<b>Vscan Air™ CL (Option)</b>	
Overview-----	13-378
Install the Vscan Air CL Probe Charger-----	13-383
Charge the Vscan Air CL Probe-----	13-384
Vscan Air CL Battery Indicator-----	13-387
<b>EZ Imaging</b>	
Overview-----	13-398
Activate EZ Touch Panel-----	13-398
Quick Patient Change-----	13-406
<b>Anonymize the patient</b>	
Overview-----	13-407
Anonymize the patient-----	13-408
<b>Report Writer</b>	
Introduction-----	13-409
Creating a report-----	13-410
Activating the Report-----	13-411
Editing a Report-----	13-415
Accessing Worksheet, OB Graph and Anatomical Survey Pages--	13-428
Storing the Report-----	13-428
Retrieving an Archived Report-----	13-428
Deleting a Report from Archive-----	13-429
Printing the Report-----	13-429
Exporting the Report to Media-----	13-430
Exiting the report-----	13-430
Designing Your Own Template-----	13-431
Direct Report-----	13-456
Report Presets-----	13-460
<b>Configuring DICOM</b>	
Overview-----	13-466
DICOM Job Spooler-----	13-467
Patient Menu DICOM Functionality-----	13-468
Troubleshooting DICOM Connectivity Issues-----	13-469
<b>Configuring the Wireless Network</b>	
Wireless LAN (WLAN)-----	13-470
Wireless LAN (WLAN) Specifications-----	13-471
Connecting to the WLAN-----	13-473
Network and Spooler Status Icons-----	13-474
Adding a Wireless Network-----	13-475
Removing a WLAN-----	13-476
Customizing Wireless Network Settings-----	13-477
Setting an IP Address-----	13-478
Refreshing a WLAN-----	13-479
Managing Connectivity to a Wireless Network-----	13-479
Monitoring the WLAN-----	13-479
WLAN Diagnostics-----	13-480
Repairing the WLAN-----	13-480
Available WLAN Channels-----	13-481

---

Disconnecting from the WLAN -----	13-481
<b>Tricefy Uplink</b>	
Introduction -----	13-482
Uploading Exam Information to the Tricefy Cloud-----	13-484
Tricefy Icons-----	13-487
Tricefy Activation -----	13-487
<b>Device Mgmt</b>	
Overview -----	13-488
Upload For Fleet and Manual Backup (Cloud Backup) -----	13-490
Backup Automatically (Local and Cloud Backup) -----	13-491
Manual Backup (Cloud Backup) -----	13-491
Assign Configuration to Fleet or to the Device (on Cloud) -----	13-492
Receive Installation Notification -----	13-493
Installation Dialog -----	13-494
Detailed Restore from Cloud -----	13-501
Cancel a Failed Job -----	13-503
Icon and Notification -----	13-504
<b>Smart Device Apps</b>	
LOGIQ Apps -----	13-505
<b>Digital Expert</b>	
Digital Expert Remote Training-----	13-515
<b>Service and Applications Support</b>	
GE HealthCare Connect Guide -----	13-516
Support Requests-----	13-520
<b>Service Desktop</b>	
Overview -----	13-525
Accessing the Service Desktop -----	13-525
<b>Battery Power Mode</b>	
Overview -----	13-526
Scan on Battery Option (ScoB) -----	13-527
View current battery status -----	13-531
Battery charging -----	13-534
Refreshing the battery -----	13-535
Battery deterioration -----	13-536
Battery Disposal -----	13-536
<b>Magstripe Card Reader</b>	
Magstripe Magnetic Card Reader-----	13-537
<b>Footswitch</b>	
Wired Footswitch -----	13-538
<b>DVR</b>	
Setting up the DVR -----	13-539
Using the DVR -----	13-540
<b>Auto Preset Assistant</b>	
-----	13-545
Auto Abdominal Color Assistant-----	13-552
<b>Voice Control</b>	
Set up Voice Control -----	13-558

---

Start Voice Control .....	13-559
Command Set .....	13-560
Stop Voice Control .....	13-562
Change Voice Control settings.....	13-563

**Data Streaming (Option)**

User Setup for Data Streaming .....	13-566
Enable Data Streaming .....	13-567
Enable Data Streaming .....	13-568
Data Streaming in Process .....	13-569

**Index**



---

# Chapter 1

## Introduction

*This chapter consists of information concerning indications for use/contraindications, contact information and how this documentation is organized.*

# System Overview

## Attention

This manual contains necessary and sufficient information to operate the system safely. Advanced equipment training may be provided by a factory trained Applications Specialist for the agreed-upon time period.

Read and understand all instructions in this manual before attempting to use the LOGIQ Totus system.

Keep this manual with the equipment at all times. Periodically review the procedures for operation and safety precautions.

Disregarding information on safety is considered abnormal use.

Not all features, products, probes, or peripherals described in this document may be available or cleared for sale in all markets. Please contact your local GE HealthCare Ultrasound representative to get the latest information.

*NOTE: Please note that orders are based on the individually agreed upon specifications and may not contain all features listed in this manual.*

*NOTE: All references to standards / regulations and their revisions are valid at the time of publication of the user manual.*

## Documentation

Safety instructions must be reviewed before operating the system.

The LOGIQ Totus manuals are written for users who are familiar with basic ultrasound principles and techniques. They do not include sonographic training or detailed clinical procedures.

Documentation is provided in the following ways:

- Online Help PDFs viewable on the system
- Offline PDFs viewable on a Windows PC
- PDFs on the internet at the GE HealthCare Customer Documentation Portal
- Paper copies (orderable via H-Cat)

Table 1-1: Documentation

Publication	Translated	Available via F1 (Online help using F1 key on system)	Available via Media in the eIFU Kit	Available on Paper (if purchased via H-Cat)
User Manual Provides information needed by the user to operate the system safely.	Yes (all required languages)	Yes	Yes	Yes
Release Notes Provides precautions and instructions that supplement the Basic User Manual	Yes	No	Yes	Yes
Advanced Reference Manual Provides Acoustic Output Data and System Measurement and Analysis Tables and Formulas.	English and French	No	Yes	Yes
Privacy and Security Manual Describes Privacy and Security considerations and capabilities, and how they may be configured and used appropriately on the system.	Yes (all required languages)	No	No	No

### Documentation (continued)

*NOTE: An AIUM Booklet is shipped with systems shipped in the United States and Canada.*

*NOTE: Dates on screenshots are represented in MM/DD/YYYY format throughout the manual. Information on how to change the system's date can be found in Customizing Your System.*

*NOTE: The screen graphics in this manual are only for illustrational purposes. Actual screen output may differ.*

*NOTE: The Service Manual referenced in this manual is part number 5936427. The latest version of the Service Manual is available at: <https://www.gehealthcare.com/support/documentation>*

### Online Help PDFs

Online Help PDFs are available on the system by pressing the F1 key or via the eIFU icon on the second Utility Page.

### Viewing Online Help in a Language Different from the System Language

On the Utility > System > General Preset page, select the language you wish to view Online Help with from the Online Help Language dropdown selections.

If the translated Online Help is not available, the default language (English) is viewable.

Translated Online Help files can be updated via the eIFU USB Flash Drive provided with the ultrasound system in the eIFU Kit. To order another kit, contact your GE HealthCare Representative.

## Electronic Media

### Offline PDFs

To view user documentation PDFs on a Windows PC,

1. Insert the media into the media drive.
2. Open the media drive on your desktop.
3. Double click the HTML document for the ultrasound system.
4. Select the item you want to view (click on the blue, underlined link in the File Name column).

To close the window, click on the 'X' in the upper, right-hand corner of the browser window.

*NOTE: If your PC does not have Adobe Reader, a free download is available on the Adobe website at <http://www.adobe.com>.*

### Updating Documentation on the Ultrasound Scanner Via the USB

The latest version of the Online Help is located on the USB flash drive. To update to the latest version:

1. Power down the ultrasound system and insert the eIFU USB flash drive into a rear USB port.

**NOTE:** *Ensure that the system is USB Device Enabled (check setting on System Admin Utility Page).*

2. Power on the ultrasound system and follow the screen prompts.
  - a. Select Install SW ... on the Start Application screen.
  - b. Select OK on the first StartLoader screen.
  - c. Select the package and then select Install on the second StartLoader screen; software installation begins. After "Installation has completed" message appears and system restarts, remove USB flash drive.
  - d. As you verify each feature works correctly, select "Passed." If all features work correctly and "Passed" is selected for all features, the signature field is enabled at the bottom of the New Software Verification Checklist. Type your signature (minimum of three characters) and press OK. The system is now ready for use.

**NOTE:** *You can search through a document, use hyperlinks in the Table of Contents and Index to locate topics, and navigate via bookmarks.*

**NOTE:** *In addition to viewing documentation on the Ultrasound system, the Documentation media can be read on any PC.*

To exit, press the 'X' in the upper, right-hand corner of the documentation window.

### Viewing Online Help in a Language Different from the System Language

On the Utility > System > General Preset page, select the language you wish to view Online Help with from the Online Help Language dropdown selections

If the translated Online Help is not available, the default language (English) is viewable.

Translated Online Help files can be updated via the eIFU USB Flash Drive provided with the ultrasound system in the eIFU Kit. To order another kit, contact your GE HealthCare Representative.

## **Online Customer Documentation Portal**

Documentation is available in the Customer Documentation Portal on the internet at the GE HealthCare Support Documentation Library at:

<https://www.gehealthcare.com/documentation>

Navigate to the Customer Documentation Portal on the website and enter the following information to search for the desired manual:

- Document Number

OR

- Modality
- Product(s)
- Document Type
- Keyword

You can download the desired manual from the website or copy the manual url to share the link.

## **Paper Documentation**

Paper manuals can be ordered via H-Cat.

### **Principles of Operation**

Medical ultrasound images are created by computer and digital memory from the transmission and reception of mechanical high-frequency waves applied through a transducer. The mechanical ultrasound waves spread through the body, producing an echo where density changes occur. For example, in the case of human tissue, an echo is created where a signal passes from an adipose tissue (fat) region to a muscular tissue region. The echoes return to the transducer where they are converted back into electrical signals.

These echo signals are highly amplified and processed by several analog and digital circuits having filters with many frequency and time response options, transforming the high-frequency electrical signals into a series of digital image signals which are stored in memory. Once in memory, the image can be displayed in real-time on the image monitor. All signal transmission, reception and processing characteristics are controlled by the main computer. By selection from the system control panel, the user can alter the characteristics and features of the system, allowing a wide range of uses, from obstetrics to peripheral vascular examinations.

Transducers are accurate, solid-state devices, providing multiple image formats. The digital design and use of solid-state components provides highly stable and consistent imaging performance with minimal required maintenance. Sophisticated design with computer control offers a system with extensive features and functions which is user-friendly and easy to use.



## Indications for Use

The LOGIQ Totus is intended to be used in a hospital, medical clinic and private practice office.

## US Indications for Use Statement

The LOGIQ Totus is a general purpose diagnostic ultrasound system intended for use by qualified and trained healthcare professionals for ultrasound imaging, measurement, display and analysis of the human body and fluid. LOGIQ Totus clinical applications include : Fetal / Obstetrics; Abdominal (including Renal, Gynecology/Pelvic); Pediatric; Small Organ (Breast, Testes, Thyroid); Neonatal Cephalic; Adult Cephalic; Cardiac (Adult and Pediatric); Peripheral Vascular; Musculo-skeletal Conventional and Superficial; Urology (including Prostate); Transrectal; Transvaginal.

Modes of operation include: B, M, PW Doppler, CW Doppler, Color Doppler, Color M Doppler, Power Doppler, Harmonic Imaging, Coded Pulse, 3D/4D Imaging mode, Elastography, Shear Wave Elastography, Attenuation Imaging, Contrast Enhanced Imaging and Combined modes: B/M, B/Color, B/PWD, B/Color/PWD, B/Power/PWD.

## Operator Profile

- Qualified and trained Healthcare professionals, including physicians, sonographers and equivalent/compareable professions, with at least basic ultrasound knowledge.
- The operator must have read and understood the user manual.

*NOTE: Only qualified physicians or sonographers should perform ultrasound scanning on human subjects for medical diagnostic reasons. Request training, if needed.*

## Types of use

multiple patients, multiple use

## Frequency of Use

Daily (Typically 8 hours)

## Contraindication

The LOGIQ Totus ultrasound system is not intended for ophthalmic use or any use causing the acoustic beam to pass through the eye.

## Prescription Device



CAUTION: United States law restricts this device to sale or use by, or on the order of a physician.

## Clinical Benefit (System and Probes)

The clinical benefit of a diagnostic ultrasound device and probe is to help healthcare professional provide accurate diagnostic information (visualize human tissue/internal structure) that enhances the diagnostic and treatment care pathways of the patient for a variety of diseases and conditions.

## Patient Population

- Age: all ages (including embryos and fetuses)
- Location: worldwide
- Sex: male and female
- Weight: all weight categories
- Height: no limitations

**NOTE:** *Extreme obesity may affect operation of the device*



**WARNING**

Do not cross-use the ultrasound system between human and veterinary/animal use.

## Use Environment

The system is intended to be used in the following environments: Intensive Care Unit(ICU, CVICU, CCU), Neonatal Intensive Care Unit(NICU), Pediatric Intensive Care Unit(PICU), Emergency Room, Operating Room, Outpatient Surgery Clinic, Radiology, Medical Office(Nurse Practitioner), Observational Units, Cath Lab, Clinic, Physician's Office, Labor/Deliver Unit and Oncology.

**Potential additional considerations of use environment**

- Room Size: 8' x 10' (exam room)
- Power: AC outlet operation
- Lighting: dim(exam room) to bright(operating room)
- Noise: low(exam room) to high(emergency room)
- Other devices in environment: EMR PC, exam lights, exam table, sink, supplies for performing the ultrasound procedure, additional equipment in the ER or operating room(life-saving devices, instruments/tools, monitors), treadmill(for cardiac exams).
- Other environmental conditions: Level of stress on the operator: low to high, Barriers between the operator and the product: gloves typically worn during an examination, Sterility: may be used in a sterile environment, Entry and Exit: minimum one standard entry door.

**System Environmental Requirements**

Table 1-2: System Environmental Requirements

	Operational	Storage	Transport (<16hrs.)
Temperature	10° - 35°C/50° - 95°F with 2D probe 18° - 30°C/64.4° - 86°F with 4D probe	-10° - 50°C 14° - 122°F	-10° - 50°C 14° - 122°F
Humidity	30 - 80% non-condensing	10 - 90% non-condensing	10 - 90% non-condensing
Pressure	700 - 1060hPa	700 - 1060hPa	700 - 1060hPa

# Contact Information

## Contacting GE HealthCare Ultrasound

For additional information or assistance, please contact your local distributor or the appropriate support resource listed on the following pages:

### INTERNET

<http://www.gehealthcare.com>

<https://www.gehealthcare.com/transducers>

### Clinical Questions

For information in the United States, Canada, Mexico and parts of the Caribbean, call the Customer Answer Center.

TEL: (1) 800-682-5327 or (1) 262-524-5698

In other locations, contact your local Applications, Sales, or Service Representative.

### Service Questions

For service in the United States, call GE HealthCare CARES.

TEL: (1) 800-437-1171

In other locations, contact your local Service Representative.

### Information Requests

To request technical product information in the United States, call GE HealthCare.

TEL: (1) 800-643-6439

In other locations, contact your local Applications, Sales, or Service Representative.

### Placing an Order

To order accessories, supplies, or service parts in the United States, call the GE HealthCare Technologies Contact Center.

TEL: (1) 800-558-5102

In other locations, contact your local Applications, Sales, or Service Representative.

Contacting GE HealthCare Ultrasound (continued)

Table 1-3: Americas

ARGENTINA	GE Healthcare Argentina Nicolas de Verda 3616 piso 5 Buenos Aires - 1307	TEL: (+54) 11-5298-2200
BRAZIL	GE Healthcare do Brasil Comércio e Serviços para Equipamentos Médicos - Hospitalaria Ltda. Av. Magalhães de Castro, 4800, Andar 11 Conj. 111 e 112 Andar 12 Conj. 121 e 122, Torre 3 - Cidade Jardim CEP: 05878 120 São Paulo/SP Brasil CNPJ: 00.029.372/0001 40 Responsável Técnico: Renata Gelleriani Brandão CRF/SP nº 38.198	TEL: 3004 2525 (Capitals and Metropolitan Regions)  08000 165 799 (Other Locations)
CANADA	GE Ultrasound 9900 Innovation Drive Wauwatosa, WI 53226	TEL: (1) 800-668-0732  Customer Answer Center TEL: (1) 262-524-5698
LATIN & SOUTH AMERICA	GE Ultrasound 9900 Innovation Drive Wauwatosa, WI 53226	TEL: (1) 262-524-5300  Customer Answer Center TEL: (1) 262-524-5698
MEXICO	GE Sistemas Médicos de México S.A. de C.V. Rio Lerma #302, 1º y 2º Pisos Colonia Cuauhtémoc 06600-México, D.F.	TEL: (5) 228-9600 FAX: (5) 211-4631
USA	GE Ultrasound 9900 Innovation Drive Wauwatosa, WI 53226	TEL: (1) 800-437-1171 FAX: (1) 414-721-3865

Table 1-4: Asia

ASIA PACIFIC JAPAN	GE Healthcare Asia Pacific 4-7-127, Asahigaoka Hiroshi, Tokyo 191-8503, Japan	TEL: +81 42 585 5111
AUSTRALIA	32 Phillip Street Haramatta, 2150 Sydney, NSW, Australia	TEL: 1800 659 465
CHINA	GE Healthcare Asia No. 1, Yongchang North Road Beijing Economic & Technology Development Area Beijing 100178, China	TEL: (8610) 5806 8888 FAX: (8610) 6787 1162 Service: 4008128188 (24h)
INDIA	Wipro GE Healthcare Pvt Ltd No. 4, Kadugodi Industrial Area Sadaramangala, Whitefield Bangalore, 560087	TEL: +(91) 1-800-425-8025

Table 1-4: Asia (Continued)

KOREA	19F, 416 Hwangguse-ro, Chung-gu Seoul 04637, Korea	TEL: +82 2 6201 3114
NEW ZEALAND	Level 7 Vero Centre 48 Shortland St, Auckland, 1010 New Zealand	TEL: 0800 659 465
SINGAPORE	GF Healthcare ASFAN (Singapore) 11 North Buona Vista Drive #11 07 The Metropolis Tower 2 Singapore 138589	TEL: +65 6291 8528 FAX: +65 6291 7006

Table 1-5: Africa

EGYPT	GF Medical Systems Egypt LLC Plot 44 Teseen El Shama'y Street Al Salam Axis First Sector City Centre, Sh. settlement Cairo, Egypt	TEL: +20 2 25354200 FAX: +20 2 25370031
KENYA	GF East Africa Services Limited General Malherge Drive, Courtyard Building Westlands Nairobi 00 00100 KC	TEL: +254 719 093 044
NIGERIA	GE International Operations (Nig) Ltd Bishop Aboyade Cole Street No. 927/928 Mansard Place, PO Box 54255 Victoria Island Lagos LA NG	TEL: +234 (01) 4607101 TEL: +234 (01) 4607102
KINGDOM OF SAUDI ARABIA	GF Healthcare Arabia Co. Ltd Platinum Centre, Building 1 Sahadati Ayoubi Road Riyadh 12811 Kingdom of Saudi Arabia	TEL: +966 (11) 494 5779 FAX: +966 (11) 207 3946
SOUTH AFRICA	General Electric South Africa (Pty) Ltd 80 Glenhove Road Green on Glenhove Customer Innovation Centre Johannesburg GP 2198 ZA	TEL: +270100725000 FAX: +27 0862958385

Table 1-6: Europe

AUSTRIA	GF Healthcare Austria GmbH & Co OG EURO PLAZA, Gebäude F Technologiestrassen 10 A-1120 Vienna	TEL: (+43) 1 97272 0 FAX: (+43) 1 97272 2222
BELGIUM & LUXEMBURG	GF Healthcare BVBA/SPRL Koutervelstraat 20 1031 D IFGFM	TEL: (+32) 2 719 7204 FAX: (+32) 2 719 7205

Table 1-6: Europe (Continued)

CZECH REPUBLIC	GE Medical Systems Česká Republika, s.r.o. Bucharova 2641/14 158 00 Praha 5 Česká republika	TEL: (+420) 224 446 162 FAX: (+420) 224 446 161
DENMARK	GE Healthcare Park Allé 295 DK-2635 Brøndby, Denmark	TEL: (+45) 43 295 400 FAX: (+45) 43 295 399
ESTONIA & FINLAND	GE Healthcare Finland Oy Kuortaneentiekatu 2, 000510 Helsinki P.O. Box 330, 00031 GE Finland	TEL: (+358) 10 39 48 220 FAX: (+358) 10 39 48 221
FRANCE	GE Medical Systems SCS Division Ultrasonnd 21 Avenue de l'Europe - CS2052B 78157 Velizy Villacoublay Cedex	TEL: (+33) 1 34 49 52 70 FAX: (+33) 13 44 95 202
GERMANY	GE Healthcare GmbH Beethovenstrasse 259 42655 Solingen	TEL: (+49) 211-73-74440 FAX: (+49) 212-28 02-380
GREECE	GE Healthcare 8-10 Sorou Str. Marousi Athens 15125 Helas	TEL: (+30) 210 8930600 FAX: (+30) 210 9625931
HUNGARY	GE Hungary Zrt Gence utca 3 Budapest, HU 1138 EU	TEL: (+36) 23 410 314 FAX: (+36) 23 410 390
IRELAND	NORTHERN IRELAND GE Healthcare Victoria Business Park 9, Westbank Road Belfast BT3 9JL.  REPUBLIC OF IRELAND GE Healthcare 3050 Lake Drive Citywest Business Campus Dublin 24	TEL: (+44) 028 90229900  TEL: 1800 460 550 FAX: (+353) 1 686 5327
ITALY	GE Medical Systems Italia spa Via Galeno, 36, 20126 Milano	TEL: (+39) 02 2600 1111 FAX: (+39) 02 2600 1417
KAZAKHSTAN	«Дженерал Электроник Қазақстан» ЖШС Қазақстан, Алматы қаласы 050010. Тимирязев көшесі, 25В ү., 307 кенсе.	T +7 727 3560020
LUXEMBOURG	See Belgium.	
NETHERLANDS	GE Healthcare De Wel 18 B, 3871 NV Hooftaker PO Box 22, 3870 CA Hooftakken	TEL: (+31) 33 254 1290 FAX: (+31) 33 254 1292

Table 1-6: Europe (Continued)

NORWAY	GE Vingmed Ultrasound AS Sandakerveien 100C 0184 Oslo, Norway	TEL: (+47) 23 18 50 50 FAX: (+47) 23 18 60 35
	GE Vingmed Ultrasound Strandrommenader 45 P.O. Box 141, 3191 Horten	TEL: (+47) 33 02 11 16
POLAND	GE Medical Systems Polska Sp. z o.o., ul. Woloska 9 02-583 Warszawa, Poland	TEL: (+48) 22 330 83 00 FAX: (+48) 22 330 83 83
PORTUGAL	General Electric Portuguesa SA Avenida do Forte 6 - 6A Edifício Rasmazzotti 2790-072 CARNAXIDE	TEL: (+351) 21 425 1300 FAX: (+351) 21 425 1343
RUSSIA	GE Healthcare Presterskaya nab. 10 Block C, 12 floor 123317 Moscow, Russia	TEL: (+7) 4957 396931 FAX: (+7) 4957 396932
SPAIN	GE Healthcare España C/ Gocelso 36-37 28023 Madrid	TEL: (+34) 91 663 2500 FAX: (+34) 91 663 2501
SWEDEN	GE Healthcare Sverige AB FC 314, 182 82 Stockholm Besöksadr. Venderupen 89 Danderyd, Sverige	TEL: (+46) 08 559 500 10 FAX: (+46) 08 559 500 15 Service Center (+46) 020-120 14 36
SWITZERLAND	GE Medical Systems (Schweiz) AG Eurocastrasse 31 8192 Clattenegg	TEL: (+41) 1 809 92 92 FAX: (+41) 1 809 92 22
TÜRKIYE	GE Healthcare Türkiye Istanbul Office Levent Ofis Esenlepe Mah. Harman Sok. No.6 Sisli Istanbul	TEL: +90 212 398 07 00 FAX: +90 212 284 67 00
UNITED ARAB EMIRATES (UAE)	GE Healthcare Dubai Internet City, Building No. 18 First Floor, Dubai - UAE	TEL: (+971) 4 429 6101 or 4 429 6161 FAX: (+971) 4 429 6201
UNITED KINGDOM	GE Medical Systems Ltd Polaris Wood Nightingales Lane Chalfont St Giles Duckinghamsire HP8 4SP	TEL: (+44) 1494 544000 FAX: (+44) 1707 289742
For all other European countries not listed, please contact your local GE HealthCare distributor or the appropriate support resource listed on <a href="http://www.gehealthcare.com">www.gehealthcare.com</a> .		



## Manufacturer



GE Ultrasound Korea, Ltd.  
9, Sunhwan-ro 214beon-gil, Jungwon-gu, Seongnam-si,  
Gyeonggi-do, 13204  
Republic of Korea



---

# Chapter 2

## Safety

*Describes the safety and regulatory information pertinent for operating this ultrasound system.*

# Owner Responsibility

## Owner requirements

It is the responsibility of the owner to ensure that anyone operating the system reads and understands this section of the manual. However, there is no representation that the act of reading this manual renders the reader qualified to operate, inspect, test, align, calibrate, troubleshoot, repair or modify the system. The owner should make certain that only properly trained, fully-qualified service personnel undertake the installation, maintenance, troubleshooting, calibration and repair of the equipment.

The owner of the ultrasound unit should ensure that only properly trained, fully qualified personnel are authorized to operate the system. Before authorizing anyone to operate the system, it should be verified that the person has read, and fully understands, the operating instructions contained in this manual. It is advisable to maintain a list of authorized operators.

Should the system fail to operate correctly, or if the unit does not respond to the commands described in this manual, the operator should contact the nearest field GE HealthCare Ultrasound Service Office.

For information about specific requirements and regulations applicable to the use of electronic medical equipment, consult the local, state and federal agencies.

### ***For USA only***

Federal law restricts this device to use by, or on the orders of, a physician.

## Notice against user modification

Never modify this product, including system components, software, cables, and so on. User modification may cause safety hazards and degradation in system performance. All modification must be done by a GE HealthCare qualified person.

## **Reporting**

In the case of a serious incident occurring in relation to LOGIQ Totus ultrasound products, the incident should be reported to GE HealthCare and the competent Authority.

# Safety Precautions

## Precaution Levels

### Icon description

Various levels of safety precautions may be found on the equipment and different levels of concern are identified by one of the following flag words and icons which precede the precautionary statement.



DANGER

Indicates that a specific hazard is known to exist which through inappropriate conditions or actions will cause:

- Severe or fatal personal injury



WARNING

Indicates that a specific hazard is known to exist which through inappropriate conditions or actions may cause:

- Minor personal injury
- Substantial property damage



CAUTION

Indicates that a potential hazard may exist which through inappropriate conditions or actions will or can cause:

- Property damage

**NOTE:** *Substantial property damage is defined as system requires service to function.*

**NOTE:** *Indicates precautions or recommendations that should be used in the operation of the ultrasound system, specifically:*







- *Maintaining an optimum system environment*
- *Using this Manual*
- *Notes to emphasize or clarify a point.*

## Hazard Symbols

### Icon Description

Potential hazards are indicated by the following icons:

Table 2-1: Potential Hazards

Icon	Potential Hazard	Usage
	<p><b>Biological Hazard</b> Describes precautions necessary to prevent the risk of disease transmission or infections.</p> <ul style="list-style-type: none"> <li>• Patient/user infection due to contaminated equipment.</li> </ul>	<ul style="list-style-type: none"> <li>• Cleaning and care instructions</li> <li>• Sheath and glove guidelines</li> </ul>
	<p><b>Electrical Hazard</b> Describes precautions necessary to prevent the risk of injury through electric hazards.</p> <ul style="list-style-type: none"> <li>• Electrical micro-shock to patient, e.g., ventricular</li> </ul>	<ul style="list-style-type: none"> <li>• Probes</li> <li>• ECG, if applicable</li> <li>• Connections to back panel</li> </ul>
	<p><b>Moving Hazard</b> Describes precautions necessary to prevent the risk of injury through moving or tipping hazard!</p> <ul style="list-style-type: none"> <li>• Console, accessories or optional storage devices that can fall on patient, user, or others.</li> <li>• Collision with persons or objects may result in injury while maneuvering or during system transport.</li> <li>• Injury to user from moving the console.</li> </ul>	<ul style="list-style-type: none"> <li>• Moving</li> <li>• Using brakes</li> <li>• Transporting</li> </ul>
	<p><b>Acoustic Output Hazard</b></p> <ul style="list-style-type: none"> <li>• Patient injury or tissue damage from ultrasound radiation.</li> </ul>	<ul style="list-style-type: none"> <li>• ALARA, the use of Power Output following the 'as low as reasonably achievable' principle</li> </ul>
	<p><b>Explosion Hazard</b> Describes precautions necessary to prevent the risk of injury through explosion hazard!</p> <ul style="list-style-type: none"> <li>• Risk of explosion if used in the presence of flammable anesthetics.</li> </ul>	<ul style="list-style-type: none"> <li>• Flammable anesthetic</li> </ul>
	<p><b>Fire and Smoke Hazard</b></p> <ul style="list-style-type: none"> <li>• Patient/user injury or adverse reaction from fire or smoke.</li> <li>• Patient/user injury from explosion and fire.</li> </ul>	<ul style="list-style-type: none"> <li>• Replacing fuses</li> <li>• Outlet guidelines</li> </ul>

### Important Safety Considerations

The following topic headings (Patient Safety, and Equipment and Personnel Safety) are intended to make the equipment user aware of particular hazards associated with the use of this equipment and the extent to which injury can occur if precautions are not observed. Additional precautions may be provided throughout the manual.



#### DANGER

Improper use can result in serious injury. The use of the system outside the described conditions or intended use, and disregarding safety related information is considered abnormal use. The user must be thoroughly familiar with the instructions and potential hazards involving ultrasound examination before attempting to use the device. Training assistance is available from GE HealthCare if needed.

Disregarding information on safety is considered abnormal use.

Following are potential risks inherent to technology:

- Ultrasonic energy delivered to non-targeted tissue with the use of Ultrasound devices, and the interaction of sound energy with tissue at sufficiently high levels can produce biological effects.
- Monitoring the Mechanical Index (MI) can be a tool to help monitor the probability that cavitation could occur.



## **Patient Safety**

### **Related Hazards**



#### **WARNING**

The concerns listed can affect the safety of patients undergoing a diagnostic ultrasound examination.

### **Patient identification**

Always include proper identification with all patient data and verify the accuracy of the patient's name and ID numbers when entering such data. Make sure correct patient ID is provided on all recorded data and hard copy prints. Identification errors could result in an incorrect diagnosis.

The ultrasound system is not meant to be long term storage for patient data or images. The customers are responsible for the data on the system and a regular backup is highly recommended.

It is advisable to back up system data prior to any service repairs to the hard drive. It is always possible during system failure and repair to lose patient data. GE HealthCare will not be held responsible for the loss of this data.

### Diagnostic information

The images and calculations provided by the system are intended for use by competent users, as a diagnostic tool. They are explicitly not to be regarded as the sole, irrefutable basis for clinical diagnosis. Users are encouraged to study the literature and reach their own professional conclusions regarding the clinical utility of the system.

The user should be aware of the product specifications and of the system accuracy and stability limitations. These limitations must be considered before making any decision based on quantitative values. If in doubt, the nearest GE HealthCare Ultrasound Service Office should be consulted.

Equipment malfunction or incorrect settings can result in measurement errors or failure to detect details within the image. The equipment user must become thoroughly familiar with the equipment operation in order to optimize its performance and recognize possible malfunctions. Applications training is available through the local GE HealthCare representative. Added confidence in the equipment operation can be gained by establishing a quality assurance program.



#### WARNING

The system provides calculations (e.g. estimated fetal weight) and charts based on published scientific literature. The selection of the appropriate chart and clinical interpretation of calculations and charts is the sole responsibility of the user. The authorized user should consider proper indications for the use of a calculation or chart as described in the scientific literature. The diagnosis, decision for further examination, and medical treatment must be performed by qualified personnel following good clinical practice.



#### CAUTION

Features that facilitate measurements such as VOCAL or SonoNT must be used with extreme care. The measurement results are a suggestion of the system, if in doubt verify with manual measurement methods.

The user is responsible for the diagnostic interpretation of the measurement results.

## Mechanical hazards

The use of damaged probes or improper use and manipulation of intracavity probes can result in injury or increased risk of infection. Inspect probes often for sharp, pointed, or rough surface damage that could cause injury or tear protective barriers.

The use of damaged probes can result in injury or increased risk of infection. Inspect probes often for sharp, pointed, or rough surface damage that could cause injury or tear protective barriers.



Electrical  
Hazard

A damaged probe can also increase the risk of electric shock if conductive solutions come in contact with internal live parts. Inspect probes often for cracks or openings in the housing and holes in and around the acoustic lens or other damage that could allow liquid entry. Become familiar with the probe's use and care precautions outlined in *Probes and Biopsy*.



DANGER

Ultrasound transducers are sensitive instruments which can easily be damaged by rough handling. Take extra care not to drop transducers and avoid contact with sharp or abrasive surfaces. A damaged housing, lens or cable can result in patient injury or serious impairment or operation.

### ALARA



#### DANGER

Ultrasound can produce harmful effects in tissue and potentially result in patient injury. Always minimize exposure time and keep ultrasound levels low when there is no medical benefit. Use the principle of ALARA (As Low As Reasonably Achievable), increasing output only when needed to obtain diagnostic image quality. Observe the acoustic output display and be familiar with all controls affecting the output level. See the *Bioeffects section* of the *Acoustic Output chapter* in the *Advanced Reference Manual* for more information.

### Training

It is recommended that all users receive proper training in applications before performing them in a clinical setting. Please contact the local GE HealthCare representative for training assistance.

ALARA training is provided in the Medical Ultrasound Safety booklet shipped in the eDOCs kit. The ALARA education program for the clinical end-user covers basic ultrasound principles, possible biological effects, the derivation and meaning of the indices, ALARA principles, and examples of specific applications of the ALARA principle.

## Equipment and Personnel Safety

The concerns listed in the Related Hazards section can seriously affect the safety of equipment and personnel during a diagnostic ultrasound examination.

### Related Hazards



#### DANGER

This equipment contains dangerous voltages that are capable of serious injury or death.

If any defects are observed or malfunctions occur, stop operating the equipment and perform the proper action for the patient. Inform a qualified service person and contact a Service Representative for information.

There are no user serviceable components inside the console. Refer all servicing to qualified service personnel only.

Ensure that unauthorized personnel do not tamper with the unit.



#### Electrical Hazard

To avoid injury:

- Do not remove protective covers. No user serviceable parts are inside. Refer servicing to qualified service personnel.
- To assure adequate grounding, connect the attachment plug to a reliable (hospital grade) grounding outlet (having equalization conductor  $\text{E}$  ).
- Never use any adaptor or converter of a three-prong-to-two-prong type to connect with a mains power plug. The protective earth connection will loosen.
- Do not place liquids on or above the console. Spilled liquid may contact live parts and increase the risk of shock.
- In North America, a 220-240V installation requires the use of a center-tapped AC power source.

### Related Hazards (continued)



#### DANGER

The concerns listed below can seriously affect the safety of equipment and personnel during a diagnostic ultrasound examination.



#### Explosion Hazard

Risk of explosion if used in the presence of flammable anesthetics.

Never operate the equipment in the presence of flammable or explosive liquids, vapors or gases. Malfunctions in the unit, or sparks generated by fan motors, can electrically ignite these substances. Operators should be aware of the following points to prevent such explosion hazards.

- If flammable substances are detected in the environment, do not plug in or turn on the system.
- If flammable substances are detected after the system has been turned on, do not attempt to turn off the unit, or to unplug it.
- If flammable substances are detected, evacuate and ventilate the area before turning off the unit.



#### Smoke & Fire Hazard

The system must be supplied from an adequately rated electrical circuit. The capacity of the supply circuit must be as specified.



#### DANGER

#### Biological Hazard

For patient and personnel safety, be aware of biological hazards while performing invasive procedures. To avoid the risk of disease transmission:

- Use protective barriers (gloves and probe sheaths) whenever possible. Follow sterile procedures when appropriate.
- Thoroughly clean probes and reusable accessories after each patient examination and disinfect or sterilize as needed. Refer to *Probes and Biopsy* for probe use and care instructions.
- Follow all infection control policies established by your office, department or institution as they apply to personnel, equipment and accessories.

**Related Hazards (continued)**



**DANGER**

Do not unpack the LOGIQ Totus. This must be performed by qualified service personnel only. Improper unpacking could lead to injury.



**DANGER**

GE HealthCare recommends dedicated probes for use on humans only or animals only. Mark probes dedicated for animals with special labels.

Observe any country specific rules and regulations for handling equipment used on both animals and humans. Such national restrictions may prohibit transfer of probes used on animals to humans and vice-versa.

Failure to follow these instructions could lead to exposure to infectious agents.



**WARNING**

- Make sure to verify the media after writing data, such as EZBackup, SaveAs or Export.
- Before deleting a patient or image from the patient screen, make sure you have saved the data by EZBackup/Backup or Export and verify that the media data transfer was successful. Not following the instructions could result in the loss of data requiring a rescan.



**WARNING**

When you move the Control Panel up/down with the monitor, place BOTH hands on the Control Panel. Touching other moving parts other than the Control Panel may cause personal injury.



**WARNING**

Contact with natural rubber latex may cause a severe anaphylactic reaction in persons sensitive to the natural latex protein. Sensitive users and patients must avoid contact with these items.



**WARNING**

The LOGIQ Totus is not intended to be used as a data storage device; backup of the Patient and Image Database is your institution's responsibility. GE HealthCare is NOT responsible for any lost patient information or for lost images. Loss of image data may require a rescan.

### Related Hazards (continued)



#### WARNING

To minimize accidental loss of data, perform EZBackup and Backup on a regular basis.

1. First, perform EZBackup to save the images.
2. Next, perform Backup at Utility -> Backup/Restore. Enable the following checkboxes under Backup:
  - User defined configuration
  - Service



#### CAUTION

Only approved and recommended peripherals and accessories should be used.

All peripherals and accessories must be securely mounted to the LOGIQ Totus. Failure to follow these instructions could lead to unexpected diagnostic performance.



#### CAUTION

Non-supported peripheral devices that use their own AC power source CANNOT be attached to the LOGIQ Totus. DO NOT connect the peripheral device's power cord into the LOGIQ Totus system. Only peripheral devices purchased from GE HealthCare with the purpose of being used with the LOGIQ Totus system should be used.

Use a USB printer cable that is less than 3 meters in length.

Failure to follow these instructions could lead to unexpected diagnostic performance.



#### CAUTION

Do not use this equipment if a safety problem is known to exist. Have the unit repaired and performance verified by qualified service personnel before returning to use.



**Related Hazards (continued)**



**CAUTION**

To avoid injury or system damage, NEVER place any object or liquid on the operator panel.

**Material Safe Data**

**Rubber part**

Material: EPDM

Where Used: Probe holder/Gel holder/Keyboard bumper/Front and Rear Foot Pedal/System bumper at the four corners.

### Related Hazards (Monitor)



#### WARNING

- **DO NOT** place a finger, hand or any object on the joint of the monitor or monitor arm to avoid injury when moving the monitor and monitor arm.
- To avoid result of injury or system damage, **NEVER** place any object or liquid on the monitor, whether in the home or flip down/transport position.
- **DO NOT** scratch or press on the panel with any sharp objects, such as a pencil or pen, as this may result in damage to the panel.
- To avoid injury or damage, make sure nothing is within the range of motion before moving the monitor and monitor arm. This includes both objects and people.
- Pay attention to the monitor arm position to avoid hitting it against anyone or anything.
- Before moving the system to another location, be sure to lock the monitor arm in the transport position.
- The monitor screen may have defective pixels. These pixels may appear as a slightly light or dark area on the screen. This is due to the characteristics of the panel itself, and not the product.
- The backlight of the monitor has a fixed life span. When the screen becomes dark or begins to flicker, contact a qualified Service Representative for information.

*NOTE: Bright light could impact readability of screen.*

### Related Hazards (Volume Navigation)



#### DANGER

**DO NOT** use the Volume Navigation feature on any patient relying on life-sustaining electronic equipment, such as a pacemaker or defibrillator. Failure to follow this instruction could lead to interference with patient electronic device(s).

## **Related Hazards (Specific modes and features)**



### **CAUTION**

- Be aware that diagnostic conclusions must not be drawn from a specific mode, such as Render Mode or LOGIQView Mode. Always check with other diagnostic procedures.
- The accuracy of measurements in specific modes such as Render Mode, LOGIQView, STIC or VOCAL is limited and can be lower than measurements in B-images.
- Do not diagnose based on 3D/4D Acquisition Mode. Always check and confirm diagnostic findings in B-Mode.

## **Reusable Accessory Cleaning**



### **DANGER**

Reusable accessories should be cleaned and disinfected or sterilized as stated by the manufacturer, before first use and after each patient examination.

## Classifications

Type of protection against electric shock

Class I Equipment (\*1)

Degree of protection against electric shock

Type BF Applied part (\*2) (for Probes marked with BF symbol)

Type CF Applied part (\*3) (for ECG, eTRAX needle marked with CF symbol)

Continuous Operation

System is Ordinary Equipment (IPX0)

Footswitch is IPX8; Probes are IPX7 or greater

Internally powered ME equipment

Vscan Air CL is IP67, Vscan Air CL charger is IP41.

**NOTE:** *Probe connector is not waterproof.*

### **\*1. Class I Equipment**

EQUIPMENT in which protection against electric shock does not rely on BASIC INSULATION only, but includes an earth ground. This additional safety precaution prevents exposed metal parts from becoming LIVE in the event of an insulation failure.

### **\*2. Type BF Applied Part**

TYPE BF APPLIED PART providing a specified degree of protection against electric shock, with particular regard to allowable LEAKAGE CURRENT.

Table 2-2: Type BF Equipment

	Normal Mode	Single fault condition
Patient leakage current	Less than 100 microA	Less than 500 microA

### **\*3. Type CF Applied Part**

TYPE CF APPLIED PART providing a degree of protection higher than that for Type BF Applied Part against electric shock particularly regarding allowable LEAKAGE CURRENTS.

Table 2-3: Type CF Equipment

	Normal Mode	Single fault condition
Patient leakage current	Less than 10 microA	Less than 50 microA

## EMC (Electromagnetic Compatibility)

**NOTE:** *This equipment generates, uses and can radiate radio frequency energy. The equipment may cause radio frequency interference to other medical and non-medical devices and radio communications. To provide reasonable protection against such interference, this product complies with emissions limits for a Group 1, Class A Medical Devices Directive as stated in EN 60601-1-2. However, there is no guarantee that interference will not occur in a particular installation.*

**NOTE:** *If this equipment is found to cause interference (which may be determined by turning the equipment on and off), the user (or qualified service personnel) should attempt to correct the problem by one or more of the following measure(s):*

- *reorient or relocate the affected device(s)*
- *increase the separation between the equipment and the affected device*
- *power the equipment from a source different from that of the affected device*
- *consult the point of purchase or service representative for further suggestions.*

**NOTE:** *The manufacturer is not responsible for any interference caused by using other than recommended interconnect cables or by unauthorized changes or modifications to this equipment. Unauthorized changes or modifications could void the users' authority to operate the equipment.*

**NOTE:** *To comply with the regulations on electromagnetic interference for a Class A FCC Device, all interconnect cables to peripheral devices must be shielded and properly grounded. Use of cables not properly shielded and grounded may result in the equipment causing radio frequency interference in violation of the FCC regulations.*



### CAUTION

Unexpected diagnostic system performance or failure from interference broadcasted by device due to electromagnetic incompatibility with cauterizing knife causing obvious deterioration of image quality.

## EMC (Electromagnetic Compatibility) (continued)

*NOTE: Do not use devices which intentionally transmit RF Signals (cellular phones, transceivers, or radio controlled products), other than those supplied by GE HealthCare, in the vicinity of the equipment, as it may cause performance outside the published specifications. Keep the power to these type devices turned off when near this equipment.*



### CAUTION

Portable RF communications equipment (including peripherals such as antenna cables and external antennas) at frequencies noted in Table 2-4 on page 2-23 should be used no closer than 30cm (12 inches) to any part of the LOGIQ Totus, including cables specified by GE HealthCare.

Otherwise, degradation of the performance of this equipment could result.

*The medical staff in charge of this equipment is required to instruct technicians, patients, and other people who maybe around this equipment to fully comply with the above requirement.*

## **EMC Performance**

All types of electronic equipment may characteristically cause electromagnetic interference with other equipment, either transmitted through air or connecting cables. The term EMC (Electromagnetic Compatibility) indicates the capability of equipment to curb electromagnetic influence from other equipment and at the same time not affect other equipment with similar electromagnetic radiation from itself.

Proper installation following the service manual is required in order to achieve the full EMC performance of the product.

The product must be installed as stipulated in 4.2, Notice upon Installation of Product.



### **CAUTION**

Use of this equipment adjacent to or stacked with other equipment should be avoided because it could result in improper operation. If such use is necessary, this equipment and the other equipment should be observed to verify that they are operating normally. Failure to follow these instruction could lead to unexpected diagnostic performance.

In case of issues related to EMC, please call your service personnel.

The manufacturer is not responsible for any interference caused by using other than recommended interconnect cables or by unauthorized changes or modifications to this equipment. Unauthorized changes or modifications could void the users' authority to operate the equipment.

## EMC Performance (continued)



### WARNING

Do not use devices which intentionally transmit RF signals (cellular phones, transceivers, or radio controlled products), other than those supplied by GE HealthCare (wireless microphone, broadband over power lines, for example) unless intended for use with this system, in the vicinity of this equipment as it may cause performance outside the published specifications.

Keep power to these devices turned off when near this equipment.

Medical staff in charge of this equipment is required to instruct technicians, patients and other people who may be around this equipment to fully comply with the above regulation.

Portable and mobile radio communications equipment (e.g. two-way radio, cellular/cordless telephones, wireless computer networks) should be used no closer to any part of this system, including cables, than determined according to the following method:



**EMC Performance (continued)**

Table 2-4: Recommended separation distances between portable and mobile RF communications equipment and this system

<p><b>This system is intended for use in an electromagnetic environment in which radiated RF disturbances are controlled. The customer or the user of this system can help prevent electromagnetic Interference by maintaining a minimum distance between portable and mobile RF communications equipment (transmitters) and this system as recommended below, according to the maximum output power of the communications equipment.</b></p>			
<p>Rated Maximum Output Power (P) of Transmitter Watts (W)</p>	<p>Separation distance according to transmitter frequency</p>		
	<p><b>150 kHz - 80 MHz</b> d=[3.5/3] square root of P</p>	<p><b>80 MHz - 800 MHz</b> d = [3.5/3] square root of P</p>	<p><b>800 MHz - 2.5 GHz</b> d = [7/3] square root of P</p>
	<p>Where: d= separation distance in meters, P = rated power of the transmitter.</p>		
	<p><b>The separation distance in meters should be</b></p>		
0.01	0.12	0.12	0.23
0.1	0.37	0.37	0.74
1	1.17	1.17	2.33
10	3.69	3.69	7.38
100	11.7	11.7	23.3
<p>For transmitters rated at a maximum output power not listed above, the separation distance can be estimated using the equation in the corresponding column, where P is the maximum output power rating of the transmitter in watts (W) according to the transmitter manufacturer. NOTE: At 80 MHz and 800 MHz, the separation distance for the higher frequency range applies. These guidelines may not apply in all situations. Electromagnetic propagation is affected by absorption and reflection from structures, objects, and people.</p>			

### Notice upon Installation of Product

Separation distance and effect from fixed radio communications equipment: field strengths from fixed transmitters, such as base stations for radio (cellular/cordless) telephones and land mobile radios, amateur radio, AM and FM radio broadcast, and TV broadcast transmitter cannot be predicted theoretically with accuracy. To assess the electromagnetic environment due to fixed RF transmitters, an electromagnetic site survey should be considered. If the measured field strength in the location in which the ultrasound system is used exceeds the applicable RF compliance level as stated in the immunity declaration, the ultrasound system should be observed to verify normal operation. If abnormal operation is observed, additional measures may be necessary, such as re-orienting or relocating the ultrasound system or using an RF shielded examination room may be necessary.

1. Use either power supply cords provided by GE HealthCare or ones designated by GE HealthCare. Products equipped with a power source plug should be plugged into the fixed power socket which has the protective grounding conductor. Never use any adaptor or converter to connect with a power source plug (e.g. three-prong-to-two-prong converter).
2. Locate the equipment as far away as possible from other electronic equipment.
3. Be sure to use only the cables provided by or designated by GE HealthCare. Connect these cables following the installation procedures (e.g. wire power cables separately from signal cables).
4. Lay out the main equipment and other peripherals following the installation procedures described in the Option Installation manuals.

**General Notice**



**WARNING**

Use of accessories, transducers and cables other than those specified or provided by GE HealthCare of this equipment could result in increased electromagnetic emissions or decreased electromagnetic immunity of this equipment and result in improper operation.

**Probe cables**

Table 2-5: Probe cables

Probe	Length (m)	Cable Type
9L-D	2.4	Shielded
L3-12-D	2.2	Shielded
ML6-15-D	2.2	Shielded
L6-24-D	3.0	Shielded
M5Sc-D	2.2	Shielded
6S-D	2.2	Shielded
C1-6-D	2.2	Shielded
C1-6VN-D	2.2	Shielded
C2-7-D	2.2	Shielded
C2-7VN-D	2.2	Shielded
C3-10-D	2.2	Shielded
IC5-9-D	2.0	Shielded
12S-D	2.5	Shielded
RAB6-D	2.1	Shielded
RIC5-9-D	2.5	Shielded
P2D	2.2	Shielded
P6D	2.0	Shielded
Vscan Air CL		

**General Notice (continued)**

**Other cables**

Table 2-6: Other cables

<b>Model name</b>	<b>Length (m)</b>	<b>Cable Type</b>
Power cable	4.0	Non-Shielded
ECG cable	3.6	Shielded
ECG lead wire	0.7	Shielded
V-Nav transmitter	3.3	Shielded
V-Nav Dual 10mm sensor	2.5	Shielded
Footswitch	2.5	Shielded
Vscan air CL charger cable	0.15	Non-Shielded

**General Notice (continued)**

1. Designation of Peripheral Equipment Connectable to This Product.

The equipment indicated in the Supplies/Accessories section can be hooked up to the product without compromising its EMC performance.

Avoid using equipment not designated in the list. Failure to comply with this instruction may result in poor EMC performance of the product.

2. Notice against User Modification

The user should never modify this product. User modifications may cause degradation in EMC performance.

Modification of the product includes changes in:

- a. Cables (length, material, wiring, etc.)
  - b. System installation/layout
  - c. System configuration/components
  - d. Securing system parts (cover open/close, cover screwing)
3. Operate the system with all covers closed. If a cover is opened for some reason, be sure to shut it before starting/resuming operation.
  4. Operating the system with any cover open may affect EMC performance.

### Peripheral Update for EC countries

The following is intended to provide the users in EC countries with updated information concerning the connection of the LOGIQ Totus to image recording and other devices or communication networks.

### Peripherals used in the patient environment

The LOGIQ Totus has been verified for overall safety, compatibility and compliance with the following image recording devices:

- Sony UP-D898DC Digital Printer
- Sony UP-D25 Digital Printer
- Sony UP-DR80MD Color Printer
- Drive Bay (for Tru3D and Volume Navigation)
- USB 2.0/3.0 Flash Drive
- USB Hard Disk Drive

*NOTE: The LOGIQ Totus supports the USB 3.0 standard (on the Operator Panel and Peripheral/Accessory Connector Panel).*

The LOGIQ Totus has also been verified for compatibility, and compliance for connection to a local area network (LAN) via the rear panel Ethernet connection, provided the LAN components are IEC/EN 60950 and IEC/EN 62368 compliant.

A Wireless LAN option is available. Conforms to IEEE 802.11 a/ b/g/n/ac Wi-Fi with Bluetooth 5.2 Standard.

The LOGIQ Totus may also be used safely while connected to devices other than those recommended above if the devices and their specifications, installation, and interconnection with the system conform to the requirements of IEC/EN 60601-1.

**Peripherals used in the patient environment (continued)**

Accessory equipment connected to the analog and digital interfaces must be certified according to the respective IEC standards (i.e., IEC60950 or IEC62368 for data processing equipment and IEC60601-1 for medical equipment).

Furthermore, all complete configurations shall comply with the valid version of the system standard IEC60601-1. Everyone who connects additional equipment to the signal input part or signal output part of the LOGIQ Totus system configures a medical system, and is therefore responsible to ensure that the system complies with the requirements of the valid version of IEC60601-1. If in doubt, consult the technical service department or your local GE HealthCare representative.

General precautions for installing an alternate on-board device would include:

1. The added device must have appropriate safety standard conformance and CE Marking.
2. The total power consumption of the added devices, which connect to the LOGIQ Totus and are used simultaneously, must be less than or equal to the rated supply of the LOGIQ Totus.
3. There must be adequate heat dissipation and ventilation to prevent overheating of the device.
4. There must be adequate mechanical mounting of the device and stability of the combination.
5. Risk and leakage current of the combination must comply with IEC/EN 60601-1.
6. Electromagnetic emissions and immunity of the combination must conform to IEC/EN 60601-1-2.

### Peripherals used in the patient environment (continued)

General precautions for installing an alternate off-board, remote device or a network would include:

1. The added device(s) must have appropriate safety standard conformance and CE Marking.
2. The added device(s) must be used for their intended purpose having a compatible interface.
3. Signal or mains isolation devices and additional protective earth may be needed to assure compliance with IEC/ EN 60601-1.



## Declaration of Emissions

This system is suitable for use in the following environment. The user must assure that it is used only in the electromagnetic environment as specified.

Table 2-7: Declaration of Emissions

<b>Guidance and manufacturer's declaration - electromagnetic emissions</b>		
<b>The system is intended for use in the electromagnetic environment specified below. The user of the system should assure that it is used in such an environment.</b>		
<b>Emission Type</b>	<b>Compliance</b>	<b>Electromagnetic Environment</b>
RF Emissions CISPR 11	Group 1	This system uses RF energy only for its internal function. Therefore, its RF emissions are very low and are not likely to cause any interference in nearby electronic equipment.
RF Emissions CISPR 11	Class A	This system is suitable for use in all establishments, other than domestic establishments and those directly connected to the public low-voltage power supply network that supplies buildings used for domestic purposes, provided the following warning is heeded:  WARNING: The EMISSIONS characteristics of this equipment make it suitable for use in industrial areas and hospitals (CISPR 11 class A). If it is used in a residential environment (for which CISPR 11 class B is normally required) this equipment might not offer adequate protection to radio-frequency communication services. The user might need to take mitigation measures, such as relocating or reorienting the equipment.
Harmonic Emissions IEC 61000-3-2	Class A	
Voltage Fluctuations/Flicker Emissions IEC 61000-3-3	Complies	

## Declaration of Immunity

This system is suitable for use in the following environment. The user must ensure that the system is used according to the specified guidance and only in the electromagnetic environment listed.

Table 2-8: Declaration of Immunity Compliance Statement Supporting

Guidance and manufacturer's declaration - electromagnetic immunity			
This system is intended for use in the electromagnetic environment specified below. The customer or the user of this system should assure that it is used in such an environment.			
Environments of INTENDED USE	Professional HealthCare facility environment		
Immunity Type	IEC 60601-1-2 test level	IEC 60601-1-2 Compliance Level	Electromagnetic Environment Guidance
IEC 61000-4-2 Electrostatic discharge (ESD)	± 8 kV contact  ± 15 kV air	± 8 kV air ± 15 kV air	Floors should be wood, concrete, or ceramic tile. If floors are covered with synthetic material, the relative humidity should be at least 30%.
IEC 61000-4-4 Electrical fast transient/burst	±2 kV for power supply lines 100 kHz rate  ± 1 kV for input/output lines 100 kHz rate	± 2 kV for power supply lines 100 kHz rate ± 1 kV for input/output lines 100 kHz rate	Mains power quality should be that of a typical commercial and/or hospital environment.
IEC 61000-4-5 Surge Immunity	± 1 kV line-line ± 2 kV line-earth	± 1 kV line-line ± 2 kV line-earth	Mains power quality should be that of a typical commercial and/or hospital environment.
IEC 61000-4-11 Voltage dips and short interruptions and voltage variations on power supply input lines	0 % UT; 0.5cycle, Phase: 0,45,90,135,180,225,270,315° 0 % UT; 1cycle, Phase: 0° 70 % UT; 25/30cycle, Phase: 0° 0 % UT; 250/300 cycle Note: Apply IEC 60601-2-37 (202.6.2.7)	0 % UT; 0.5cycle, Phase: 0,45,90,135,180,225,270, 315° 0 % UT; 1cycle, Phase: 0° 70 % UT; 25/30cycle, Phase: 0° 0 % UT; 250/300 cycle Note: Apply IEC 60601-2-37 (202.6.2.7)	Mains power quality should be that of a typical commercial and/or hospital environment. If the user requires continued operation during power mains interruptions, it is recommended that the system be powered from a UPS or a battery option.

Table 2-8: Declaration of Immunity Compliance Statement Supporting (Continued)

<b>Guidance and manufacturer's declaration - electromagnetic immunity</b>			
<b>This system is intended for use in the electromagnetic environment specified below. The customer or the user of this system should assure that it is used in such an environment.</b>			
<b>Environments of INTENDED USE</b>	<b>Professional HealthCare facility environment</b>		
<b>Immunity Type</b>	<b>IEC 60601-1-2 test level</b>	<b>IEC 60601-1-2 Compliance Level</b>	<b>Electromagnetic Environment Guidance</b>
IEC 61000-4-8 Power frequency (50/60 Hz) magnetic field	30 A/m	30 A/m	Power frequency magnetic fields should be at levels characteristic of a typical location in a typical commercial and/or hospital environment.
NOTE: UT is the AC mains voltage prior to application of the test level.			

Table 2-8: Declaration of Immunity Compliance Statement Supporting (Continued)

Guidance and manufacturer's declaration - electromagnetic immunity			
This system is intended for use in the electromagnetic environment specified below. The customer or the user of this system should assure that it is used in such an environment.			
Environments of INTENDED USE	Professional HealthCare facility environment		
Immunity Type	IEC 60601-1-2 test level	IEC 60601-1-2 Compliance Level	Electromagnetic Environment Guidance
IEC 61000-4-6 Conducted RF	3 Vrms 150kHz to 80MHz 6 Vrms in ISM bands between 150 kHz to 80MHz	3 Vrms 150kHz to 80MHz 6 Vrms in ISM bands between 150 kHz to 80MHz	Portable and mobile RF communications equipment should be used no closer to any part of this system, including cables, than the recommended separation distance calculated from the equation appropriate for the frequency of the transmitter. Recommended Separation Distance (see Table 2-4)
IEC 61000-4-3 Radiated RF EM fields	3 V/m 80 MHz - 2.7 GHz 80% AM 1 kHz	3 V/m 80 MHz - 2.7 GHz 80% AM 1 kHz	
IEC 61000-4-39 Radiated Fields in Close Proximity	134.2kHz, PM 50% 2.1kHz, 65 A/m 13.56MHz, PM 50% 50kHz, 7.5A/m	134.2kHz, PM 50% 2.1kHz, 65 A/m 13.56MHz, PM 50% 50kHz, 7.5A/m	

$$d = \left[ \frac{3.5}{3} \right] \sqrt{P}$$

(80 MHz to 800 MHz (see Table 2-4)

$$d = \left[ \frac{3.5}{3} \right] \sqrt{P}$$

(800 MHz to 2.7 GHz (see Table 2-4)

$$d = \left[ \frac{7}{3} \right] \sqrt{P}$$

where  $P$  is the maximum output power rating of the transmitter in watts (W) according to the transmitter manufacturer and  $d$  is the recommended separation distance in meters (m). Field strengths from fixed RF transmitters, as determined by an electromagnetic site survey, should be less than the compliance level in each frequency range b.

Table 2-8: Declaration of Immunity Compliance Statement Supporting (Continued)

Guidance and manufacturer's declaration - electromagnetic immunity			
This system is intended for use in the electromagnetic environment specified below. The customer or the user of this system should assure that it is used in such an environment.			
Environments of INTENDED USE	Professional HealthCare facility environment		
Immunity Type	IEC 60601-1-2 test level	IEC 60601-1-2 Compliance Level	Electromagnetic Environment Guidance
IEC 61000-4-3 Proximity fields from RF wireless communications equipment	9 V/m to 28 V/m spot frequencies 385 MHz: 27 V/m 450 MHz: 28 V/m 710 MHz: 9 V/m 745 MHz: 9 V/m 780 MHz: 9 V/m 810 MHz: 28 V/m 870 MHz: 28 V/m 930 MHz: 28 V/m 1720 MHz: 28 V/m 1845 MHz: 28 V/m 1970 MHz: 28 V/m 2450 MHz: 28 V/m 5240 MHz: 9 V/m 5500 MHz: 9 V/m 5785 MHz: 9 V/m PM 18 Hz or 217 Hz (50% duty cycle)	9 V/m to 28 V/m spot frequencies 385 MHz: 27 V/m 450 MHz: 28 V/m 710 MHz: 9 V/m 745 MHz: 9 V/m 780 MHz: 9 V/m 810 MHz: 28 V/m 870 MHz: 28 V/m 930 MHz: 28 V/m 1720 MHz: 28 V/m 1845 MHz: 28 V/m 1970 MHz: 28 V/m 2450 MHz: 28 V/m 5240 MHz: 9 V/m 5500 MHz: 9 V/m 5785 MHz: 9 V/m PM 18 Hz or 217 Hz (50% duty cycle)	Minimum separation distances for higher IMMUNITY TEST LEVELS shall be calculated using the following equation:  $E = \frac{6}{d} \sqrt{P}$ Where P is the maximum power in W, d is the minimum separation distance in m, and E is the IMMUNITY TEST LEVEL in V/m.
<p>a. Field strengths from fixed transmitters, such as base stations for radio (cellular/cordless) telephones and land mobile radios, amateur radio, AM and FM radio broadcast, and TV broadcast cannot be predicted theoretically with accuracy. To assess the electromagnetic environment due to fixed RF transmitters, an electromagnetic site survey should be considered. If the measured field strength in the location in which this system is used exceeds the applicable RF compliance level above, this system should be observed to verify normal operation. If abnormal performance is observed, additional measures may be necessary, such as reorienting or relocating this system.</p> <p>b. Over the frequency range 150 kHz to 80 MHz field strengths should be less than 3 V/m.</p> <p>c. As an alternative to FM modulation, 50 % pulse modulation at 18 Hz may be used because while it does not represent actual modulation, it would be worst case.</p> <p>NOTE: These guidelines may not apply in all situations. Electromagnetic propagation is affected by absorption and reflection from structures, objects, and people.</p>			

**Declaration of Immunity (continued)**

Table 2-9: Spot Frequencies for IEC 61000-4-3 Proximity fields from RF wireless communications equipment

Test Frequency (MHz)	Band (MHz)	Service	Modulation	Maximum Power (W)	Distance (m)	Immunity Test Level (V/m)
385	380 - 390	TETRA 400	Pulse modulation 18 Hz	1.8	0.3	27
450	430 - 470	GMRS 460, FRS 460	FM $\pm$ 5 kHz deviation 1 kHz sine	2	0.3	28
710	704 - 787	LTE Band 13, 17	Pulse modulation 217 Hz	0.2	0.3	9
745						
780						
810	800 - 960	GSM 800/ 900 TETRA 800 iDEN 820 CDMA 850 LTE Band 5	Pulse modulation 18 Hz	2	0.3	28
870						
930						
1720	1700 - 1990	GSM 1800; CDMA 1900; GSM 1900; DECT; LTE Band 1, 3, 4, 25; UMTS	Pulse modulation 217 Hz	2	0.3	28
1845						
1970						
2450	2400 - 2570	Bluetooth, W LAN, 802.11 b/g/n, RFID 2450, LTE Band 7	Pulse modulation 217 Hz	2	0.3	28
5240	5100 - 5800	WLAN 802.11 a/n	Pulse modulation 217 Hz	0.2	0.3	9
5500						
5785						

## **Essential performance**

The essential performance of the ultrasound unit is:

- The ability to display B-mode image as input for diagnosis.
- The ability to display M-mode image as input for diagnosis.
- The ability to display Doppler-mode image as input for diagnosis.
- The ability to display Color Flow-mode image as input for diagnosis.
- The display of acoustic power indexes as an aid for safe use of ultrasound diagnostic (MI, TIS, TIB, TIC).

## Patient Environmental Devices (LCD monitor)

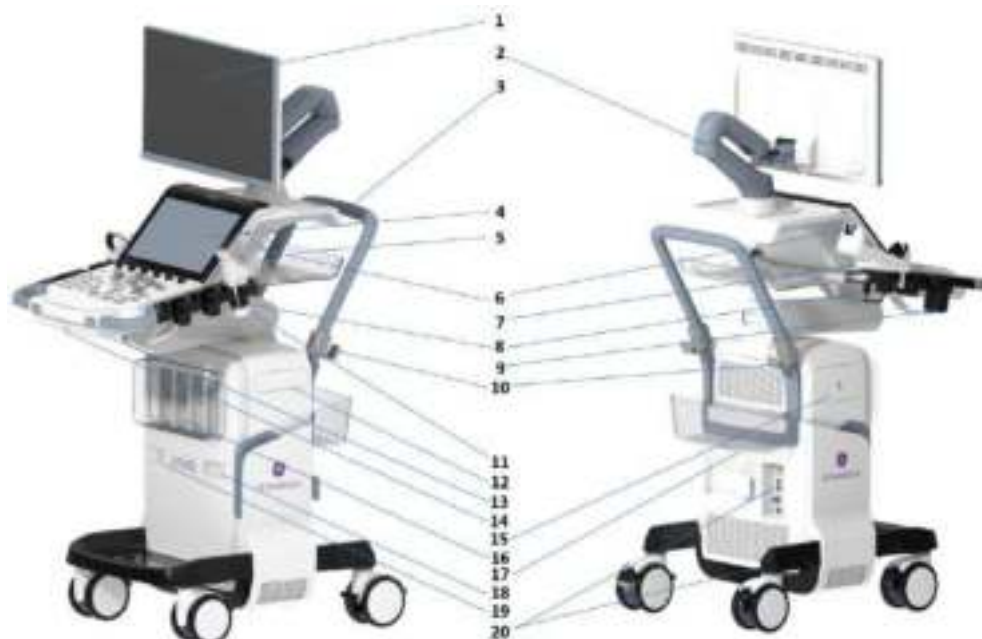

Figure 2-1. Patient Environmental Devices

1. 23.8 inch widescreen monitor
2. Monitor arm
3. Rear handle
4. Control panel with touch panel display
5. OPIO rear tray (option)
6. USB port (2 A types, 2 C types), Microphone
7. Horizontal TV probe holder (option)
8. Probe holder
9. Gel holder or Gel warmer (option)
10. Rear handle cable hook (option)
11. Wireless probe charger (option)
12. V-Navi controller (Option)
13. Front handle with control panel rotation and up/down button
14. AN Keyboard (option)
15. BW printer (option) or Drawer (option) bay
16. Probe connectors
17. Rear basket (option)
18. Patient I/O Port (Option)
19. CW probe port (Option)
20. External I/O connectors and Mains power switch



**Patient Environmental Devices (HDU monitor)**

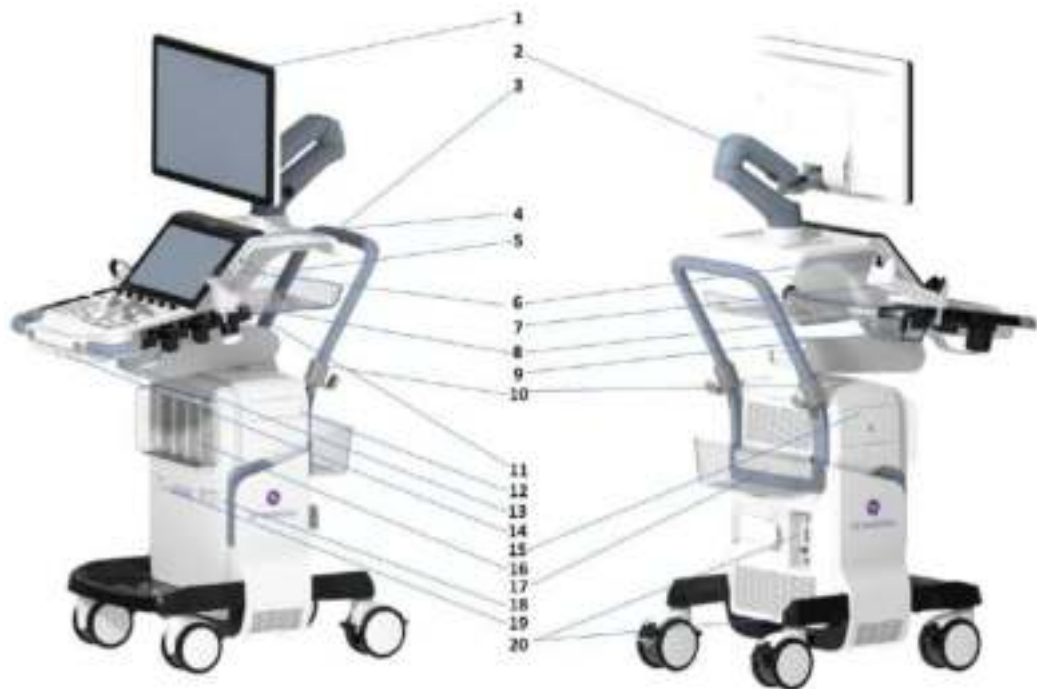

Figure 2-2. Patient Environmental Devices

- |  |   |
|--|---|
| 1. 23.8 inch widescreen monitor                | 12. V-Navi controller (Option)                                  |
| 2. Monitor arm                                 | 13. Front handle with control panel rotation and up/down button |
| 3. Rear handle                                 | 14. AN Keyboard (option)  |
| 4. Control panel with touch panel display      | 15. BW printer (option) or Drawer (option) bay                  |
| 5. OPIO rear tray (option)                     | 16. Probe connectors  |
| 6. USB port (2 A types, 2 C types), Microphone | 17. Rear basket (option)  |
| 7. Horizontal TV probe holder (option)         | 18. Patient I/O Port (Option)                                   |
| 8. Probe holder                                | 19. CW probe port (Option)                                      |
| 9. Gel holder or Gel warmer (option)           | 20. External I/O connectors and Mains power switch              |
| 10. Rear handle cable hook (option)            |   |
| 11. Wireless probe charger (option)            |   |

### Acceptable Devices

The Patient Environmental devices shown on the previous page are specified to be suitable for use within the PATIENT ENVIRONMENT.



CAUTION

DO NOT connect any probes or accessories without approval by GE HealthCare within the PATIENT ENVIRONMENT.

See 'Peripheral Update for EC countries' on *page 2-28 for more information*.

Any device connected to the LOGIQ Totus must conform to one or more of the requirements listed below:

1. IEC standard or equivalent standards appropriate to devices.
2. The devices shall be connected to PROTECTIVE EARTH (GROUND).

### Unapproved Devices



DANGER

DO NOT use unapproved devices.

If devices are connected without the approval of GE HealthCare, the warranty will be INVALID.

Any device connected to the Ultrasound System must conform to one or more of the requirements listed below:

1. IEC standard or equivalent standards appropriate to devices.
2. The devices shall be connected to PROTECTIVE EARTH (GROUND).

### Accessories, Options, Supplies



CAUTION

Unsafe operation or malfunction may result. Use only the accessories, options and supplies approved or recommended in these instructions for use.

## Acoustic Output

When the “Auto Freeze Time (probe selection required)” preset is selected on the Utility -> System -> System Imaging screen, the system auto freezes after the time specified (10 or 30 minutes, 1 hour, or Never) of scanning if it detects no change in the image.

Located on the upper right section of the system display monitor, the acoustic output display provides the operator with real-time indication of acoustic levels being generated by the system. See the *Acoustic Output chapter* in the *Advanced Reference Manual* for more information.

## Acoustic Output Display Specifications

The display consists of three parts: Thermal Index (TI), Mechanical Index (MI), and a relative Acoustic Output (AO) value.

The TI and MI are displayed at all times. The TI display starts at a value of 0.0, increments in steps of 0.1 and accuracy is  $\pm 50\%$ . For MI display values between 0 and 0.4, the display increments in steps of 0.01 and for values greater than 0.4, increments in steps of 0.1. The MI accuracy is  $\pm 25\%$ .

The AO percentage (AO%) value informs the user of where the system is operating within the range of available output. Accuracy of the AO% is  $\pm 10\%$ .

### Acoustic Output Display Specifications (continued)

#### Thermal Index

Depending on the examination and type of tissue involved, the TI parameter will be one of three types:

- **Soft Tissue Thermal Index (TIS)**. Used when imaging soft tissue only, it provides an estimate of potential temperature increase in soft tissue.
- **Bone Thermal Index (TIB)**. Used when bone is near the focus of the image as in the third trimester OB examination, it provides an estimate of potential temperature increase in the bone or adjacent soft tissue.
- **Cranial Bone Thermal Index (TIC)**. Used when bone is near the skin surface as in transcranial examination, it provides an estimate of potential temperature increase in the bone or adjacent soft tissue.

#### Mechanical Index

MI recognizes the importance of non-thermal processes, cavitation in particular. The Index is a relative indicator of the likelihood of mechanical bioeffect within the tissue.

#### Changing the Thermal Index Type

You can select the displayed TI type on Utility -> Imaging -> B-Mode. This preset is application dependent so each application could specify a different TI type.

#### Controls Affecting Acoustic Output

The potential for producing mechanical bioeffects (MI) or thermal bioeffects (TI) can be influenced by certain controls.

*Direct.* The Power Output control has the most significant effect on Acoustic Output.

*Indirect.* Indirect effects may occur when adjusting controls. Controls that can influence MI and TI are detailed under the Bioeffects portion of each control in the Optimizing the Image sections.

Always observe the Acoustic Output display for possible effects.

## Best practices while scanning



### HINTS

Raise the Acoustic Output only after attempting image optimization with controls that have no effect on Acoustic Output, such as Gain and TGC.

**NOTE:** Refer to the *Optimizing the Image* sections for a complete discussion of each control.



### DANGER

Be sure to have read and understood control explanations for each mode used before attempting to adjust the Acoustic Output control or any control that can affect Acoustic Output. During a screening and diagnostic ultrasound examination, high frequency sound penetrates and interacts with tissue in and around the area of anatomy to be imaged. Only a small portion of this sound energy is reflected back to the transducer for use in constructing the image, while the remainder is dissipated within the tissue. The interaction of sound energy with tissue at sufficiently high levels can produce biological effects (aka bioeffects) of either a mechanical or thermal nature. Although the generation of bioeffect is intentional with therapeutic ultrasound, it is generally undesired in screening and diagnostic applications and may be harmful in some conditions.



### Acoustic Output Hazard

Use the minimum necessary acoustic output to get the best diagnostic image or measurement during an examination. Begin the exam with the probe that provides an optimum focal depth and penetration.

### Acoustic Output Default Levels

In order to assure that an exam does not start at a high output level, the LOGIQ Totus initiates scanning at a reduced default output level. This reduced level is preset programmable and depends upon the exam category and probe selected. It takes effect when the system is powered on or **New Patient** is selected.

To modify acoustic output, adjust the Power Output level on the Touch Panel.



Figure 2-3. Location of Power Output control

### Acoustic Output on Pleural Preset

The U.S. Food and Drug Administration (FDA) recommends that MI levels should be lower than 1.4 when scanning lungs.

Select the Pleural preset when performing a lung exam. The displayed MI will not exceed 0.8 with Pleural preset selected. Differences in MI values are a result of probe to probe variation as well as the calculation accuracy of the displayed MI value.

## **WEEE Passport**

The WEEE (Waste Electrical and Electronic Equipment) Passport describes product recycling information. To access the WEEE passport for GE HealthCare products:

1. Go to the GE HealthCare Support Documentation Library at:  
<https://www.gehealthcare.com/support/documentation>
2. Select the modality "Ultrasound (UL)."
3. Enter the document name or the keyword "WEEE."
4. Press "Search."
5. Select the desired WEEE passport.

## RoHS LOGIQ Totus Hazardous Substances

The following product pollution control information is provided according to SJ/T 11364-2024 Marking for Control of Pollution caused by Electronic Information Products.



The symbol above indicates the product contains hazardous materials in excess of the limits established by the Chinese standard GB/T 26572 Requirements for Concentration Limits for Certain Hazardous Substances in Electronic Information Products. The number in the symbol is the Environment-friendly Use Period (EFUP), which indicates the period during which the hazardous substances or elements contained in electrical and electronic products will not leak or mutate under normal operating conditions so that the use of such electrical and electronic products will not result in any severe environmental pollution, any bodily injury or damage to any assets. The unit of the period is “Year.”

In order to maintain the declared EFUP, the product shall be operated normally according to the instructions and environmental conditions as defined in the product manual, and periodic maintenance schedules specified in Product Maintenance Procedures shall be followed strictly. Consumables or certain parts may have their own label with an EFUP value less than the product. Periodic replacement of those consumables or parts to maintain the declared EFUP shall be done in accordance with the Product Maintenance Procedures.

This product must not be disposed of as unsorted municipal waste, and must be collected separately and handled properly after decommissioning.



## Name and Concentration of Hazardous Substances

Table 2-10: Table of hazardous substances' name and concentration for LOGIQ Totus

Component Name	Hazardous substances' name									
	Pb	Hg	Cd	Cr (VI)	PBBs	PBDEs	DBP	DIBP	BBP	DEHP
Display	X	O	O	O	O	O	O	O	O	O
Circuit Boards	X	O	O	O	O	O	O	O	O	O
Touch Panel	O	O	O	O	O	O	O	O	O	O
Console Cabinet	O	O	O	O	O	O	O	O	O	O
Operator Panel	O	O	O	O	O	O	O	O	O	O
Console Frame (Base Casting, Castings, Card Rack)	O	O	O	O	O	O	O	O	O	O
System Covers	O	O	O	O	O	O	O	O	O	O
System Cables	O	O	O	O	O	O	O	O	O	O
Ultrasound Probes	X	O	O	O	O	O	O	O	O	O

This table is prepared according to SJ/T 11364.  
O: Indicates that this hazardous substance contained in all of the homogeneous materials for this part is below the limit requirement in GB/T 26572.  
X: Indicates that this hazardous substance contained in at least one of the homogeneous materials used for this part is above the limit requirement in GB/T 26572.

- Data listed in the table represents best information available at the time of publication.
- Applications of hazardous substances in this medical device are required to achieve its intended clinical uses, and/or to provide better protection to human beings and/or to environment, due to lack of reasonably (economically or technically) available substitutes

Note: Options may not be present on every system.

## India Battery Waste Management

India Battery Waste ERP Certificate No.: 12331169

## Safe Product and Packaging Disposal

This product and package should be disposed of according to hospital disposal practices, and local environmental and waste disposal regulations. Components and accessories of the LOGIQ Totus which have come into direct or indirect contact with the patient may be biohazardous, and should be disposed of according to facility guidelines for biohazardous material. The

waste of electrical and electronic equipment must not be disposed as unsorted municipal waste and must be collected separately. Please contact an authorized representative of the manufacturer for information concerning the disposal/ decommissioning of equipment.

# Device Labels

## Label Icon Description

The following tables describes the purpose and location of safety labels and other important information provided on the equipment.

**NOTE:** *This machine should be used in compliance with law. Some jurisdictions restrict certain uses, such as gender determination (shown for country specific label).*



Figure 2-4. Rear Panel Label Location

## Label Icon Description (continued)

Table 2-11: Label Icons (Rear of Console)







No.	Label/Icon	Purpose/Meaning/Reference Standard
		GE HealthCare Logo
1.		Monitor Label: GE HealthCare created  DO NOT place a finger, hand or any object on the joint of the monitor or monitor arm to avoid injury when moving the monitor and monitor arm.
1. and 3.		Follow instruction for use.  IEC 60601-1:2005+A1:2012 Annex D.1 and ISO 7010-M002
1. and 3.	RoHS Label-China Systems only (shown for Country specific label)  	China Electronics Industry Standard SJ/T 11364-2024  Indicates the presence of hazardous substance(s) above the maximum concentration value. Maximum concentration values for electronic information products, as set by the People's Republic of China Electronics Industry Standard GB/T 26572, include the hazardous substances of Lead, Mercury, Hexavalent chromium, Cadmium, Polybrominated biphenyls (PBBs), Polybrominated diphenyl ethers (PBDEs), Dibutyl phthalate (DBP), Diisobutyl phthalate (DIBP), Butyl benzyl phthalate (BBP), and Bis (2-ethylhexyl) phthalate (DEHP). "20" indicates the number of years during which the hazardous substance(s) will not leak or mutate so that the use of this product will not result in any severe environmental pollution, bodily injury, or damage to any assets.
1 and 3.		This WEEE symbol indicates that waste electrical and electronic equipment must not be disposed of as unsorted municipal waste and must be collected separately. Please contact an authorized representative of the manufacturer for information concerning the decommissioning of your equipment. Standard: EN 50419.  WEEE Directive 2012/19/EU
1. and 3.		"General Warning Sign" Possible shock hazard. Do not remove covers or panels. No user serviceable parts are inside. Refer servicing to qualified service personnel. Standard: ISO 7010-W001.

Table 2-11: Label Icons (Rear of Console) (Continued)







No.	Label/Icon	Purpose/Meaning/Reference Standard
1. , 3. and 8.		<p>Pinch point caution Watch your hands and fingers when adjusting the monitor. Keep hands clear of openings.</p> <p>GE HealthCare created</p>
		<p>Maximum load 1kg- Danger of breaking. Do not put any items exceeding the indicated maximum load limit on this shelf.</p> <p>ISO 7010-P012</p>
2.		<p>Every system has a unique marking for identification, the Unique Device Identification (UDI) Label. The UDI label consists of a series of alpha-numeric characters and barcode which uniquely identify the LOGIQ Totus system as a medical device manufactured by GE HealthCare. Scan or enter the UDI information into the patient health record as required by country-specific laws.</p>
		<p>UDI Human Readable Label Text: Global Trade Item Number (GTIN), Manufacturing Date, Serial Number</p> <p>GE HealthCare created</p>
		<p>UDI Symbol and Data Matrix</p> <p>ISO15223-1</p>
2.		<p>System Voltage (100-240VAC) Frequency Power Rating</p> <p>IEC 61293 /IEC 60601-1</p>
2.		<p>Alternating Current symbol is in accordance with IEC 60417-5032</p>
2.		<p>Catalog/Model Number. Standard: ISO 7000-2493.</p>

Table 2-11: Label Icons (Rear of Console) (Continued)



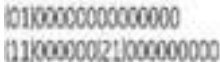





No.	Label/Icon	Purpose/Meaning/Reference Standard
2.		Serial Number. Standard: ISO 7000-2498.
2.		Legal Manufacturer's name and address. Standard: ISO 7000-3082.
2.		Date of manufacture YYYY-MM. Standard: ISO 7000-2497.
2.		ANSI/AAMI ES 60601-1:2005/A2:2021, CAN/CSA-C22.2 No. 60601-1 (Amendment 2:2022)
3.		<p>The CE Mark of Conformity indicates this equipment conforms with the European Medical Device Regulation 2017/745</p> <p>European Medical Device Regulation 2017/745</p>
3.		<p>Do not use the following devices near this equipment: cellular phone, radio receiver, mobile radio transmitter, radio controlled toy, broadband power lines, etc. Use of these devices near this equipment could cause this equipment to perform outside the published specifications. Keep power to these devices turned off when near this equipment.</p> <p>ISO 7010-P013</p>
3.		<p>DO NOT push the system. Use the handle to push/pull the system, e.g., DO NOT use the monitor. Failure to do so may cause serious injury or system damage.</p> <p>IEC 60601-1:2005+A1:2012 Annex D.2 and ISO 7010-P017</p>
3.		<p>United States only            Prescription Device label            21 CFR 801.109 and Alternative to Certain Prescription Device Labeling Requirements Guidance to Industry 1/2/2000 U.S. Food&amp;Drug Administration modified by GE HealthCare for clarity that this is for the USA</p>
3.		Type BF Applied Part (man in the box) symbol is in accordance with IEC 60417-5333.

Table 2-11: Label Icons (Rear of Console) (Continued)







No.	Label/Icon	Purpose/Meaning/Reference Standard
3.		Symbol indicating that the Instructions for Use are supplied in electronic form. ISO 7000-3500
3.		Use two people to transport system on inclines. This label also indicates the system weight. To avoid possible injury and equipment damage when transporting from one area of use to another: <ul style="list-style-type: none"> <li>• Be sure the pathway is clear.</li> <li>• Limit movement to a slow careful walk.</li> <li>• Use two or more persons to move the equipment on inclines or long distance.</li> </ul> GE HealthCare created
3.		This product is a medical device ISO15223-1
3.		Unlock/Lock the monitor arm GE HealthCare created
3.		The MR Unsafe label is to <b>warn</b> that this Ultrasound System poses risks to the patient, medical staff or other persons within the MR environment and that the Ultrasound system should remain outside of the MR environment ISO 7010
3.		The CH-REP label indicates the authorized representative in Switzerland Regulation (EU) 2017/745
4.		Gender Caution (only for India, China, Korea) GE HealthCare created

Table 2-11: Label Icons (Rear of Console) (Continued)





No.	Label/Icon	Purpose/Meaning/Reference Standard
5.		<p>Possible shock hazard. Do not remove covers or panels. No user serviceable parts are inside. Refer servicing to qualified service personnel.</p> <ol style="list-style-type: none"> <li>1. Network/Disk/Battery Indicators</li> <li>2. Audio out connector</li> <li>3. Ethernet connector</li> <li>4. USB 3.0 port</li> <li>5. USB 3.0 port</li> <li>6. HDMI connector</li> <li>7. DP connector</li> <li>8. VGA connector</li> <li>9. Composite connector</li> <li>10. S-Video connector</li> </ol>
6.		<ol style="list-style-type: none"> <li>1. System voltage (~100-240VAC) Frequency Power Rating</li> <li>2. "Equipotentiality" indicates the terminal to be used for connecting equipotential conductors when interconnecting (grounding) with other equipment. Connection of additional protective earth conductors or potential equalization conductors is not necessary in most cases and is only recommended for situations involving multiple equipment in a high-risk patient environment to provide assurance that all equipment is at the same potential and operates within acceptable leakage current limits. An example of a high-risk patient would be a special procedure where the patient has an accessible conductive path to the heart such as exposed cardiac pacing leads. IEC60417-5021 IEC 60601-1:2005+A1:2012 Annex D.1 and IEC 60417-5021</li> </ol>
7.	Country Specific Label	Country Specific label are required to comply with country regulation
9.		<p>The system contains the following wireless module: INTEL AX210NGW</p> <p>*Those symbols and certification marks corresponding to number "9" are only for wireless module : INTEL AX210NGW. Those are not related to the certification of LOGIQ Totus.</p> <p>**The latest information on INTEL certification can be found at the following link: <a href="https://www.intel.com/content/www/us/en/support/articles/000007443/wireless/legacy-intel-wireless-products.html">https://www.intel.com/content/www/us/en/support/articles/000007443/wireless/legacy-intel-wireless-products.html</a></p>
9.		Australia RCM certification mark



Table 2-11: Label Icons (Rear of Console) (Continued)









No.	Label/Icon	Purpose/Meaning/Reference Standard
9.		Moldova SM certification mark and number
9.		Malaysia MCMC certification mark and number
9.		South Korea KC certification mark and number
9.		South Africa - ICASA certification mark and number
9.		Pakistan Telecommunication Authority (PTA)
9.		Serbia RATEL certification mark
9.		Ukraine NCCIR certification mark
9.		Brazil ANATEL certification mark and number
9.		USA FCC certification mark and number
9.	<p data-bbox="333 1523 510 1549">IC: 1000M-AX210NG</p>	Canada ISED certification number
9.	<p data-bbox="322 1614 537 1641">CMIIT ID:2020AJ11402(M)</p>	China SRRC certification number

Table 2-11: Label Icons (Rear of Console) (Continued)









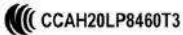

No.	Label/Icon	Purpose/Meaning/Reference Standard
9.		Belarus TR BY certification mark
9.		Singapore IMDA certification mark
9.		Taiwan NCC certification mark and number
9.		Taiwan BSMI certification mark and number
9.		Japan MIC certification mark and number
9.		UAE TDR A certification mark and number
		Degrees of protection provided by enclosures (IP Code) IEC 60529
Operator control panel		<p>“ON” indicates the power on position of the power switch. <b>CAUTION:</b> This Power Switch <b>DOES NOT ISOLATE</b> Mains Supply.</p> <p>IEC 60601-1:2005+A1:2012 Annex D.1, IEC 60417-5007 and IEC 60417-5009</p>
System packing		<p>DO NOT USE HOOK</p> <p>To indicate that hooks shall not be used for handling the transport package.</p> <p>ISO7000-0622</p>
System packing		<p>TOP, UPRIGHT - Transportation and Storage</p> <p>To indicate correct upright position of the transport package.</p> <p>ISO7000-0623</p>

Table 2-11: Label Icons (Rear of Console) (Continued)

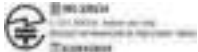

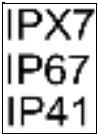





No.	Label/Icon	Purpose/Meaning/Reference Standard
System packing		<p>Fragile, handle with care</p> <p>Indicate a medical device that can be broken or damaged if not handle carefully</p> <p>ISO15223-1: 5.3.1 ISO7000-0621</p>
System packing		<p>Do not stack</p> <p>ISO7000-2402</p>
System packing		<p>Keep dry (Protect from moisture)</p> <p>Indicates a medical device that needs to be protected from moisture.</p> <p>ISO15223-1: 5.3.4 ISO7000-0626</p>
System packing		<p>Temperature limitation</p> <p>Indicates the temperature limits to which the medical device can be safely exposed.</p> <p>ISO15223-1: 5.3.7 ISO7000-0632</p>
System packing		<p>Humidity control</p> <p>Indicates the range of humidity to which the medical device can be safely exposed.</p> <p>ISO15223-1: 5.3.8 ISO7000-2620</p>
System packing		<p>Range of Air Pressure</p> <p>Indicates the range of atmospheric pressure to which the medical device can be safely exposed.</p> <p>ISO15223-1: 5.3.9 ISO7000-2621</p>
System packing		<p>RECYCLING PAPER 30% USED</p> <p>To indicate that the marked item or its material is part of a recovery or recycling process.</p> <p>ISO 7000-1135</p>

Table 2-11: Label Icons (Rear of Console) (Continued)

No.	Label/Icon	Purpose/Meaning/Reference Standard
ECG connector		Defibrillation-proof CF applied part IEC 60601-1:2005+A1:2012 Annex D.1 and IEC 60417-5336
eTRAX needle		CF applied part IEC 60601-1:2005+A1:2012 Annex D.1 and IEC 60417-5335

Label on the packing box



Figure 2-5. Package label

This label is printed on the packing box of the system to indicate the humidity, temperature and air pressure condition for the storage and shipment.

## Probe Labeling

Each probe is labeled with the following information:

- Seller's name and manufacturer
- Operating frequency (not shown on all probes)
- GE HealthCare part number
- Probe serial number
- Month and year of manufacture
- Probe designation-provided on the probe grip and the top of the connector housing, so it is easily read when mounted on the system and is also automatically displayed on the screen when the probe is selected.
- UDI Symbol and Data Matrix
- DI Human Readable LabelText: Global Trade Item Number, GTIN

The following information appears on all probe labels, regardless of the connector type, except for "IPX7," "CE Mark," and "XDclear™" which only appears on applicable probes.



Figure 2-6. Probe Label (Example)

- |  |  |
|--|--|
| 1. GE HealthCare Logo  | 9. CE Mark and Notified Body Number                          |
| 2. Probe Model (Name)  | 10. REF: Catalog/model number                                |
| 3. UDI Symbol and Data Matrix  | 11. Serial Number  |
| 4. UDI Human Readable LabelText: Global Trade Item Number, GTIN, (01), Manufacturing Date (11), Serial Number (21) | 12. Manufacturer's site country of origin                    |
| 5. Type BF/CF Applied Part   | 13. Legal Manufacturer's Name and Address                    |
| 6. Caution: Consult the Manual.  | 14. Date of Manufacture, as YYYY-MM                          |
| 7. WEEE Waste Symbol   | 15. Product Marketing Indicator information may appear here. |
| 8. Chinese RoHS Hazardous Substance Symbol   | 16. IP Classification  |
|  | 17. Symbol indicates the item is a medical device.           |

**NOTE:** *Non-GE HealthCare probes will also have a UDI symbol and equivalent information.*

---

## Chapter 3

# Preparing the System for Use

*Describes the site requirements, console overview, system positioning/transporting, powering on the system, adjusting the display monitor, probes and operator controls.*

# Site Requirements

## Introduction

Qualified and trained HealthCare professionals, including physicians, sonographers and equivalent/compareable professions, with at least basic ultrasound knowledge. Only qualified physicians or sonographers should perform ultrasound scanning on human subjects for medical diagnostic reasons. Request training, if needed.

Do not attempt to set up the system alone. GE HealthCare, Affiliate, or Distributor Field Engineers and Application Specialists will install and setup the system. See 'Contact Information' on *page 1-12 for more information*.

The LOGIQ Totus does not contain any operator serviceable internal components. Ensure that unauthorized personnel do not tamper with the unit.

Never set liquids on the unit to ensure that liquid does not drip into the control panel or unit.



## **Before the system arrives**

### **NOTICE**

This medical equipment is approved, in terms of the prevention of radio wave interference, to be used in hospitals, clinics and other institutions which are environmentally qualified. The use of this equipment in an inappropriate environment may cause some electronic interference to radios and televisions around the equipment.

Ensure that the following is provided for the new system:

- A separate power outlet with a 20 amp circuit breaker for 120 VAC for 120 V area, 10 amp circuit breaker for 250 VAC for 220/240 V area.
- Take precautions to ensure that the console is protected from electromagnetic interference.

Precautions include:

- Operate the console at least 5 meters (15 feet) away from motors, typewriters, elevators, and other sources of strong electromagnetic radiation (non-medical grade UPS must be at least 2 meters (6 feet) away from console).
- Operation in an enclosed area (wood, plaster or concrete walls, floors and ceilings) helps prevent electromagnetic interference.
- Special shielding may be required if the console is to be operated in the vicinity of radio broadcast equipment.

## Environmental Requirements

### LOGIQ Totus

The system should be operated, stored, or transported within the parameters outlined below. Either its operational environment must be constantly maintained or the unit must be turned off.

*NOTE: You may get an overheating message with regard to fan speed. Ensure adequate system/room ventilation.*

Table 3-1: System Environmental Requirements

	Operational	Storage	Transport (<16hrs.)
Temperature	10° - 35°C/50° - 95°F with 2D probe 18° - 30°C/64.4° - 86°F with 4D probe	-10° - 50°C 14° - 122°F	-10° - 50°C 14° - 122°F
Humidity	30 - 80% non-condensing	10 - 90% non-condensing	10 - 90% non-condensing
Pressure	700 - 1060hPa	700 - 1060hPa	700 - 1060hPa

**Probe**

Probes should be operated, stored, or transported within the parameters outlined below.

Table 3-2: Probe Environmental Requirements

	Operational
Temperature	10° - 35°C with 2D probe 18° - 30°C with 4D probe
Humidity	10 - 80% non-condensing for 2D probe 30 - 80% non-condensing for 4D probe
Pressure	700 - 1060hPa



CAUTION

Note that the environmental conditions of the ultrasound system and the probe may differ.



CAUTION

Ensure that the probe face temperature does not exceed the normal operation temperature range.



CAUTION

Check the room temperature before you use the 4D probe.

# Console Overview

## Console Graphics (LCD monitor)

The following are illustrations of the console:



Figure 3-1. LOGIQ Totus System

- |   |   |
|---|---|
| 1. Monitor  | 18. Air filter (Inside the side cover right)                                  |
| 2. Touch panel  | 19. Control panel rear tray (Option)  |
| 3. Control panel with power on/off button                 | 20. Rear cable hook   |
| 4. Control panel swivel button                            | 21. DP, VGA, Composite, S-Video Connector (Option)                            |
| 5. Physical A/N keyboard (Option)                         | 22. Air filter (Inside the rear cover)  |
| 6. Control panel up/down button                           | 23. Circuit breaker, AC inlet   |
| 7. Probe cable management Hook (underneath Control panel) | 24. USB 3.0 Ports   |
| 8. Probe ports (4)  | 25. Probe holder left   |
| 9. CW probe port (Option)                                 | 26. Gel holder or Gel warmer (Option)   |
| 10. Monitor arm   | 27. Probe cable management Hook (underneath Control panel)                    |
| 11. USB 3.0 ports   | 28. B/W printer (Option)  |
| 12. Rear handle   | 29. Peripheral USB 3.0 ports, Ethernet Connector, HDMI connector, Audio input |
| 13. Probe holder right                                    | 30. Air filter (Inside the side cover left)                                   |
| 14. Rear handle cable hook (Option)                       | 31. Wheel (4)   |
| 15. V-Nav controller (Option)                             |   |
| 16. Rear basket (Option)                                  |   |
| 17. Patient I/O Port (Option)                             |   |

Console Graphics (HDU monitor)



Figure 3-2. LOGIQ Totus System

- |   |  |
|---|--|
| <ol style="list-style-type: none"> <li>1. Monitor</li> <li>2. Touch panel</li> <li>3. Control panel with power on/off button</li> <li>4. Control panel swivel button</li> <li>5. Physical A/N keyboard (Option)</li> <li>6. Control panel up/down button</li> <li>7. Probe cable management Hook (underneath Control panel)</li> <li>8. Probe ports (4)</li> <li>9. CW probe port (Option)</li> <li>10. Monitor arm</li> <li>11. USB 3.0 ports</li> <li>12. Rear handle</li> <li>13. Probe holder right</li> <li>14. Rear handle cable hook (Option)</li> <li>15. V-Nav controller (Option)</li> <li>16. Rear basket (Option)</li> <li>17. Patient I/O Port (Option)</li> </ol> | <ol style="list-style-type: none"> <li>18. Air filter (Inside the side cover right)</li> <li>19. Control panel rear tray (Option)</li> <li>20. Rear cable hook</li> <li>21. DP, VGA, Composite, S-Video Connector (Option)</li> <li>22. Air filter (Inside the rear cover)</li> <li>23. Circuit breaker, AC inlet</li> <li>24. USB 3.0 Ports</li> <li>25. Probe holder left</li> <li>26. Gel holder or Gel warmer (Option)</li> <li>27. Probe cable management Hook (underneath Control panel)</li> <li>28. B/W printer (Option)</li> <li>29. Peripheral USB 3.0 ports, Ethernet Connector, HDMI connector, Audio input</li> <li>30. Air filter (Inside the side cover left)</li> <li>31. Wheel (4)</li> </ol> |
|---|--|



### DANGER

**DO NOT** touch the patient and any of the connectors on the ultrasound unit simultaneously, including ultrasound probe connectors. **DO NOT** touch the conducting parts of the USB, Ethernet, Video or Audio cables when connecting equipment to the unit. Failure to follow these instruction could lead to electrical shock.



### CAUTION

For compatibility reasons, use only GE HealthCare approved probes, peripherals or accessories.

**DO NOT** connect any probes or accessories without approval by GE HealthCare. Failure to follow these instructions could lead to unexpected diagnostic performance.

## **External drives (USB Flash Drive, USB HDD)**

Approved USB Hard Disk and USB Flash Drives may be used for Save As and Backup/Restore in the powered system USB ports.

You can use these to perform software upgrades, image archiving, and service diagnostics.

USB Drives are an ESD-sensitive device. Only use USB 2.0/3.0/ C Drives recommended by GE HealthCare.

### Speakers

Audio is provided via internal speakers.

**NOTE:** You make volume adjustments on the Utility Touch Panel (Master Volume, Effects Volume).

- Audio Doppler operation
- Audio playback of recorded scan sessions
- Audio error notification.

### Storage areas

Storage areas are available and can be used to store gel, options, probe cables, accessories, etc.



Figure 3-3. Storage area

1. Base tray - Max. allowable load : 2kg
2. Control panel rear tray (Option) - Max. allowable load : 1kg
3. Rear basket (Option) - Max. allowable load : 2kg

**NOTE:** DO NOT put the max. allowable load exceeded on the tray or basket.



## Install the TVTR Probe holder (Option)

Push the TVTR Probe holder into the left-side probe holder until it clicks as the picture below.



Figure 3-4. Install TVTR Probe holder



Figure 3-5. TVTR Probe Holder

When remove the TVTR probe holder from the system, pull the hook and pull out the probe holder.



Figure 3-6. Pull the hook to disassemble the probe holder

## Peripheral/Accessory Connection

### Peripheral/Accessory Connector Panel

LOGIQ Totus peripherals can only be properly connected using the peripheral/accessory connector panel. Available connectors are audio out, two USB 3.0 ports, HDMI port and Ethernet connector, with options DP, VGA, S-VIDEO and COMPOSITE.



**DANGER**

The connection of equipment or transmission networks other than as specified in these instructions can result in electric shock hazard. Alternate connections will require verification of compatibility and conformity to IEC/EN 60601-1 by the installer. Equipment modifications and possible resulting malfunctions and electromagnetic interference are the responsibility of the owner.



**CAUTION**

For compatibility reasons, use only GE HealthCare-approved probes, peripherals, or accessories.

**DO NOT** connect any probes or accessories without approval by GE HealthCare. Failure to follow these instructions could lead to unexpected diagnostic performance.

Table 3-3: Peripheral/Accessory Connector Panel

	<ol style="list-style-type: none"> <li>1. Audio Out</li> <li>2. RJ-45 Modular, 8-pin Ethernet</li> <li>3. USB 3.0 port</li> <li>4. USB 3.0 port</li> <li>5. HDMI connector</li> <li>6. DP connector (Option)</li> <li>7. VGA connector (Option)</li> <li>8. Composite connector (Option)</li> <li>9. S-Video connector (Option)</li> </ol>
--	--

## **Unity Video Scaler and Converter (UVSC)**

The LOGIQ Totus UVSC Option enables the ability for the console to view or record scanning via an DP, DVI, S-Video and Composite.

*NOTE: The S-Video and Composite image displays a portion of the main display that includes the probe image in both single and dual probe display modes. To provide increased resolution and maintain the proper aspect ratio on the S-Video and Composite display, the entire main display image is not projected on the S-Video and Composite monitor. The S-Video and Composite crop area was selected to optimize the probe image so when the console is not in an imaging mode the S-video and Composite will continue to display a cropped portion of the screen which may appear incorrect.*

## External Monitor

An external monitor can be connected to the LOGIQ Totus via the HDMI port, under the following guidelines:

- The display resolution must be set to (1080i) 1920x1080 on the external monitor, matching the main system display. Other resolutions are not supported.
- An isolation transformer must be used to power the external monitor to prevent adverse effects on the ultrasound scanner.
- It is the customer's responsibility to ensure leakage current and grounding is tested and complies with electrical leakage standards.



Figure 3-7. Connect HDMI Cable to back of LOGIQ Totus and External Monitor

## Front Panel Connections and Indicators

There are three sets of connector/indicators on the Front Panel: Hard Disk Drive and Network Status Indicators, CW Probe, Patient Cardiac/ECG Connections, and Volume Navigation (V Nav) Connections/Indicators

## Rear Panel Indicators

There are four sets of connector/indicators on the rear panel : SSD, Network and Battery Status Indicators

## Network Status Indicators

There are three front-panel status indicators:

Table 3-4: Local Drive and Network Status

	<ol style="list-style-type: none"><li>1. Local Drive Activity Status</li><li>2. Network Activity Status</li><li>3. Battery Activity Status</li></ol> <p>Charging : LED blinking Full charged : LED on Charge off (not full charge) or Discharging : LED off</p>
--	---

**Network and Spooler Status Icons**

The following icons identify network and spooler statuses. These appear on the display monitor.

Table 3-5: Network and Spooler Status Icons

Ethernet Active 	Ethernet Error 	Ethernet Active Spooler Active 	Ethernet Active Spooler Error 	Mobile 
Mobile Error 	Mobile Bluetooth 	Mobile Wifi 	Spooler Active 	Spooler Active Error 
Spooler Inactive 	Spooler Inactive Error 	Wifi 1 Bar 	Wifi 2 Bars 	Wifi 3 Bars 
Wifi 4 Bars 	Wifi Alert 	Wifi Spooler Active 	Wifi Spooler Error 	Wifi Error 

*NOTE: The Mobile icons are used for the Smart Device Apps (Tablet and Mobile Phone).*

**ECG Connections**

Table 3-6: ECG connection

	<ol style="list-style-type: none"> <li>1. ECG Connector</li> </ol>
---	--

Table 3-7: ECG Lead Placement

Lead	Patient Cable Marking		Position on Patient
	AHA	IEC	
I	RA (White)	R (Red)	Right Arm
II	LA (Black)	L (Yellow)	Left Arm
III	LL (Red)	F (Green)	Left Leg

**Volume Navigation Connections/Indicator**

Table 3-8: Volume Navigation Connections

	<ol style="list-style-type: none"> <li>1. Non-V Nav Inside Probe V Nav Receiver Connector (2 cables)</li> <li>2. V Nav Needle Tip Tracker/Virtual Tracker Sensor Connector</li> <li>3. V Nav Active Tracker Connector</li> <li>4. V Nav Transmitter Indicator</li> <li>5. V Nav Transmitter Connector</li> </ol>
--	--



# Powering the System

## Connecting the System



**DANGER**

Under no circumstances should the AC power plug be altered, changed, or adapted to a configuration rated less than specified. Never use an extension cord or adapter plug.

To help assure grounding reliability, connect to a “hospital grade” or “hospital only” grounded power outlet.



**DANGER**

Use the appropriate power cord provided by or designated by GE HealthCare. Failure to follow these instructions could lead to exposure to electrical shock.



**WARNING**

Use caution to ensure that the power cable does not disconnect during system use.

If the system is accidentally unplugged, data may be lost.



**WARNING**

To avoid leakage current above safety limits as prescribed by IEC 60601-1 and to ensure continuity of protective earth, DO NOT connect LOGIQ Totus and mains-operated accessories to a single or multiple socket extension cord or power strip.

## Connecting the System (continued)

To connect the system to the electrical supply:

1. Ensure that the wall outlet is the appropriate type.
2. Ensure that the power switch is turned off.
3. Unwrap the power cable. Make sure to allow sufficient slack in the cable so that the plug is not pulled out of the wall if the system is moved slightly.
4. Attach the power plug securely into the wall outlet.
5. Push the power plug securely into the wall outlet.

**NOTE:** *Do not use an extension cord or adapter plug except for GE HealthCare approved UPS.*

6. Ensure the circuit breaker is on (Figure 3-8 a). See 'Circuit breaker' on page 3-21 for more information.



Figure 3-8. Circuit Breaker (a) and Power Plug (b)

## Circuit breaker

The Circuit Breaker is located under the rear panel of the system. On supplies main power to all internal systems. Off removes main power from all internal systems. The circuit breaker automatically shuts off power to the system in case of a power overload.

If a power overload occurs:

1. Turn off all peripheral devices.
2. Reactivate the Circuit Breaker switch.

The Circuit Breaker switch should stay in the **On** position (“I”); **DO NOT** hold the switch in the **On** position. If the Circuit Breaker switch remains **On**, follow the Power On procedure.

*NOTE: If the Circuit Breaker switch does **not** remain in the **On** position or trips again:*

1. Disconnect the Power Cable.
2. Call Service immediately.

**DO NOT** attempt to use the system.

### Power On

Press the Power On/Off switch to turn the power on. The circuit breaker must also be in the on position. See 'Circuit breaker' on page 3-21 for more information.

#### To turn on the system

1. Ensure that the unit is properly plugged into an AC outlet of sufficient capacity (120V/10A or 240V/5A).
2. Turn on the breaker at the back of the system (refer to Figure 3-8 on page 3-20). At this point, the On/Off switch should be turned off.
3. Momentarily press the On/Off switch. The switch turns on a light. (refer to Figure 3-9 on page 3-22 ).
4. The system should now go through its boot-up process with no further user intervention (approximately 1 to 2 minutes).

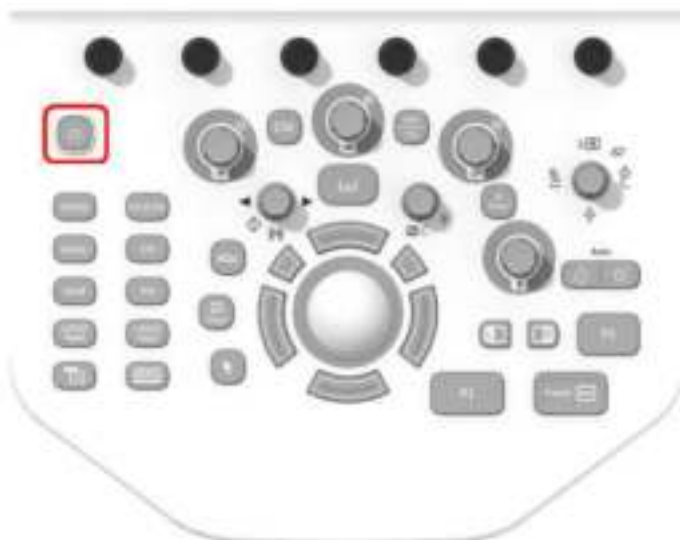

Figure 3-9. Power On/Off Switch Location

## Power Up Sequence

The system is initialized. During this time:

- The system boots up and the status is reflected on the monitor.
- Probes are initialized for immediate operation.

*NOTE: If no probe is connected, the system goes into freeze mode.*

- Peripheral devices are activated on power up.

After initialization is complete, controls on the Control Panel backlight and the default B-Mode screen is displayed on the monitor (if a probe is connected).

### Password Protection

#### Login

At login, you are notified that “You are accessing a diagnostic medical device that is provided by authorized usage only. Data stored on this device may be subject to various regulations including but not limited to regulations which govern disclosure and privacy of this data. By using this device you are acknowledging that you are authorized to do so and are trained in appropriate use and regulatory guidelines.”

*NOTE:* You can change the wording that appears on the Login screen. See ‘Logon Banner’ on page 10-157 for more information.

1. **Operator:** Enter the Operator ID.
2. **Password:** Enter Operator’s password (optional).
3. **Logon or Cancel.**
  - **OK:** Proceed with the logon
  - **Emergency:** Data stored only for the duration of the current exam (EUSR).
4. **Change Password:** Change password, as specified by the Password Policy.

## Initial Login to the LOGIQ Totus

When first logging in to the LOGIQ Totus:

1. The Administrator should log in, typing “ADM” as the Operator Login.

*NOTE: No password is needed for the initial administrator log in.*

*NOTE: The Touch Keyboard displays when a field is selected. Use the keyboard to enter the Operator ID and Password.*



Figure 3-10. First Admin Login to the LOGIQ Totus

**Initial Login to the LOGIQ Totus (continued)**

2. Upon ADM Login, specify the institution’s Default Security Level for the LOGIQ Totus: Lowest, Medium, High (Recommended), or Highest), then select **Apply Change**.

*NOTE: You may choose Skip For Now up to 20 times total to postpone choosing the Security Level. After 20 skips the system will require a Security Level to be chosen.*

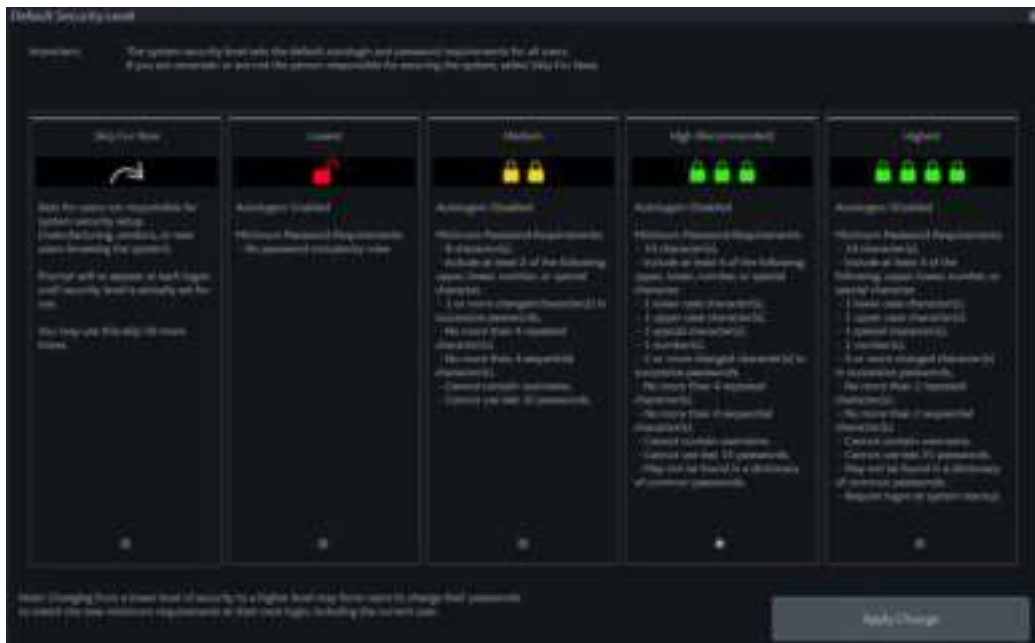

Figure 3-11. Default Security Level

Table 3-9: Security Levels

Security Level	Complexity Rules
Skip For Now	Best for users not responsible for system security setup (manufacturing, vendors or new users browsing the system). Prompt will re-appear at each logon until security level is set for use. This skip can be chosen 20 total times before the system will require a security level to be chosen.
Lowest	Autologon enabled. No password complexity rules.
Medium	Autologon disabled. Minimum Password Requirements: <ul style="list-style-type: none"> <li>• 8 characters.</li> <li>• Include at least two of the following: one upper case character, one lower case character, one number and/or one special character.</li> <li>• One or more changed character(s) in successive passwords.</li> <li>• No more than four repeated characters.</li> <li>• No more than four sequential characters.</li> <li>• Cannot contain username.</li> <li>• Cannot use the last 10 passwords.</li> </ul>



Table 3-9: Security Levels (Continued)

Security Level	Complexity Rules
High (Recommended)	Autologon disabled. Minimum Password Requirements: <ul style="list-style-type: none"> <li>• 10 characters.</li> <li>• One lower case character.</li> <li>• One upper case character.</li> <li>• One special character.</li> <li>• One number.</li> <li>• Two or more changed characters in successive passwords.</li> <li>• No more than four repeated characters.</li> <li>• No more than four sequential characters.</li> <li>• Cannot contain username.</li> <li>• Cannot use last 15 passwords.</li> <li>• May not be found in a dictionary of common passwords.</li> </ul>
Highest	Autologon disabled. Minimum Password Requirements: <ul style="list-style-type: none"> <li>• 14 characters.</li> <li>• One lower case character.</li> <li>• One upper case character.</li> <li>• One special character.</li> <li>• One number.</li> <li>• Four or more changed characters in successive passwords.</li> <li>• No more than two repeated characters.</li> <li>• No more than two sequential characters.</li> <li>• Cannot contain username.</li> <li>• Cannot use last 25 passwords.</li> <li>• May not be found in a dictionary of common passwords.</li> <li>• Require logon at system startup.</li> </ul>

### Initial Login to the LOGIQ Totus (continued)

3. If a Security Level is chosen, the Confirm Change screen appears.

If *Lowest* or *Medium* Security Level was chosen, you will be prompted to acknowledge that the security setting is lower than GE HealthCare recommends to secure the system. You will not be able to Confirm Change unless the “I Agree” box is selected.

If *Medium*, *High* or *Highest* Security Level was chosen, you can choose to change your password immediately and/or to force all users to change their password at next login.

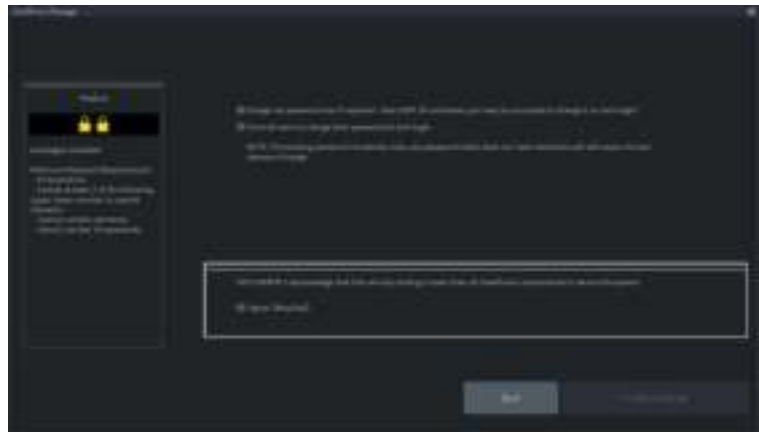

Figure 3-12. Confirm Change Screen

**Initial Login to the LOGIQ Totus (continued)**

4. You will be prompted to set up the ADM password, based on the selected Security Level.

**NOTE:** *If the password you type doesn't meet the selected Security Level's password complexity rules, the screen will prompt you (in red) to correct the password, as shown below.*

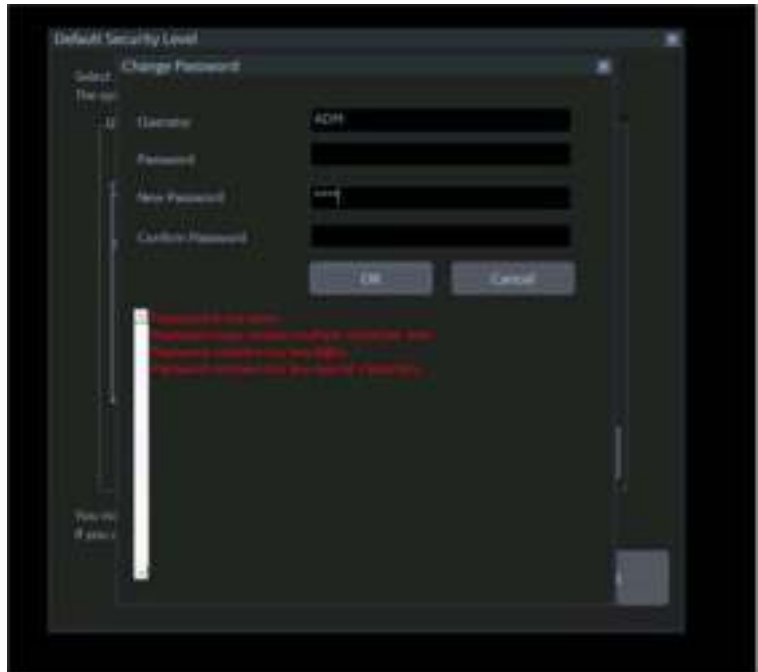

Figure 3-13. Change Password

### Initial Login to the LOGIQ Totus (continued)

5. After logging in, complete the system encryption setup. Navigate to the Disk Encryption Utility, Utility--> Admin--> Disk Encryption page. The system encrypts patient data by default (Encryption On. Disks are unlocked automatically). If you wish to change the default encryption setting, select the desired Encryption Policy, then press Accept.

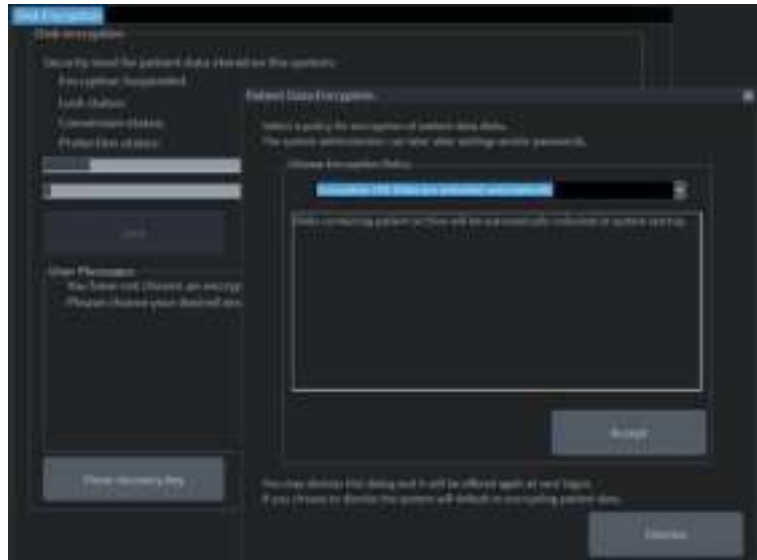

Figure 3-14. Initialize System Encryption

**NOTE:** *If you (or the Field Service Engineer) reloads system software, you will need to press “Initialize System Encryption” to encrypt the system and reset System Encryption password and preferences.*

Initial Login to the LOGIQ Totus (continued)

Table 3-10: Encryption Policy Selections

Encryption Policy	Description
Encryption OFF	Patient Data will not be encrypted. Selecting "OFF" will unencrypt the drive. System drive and recovery partition will remain encrypted.
Encryption ON. Disks are unlocked automatically	System Default. Patient data is encrypted and unlocked at system boot-up. Recovery Key and Password tied to the hard drive.
Encryption ON. Require Pre-Boot PIN/Password before unlocking system drives	The system will not boot until the Pre-Boot PIN or Password has been entered. Unlike other manual key entry configurations, <b>no system functionality</b> is available without the PIN/Password. This encryption policy is intended for high security environments or customers with specific needs.
Encryption ON. Key is stored on USB/password is entered manually	The system will request the encryption password or recovery key at system startup. The system is not accessible until this password or a disk recovery key is provided. Requiring a password to access the patient archive may prevent emergency usage of the system.

*NOTE: If you choose to dismiss this dialog, this dialog will be offered to you again at the next logon.*

**Initial Login to the LOGIQ Totus (continued)**

- 6. You must set the Encryption Password and record the Recovery Key in order to ensure access to your institution’s patient data (required if replacing the system drive, ECB Board, or reformatting the C:\ Drive).

Recovery Keys are not backed up by the system; you must record / archive the Recovery Key in order to retrieve patient data.

- a. Reset the Encryption Password by pressing “Change password”.

Reply “**No**” to this Question, “Password is already set on a disk. Do you want to reuse it? Press “**No**” to delete existing password. You will be prompted to set new.

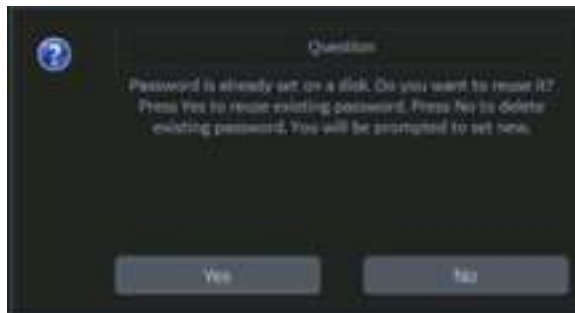

You can now update the encryption password, then press **OK**.



**Initial Login to the LOGIQ Totus (continued)**

- b. Record the Recovery Key by pressing “Show recovery key”, then printing it to a local printer or PACS. Or, save the Recovery Key to a USB Flash Drive by pressing “Save recovery keys”.

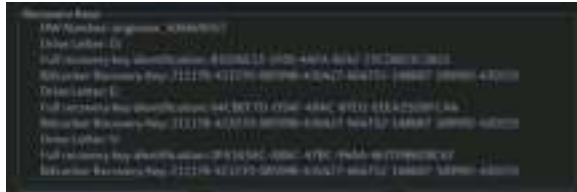

You can Show or Hide the Encryption key. Store the Recovery Key in a secure location, accessible to the ADM user as necessary.

**Encryption Notes**

The system is usable while it is being encrypted. Encryption can take between 20 minutes and several hours, depending upon system configuration; a status bar tracks encryption progress. It is a background task. You can scan while the system is being encrypted. You can also power the system down and back on while the disk is being encrypted; disk encryption will pick up where it left off in the encryption process.

### Changing Your Password

The System Administrator manages system groups, users, and permissions. After you have been added as a valid user, the System Administrator will assign you a temporary password. When you log into the system for the first time, you will be prompted to change your password.

You can change your password at any time when first logging onto the system. To change your password

1. Type your name in the Operator field.
2. Press the Change Password button. The Change Password pop-up appears.

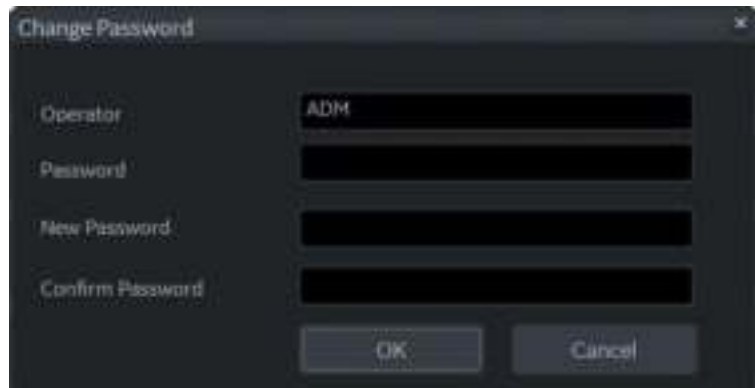

Figure 3-15. Password Change

3. Type the following:
  - **Password:** Type your current password.
  - **New Password:** Type your new password.
  - **Confirm Password:** Retype your new password.

*NOTE: If you do not wish to set a password, or to change your password, select OK to continue.*



## Emergency User

If an Emergency User has been enabled by the Administrator via Utility--> Admin--> Logon, they need to login as “EUSR.”

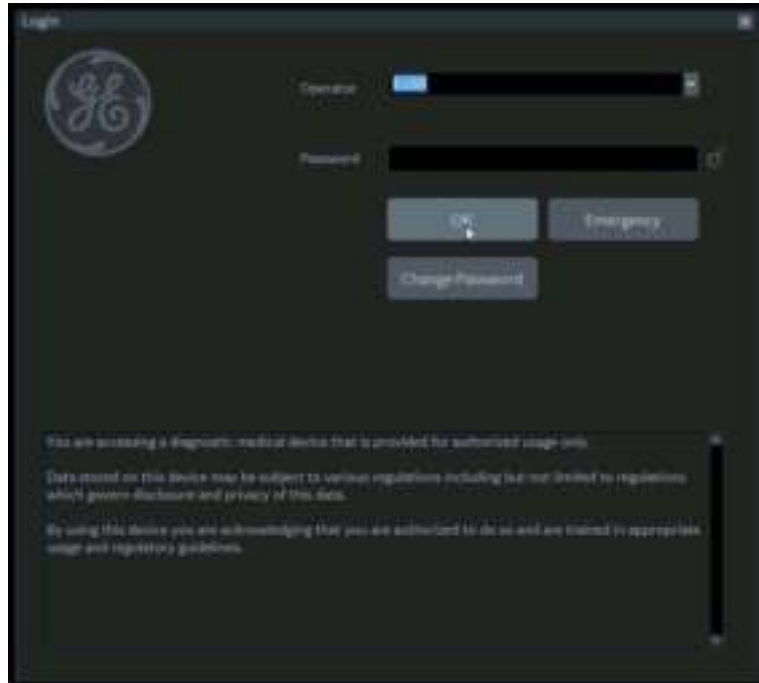

Figure 3-16. Emergency User

User Rights for the Emergency User are set by the Administrator via Utility--> Admin--> Groups. Emergency Users do not have access to your institution’s patient data, as shown in the example below.

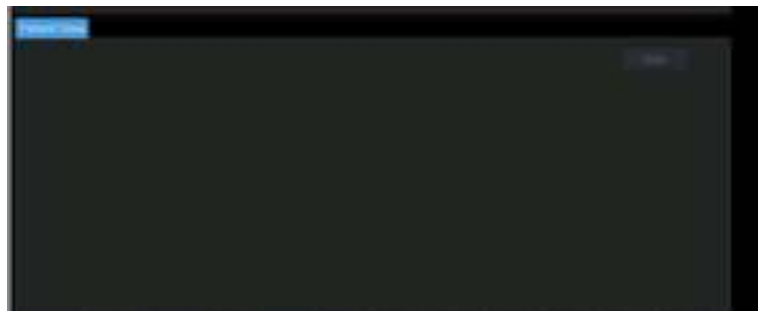

Figure 3-17. Patient Information Not Accessible

## Logoff

To logoff, press the **Power On/Off** switch momentarily and a SYSTEM-EXIT window appears.

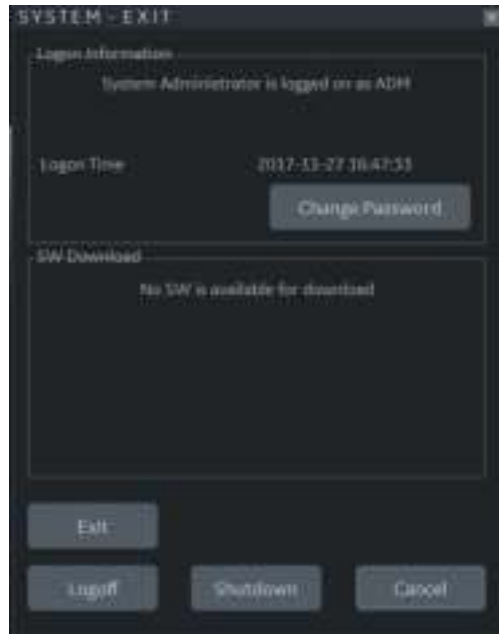

Figure 3-18. System Exit Window

## Power Off

For optimum system operation, we recommend that you restart the system at least once every 24-hour period. If you shut down the system at the end of the day, no other action is needed.



### WARNING

To avoid losing patient data, ensure that you have properly ended the patient's exam and transferred all exam data / images / clips.

To power off the system:

1. Set the brake and use the operator panel movement controls to lock the control panel in place.
2. When you shutdown the system, enter the scan screen and lightly press the **Power On/Off** switch at the front of the system once. The System-Exit window is displayed.

### NOTE:

*DO NOT press and hold down the Power On/Off switch to shutdown the system. Instead, lightly press the Power On/Off switch and select Shutdown.*

## Power Off (continued)

- Using the **Trackball**, select Shutdown.

The shutdown process may take up to two (2) minutes and is completed when the control panel illumination shuts down.

**NOTE:** *If a system shutdown is initiated while the system is still processing an incoming or outgoing DICOM job, a dialog box appears, notifying the user to confirm shutdown, check the spooler status or cancel the shutdown (see Figure 3-19).*

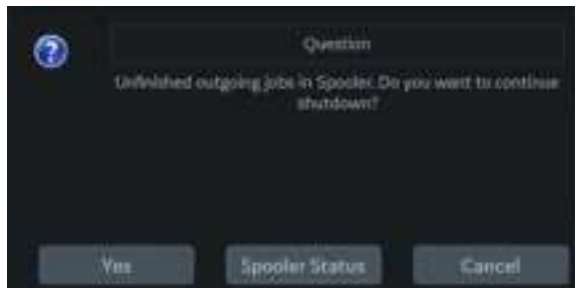

Figure 3-19. Confirm Shutdown

- Disconnect the probes.

Clean or disinfect all probes as necessary. Store them in their shipping cases or another appropriate probe storage system to avoid damage.



### WARNING

**DO NOT** turn off the circuit breaker before the Power On/Off switch LED is white.

Data may be lost or system software damaged if the circuit breaker is turned off before the Power On LED is white.

**NOTE:** *When the Power Assistant is installed, Power Assistant battery replacement may be necessary if the circuit breaker is turned off for long periods of time (3 to 6 months).*

### **Crash Recovery Instructions**

In case of a system crash, power cycle the system. Upon boot-up, all images and measurements, except for generic worksheets, are preserved in the system. When the system returns, the system alerts you that unsaved images are still in the system from the previous patient. Respond to the prompt to continue the current patient. Check that all images and measurements have been preserved in the system. Then resume the exam.

If the system fails to respond to your commands within a typical period of time, you need to manually reset the system. Simply hold down the power switch to initiate a normal power down sequence. After the system has completely shut down (power switch white), restart the system using the standard power-up sequence. All images and measurements, except for generic worksheets, are preserved in the system. When the system has fully powered up, the system alerts you that unsaved images are still in the system from the previous patient. Respond to the prompt to continue the current patient. Check that all images and measurements have been preserved in the system. If you do not have any images on the clipboard, the patient must be retrieved from the database. Then resume the exam.

# System Language Configuration

## Select the System Language and Date/Time Format

The default operating system language and keyboard may be changed from the Utility > System > General page.



Figure 3-20. Utility System General Screen

1. Select the desired system language from the **Language** dropdown menu (1). Then select **Save** at the bottom left of the screen. Do NOT restart yet.
2. Select **Regional Options** (2) to open the Regional Options Dialogue Box

## Select the System Language and Date/Time Format (continued)



Figure 3-21. Regional Options Dialogue Box

3. Select the following Regional Options:
  - **Current OS Language** - Select the language from the dropdown menu (3) to match the system language selected in Step 1.
  - **Keyboard** - Select the keyboard language preference from the dropdown menu (4).
  - **Current Format** - Select the date and time format preference from the dropdown menu (5).
4. After making changes to the Regional Options, select **OK**; when prompted to restart, choose **OK** again to restart system.

**NOTE:** *For the United Kingdom, it is recommended to use ENG Language (1), English (United States) OS Language (3), and modify "Current Format" time/date settings to English (United Kingdom) (4) (see Figure 3-21 on page 3-41).*

### Change the Keyboard Language (Temporary)

To temporarily change the keyboard language, press the left Alt+Shift keys on the keyboard to toggle through all available keyboard languages until you reach the desired language.

**NOTE:** *When the system is restarted, the keyboard language will return to the keyboard language last set in Regional Options.*

### **English (International) Keyboard**

When the system language is set to English (United States), pressing the Ctrl+Shift on the keyboard toggles between the English (United States) keyboard and the English (International) keyboard.

### **Apostrophe/Quotation Marks**

To type an apostrophe or quotation marks while using the English (International) keyboard, you must press the space key after the apostrophe or quotation mark to display the character.



## Preset Restore User Interface Corruption

When restoring presets with the user interface in Russian, Greek, Japanese or Simplified Chinese, if the OS Region Language does not match the selected system software application language at the time of the preset restore, the user interface text may appear corrupted.

To prevent the corruption, before restoring presets, confirm that the OS Region language and system software application language match by following the procedure below, 'Match the OS Language with System Software Application Language' on *page 3-43*, referring to Figure 3-22.

If the corruption has already occurred and the text on the screen is not readable, follow the same procedure ('Match the OS Language with System Software Application Language' on *page 3-43*) to correct the settings, referring to Figure 3-23, which shows the location of the Regional Options and Language fields on the corrupted screens.

### Match the OS Language with System Software Application Language

Change the default operating system language on the Utility > System > General page.

1. Select **Regional Options** to open the Regional Options dialogue box (1).
2. Select **Current OS Language** and select the OS language from the dropdown menu to match the system language (2).
3. Select **OK** (3). The system will restart.

Match the OS Language with System Software Application Language (continued)



Figure 3-22. Match OS Language with System Software Application Language (Preventative)

Match the OS Language with System Software Application Language (continued)

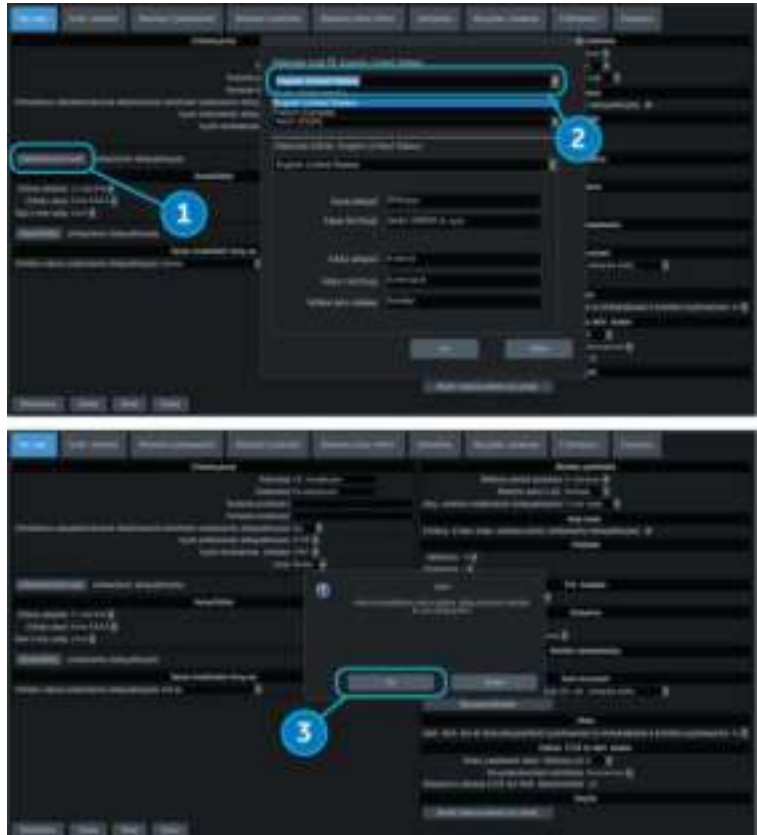

Figure 3-23. Match OS Language with System Software Application Language (Corrective)

# Connecting the Probe

## Connecting the Probe



### DANGER

Fault conditions can result in electric shock hazard to user/patient. Do not touch the surface of probe connectors which are exposed when the probe is removed. Do not touch the patient when connecting or disconnecting a probe.



### CAUTION

Inspect the probe before and after each use for damage or degradation to the housing, strain relief, lens, seal, cable and connector. **DO NOT** use a transducer which appears damaged until functional and safe performance is verified. A thorough inspection should be conducted during the cleaning process.

Probes can be connected at any time, regardless of whether the console is powered on or off. To ensure that the ports are not active, place the system in the image freeze condition.

To connect a probe:

1. Place the probe's carrying case on a stable surface and open the case.
2. Carefully remove the probe and unwrap the probe cord.
3. **DO NOT** allow the probe head to hang free. Impact to the probe head could result in irreparable damage. Use the integrated cable management hook to wrap the cord.

## Connecting the Probe (continued)

4. Prior to inserting the probe, ensure that the connector locking handle is positioned to the left.
5. Align the connector with the probe port and carefully push into place.

**NOTE:** *When connecting the probe, DO NOT turn the locking lever if resistance is felt. If this is the case, remove the probe connector and check for misaligned or damaged pins. Probes with damaged connector pins should be taken out of service immediately.*

6. Turn the connector locking handle to the right to secure the probe connector.
7. Carefully position the probe cord so it is free to move and is not resting on the floor.



Figure 3-24. Probe port

1. Active probe port
2. Pencil probe port

## Unpacking



### CAUTION

If the packaging has been

- Damaged.
- Unintentionally opened before use.
- Exposed to environmental conditions outside of those specified.

Contact your GE HealthCare representative

### **Chirping noise**

- Probes may generate slight audible noise emissions when operated in volume mode
- The repetitive transmission of ultrasound-pulses can generate audible high frequency sounds in the transducer. The frequency and loudness of these sounds (chirping sound) varies with operating mode and U/S image penetration. This sound is due to normal operation and does not indicate degradation of probe safety, performance, or reliability.

### **Cable Handling**

Take the following precautions with probe cables:

- Keep free from wheels. Use the cable hooks located below the operator panel.
- Do not bend the cable acutely
- Avoid crossing cables between probes.

## Selecting probes

To activate the probe, select the appropriate probe from the probe indicators on the Touch Panel.

1. Select the probe that provides optimum focal depths and penetration for the patient size and exam.
2. Select the exam application.
3. Select the application preset.
4. Begin the scan session using the default Power Output setting for the probe and exam.



Figure 3-25. Probe Application/Presets Touch Panel

The probe's default settings for the mode and selected exam are used automatically.

**NOTE:** *Selecting a new probe unfreezes the image.*

### Deactivating the Probe

When deactivating the probe, the probe is automatically placed in freeze mode.

To deactivate a probe:

1. Ensure the selected probe is deselected or the LOGIQ Totus is in freeze mode. If necessary, press the **Freeze** key.
2. Gently wipe the excess gel from the face of the probe.
3. Carefully slide the probe around the right side of the keyboard, toward the probe holder. Ensure that the probe is placed gently in the probe holder.

### Disconnecting the Probe



#### CAUTION

DO NOT allow the probe head to hang free. Impact to the probe head could result in irreparable damage. Use the integrated cable management hook to wrap the cord.

Probes can be disconnected at any time. However, the probe should not be active when disconnecting the probe.

1. Ensure the probe is deactivated. Deactivate by selecting another probe or pressing Freeze.
2. Move the probe locking handle to the left.
3. Pull the probe connector straight out of the probe port carefully.
4. Carefully slide the probe and connector away from the probe port and around the right side of the keyboard.
5. Ensure the cable is free.
6. Be sure that the probe head is clean before placing the probe in its storage box or wall hanging unit.



## Storing the Probe

It is recommended that all probes be stored in the provided carrying case or in the wall rack designed for probe storage.

Carrying case:

- First place the probe connector into the carrying case.
- Carefully wind the cable into the carrying case.
- Carefully place the probe head into the carrying case. **DO NOT** use excessive force or impact the probe head.

## Storage/Transportation



**DANGER**

Placing a dirty or contaminated probe in a carrying case or shipping carton will contaminate the foam insert. Failure to follow proper cleaning guidelines could lead to patient exposure to contaminant.

Each probe should be supported in its own probe holder on the console. If a carrying case is provided with the probe, always use the carrying case to transport the probe from one site to another.

Secure the probe in its holder for moving short distances.

When transporting a probe a long distance, store it in its carrying case.

If possible, use a rigid container with a lid that secures the probe's connector in place so as not to damage the probe head or lens. Place a soft cloth in the bottom of the container to prevent movement during transport.

# Operator Controls

## Control Panel Map

Controls are grouped together by function for ease of use.



Figure 3-26. Control Panel

- |   |   |
|---|---|
| 1. Probe Holder and Cable Management                | 7. Trackball, Trackball keys, Pointer, Measure, Comment, Body pattern, Clear, Zoom, Programmable keys |
| 2. Touch Panel                                      | 8. L/R, Start/Stop, Freeze keys   |
| 3. Joystick controls                                | 9. Steer/Width/Depth/Reverse joystick   |
| 4. On screen keyboard (not display in this graphic) | 10. Auto, CF/PW auto positioning  |
| 5. User defined keys                                | 11. P1, P2  |
| 6. Mode/Gain/XYZ (3D) controls                      |   |

## Control panel adjustment



**CAUTION**

To avoid injury or damage, make sure nothing is within the range of motion before moving the control panel. This includes both objects and people.

Ensure that the hands of the patient are away from the Control panel arm when moving the Control panel.



**CAUTION**

To avoid injury or damage while moving or adjusting other equipment, ensure that no parts of the LOGIQ Totus (such as the control panel or monitor) are within the range of motion of the other equipment

### To raise/lower the control panel

1. Hold the front handle in two hands.
2. Push and hold down the Up/Down button next to the right front handle.
3. Raise or lower the control panel.
4. Release the Up/Down button at the desired height.



Figure 3-27. Up/Down control button

**To swivel the control panel**

1. Hold the front handle in two hands.
2. Push and hold down the swivel button next to the left front handle.
3. Move the control panel to the left or the right.
4. Release the swivel button at the desired position.



Figure 3-28. Swivel control button

## Keyboard

### On Screen Keyboard

You can use "On Screen Keyboard" on touchscreen. Keyboard will show up when you press "Keyboard" User Defined key. And you can hide it with "Exit" button on Keyboard or Keyboard UD key.



Figure 3-29. On Screen Keyboard

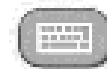

Figure 3-30. Keyboard User Defined key

### **Physical A/N keyboard (Option)**

Physical A/N keyboard is under the control panel.



Figure 3-31. Physical A/N keyboard

Push the keyboard to project forward.



Figure 3-32. Push the keyboard

## Functional keys

The standard alpha-numeric keyboard has some special functions.

Table 3-11: Special key function

Keyboard key	Function
Esc	Exit current display screen.
F1	Help Access Online help/user manual.
F2	Arrow Annotation Arrow.
F3	Eject Eject media.
F4	Spooler Activates DICOM Job Spooler screen.
F5	Creates a Fast Key.
F6	Plays a Fast Key.
F7	Home/Set Home Move annotation cursor to home position; shift+key to set current annotation cursor position as the new home position.
F8	Text1/Text2 Switch between user text annotation overlays.
F9	Grab Last Activate the last selected data for edit.
F10	Word delete Erase word associated with comment cursor.

If you encounter a problem and cannot collect the logs immediately:

Table 3-12: Key for collecting the log

Keyboard key	Function
Alt+1 or Alt+2	Place a marker in the log.
Alt+D	Collect the logs.

Once the logs are collected, the engineering team would be able to see the marker you added which will help engineering to troubleshoot the problem.

## Touch Panel

The Touch Panel contains exam function and mode/function specific controls.

### Exam Function Controls

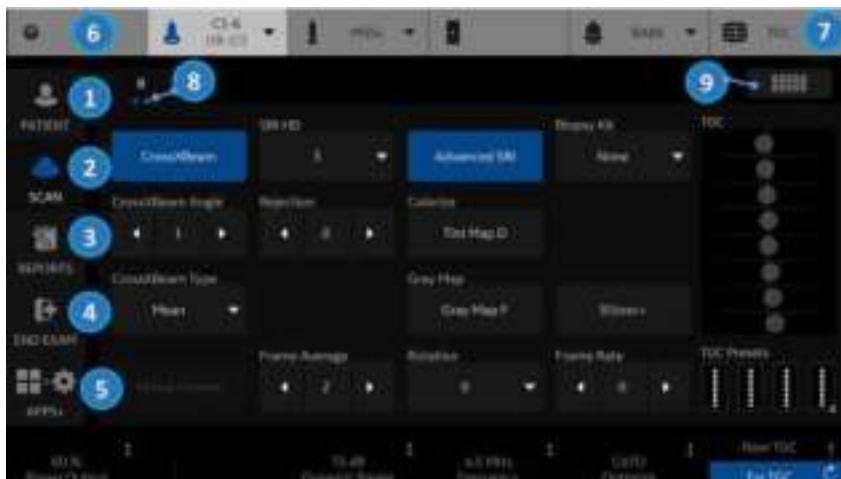

Figure 3-33. Exam Function Controls

- |   |  |
|---|--|
| 1. Patient: Enters Patient screen   | 6. Probe Indicator: Indicates and selects the probes.  |
| 2. Scan: Enters scanning mode screen  | 7. TGC Control: Activates TGC function.  |
| 3. Reports: Activates default report and Touch Panel of report choices.           | 8. Indicates the number of pages for this mode. To move to the next page, touch the “dot” or swish your hand from right to left/left to right. |
| 4. End Exam: Activates Image Management and Touch Panel with end of exam options. | 9. To view all/fewer of the controls for this Touch Panel, press this Research/Clinical button.  |
| 5. APPS+: Activates Apps and Utility.   |  |

**NOTE:** *Different menus are displayed depending on which Touch Panel Tab is selected.*

At the bottom of the Touch Panel, there are six combination rotary dials/push buttons. The functionality of these rotaries changes, depending upon the currently-displayed menu. Press the button to switch between controls, or rotate the dial to adjust the value, or move the control left/right or up/down to adjust the value.



## Mode/Function Specific Controls

In general, the key name is indicated at the top of the key. There are different types of Touch Panel keys as illustrated below:



Figure 3-34. Mode/Function Specific Controls

1. Press to toggle control on/off.
2. Progress/Select keys are used for controls that have three or more choices.
3. Progression keys are used to assess the impact of the control on the image progressively.
4. 3-way functionality knobs (below the Touch Panel): Adjust controls by pressing (dot symbol), rotate (circled arrow symbol), move up/down (vertical line with arrows) or left/right (horizontal line with arrows).

### Mode, Display and Print

This group of controls provides various functions relating to the display mode, display orientation, image recording/saving, freeze, gain and Cine scroll.

The Mode Controls select the desired display mode or combinations of display modes.

- During dual display modes the **L** and **R** keys activate the Left or Right displayed image. See 'Split Screen' on *page 6-18 for more information*.
- Auto is used to:
  - initiate auto optimize.
  - turn off auto optimize.
- Depth controls the image display depth.
- The Reverse key (via Depth key if preset) toggles the left/right orientation of the scan image.
- Print keys are used to activate/print the designated recording device.
- The Freeze key is used to stop the acquisition of ultrasound data and freeze the image in system memory. Pressing **Freeze** a second time continues live image data acquisition.
- To activate a specific mode, press the appropriate mode key.

Each mode has its own gain control via the larger gray knob surrounding the mode key.

## Measurement and Annotation

This group of controls performs various functions related to making measurements, annotating and adjusting the image information.

- The Comment key enables the image text editor and displays the annotation library Touch Panel.
- The Clear key is generally used to erase functions, such as annotations/comments, body patterns and measurements. Pressing the Clear key again exits the selected function.
- The Body Pattern/Ellipse control has a dual purpose:
  - Press the Body Pattern/Ellipse control, it enables the Body Pattern Touch Panel and displays the default pattern on the screen. When body patterns are active, the knob rotates the probe position indicator.
  - Rotate the Body Pattern/Ellipse control, it activates the ellipse measurement function after the first distance measurement has been set and the second caliper is activated.

Press Set to fix the measurement after the ellipse adjustment is complete. The measurement is then displayed in the measurement result window.

- The Measure key is used in all types of basic measurements. When the Measure key is pressed, the measurement Touch Panel is displayed.
- The Set key, located on the Trackball on-screen controls, is used for various functions, but is generally used to fix or finish an operation (e.g. to fix a measurement caliper).
- The Trackball is used with almost every key function in this group. Trackball control depends on the last key function pressed.

# Monitor

## Adjusting the Monitor Position



CAUTION

**DO NOT** apply force to the monitor surface by finger or other hard object.

The monitor surface may be damaged and permanently discolored.

- LCD Monitor



- HDU Monitor



## Adjusting the Monitor Position (continued)



### CAUTION

If any defects or damages are observed on the display screen or monitor itself, do not operate the equipment but inform a qualified service person.

Contact a Service Representative for information.

Grab the frame of the monitor with both hands when you adjust the position of the monitor and monitor arm.

Table 3-13: How to grab (LCD Display)

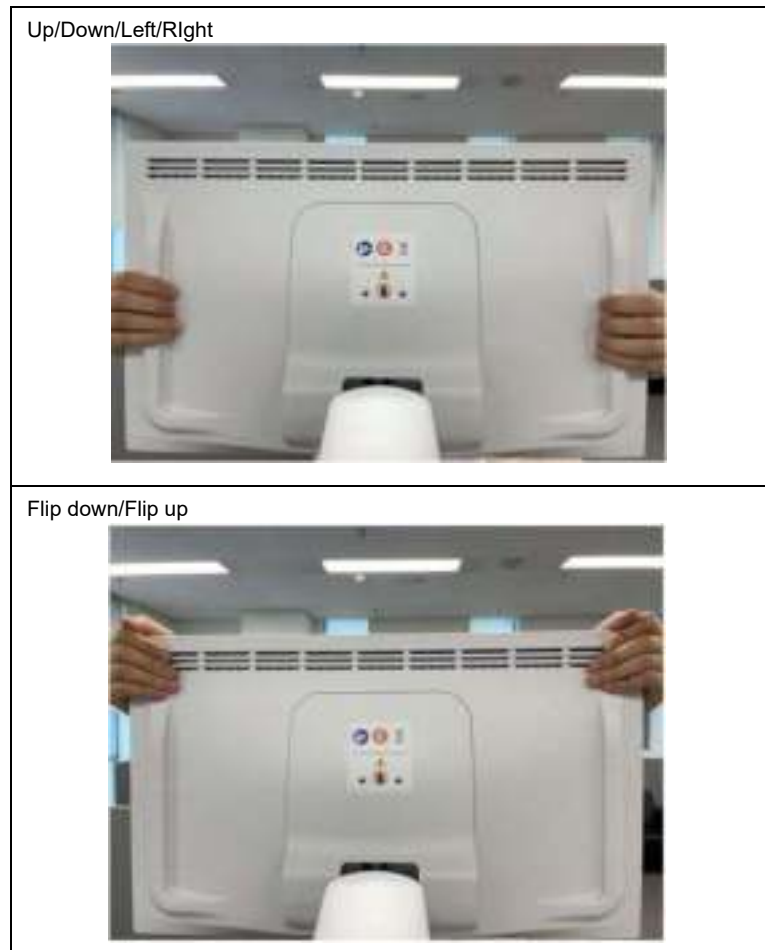

## **Adjusting the Monitor Position (continued)**

Table 3-14: How to grab (HDU Display)

Up/Down/Left/Right



Flip down/Flip up



## Locking/unlocking the Monitor

1. Turn the release knob clockwise to unlock the monitor. The monitor can be moved freely in all directions (Figure 3-35 1).
2. Turn the release knob clockwise to raise the lock and move the monitor into the parked position, then turn the lock counterclockwise to lock. (Figure 3-35 2).



Figure 3-35. Unlock/Lock the monitor arm

1. Unlocked
2. Locked

## Adjusting the Monitor

You make adjustments to all monitors via the second Utility Menu page. To view the monitor while making these adjustments

1. Press Utility--> select the second page.
2. Press **Scan Screen**. The scan screen displays on the main display while the Utility Touch Panel is active so you can see the affect your adjustments are making to the monitor.

Table 3-15: Monitor Adjustments

Monitor Adjustments	Parameters	Affect on the Monitor
<b>Room Profile:</b> Monitor luminance varies, depending on the room's profile (light, dark, semi-dark). Adjusting this control helps to adapt the monitor to different room lighting conditions.	Set the Room Profile to match the room:	Brightness/Contrast Equivalent:
	LCD display	
	Dark	50/85
	Semi-Dark	70/85
	Light	90/85
	HDU display	
	Dark	50/40
	Semi-Dark	50/65
	Light	50/100
	User Defined	If you select User Defined, adjust the Brightness/Contrast control at the bottom of the Touch Panel.
Note: Brightness/Contrast setting is changeable when the Room Profile setting is available and set to "User Defined".		
<b>Color Profile:</b> Color Profile controls color temperature, or overall tint of the monitor.	0	6500K
	1	9000K (LCD display) / 9300K (HDU display)
	2	11000K
	3	13000K



Table 3-15: Monitor Adjustments (Continued)

Monitor Adjustments	Parameters	Affect on the Monitor
Gamma Setting: With Grayscale Standard Display Function (GSDF) enabled, the gamma button on the Touch Panel affects the image, emulating the appearance of that gamma. The system gamma is adjusted to match the GSDF gamma compensation to the new monitor gamma.	Set the Gamma to 2.2 or 2.4	Note: With GSDF disabled, the monitor still uses a gamma curve that may be selected on the Touch Panel (for backwards compatibility with sites that are happy with their PACS or may have a mix of older systems).
Return to Default settings.	Press "Reset Monitor", then restart the system.	

## Wide Screen Monitor Display Settings

Further clarification on three settings on the Utility--> System--> System Display configuration page is provided below:

- Image Size (Default, Large)
- Image Display Area (Default, Large, Extra Large)
- Use Wide Screen For... (On, Off, Auto)

Table 3-16: Wide Screen Monitor Display Settings

Preset Setting	Description	Choices
<b>Image Size:</b>	The parameter "Image Size" changes the size of the ultrasound image without changing the screen image, which includes the title bar and the image parameter window. It also does not change the size of comments, measurement cursors and lines, or the measurement result box. With all other settings the same, increasing Image Size from Default to Large creates a larger ultrasound image both on the LOGIQ Totus display and on PACS' displays. It will not affect the appearance of screen image items like the title bar and the image parameter window.	<ul style="list-style-type: none"> <li>• Default</li> <li>• Large</li> </ul>



Image Size = Default (Left) and Image Size = Large (Right)

Hint: If you select and save "Last Used" on this page, the system starts with last used Room Profile setting every time.

Table 3-16: Wide Screen Monitor Display Settings (Continued)

Preset Setting	Description	Choices
Image Display Area	<p>“Image Display Area” changes the size of the screen image.</p> <p>On the LOGIQ Totus display, this parameter changes the size of the ultrasound image. It also changes the arrangement of the items like the title bar and image parameter window, but not their individual size. Comments, measurement cursors and lines, and the measurement result box also do not change.</p> <p>This parameter also changes the pixel count of the image. Many PACS software packages scale all images of the same aspect ratio to the same viewing size, regardless of their pixel count. Because the ultrasound image displayed is enlarged as the pixel count is increased, the PACS display size of the ultrasound image does not change. However, items like the title bar, image parameter window, comments, and measurements do not get larger as the pixel count is increased, so they appear smaller on PACS. If text appears too small on PACS, change the Image Display Area to Default (decreasing the screen image pixel count).</p>	<ul style="list-style-type: none"> <li>• Default</li> <li>• Large</li> <li>• Extra Large</li> </ul>



Ultrasound System Image Display Area: Left = Default, Right = Large



PACS Image Display Area: Left = Default, Right = Large

Table 3-16: Wide Screen Monitor Display Settings (Continued)

Preset Setting	Description	Choices
Use Wide Screen For...	<p>“Use Wide Screen for...” determines when the system will use a wide screen aspect ratio (16:9) as opposed to a “standard” aspect ratio (4:3). If “Single Image” under this heading is set to On, then the 16:9 aspect ratio is always used.</p> <p>A third aspect ratio is used if Extra Large is selected under Image Display Area. In this case the Wide Screen display options are not used and a 16:10 aspect ratio is used for all images. The 16:10 aspect ratio will be only modestly different than the 16:9 aspect ratio.</p> <p>Note: PACS display the top and bottom of the image as black bars, just like watching a wide-format movie on a non-wide screen TV.</p>	<ul style="list-style-type: none"> <li>• On</li> <li>• Off</li> <li>• Auto</li> </ul>



Ultrasound System Left&Right: Image Size=Large, Image Display Area=Default; Right: Wide Screen=On



PACS Left&Right: Image Size=Large, Image Display Area=Default; Right: Wide Screen=On

## Image Display Area Preset Setting Notes

The following table shows pixel counts (columns × rows) for saved images for all combinations of Image Display Area and Wide Screen on/off.

Table 3-17: Wide Screen Single Image and CINE Clip Pixel Count

Image Display Area Setting	Single Image	Single Image	CINE Clip*		Stress Clip
	On	Off	On*	Off*	
Default	1456 x 819	1092 x 819	1346 x 748	982 x 748	1092 x 819
Large	1552 x 873	1164 x 873	1442 x 802	1054 x 802	1164 x 873
Extra Large	1552 x 970	1552 x 970	1442 x 899	1442 x 899	1552 x 970

\*Under CINE Clip, "On" and "Off" mean Wide Screen Single Image On/Off, **NOT** CINE Clip On/Off.

**NOTE:** Note the different pixel counts for single frames and cine clips. This is because saved cine clips cut off the title bar and image parameter window.

## Use Wide Screen For... Preset Setting Notes

The following table shows the aspect ratio for saved images for all combinations of Image Display Area and Wide Screen on/off. For comparison, it also includes data for the image display on 19" monitors. For CINE clips, the aspect ratios will not be exactly the same as for single frames, but they will be very close.

Table 3-18: Wide Screen Aspect Ratio, Single Image

Image Display Area Setting	On	Off
Default	16:9	4:3
Large	16:9	4:3
Extra Large	16:10	16:10

## Test Patterns

The LOGIQ Totus monitors follow the DICOM Gray Scale Display Function (GSDF) standard\* which uses a GSDF curve to evaluate the health and effectiveness of the monitor. The GSDF standard is what is commonly used for calibrating PACS' monitors. This setting may help to make the image appearance more uniform between the LOGIQ Totus and PACS.

**NOTE:** *The monitor is GSDF-compliant with all contrast settings, but not all brightness settings.*

There is a GSDF on/off switch, "Enable DICOM grayscale display mode (GSDF)" via the Utility--> System--> System Display page that allows you to adjust the monitor you are using to the PACS.

Table 3-19: Test Patterns







Test Pattern	Description	Screen Example
Gray Bars	Confirm that you can clearly see all of the different gradations of the grayscale in each gray cell.	
Color Bars	Confirm that you can clearly see all of the different colors in each colored cell.	
Resolution	Confirm that this image is clear and crisp, without jagged edges or lines.	

Table 3-19: Test Patterns (Continued)

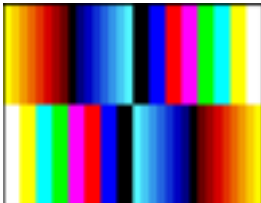
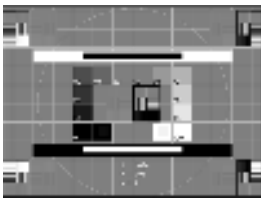
Test Pattern	Description	Screen Example
Brightness Contrast	Before making any adjustments, record the settings for contrast and brightness. In a dimly lit room, adjust the monitor to Brightness 50 & Contrast 40. Increase the contrast until the left most block in the second row from the bottom is just visible. All the remaining blocks in the last 2 rows of the image should now be visible. Reset the contrast and brightness to the recorded levels.	
LN1 to LN18	Luminance for different grayscale levels. Usually, the facility's Biomed Engineer tests each gray level map on the monitor from LN-1 to LN-18 with a light meter and then graphs these on a scale to ensure that the curve falls within the GSDF's standard. Generally, this is performed yearly.	<p data-bbox="920 535 974 557">LN-1</p>  <p data-bbox="920 773 987 795">LN-18</p> 
QC	Quality Control. Confirm that this image is clear and crisp, without jagged edges or lines.	
CT	Contrast. Confirm that you can you detect the circles within the square grayscale boxes.	
<p data-bbox="158 1487 1170 1614">**Assessment of Display Performance for Medical Imaging Systems." Report of the American Association of Physicists in Medicine (AAPM) Task Group 18, Medical Physics Publishing, Madison, WI, AAPM On-Line Report No. 03, April 2005, Samei E, Badano A, Chakraborty D, Compton K, Cornelius C, Corrigan K, Flynn MJ, Hemminger B, Hangiandreou N, Johnson J, Moxley M, Pavlicek W, Roehrig H, Rutz L, Shepard J, Uzenoff R, Wang J, Willis C.</p> <p data-bbox="158 1620 821 1643">*Also see <a href="https://www.aapm.org/pubs/reports/OR_03.pdf">https://www.aapm.org/pubs/reports/OR_03.pdf</a>, section 4.3.</p>		

# Monitor Display

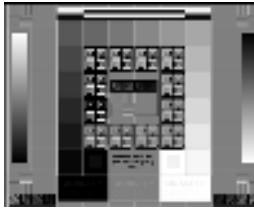
## Monitor Display



Figure 3-36. Monitor Display Tour



## Monitor Display (continued)





1. System Date and Time (Note: The date on the monitor may truncate the century when using the YYYY-MM-DD date format.)
2. Caps Lock
3. Network Connection Indicators (Wireless LAN, Wired, Mobile Bluetooth), Battery Status
4. DVR Status
5. InSite Indicator
6. Image Clipboard
7. Image Preview
8. Worksheet/Direct Report
9. Gray/Color Bar
10. Institution/Hospital Name, Date, Time
11. Operator Identification, Patient Name
12. Probe Orientation Marker
13. Measurement Calipers and System Message Bar
14. Color Window
15. Power Output Readout
16. Probe Identifier, Exam Preset
17. Live/Freeze Indicator
18. Imaging Parameters by Mode, Speed of Sound (SoS) Indicator (if applicable)
19. Focus Indicator and Color Flow Focal Zone Marker
20. Depth Scale
21. Image Management Icons and LOGIQ Apps Icon (not shown)
22. Body Pattern
23. CINE Gauge
24. Trackball Controls and Status

### Live/Freeze Indicator

Live/Freeze Indicator shows active image scan status with Single/Dual/Quad format and has four choices (Live/Not Live/Update/B Pause).

Live/Freeze Indicator display (on/off) is configurable on Utility -> System -> System Display menu.

Table 3-20: Live/Freeze Indicator

Live		Update	
Not Live		B Pause	

## Monitor Display Layout

Monitor Display Layout is configurable on Utility -> System -> System Display menu.

See 'System/System Display Preset Menu' on *page 10-12 for more information.*

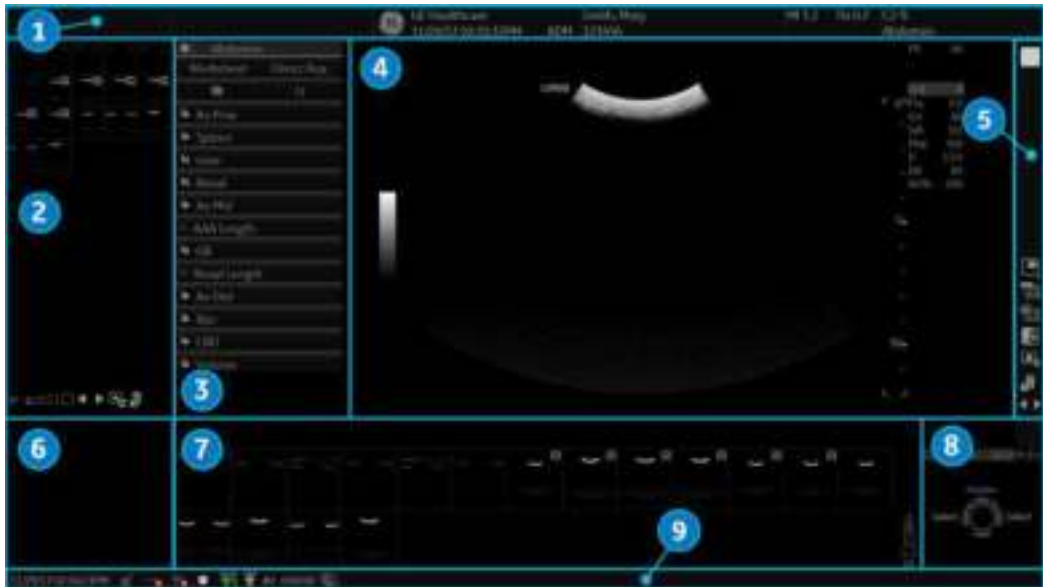

Figure 3-37. Default Image Format (4:3)

1. Title bar
2. Information window 1
3. Information window 2
4. Scan Area
5. Control Window
6. Preview window/User Label
7. Clipboard
8. Trackball mapping and Set keys
9. Status area

## Information Window

Measurement Summary, Side Clipboard, Scan Assistant Guide, and My Desktop are displayed options for Info1 or Info2 window.



Figure 3-38. Information Window - Example

1. Measurement Summary
2. Side Clipboard
3. Scan Assistant Guide
4. My Desktop

## My Desktop

The user can import graphics (jpeg) and write a caption for that graphic to display on My Desktop in Utility -> User Specific.

Table 3-21: User Specific

Preset Parameter	Description
My Desktop Title	Free text
Picture 1 and 2	Browse to load jpeg and type the caption.
Background Color	Select Color: Select the background color. Default Color: Reset the background color to factory default.
Import	Import the graphic.

## User Label

In Utility -> Application -> Settings -> Label Area, you can enter User Label which displays in the Preview Window as a brief note.

For example, P1 - Stills only, P2 - Stills, Clips (3 sec.), P3 - Volume, P4 Screen Capture.



Figure 3-39. Application Settings Preset Menu

Table 3-22: Label Area

Preset Parameter	Description
Show labels	If selected, the system displays the User Label in the Preview Window at the left-bottom of the monitor.
Label 1 - 8	User labels have eight text lines. Each User Label is limited to 50 characters.

**Change the Display Image Area**

You can change the screen format layout by pressing the lower, right-hand corner of the Display Image Area icon on the display:

Table 3-23: Display Image Area Selections

<p>Display Image Area icons</p> 	<p>Click Image Display Area icon to toggle current display area and extra large area.</p> <p>Default Layout</p> <ul style="list-style-type: none"> <li>• (4:3 Layout) Standard</li> <li>• (16:9 Layout) Full Wide</li> </ul> <p>Large Image Layout</p> <ul style="list-style-type: none"> <li>• (4:3 Layout) Standard</li> <li>• (16:9 Layout) Full Wide</li> </ul> <p>Extra Large Layout</p> <ul style="list-style-type: none"> <li>• (16:10 Layout) Partial Wide</li> </ul>
---	---

Table 3-24: Display Image Area Examples



<p>Default Layout Standard</p>	
<p>Default Layout Full Wide</p>	

Table 3-24: Display Image Area Examples (Continued)

Large Image Layout Standard	
Large Image Layout Full Wide	
Extra Large Layout Partial Wide	

**NOTE:** *Even If there are buttons on the rear cover of the monitor, DO NOT use those buttons for adjustment. The LOGIQ Totus system will override the parameter(s) and the monitor does not have capability to retain parameters.*

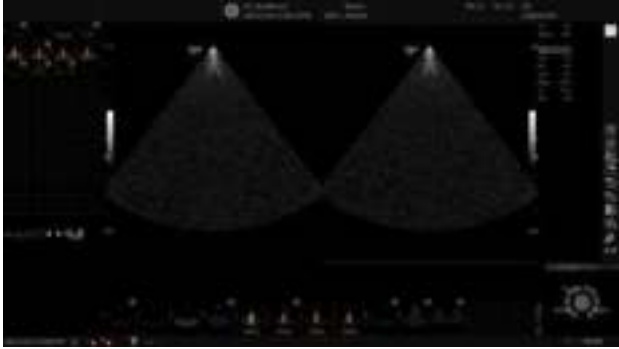
## Using the Monitor Display Controls to Manage Images

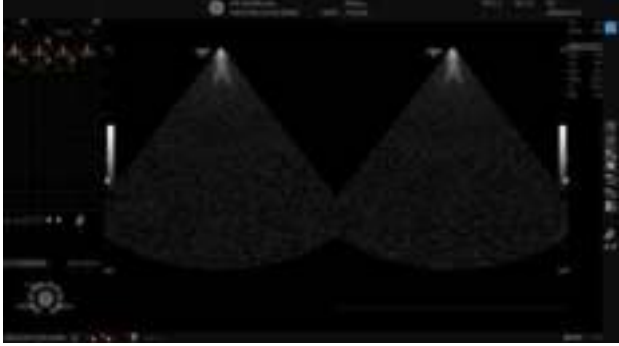
### Image Management Icons

You can manage images from the display via these on-display controls.

Table 3-25: Image Management Icons

	<p><b>Image Display Area</b>            Press Image Display Area to select Image Display Area - Default/Large/Extra large. See 'Change the Display Image Area' on page 3-79 for more information.</p>
	<p><b>Worksheet</b>            Activate the Worksheet.</p>
	<p><b>Active Images</b>            Press Active Images to go to the Patient Active Images page.</p>
	<p><b>Compare Assistant</b>            Press to activate Compare Assistant.</p>
	<p><b>Activate Save As Menu - Note:</b> Save As Menu icon is displayed only when an image is recalled or scan state is frozen/CINE Loop.</p>
	<p><b>Delete Recalled Image/Delete Last Image -</b> Delete Recalled Image is displayed only when one image is recalled. / Delete last image icon is displayed only when the image is not recalled and there are non-stored images. You can use this to delete an image from the clipboard. Place the cursor on the clipboard image you want to delete, then press <b>Set</b> to select the image. Then place the cursor on the Delete icon and press <b>Set</b>.</p>
	<p><b>Next/Previous Image(s) and Clipboard Slide Show</b>            Press the left arrow to move to the previous image; press the right arrow to move to the next image.  <b>Clipboard Slide Show</b>            The Clipboard Slide Show plays all images on the clipboard and wraps around the ends. To activate, press and hold [Ctrl] + [Previous Arrow] or [Ctrl] + [Next Arrow].</p> <ul style="list-style-type: none"> <li>• Each image recalls for three seconds, or the length of the loop, whichever is longer.</li> <li>• You can manually skip to a new image during the slide show by recalling it, as usual.</li> <li>• To end the slide show manually, press [Ctrl] + [Previous]/[Next] again.</li> <li>• Slide Show ends when you go to live scanning, or if the clipboard is not shown when it's time for the next image to load.</li> </ul>

# System Positioning/Transporting

## Moving the System

When moving or transporting the system, follow the precautions below to ensure the maximum safety for personnel, the system, and other equipment.



CAUTION

This equipment is not to be used during transportation (e.g. ambulance cars, aircraft).



CAUTION

Handle carefully. A drop of more than 5 cm can cause mechanical damages.



Moving  
Hazard

Never move the system with locked wheels.



## Before moving the system

1. Press the **Power On/Off** switch to power off the system. See 'Power Off' on page 3-37 for more information.
2. Unplug the power cord.
3. Wind the power cable around the neck of rear handle.



**DANGER**

**LOOSELY** (not twisting tightly) wrap the Power Cord around the neck of rear handle. Occasionally wrap the Power Cord around the neck of rear handle in the opposite direction.

**NEVER** allow the Power Cord to drag on the floor.

**NEVER** roll over the Power Cord with the wheels.

Failure to follow these instructions could lead to exposure to electrical shock.

4. All cables from off-board peripheral devices (external Color Digital/Report printer, etc.) and the ethernet connection must be disconnected from the console.
5. Ensure that no loose items are left on the console.
6. Connect all probes to be used while off site. Ensure that probe cables are out of the way from the wheels and not protruding beyond the console. Use the probe management hooks located below the Operator Panel to further secure the probe cables

**NOTE:** *If more than four (4) probes are intended to be used, store the additional probes securely.*

7. Store all other probes in their original cases or in soft cloth or foam to prevent damage. In addition, on-board storage bins are available as a system option.

### Before moving the system (continued)

8. Store sufficient gel and other essential accessories in the provided space.
9. Adjust the monitor and control panel to their lowest positions by using the up/down switch on the front of the operator panel. Make sure the operator panel is locked in place.



#### CAUTION

To prevent system damage while not in use AND/OR before moving the system, flip down the monitor and lock the monitor arm and operator panel firmly in place.



Figure 3-40. Flip down the monitor and lock the monitor arm

10. Unlock the wheels.

## When moving the system



### CAUTION

1. Always use the rear handle grips to move the system.
- **DO NOT** attempt to move the console using any cables or fixtures, such as the probe connectors.
- **DO NOT** attempt to move the system with the monitor by pulling cables or belts placed around the monitor and/or monitor arm.
- **DO NOT** restrain the LOGIQ Totus at the monitor or the monitor neck using a belt. Always secure the monitor at the body part of the console.
2. Take extra care when moving the system long distances and on inclines. Ask for help if necessary.  
Avoid ramps that are steeper than ten degrees to avoid tipping over the system. Utilize additional care and personnel when moving on a steep incline (>5 degrees) or loading the system into a vehicle for transport.

### NOTE:

*Wheel chair ramps are usually less than five degrees.*

3. Use the foot brake (pedal), located on the bottom of the system in the front, when necessary.
4. Do not let the system strike walls or door frames.
5. Use extra care when crossing door or elevator thresholds.
6. Once the destination is reached, lock the wheels.



### WARNING

To avoid possible injury and equipment damage:

- Be sure the pathway is clear.
- Limit movement to a slow careful walk.
- Use two or more persons to move the system on inclines or long distances.

Failure to follow instructions could lead to possible injury and/or equipment damage.

## Wheels

Examine the wheels frequently for any obvious defects that could cause them to break or bind. Each wheel has an independent brake pedal. A left rear wheel also has a swivel lock.



Figure 3-41. Brake lock and Swivel lock

1. Brake lock pedal

2. Swivel lock pedal



**CAUTION**

If you park the system on a slippery slope, you **MUST** use the brakes on the wheel.

## Brake pedal



Figure 3-42. Front and Right-rear caster

1. Step on Lower side pedal to activate Brake
2. Step on Upper side pedal to release Brake



Figure 3-43. Left-rear caster

1. Step on to activate Brake
2. Raise up to release Brake

## Swivel lock



Figure 3-44. Rear-left with Swivel lock

1. Step on Lower side pedal to activate Swivel Lock with clicking sound
2. Step on Lower side pedal to de-activate Swivel Lock

**NOTE:** *Wheel needs to be straight when you activate Swivel Lock.*



Figure 3-45. Caster position for Swivel lock

## Transporting the System

Use extra care when transporting the system using vehicles. In addition to the instructions used when moving the system (see 'Before moving the system' on *page 3-83* for more information), also perform the following:

1. Before transporting, place the system in its special storage case.
2. Only use vehicles that are designed for transport of the LOGIQ Totus system.
3. Load and unload the system to a vehicle parked on a level surface.
4. Ensure that the transporting vehicle can handle the weight of the system plus the passengers.
5. Ensure that the load capacity of the lift (a minimum of 85 kg [187 lbs] is recommended) is capable of handling the weight of the system and any other items on the lift at the same time.
6. Ensure that the lift is in good working order.
7. Secure the system while it is on the lift so that it cannot roll. Use either wood chocks, restraining straps, or other similar types of constraints. Do not attempt to hold it in place by hand.

*NOTE: Strap the system below its handle so that the system does not break loose.*

8. Employ two to three persons to load and unload safely from a vehicle.
9. Load the unit aboard the vehicle carefully and over its center of gravity. Keep the unit still and upright.

*NOTE: Do not lay the unit down on its side.*

10. Ensure that the system is firmly secured while inside the vehicle. Any movement, coupled with the weight of the system, could cause it to break loose.
11. Secure system with straps or as directed otherwise to prevent motion during transport.
12. Prevent vibration damage by driving cautiously. Avoid unpaved roads, excessive speeds, and erratic stops or starts.

## Acclimation Time

After being transported, the unit requires one hour for each 2.5 degree increment when its temperature is below 10 degree C or above 40 degree C before powering on.

Table 3-26: System Acclimation Time Chart

<b>Degree C</b>	60	55	50	45	40	35	30	25	20	15	10
<b>Degree F</b>	140	131	122	113	104	95	86	77	68	59	50
<b>hours</b>	8	6	4	2	0	0	0	0	0	0	0
<b>Degree C</b>	5	0	-5	-10	-15	-20	-25	-30	-35	-40	
<b>Degree F</b>	41	32	23	14	5	-4	-13	-22	-31	-40	
<b>hours</b>	2	4	6	8	10	12	14	16	18	20	



---

## Chapter 4

# Preparing for an Exam

*Describes how to begin an exam.*

# Beginning an Exam

## Introduction

Begin an exam by entering new patient information.

The operator should enter as much information as possible, such as:

- Dataflow
- Exam category
- Patient ID
- Patient name
- Exam Information

The patient's name and ID number is retained with each patient's image and transferred with each image during archiving or hard copy printing.

## Patient Screen

Press **Patient** on the Touch Panel to display the Patient Screen on the monitor.

- Enter Patient Data with the alphanumeric keyboard.
- To navigate through the Patient Entry menu, use the **Tab** key or **Trackball** and **Set** to move and fix the cursor.



Figure 4-1. Patient Screen (Example: Category ABD)

Table 4-1: Patient Screen

No.	Function	Description
1.	Image Management	<ul style="list-style-type: none"> <li>• Patient–Provides a search and creation of patient. (currently selected)</li> <li>• Image History–Provides a list of images per exam for the currently selected patient.</li> <li>• Active Images–Provides preview of the currently selected exam and Compare Assistant.</li> <li>• Data Transfer–Provides an interface to handle patient data from a remote device.</li> </ul>

Table 4-1: Patient Screen (Continued)

No.	Function	Description
2.	Function Selection	<ul style="list-style-type: none"> <li>• New Patient–Used to clear patient entry screen in order to input a new patient's data into the database.</li> <li>• Register–Used to enter new patient information into the database prior to the exam. If you are using the auto-generate Patient ID feature, do not select Register. It is always a good practice to Register all patients.</li> <li>• Details–Select the Details box to activate/deactivate the exam details. The Exam Description pull-down selection is used as the DICOM identifier.</li> </ul>
3.	Query This Patient	Allows for One Click Q/R for the current patient.
4.	Logoff	Used to logoff system.
5.	EZBackup	One-step method to backup patient images to an external media.
6.	Dataflow Selection	Select archive and other pre-defined services. If you place the cursor on the icon, the pop-up menu displays disk capacity.
7.	Save and Exit	Used to save all changes and exit the Patient Menu.
8.	Patient Information	<ul style="list-style-type: none"> <li>• Patient ID Number</li> <li>• Alternate (Other, Second) Patient ID Name and Number. The system allows you to enter a second identification number for the same patient, which may be required in certain countries. This is only displayed if enabled on the Connectivity -&gt; Miscellaneous screen.</li> <li>• Patient Name–Last, First and Middle</li> <li>• DOB (Birthdate)</li> <li>• Age (automatically calculated when birthdate is input)</li> <li>• Sex</li> </ul>
9.	Category Selection	Select from 8 exam application categories. When a category is selected, the measurement and category presets are displayed.
10.	Exam Information	Shows the Current/Active Exam information. Information pertinent to the selected exam category appears in the window. All possible information needs to be entered. <ul style="list-style-type: none"> <li>• Images-Displays the selected exam's images in the middle of screen.</li> <li>• Clear–Clears existing data.</li> <li>• Past Exam (only for OB)–Input past exam data (register the patient before using).</li> </ul>
11.	Scan Assistant Program	The Scan Assistant Program is either selected automatically or manually, depending on the preset as configured on the Utility--> System--> General page.
12.	Patient View/Exam View	Display either patient or examination list. Refer to 'Patient View/ Exam View' on <i>page 4-5</i> for details.

Patient View/Exam View



Figure 4-2. Patient View and Exam View

Table 4-2: Patient View/Exam View

No.	Function	Description
1.	Patient View	Lists the patients in the database. When you double-click a patient on the patient list using the <b>Set</b> key, the Review screen or New Exam entry screen displays depending upon how the “Double click on patient list to start” preset is set at Utility -> Connectivity -> Miscellaneous.
2.	Exam View	Displays the list of all the exams for the Current Patient. The system can display the Detail Mode instead of Exam View when you select a patient on the patient list and press Review or Register (to Register, enter a patient ID and select). If the Detail Mode preset on Utility -> Connectivity -> Miscellaneous menu is selected, the Detail Mode displays.
3.	Search	Select a search criteria. Note: Criteria “Img. Archived” means that the exam was backed up to external media by EZBackup or Export.
4.	String	Enter appropriate information for search criteria. Note: If you select Locked (Y, N) or Archived (Y, N) for the Search key, enter Y (Yes) or N (No).
5.	Clear	Clears the entered string.
6.	Hide	Hide the patient view.

Table 4-2: Patient View/Exam View (Continued)

No.	Function	Description
7.	Review	Highlight the patient and press Review. Exam view is displayed. Note: If the selected patient has a Current Exam or the selected exam is the Current Exam, the Review button changes to "Resume Exam" on Patient List.
8.	New Exam	Creates a new exam for the current patient.
9.	Resume Exam	Continues the exam for that patient if you select the last exam of the day.
10.	Delete	Delete one or more patient record from Patient View. Note: "Delete" is only displayed when you login as Administrator.
11.	Detail	The detail information for the selected category displays.
12.	Lock/Unlock	Locks the exam/patient. Prevents move and delete functions. If you select the patient, all exams are locked. If you select one exam, the selected exam is locked and the lock icon displays in the patient ID cell.
13.	Listing xx/xx	Displays the quantity of patients that match the search criteria in the search window or the quantity of patients in the database.
14.	Images	Display images of the selected exam in the middle of the monitor.
15.	Clear Exam	Clear exam (located on the Touch Panel).
16.	Delete Exam	Delete one or more exams from Exam View. Note: "Delete" is only displayed when you login as Administrator.
17.	Disk	Displays the disk name on which you saved the exam's image data. If "+" displays behind the disk name, the data is saved on two or more disks.
18.	Send To	Send the images to the DICOM Device.
19.	Print	Print the search list to a standard printer. Highlight the patient and press left Set key. Select Print from the pop-up and press the right Set key.



**NOTE:** Refer to 'Change Patient ID of the existing patient (Edit & Copy)' on page 4-18 for more information about Edit&Copy and Anonymize.

## **OB Exam**

### **Exam Preparation**

Prior to an ultrasound examination, the patient should be informed of the clinical indication, specific benefits, potential risks, and alternatives, if any. In addition, if the patient requests information about the exposure time and intensity, it should be provided. Patient access to educational materials regarding ultrasound is strongly encouraged to supplement the information communicated directly to the patient. Furthermore, these examinations should be conducted in a manner and take place in a setting which assures patient dignity and privacy.

- Prior material knowledge and approval of the presence of nonessential personnel with the number of such personnel kept to a minimum.
- An intent to share with the parents per the physician's judgement, either during the examination or shortly thereafter, the information derived.
- An offer of choice about viewing the fetus.
- An offer of choice about learning the sex of the fetus, if such information becomes available.

Ultrasound examinations performed solely to satisfy the family's desire to know the fetal sex, to view the fetus, or to obtain a picture of the fetus should be discouraged.

## **Acoustic Output Considerations**



**DANGER**

The Ultrasound system is a multi-use device which is capable of exceeding FDA Pre-enactment acoustic output (spatial peak-temporal average) intensity limits for fetal applications. The interaction of sound energy with tissue at sufficiently high levels and/or longer duration can produce biological effects (aka bioeffects) of either a mechanical or thermal nature.



**DANGER**

It is prudent to conduct an exam with the minimum amount and duration of acoustic output necessary to optimize the image's diagnostic value. The interaction of sound energy with tissue at sufficiently high levels can produce biological effects (aka bioeffects) of either a mechanical or thermal nature.

### **Concerns surrounding fetal exposure**

Always be aware of the acoustic output level by observing the Acoustic Output Display. In addition, become thoroughly familiar with the Acoustic Output Display and equipment controls affecting output.

### **Training**

It is recommended that all users receive proper training in fetal Doppler applications before performing them in a clinical setting. Please contact a local sales representative for training assistance.



## To Start an Obstetrics Exam

**NOTE:** Calculation formulas are listed in the *Advanced Reference Manual*.

To begin an Obstetrics exam, you have to enter the OB-specific information. Obstetric patient fields are listed in the following table.

Table 4-3: Obstetric fields

Field	Description
LMP	Last Menstrual Period; enter the date that the patient started her last menstrual period. You must enter 4 digits for the year. When you type the month and day, the system fills in the slash (/). The Date Format preset chosen in Utility -> System -> General determines the required format.
BBT	Basal Body Temperature.
EDD by LMP	Estimated Delivery Date by LMP; the system fills in the date after you enter the LMP.
GA by LMP	Gestational Age by LMP; the system fills in the age after you enter the LMP.
Gravida	Number of pregnancies.
Para	Number of births.
AB	Number of abortions.
Ectopic	Number of ectopic pregnancies.
Fetus #	Number of fetuses; default is 1. Can be 1-4.
Accession #	Exam number used with hospital information system (DICOM). This is a tracking number from the worklist.
Exam Description	Describe the type of exam.
Perf Physician	The physician who performs the exam. Choose from the list or type the name.
Ref. Physician	The physician who requested the exam. Choose from the list or type the name.
Operator	The person (not a physician) who performs the scan. Choose from the list.

**NOTE:** To fill in the following information, move the **Trackball** to highlight the **Detail** button and press **Set**.

Table 4-4: Obstetric fields: Detail

Field	Description
Indications	Why the patient needs the ultrasound exam.
Comments	Comments about the exam.

# Starting an examination

## Cautions and Warnings



WARNING

Imaging functions may be lost without warning. Develop emergency procedures to prepare for such an occurrence. Failure to prepare for unexpected loss of functionality could lead to patient injury.



WARNING

Always ensure you have selected a dataflow. If No Archive is selected, no patient data is saved and a rescan may be required. A Ø appears next to Dataflow if No Archive is selected.



WARNING

To avoid patient identification errors, always verify the identification with the patient. Make sure the correct patient identification appears on all screens and hard copy prints.



CAUTION

Always use the minimum power required to obtain acceptable images in accordance with applicable guidelines and policies.



CAUTION

Always use the system on a flat surface in the patient environment.

## **Cautions and Warnings (continued)**



### **CAUTION**

Ensure that the hands of the patient are away from the system during the exam.

The position of the operator and the patient vary by scan region.

In most cases, the operator sits/stands straight in front of the operator console and the patient lies on the bed on the right (or left) side of the system.

### Creating a new patient record

When starting a new patient's exam, ensure you do the following:

1. Press **Patient** on the Touch Panel.
2. Press **New Patient** on the Touch Panel or the monitor.
3. Fill in patient information.

**NOTE:** Press **Tab** or **Enter** on A/N keyboard to move the cursor to next field.

**NOTE:** Do not use the following characters when filling in patient information:

“ ‘ \ / : ; . , \* < > | + = [ ] &

4. Choose the exam category.  
Enter the required information for the selected exam category.



Figure 4-3. Exam category

5. Verify the dataflow.

**NOTE:** DO NOT use the removable media dataflows on the New Patient menu.

**NOTE:** The system can display a warning dialog when the patient is registered to “No Archive”. If the “Warn register to No Archive” preset is selected in the Utility -> Connectivity -> Miscellaneous menu, a warning displays. A different dataflow for permanent storage of patient data should be selected.

6. Select **Register**.
7. Select the probe to start scanning (or select Save and Exit, Esc, Scan, or Freeze).

## Perform an exam

1. Select the probe, exam category, and application.

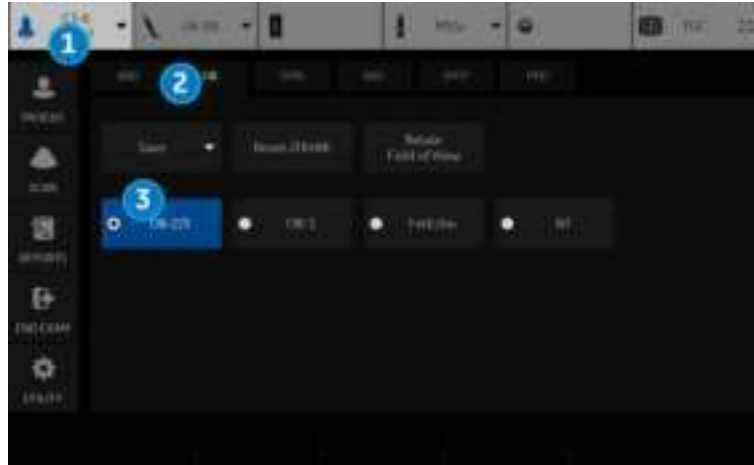

Figure 4-4. OB Preset - example

1. Probe
2. Exam category
3. Application preset

**NOTE:** See 'Imaging Preset Manager' on page 10-182 if you want create/edit user defined preset.

2. Perform an exam.
3. Store the raw data to the clipboard.

To store the still image, press **Freeze** and run the cineloop using the **Trackball**. Select the frame and press **P1** (or the assigned Print key).

To store the cineloop, press Print key without freezing or press **Freeze** and run the cineloop using the **Trackball**. Select the start/end frame and run the selected loop. Press **P1** (or the assigned Print key).

### Ending an exam



#### WARNING

To ensure correct storage of measurements, verify that the measurement result window is updated before you send or save the image.

1. When you have completed the study, press **End Exam** on the Touch Panel.
2. The image management screen displays. Select the images (still frame or cineloop) you want to store or select **Select All** to store all images. Select **Permanent Store** to store the images permanently.

**NOTE:** *Return to the patient screen automatically from the scan screen when you select OK from the “ID is not unique” warning message.*

### Scanning without entering any patient data

To scan a patient without entering any patient data until the end of the exam:

1. Press **Scan**.
2. When you scan the patient and save images to clipboard without a patient, you will receive a warning that states, “A patient must be selected for permanent storage of image.” Press OK.
3. Press **Patient** to display the Patient Search screen.
4. Enter the Patient ID.

**NOTE:** *If you have images or measurements that are not attached to a Patient ID, the message “Unsaved images, measurements or fetus number will be linked to the current patient information, continue?” appears when the patient ID is registered.*

5. Enter patient data and exam information as necessary.
6. Press **Active Images**.
7. Press **Permanent Store**.

## Starting a new exam on an existing patient

1. Press **Patient**.
2. Press **New Patient** on the Touch Panel or the monitor.
3. Enter Patient ID or Last name, etc. in the patient information to display the target patient in Patient View.  
For example, if you type “v” in Patient ID, only display patients begins with patient ID “v”.  
or select Search key and enter a string to search a patient.
4. Highlight the target patient and double click the right **Set** key. Selected patient information displays.
5. Choose the exam category for new exam.
6. Select **New Exam**. A new exam is created in Exam View.
7. Select the probe to start scanning (or select Exit, Esc, Scan, or Freeze).

## Retrieve Patient/Exam Information from Worklist

**NOTE:** Before you retrieve data from the Worklist server, make sure that Network LAN is connected correctly. If the worklist is not displayed, reboot the system.

1. Press **Patient** and select **Data Transfer**. The Data Transfer screen displays.
2. Click on a radio button of **Worklist**. The patient/exam list displays in the Transfer To section.



Figure 4-5. Data Transfer

1. Worklist
  2. Worklist radio button
  3. Transfer button
  4. Worklist server
3. The Worklist used last time is displayed on the monitor display. Press **Refresh** to refresh the list or select another Worklist server from the Transfer From pull-down menu.
  4. Select the patient(s) or the exam(s) from the list.
  5. Press **Transfer**. The progress bar displays during the transfer.
  6. Enter the required items and start an exam.



## Sending Multiple Exams and Patients with Single Click to PACS

In the Patient View window, select 1 or multiple patients -- you can select by whole exam or whole patient -- to send to PACS. Select multiple items by using the Shift+Trackball Set Key.



Figure 4-6. Multiple Patient/Exam Send To

## Change Patient Information except Patient ID and scan

1. Perform Step 1 to 6 in 'Starting a new exam on an existing patient' on *page 4-15*.
2. You can change Patient information except Patient ID.



Figure 4-7. Change Patient Information

3. Select the probe to start scanning (or select Exit, Esc, Scan, or Freeze).

## Change Patient ID of the existing patient (Edit & Copy)

1. Ensure that you are logged in as an Administrator on the system.
2. Change the dataflow to Local Archive.
3. Select the patient from the Patient View list and left click to bring up the “Edit & Copy” pop-up menu.

**NOTE:** *If you do not see the Edit and Copy ID option on the pop up menu, make sure the top half of the patient screen is blank.*

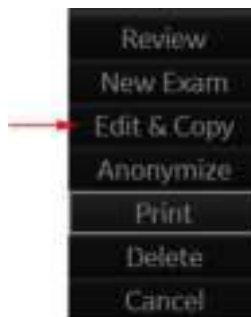

Figure 4-8. Select an Exam to Copy and Edit

4. A confirmation dialog displays. Select **OK**.



Figure 4-9. Copy Patient Pop-Up Confirmation

## Change Patient ID of the existing patient (Edit & Copy) (continued)

- The “Edit and Copy Patient” dialog displays. All the fields inherit the values from the original patient’s exam, except for Patient ID.



Figure 4-10. Edit and Copy Patient Dialogue

- **Generate Patient ID** generates a patient ID.
- **Clear All** clears all fields except for Patient ID and Other ID.
- **Cancel** button cancels the “Edit and Copy Patient” function.

- Fill in the Patient information fields, then press OK.

**NOTE:**

*If the newly entered Patient ID is not unique in the database, the Patient ID turns to red and an error message displays on the status bar.*



Figure 4-11. Copy Status Bar

- When the copy is done, the patient list is refreshed.

Make sure that the patient record with new Patient ID is created.

**NOTE:**

*If you want delete Patient record with old Patient ID, click **Delete** on the Touch Panel.*

### Tips



#### WARNING

Confirm the patient identification prior to deleting/entering/importing any patient data. The user is responsible for patient data, diagnostic information or any other patient-related information entered in the database. Failure to follow instructions could lead to loss of or incorrect patient data.

The “Edit and Copy Patient” function:

- Copies data of a registered patient from the local archive to a newly-created patient in the local archive. The newly-created patient would have a new identification: patient ID, other ID, patient name, and sex etc.
- Assigns a new identification: new UIDs to the copied exam data. The newly-copied patient would have the same medical data as the patient being copied but with a different identification.

**NOTE:** *“Edit and Copy Patient” will only copy patient data, images inside the local archive; it will not allow patient data or images from outside of the local archive. This includes the following types of images: exported, SaveAs, DICOM Store, or (DICOM) print.*

**NOTE:** *“Edit and Copy Patient” does not copy the patient’s report.*

**NOTE:** *“Edit and Copy Patient” does not deal with patient information already burned in image pixels.*

**NOTE:** *The image and title bar, including patient information, is copied as is.*

**NOTE:** *The “Edit & Copy” function does not display for a current patient.*

**NOTE:** *The “Edit & Copy” function does not display when multiple patients are selected.*

# Retrieving and editing archived information

## Searching for an existing patient

1. Press **Patient** to display the Patient Screen.
2. Select the search key (Patient ID, First Name, Last Name, etc.). Type the search string.

When default configured, the system automatically searches to see if the patient is already in the archive. The result of this search is displayed in the Patients list.

**NOTE:**

*When the number of patients on a hard disk is in the hundreds, it takes time to search for a patient or switch to another screen. In this case, do one of the following:*

- *Uncheck the “Auto search for patient” preset, found under Patient/Exam Menu Options in Utility -> Connectivity -> Miscellaneous.*
  - *Delete unnecessary patient data.*
3. Highlight the patient in the Patients list.  
Select the Exam View tab to display a list of examinations instead of the patient records.

## Searching for an existing patient (continued)



Figure 4-12. Patient Search Screen

1. Select **Review** to review the exam history of this patient.  
If the study was performed on the same day, **Resume Exam** will populate in place of **Review** to continue the exam
2. Select **New Exam** to create a new exam for this patient.
3. Select **Delete** to delete this patient.
4. Lock/Unlock. Use to lock/unlock the exam/patient.

**NOTE:** “Delete” is only displayed when you login as Administrator.

## Pop-up menu

If you select the patient and press the left **Set** key, the pop-up menu displays.



Figure 4-13. Archived Patient

If the study was performed on the same day, **Resume Exam** will populate to continue the exam.



Figure 4-14. Patient of the Day

**NOTE:** The preset "Double click on patient list to start", located on the Utility -> Connectivity -> Miscellaneous screen, allows you to display either the Review or New Exam screen by double clicking the **Set** key on the patient name.

## Changing Patient Information or an Exam

If patient information needs to be edited, pressing **Patient** enables the Patient Screen for modifying information.

If the patient is still active, you can go to the New Patient page to change any field as well as select a different category. The exam changes in the Exam View area.

If the exam category needs to be changed, pressing **New Exam** allows modification of the Patient Screen without erasing accumulated patient images, measurements, annotations, calculations and worksheets.

1. Display the Patient screen by pressing **Patient**.
2. Select patient from the Patient list. The system automatically searches to see if the patient is already in the database.
  - Select Search key (Patient Data: ID, First Name, Last Name, Birthdate, Sex or Exam Date.
  - Enter search string (for example, initial letter of Patient Name)
3. The appropriate patient is displayed.

If patient information needs to be edited or the exam category changed, use the New Exam feature. Pressing **New Exam** allows modification of the Patient Screen without erasing accumulated patient images, measurements, annotations, calculations and worksheets.

**NOTE:** *Patient identification information cannot be modified.*



## Changing Patient Information or an Exam (continued)

4. To have the database shown in its entirety, **Backspace** on the Search string and all patient names appear.
5. Select Register to register the new exam.  
A new exam is automatically created on that patient unless an exam already exists on that day for that patient.
6. To display the patient information on the title bar, press the **Esc** key, the **B-Mode** key or **Register**.  
Select the Model and appropriate probe Touch Panel keys, if necessary.

## Deleting the existing patient/exam/image



### WARNING

Before deleting a patient or image from the Patient Screen, make sure you have already saved the data with EZBackup, Backup, or Export. Verify the media before deletion. Failure to follow instruction could lead to loss of patient data.

## Deleting the existing patient

1. Search and select the patient in the patient list with the **Ctrl** or **Shift** keys.
2. Select **Delete**. The confirmation dialog box displays.  
OR  
Press the left **Set** key. A pop-up menu displays. Select **Delete**. The confirmation dialog box displays.



Figure 4-15. Select the patient in the patient list

3. Select **Yes** to delete or **No** to cancel.

## **Deleting the existing patient/exam/image (continued)**

### **Delete multiple patients from the patient list**

1. Select the multiple patients to be deleted from the patient list.
2. Select **Delete**. The confirmation dialog box displays.  
OR  
Press the left **Set** key. A pop-up menu displays. Select **Delete**. The confirmation dialog box displays.
3. Select **Yes** to delete or **No** to cancel.

### **Deleting the existing exam**

1. Search and select the patient in the patient list.
2. Select **Review**.
3. The patient exam screen displays. Select the exam to be deleted.
4. Select **Delete**. The confirmation dialog box displays.
5. Select **Yes** to delete or **No** to cancel.

### **Deleting the existing image**

1. Search and select the patient in the patient list.
2. Select **Review**. The patient exam screen displays.
3. Select the exam which contains the image to be deleted.
4. Select **Active Images** to display the image list.
5. Select the image to delete and select **Delete**. The confirmation dialog box displays.
6. Select **Yes** to delete or **No** to cancel.

# MyPreset

## Overview

MyPreset allows you to configure the specific-presets according to the probe.

You can arrange and edit the presets on the Touch Panel in Utility. See 'Arranging MyPreset Tab' on *page 4-29* for more information.

## Activating MyPreset

1. Check **Default MyPreset** in Utility > System > System Imaging > Control to start MyPreset.
2. From the Touch Panel, select the active probe icon. MyPreset exam tab displays on the Touch Panel.

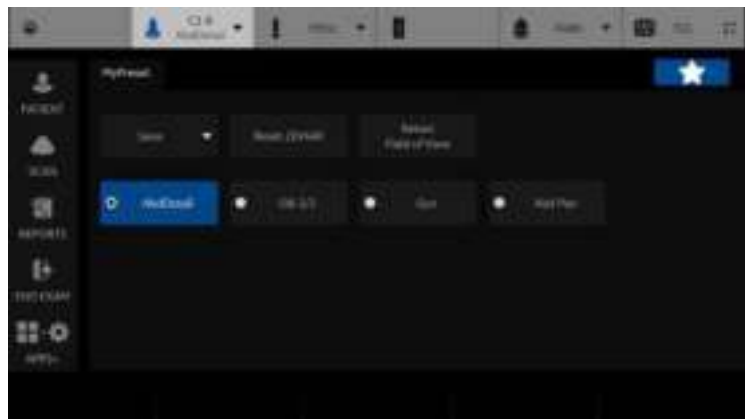

Figure 4-16. MyPreset Tab

**NOTE:** Select MyPreset (star icon) on the Touch Panel. Conventional exam tab displays.

## Activating MyPreset (continued)



Figure 4-17. Conventional Exam Tab

## Arranging MyPreset Tab

You can update MyPreset Configuration for each probe if desired. Need for each probe separately.

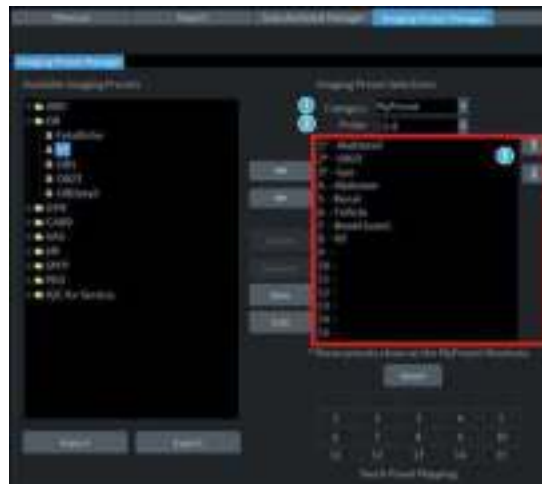

Figure 4-18. Imaging Preset Manager

1. Select MyPreset.
2. Select desired Probe.
3. Select presets from Available Imaging Presets column to be displayed on MyPreset tab. Use the up/down arrow to move the preset to a position.



---

## Chapter 5

# Optimizing the Image

*Describes how to adjust the image. This chapter is broken into the following sections: B-Mode, M-Mode, Color Flow Mode, M Color Flow, Doppler Mode, and 3D Mode.*

# Optimizing B-Mode

## **Intended Uses**

B-Mode is intended to provide two-dimensional images and measurement capabilities concerning the anatomical structure of soft tissue.

## **Typical B-Mode Exam Protocol**

A typical examination using B-Mode might proceed as follows:

1. Record exam-related patient information. Verify system setup (probes and presets).
2. Position the patient and the console for optimum operator and patient comfort. Perform the scan.
3. Complete the study by collecting all the data.



## B-Mode Scanning Hints



### HINTS

These B-Mode controls produce the following results:

**Auto Optimize.** Automatically improves the contrast resolution of the image by changing the gray scale to match the image data. Available in B-Mode and Doppler Mode.

**Coded Harmonics.** Improves image clarity and tissue contrast by reducing clutter and artifacts.

**B-Flow.** Provides a more intuitive representation of non-quantitative hemodynamics in vascular structures.

**Frequency.** Changes system parameters to best optimize for a particular patient type.

**Gray Map.** Affects the presentation of B-Mode information. Choose the gray map prior to making other adjustments. There is an interdependency between gray maps, gain, and dynamic range. If you change a map, revisit gain and dynamic range settings.

**Dynamic Range.** Changes the amount of gray scale information displayed. A higher dynamic range shows more gray scale information displayed, while a lower dynamic range displays less gray scale information onto the same display scale. If you increase the gain, you may want to decrease the Dynamic Range.

**Frame Average.** Smooths the image by averaging frames. Reduces noise in the image.

**TGC.** Adjust TGC to adjust Gain in specific areas.

**Width.** Sizes region of interest. Adjust the Width to the smallest reasonable size to maximize frame rate.

## B-Mode Controls

Table 5-1: B-Mode Controls

Control	Adjusts Acoustic Output	Description/Benefit
Depth	Yes	To increase/decrease, adjust <b>Depth</b> . Depth controls the distance over which the B-Mode images anatomy. To visualize deeper structures, increase the depth. If there is a large part of the display which is unused at the bottom, decrease the depth.
Gain	No	To decrease/increase, rotate <b>Gain</b> (Mode key). B-Mode Gain increases or decreases the amount of echo information displayed in an image. It may have the effect of brightening or darkening the image if sufficient echo information is generated. Note: Always optimize gain before increasing the Power Output.
Focus 	Yes	In B-Mode, 4D and Contrast (Reference and Contrast) mode, the Focus is applied uniformly across the entire field of view, as indicated by the Focus indicator overlaid on the Depth indicator (see example 1 on the left).  In Contrast MVI, CF/PDI/MVI, the Focus position is focused in the Region of Interest, as indicated by the "Dot" indicator overlaid on the Depth indicator (see example 2 on the left). The focus position is assigned to a rotary on the Contrast MVI, CF/PDI/MVI tab.
Auto Optimize	No	See 'Auto Optimize' on <i>page 5-8 for more information</i> .
ACE	No	Use ACE (Adaptive Contrast Enhancement) to emphasize echoes from real structures while reducing noise/haze. This results in enhanced signal-to-noise ratio. A sub-selection of ACE allows you to adjust how much ACE is applied, including a setting showing the coherence factor. Values are Light, Medium, or High filtering, or None (no filtering).
Mode Cursor	No	Displays the M/D-Mode cursor on the B-Mode image. To activate/deactivate the M/D-Mode cursor, press <b>Mode Cursor</b> (left Set key). <b>Trackball</b> to position the M/D-Mode cursor. Adjust the Angle and SV Length as necessary.
SRI-HD	No	See 'SRI-HD (High Detection Speckle Reduction Imaging)' on <i>page 5-11 for more information</i> .

Table 5-1: B-Mode Controls (Continued)

Control	Adjusts Acoustic Output	Description/Benefit
CrossXBeam	No	CrossXBeam Angle adjusts maximum steering angle of CrossXBeam. Higher values correspond to larger angles. See 'CrossXBeam' on page 5-14 for more information.
Coded Harmonic Imaging (CHI)	Yes	To activate Coded Harmonic imaging, press <b>CHI</b> on the control panel. Coded Harmonics enhances near field resolution, diminishes low frequency high amplitude noise and improves imaging technically difficult patients. Coded Harmonics may be especially beneficial when imaging isoechoic lesions in shallow-depth anatomy in the breast, liver, and hard-to-visualize fetal anatomy.
Frequency	Yes	Adjust <b>Frequency</b> until the desired frequency is selected. Multi Frequency mode lets you downshift to the probe's next lower frequency or shift up to a higher frequency.
Steer	Yes	To slant the linear image to the left/right, select <b>Steer</b> . You can slant the B-Mode or Color Flow linear image left or right to get more information without moving the probe. The angle steer function only applies to linear probes. Linear probes can be steered left, center, or right up to a maximum of 15 degrees, depending on the probe.
Virtual Convex	Yes	To activate/deactivate Virtual Convex, select <b>Virtual Convex</b> . On Linear and Sector probes, Virtual Convex provides a larger field of view in the far field. Virtual Convex is defaulted as active with Sector probes.
Max Angle	Yes	With IC5-9-D and RIC9-5-D probes, the Virtual Convex control becomes Max Angle. Max Angle toggles the field of view to 179 degrees.
TGC	No	TGC amplifies returning signals to correct for the attenuation caused by tissues at increasing depths. TGC slide pots are spaced proportionately to the depth. The area each pot amplifies varies as well. A TGC curve may appear on the display (if preset), matching the controls that you have set (except during zoom). You can choose to deactivate the TGC curve on the image.
Width	Yes	To narrow/widen the sector width, rotate the <b>Width</b> control (located on the Depth control). You can widen or narrow the size of the sector angle to maximize the image's region of interest (ROI).

Table 5-1: B-Mode Controls (Continued)

Control	Adjusts Acoustic Output	Description/Benefit
Tilt	Yes	<p><i>Tilt</i> is available on the Trackball and/or the Rotary control, allowing sector angle adjustment to obtain more information without moving the probe.</p> <p>Trackball Control: When shown as available on the Trackball controls on the display, use the Trackball key and the Trackball to tilt the angle to the left/right.</p> <p>Rotary Control: Rotate the Rotary control to tilt the angle to the left/right. Pressing the control resets Tilt to center.</p> <p><i>Tilt</i> is not available on Linear probes.</p> <p><i>Tilt</i> is not available while in CrossXBeam.</p>
Dynamic Range	No	<p>To increase/decrease, adjust Dynamic Range.</p> <p>Dynamic Range controls how echo intensities are converted to shades of gray, thereby increasing the adjustable range of contrast. Dynamic Range is useful for optimizing tissue texture for different anatomy. Dynamic Range should be adjusted so that the highest amplitude edges appear as white while lowest levels (such as blood) are just visible.</p>
Reverse (if Preset)	No	<p>To flip the image 180 degrees, press the <b>Reverse</b> key.</p> <p>Flips the image 180 degrees left/right.</p> <p><b>WARNING:</b> When reading a reverse image, be careful to observe the probe orientation to avoid possible confusion over scan direction or left/right image reversal. Failure to follow instructions could result in misinterpretation.</p>
Maps	No	<p>To select a map, press the <b>Gray Map</b> on the Touch Panel. A map window displays. The image reflects the map as you go through the selections.</p> <p>The system supplies B, M, and Doppler Mode system maps. Maps are preset-specific and are arranged in order from the softest map on the top of the menu to the map with the most contrast on the bottom of the menu.</p> <p>The only exception is Map J, which is a very soft map.</p>
Frame Average	No	<p>Temporal filter that averages frames together, thereby using more information to make up one image. This has the effect of smoothing the image and reducing apparent noise.</p>
Colorize	No	<ol style="list-style-type: none"> <li>1. Select <b>Colorize</b> on the Touch Panel.</li> <li>2. <b>Trackball</b> to cycle through available maps.</li> <li>3. Press <b>Set</b> to select.</li> </ol> <p>Colorize is the colorization of a conventional B-Mode image or Doppler Spectrum to enhance the user's ability to discern B, M, and Doppler Mode intensity valuations.</p> <p><i>NOTE: You can colorize realtime or CINE images or Timeline CINE, but not DVR images.</i></p> <p>Colorizes the gray scale image to enhance the eye's discrimination capability.</p> <p>The gray bar displays while Colorize is activated.</p> <p>To deselect, select a gray map.</p>

Table 5-1: B-Mode Controls (Continued)

Control	Adjusts Acoustic Output	Description/Benefit
Rotation	No	Rotates the image 180 degrees. Beneficial in transvaginal and transrectal scanning. <b>WARNING:</b> When reading a rotated image, be careful to observe the probe orientation to avoid possible confusion over scan direction or left/right image reversal. Failure to follow instructions could result in misinterpretation.
Frame Rate	Yes	Optimizes frame rate or spatial resolution for the best possible image. High Frame Rate is useful in fetal heartbeat, adult cardiac applications, and clinical radiology applications which require significantly higher frame rates. Low Frame Rate (high resolution) is useful in situations where very small vessels are being imaged, e.g., thyroid, testicles.
Rejection	No	Selects a level below which echoes will not be amplified (an echo must have a certain minimum amplitude before it will be processed). Allows for the elimination from the display of low level echoes caused by noise.
Suppression	No	Suppresses the noise in the image.
Speed of Sound	No	See 'Speed of Sound (SoS) Tissue Imaging' on page 5-28 for more information.

### Auto Optimize

#### Description

Continuous Auto Tissue Optimize (CATO) optimizes the image based on the B-Mode image data. Different preset levels (Low, Medium, High) allow users to choose a preference for contrast enhancement of the B-Mode image. Low provides the least amount of contrast enhancement, high provides most.

CATO is available in single or multi images, on live, frozen or CINE images (in B-Mode only), and while in zoom.

**NOTE:** *The probe orientation mark color is blue with green lines above and below.*



Figure 5-1. Probe Orientation Marker

Auto in PW Doppler Mode (ASO: Auto Spectral Optimization) optimizes the spectral data. Auto adjusts the Velocity Scale/PRF (live imaging only), baseline shift, dynamic range, and invert (if preset). "Running Auto Spectral Optimization" appears at the bottom of the monitor upon activation. Upon deactivation, the spectrum is still optimized.

#### Benefit

Auto can reduce optimization time and create a more consistent process.

#### Adjusting

To activate, press Right **Auto** key.

Press Left **Auto** key to turn off Auto.

#### Auto Optimize Preset

The CATO preset can be set at Utility > Imaging > B-Mode > Auto Optimize Mode. Specify the CATO Level: Low, Medium, or High.

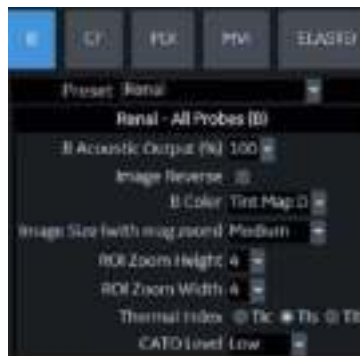

Figure 5-2. CATO Preset

<b>Values</b>	Auto is active until you deactivate it or when you change the following: Probe, Exam Category, Exam Calcs, or New Patient.
<b>Affect on other controls</b>	You may need to adjust the Gain.

## **Continuous Tissue Optimization (CTO)**

<b>Description</b>	CTO optimizes the spatial continuous gain adjustment on the B-Mode image. CTO can be used alone or in combination with CATO.  <i>NOTE: The probe orientation mark color is turquoise with an over and under line.</i>
<b>CTO Preset</b>	Select Auto Optimize Mode at Utility > Imaging > B > Auto Optimize Mode. CTO only, CATO only or both may be selected to use a combination of CTO and CATO to optimize the B-Mode image.
<b>Adjusting</b>	To activate CTO, press the right <b>Auto</b> control.  To deactivate CTO, press the left <b>Auto</b> control.  To adjust the overall CTO Gain, use “CTO Gain” on the Touch Panel or B-Mode Gain. This can be set via Utility--> Imaging--> B--> CTO Gain.
<b>Benefit</b>	CTO can reduce optimization time and create a more consistent process.
<b>CTO Availability</b>	CTO is available on the C1-6-D, C1-6VN-D, C2-7-D, C2-7VN-D, C3-10- D, IC5-9-D, RIC5-9-D, RAB6-D, 9L-D, L3-12-D, ML6-15-D, L6-24-D, 12S-D, M5Sc-D and 6S-D probes, in certain applications



## SRI-HD (High Detection Speckle Reduction Imaging)

### Description

SRI-HD (High Detection Speckle Reduction Imaging) is an adaptive algorithm to reduce the unwanted effects of speckle in the ultrasound image. Image speckle usually appears as a grainy texture in otherwise uniform areas of tissue. Its appearance is related to image system characteristics, rather than tissue characteristics, so that changes in system settings, such as probe type, frequency, depth, and others, can change the appearance of the speckle. Too much speckle can impair image quality and make it difficult to see the desired detail in the image. Likewise, too much filtering of speckle can mask or obscure desired image detail. Extra care must be taken to select the optimal SRI-HD level.

### SRI-HD

SRI-HD is available in B-Mode imaging and may be used with any transducer or clinical application when image speckle appears to interfere with the desired image detail.

### Advanced SRI Type 1

Advanced SRI Type 1 is available in B-Mode for select applications, to produce images with clear borders and reduced speckle while maintaining natural image texture.

### Advanced SRI Type 2

Advanced SRI Type 2 is available in B-Mode for OB/GYN applications (as a purchasable option), to produce smoother, cleaner images with enhanced border delineation.

SRI-HD Type 2 is available for the probes and applications listed in Table 5-2.

Table 5-2: Advanced SRI Type 2 OB/GYN Probes and Applications

Probe	OB1	OB23	FetalEcho	NT	GYN	Follicle
C1-6-D/C1-6VN-D	X	X	X	X	X	X
RAB6-D	X	X	X	X	X	X
9L-D	X	X	X	X	X	X
L3-12-D	X	X	X	X		
IC5-9-D	X	X		X	X	X
RIC5-9-D	X	X		X	X	X

**NOTE:** When available per probe and application, the SRI Type can be chosen on the B-Mode tab, page 2.

## SRI-HD (High Detection Speckle Reduction Imaging) (continued)

### Adjusting

Adjust SRI-HD levels on the Touch Panel. You can also set presets via Utility--> Imaging--> B-Mode.

**NOTE:** *We recommend selecting the SRI-HD level by observing the enhanced image in side-by-side dual image comparison with the original, unprocessed image. Dual display mode is activated by pressing the L and R keys simultaneously.*

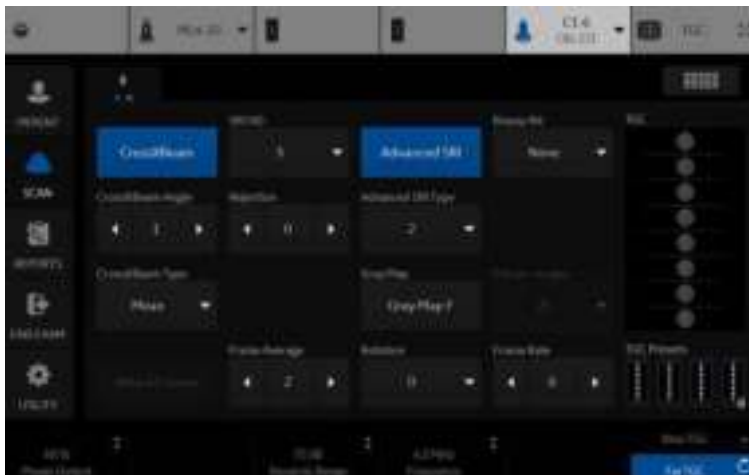

Figure 5-3. SRI-HD Adjustment

### Values

Level values vary, depending upon the probe. 0 = Minimal Filtering. Increasing the level value increases the amount of SRI filtering and will result in smoother images.

### Benefits

SRI-HD smooths the image when image speckle interferes with the desired image detail.

## SRI-HD (High Detection Speckle Reduction Imaging) (continued)

### Tips and Notes

When selecting the SRI-HD level, observe the effect of SRI-HD in the desired region of interest and make a real-time comparison with the original image. The optimal level depends on the clinical situation. Observing the original and SRI-HD-processed images together helps to determine whether too much or too little SRI-HD has been applied.

Dual image mode for SRI-HD can also be activated on a stored CINE Loop. This allows you to always see the original, unprocessed or enhanced image by going into the Dual display mode and to change the SRI-HD settings when reviewing the CINE Loop.

SRI-HD is available on 3D/4D (sectional image and render image).

- You cannot change SRI-HD after the scan starts.
- The effects for the rendered image are less than the 2D-image.

### CrossXBeam

#### Description

CrossXBeam is the process of combining three or more frames from different steering angles into a single frame. CrossXBeam is available on Convex and Linear probes.

CrossXBeam combines multiple co-planar images from different view angles into a single image at real-time frame rates.

CrossXBeam Angle adjusts maximum steering angle of CrossXBeam. Higher values correspond to larger angles.

#### Adjusting

To activate CrossXBeam, press the **CrossXBeam** key on the Touch Panel; an “X” appears on the display next to “CHI” or “B.”

You can also adjust the **CrossXBeam Angle** and **CrossXBeam Type** (Mean/Hybrid/Max/MotionCorrection) on the Touch Panel. **Max** detects maximum values; **Mean** detects averaged values; **Hybrid** detects a mix of both average and maximum values; **MotionCorrection** suppresses blurriness and/or artifacts caused by lateral motion.

#### Values

All linear and convex probes are supported. B-Mode CrossXBeam is available while in B-Mode, Color Flow, or PW Doppler Mode. Steering is optimized by probe.

#### Benefits

The combined single image has the benefits of:

- reduced speckle noise,
- reduced clutter, and
- continuity of specular reflectors.

Therefore, this technique can improve:

- contrast resolution with increased conspicuity of low contrast lesions,
- better detection of calcifications,
- biopsy needle visualization, and
- cystic boundary definition.

## B-Flow

### Description

B-Flow is intended to provide a more intuitive representation of non-quantitative hemodynamics in vascular structures.

B-Flow is digitally-encoded Ultrasound, using digital codes to enhance weak signals from small particulate reflectors (blood flow) and suppress signals from strong reflectors (tissue). Flow and tissue are displayed simultaneously without threshold decision and overlay.

All B-Mode measurements are available with B-Flow active: depth, distance along a straight line, % stenosis, volume, trace, circumference, and enclosed area.

### Presetting

Preset the default B Flow Mode via Utility--> Imaging--> General--> BF button.

### Activating

To activate/deactivate B-Flow, press **B-Flow** on the control panel. The preset default B Flow Mode appears. PW Doppler Mode is available while in B-Flow; however, M-Mode and Color Flow/PDI Modes are not available.

### Using B-Flow

To optimize the image:

Adjust the frequency, display depth, and focal zone location based on the patient body type and anatomy of interest. Adjust Sensitivity/PRI and Background setting as needed (see below).

Adjust the remaining Imaging parameters and presets as needed; functionally is the same as B-Mode when in B-Flow mode.

### Scanning Hints

B-Flow provides an intuitive view of blood flow, acute thrombosis, soft plaque, small vessel perfusion, and high grade stenosis. Compared to Color Doppler, it does not display bleeding, blooming, or aliasing artifacts.

To view high speed jets only for stenosis, use a PRI value of 10 or lower. Use the Background control to display an appropriate amount of tissue background including plaque.

To view slow flow, use a large PRI value while avoiding a PRI value that introduces a bar artifact.

### B-Flow (continued)

<b>Benefits</b>	Compared to Color Doppler mode, B-Flow provides better spatial and temporal resolution, displays blood flow in the entire image, i.e. NO ROI, and is not angle dependent as it does not use the Doppler Principle. B-Flow is therefore a more realistic (intuitive) representation of flow information, allowing you to view both high and low velocity flow at the same time.
<b>Affect on other controls</b>	When you activate B-Flow, the system remembers the imaging parameters set while in B-Mode. When you optimize the frame rate via Line Density, you compromise the resolution and when you optimize the resolution, you compromise the frame rate. B-Flow is not available in 3DView; but is available in Easy 3D.
<b>Bioeffects</b>	Using B-Flow Frequency, Focus Position/Number, Sensitivity/PRI, Line Density, Visualization and Power Output may change the TI and/or MI. Observe the output display for possible effects.

### Background

<b>Description</b>	Background and Tissue controls work together to display the amount of background shown on the B-Flow image. Background provides a large change in the amount of tissue displayed; Tissue provides fine tuning to the amount of tissue displayed.  Adjusts the amount of tissue displayed on the B-Flow image. Works along with the Tissue control.
<b>Value</b>	0, 1, 2, 3 <ul style="list-style-type: none"><li>• 0 = Least amount of tissue displayed.</li><li>• 3 = Most tissue displayed.</li></ul>

*NOTE: Not available for Frozen images or in CINE.*

### Accumulation

<b>Description</b>	Accumulation enhances the flow in an image; ideal to capture dynamic flow in a still picture.
<b>Values</b>	Off - Infinite. Infinite provides the same result as applying CINE Capture to a B-Flow CINE clip.
<b>Benefit</b>	Accumulation detects the maximum signal and holds it (accumulates it) for the level specified (Off - Infinite).

## B-Flow (continued)

### Capture

#### Description

B-Flow Capture provides users the ability to create an accumulated image in B-Flow Live. Maximum intensity projection algorithm to detect the strongest signal between the frames and display the results.

Capture allows the user to represent the dynamic flow situation in the vasculature with a single still image. Adjustments can be made to modify the start and end frames used in the process. Select from the Touch Panel, a “C” will appear in the image parameter list in place of frame average.

*NOTE: B-Flow Capture is assigned to the right Trackball key. You can operate B-Flow Capture from the Touch Panel or the right Trackball key. B-Flow Capture is available only while in Research mode.*

*NOTE: When turning on Live Capture, the cine buffer is cleared of prior data.*

### Sensitivity/PRI

#### Description

Sensitivity/PRI (Pulse Repetition Interval) is proportional to the time interval between the pulses sent to develop the B-Flow image.

In general, a larger value is recommended for slow flow as slow flow detection requires more time separation between pulses so the system can detect the difference in flow profile. However, a larger value could cause bar artifacts on the image. Therefore, it is suggested to not increase the PRI value more than needed. A small value of PRI should be used when the interest is in fast flow only, e.g. viewing a jet in a stenosis case, where the jet is of interest.

*NOTE: Sensitivity/PRI is Probe and Exam Category dependent.*

#### Bioeffects

Using B-Flow Sensitivity/PRI may change the TI and/or MI. Observe the output display for possible effects.

## **B-Flow (continued)**

### **Visualization**

**Description**

Define the display technique.

**Values**

- **B-Flow.** Displays only B-Flow image.
- **Dual.** Displays B-Mode and B-Flow images simultaneously using dual screen.
- **Hybrid.** Displays the B-Flow image over the B-Mode image using Hybrid Map.

*NOTE: Press **L** and **R** at the same time to switch between Visualization values. The switch sequence can be selected in Utility -> Imaging -> BF -> "L/R Button Sequence".*

*NOTE: Available for C1-6-D, C1-6VN-D, C2-7-D, C2-7VN-D, C3-10-D, 9L-D, L3-12-D, L6-24-D, M5Sc-D and ML6-15-D probes.*



## LOGIQView

### Description

LOGIQView provides the ability to construct and view a static 2D image which is wider than the field of view of a given transducer. This feature allows viewing and measurements of anatomy that is larger than what would fit in a single image. Examples include scanning of vascular structures and connective tissues in the arms and legs.

LOGIQView constructs the extended image from individual image frames as the operator slides the transducer along the surface of the skin in the direction of the scan plane. The quality of the resulting image is somewhat user-dependent and requires some additional skill and practice to develop proper technique and become fully proficient.

LOGIQView is not available for the following:

- Multi Image
- Timeline Modes
- B-Flow Mode
- Color Flow Mode
- PDI Mode

### Benefits

The user can look at a larger region of interest within one field of view that is wider than any given probe would normally provide.

### Clinical Use

LOGIQView is intended for scanning areas too large to fit on one image.

### Using LOGIQView

To perform an exam using LOGIQView,

1. Perform a detailed examination of the anatomy/pathology. Optimize parameters for tissue texture and visible window **PRIOR TO** activating LOGIQView.
2. Press the LOGIQView key on the Control Panel.
3. To start acquiring the image, press **Start** (Trackball key).



### HINTS

When you scan, start with a strong, quick sweep in the direction of the acquisition and then complete the LOGIQView image with a slow steady sweep. LOGIQView acquires images via leading edge vectors (and does not acquire slices, as in CINE). The image is being stored as you perform the scan and you can watch the LOGIQView as it is being acquired.

### LOGIQView (continued)

4. To restart the scan, press **Start** again. You can back up the probe, realign it, then go forward to redo a portion of the scan.
5. To complete the scan, press **End** or Freeze (or allow the scan to auto complete. The LOGIQView is then displayed, scaled to fit entirely on the screen.
6. Perform measurements and record images.
7. Select Frame Review to move through the LOGIQView one frame at a time. Use the Trackball to scroll.

**NOTE:** *Measurement error is within 5% of the distance you measured for all linear probes.*

### Uniform Motion

The quality and usefulness of LOGIQView images is affected by transducer motion. Incorrect technique can contribute to image distortion.

Guidance and precautions for uniform motion:

- Continuous contact is required throughout the length of the extended image. DO NOT lift the transducer from the skin surface.
- Always keep the transducer perpendicular to the skin surface. DO NOT rock the transducer.
- Keep the motion within the same scan plane, if possible. DO NOT slide the transducer laterally.
- Lateral turning (change in direction to follow anatomical structure) can be accommodated with slower motion. DO NOT make abrupt changes in direction.
- The system accommodates a reasonable range of motion velocity. DO NOT make abrupt changes in speed of motion. Deeper scans generally require reduced speed.

### Bioeffects

Activating LOGIQView has no affect upon Acoustic Output values.

**NOTE:** *Available for most of 2D imaging supported probes*

## B Steer+ (Option)

<b>Description</b>	BSteer+ allows you to obtain improved biopsy needle visualization without changing B-Mode imaging parameters. B Steer+ is available in B-Mode, Color Flow mode, and PDI mode. BSteer+ is available with all linear probes and the following convex probe: C1-6-D.
<b>Preset</b>	<p>To enable/disable B Steer+: Set the “Steer knob activates B Steer+” preset via the Utility --&gt; Imaging --&gt; General page.</p> <p>To set the B Steer+ Angle and Needle Gain: Set via the presets on the Utility --&gt; Imaging --&gt; B Tab.</p>
<b>Adjustment</b>	<p>To activate B Steer+, adjust the Steer/Width/Depth/Reverse Joystick to the left or right. The B Steer+ symbol and border line display on the image (at the opposite side of product logo).</p> <p><i>NOTE: Make the biopsy and beam angle as perpendicular as possible.</i></p> <p>Needle gain and angle adjustments are available using the:</p> <ul style="list-style-type: none"> <li>• Touch Panel controls (B Steer+ Angles and Needle Gain). Select the appropriate beam angle or needle gain via the Touch Panel control.</li> <li>• Steer/Width/Depth/Reverse Joystick (Needle Gain). Rotate the Steer/Width/Depth/Reverse Joystick left/right to adjust the gain.</li> <li>• Auto (B Steer+ Angle). Press Auto left/right to adjust the B Steer+ Angle.</li> </ul> <p>Find the best needle visibility by changing the needle gain and needle angle.</p>
<b>Values</b>	<p>B Steer+ angle (beam steering angle for needle visualization) is selectable from 15 to 40 degrees. Needle Gain is adjustable from 0 to 100.</p> <p>B Steer values (including enable/disable, B Steer+ angle, and Needle Gain) are returned to factory or user preset values when you change: Probe, Exam Category, Exam Calcs, or New Patient.</p>
<b>Benefits</b>	<p>BSteer+ provides better needle visualization compared to normal B-Mode. B Steer+ allows you to adjust beam angle and needle gain to achieve best possible needle visualization without affecting the B-Mode image. The enhanced needle is superimposed on top of the BMode image, giving the best possible image of both needle and tissue..</p>
<b>Bioeffects</b>	<p>Activating B Steer+ may change the TI and/or MI. Observe the output display for possible effects.</p>

### Activating

To activate BSteer+ press the BSteer+ button (1) in the B tab on the Touch Panel.

*NOTE: To activate BSteer+ in Color Flow or PDI mode, first select the B tab on the Touch Panel.*

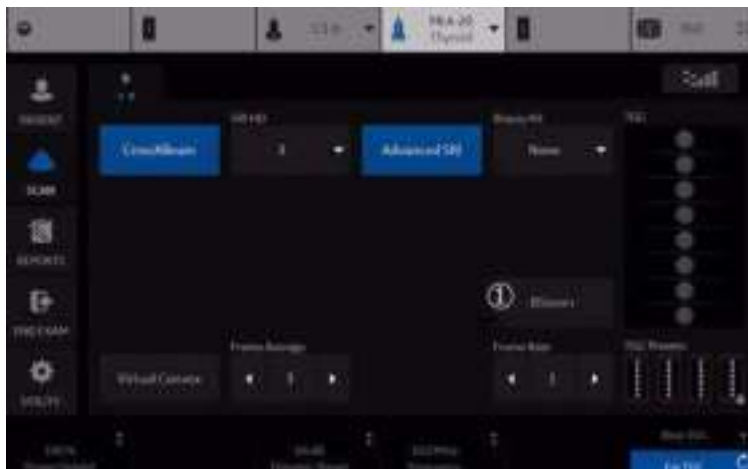

Figure 5-4. Button for activating BSteer+

The steer knob may also be used to activate BSteer+. To do this, check the option Steer knob activates BSteer+ in Utility > Imaging > General menu. Pushing the steer knob left or right will then activate BSteer+.

*NOTE: When using the Steer knob for BSteer+, this functionality only applies only to the selected probe and preset in the Utility > Imaging menu.*

*NOTE: When using the Steer knob for BSteer+, normal steer functionality will not be available for the selected probe and preset. Activating BSteer+ may decrease frame rate.*

### Using B Steer+

When BSteer+ is activated, the BSteer+ symbol (1), and a borderline appears on the image. The borderline indicates the boundary of the needle enhancement area. Beneath the line, the needle is not enhanced by BSteer+.



Figure 5-5. BSteer+ Symbol (1) and Borderline (2)

**NOTE:** For convex probes, 2 borderlines may appear. The region between the lines is the needle enhancement area. This area is narrow relative to the width of the image for a convex probe because the beams are steered so that they are parallel. For convex probes, a limited part of the needle in the image will be enhanced (the tip as it first enters the tissue, and the upper part of the shaft as it is inserted deeper).

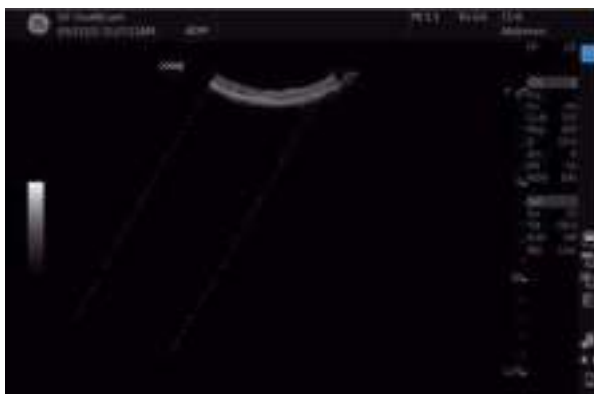

Figure 5-6. Two Borderlines May appear in BSteer+ for Convex Probes

The BSteer+ tab and the following controls appear on the Touch Panel.



Figure 5-7. BSteer+ Tab and Controls on the Touch Panel

1. Beam Direction
2. Beam Angle
3. Dynamic FOV (field-of-view)
4. Needle Resolution
5. Needle Gain BSteer+ (for deactivating BSteer+)

To optimize the biopsy image using BSteer+ functionality, adjust BSteer+ beam direction, angle and needle gain.

Adjust BSteer+ beam direction and angle to make needle and beam angle as perpendicular as possible.

BSteer+ beam direction and angle are selectable using the direction and angle buttons on the Touch Panel.

**NOTE:** *BSteer+ angle can also be adjusted using the Set Keys above the trackball if **Use set keys to change BSteer+ Angle** is checked in Utility > System > User Configurable Key menu.*

**NOTE:** *When the BSteer+ tab is active on the Touch Panel, the Auto Keys can also be used to adjust BSteer+ angle. To use Auto Keys to activate and deactivate auto optimize while in BSteer+, select the B tab on the control panel.*

*Adjust Needle Gain to achieve desired needle brightness. Gain is adjustable by rotating the Needle Gain rotary or the Depth rotary (range from 0 to 100).*

**NOTE:** *If the Needle Gain is too high, noise may be amplified along with needle.*

Turning on Dynamic FOV will make the needle signal stronger when the steering angle is not perfectly perpendicular to the needle.

**NOTE:** *Turning on BSteer+ Dynamic FOV may decrease frame rate.*

Select Needle Resolution to achieve desired spatial resolution for the needle. High will make needle appear thinner, and Low will make needle appear thicker.

BSteer+ values (including enable/disable, beam direction, angle and Needle Gain) are returned to factory default values or user preset values when the following change: Probe, Exam Category, Exam Calcs or New Patient.

## Preset



Figure 5-8. BSteer+ Preset

- BSteer+ Beam Direction - preset via Utility -> Imaging -> B Tab.
- BSteer+ Beam Angle - preset via Utility -> Imaging -> B Tab.
- BSteer+ Needle Gain - preset via Utility -> Imaging -> B Tab.
- BSteer+ Dynamic FOV - preset via Utility -> Imaging -> B Tab.
- BSteer+ Needle Resolution - preset via Utility -> Imaging -> B Tab.

### Touch TGC

**Description** TGC amplifies returning signals to correct for the attenuation caused by tissues at increasing depths. TGC slide pots are spaced proportionately to the depth. A TGC curve may appear on the display (if preset), matching the controls that you have set (except during zoom).

*NOTE: TGC adjusts the image automatically when using zoom.*

**Values** When you change the depth, TGC is rescaled across the new depth range. Each pot is proportionately scaled across the depth.

**User-Defined Preset** There are 4 presets located on and selected via the Touch Panel. The right-most preset is locked and cannot be changed.  
TGC Display On/Off -- preset via Utility --> System --> System Display.

**Benefits** TGC balances the image so that the density of echoes is the same throughout the image.

### Adjusting Touch TGC with B-Mode Image Overlay

You can adjust the TGC by overlaying the TGC slidepots over the B-Mode image on the Touch Panel (1), or via the Touch Panel TGC slide pots (2).

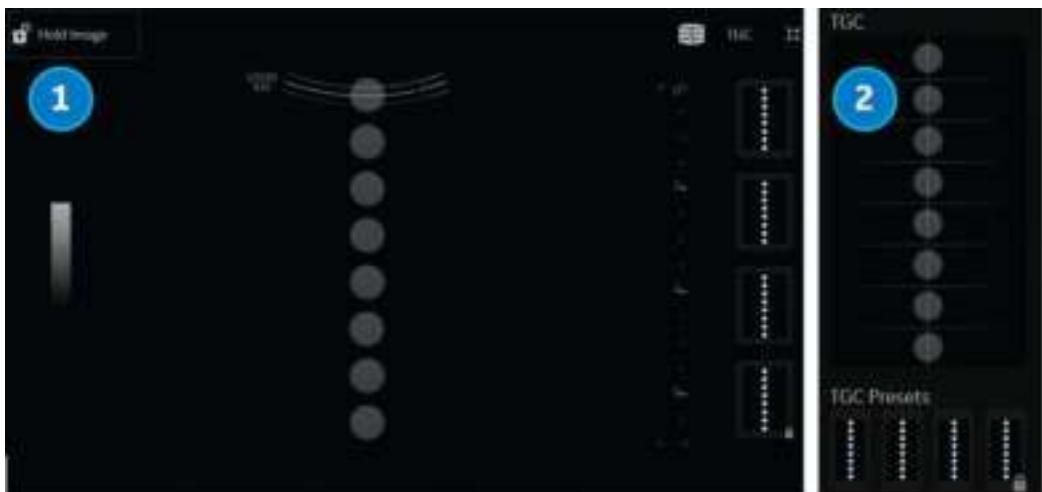

Figure 5-9. Adjusting the TGC



## Touch TGC (continued)

### Adjusting TGC with the B-Mode Image Overlay



To adjust the TGC interactively with the B-Mode image overlay,

1. Press the TGC control, located in the upper, right-hand corner of the B-Mode Touch Panel. TGC “slidepots” appear over the B-Mode image.

Pressing the bottom, right rotary or bottom, right corner of the Touch Panel also enters Touch TGC and adjusts the image.

2. Adjust these slidepots by sliding each slidepot on the Touch Panel with your finger.



#### HINTS

To hold the B-Mode image while adjusting the TGC, select the Hold Image lock located in the upper left-hand corner of the Touch Panel. The Hold Image lock overrides the Utility screen Auto Hide delay timer and hides the TGC slidepots, allowing unobstructed view of the image on the Touch Panel.

When Hold Image is active (or the Auto Hide delay timer is set to Off on the Utility screen), the Full Image button appears. Select the Full Image button to toggle between active B-Mode and the full image area.

NOTE: Though the B-Mode image is locked, you can still adjust the TGC curve while the image lock is active.

3. To save this TGC setting as a preset, press and hold the box on the right until the box displays a blue outline. This TGC setting now appears in the “Custom” window.
4. To reset to the default setting, touch the TGC Presets preset at the bottom of the TGC display on the Touch Panel.

NOTE: *Timeout for TGC display can be set in Utilities --> System ==> General.*

### Adjusting TGC using the Touch Panel

You can also adjust the TGC or select a TGC preset directly on the Touch Panel.

1. Adjust these slidepots by sliding each slidepot on the Touch Panel with your finger; or select TGC preset.
2. To save a TGC setting as a preset, press and hold an available TGC preset box on the bottom of the Touch Panel until the box displays a blue outline.

## **Speed of Sound (SoS) Tissue Imaging**

Speed of Sound is available on all probes for the following applications: Abdomen, AbdDetail, Abdomen 2, Renal, Bowel, and Breast. The Speed of Sound control is displayed only for these applications and are hidden in all other applications, even when research mode is enabled.

*NOTE: Speed of Sound displays on the monitor display as “SoS” with the speed following, “SoS 1500” (when the speed of sound is not equal to 1540).*

A control has been added on the Touch Panel to change the transmitted speed of sound for various breast tissue types:

To activate Speed of Sound for Breast, for example,

1. Select Probe --> Small Parts--> Breast--> B-Mode--> Speed of Sound.
2. Press Speed of Sound on the Touch Panel. Speed of Sound selections appear at the bottom of the Touch Panel in place of the Focus Position control.
3. Adjust the Speed of Sound control up/down to achieve the desired image. The system displays the Speed of Sound (SoS) on the Touch Panel in the upper, right-hand corner of the display as “SoS #####”.

SoS settings are returned to the default for an SoS of 1540 (or when the SoS is not displayed on the display).

## Minimizing Grating Lobe/Side Lobe Artifacts

### Overview

Grating lobes/side lobes often create a spurious structure or clouding within an ultrasound image. Such artifacts are not uncommon in gray scale 2D imaging mode. They are caused by an undesired off-axis ultrasound beam contaminating the main beam.

The ultrasound system presumes that the reflections returning to the transducer always come from the steered direction. However, when these (weaker) off-axis beams encounter a strong specular reflector, the returning reflected energy will be received and "added" to the main beam.

Grating lobe/side lobe artifacts can be especially noticeable within anechoic regions (i.e. fluid, cysts, heart chamber, large blood vessels, etc.).

### Corrective Adjustments

On the LOGIQ Totus, if grating lobe/side lobe artifacts are suspected during the scan, adjustments can be made to reduce such artifacts.

1. Adjust scan window
2. Reduce CrossXBeam Angle
3. Decrease AO

For example, on C3-10-D probe, at default setting for NeoHead, grating lobe/side lobe artifacts are present in Figure 5-10.

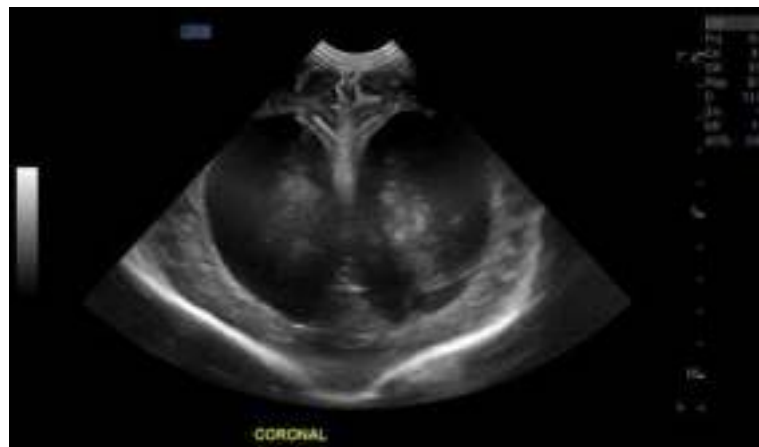

Figure 5-10. Image with Grating Lobe Artifact

**Corrective Adjustments (continued)**

To correct, reduce the CrossXBeam Angle and decrease the AO from 100% to 90%. The grating lobe/side lobe artifacts are removed as shown in Figure 5-11.

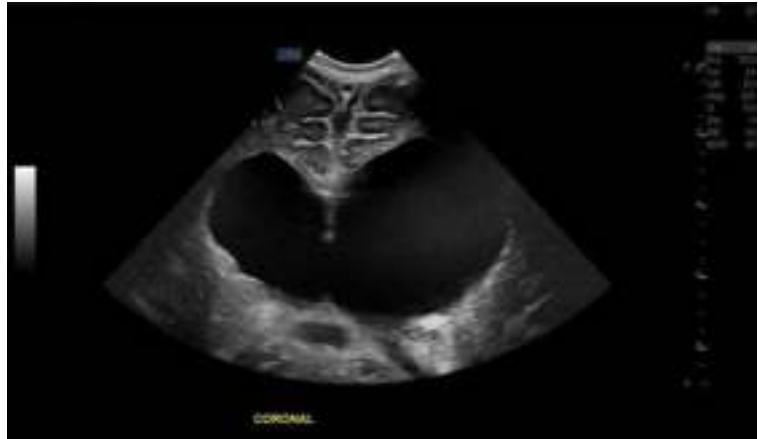

Figure 5-11. Image with Grating Lobe Artifact Removed

# Optimizing M-Mode

## Intended Use

M-Mode is intended to provide a display format and measurement capability that represents tissue displacement (motion) occurring over time along a single vector.

## Introduction

M-Mode is used to determine patterns of motion for objects within the ultrasound beam. The most common use is for viewing motion patterns of the heart.

LOGIQ Totus has three types of M-Mode:

- Conventional M-Mode: displays a distance/time plot of a cursor line in the axial plane of the 2D-image. Conventional M-Mode can be combined with Color Mode.
- Anatomical M-Mode (AMM)
- Curved Anatomical M-Mode (CAMM)

## M-Mode Display



Figure 5-12. M-Mode Display

## Typical exam protocol

A typical examination using M-Mode might proceed as follows:

1. Get a good B-Mode image. Survey the anatomy and place the area of interest near the center of the B-Mode image.
2. Press **Mode Cursor**.
3. Trackball to position the mode cursor over the area that you want to display in M-Mode.
4. Press M-Mode.
5. Adjust the Sweep Speed, TGC, Gain, Power Output, as needed.
6. Press **Freeze** to stop the M trace.
7. Record the trace to disk or to the hard copy device.
8. Press **Freeze** to continue imaging.
9. To exit, press M-Mode.

## M-Mode Controls

*NOTE: You can set default value of each parameter by probe and application on the Utility --> Imaging page. See 'Imaging Presets' on page 10-30 for more information.*

Table 5-3: M-Mode Controls

Control	Adjusts Acoustic Output	Description/Benefit
Sweep Speed	No	To increase/decrease, select <b>Sweep Speed</b> . Changes the speed at which the timeline is swept. Available in M-Mode, Doppler Mode and M Color Flow Mode. You can speed up or slow down the timeline to see more or fewer occurrences over time.

## Anatomical M-Mode (AMM) and Anatomical Color M-Mode (ACMM)

### Description

Anatomical M-Mode gives you the ability to manipulate the cursor at different angles and positions. The M-Mode display changes according to the position of the cursor.

Anatomical M-Mode displays a distance/time plot from a cursor line, which is independent from the axial plane. AMM is available in B, Color and TVI.

**NOTE:** To set up AMM, go to Utility--> Imaging--> AMM. Select the specific probe and parameters.

**NOTE:** Turn off CrossXBeam before activating AMM/CAMM.



Figure 5-13. Anatomical M Mode

### Activating

To activate Anatomical M-Mode, while in M-Mode, press the **Anatomical M** Touch Panel control.

**NOTE:** AMM is not available on Linear probes.

**NOTE:** Anatomical M-Mode can also be used with previously acquired digitally stored 2D images. More than one heart cycle should be stored if performing M-Mode in post processing.

To activate Anatomical Color M-Mode, after accessing Anatomical M-Mode, activate Color Flow (CF).

### Adjusting

Use Touch Panel Trackball to position the M cursor over the required area of the B-Mode image.

1. Use the trackball (assigned function: Pos) to position the M cursor over the required area of the image.
2. Press the top Trackball key to allow free rotation of the solid arrow line throughout the 2D image (trackball assigned function: Angle).

**NOTE:** Rotate the Touch Panel control to angle the M cursor at a given angle.

## Anatomical M-Mode (AMM) and Anatomical Color M-Mode (ACMM)

(continued)

**Benefits** Color Flow Mode and Color M-Mode are Doppler Modes intended to add color-coded qualitative information concerning the relative velocity and direction of fluid motion within the B-Mode or M-Mode image.

**Bioeffects** Changing the Packet Size, Scale, and ROI size may change the TI and/or MI. Observe the output display for possible effects.

## Curved Anatomical M-Mode (CAMM)

Curved Anatomical M-Mode (CAMM) displays a distance/time plot from a free-drawn cursor line. CAMM is available in B, CF and TVI.

1. Select **Curved AMM** on the Touch Panel.
2. Use the Trackball to position the start point of the time motion curve in the B-Mode image.
3. Press **Set** to fix the start point.
4. Use the Trackball to position the next point.  
The time motion curve is drawn by the green line.
5. Press **Set** to fix the point.
6. Repeat step 4 and 5 to draw a complete time motion curve.

**NOTE:** *The time motion curve can be edited by following the curve back to the desired point and redrawn as desired. Following the curve back to the starting point will delete the time motion curve.*

7. Press **Set** twice to complete.

**NOTE:** *Move the cursor to the desired anchor point and press **Set**. Move the point to the desired position and press **Set**.*

8. The arrow cursor appears on the M-Mode image and the red bar appears on the time motion curve.

The red bar indicates the position of the time motion curve relative to the arrow cursor on the CAMM image. They move relative to one another.

**NOTE:** *Press **Set** to clear a cursor line.*

**NOTE:** *Curved Anatomical M-Mode can also be used with previously acquired digitally stored B-Mode images.*

**NOTE:** *CAMM is not available on Linear probes.*



# Optimizing Color Flow

## Intended Use



### WARNING

Color Flow Doppler is intended for qualitative studies only.

Color Flow Mode is a Doppler Mode intended to add color-coded qualitative information concerning the relative velocity and direction of fluid motion within the B-Mode image.

Information regarding the flow velocity and direction is color-coded and rendered onto a BMode image. Flow that travels away from the transducer (negative Doppler shift) is depicted in blue, and flow that is traveling toward the transducer (positive Doppler shift) is depicted in red (colors are user-definable), with lighter shades of each color denoting higher velocities.

## Introduction

A typical examination using Color Flow Mode,

1. Follow the same procedure as described under B-Mode to locate the anatomical area of interest.
2. After optimizing the B-Mode image, add Color Flow.
3. Move the color flow area of interest as close to the center of the image as possible.
4. Optimize the color flow parameters so that a high frame rate can be achieved and appropriate flow velocities are visualized.
5. Press **Freeze** to hold the image in memory.
6. Record color flow images as necessary.
7. If more definitive information is needed about flow, utilize the procedures described under Doppler Mode.

### NOTE:

*Use all noise reduction controls with care. Excessive application may obscure low level diagnostic information.*

8. To exit Color Flow, press **CF**-Mode or **B**-Mode.

*NOTE: Most parameters are user presettable by probe and application in the preset menu (Utility -> Imaging -> CF).*

## Activating Color Flow

Color Flow is useful to see flow in a broad area. Color Flow allows visualization of flow in the CF ROI, whereas Doppler Mode provides spectral information in a smaller area.

Color Flow is also sometimes used as a stepping stone to Doppler. You use Color Flow to locate flow and vessels prior to activating Doppler.

## Color Flow Mode Controls

Color Flow Mode and Color M-Mode are Doppler Modes intended to add color-coded qualitative information concerning the relative velocity and direction of fluid motion within the B-Mode or M-Mode image.

Table 5-4: Color Flow Mode Controls

Control	Adjusts Acoustic Output	Description/Benefit
Flow Selection	No	In the Lower Extremity Vein (LEV) and Abdominal applications, you can quickly select the flow state via a shortcut on the Color Flow Mode Touch Panel menu.
Gain	No	Gain amplifies the overall strength of echoes processed in the Color Flow window or spectral Doppler timeline. Allows you to control the amount of color within a vessel or to fill in or clean out spectral information.
Scale (Velocity Scale)	Yes	To raise/lower the velocity scale, adjust <b>Scale</b> . Increases/decreases the Scale on the color bar. Imaging of higher velocity flow requires increased scale values to avoid aliasing.
Wall Filter	No	Filters out low flow velocity signals. It helps get rid of motion artifacts caused from breathing and other patient motion. Gets rid of excess, unnecessary low frequency signals caused by motion.
Size/Position of the color window	No	Adjust size and position of the color window. To adjust the size, press the top trackball key to select <b>Size</b> then move the Trackball left/right, up/down. To adjust the position, press the top trackball key to select <b>Pos</b> then move the <b>Trackball</b> to position the color window. Increase the color window to see a larger area; decrease the color window to improve frame rate and spatial resolution.
Invert (Color Invert)	No	To reverse the color flow, press <b>Invert (Color Invert)</b> . Lets you view blood flow from a different perspective, e.g., red away (negative velocities) and blue toward (positive velocities). You can invert a real-time or frozen image. <i>NOTE: Invert reverses the color map, NOT the color Scale.</i>

Table 5-4: Color Flow Mode Controls (Continued)

Control	Adjusts Acoustic Output	Description/Benefit
Baseline	No	<p>To adjust the baseline, adjust <b>Baseline</b> up/down, as necessary. Changes the Color Flow or Doppler spectrum baseline to accommodate higher velocity blood flow. Minimizes aliasing by displaying a greater range of forward flow with respect to reverse flow, or vice versa.</p> <p>Baseline adjusts the alias point. The default baseline is at the midpoint of the color display and at the midpoint of the color bar reference display.</p>
Angle Steer	Yes	<p>To slant the linear image to the left/right, adjust <b>Angle Steer</b>. You can slant the ROI of the Color Flow linear image left or right to get more information without moving the probe. The Angle Steer function only applies to linear probes.</p> <p>Provides a Doppler cursor angle suitable for linear probe orientation. Beneficial in Peripheral Vascular to image carotids.</p>
Accumulation	No	<p>Accumulation enhances the flow in an image. Accumulation detects the maximum signal and holds it for the level specified.</p> <p>Note: If Accumulation is turned off, then Frame Averaging is used.</p>
Color Flow Line Density	Yes	<p>Optimizes the Color Flow frame rate or spatial resolution for the best possible color image.</p> <p>Low line density is useful in fetal heartbeat, adult cardiac applications, and clinical Radiology applications which require significantly higher frame rates. High resolution is useful in situations where very small vessels are being imaged, e.g., thyroid, testicles.</p>
Map	No	<p>Allows you to select a specific color map. After you have made your selection, the color bar displays the resultant map.</p> <p>Shows the direction of the flow and highlights the higher velocity flows.</p> <p>Velocity Maps (V). Flow shown as blue away/red toward the probe.</p> <p>Velocity Variance Maps (VV). Provides a measure of turbulence (stenosis). Adds green to velocity maps.</p>
Map Compress	No	<p>When you increase the value, high velocity elements in the map are compressed so that the map darkens. When you decrease the value, low velocity elements in the map are compressed so that the map lightens. The effect is visible in the color bar.</p>
Radiantflow	No	<p>Radiantflow provides an easy, fast visualization of tiny vessels, displaying as a 3D effect.</p>
Threshold	No	<p>Threshold assigns the gray scale level at which color information stops.</p> <p>Limits color flow overlay to low level echoes inside vessel walls. Helps minimize color 'bleeding' outside vessel walls.</p>
Frame Average	No	<p>Averages color frames.</p> <p>Higher frame averaging keeps the color displayed longer for increased flow visualization while lower frame averaging provides greater flow dynamics.</p>

Table 5-4: Color Flow Mode Controls (Continued)

Control	Adjusts Acoustic Output	Description/Benefit
Transparency Map	No	Brings out the tissue behind the color map. Helps demonstrate the tissues behind the color.
Spatial Filter	No	Smooths out the color, makes it look less pixelated.
Flash Suppression	No	Activates/deactivates Flash Suppression, a motion artifact elimination process. Beneficial to suppress flash.
Packet Size	Yes	Controls the number of samples gathered for a single color flow vector. Allows you to improve the color sensitivity and accuracy of color averaging (increase packet size) or frame rate (decrease packet size), as needed.
Power Doppler Imaging (PDI)	No	See 'Power Doppler Imaging (PDI)' on <i>page 5-44 for more information.</i>

## Radiantflow



### CAUTION

Radiantflow is a display method which uses the amplitude of the Color flow signal. Note that this may alter the appearance of the Ultrasound information displayed. For diagnostic purposes, this must be taken into account or the Region of Interest must be checked without Radiantflow.

Radiantflow is a rendering technique for Color Flow and Power Doppler Imaging, available on all probes. Radiantflow provides an easy, fast visualization of tiny vessels, displaying as a 3D effect. Press Radiantflow on the Color Flow Touch Panel and select the amount of power signal gradient.

- Off. - Normal Color Flow/Power Doppler Imaging.
- Min. - Less gradient.
- Mid. - More gradient.
- Max. - Most gradient.



Figure 5-14. Radiantflow Map

## Flow Model Shortcuts

Flow Model Shortcuts values vary by application. You can configure these Shortcuts on the Utility--> Imaging--> CF. Below is an example of the Renal Flow Model Shortcuts and the following table lists all the following Flow Model Shortcuts by application.



Figure 5-15. Application Flow Model Shortcuts

**Flow Model Shortcuts (continued)**

Table 5-5: Flow Model Shortcuts

<b>Application</b>	<b>Flow Model Shortcuts</b>			
ABD, ABD Biopsy	Aorta	Slow Flow (Renal)	Fast Flow (Renal Art)	Penetration
Renal	Aorta	Twinkle	Fast Flow (Renal Art)	Penetration
OB1, OB23	Fetal Echo	Ovary		
PedAbd	Slow Flow (Renal)		Twinkle	Penetration
NeoHead	Slow Flow			Penetration
NeoAbd	Slow Flow (Renal)			Penetration
Cardiac (Adult, Pediatric)	Fast Frame Rate	Penetration	Slow Flow	
Scrotal	Slow Flow			
Thyroid	Slow Flow	Med Flow	Carotid	
Breast, MskGen	Slow Flow	Med Flow	Fast Flow	Penetration
MskSup	Slow Flow	Med Flow	Fast Flow	Rheuma
LEV	Slow Flow	Fast Flow		
UEV	Slow Flow			
Carotid	Vascular Surgery	Vertebral Arterial (Vert.Art.)		
UEA	Vascular Surgery	Slow Flow		
GYN	Ovary			



## Editing Flow Model Shortcuts

1. Via Utility--> Imaging--> CF, highlight the Flow Model line you want to add/update.



Figure 5-16. Setting up Flow Models

2. Type the Flow Model name in the **Name** field. The Flow Model is updated as you type.
3. Update Delta Gain (increases/decreases Displayed Gain by the dB selected here), Velocity, Line Density, CF/PDI Frequency for this Flow Model.
4. Set Default Flow Model.
5. Press Save, then Exit.

The updated Flow Model is located in the designed position on the Color Flow Touch Panel.

**NOTE:** *Users can free type custom flow shortcuts into the Scan Assistant Creator to use them within Scan Assistant.*

### Power Doppler Imaging (PDI)

**Description** Power Doppler Imaging (PDI) is a color flow mapping technique used to map the strength of the Doppler signal coming from the flow rather than the frequency shift of the signal. Using this technique, the ultrasound system plots color flow based on the number of reflectors that are moving, regardless of their velocity. PDI does not map velocity, therefore it is not subject to aliasing. A sub-mode of PDI has been optimized for visualization of small slow flow vessels, called Micro Vascular Imaging (MVI).

**Adjusting** Press **PDI**. The color flow window appears over the B-Mode image. Move the Trackball to move the CF window. To exit, press **PDI** or select a new mode.

*NOTE: Most parameters are user presettable by probe and application in the preset menu (Utility -> Imaging -> PDI).*

**Values** On/Off.

Twelve power and four directional PDI maps are available.

**Benefits** Since PDI does not display velocity, it does not alias.

**Affect on other controls** When PDI is activated, the following controls are adjusted: Color Map is set to a power map. Line Density is adjusted. Threshold is set to 100%. Frame Averaging is adjusted. Packet Size is adjusted.

*NOTE: These controls are reset to their previous values upon exiting PDI.*



#### HINTS

When changing maps, higher gain settings may be needed.

## Power Doppler Imaging (PDI) (continued)

Table 5-6: Power Doppler Imaging Controls

Control	Adjusts Acoustic Output	Description/ Benefit
Map	No	<p>Allows you to select a specific color map. After you have made your selection, the color bar displays the resultant map. Shows the direction of the flow and highlights the higher velocity flows. Power Maps. Assortment of Black/White, Pink, Blue, Yellow, Red, or B-Flow Maps.</p> <p>Directional Maps. Directional Power Doppler Maps from PDI. Note: If the image is aliasing while in Directional MVI Maps, increase the Scale.</p> <p>You can set the default map by probe via Utility -&gt; Imaging -&gt; MVI -&gt; Default Map.</p>
Background	No	<p>Displays the amount of background image shown on the MVI image. Use the Background control to display an appropriate amount of tissue background including plaque.</p> <ul style="list-style-type: none"> <li>• 0=Least amount of image displayed</li> <li>• 6=Most amount of image displayed</li> </ul>

## Presets

You can set the default PDI imaging mode via Utility -> Imaging -> General -> Default PDI:



Figure 5-17. Set Default PDI

### **Micro Vascular Imaging (MVI)**

Smaller vessels can be imaged using Micro Vascular Imaging (MVI), which is a sub-mode of PDI optimized for visualization of small, slow flow vessels. It's available on the C1-6-D, C1-6VN-D, 9L-D, L3-12-D, ML6-15-D and L6-24-D probes. MVI is used to detect and visualize micro-vasculature by providing higher sensitivity and higher spatial resolution.

### **Activating MVI**

Refer to 'System/User Configurable Key' on *page 10-26*.

## Directional Power Doppler

You can select the DPO 0, 1, 2, and 3 Directional Power Doppler maps while in PDI.

**NOTE:** *If you store a PDI image and recall it, you can still switch to the Directional Power Doppler map and vice versa. However, an image stored as non-directional then switched to directional just adds direction to a non-directional map and vice versa.*



### HINTS

If the image is aliasing while in Directional Power Doppler, increase the Scale.

# Optimizing M Color Flow

## M Color Flow Mode

<b>Description</b>	<p>M Color Flow is used for cardiac applications. There is a cursor on the B-Mode image that determines the extent of the Color.</p> <p>The Color Flow maps available in M-Mode are the same as in Color Flow Mode. The size and position of the Color Flow window in B-Mode determines the size and position of the Color Flow window in M-Mode.</p> <p>All M-Mode measurements are available with M Color Flow active: depth, distance along a straight line, % stenosis, volume, trace, circumference, enclosed area, distance, time, slope, and heart rate.</p>
<b>Activating</b>	<p>To activate M Color Flow Mode, press <b>M</b> (M-Mode). Then press <b>CF</b> (Color Flow) - or - press <b>CF</b>, then press <b>M</b>.</p> <p>To toggle between M Color Flow controls and Color Flow controls, press the appropriate Touch Panel Mode tab.</p>
<b>Benefits</b>	<p>Color Flow Mode and Color M-Mode are Doppler Modes intended to add color-coded qualitative information concerning the relative velocity and direction of fluid motion within the B-Mode or M-Mode image.</p>
<b>Bioeffects</b>	<p>Changing the Sweep Speed, Packet Size, Frame Rate/Resolution, Zoom, PRF, and ROI size may change the TI and/or MI. Observe the output display for possible effects.</p>

# Optimizing Spectral Doppler

## Intended Use

Doppler is intended to provide measurement data concerning the velocity of moving tissues and fluids. PW Doppler lets you examine blood flow data selectively from a small region called the sample volume.

## Typical Use - PW Doppler

In Pulsed Wave Doppler (PW) Mode, energy is transmitted from the ultrasound probe into the patient, as in B-Mode. However, the received echoes are processed to extract the difference in frequency between the transmitted and received signals. Differences in frequencies can be caused by moving objects in the path of the ultrasound signal, such as moving blood cells. The resultant signals are presented audibly through the system speakers and graphically on the system display. The X axis of the graph represents time while the Y axis represents the shift in frequency. The Y axis can also be calibrated to represent velocity in either a forward or reverse direction.

PW Doppler is typically used for displaying the speed, direction, and spectral content of blood flow at selected anatomical sites. PW Doppler operates in two different modes: conventional PW and High Pulse Repetition Frequency (HPRF).

PW Doppler can be combined with B-Mode for rapidly selecting the anatomical site for PW Doppler examination. The site where PW Doppler data is derived appears graphically on the B-Mode image (Sample Volume Gate). The sample volume gate can be moved anywhere within the B-Mode image.

### Typical exam protocol

A typical examination using PW Doppler Mode might proceed as follows:

1. Locate the anatomy to be examined. Get a good B Mode image. Press CF to help locate the vessel you wish to examine.
2. Press **Mode Cursor** to display the sample volume cursor and gate.  
or  
Press **PW**. The PW Doppler spectrum appears and the system operates in combined B+Doppler Mode. Adjust **Volume** to adjust Doppler audio. The Doppler signal is heard through the speakers.
3. Position the sample volume cursor by moving the **Trackball** left and right. Position the sample volume gate by moving the **Trackball** up and down. Size the gate by clicking **SV Length**.
4. Optimize the PW Doppler spectrum, as necessary. Refer to the *Doppler Optimization* section of this chapter for more information.
5. Press **Update** to toggle between real time B-Mode with Doppler Mode (with audio).
6. Sample along the whole length of the vessel. Make sure that the probe is parallel to flow. Listen, then look, when positioning the sample volume cursor.
7. Press **Freeze** to hold the trace in memory and stop imaging. Activate CINE Timeline, as necessary. See 'Using CINE' on page 6-3 for more information.
8. Perform measurements and calculations, as necessary. Refer to the Measurements and Calculations chapter for more information.
9. Record results by pressing the appropriate print key, depending on the setup of your recording devices.
10. Press **Freeze** to resume imaging.
11. Repeat the above procedure until all relevant flow sites have been examined.



## **Spectral Doppler Display**

Time zero (the start of the trace) appears on the left side of the graph. As time progresses, the trace moves to the right. The baseline of the graph (representing zero velocity, zero frequency shift, or no detected flow), appears as a solid line running horizontally across the display. By convention, movement toward the probe is positive and movement away from the probe is negative. Positive frequencies or velocities appear above the baseline. Negative frequencies or velocities appear below the baseline.

Typically, blood flow is not uniform but is composed of a mix of blood cells moving at different velocities and in different directions. Thus, the display is composed of a spectrum as gray scale values. Strong signals are displayed as bright while weak signals are displayed as varying shades of gray.

HPRF (High Pulse Repetition Frequency) is invoked when you are operating in PW Doppler Mode and conditions activate HPRF (when the velocity scale factor or sample volume gate depth exceeds certain limits). When HPRF is active, multiple sample volume gates appear along the Doppler mode cursor. Doppler information can be received from any of the multiple sample volume gates. The Doppler signals from all the gates are added together and displayed in one spectrum.

Information about the PW Doppler display is automatically written on the screen and updated when scanning parameters are changed.

This chapter includes:

- A discussion of PW Doppler.
- Activating Pulsed Wave Doppler.
- Optimizing the Doppler spectrum.

## PW Doppler Mode Display

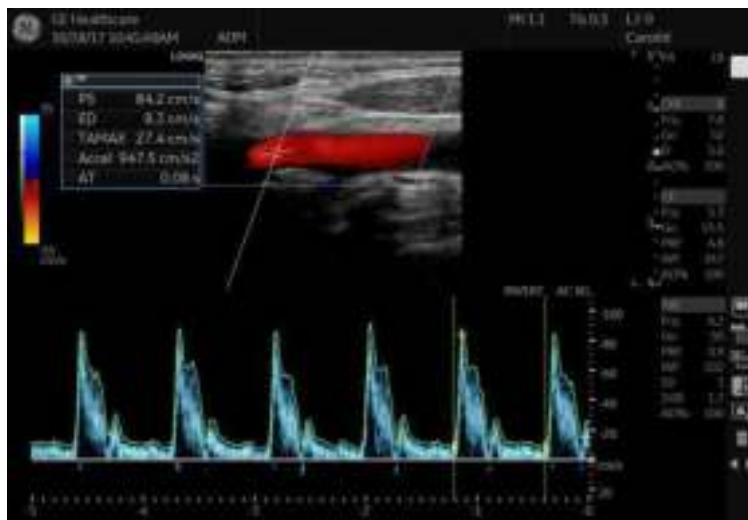

Figure 5-18. PW Doppler Mode Display

Table 5-7: Doppler Mode Display Explanations

Doppler Display	Description, Format, Values
Scale	Velocity Scale, displayed as PRF in kHz.
Wall Filter	Wall filter size, displayed as WF in Hz.
Doppler Gain*	Displays as GN in decibels (dB).
Sample Volume Depth	Displays (in Cm) when Doppler cursor is present.
Doppler Angle (AC ##)	Indicates angle in degrees between the Doppler mode cursor and the angle correction indicator. Displays when Doppler cursor is present. The Doppler Angle displays in red when the angle exceeds 60°. Velocities obtained when the angle is greater than 80° are displayed as asterisks (**).
Spectral Invert	INVERT appears when the spectral trace is inverted and the plus/minus signs (+/-) are reversed.
HPRF	HPRF mode is used when detected velocities exceed the processing capabilities of the currently selected PW Doppler scale or when the selected anatomical site is too deep for the selected PW Doppler scale.
Time Scale	Each selection represents a different sweep time.
Angle Correct	Indicates flow direction.
Sample Volume Gate	Indicates sample volume box. Each probe defaults to a specific range gate.
Doppler Velocity Scale	Flow direction has a positive and negative indicator, noted in centimeters per second (cm/sec). When the velocity scale is less than 10 cm/s, it is displayed to the first decimal point (4.6 rather than 5 cm/s). The Doppler velocity scale adjust as you adjust the Scale.

## Doppler Mode Controls

**NOTE:** You can set the default value of each parameter by probe and application on the Utility --> Imaging page. See 'Imaging Presets' on page 10-30 for more information.

Table 5-8: Doppler Mode Controls

Control	Adjusts Acoustic Output	Description/Benefit
Doppler Sample Volume Gate Position (Trackball)	Yes	To move sample volume gate position, press the top trackball key to select <b>Pos</b> , move <b>Trackball</b> up or down until positioned inside the vessel. Moves the sample volume gate on the B-Mode's Doppler Mode cursor. The gate is positioned over a specific position within the vessel. Positions the sample volume gate to sample blood flow.
Doppler sample volume length (SV Length)	Yes	To increase/decrease the gate size, adjust <b>SV Length</b> on the Touch Panel. Hold down key to continuously size gate. Sizes the sample volume gate. A smaller gate produces accurate sampling results because it is more sensitive. You can also enlarge the gate for sampling large vessels or areas.
Angle Correct/Auto Angle	No	To adjust the angle relative to the probe face, adjust <b>Angle Correct</b> to the left/right. The velocity scale changes when you adjust angle correct. Press <b>Angle Correct</b> to access <b>Auto Angle</b> . Estimates the flow velocity in a direction at an angle to the Doppler vector by computing the angle between the Doppler vector and the flow to be measured. Optimizes the accuracy of the flow velocity. This is especially useful in vascular applications where you need to measure velocity. <i>NOTE: When the Doppler Mode Cursor and angle correct indicator are aligned (the angle is 0), you cannot see the angle correct indicator.</i>
Quick Angle	No	Quickly adjusts the angle by 60 degrees. Press <b>Quick Angle</b> to toggle between Off, Right and Left.
Steer and Fine Steer	Yes	To slant the linear image to the left/right, adjust <b>Steer</b> to the left or right. Press <b>Steer</b> to access <b>Fine Steer</b> . You can slant the ROI of the Color Flow linear image left or right to get more information without moving the probe. The angle steer function only applies to linear probes. Provides a Doppler cursor angle suitable for linear probe orientation. Beneficial in Vascular applications.
Audio Volume	No	Controls audio output. An audio representation of the flow within a vessel can be used to evaluate proper probe angle and position.
Cycles to Average	No	The average value over a number of cycles (from 1-5).

Table 5-8: Doppler Mode Controls (Continued)

Control	Adjusts Acoustic Output	Description/Benefit
Display Format	No	Changes the horizontal/vertical layout between B-Mode and M-Mode, or timeline only.
Update	Yes	<p>To activate, press <b>Update</b> to toggle between simultaneous and update. Doppler Mode does not restart each time the image is updated; however, a black bar may appear with a lightning bolt signaling a break in the timeline.</p> <p>Toggles between simultaneous and update presentation while viewing the timeline.</p> <p>Update increases the Spectral Doppler display quality.</p>
Simultaneous (Duplex/Triplex)	Yes	<p>Duplex allows two modes to be active at the same time; Triplex allows three modes to be active at the same time.</p> <ul style="list-style-type: none"> <li>• B + PW or B + CW or B + CF (Duplex)</li> <li>• B + PW + CF (Triplex)</li> </ul> <p>Update pauses the image while keeping the CW / PW timeline active.</p> <p>When Duplex/Triplex is OFF, either the image or timeline is active. Update then switches the active side between the image and the timeline.</p>
Baseline	No	Adjusts the baseline to accommodate faster or slower blood flows to eliminate aliasing.
Compression	No	<p>Compression controls how echo intensities are converted to shades of gray, thereby increasing the range of contrast you can adjust.</p> <p>Optimizes the image's texture and smoothness by increasing or decreasing the amount of gray scale.</p>
Invert	No	<p>Vertically inverts the spectral trace without affecting the baseline position.</p> <p>The plus (+) and minus (-) signs on the velocity scale reverse when the spectrum is inverted.</p> <p>If you change the probe angle to accommodate anatomy, blood flow still moves in the same direction, but the Doppler information will be reversed. It is easier in cases like this to invert the spectrum instead of reversing the probe orientation.</p>
Scale (Velocity Scale)	Yes	<p>To view signal detail, adjust Scale to enlarge the vertical spectral Doppler trace. Velocity range directly controls the pulse repetition frequency, which is responsible for the setting of the Nyquist limit (the ability to detect maximum velocity without aliasing).</p> <p>If the sample volume gate range exceeds single gate Scale capability, the system automatically switches to high PRF mode. Multiple gates appear, and HPRF is indicated on the display.</p>
Trace Method (Spectral Trace)	No	<p>To get a peak trace, click MAX. A green trace displays on the spectrum.</p> <p>To get a mean trace, click MEAN. A blue trace displays on the spectrum.</p> <p>Traces the average mean and peak velocities in realtime or frozen images.</p> <p>Lets you trace the cardiac cycle.</p>

Table 5-8: Doppler Mode Controls (Continued)

Control	Adjusts Acoustic Output	Description/Benefit
Trace Sensitivity	No	Adjust the trace to follow the waveform for signal strength. If the signal is very faint, increasing the Trace Sensitivity will allow the system to trace that signal strength.
Trace Direction	No	Specifies trace direction. You can select where on the waveform to perform the trace, above, below, or both (above and below).
Cursor Moving	No	On Utility--> Imaging, specify No Action, Update 2D/CF-Long, Medium, or Short, or Update Doppler-Slow, Medium, or Fast. Cursor Moving lets you 'walk' Doppler through a vessel while the Doppler gate is moving. Updates are more frequent on Fast vs. Medium vs. Slow. If you set the preset to Update 2D/CF, this causes the B Mode/Color Flow image to go live while you move the Doppler cursor.
Time resolution	No	Adjusts image appearance so that if you select a lower setting, the image appears smoother; if you select a higher setting, the image appears sharper.
Wall Filter	No	To increase/decrease, select <b>Wall Filter</b> on the Touch Panel. Insulates the Doppler signal from excessive noise caused from vessel movement. Gets rid of excess, unnecessary information. Cleans out low level noise above and below the baseline so you don't see or hear it on the spectrum.
Auto (Auto Optimize)	No	To activate, press Right <b>Auto</b> key. Press Left <b>Auto</b> key to turn off Auto. Auto in PW Doppler Mode (ASO: Auto Spectral Optimization) optimizes the spectral data. Auto adjusts the Velocity Scale/PRF (live imaging only), baseline shift, dynamic range, and invert (if preset). "Running Auto Spectral Optimization" appears at the bottom of the monitor upon activation. Upon deactivation, the spectrum is still optimized. See 'Auto Optimize' on <i>page 5-8 for more information</i> .
Mode Cursor	No	Displays the Doppler Mode cursor on the B-Mode image. To activate/deactivate the Doppler Mode cursor, press Mode Cursor. Trackball to position sample volume graphic.
Modify Auto Calcs	No	Activates the menu to select which calculations are automatically calculated.
Auto Calcs	No	Activates the calculation automatically which you select in the Modify Auto Calculation when the system is in a state of freeze or live. <ul style="list-style-type: none"> <li>• Live: Auto calculation activates when the system in a state of live.</li> <li>• Freeze: Auto calculation activates when you press Freeze.</li> <li>• Off</li> </ul>

### Auto Doppler Assist

Auto Doppler Assist automatically positions and steers Color Flow ROI and PW Cursor. This feature is available on all linear probes. Available in Color Flow, Color Flow + PW (Triplex and non-Triplex).

To use Auto Doppler Assist, position the cursor in the Color Flow ROI (the Color Flow ROI has to include the vessel of interest, or part of it). Press the appropriate Touch Panel Auto control (shown below) or press the Auto control to the left for Color Flow or to the right for Pulsed Wave. Manual map the “Auto” controls via Utility--> User Configurable Key.



Figure 5-19. Auto Doppler Assist

Upon pressing the Auto Doppler Assist button, the system will automatically:

- Pick the artery or vein (depending on the selected application).
- Center the Color Flow ROI on the vessel of interest.
- Steer with the direction of the vessel.
- Keeps the Sample Volume in the middle of the ROI.
- Steers the PW Cursor (if existing) to maintain the angle correct set by the operator under Auto Correct on the Utility --> Imaging --> PW --> Angle Correct.

**NOTE:** *If the angle is set to zero, then the system uses 60 degrees.*

# Using 3D

## Overview



### DANGER

DO NOT use the Volume Navigation feature on any patient relying on life-sustaining electronic equipment, such as a pacemaker or defibrillator. Failure to follow this instruction could lead to interference with patient electronic device(s).

Easy 3D is compatible with every 2D transducer using a freehand acquisition to generate a volume dataset.

3D Volume datasets are allowing the navigation in the 3D cube itself and providing access to the 3 different main planes – axial, sagittal and coronal.

There are three 3D Packages:

Table 5-9: 3D Package Options

3D Type	Description	Sensor/No Sensor
Easy 3D	Designed for rendering B Mode and Color Flow Mode images, e.g., Baby Face scans.	No sensor
Advanced 3D	Designed for rendering B Mode and Color Flow Mode images, e.g., vessel trees.	No sensor
Tru3D	Designed for rendering B Mode and Color Flow Mode images, e.g., vessel trees.	Sensor

### 3D Acquisition

#### Acquiring a 3D Scan

To acquire a 3D scan,

1. Optimize the B-Mode image. Ensure even gel coverage.
2. Press the 3D/4D control panel key. Two screens appear.
3. Set appropriate values for Acq Mode and Scan Plane. Also, set the scan distance before scanning.
  - Acquisition mode  
Sensorless Parallel is for all acquisitions done with the linear probes and on regular shapes, where you can move the probe parallel on the skin.  
Sensorless Sweep is for the sweep acquisition using the curved probe (i.e. intercostal liverscan or kidney).
  - Scan Distance  
The Scan Distance is an indicator for the size of the Volume: Have you acquired longer distance than 6 cm, increase the Scan distance. Have you acquired a shorter distance than 6 cm, decrease the Scan distance. For sweep acquisition 6 means a transducer angulation of around 60°.
4. To start acquiring the image, press **Start** (Trackball key).
5. To perform a parallel scan, scan evenly. To perform a sweep (fan) scan, rock the probe once. Note the distance of the scan.
6. The 3D volume of interest (VOI) is dynamically assembled on the right side of the screen.

**NOTE:** *If the image stops before you're done scanning, start acquiring the 3D volume of interest again.*

7. To complete the 3D scan, press **End** (Trackball key).

**NOTE:** *You can also press Freeze, but then you need to also press the 3D key to obtain the final render.*



## **Acquiring a 3D Scan (continued)**

### **3D Notes**

- Adjust the 3D dataset brightness with B-Mode or Color Flow Mode Gain.
- Use Colorize to change the color of the active dataset.
- Use Zoom to increase the zoom factor of the active dataset.
- Vertical lines may be seen in a resliced image. This usually happens when you scan too fast or if the scan distance is set to a high value.

Scan more slowly, adjust the frame rate for a faster rate or adjust the scan distance.

3D Acquisition Parameter Description



Figure 5-20. 3D Acquisition

Table 5-10: 3D Acquisition Description and Instructions for Use

3D Parameter	Description
App (Application) Presets	Selections: None, OB - Baby Face, Vascular, User 1, User 2, User 3 <b>None.</b> No application preset applied. <b>OB - Baby Face.</b> After having scanned in this mode, certain rendering parameters are set automatically. The gray surface mode is activated and the texture mode is switched off. The gray surface mode values for opacity and threshold are set automatically according to the datasets histogram. <b>Vascular.</b> Available only with Advanced 3D or Tru 3D package. After having scanned in this mode, certain rendering parameters are set automatically. The color image is rendered in the texture mode. The values for opacity and threshold of the texture mode are set automatically according to the datasets histogram. The B-Mode image is rendered in the gray surface mode. Opacity and threshold values are defined according to the histogram.
Delete Active User Preset	Select to delete a user preset (User 1, User 2, or User 3).

Table 5-10: 3D Acquisition Description and Instructions for Use (Continued)

3D Parameter	Description
Acquisition Mode	<p>Selections: Sensorless Parallel, Sensorless Sweep</p> <p><b>Sensorless Parallel.</b> In this mode the probe must be moved during 3D data acquisition without angling it. You should scan the object you want to render in 2-4 seconds. The speed at which you scan should be constant. No sensor is mounted on the probe.</p> <ul style="list-style-type: none"> <li>• Since the time for post-processing depends on the acquired number of frames, it is recommended that you check the frame rate. Low frame rates result in fewer acquired frames for the 3D dataset which results in intensive post-processing (interpolation). Therefore, low frame rate = long post-processing.</li> </ul> <p><b>Sensorless Sweep.</b> In this mode the probe must be moved to a position where you can clearly see a middle cut of the object you want to scan and render. Tilt the probe to about 30 degrees until the object you want to scan disappears. Start the acquisition and tilt the probe over a distance of around 60 degrees until the object disappears again. The entire scan time should be around 2-4 seconds. During the sweep, the probe may not be moved parallel, just tilted. No sensor is mounted on the probe.</p> <p>Before starting an acquisition, take care that the transmitter is positioned correctly during data acquisition and that the transmitter cannot move.</p>
Scan Plane	<p>Selections: Front to Back, Side to Side</p> <p><b>Front to Back.</b> After having scanned in this mode, the rendered dataset is shown in a frontal view. For acquiring a fetal face in sagittal cuts, use this mode.</p> <p><b>Side to Side.</b> After having scanned in this mode, the rendered dataset is shown from a side view. For acquiring a fetal face in coronal cuts, use this mode.</p>
Display Format 50/50 Only 2D	<p><b>50/50.</b> Display in Dual Image (2D and 3D).</p> <p><b>Only 2D.</b> Display in Single Image.</p>
3D	Starts the rendering process.
Scan Distance	Adjusts the distance covered during the scan. Depending on the real width of a scan acquired during a sensorless 3D acquisition, the volume of interest's width can be enlarged or reduced. You can adapt the form of a fetal face if the baby's head looks oval instead of round. The assumed default width of a parallel scan is 6 cm; or a fan scan 60 degrees.

**NOTE:** *The selection of user presets is effective only while 3D mode is active. Exiting 3D mode and activating 3D mode again resets the 3D presets to the default setting, regardless if Patient or application changes.*

**NOTE:** *Changing the tab between [Easy] and [Adv3D] changes some parameters that are not common between those tabs.*

**NOTE:** *When a 3D image is recalled, no 3D presets are active and parameters are recalled from the image file.*

**NOTE:** *Default Scan Distance, Opacity and Threshold may not be consistent and may change per scan. After the User Preset is saved and recalled, Opacity and Threshold are consistent.*

## Manipulating the Volume of Interest

Imagine you are able to manipulate the 3D volume of interest (VOI) in your hand. The 3D VOI is a tangible anatomical object that you can see and manipulate easily using the Trackball and Set control panel keys.

Practice positioning the pointer at different places within the 3D VOI. Highlight different colors (white, red, yellow, or green). Press Set to select a VOI for manipulation. Use the hand to manipulate the 3D VOI.

Table 5-11: Manipulating the Volume of Interest

Procedure	Example
<p>Rotating the 3D VOI Left/Right or Forward/Backward                      You can rotate it left to right or right to left. You can rotate it forward/backward. Press right Set key when the white pointer finger is positioned on the white box. Move the closed white hand to manipulate the 3D VOI.</p>	
<p>Moving Through the 3D VOI                      You can move through the 3D VOI using the red hand. Press Set when the red pointer finger is positioned on the red box. Move the closed red hand to move through the 3D VOI.  <i>Note: Any plane in the volume can be made active (highlighted with red box) by clicking on it.</i></p>	

Table 5-11: Manipulating the Volume of Interest (Continued)

Procedure	Example
<p>Viewing Specific Portions of the Anatomy</p> <p>You can pull back tissue to view specific portions of anatomy using the yellow hand. Press Set when the yellow pointer finger is positioned on the yellow box. Move the closed yellow hand to manipulate the 3D VOI.</p> <p><i>Note: This actually moves an edge. A yellow hand appears only when the pointer is on an edge of the VOI.</i></p>	
<p>Pulling Back a Corner of the VOI to View Specific Anatomy</p> <p>You can pull back a corner to view specific portions of anatomy using the green hand. Press Set when the green pointer finger is positioned on the green box. Move the closed green hand to manipulate the 3D VOI.</p>	

## Easy 3D

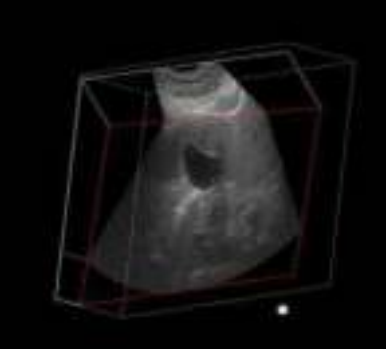
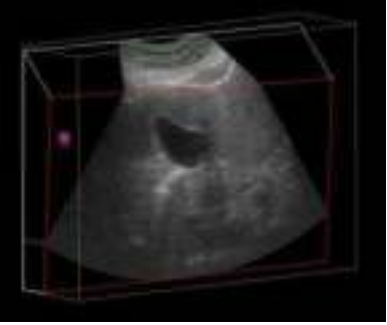
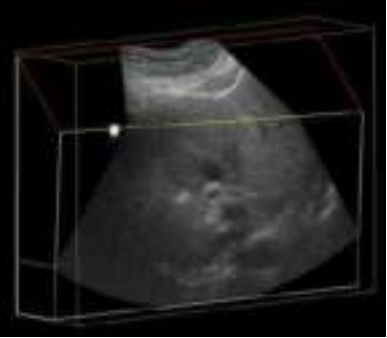
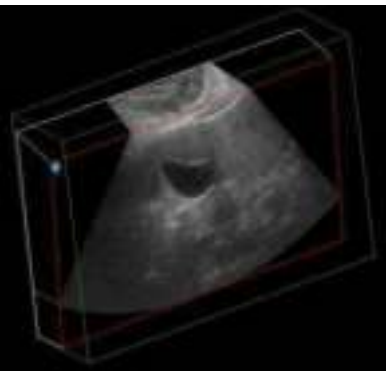
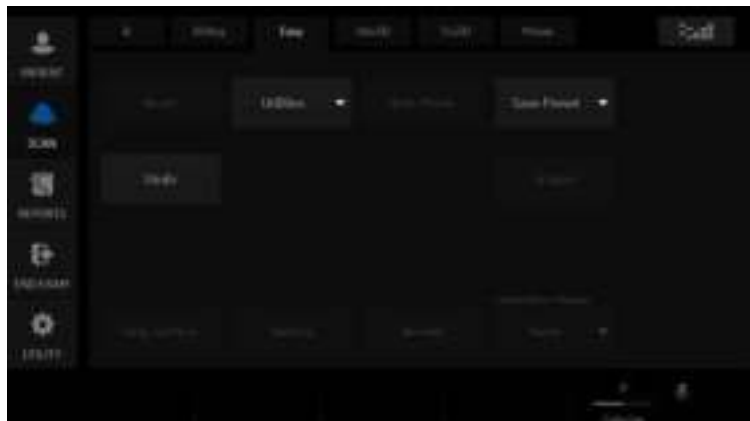

Figure 5-21. Easy 3D

Descriptions and instructions for using Easy 3D follow:

Table 5-12: Easy 3D Description and Instructions for Use

3D Parameter	Description
Reset	Resets the 3D volume of interest back to its original orientation.
Utilities	Select Average Off, Average Light, Average Medium, or Average Strong. Use smoothed volume for rendering the 3D volume. Strong = Most Smoothing.
Auto Movie	Initializes the calculation and display of a 3D movie. A rotation of 30 degrees left and right around the actual image position (either the default position after acquisition or the position that was manually defined by manipulating the 3D volume of interest) is shown. For this 60 degree rotation, eleven images in steps of 6 degrees are calculated.
Save Preset	Save as a user preset (User 1, 2, or 3).
Undo	Undoes any manipulation you have done to your 3D dataset.
Scalpel	Structures, for example a part of the placenta hiding the view to a fetal face, can be cut out in a rendered image. All visible structures can be cut out. The option of 'erase inside' deletes all structures inside the marked region. The option of 'erase outside' deletes all structures outside the marked region. The region in the rendered image is marked with the right Set key. To define the contour of the region, press the right Set key for each vertex. To close the contour, double click the right Set key. As long as a contour is not closed, it can be traced back with the left Set key. The cut out process can be undone by the Undo Last function. As soon as the Apply button is pressed, a new dataset is generated.
Gray Surface	Activates the gray surface rendering mode. It leads to a transparent appearance of the object, generated by displaying only a surrounding shell of structures.

Table 5-12: Easy 3D Description and Instructions for Use (Continued)

3D Parameter	Description
Texture	<p>Activates the texture or photorealistic rendering mode. It creates a photorealistic appearance of the object. The shading depends on the orientation of the surface of the object.</p> <p>If both Texture and Gray Surface mode are switched on, the mixture percentage of both modes can be defined.</p>
Render	<p>Changes between the rendered image view and the view of a volume of interest. The volume of interest shows the acquired ultrasound images transformed into an isotropic rectangular coordinate system. The volume of interest can be manipulated as described above.</p>
Orientation Marker	<p>You can now specify/define, then add the following orientation markers while in 3D via the <b>Orientation Marker</b> key:</p> <ul style="list-style-type: none"> <li>• TRV Sup to Inf</li> <li>• TRV Inf to Sup</li> <li>• SAG Lt to Rt</li> <li>• SAG Rt to Lft</li> <li>• Defined</li> <li>• None</li> </ul>
Threshold/Opacity	<p>Threshold defines which gray values are used for rendering and which are considered noise. Opacity defines how strict Threshold is used for discrimination. A low opacity value creates a firmer appearance of the surface. A high opacity value leads to a transparent appearance of the rendered image.</p>
Scan Distance	<p>Adjusts the distance covered during the scan. Depending on the real width of a scan acquired during a sensorless 3D acquisition, the volume of interest's width can be enlarged or reduced. You can adapt the form of a fetal face if the baby's head looks oval instead of round. The assumed default width of a parallel scan is 6 cm; or a fan scan 60 degrees.</p>
Colorize/Contrast	<p>Colorizes the 3D render or adds contrast to the 3D rendered image.</p>

## Advanced 3D



Figure 5-22. Advanced 3D

Descriptions and instructions for using Advanced 3D follow:

Table 5-13: Advanced 3D Description and Instructions for Use

3D Parameter	Description
Tile	The display can be divided into 1, 2, 4, or 6 windows. Switching to a lower number of windows keeps the images from left to right.
3D Landscape	Shows a combination of 2D slices and a 3D rendered image. After a color acquisition you can combine the 2D B-Mode image slices with a 3D rendered color image. This mode allows stepping through the B-Mode images along a vessel structure. The 2D slice can be moved with the right Set key. The Trackball symbol has to be positioned inside the 2D plane.
Active Data	Manipulations of rendering parameters only have an effect on the data defined as Active Data. After having selected Active Data, a list of data is displayed, Gray Data or Inversion. Choose the data to be manipulated. Active Data is only available when you select both Inversion and Gray Data in Visible Data. <i>NOTE: Inversion Mode is only available for Black-and-White mode.</i>
Visible Data	After selecting Visible Data, a list of data is displayed, Gray Data or Inversion. Choose the data you want to display. For example, if only Inversion is chosen, the B-Mode image is switched off in the rendered image and only inversion mode is displayed.
Define Axis	For certain display and measurement modes (Angular Plane Mode, Angular Volume Measurement Mode), an axis in the volume of interest is required. To define the axis, set the start point by using the Trackball to position one end of the axis and pressing the right Set key, then positioning the other end of the axis and pressing the right Set key.



Table 5-13: Advanced 3D Description and Instructions for Use (Continued)

3D Parameter	Description
Group Planes	<p>Selections: Off, Main, Parallel, Angular</p> <p><b>Off.</b> A VOI or a rendered image is displayed. The Render button changes between the rendered image view and the view of the VOI. The VOI shows the acquired Ultrasound images transformed into an isotropic rectangular coordinate system.</p> <p><b>Main.</b> Three orthogonal cuts (with colored frames) of the acquired VOI are displayed after pressing Main. The VOI shows the acquired ultrasound images transformed into an isotropic rectangular coordinate system. On the left top of the image a complete VOI is displayed. It shows the position of the three orthogonal planes in the VOI. A green point displayed in each plane defines the point of intersection of the three planes. This point can be set to different positions in the planes by double clicking the right Set key. A plane can be moved parallel in the VOI by pressing the right Set key on the position of the green point and moving the Trackball up and down inside the plane.</p> <p><b>Parallel.</b> In this mode all displayed VOIs get the orientation of the last modified volume. Normally four VOIs are displayed. It is possible to display six VOIs by increasing the number of displayed volumes in the Tile area. Between the first and the last VOI, the selected planes are parallel and equidistant. A modification on the plane in one VOI results in a parallel modification of the planes in all other VOIs.</p> <p><b>Angular.</b> Before starting the Long Axis Rotation Mode, make sure that a long axis has correctly been defined in the VOI (see Define Axis above). The function starts in the long axis display mode. In the upper, left-hand corner a short axis cut is shown which gives an overview of the orientation of the long axis planes.</p> <p>To move these planes, press and hold down the right Set key while moving the Trackball.</p>
Type 1/2	<p>Defines the rendering modes. Selections: Gray Surface, Texture, Maximum Intensity, Minimum Intensity, Average Intensity, and None. If both Type 1 and Type 2 rendering modes are switched on, the mixture of both modes can be defined.</p> <p><b>Gray Surface.</b> Activates the gray surface rendering mode. It leads to a opaque appearance of the object, generated by displaying only a surrounding shell of anatomical structures. Adjust Threshold and Opacity as well.</p> <p><b>Texture.</b> Activates the texture of photorealistic rendering mode. It creates a photorealistic appearance of the object. The shading depends on the orientation of the surface of the object. Adjust Threshold and Opacity as well.</p> <p><b>Maximum Intensity.</b> Transparent appearance of the object. Generated by displaying the maximum gray values in the VOI.</p> <p><b>Minimum Intensity.</b> The rendered image is generated by displaying the lowest gray values in the VOI that exceed the defined threshold. Dark anatomical structures, like cysts, can be shown in this mode.</p> <p><b>Average Intensity.</b> Transparent appearance of the object. Generated by a summation of the gray values.</p> <p><b>None for Type 2.</b> No second rendering mode is used in addition to the Type 1 rendering mode.</p>
Render	<p>Changes between the rendered image view and the view of a volume of interest. The volume of interest shows the acquired ultrasound images transformed into an isotropic rectangular coordinate system. The volume of interest can be manipulated as described above.</p>

Table 5-13: Advanced 3D Description and Instructions for Use (Continued)

3D Parameter	Description
Reslice	<p><b>Cube.</b> The VOI shows the acquired ultrasound images transformed into an isotropic rectangular coordinate system. This mode allows you to work simultaneously with six cut planes.</p> <p><b>Virtual Rescan.</b> The marked cut planes under Reslice Cube (red border) is displayed without any perspective distortions, e.g., parallel to the screen. This allows you to move through the volume one slice at a time in any direction.</p> <p><b>Cubic Plane.</b> Only one cut plane view is shown in a perspective displayed VOI. The cut plane can be moved freely without any limitations.</p>

## Movie 3D

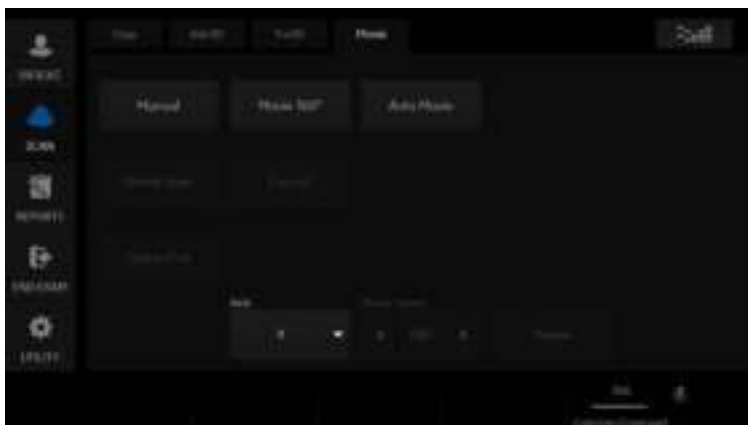

Figure 5-23. Movie 3D

Descriptions and instructions for using Movie 3D follow

Table 5-14: Movie 3D Descriptions and Instructions for Use

3D Parameter	Description
Manual Define Start/End	An animated rotation of the rendered image can be calculated and displayed by this function. Using this function, you first need to define the start and end position of the rotation. To define this, move the VOI to the start position, then press Define Start. Move the VOI to the end position and press Define End.
Movie 360 Degrees	The calculation and display of a complete rotation around the axis, defined by the Axis button, starts in steps of 15 degrees.
Auto Movie	Initializes the calculation and display of a 3D movie. A rotation of 30 degrees left and right around the actual image position (either the default position after acquisition or the position that was manually defined by manipulating the 3D volume of interest) is shown. For this 60 degree rotation, eleven images in steps of 6 degrees are calculated.
Axis	All rotations (Auto Move and Movie 360) are calculated as rotations around the specified axis (X, Y, or Z).
Movie Speed	You can adjust the speed of any 3D rotation.
Pause	Stops and restarts the rotation. As soon as Pause is pressed, the different rotation steps can be displayed by moving the Trackball.

## Tru3D and Volume Measurement



Figure 5-24. Tru3D

Descriptions and instructions for using Tru3D are the same as noted in the Advanced 3D section. See Table 5-13 on page 5-66 for a description of these controls.

### Performing a Sensor Scan

To perform a sensor scan,

1. Attach the sensor cables to the front of the Ultrasound system.
2. Attach the probe bracket to the probe, unless using a VNav Inside (VN) probe.  
Insert the receiver into the bracket on the probe.
3. Position the magnet near the patient, within 18 inches of the probe, next to the patient on the bed.
4. On the Touch Panel, select With Sensor.
5. Acquire the 3D scan.

## Tru3D

Table 5-15: Tru3D Descriptions and Instructions for Use

3D Parameter	Description
Acquisition Mode	<p><b>With Sensor.</b> Only available if you are using the Tru 3D package. In this mode the probe can be moved in different ways over the object you want to render. The probe can be moved parallel and angled during the same 3D acquisition. The sensor system registers any movement. It is recommended not to move in one direction and back again during one scan. It is also not recommended to turn the probe around its axis. The scanning speed does not have to be constant, but you should not change the velocity too much. In this mode the sensor has to be mounted on the probe.</p> <p>Before starting an acquisition, take care that the transmitter is positioned correctly during data acquisition and that the transmitter cannot move. The transmitter has to be placed in such an orientation that the probe with the receiver attached is always in the forward hemisphere of the transmitter during scanning.</p> <p>The patient <b>MAY NOT</b> move during the acquisition.</p> <p>The sensor device consists of an electromagnetic field transmitter and a field receiver. The field transmitter generates an alternating spheric electromagnetic field in a strength of up to five times the earth's magnetic field, depending on the distance between the transmitter and the receiver.</p> <p>For 3D data acquisition, the probe with the attached position sensor can be moved freely in an area of 70 cm around the transmitter.</p> <p>During data acquisition, the electromagnetic sensor device generates with a frequency of about 100 Hz a set of three translation and three angle values. These values describe the position of the ultrasound probe in space.</p>

**Magnetic field range from the transmitter**

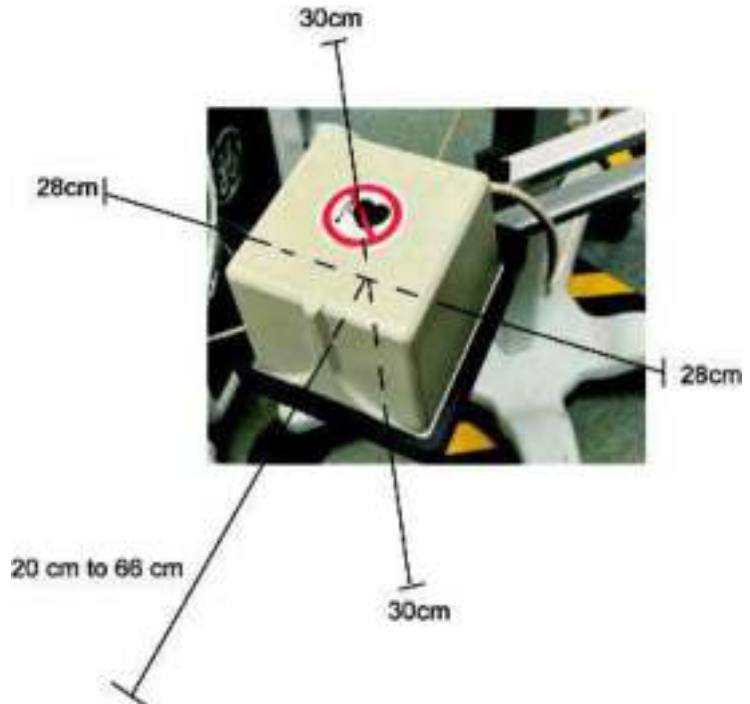

Figure 5-25. Magnetic field range from the transmitter

From the center of the transmitter,

1. 30cm above and below
2. 28cm left and right
3. 20 - 66cm forward

*NOTE: Remove the metal product from the region of the magnetic field to increase accuracy of position detection.*

## Volume Measurement

The average measurement error for distance measurements is 5% and for volume measurements is 10%.

### Workflow example

**NOTE:** *If you print out a Volume Measurement image with a B/W printer or store it onto the Clipboard, change the following presets before performing the Volume Measurement. On the Utility -> Connectivity -> Button preset menu in the Volumes section, choose Volume File Format\* = 2 - Standard DICOM with Raw Data and in the Still Images section, choose Format = Secondary Capture Image.*

1. Scan in 2D-mode. Select Auto Sweep. Acquire and store the image.
2. Recall Image. Activate **3D/4D**.
3. Select **Vol. Meas** Tab. Select **Angular Method**.



Figure 5-26. 3D Volume Measurement

**NOTE:** *Angular method is intended for spherical objects. Serial method is intended for rectangular objects.*

**Volume Measurement (continued)**

4. Define the axis and press **Enter**.
5. Six cut planes are displayed. You measure the volume by marking the contour of the anatomy.
6. When all traces are completed, the system displays the volume in the Results Window.

Measurement examples are shown below:



Figure 5-27. 2D Measurement (Example)



Figure 5-28. Example of Segment Method

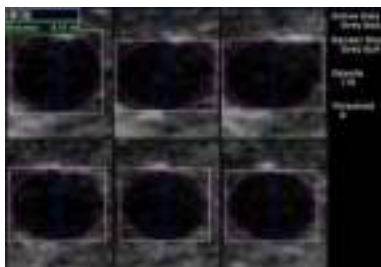

Figure 5-29. Example of Angular Method



## Volume Measurement (continued)

Table 5-16: Volume Measurement Descriptions and Instructions for Use

3D Parameter	Description
2D	<p>Type of 2D measurement: Distance, Angle, Circumference, Area</p> <p><b>Distance.</b> Set the start and end distance using the right Set key.</p> <p><b>Angle.</b> An angle is measured by marking two lines. Press the right Set key once marks the beginning of the first line. Press the right Set key again to mark the end of the first line and simultaneously the beginning of the second line (the intersection of two lines). Press the right Set key a third time to close the angle measurement.</p> <p><b>Circumference.</b> The circumference of an area is measured by marking the contour of the anatomy by a polygon contour. Each point of the polygon is marked by pressing the right Set key. A double click of the right Set key closes the circumference. As long as the contour is not finished, each point can be deleted by a single press of the left Set key.</p> <p><b>Area.</b> An area is measured by marking the contour of the anatomy by a polygon contour. The area of an area is measured by marking the contour of the anatomy by a polygon contour. Each point of the polygon is marked by pressing the right Set key. A freehand contour can be drawn by pressing and holding down the right Set key and moving the Trackball. Double click the right Set key to complete the area. As long as the contour is not finished, each point can be deleted by a single press of the left Set key.</p>
Angular Method	<p>This function allows you to mark any volume of interest in the dataset to measure its volume or to perform a segmentation of the object.</p> <p>The volume of a 3D object is determined by drawing the contour in several planes, which are rotated around an axis defined by the user. The contours are used to calculate the volume of the object.</p> <p>To determine the volume of an object based on the multiplanar Simpson rule, you need to define the rotation axis via Define Axis.</p> <p>When you press Angular Method, six cut planes are displayed. The Long Axis is marked in blue. You measure the volume by marking the contour of the anatomy. The contour can be marked in different ways: Polygon, Spline, Ellipse, Rectangle, or Rotate.</p> <p><b>Polygon.</b> Each point of the polygon is marked with a single press of the right Set key. A freehand contour can be drawn by pressing and holding down the right Set key and moving the Trackball. Double click the right Set key to complete the area. As long as the contour is not finished, each point can be deleted by a single press of the left Set key.</p> <p><b>Curve.</b> An area can be marked by single points positioned by pressing the right Set key. A double click on the right Set key closes the spline. The position of the points defining the contour can be changed by clicking on the point and moving it by pressing the right Set key and using the Trackball. As long as the contour is not finished, each point can be deleted by a single press of the left Set key.</p>

Table 5-16: Volume Measurement Descriptions and Instructions for Use (Continued)

3D Parameter	Description
Angular Method	<p><b>Ellipse.</b> When you select this mode, a circle is displayed. You can move the circle by pressing and holding down the right Set key while moving the circle with the Trackball. Press the right Set key to set the chosen position. To manipulate the shape of the circle, move the edges of the circle while pressing the right Set key.</p> <p><b>Rectangle.</b> When you select this mode, a rectangle is displayed. You can move the rectangle by pressing and holding down the right Set key while moving the rectangle with the Trackball. Press the right Set key to set the chosen position. To manipulate the shape of the rectangle, move the edges of the circle while pressing the right Set key.</p> <p><b>Rotate.</b> Using the rotate function, you can rotate an area around the Z axis. When you select this function, the Trackball symbol changes as soon as it is positioned to an edge of a region. The region can then be rotated by pressing and holding down the right Set key. A region can be selected and deleted by pressing the Clear key. To save a measurement, press Save Segment, Save to Report, or Cancel.</p>
Serial Method	<p>The Serial Method allows you to mark any volume of interest in the dataset to measure its volume or perform a segmentation of the object. A volume definition is done by defining areas at different depths. Before starting the volume measurement, you need to select a plane showing a cut in which the object can be clearly defined. When you press Serial Method, the display window shows two different views. The left side displays the active plane as a single plane. The VOI on the right side is displayed in cubic mode. In the right VOI select the cut plane position where the measurement process should start. In the left plane, mark the object of interest by designating one of the area definition modes (Curve, Ellipse, Rectangle, Polygon, Rotate). After you have completed defining the first area, the depth of the VOI should be changed on the right side. To change the depth, position the Trackball symbol inside the plane to be moved. press and hold down the right Set key while moving the Trackball backwards. By defining the contour of an object at different depths, its volume can be calculated by summing up the defined slices. To save a measurement, press Save Segment, Save to Report, or Cancel.</p>
Define Axis	<p>For certain display and measurement modes (Angular Plane Mode, Angular Volume Measurement Mode), an axis in the volume of interest is required. To define the axis, set the start point by using the Trackball to position one end of the axis and pressing the right Set key, then positioning the other end of the axis and pressing the right Set key.</p>
Save Segment	<p>After measuring a volume, you can use the defined volume for segmentation by pressing Save Segment. Segmentation means that a new dataset is created with voxel information based on the defined volume. A dataset containing only voxels inside the measured volume is created. The original dataset is saved additionally to the segmented data. The segmented data can be chosen in the Active Data or Visible Data list.</p>
Save to Report	<p>After measuring a volume, press Save to Report to register the measurement result in a database that is used for report generation.</p>

---

# Chapter 6

## Scanning/Display Functions

*Describes additional ways in which to adjust the image.*

# Freezing an Image

## Introduction

Freezing a real-time image stops all movement and allows you to measure and print the image.

*NOTE: While the image is frozen, all Power Output is suspended.*

## Freezing an image

To freeze an image,

1. Press **Freeze**. The Freeze key backlight turns blue.

If you are in a mixed mode, both screen formats stop immediately. Deactivating Freeze restarts both modes and places a black bar on the trace to indicate the time discontinuity.

To reactivate the image,

1. Press Freeze again.

*NOTE: Selecting a new probe unfreezes the image*

*NOTE: Deactivating Freeze erases all measurements and calculations from the display (but not from the worksheet).*

Use the Trackball to start CINE after pressing Freeze.

# Using CINE

## Introduction

CINE images are constantly being stored by the system and are available for playback or manual review via CINE.

You can view CINE as a continuous loop via CINE Loop or manually review CINE images frame by frame via the Trackball.

Data in CINE is available until new data is acquired. CINE is stored on the system's memory and can be archived as well.

CINE is useful for focusing on images during a specific part of the heart cycle or to view short segments of a scan session.

## Cine gauge



Figure 6-1. Cine gauge

1. Loop speed
2. Cine gauge
3. Current frame number/total frame number  
The cine gauge indicates which frame you are viewing of the whole loop.
4. Current number of seconds/total number of seconds  
The cine gauge indicates which frame you are viewing of the whole loop.
5. Start frame
6. End frame

## Touch Panel

The following Touch Panel appears:

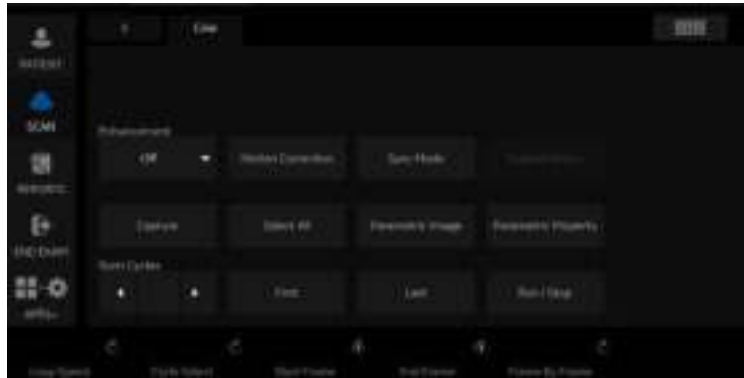

Figure 6-2. Cine Touch Panel

Table 6-1: Cine Touch Panel description

Parameter	Description
Select All	Select all frames of the cineloop.
Sync Mode	Phase synchronizes multiple cineloops.
Num Cycles	Control the number of heart cycles to be included in the cineloop.
First	Move to the first frame of cineloop.
Last	Move to the last frame of cineloop.
Run/Stop	Start/Stop the cineloop review.
Loop Speed	Adjust the cineloop playback speed.
Cycle Select	Select the heart cycle to review.
Start Frame	Rotate the rotary to select the start frame and push to set the frame.
End Frame	Rotate the rotary to select the end frame and push to set the frame.
Frame by Frame	Review the cine image frame by frame manually.
Capture	Searches through all images between the start frame and end frame and displays each peak or the highest velocity/tissue power.
Capture Recon.	Capture Recon. reconstructs small blood vessels in the cine mode.
Enhancement	Execute the enhancement to the Cine capture image. Select Off, Shade FW, Shade Rv, Enhance1, Enhance2 or Enhance3.
Motion Correction	Motion correction compensates each frame and cancels the motion.

## Using CINE

*NOTE: Preset the parameters as necessary.*

1. Press **Freeze**.
2. Move the Trackball to activate Cine.
3. Use the trackball or **Frame by Frame** to scroll through the acquisition and find the sequence of interest.
4. Press **Start Frame** or **End Frame** to set the corresponding cineloop boundary to the current frame as necessary.  
Rotate **Start Frame** and **End Frame** to trim or expand the cineloop boundaries.
5. Adjust **Cycle Select** to move from heart beat to heart beat and select the heart cycle of interest.
6. Adjust **Num cycles** to select the number of heart beats to play back.
7. Press **Run/Stop** to run the cineloop and then press the print key to store the cineloop.  
Cine loops stored on the clipboard are indicated with a movie strip icon.
8. Press **Run/Stop** again to stop the cine loop.
9. Press **Freeze** to return to live scanning.

*NOTE: If you don't need edit, only press Run/Stop to run the cineloop and print key to store.*

*NOTE: Cineloop storage can be configured to store heart cycles with additional time before and after the R-wave and to display a preview before storage. See 'Print Controls' on page 10-50 for more information.*

### Adjust the cine loop speed

Rotate Loop Speed to set the speed of the cineloop playback.

The speed factor (%) is displayed above the cine gauge.

### To view a cineloop frame by frame

In freeze, use the trackball or **Frame by Frame** to scroll through the cineloop frame by frame.

### Synchronize cine loops

1. Recall stored cine loop to right side of dual screen.
2. Recall same cine loop to left side of dual screen.
3. Change visualization of left side image
4. Select **Sync mode** to start the synchronization.

*NOTE: This is useful for Hybrid Contrast to display and check Contrast and Hybrid Contrast for example.*

### Recalling a cine loop

To recall a cine loop, double click on the cine loop on the clipboard.

*NOTE: CINE Loops stored on the Clipboard are indicated with a movie strip icon.*

### Cine Mode Selection

To scroll the B-Mode cine loop only, toggle the top Trackball key and select **Scroll B**.

To scroll the Timeline cine loop only, toggle the top Trackball key and select **Scroll D**.

### Velocity Scale with B-Mode Only

If you review the B-Mode cine loop while in Doppler Mode with the Timeline using Scroll B, the Velocity Scale displayed with the Timeline is for the time phase of the currently-displayed B-Mode image, NOT for the time phase of the acquired Doppler Spectrum.

Check the velocity value with the measurement function if you review the cine loop using Scroll B. Note that there may be a discrepancy between the velocity scale displayed and the velocity measured using the measurement function.



## Mark CINE

### Preset

1. Check **Enable Mark Cine Control** via Utility -> Application -> Print Controls.

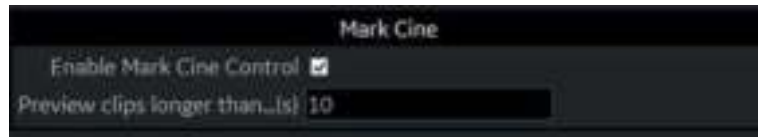

Figure 6-3. Mark Cine on Print Control

Table 6-2: Mark Cine

Preset Parameter	Description
Enable Mark Cine Control	Lets you mark where you want the CINE Loop to start (prospective CINE).
Preview Loop Longer than...(s)	When selected, allows you to review cine loops before storage for loops longer than selected time frame (in seconds).

2. Press **Save**.

### How to use

1. Press **Mark Cine** to specify the starting point for loop storing or cine review.  
When you press **Mark Cine**, the current image frame is noted as a start frame.
2. Press the appropriate print key while continuing to live scan to store the cine loop.

**NOTE:** *The Mark CINE control on the Trackball key is available while live scanning in non-timeline modes (B-Mode, B-Flow and Color Flow Mode).*

**NOTE:** *Selecting Mark CINE when a Mark CINE already exists causes the new Mark CINE to replace the previous one.*

**NOTE:** *Changing modes or other actions that flush CINE memory causes the Mark CINE to be removed and the image data will not be saved.*

**NOTE:** *A Print button can be configured to store a Single Image during Mark Cine, without stopping the Cine loop.*

### Preview

Loop Preview can be enabled independently for Time-Based Store, ECG-Based Store, and Mark CINE. This is useful for setting preview preferences based on the application.

**NOTE:** *The Contrast Time Span setting overrides the Time Span when in Contrast Mode.*

### Background Store

Live Clips are stored in the background to allow you to continue scanning. This works for both Raw Data and for DICOM Loops (with Direct Store On or Off). Image Ordering is preserved with Background Store.

The benefit of Background Store is that clips are stored with minimal interruption to live scanning.

**NOTE:** *Background Store IS NOT supported with V Nav, 4D, or with previously-acquired CINE Loops.*

**NOTE:** *The system may stop acquisition while storing if CINE memory is at least 80% full. Monitor CINE memory while storing CINE loops to ensure continuous live scanning.*

**NOTE:** *DICOM loops take significantly longer to store. Storage time may approach or exceed loop time. Allow extra space in CINE memory when saving DICOM loops.*

**NOTE:** *The CINE gauge turns purple to indicate the section of CINE memory that is being stored in the background.*

## Image Storage Hints



### HINTS

#### Setup Tips

- Print Button Setup is Application specific. When you access Application--> Print Controls, the current Application is the default Application.
- To apply the same Print Control Settings for all Applications, select All Applications as the preset on the Print Controls Menu. Be sure to re-enter values if the field is green.
- Print button setup for the file format and destinations are still configured via the Connectivity Menus.



### HINTS

#### Usage Tips

- If you select Mark CINE, the next time you press Print completes the Mark CINE Loop Store, independent of its configuration.
- The CINE gauge turns green when a Prospective CINE Clip is pending.
- You can cancel Prospective Store by pressing Freeze/Unfreeze or by changing Modes.

### Cine Capture

Selecting **Capture** searches through all images between the start frame and end frame and displays each peak or the highest velocity/tissue power. Adjust the start frame and end frame points to limit the image frames used in the process.

1. Display the CINE loop which is in memory or recalled from archive.

*NOTE: Cine Capture applies only to 2D images (B, B Flow, CF, PDI, Contrast, etc.).*

*NOTE: On 2D duplex modes (B/CF, B/PDI, etc.), Cine Capture is not applied to the background B-Mode image, even if the CF/PDI display is turned off.*

2. Run the cineloop.
3. Select **Capture** on the Touch Panel to display the captured image.  
A character 'C' displays on the screen instead of the frame average level.
4. If necessary, save the captured image.
5. Press **Capture** again to turn Cine Capture off.

*NOTE: Cine Capture can be used on exported files by using the Save As function. You can save the still image (jpeg) and cine loop (avi) by using Save As.*

*NOTE: Cine Capture does not effect TIC Analysis.*

## Capture Recon.

### Description

Capture Recon. reconstructs small blood vessels in the CINE mode.

It is available in B-Flow, Contrast, CF, PDI, and B-Mode without CrossXBeam.

Capture Recon. shows smaller blood flow information than conventional B-Flow image, which is expected for the characterization of tumor, chronic liver disease, vascular abnormality, etc.

### Procedure

1. Scan B-Flow mode in the ordinary way, except:  
Sensitivity can be larger (20 (default) to 30 or more).
2. Acquire a short clip, then freeze.
  - Combination of Capture helps to imagine resulting image.
  - 3-dimensional sweep may be efficient to visualize many vessels.
3. Press **Capture Recon** on the CINE Touch Panel. Adjust threshold as necessary.
4. The order of the frames is rearranged by order of smaller artifact. The frame which has motion artifact is rejected. Move the Trackball or assigned rotary to review the image Frame by Frame.

**NOTE:** *While the Capture Recon, is activated, the color of CINE gauge turns pink.*

### Enhancement

**Enhancement** executes the enhancement process to cine capture images.

1. Display the cine capture image using **Capture**.
- NOTE:*        *Enhancement applies only to Cine Capture images.*
2. Select **Enhancement**. A character 'C' displays on the screen instead of the frame average level.
    - Shade Fw/Shade Rv  
Select Fw (Forward) that brings start frame or Rv (Reverse) that brings last frame of cine to the front. The system has two thresholds for the Shade process. Comparison will be made frame by frame after the thresholds have been met. If the two thresholds are satisfied, no comparison will be made with the rest of the frame.  
  
Using Shade Fw/RV, lower intensity echoes in the near frame will be masked by higher intensity echoes in the far frame. ShadeFw/Rv makes it possible to show lower intensity echoes in the near frame despite the fact that there may be a higher echo projection in the far frame. Therefore, the anteroposterior position of the blood vessel is clearly displayed.
    - Enhance1/Enhance2/Enhance3  
  
The part corresponding to the data of the selected frame is enhanced and superimposed on the entire cine capture images. This allows you to visualize the spatial relationships with the B-Mode image and the flow appearance.



Figure 6-4. Enhancement image example

3. If necessary, save the enhanced image.

*NOTE:*        *You can save the still image (JPEG) and cine loop (WMV) by using Save As.*

## Motion Correction

Understanding of the vascular structure is important, for example, with liver cancer. Though, the captured image distorts or blurs due to the patient's breathing. Motion correction compensates each frame and cancels the motion.

*NOTE: Motion Correction is activated only for B, CHI, Contrast and B-Flow.*

1. Displays the cine capture image using **Capture**.
2. Select **Motion Correction**. The system generates the captured image with motion correction.

The user can store the cine clip with the state of motion correction kept in the raw data.

The user can store the still image as the single frame DICOM image without the raw data.

# Image Zoom

## Overview

There are three kinds of zoom on the system: Pan Zoom, HD Zoom and Magnification Zoom.

- **HD Zoom** only acquires the image data within the ROI, increasing the density of the image in the ROI. Image adjustments can only be performed during live scanning.
- **Pan Zoom** magnifies the display of the data within the ROI without making any changes to the ultrasound image data acquired. The entire image is acquired and the ROI can be adjusted (moved and resized).
- **Magnification Zoom** magnifies the entire image on the screen (non-ROI zoom).

## Location of Zoom Control



Figure 6-5. Zoom Control Knob



## HD Zoom

In HD Zoom, the Ultrasound line density and/or sampling frequency increases, resulting in higher resolution. HD Zoom can be performed on live images.

1. To activate HD Zoom, push the **Zoom** control knob inward while scanning live.

*NOTE: If already in Magnification Zoom, push the **Zoom** control knob inward to first turn off Magnification Zoom, then push again to activate HD Zoom.*

Press the top trackball key to select **Size** for change ROI size or **Pos** for change ROI position.

Use the trackball to position the zoom area over the desired portion of the image.

2. To exit HD Zoom, push the **Zoom** control knob inward again.

*NOTE: When HD Zoom is on and the image is live, the right trackball button toggles from HD Zoom to Pan Zoom.*

## Bioeffect

HD Zooming an image changes the frame rate which tends to change thermal indices. The position of the focal zones may also change which may cause the peak intensity to occur at a different location in the acoustic field. As a result, the MI (TI) may change.



Acoustic  
Output  
Hazard

Observe the output display for possible effects.

### Pan Zoom

Pan Zoom can be performed on a live, frozen, CINE or recalled raw data image.

1. To activate Pan Zoom (when frozen or in CINE) push the **Zoom** knob inward.  
Press the top trackball key to select **Size** to change ROI size or **Pos** to change ROI position. Use the trackball to change the ROI size or position the zoom area over the desired portion of the image.
2. To deactivate Pan Zoom push the **Zoom** control knob inward again.

**NOTE:** *When Pan Zoom is on and the image is live, the right trackball button toggles from Pan Zoom to HD Zoom.*



Figure 6-6. Zoomed Image Example

1. Zoom Image
2. Reference Image: Reference image is the small un-zoomed image.
3. Zoom ROI: Zoom ROI indicates the region of the image to zoom.
4. Pos/Size: Use the top trackball key to change position and size of ROI.

## Magnification Zoom

Magnification Zoom magnifies the entire image on the screen (non-ROI zoom).

1. To activate Magnification Zoom, rotate the **Zoom** control knob clockwise.
2. There are three ways to deactivate Magnification Zoom:
  - Press Mag Zoom Rest on the trackball button.
  - Rotate the **Zoom** control value to 0.
  - Activate B-Mode (push the B-Mode button on the Front Panel).

## Panning in Magnification Zoom

While in Magnification Zoom, you can pan the image across the screen.

1. Press the Top Trackball button to highlight the Position Indicator “Pos.”



Figure 6-7. Position Indicator

2. Move the Trackball to pan the image across the screen.

# Split Screen

## Overview

LOGIQ Totus supports the following multiple image format:

- Dual (split the window area into 2 areas)
- Wide Dual (split the window area into 2 areas, but wider than the normal dual)
- Quad (split the window area into 4 small areas)  
This is useful, for example, when measuring AFI of OB.
- Simultaneous (Dual) (split the module window into 2 areas, with both panes live and active)

*NOTE: Recalled dual/quad images can be edited.*

## Dual screen

1. Press **L** to activate a dual screen. The single image is placed on the left side.

*NOTE: When you activate the dual screen by pressing L, the single image is placed on the left side; when you activate by pressing R, the single image is placed on the right side.*

2. Press **R**. The left side image is freezed and the image displays in the right side.
3. Press **Freeze** to freeze the image of the right side.
4. Press **Freeze** again to unfreeze the active image which has the gray bar under the image.  
To switch between active images, press **L** or **R**.
5. Press **B**-mode key to return to the single screen.

*NOTE: To put a copy of the image on the opposite side when entering dual split screen, use the "When Entering Dual Image" preset found on Utility --> Application --> Settings preset page.*

## Quad screen

1. Press and hold down **L** to activate a quad screen. The single image is placed on the upper left.
- NOTE: When you activate the dual screen by pressing L, the single image is placed on the left side; when you activate by pressing R, the single image is placed on the right side.*
2. Press **R**. The left side image is freezed and the image displays in the upper right.
  3. Press **Freeze**.
  4. Press **Freeze** again to unfreeze the image which has the gray bar under the image.  
Press **L** or **R** to move the gray bar to the image of the left side or the right side.
  5. Press **B-mode** key to return to the single screen.

## Simultaneous mode

While using CFM or PDI, press **L** and **R** keys simultaneously to display B and B+CFM, or B and B+PDI in real-time on the left and right side.

It is useful to observe the ROI in B-Mode.

- NOTE: Simultaneous mode can also be used within B-Mode to view with (Right) and without CrossXBeam (Left) if CrossXBeam is turned on.*

## Dual Caliper

In split screen, you can draw a caliper, area, ellipse, or spline trace on both the left and right image at the same time. Whichever side of the screen that you annotate is called the "Original" graphic. The copy is called the "Shadow" graphic.

This feature is available in the following modes:

- B-Mode:B-Mode
- Color Flow Mode:Color Flow Mode
- B-Mode:Color Flow Mode
- Simultaneous Mode.
- Contrast
- Elastography
- Volume Navigation

## Dual Caliper (continued)

**NOTE:** *Dual Caliper IS NOT available in B-Mode: B/PW Mode or in B-Mode: B/M Mode, or with different probes.*

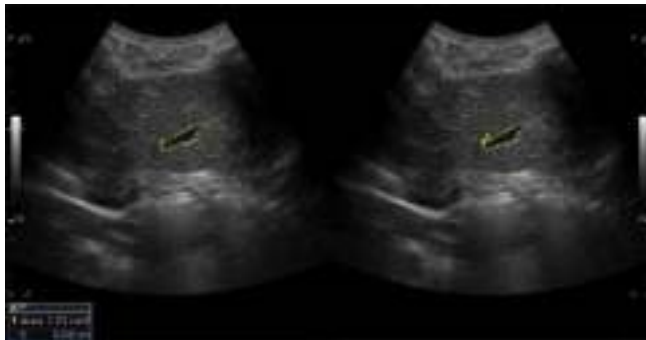

Figure 6-8. Original (Left), Shadow (Right)

**NOTE:** *Only the Original graphic contains the graphic numbering. In this way you can always distinguish between the Original and the Shadow graphic.*

**NOTE:** *You can only edit the Original graphic; however, when you do edit the Original graphic, the Shadow graphic is also edited at the same time.*

**NOTE:** *If you delete either graphic, both are deleted.*

**NOTE:** *When a measurement is selected without Dual B-Mode images or with different probe images, a warning message is displayed on the status bar and the selected measurement is cancelled.*

**NOTE:** *If the first point of the Original graphic is out of the Shadow image area, then a warning message displays on the status bar and the Shadow graphic is not drawn.*

**NOTE:** *The Trackball move area is limited to the narrow area of both images.*

**NOTE:** *You cannot take a measurement across dual images.*

**NOTE:** *The 2D Dual measurement tool cannot be copied.*

## Dual caliper for 2D image

2D Dual Caliper / 2D Dual Area / 2D Dual Ellipse / 2D Dual Spline Trace / 2D Dual Circle are not available through the factory default. To enable these measurements, add a new measurement using “2D Dual Caliper”, “2D Dual Area”, “2D Dual Ellipse”, “2D Dual Spline Trace” or “2D Dual Circle” tool in the Utility--> Measure--> M&A preset menu.

1. Select Blank from Add measurement.



Figure 6-9. Add Measurement

2. Select appropriate dual caliper tool from Tool drop-down menu.



Figure 6-10. Drop-down menu

3. Type the measurement and parameter name as you like.
4. Add the created measurement to the Touch Panel.
5. Display the dual image and press **Measure**.
6. Select an added measurement from the Touch Panel to enable the appropriate measurement. A caliper displays.

**NOTE:** *When the measurement is selected without dual B images or with different probe images, a warning message displays on the status bar and the selected measurement is cancelled.*

### Dual caliper for 2D image (continued)

7. To position the caliper at the start point, move the **Trackball**. You can use both images as an original image.

*NOTE: If the first point of the original graphic is out of the shadow image area, then the warning message displays on the status bar and the shadow graphic is not drawn.*

8. To fix the start point, press **Set**. The caliper changes to an active caliper.

*NOTE: Only original graphic has graphic numbering to distinguish between original image and shadow image.*

*NOTE: The trackball move area is limited to the narrow area of both images.*

*NOTE: Only the original graphic can be edited. When the original graphic is edited, the shadow graphic is also updated.*

9. To complete the measurement, press **Set**. The system displays the measurement result in the Results Window.

### Dual Caliper for V Nav

1. Check **Dual Caliper on VNav** in Utility -> System -> System Measure. Only available distance, area, trace and angle measurement for V-Nav.

*NOTE: You cannot measure on the recalled image.*

*NOTE: Measure is available on the cine image shortly after freezing the image; however, you cannot measure on recalled images.*

2. Select the measurement via the Trackball key for a live scan image. Select the measurement from the Measurement Type table for Volume data.

*NOTE: Numbers are only displayed on the live scan image.*

3. If you want to measure live scan and volume data separately, select **Off** for Dual Caliper using the Touch Panel key.

*NOTE: After the Dual caliper measurement, graphics and measurement results are removed from the Volume dataset when you press **Measure**.*

*NOTE: If you use Zoom after the Dual caliper measurement, graphics and measurement results are removed.*



# Annotating an Image

## Introduction

The comment function provides the capability to type the comments of free text and/or insert the pre-defined comments from the comment library. It also provides the user with arrow markers to point to parts of the image.

Pressing the **Comment** key or any keys on the alphanumeric keyboard initiates the comment mode. This assigns the Trackball function to controlling the cursor and displays the comment library on the Touch Panel menu.



Figure 6-11. Comment Key on the Front Panel

In comment mode, text can be added by using the comment library or by typing from the alphanumeric keyboard.

Comments can be erased by powering down, when you press **Clear** or **New Patient**, or when preset via Utility -> Comments.

### Introduction (continued)

In addition, the display's home position can be changed (preferred comment area) for each display so that all subsequent comments begin in the same spot.

To return to the user specified position or factory default position, press the **F7 (Cursor Home)** key or the **Home** control on the Annotation Touch Panel (see Figure 6-13 on page 6-29).

To establish a new cursor home position, place the cursor in the desired position and press **Shift+F7** or press and hold the Home control on the Annotation Touch Panel.

Comment Mode is activated by pressing the **Comment** key. Comment Mode can also be automatically activated by typing from the alphanumeric keyboard.

**NOTE:** *In this case, the cursor begins at the same location where the comment mode was exited.*

After activating the comment mode, a vertical bar type cursor appears on the screen. Use the **Trackball** to move the cursor.

The factory default color for comments is yellow. The color selection can be changed to any of the colors available on the system. The choices are white, yellow, bright red, orange, etc.

**NOTE:** *The user cannot change the Font Family.*

To indicate a specific comment or text group is selected, the color turns to blue. Once the comment is set or fixed, the color returns to yellow or to the user selected color.

On the Touch Panel annotations have been color-coded for easy replacement or to easily add annotations. See Annotation Groupings below.

To delete comments by character, press the **Backspace** key.

To delete all comments and arrow marks, press the **Clear** key twice immediately after entering the comment mode.

To exit the Comment/Library Comment function, press the next function you wish to do.

To move by words or by text group, press the **Tab** key.

## Adding Comments to an Image

### Comment Retention

Comments from the B-Mode images are retained and carried over when switching to multi-image format or duplex mode.

The position of the comments is adjusted so that it is at the same relative position with respect to the display window in the new format as it was in the single image format.

*NOTE: Comments may not be retained when the image is switched to M-Mode image format depending on the preset.*

### Arrow Pointers

Arrow pointers can be used by activating the **F2 (Arrow)** key on the keyboard or by selecting the **Arrow** control on the Annotation Touch Panel (see Figure 6-13 on page 6-29). When the pointer comes up, it is a blue color, indicating it is active and can be moved.

- Move the pointer using the **Trackball** to any place on the screen. The pointer head direction can be controlled by movement of the Trackball or **Arrow Rotate** control.
- To readjust the length and thickness of the pointer, use the **Arrow Resize** rotary control. The default for the pointer size can be preset.
- Press **Set** to fix the place of the pointer and direction of the pointer head. The blue color turns to yellow (or the default color if changed).
- To delete the arrow marks, press the **Clear** key right after pressing the **F2 (Arrow)** key or press and hold the **Arrow** control on the Annotation Touch Panel.

*NOTE: To prevent the Trackball from changing the arrow angle, select the "Keep arrow angles" preset at Utility -> Annotation -> Comments.*

### Text Overlays

There are 2 layers of the text in comments, which can be selected by toggling the **F8 (Text1/Text2)** key on the keyboard or by selecting the **Comment Layer Switch** control on the Annotation Touch Panel (see Figure 6-12). Text1 is the default choice.



Figure 6-12. Comment Layer Switch Control

By using this function, users can perform a HIDE TEXT/SHOW TEXT, allowing the users to save or print an image without clearing the typed text.

You can specify to display text 1, text 2, or both. This allows you to have some comments that do not change during the exam while allowing you to change the other comment. Toggle the **F8** key or **Comment Layer Switch** control to cycle through the three Text 1/Text 2 states:

1. Text 1 Only -- Only Text 1 comments displayed and editable.
2. Text 2 Only -- Only Text 2 comments displayed and editable.
3. Text 1 and Text 2 -- Both displayed; only Text 2 comments editable. Only Text 2 comments erased by Clear key. Word Delete only deletes Text 2 comment. Both Text 1 and Text 2 comments erased with new patient, new exam, or probe change.

To preset the Text Overlay Sequence, go to **Utility -> Comment -> Comment** and select either **Text 1 and Both** or **Text 1 and Text 2 and Both**.

## **Text Overlays (continued)**

The font color for the Text1 and Text2 overlays can be set separately. Go to **Utility -> Comment -> Comment** and specify the text color for Text 1 Color and Text 2 Color.

*NOTE: If you check "Erase when image is unfrozen" in the Utility menu, only the editable text plane erases when you unfreeze the image.*

### Annotating an Image Using the Library

To reduce the amount of time spent annotating an image, store frequently-used comments in the Comment Library. As many as 6 libraries are available per study. One of the selected libraries is designated as the default and its entries shall be displayed on the Touch Panel when the comment mode is activated for that study.

Press **Comment** and move the comment cursor location using the **Trackball**.

Select the desired comment from the Touch Panel.

Each Touch Panel key can also be configured to hold a small list of up to 3 comments. The first word in the list is displayed on the Touch Panel and the others can be accessed by toggling the key or pop-up menu. To show the presence of a small list stored under a particular key, a small indicator (>) is placed on the key.

To program your system with specific comments, see 'Comments Libraries Presets' on *page 10-33* for more information.

### Annotating an Image by Comment Groupings

Comments can be grouped together for ease of annotating. For example, in the figure below there are blue, yellow, and green groups.



Figure 6-13. Annotation Touch Panel

When you select comments with a different color, the selected comment is added to the existing comment. In the example below, **Right** was selected from the blue group of comments. **Trans** was selected from the yellow group, so it was added to the first comment. **Bowel** was selected from the green group, so it was also added.

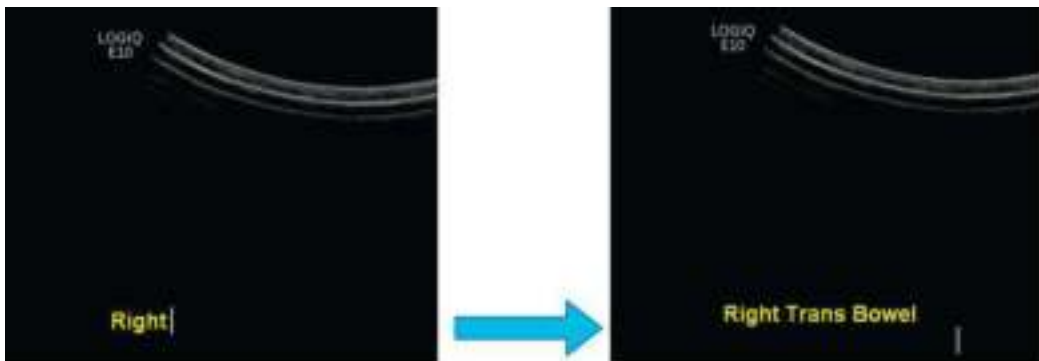

Figure 6-14. Added Comments (Different Color Groups)

### Annotating an Image by Comment Groupings (continued)

When you select comments with the same color, the selected comment is overwritten with the new comment. In the example below, **Bowel** was selected from the green group of comments, but then **Appendix** was selected from the same green group, so it replaced **Bowel**.

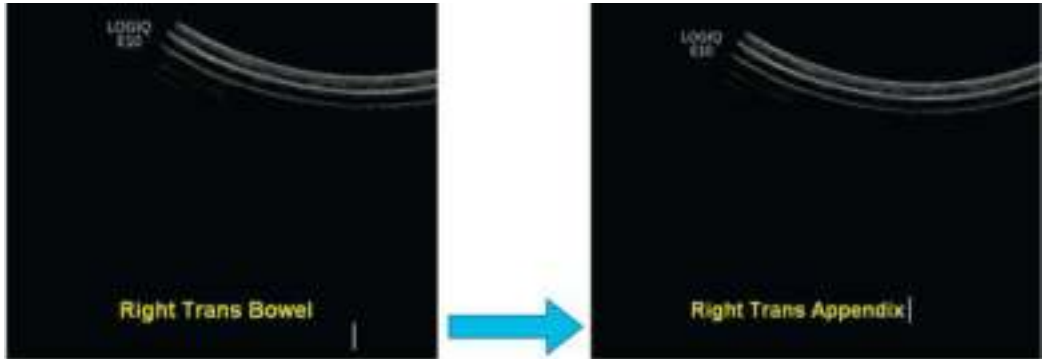

Figure 6-15. Replaced Annotation (Same Color Group)



**Annotating an Image by Comment Groupings (continued)**

You can configure these Comment color groupings via Utility--> Comments--> Libraries (up to 5 groups). Groups are organized by color. Position the cursor over the rectangular region to the left of the annotation to display the group drop-down selection menu, then select the color that matches your grouping.

*NOTE: You can also group annotations by dots (: and .). Dots are for color blindness recognition in groupings.*

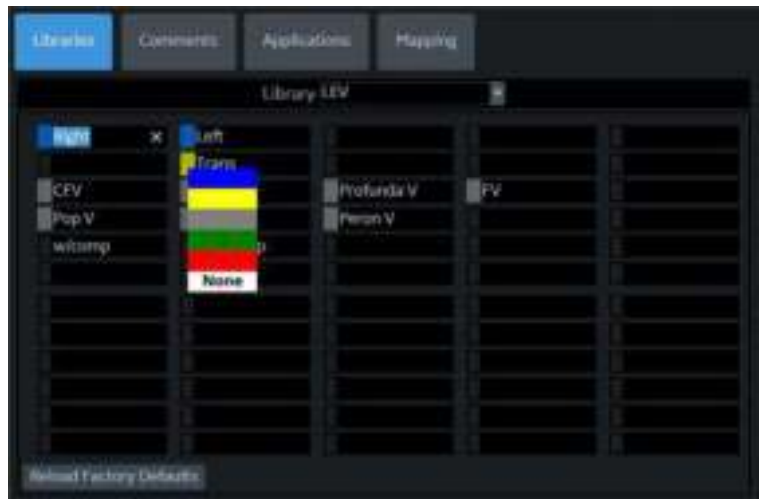

Figure 6-16. Tagging a Group Color to an Annotation

The configured comments are displayed on the Touch Panel.





Figure 6-17. Color-Tagged Annotation Touch Panel

**Rearranging Touch Panel Comments**

You can easily move comments to a new location by selecting the annotation and moving it to the new, empty location.

**NOTE:** You cannot move a comment to a location with a comment. The new location must be empty.

Table 6-3: Moving Touch Panel Annotations

Step	Example
<p>1. Position the cursor over the annotation you want to move. In the example, we are going to move "Left" to a cell to the right.</p>	
<p>2. Hold and drag the "Left" annotation to the new cell; in this case the empty cell to the right.</p>	
<p>3. Release the cursor when you have the annotation positioned in the new cell location. Then Save and Exit the Utility Page.</p>	

## Annotating an Image with Typed Words

- Press **Comment** and type the comments where the cursor is currently located (the display's home position) and use the **Trackball** to further place the comment cursor in the desired location.
- Press **Enter** to move to the next line.

**NOTE:** *Comments wrap to the next line when they are within one character of the right margin if Word Wrapping is selected in the Text Boundary preset. See 'Comments Libraries/Comments Preset Menu' on page 10-36 for more information.*

The word wrap starts one line below the start of that comment.

Comments appear on all prints, photos, DVR or CINE loops.

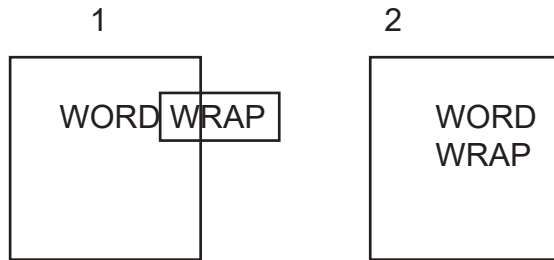

Figure 6-18. Next Line Word Wrap

1. Before

2. After

If the cursor appears at the right edge of the lowest line, or a word cannot be completed in the lower right corner, word wrap cannot be executed.

**NOTE:** *The same word wrap principles apply for library scripts as typed comments.*

### Moving Text

You have the ability to move comments already on the screen and place them in different locations.

- Place the cursor on the desired text or text group and press **Set**.
- The selected text color turns to green.
- Use the **Trackball** to move the selected text and press **Set**.

### Editing While Annotating

Backspace over any error(s) made. Blank spaces take the place of the letter(s) that were there. Continue typing the comment after backspacing over all incorrect letters.

To delete previous character(s):

- Press **Backspace** as many times as necessary to make the deletion.
- Once all texts within the selected text group are deleted, then the cursor will find another text group to delete to the upper left direction.
- If there is no more text to delete, the cursor will be located at home position.
- To delete all comments and arrow marks, press the **Clear** key twice immediately after entering the comment mode.

To move through the text a word at a time:

- Press **Tab** to move to the right by text group (Preset Keyboard Tab = Word)

*NOTE: Press Shift + Tab to move to the left.*

To activate the last text group typed or selected from the Library:

- Press **F9 (Grab Word)** key. The selected comment will be highlighted.
- To increase/decrease the area of the highlighted selection use HIGHLIGHT rotary.

*NOTE: Once the text is highlighted, typing comments or choosing them from the library replaces the highlighted text.*

*NOTE: To select all text groups, Press Shift + F9 (Grab Word) key.*

To cancel the last action:

- Press **Undo** key.

## Body Patterns

An additional way to annotate the image display is with body patterns. Body patterns are a simple graphic of a portion of the anatomy that is frequently scanned. The body pattern and probe marker can serve as a reference for a patient and probe positioning when images are archived or scanned.

1. Press **Bodypattern/Ellipse**. Body patterns specific to the current application are displayed.



Figure 6-19. Body Pattern/Ellipse Control

2. Touch the body pattern to insert. The selected body pattern with a probe marker is displayed on the scanning screen.
3. Using the trackball, adjust the position of the probe marker.
4. Rotate **Body Pattern/Ellipse** to set the probe marker orientation.
5. To move the body pattern:
  - Press **Move Pattern**.
  - Move the bodymark to a new location with the trackball.
  - Press **Set** to anchor the bodypattern to the new location.
6. Press **Set** on the keyboard or **Scan** on the Touch Panel to exit without erasing the body pattern.
7. To clear the body pattern, press the **Body Pattern/Ellipse** control to activate body patterns and then press the **Clear** key.

The body pattern packages may be customized to accommodate user preference. Up to 30 individual body patterns in the packages can be changed. See 'Body Pattern Libraries/Applications Preset Menu' on *page 10-45* for more information.

Body Patterns (continued)



Figure 6-20. Touch Panel displays of Body Pattern - example

Table 6-4: Control Touch Panel

No.	Function	Description
1.	Move Pattern	Each Touch panel key can also be configured to hold a small list of up to 3 comments. The first word in the list is displayed on the Touch Panel and the others can be accessed by toggling the key. To program your system with specific comments, see 'Creating a small list' on page 10-37 for more information.
2.	Save Position	Move the body pattern to the desired location and press the <b>Save Position</b> . Current position of Body Pattern is saved as a Home Position of current display format. Hold down <b>Save Position</b> to reset the home position to factory default.
3.	Save Probe Position	Rotate the arrow. You can also rotate the arrow by Trackball.
4.	Probe Type	The probe mark type is selectable by rotating the <b>Probe Type</b> control on the Touch Panel. There are different choices available with one being a blank selection.
5.	Pattern Size	Rotate the rotary. You can adjust the size of the body pattern..

To select the active side in dual B-Mode, use the **Active Side** rotary control at the bottom of the Touch Panel.

You can use the **Zoom** control to select the body pattern. If you want to assign the select function to the Zoom control, see See 'Body Pattern Libraries/Libraries Preset Menu' on *page 10-42 for more information..*

## Notes for Body Pattern (Probe mark)

- Probe Type is the type of probe mark displayed on the body pattern. It can be saved only for each body pattern on the Touch Panel while body pattern is activated, but not in the Utility preset menu. Therefore, Probe Type cannot be saved as an Application or System Preset.

To save the Probe Type,

- a. Activate the **Body Pattern**.
- b. Select a Body Pattern on the Touch Panel.
- c. Select a type of probe mark with the **Probe Type** Touch Panel key.
- d. Place the probe mark at the proper location.
- e. Select the **Save Probe Position** Touch Panel key.

*NOTE:* “Save Probe Position” saves both the Probe Mark position and Probe Type.

- When a Body Pattern is selected and no Probe Mark has been saved on it, the latest used Probe Mark is carried over to the Body Pattern.

### Notes for Body Pattern (Probe mark) (continued)

- Check the Body Pattern on the Touch Panel if the Probe Mark does not appear on the monitor.

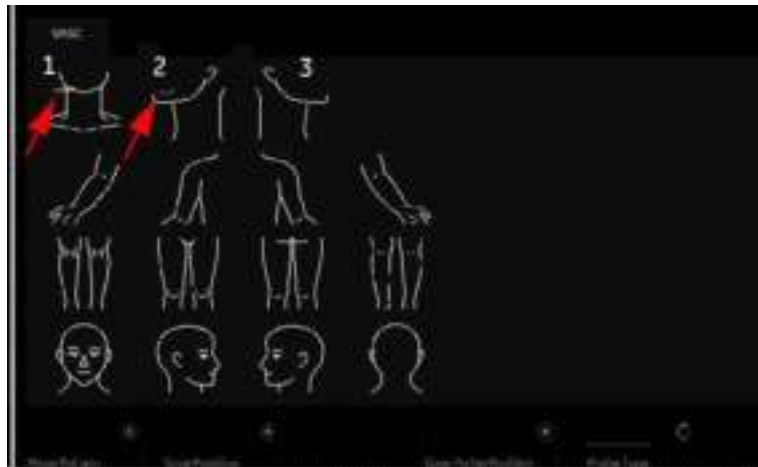

Figure 6-21. Body Pattern Touch Panel

1. When the Probe Mark is saved for the Body Pattern, the Probe Mark is displayed in yellow on the Touch Panel and should also be shown on the monitor.
2. When the Probe Mark is saved with "Probe Type - None", the Probe Mark is displayed in gray on the Touch Panel and is not shown on the monitor. Reselect an appropriate Probe Type and save as necessary.
3. When the Probe Mark is not saved, no Probe Mark is displayed either on the Touch Panel or the monitor. Select an appropriate Probe Type and save as necessary.



## Body Patterns (continued)



Figure 6-22. Body Patterns Available

- |            |                |                 |                  |
|------------|----------------|-----------------|------------------|
| 1. abdo 1  | 16. body 1     | 31. breast 1    | 46. carotid 1    |
| 2. abdo 2  | 17. body 2     | 32. breast 2    | 47. carotid 2    |
| 3. abdo 3  | 18. body 3     | 33. breast 3    | 48. carotid 3-Lt |
| 4. abdo 4  | 19. body 4     | 34. breast 4-Lt | 49. carotid 3-Rt |
| 5. aorta   | 20. body 5     | 35. breast 4-Rt | 50. carotid 4    |
| 6. arm 1   | 21. body 6     | 36. breast 5-Lt | 51. carotid 4-Lt |
| 7. arm 2   | 22. body 7-Lt  | 37. breast 5-Rt | 52. carotid 4-Rt |
| 8. arm 3   | 23. body 7-Rt  | 38. breast 6-Lt | 53. carotid 5    |
| 9. arm 4   | 24. body 8-Lt  | 39. breast 6-Rt | 54. chest 1      |
| 10. arm 5  | 25. body 8-Rt  | 40. breast 7-Lt | 55. fetus 1      |
| 11. arm 6  | 26. body 9     | 41. breast 7-Rt | 56. fetus 2      |
| 12. arm 7  | 27. body 10    | 42. breast 8-Lt | 57. fetus 3      |
| 13. arm 8  | 28. body 11-Lt | 43. breast 8-Rt | 58. fetus 4      |
| 14. arm 9  | 29. body 11-Rt | 44. breast 9-Lt | 59. fetus 5      |
| 15. arm 10 | 30. body 12    | 45. breast 9-Rt | 60. fetus 6      |

Body Patterns (continued)

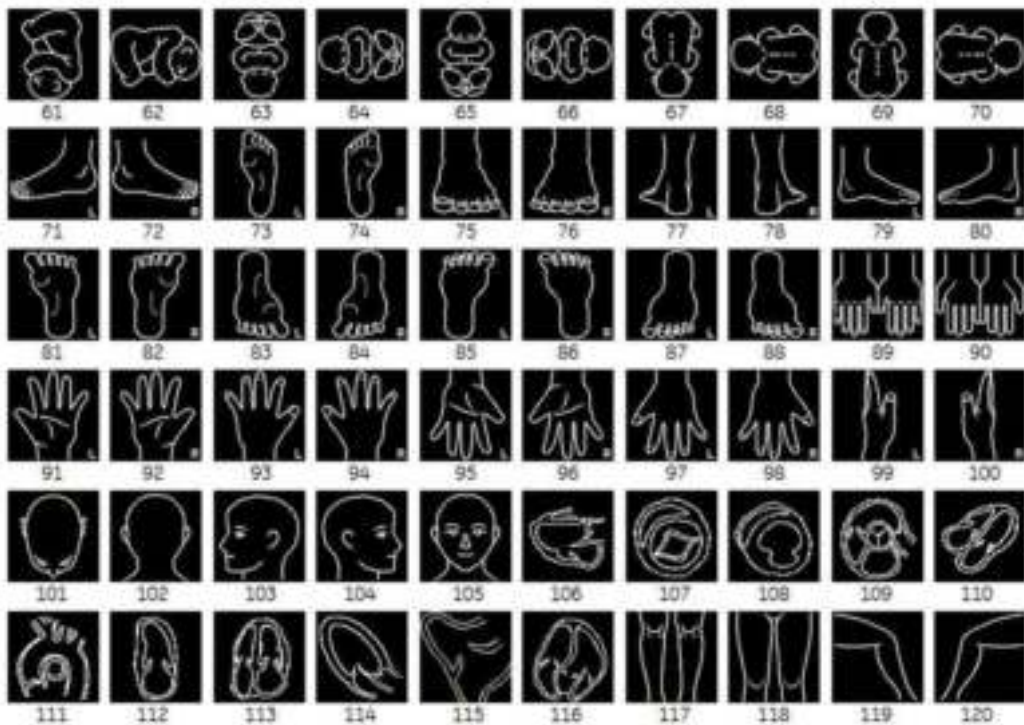

Figure 6-23. Body Patterns Available (continued)

- |               |               |                |               |
|---------------|---------------|----------------|---------------|
| 61. fetus 7   | 76. foot 3-Rt | 91. hand 3-Lt  | 106. heart 1  |
| 62. fetus 8   | 77. foot 4-Lt | 92. hand 3-Rt  | 107. heart 2  |
| 63. fetus 9   | 78. foot 4-Rt | 93. hand 4-Lt  | 108. heart 3  |
| 64. fetus 10  | 79. foot 5-Lt | 94. hand 4-Rt  | 109. heart 4  |
| 65. fetus 11  | 80. foot 5-Rt | 95. hand 5-Lt  | 110. heart 5  |
| 66. fetus 12  | 81. foot 6-Lt | 96. hand 5-Rt  | 111. heart 6  |
| 67. fetus 13  | 82. foot 6-Rt | 97. hand 6-Lt  | 112. heart 7  |
| 68. fetus 14  | 83. foot 7-Lt | 98. hand 6-Rt  | 113. heart 8  |
| 69. fetus 15  | 84. foot 7-Rt | 99. hand 7-Lt  | 114. heart 9  |
| 70. fetus 16  | 85. foot 8-Lt | 100. hand 7-Rt | 115. heart 10 |
| 71. foot 1-Lt | 86. foot 8-Rt | 101. head 1    | 116. heart 11 |
| 72. foot 1-Rt | 87. foot 9-Lt | 102. head 2    | 117. legs 1   |
| 73. foot 2-Lt | 88. foot 9-Rt | 103. head 3    | 118. legs 2   |
| 74. foot 2-Rt | 89. hand 1    | 104. head 4    | 119. legs 3   |
| 75. foot 3-Lt | 90. hand 2    | 105. head 5    | 120. legs 4   |

## Body Patterns (continued)

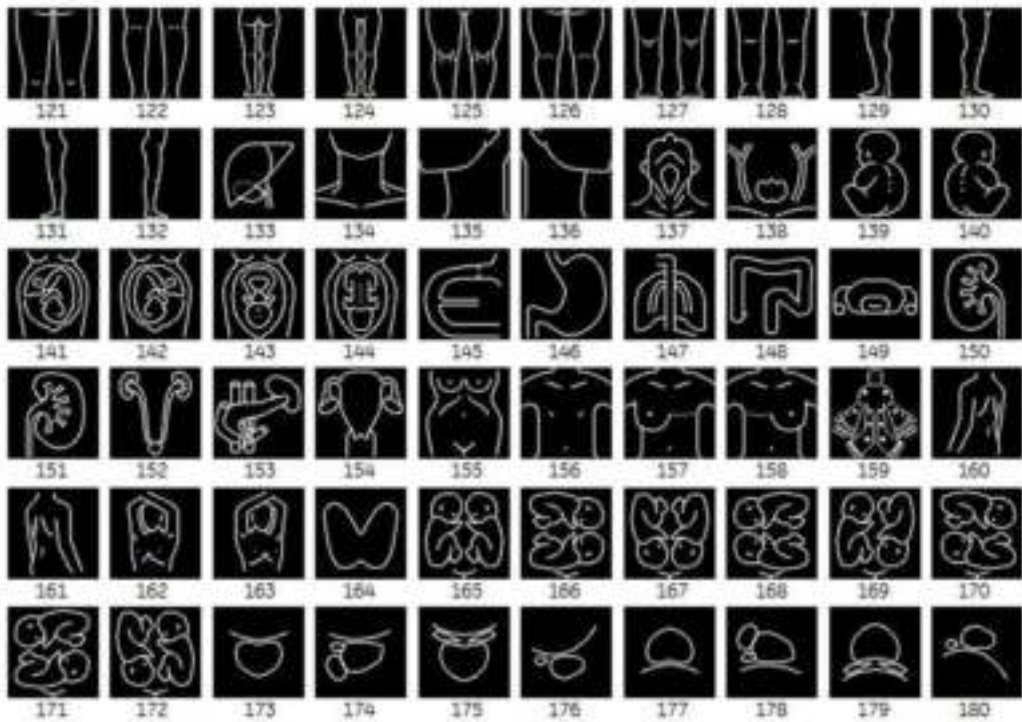

Figure 6-24. Body Patterns Available (continued)

121. legs 5	136. neck 3	151. organ 7	166. twin 2
122. legs 6	137. neck 4	152. organ 8	167. twin 3
123. legs 7	138. neck 5	153. organ 9	168. twin 4
124. legs 8	139. ob 1	154. pelvis 1	169. twin 5
125. legs 9	140. ob 2	155. pelvis 2	170. twin 6
126. legs 10	141. ob 3	156. post-breast-bilateral	171. twin 7
127. legs 11	142. ob 4	157. post-breast-Lt	172. twin 8
128. legs 12	143. ob 5	158. post-breast-Rt	173. uro 1
129. legs 13-a-Lt	144. ob 6	159. rheuma	174. uro 2
130. legs 13-a-Rt	145. organ 1	160. shoulder-back-Lt	175. uro 3
131. legs 13-Lt	146. organ 2	161. shoulder-back-Rt	176. uro 4
132. legs 13-Rt	147. organ 3	162. shoulder-front-Lt	177. uro 5
133. liver	148. organ 4	163. shoulder-front-Rt	178. uro 6
134. neck 1	149. organ 5	164. thyroid	179. uro 7
135. neck 2	150. organ 6	165. twin 1	180. uro 8

Body Patterns (continued)

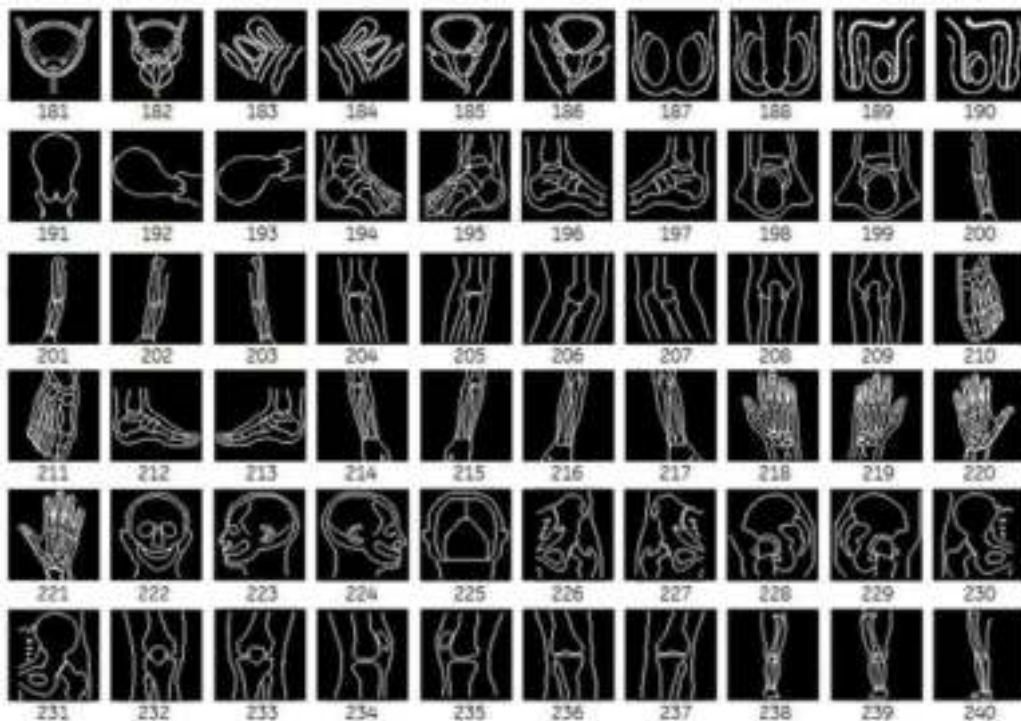

Figure 6-25. Body Patterns Available (continued)

- |                       |                    |                      |                   |
|-----------------------|--------------------|----------------------|-------------------|
| 181. uro 9 female     | 196. ankle lat-Lt  | 211. foot-Rt         | 226. hip-Lt       |
| 182. uro 9 male       | 197. ankle lat-Rt  | 212. foot lat-Lt     | 227. hip-Rt       |
| 183. uro 10 female-Lt | 198. ankle post-Lt | 213. foot lat-Rt     | 228. hip lat-Lt   |
| 184. uro 10 female-Rt | 199. ankle post-Rt | 214. forearm-Lt      | 229. hip lat-Rt   |
| 185. uro 10 male-Lt   | 200. arm-Lt        | 215. forearm-Rt      | 230. hip post-Lt  |
| 186. uro 10 male-Rt   | 201. arm-Rt        | 216. forearm post-Lt | 231. hip post-Rt  |
| 187. uro 11           | 202. arm post-Lt   | 217. forearm post-Rt | 232. knee-Lt      |
| 188. uro 12           | 203. arm post-Rt   | 218. hand-Lt         | 233. knee-Rt      |
| 189. uro 13-Lt        | 204. elbow-Lt      | 219. hand-Rt         | 234. knee lat-Lt  |
| 190. uro 13-Rt        | 205. elbow-Rt      | 220. hand post-Lt    | 235. knee lat-Rt  |
| 191. uterus 1         | 206. elbow lat-Lt  | 221. hand post-Rt    | 236. knee post-Lt |
| 192. uterus 2         | 207. elbow lat-Rt  | 222. head            | 237. knee post-Rt |
| 193. uterus 3         | 208. elbow post-Lt | 223. head lat-Lt     | 238. leg-Lt       |
| 194. ankle-Lt         | 209. elbow post-Rt | 224. head lat-Rt     | 239. leg-Rt       |
| 195. ankle-Rt         | 210. foot-Lt       | 225. head post       | 240. leg post-Lt  |

**Body Patterns (continued)**



Figure 6-26. Body Patterns Available (continued)

- |                       |                    |                    |                  |
|-----------------------|--------------------|--------------------|------------------|
| 241. leg post-Rt      | 248. thigh-Lt      | 255. wrist post-Rt | 262. brain4      |
| 242. shoulder-Lt      | 249. thigh-Rt      | 256. new carotid 2 | 263. breastSA-Rt |
| 243. shoulder-Rt      | 250. thigh post-Lt | 257. carotid2-Lt   | 264. breastSA-Lt |
| 244. shoulder lat-Lt  | 251. thigh post-Rt | 258. carotid2-Rt   | 265. lung1       |
| 245. shoulder lat-Rt  | 252. wrist-Lt      | 259. brain1        | 266. organ10     |
| 246. shoulder post-Lt | 253. wrist-Rt      | 260. brain2        | 267. organ11     |
| 247. shoulder post-Rt | 254. wrist post-Lt | 261. brain3        |                  |

# Using the Fast Key

## Overview

A keyboard Fast Key is available to record and run a sequence of often-run keystrokes.

**NOTE:** *Ensure that you have a patient selected prior to running the Fast Key operation.*

## Create a Fast Key

1. Press the **F5** key. The “Do you want to create the Fast Key?” dialog displays. Select OK to continue.
2. Select a key to assign a Fast Key to (a-z, 0-9).

If you select a Front Panel control, a Touch Panel key or any key besides a-z or 0-9, a warning dialog displays and the procedure is cancelled.

**NOTE:** *Assign Fast Key Function to Key 0 - 9 in Utility -> System -> User Configurable Key before you create a Fast Key.*

**NOTE:** *There is no distinction between capital and small letters.*

**NOTE:** *The key code is the same in Russian and Greek (a-z, 0-9).*

3. If the selected key is already assigned to a Fast Key, a warning dialog displays.

Select Yes to continue. The Fast Key file is overwritten.  
Select No to cancel the Fast Key setup.

4. Input the key sequence to be assigned.

**NOTE:** *It is impossible to save a power cycle sequence or any input from outside of the system.*

**NOTE:** *If a warning dialog displays due to the limitations of the number of key sequences, press F5 to finish and retry.*

5. Press the **F5** key to complete a Fast Key setup. The information dialog displays. Select OK.

## Start a Fast Key

1. Press the **F6** key to start a Fast Key. The message “Select the key which the Fast Key is assigned to” displays on the status bar.

*NOTE: The F6 key is ignored if another dialog displays on the system.*

*NOTE: If you press F5 after F6, the F6 function cancels and the F5 function is enabled.*

2. Press the key assigned to the Fast Key macro. The message “Fast Key playback is finished” displays on the status bar when the macro is finished.

To stop the Fast Key during the operation, press **F6**. The message “Fast Key playback is cancelled” displays on the status bar.

*NOTE: Select the running speed in the Run Fast Key Speed preset on Utility -> System -> General.*

## Backup and Restore the Fast Key

You can backup/restore the Fast Key via Utility -> System -> Backup/Restore.

To backup, select User Defined Configuration in the Backup section.

To restore, select User Defined Configuration in the Restore section.





---

## Chapter 7

# General Measurements and Calculations

*Describes how to perform general measurements and calculations.*

# Introduction

## Introduction

Measurements and calculations derived from ultrasound images are intended to supplement other clinical procedures available to the attending physician. The accuracy of measurements is not only determined by system accuracy, but also by the use of proper medical protocols by the user. When appropriate, be sure to note any protocols associated with a particular measurement or calculation. Formulas and databases used within the system software that are associated with specific investigators are so noted. Be sure to refer to the original article describing the investigator's recommended clinical procedures.



### WARNING

The system provides calculations (e.g. estimated fetal weight) and charts based on published scientific literature. The selection of the appropriate chart and clinical interpretation of calculations and charts is the sole responsibility of the user. The authorized user should consider proper indications for the use of a calculation or chart as described in the scientific literature. The diagnosis, decision for further examination, and medical treatment must be performed by qualified personnel following good clinical practice.

## Basic Operation

### Measure and Assign

1. Press **Measure** on the control panel.
2. Select the measurement tool via the upper trackball key.
3. Perform the measurement. Follow the instructions displayed on the message area at the bottom of the screen.
4. To assign a label, select the measurement in the Measurement result window and press **Set**.



Figure 7-1. Label menu

5. Select the required label from the menu. For example, if it is a distance measurement, the list includes all distance calculations for the current study.

or

Select **User Name** from the menu. The dialogue window displays.

Enter the appropriate name and select OK.



Figure 7-2. Enter Measurement Name

### List of general measurements

The following types of general measurements are available when you press **Measure** but do not choose a specific calculation. The type of measurement depends on the current scan mode.

After pressing **Measure**, rotate between various measurement types with the upper Trackball keys.

#### **B and CF Modes**

- Dist (Caliper)
- Trace
- Spline
- Intensity
- Open Trace
- Open Spline

*NOTE: You can preset the sequence of B and CF area measurements in the Measure Key Sequence (B/CF) preset in the Utility -> Measure -> Advanced screen. See the "M&A Advanced Preset" section for more information.*

#### **Doppler Mode**

- Velocity
- Trace
- Slope
- Time

#### **M-Mode**

- Caliper
- Time
- Slope

## **Assign and Measure**

1. Press **Measure** on the control panel.
2. Select the measurement on the Touch Panel.  
If you select the measurement folder, the sub menu tab is displayed. You can select and perform the measurement in the tab.  
If the folder is configured with auto-sequence measurement, the next measurement in the study is pre-selected. To skip a pre-selected measurement, select another measurement.
3. Perform the measurement. Follow the instructions displayed on the message area at the bottom of the screen.

## Measurement Controls



Figure 7-3. Measurement Controls on the Control panel

Table 7-1: Measurement controls

Control	Description
1. Cursor	<b>Pointer Key.</b> Select to display a pointer on the monitor.
2. Clear	During a measurement sequence, erases the measuring caliper and measurement data from the display. When not performing a measurement sequence, clears all calipers and measurements from the display. To remove all annotations/body markers/arrows, hold down the Clear button.
3. Annotation	Annotations can be added to measurements on the image.
4. Body Pattern	Body patterns can be added to measurements on the image.
5. Measure	Activates a measurement caliper and the calculation package associated with the currently selected preset.
6. Zoom Rotary	Zoom Rotary controls Pan Zoom, HD Zoom and Magnification Zoom. Pan Zoom magnifies the display of the data without making any changes to the ultrasound image data that is acquired. HD Zoom only acquires the image data within the ROI, and can only be performed during live scanning because of the acquisition adjustments that are done. When preset, you can adjust the Depth by moving the toggle up and down. If preset, you can scroll through the body patterns with the Zoom control. Magnification Zoom magnifies the entire image on the screen (non-ROI zoom).
7. Trackball	Moves the measurement calipers, selects the measurement on the Summary Window. Trackball also selects items on the Touch Panel with the Pointer and Set keys.
8. Trackball keys	The functionality of these keys changes (for example, Set, Change Measure, etc.) depending on the mode or action. Current functionality is displayed on the lower-right corner of the monitor.

## Touch Panel

### B/M/Doppler Mode Select Tab

The B, M, or Doppler mode select tab key allows the user to select measurements associated with a particular mode of active study.

The system provides a default mode selection.



Figure 7-4. B-Mode - Example

### Exam Calcs Tab

The Exam Calcs Tab is used for selecting calculations from other study in the selected Exam Category.

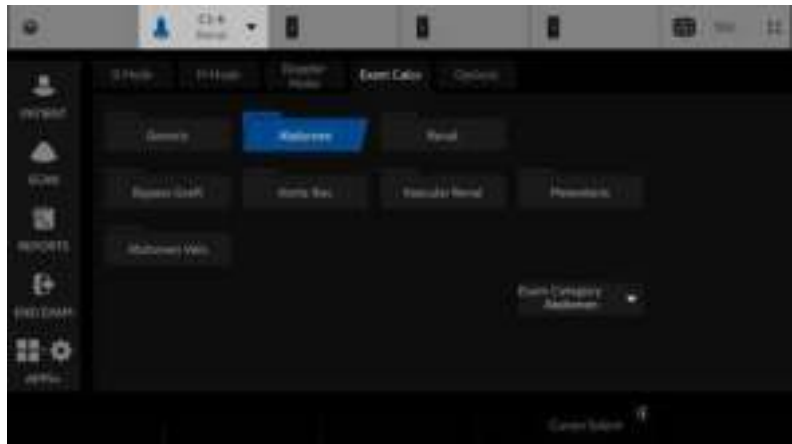

Figure 7-5. Exam Calcs Tab - example

#### Selecting a measurement in a different application

While scanning a patient, you may find that you want to measure an item that is not in the current application. In that case, Exam Category allows you to select other calculations without changing application.

1. Select **Exam Calcs** in the measurement mode.
2. Select **Exam Category**.
3. Select the exam category that has the calculation you want to make.
4. Select the study and the desired measurement.
5. After you complete the measurement, to return to the original application, repeat steps 1–4.

**NOTE:** This measurement **DOES NOT** appear on the original application worksheet.



## Options tab

The Options tab allows you to specify the following measurement and display options:

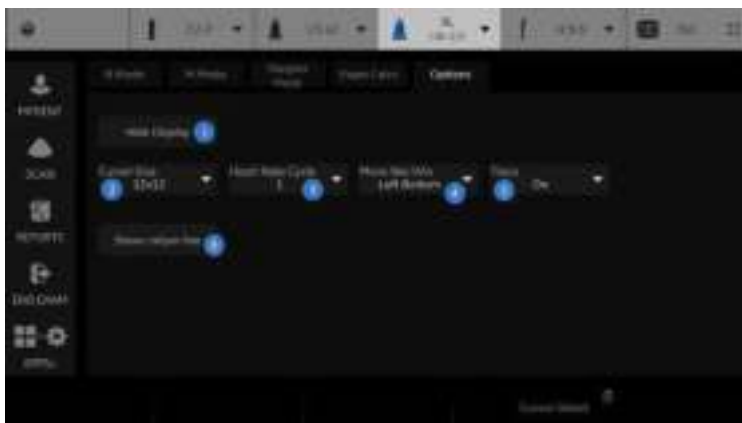

Figure 7-6. Measurement and Display Options - Example

Table 7-2: Measurement and Display Options

No.	Description
1.	Select <b>Hide Display</b> to hide the Results Window and Summary Window. Hide Display on the Touch Panel key is lit. To re-display them, select <b>Hide Display</b> again.
2.	The system displays the following choices: • 12 x 12 • 9 x 9
3.	Select <b>Heart Rate Cycle</b> to change the number of cycles used in the calculation. The system displays a list of choices from 1 – 10.
4.	You may want to change where the Results Window is positioned on the monitor display. To change the location of the Results Window, select <b>Move Res Win</b> . The system displays a list of choices.
5.	Select Auto or Manual for Doppler Trace. • Auto – the system traces the Doppler waveform from the begin time to the end time. • Manual – trace the waveform manually.
6.	After you press Set to complete the measurement, the dotted line remains on the display if the Show Caliper Line is selected. If Show Caliper Line is not selected, the system erases the dotted line and only the measurement calipers with a number or symbol are displayed. Note: The Show Caliper Line on the Options tab takes precedence over the Cursor Line Display preset, found on the System -> System Measure screen.

### **Push/Rotary button area**

At the bottom of the Touch Panel, there are six (6) combination rotary dials/push buttons. The functionality of these rotaries changes, depending upon the mode, exam category, study, etc.

### **Side Rt/Lt**

The system has measurements for the patient's right and left side. To change side, push or rotate the Side rotary button.

### **Delete**

Delete active caliper.

### **Cursor select**

When there are several measurements on the display, to rotate through and activate previously fixed calipers, push or rotate the Cursor Select rotary button.

## Exam category/Study/Measurement

For each patient, the system organizes information by exam category, study, and measurement. The definitions of these terms are as follows:

- **Exam Category** – categories include the following:
  - Abdomen
  - Obstetrics
  - Gynecology
  - Cardiology
  - Vascular
  - Urology
  - Small Parts
  - Pediatrics
- **Study/Preset** – after you choose an exam category, the system allows you to select a study. For example, when you choose the Obstetrics exam category, you can choose one of the following studies:
  - Generic
  - OB-1
  - OB-2/3
  - OB-General
  - Fetal Heart
  - OB/GYN Vessel
- **Measurement** – the measurements and calculations needed to analyze an item of anatomy. For example, a femur length is a measurement. A measurement can include several pieces of measurement data. For example, to calculate the ovarian volume, you need to measure width, length, and height.

### General Instructions

#### General Guidelines

Any measurement can be repeated by selecting that measurement again from the Touch Panel.

The system retains all measurements, but the worksheet retains only the last six measurements of each type.

#### Measurement and calculation results

As you take measurements, each measurement is given a sequential number on the display and in the Results Window. The system can display nine measurements on the screen at one time.

Once the Results Window has nine measurements, if you make any further measurements, the system erases the first measurement and adds the new measurement ("first in, first out").

Measurement graphics are kept while in cine scroll. The measurement graphic is redisplayed on the frame where it is taken, if preset "Keep Graphics with Cine Scroll" on the Advanced M&A page.

#### Selecting a calculation

When you take measurements, you can select the calculation before you take the measurement or after you take it. For example, in Obstetrics, if you select the calculation before you take the measurement, the estimated fetal age is displayed as you take the measurement. If you select the calculation after you take the measurement, the estimated fetal age is displayed after you complete the measurement.

**NOTE:** *After you take a measurement, if you select a calculation and the measurement is not applicable for the calculation, then the system assumes you want to start the calculation. The system then uses the calculation for the next measurement.*

## General Instructions (continued)

### Erasing measurements

These actions erase measurements from the system's memory:



- If you adjust the Trackball, unfreeze the image, or press Clear, the system erases all completed measurements and calculations on the display. Measurements and calculations, however, remain on the worksheets.
- If you select New Patient, the system erases all measurements and calculations on the display and clears the worksheets.
- If you make a new measurement that exceeds the maximum number of allowable measurements, the system erases the first (oldest) measurement and adds the new measurement.
- If the second caliper is active, to erase the second caliper and activate the first caliper, press Clear.

These actions you can take while performing measurements.



- Before making measurements, to stop the acquisition of image data, press **Freeze**.
- For measurements such as distance, to make fine adjustments before completing the measurements, press the top Trackball key to toggle between active calipers.
- Before completing the measurement sequence, to erase the active measuring caliper and the current data measured, press **Clear**.
- After the sequence is complete, to erase all data that has been measured to this point, but not data entered on worksheet pages, press **Clear**.
- When there are several measurements on the display, to rotate through and activate previously fixed calipers, adjust the **Cursor Select** knob. After a cursor is activated, you can change the measurement.  
*NOTE: If you want to change a trace measurement, you must erase it and trace again.*
- To repeat any measurement, select that measurement again from the Touch Panel.

Calculation formulas are available in the *Advanced Reference Manual*.

## Measurement Cursor

While you are making a measurement, the measurement cursor is either active (open plus sign) or fixed (closed plus sign). An active cursor is green and a fixed cursor is yellow.

The system allows you to identify measurements by number or by unique symbol. The symbols are used in sequence as listed. The first symbol is used for the first measurement, the second symbol for the second measurement, and so on.



Figure 7-7. Fixed Caliper Symbols

Measurement graphics are kept while in cine scroll. The measurement graphic is redisplayed on the frame where it is taken, if preset on the Advanced M&A page.

## Cursor preset

You can preset the measurement cursor in Utility -> System -> System Measure.



Figure 7-8. System/System Measure Preset Menu

Table 7-3: Cursor

Preset Parameter	Description
Cursor Type	Select whether to mark measurements with numbers or symbols.
Cursor Size	Specify 12x12 or 9x9.
Cursor Line Display	If selected, after you press Set to complete a measurement, the cursor line is displayed. If not selected, after you press Set to complete a measurement, only the cursor number or symbol is displayed.
Cursor Ellipse Cross Line Display	Check box to display the cross line in Ellipse.

Table 7-3: Cursor (Continued)

Preset Parameter	Description
D Manual Trace Cross Line Display	Check box to display the cross line with the caliper.
Cursor Position	Select 1st Cursor, 2nd Cursor, or Image Center.
Color When Set (reboot)	Select white, yellow, bright red, or orange.
Cursor is Displayed when Trackball is Moved	The active cursor does not display until you move the Trackball. This assumes the following presets are set: Repeat Measurement, Repeat, Default Measurement, and Cursor.

## Copy, move and paste measurement tools

You can copy, move and paste the measurement graphic.

**NOTE:** *This function is supported with trace, area trace, spline trace, volume trace, ellipse, 3-point ellipse, circle and intensity. The Double tools and Dual tools are not supported.*

### Copy and Paste

1. Measure the trace.
2. If present, clear the active caliper using the **Clear** key. Press the **Arrow** key to display the green arrow cursor on the screen. Move the cursor to the + mark of the measurement graphic. The selected graphic color changes from yellow to green.
3. Press **Set**. The pop-up menu displays. Select **Copy**.



Figure 7-9. Copy and Move Menu

4. Press **Set** on the outer side of the measurement graphic. The pop-up menu displays.
5. Select **Paste**. The copied graphic displays on top of the original graphic in green. Move it to the desired position using the **Trackball** and press **Set** to fix the location.

**NOTE:** *If the copied graphic is bigger than the pasted area, "Paste" fails and "The copied graphic cannot be pasted to this area" message displays on the status bar.*

### Copy and Move

1. Measure the trace.
2. If present, clear the active caliper using the **Clear** key. Press the **Arrow** key to display the green arrow cursor on the screen. Move the cursor to the + mark of the measurement graphic. The selected graphic color changes from yellow to green.
3. Press **Set**. The pop-up menu displays. Select **Copy&Move**.
4. The copied graphic displays on top of the original graphic in green. Move it to the desired position using the **Trackball** and press **Set** to fix the location.

### Move

1. Measure the trace.
2. If present, clear the active caliper using the **Clear** key. Press the **Arrow** key to display the green arrow cursor on the screen. Move the cursor to the + mark of the measurement graphic. The selected graphic color changes from yellow to green.
3. Press **Set**. The pop-up menu displays. Select **Move**.
4. Move the selected graphic to the desired position using the **Trackball** and press **Set** to fix the location.

### Performing Measurements on Saved Images

You can perform measurements on recalled images. Select the image, then perform the measurement. If the image was not saved as a raw DICOM image, you need to calibrate the image prior to performing the measurement.

To calibrate the image,

1. Recall the image.
2. Press **Measure**. The Measurement Calibration Touch Panel appears.
3. Select the mode you need to be in to perform the measurement.
4. Press the appropriate mode key on the Touch Panel (**2D calib** for B-Mode, **MM calib** for M-Mode, or **Dop. calib** for Doppler mode). The specified mode calibration pop-up appears.



## **Performing Measurements on Saved Images (continued)**

5. The system prompts you, depending on the mode.

B-Mode:

- a. Place the first point of the caliper on the ruler. Press **Set**.
- b. Position the cursor at the 5 cm point on the ruler. Press **Set**.
- c. Type "5" into the 2D-Mode Calibration pop-up window. Press OK.

M-Mode or Doppler Mode:

- a. Place the cross on zero depth and minimum or zero time.
- b. Place the cross on maximum depth and time.
- c. Type the time (in seconds) and velocity (cm/sec) in the M-Mode/Doppler Mode calibration pop-up window.

# Generic Measurements

## Overview

Each exam category has a Generic study. The Generic studies provide you quick access to measurements such as volume, angle, A/B ratio, and % stenosis. The particular measurements available in each Generic study vary, depending on the exam category and the mode. This section describes generic measurements, organized by mode.

To access Generic studies:

1. On the Control Panel, press **Measure**.
2. On the Touch Panel, select ***Exam Calcs***.
3. On the Touch Panel, select the ***Generic*** folder.

Calculation formulas are available in the *Advanced Reference Manual*.

## B-Mode Measurements

In B-Mode, the Generic study includes the following measurements:

- % Stenosis
- Volume
- Angle
- Velocity
- Stiffness
- V Ratio
- Stiff. Ratio
- A/B Ratio



Figure 7-10. B-Mode Generic Study

**NOTE:** *The following instructions assume that you first scan the patient and then press **Freeze**.*

### % Stenosis

You can calculate % Stenosis by diameter or by area, depending on the mode.

**NOTE:** *The LOGIQ Totus automatically activates the % Stenosis with the default selection. If another method is preferred, select it from the Touch Panel.*

### Diameter

**NOTE:** *When you use diameter to calculate the %stenosis, always take the measurement from a cross-sectional view of the vessel.*

To calculate percent stenosis by diameter:

1. From the Generic Touch Panel, select **% Stenosis**.
2. Select **%sten(Diam)**.  
The system displays an active caliper.
3. Make a distance measurement of the inner area of the blood vessel.  
The system displays an active caliper for the second distance measurement.
4. Make a distance measurement of the outer area of the blood vessel.

The system displays each distance measurement and the % Stenosis in the Results Window.

For details on how to make a distance measurement, See 'Distance measurement' on *page 7-39 for more information*.

**NOTE:** *For the diameter calculation, do NOT take a distance measurement from a longitudinal view. This may lead to an inaccurate assessment of % stenosis.*

**% Stenosis (continued)****Area**

To calculate percent stenosis by area:

1. From the Generic Touch Panel, select **% Stenosis**.
2. Select **%sten(Area)**.  
The system displays a caliper.
3. Make a trace measurement of the inner area of the blood vessel.

*NOTE:* To erase an open trace, move the **Trackball**.

4. Press **Set**.  
The system displays a second caliper.
5. Make a trace measurement of the outer area of the blood vessel.

The system displays the two area measurements and percent stenosis in the Results Window.

**Ellipse + Area**

To calculate percent stenosis by ellipse and area:

1. From the Generic Touch Panel, select **% Sten[E+A]** folder.
2. Ellipse is selected by default.  
The system displays a caliper.

*NOTE:* You can select the trace at this time.

3. Make an ellipse measurement of the inner area of the blood vessel.
4. Press **Set**.  
The system displays a caliper.
5. Make a trace measurement of the outer area of the blood vessel.

The system displays the two area measurements and percent stenosis in the Results Window.

*NOTE:* **% Stenosis (E+A)** is not available through the factory default. To enable **%Stenosis (E+A)**, add "%Steno(E+A)" to the Measure & Study list on the Utility -> Measure -> M&A screen.

### Volume

The volume calculation can be made from any of the following measurements:

- One distance
- Two distances
- Three distances
- One ellipse
- One distance and one ellipse

For details on how to make a distance measurement, See 'Distance measurement' on *page 7-39 for more information*.

For details on how to make an ellipse measurement, See 'Circumference and area (ellipse) measurement' on *page 7-41 for more information*.

**NOTE:** *IMPORTANT!! If you want to make a volume calculation using one or two distances, you must select **Volume** BEFORE you make the measurements.*

**NOTE:** *If you select Fix Caliper by Print Key on the Utility --> System --> System Measure, the print key does not function like the Set key, but instead ends the measurement sequence and initiates the volume calculation based on the number of measurements taken so far.*

To make a volume calculation using one or two distances:

1. Select **Volume**.
2. Make one or two distance measurements.
3. Select **Volume**.

The system displays the distances and the volume in the Results Window.

**NOTE:** *Use the **Clear** key to erase the green caliper.*

## Volume (continued)

To make a volume calculation using three distances:

1. Make three distance measurements.

**NOTE:** *Three distances can be done in the dual format mode (side by side images). One measurement is usually made in the sagittal plane and two measurements in the axial plane. To use the dual format mode, press the **L** or **R** key on front panel.*

2. Select **Volume**.

The system displays the distances and the volume in the Results Window.

To make a volume calculation using one ellipse:

1. Make one ellipse measurement.
2. Select **Volume**.

The system displays the ellipse measurement and the volume in the Results Window.

To make a volume calculation using one ellipse and one distance:

1. Make one distance measurement and one ellipse measurement.
2. Select **Volume**.

The system displays the distance and ellipse measurement and the volume in the Results Window.



### HINTS

- Volumes are most accurate when measurements are taken in the sagittal and axial scan planes.
- To display sagittal and axial plane images simultaneously, use the side-by-side dual format option.

**NOTE:** *If you change the parameters or category during the volume measurement, please follow the procedure below before you restart the measurement.*

1. Check the number of each measurement in the summary window.
2. If the numbers are not all the same, it shows that you have the calculation which is not completed. Open the Worksheet and clear that calculation.

**Volume (continued)**

Table 7-4: Volume Calculations

Calc Name	Input Measurements
Volume (spherical)	One distance
Volume (prolate spheroidal)	Two distances, $d_1 > d_2$
Volume (spheroidal)	Three distances
Volume (prolate spheroidal)	One ellipse: (d1 major axis, d2 minor axis)
Volume (spheroidal)	One distance d1, and one ellipse (d2 major axis, d3 minor axis)

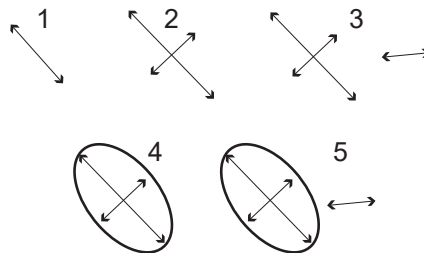

Figure 7-11. Volume Calculation Examples

1. One distance
2. Two distances
3. Three distances
4. One ellipse
5. One distance and one ellipse

Calculation formulas are available in the *Advanced Reference Manual*.



## Volume (continued)

### Post-assignment for General Volume

You can input a unique name for the general volume measurement. You can group the general volume measurements for each application.

1. Complete the volume measurement.
2. Move the caliper to the measurement result box (with green frame) and select **Set**.
3. The volume name menu appears. Select Name Volume.



Figure 7-12. Volume Name menu

4. The dialog box displays. Enter a new name or choose the existing name.



Figure 7-13. Volume Name Dialog box

**NOTE:** *The factory default volume name cannot be changed (for example, Renal Volume).*

### Angle

This function measures the angle between two intersecting planes.

1. From the Generic Touch Panel, select **Angle**.  
The system displays an active caliper.
2. To position the caliper at the start point, move the **Trackball**.
3. To fix the position of the first caliper, press **Set**.  
The system displays a second active caliper.
4. To position the second caliper at the apex of the angle, move the **Trackball**.
5. To fix the position of the second caliper, press **Set**.  
The system displays a third active caliper.
6. To position the third caliper, move the **Trackball**.
7. To complete the angle measurement, press **Set**.  
The system displays the angle in the Results Window.

*NOTE: To rotate through and activate previously fixed calipers, adjust the **Cursor Select** control.*

## A/B Ratio

In B-Mode, you can calculate A/B ratio by diameter or by area.

**NOTE:** *The LOGIQ Totus automatically activates the A/B Ratio with the default selection. If another method is preferred, select it from the Touch Panel.*

### Diameter

1. From the Generic Touch Panel, select **A/B Ratio**.
2. Select **ratio(Diam)**.  
The system displays an active caliper.
3. Make a distance measurement of the first diameter.  
The system displays an active caliper for the second distance measurement.
4. Make a distance measurement of the second diameter.  
The system displays each distance measurement and the A/B ratio in the Results Window.

**NOTE:** *The first distance is the A diameter. The second distance is the B diameter.*

For details on how to make a distance measurement, See 'Distance measurement' on page 7-39 for more information.

### Area

To calculate A/B ratio by area:

1. From the Generic Touch Panel, select **A/B Ratio**.
2. Select **ratio(Area)**.  
The system displays a caliper.
3. Make a trace measurement of the A area.  
**NOTE:** *To erase an open trace, move the **Trackball**.*  
The system displays a second caliper.
4. Make a trace measurement of the B area.  
The system displays the two area measurements and the A/B ratio in the Results Window.

For details on how to make a trace measurement, See 'Circumference and area (trace) measurement' on page 7-42 for more information.

### Dual Caliper

If “Dual Caliper on VNav and Simultaneous” is checked in Utility--> System--> System Measure menu, then when you enter simultaneous view, there is a “Dual Caliper: On/Off” setting on the Touch Panel. If the setting is on, dual caliper is enabled in simultaneous view.



Figure 7-14. Dual Caliper

### Velocity and Stiffness Ratios

If set to display via configuration settings, these two measurements appear. Refer to Elastography Option documentation.

## M-Mode Measurements

In M-Mode, the Generic study includes the following measurements:

- % Stenosis
- A/B Ratio
- HR (Heart Rate)

### % Stenosis

See '% Stenosis' on page 7-20 for more information.

### A/B Ratio

In M-Mode you can measure A/B ratio by diameter, time, or velocity.

*NOTE: The LOGIQ Totus automatically activates the A/B Ratio with the default selection. If another method is preferred, select it from the Touch Panel.*

### Diameter

See 'Diameter' on page 7-27 for more information.

### Time

To calculate A/B ratio by time:

1. Select **A/B**.
2. Select **ratio(Time)**.  
The system displays an active caliper.
3. To position the caliper at the A point, move the **Trackball**.
4. To fix the measure point, press **Set**.  
The system displays a second active caliper.
5. To position the second caliper at the B point, move the **Trackball**.
6. To complete the measurement, press **Set**.

The system displays the two time measurements and A/B ratio in the Results Window.

### A/B Ratio (continued)

#### Velocity

To calculate AB ratio by velocity:

1. Select **A/B**.
2. Select **ratio(Velocity)**.  
The system displays an active caliper with vertical and horizontal dotted lines.
3. To position the caliper at the A velocity, move the **Trackball**.
4. To fix the measure point, press **Set**.  
The system displays a second active caliper.
5. To position the second caliper at the B velocity, move the **Trackball**.
6. To complete the measurement, press **Set**.  
The system displays the two velocity measurements and the A/B ratio in the Results Window.

## Heart Rate

To calculate the heart rate from M-Mode:

1. Obtain an image and press Measure. Select **HR**.  
The system displays an active caliper.
2. To position the caliper at a recognizable point in the first cycle, move the **Trackball**.
3. To fix the first caliper, press **Set**.  
The system displays a second active caliper.
4. To position the caliper at the identical point in the next cycle (depending on preset), you need to move the **Trackball**.

**NOTE:** *In the message bar at the bottom of the display, the system indicates the number of cycles you should measure.*

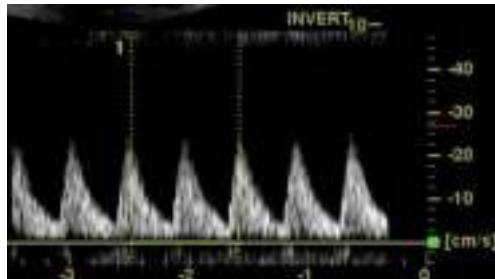

Figure 7-15. Two Heart Beat Reference (example in Doppler mode)

5. To complete the measurement and transfer the calculation to the worksheet, press **Set**.

**NOTE:** *For information about how to specify the number of heart beats that the system will use, See 'Options tab' on page 7-9 for more information.*

### Doppler Mode Measurements

In Doppler Mode, the Generic study includes the following measurements:

- PI (Pulsatility Index)
- RI (Resistive Index)
- PS/ED Ratio or ED/PS Ratio
- A/B Ratio
- HR (Heart Rate)

**NOTE:** *The following instructions assume that you do the following:*

1. In the B-Mode part of the display, scan the anatomy you want to measure.
2. Go to the Doppler Mode part of the display.
3. Press **Freeze**.

### Control Assignment

#### Cancel Transfer

**NOTE:** *Only for Vascular, Abdomen, OB and GYN.*

After the Auto Vascular calculation results are assigned to a particular vessel, the user can cancel the assignment and assigned parameters are removed from Worksheet and Report page.

When Cancel Transfer occurs, a message appears on the screen to indicate the value was erased from Worksheet and Report page.

#### Vessel location

If the vessel has a location, you can select one of the following:

- Proximal (**Prox**)
- Middle (**Mid**)
- Distal (**Dist**)

**NOTE:** *If you do not wish to assign a vessel location, press the lit location, then no location is assigned. Choose the folder you want the value assigned to.*

To select one of the locations, adjust the Touch Panel control.



## Pulsatility Index (PI)

For auto trace:

1. Select **PI**.  
The system displays a caliper and a vertical dotted line.
2. Position the caliper at the beginning of the waveform.
3. To fix the start point, press **Set**.  
The system displays a second active caliper.
4. Position the caliper at the end of the waveform.
5. To complete the measurement, press **Set**.  
The system displays peak systole, minimum diastole, end diastole, TAMAX, and PI in the Results Window.

For manual trace:

1. Select **PI**.  
The system displays a caliper and a vertical dotted line.
2. Position the caliper at the beginning of the waveform.
3. To fix the start point, press **Set**.  
The system displays a second active caliper.
4. Manually trace the entire waveform.
5. To complete the measurement, press **Set**.  
The system displays peak systole, minimum diastole, end diastole, TAMAX, and PI in the Results Window.

## Resistive Index (RI)

1. From the Doppler Generic Touch Panel, select **RI**.  
The system displays an active caliper with vertical and horizontal dotted lines.
2. To position the caliper at the peak systolic velocity, move the **Trackball**.
3. To fix the measure point, press **Set**.  
The system displays a second active caliper.
4. To position the second caliper at the end diastolic velocity, move the **Trackball**.
5. To complete the measurement, press **Set**.  
The system displays PS, ED, and RI in the Results Window.

### PS/ED or ED/PS Ratio

To calculate the Peak Systole/End Diastole ratio or End Diastole/Peak Systole ratio:

1. Select **PS/ED** or **ED/PS**.  
The system displays an active caliper with vertical and horizontal dotted lines.
2. To position the caliper at peak systole (PS) or end diastole (ED), move the **Trackball**.
3. To fix the measure point, press **Set**.  
The system displays a second active caliper.
4. To position the second caliper at end diastole (ED) or peak systole (PS), move the **Trackball**.
5. To complete the measurement, press **Set**.  
The system displays the peak systole, end diastole, and PS/ED or ED/PS ratio in the Results Window.

### Heart Rate

To measure heart rate, See 'Heart Rate' on *page 7-31 for more information*. or select any of the following measurements.

## A/B Ratio

In Doppler Mode you can measure A/B ratio by velocity, time, or acceleration.

*NOTE: The LOGIQ Totus automatically activates the A/B Ratio with the default selection. If another method is preferred, select it from the Touch Panel.*

### Velocity

See 'Velocity' on page 7-30 for more information.

### Time

See 'Time' on page 7-29 for more information.

### Acceleration

To measure A/B ratio by acceleration:

1. Select **A/B**.
2. Select **ratio(Acc)**.

The system displays an active caliper.
3. Make a distance measurement of the A acceleration point.
  - a. To position the active caliper at the start point, move the **Trackball**.
  - b. To fix the start point, press **Set**.

The system fixes the first caliper and displays a second active caliper.
  - c. To position the second active caliper at the end point, move the **Trackball**.

A dotted line connects the measurement points.
  - d. To complete the measurement, press **Set**.

The system displays the distance value in the Results Window and displays an active caliper for the second distance measurement.
4. To make a distance measurement of the B acceleration point, repeat steps a–d.

The system displays the two acceleration measurements and the A/B ratio in the Results Window.

### Acceleration

1. Select **Accel**.  
The system displays an active caliper with vertical and horizontal dotted lines.
2. To position the caliper at peak systole, move the **Trackball**.
3. To fix the measure point, press **Set**.  
The system displays a second active caliper.
4. To position the second caliper at end diastole, move the **Trackball**.
5. To complete the measurement, press **Set**.  
The system displays the peak systole, end diastole, acceleration time, and acceleration in the Results Window.

### Acceleration Time (AT)

1. Select **AT**. The system displays an active caliper and a vertical dotted line.
2. To position the caliper at the start point, move the **Trackball**.
3. To fix the first caliper, press **Set**.  
The system displays a second active caliper.
4. To position the caliper at the end point, move the **Trackball**.
5. To complete the measurement, press **Set**.  
The system displays the acceleration time in the Results Window.

### Peak Systole (PS), End Diastole (ED), or Minimum Diastole (MD)

- To calculate the peak systole, end diastole, or minimum diastole:
1. Select **PS**, **ED**, or **MD**.  
The system displays an active caliper with vertical and horizontal dotted lines.
  2. To position the caliper at the measurement point, move the **Trackball**.
  3. To complete the measurement, press **Set**.  
The system displays the peak systole, end diastole, or minimum diastole in the Results Window.

## Helpful hints



### HINTS

The following hints can help when making a measurement

- Prior to making measurements, use the Cine function, if necessary, to display the best image.
- As you take measurements, each measurement is given a sequential number on the display and in the Results Window. Nine measurements can be displayed in the Results Window at one time.
- Once the Results Window has nine measurements, if you make any further measurements, the system erases the top (first) measurement and adds the new measurement last ("first in, first out").
- While you are taking a measurement, the value in the Results Window updates until you complete the measurement.

# Mode Measurements

## B-Mode Measurements

The following measurements can be made in B-Mode.

- Distance
- Circumference
- Circumference and Area
  - Ellipse Method
  - Trace Method
  - Spline Method
  - Intensity (Echo level) Method

*NOTE:* The following instructions assume that you first scan the patient and then press **Freeze**.



WARNING

DO NOT perform a depth measurement using 4D probes.

## Distance measurement

To make a distance measurement:

1. Press **Measure** once; an active caliper displays.
2. To position the active caliper at the start point, move the **Trackball**.
3. To fix the start point, press **Set**.  
The system fixes the first caliper and displays a second active caliper.
4. To position the second active caliper at the end point, move the **Trackball**.  
A dotted line connects the measurement points, if preset accordingly.
5. To complete the measurement, press **Set**.  
The system displays the distance value in the Results Window.



### HINTS

- **Before** you complete a measurement:
  - To toggle between active calipers, press the top Trackball key.
  - To erase the second caliper and the current data measured and start the measurement again, press **Clear** once.
- **After** you complete the measurement:
  - To rotate through and activate previously fixed calipers, adjust **Cursor Select**.
  - To erase all data that has been measured to this point, but not data entered onto worksheets, press **Clear**.

### Circumference measurement

#### Open Trace

To trace the circumference of a portion of the anatomy and calculate its length:

*NOTE: Set **OpenTrace** to the Touch Panel in Utility -> Measure before perform the measurement. See 'Display/hide a folder or a measurement in the Touch Panel' on page 7-80 for more information.*

1. Press **Measure**.
2. Select **Open Trace** from the Touch Panel.
3. Position the caliper at the start point.
4. To fix the trace start point, press **Set**. The caliper changes to an active caliper.
5. Move the **Trackball** to trace the measurement area. A dotted line shows the traced area.
6. To complete the measurement, press **Set**. The system displays the circumference in the Results Window.



## Circumference and area (ellipse) measurement

You can use an ellipse to measure circumference and area. To measure with an ellipse:

1. Press **Measure** once; an active caliper displays.
2. To position the active caliper, move the **Trackball**.
3. To fix the start point, press **Set**. The system fixes the first caliper and displays a second active caliper.
4. To position the second caliper, move the **Trackball**.
5. Adjust the **Ellipse** control; an ellipse with an initial circle shape displays.
6. To position the ellipse and to size the measured axes (move the calipers), move the **Trackball**.
7. To increase the size, adjust the **Ellipse** control in a clockwise direction. To decrease the size, adjust the **Ellipse** control in a counterclockwise direction.
8. To toggle between active calipers, press the top **Trackball key**.
9. To complete the measurement, press **Set**. The system displays the circumference and area in the Results Window.



### HINTS

Before you complete the ellipse measurement:

- To erase the ellipse and the current data measured, press **Clear** once. The original caliper is displayed to restart the measurement.
- To exit the measurement function without completing the measurement, press **Clear** a second time.

### Circumference and area (trace) measurement

To trace the circumference of a portion of the anatomy and calculate its area:

1. Press **Measure**.
2. Press the top **Trackball key** to select Trace; a caliper displays.
3. To position the caliper at the start point, move the **Trackball**.
4. To fix the trace start point, press **Set**. The caliper changes to an active caliper.
5. To trace the measurement area, move the **Trackball** around the anatomy. A dotted line shows the traced area.
6. To complete the measurement, press **Set**. The system displays the circumference and the area in the Results Window.



#### HINTS

Before you complete the trace measurement:

- To erase the line (bit by bit) back from its current point, move the **Trackball** or adjust the **Ellipse** control counterclockwise.
- To erase the dotted line but not the caliper, press **Clear** once.
- To clear the caliper and the current data measured, press **Clear** twice.

## Circumference and area (spline trace) measurement

To trace the circumference of a portion of the anatomy and calculate its area:

**NOTE:** *Spline trace is not available through the factory default. The system defaults to trace. To enable spline trace, modify the Measure Key Sequence preset found in Utility -> Measure -> Advanced preset menu.*

1. Press **Measure**.
2. Press the top **Trackball key** to select Spline Trace; a caliper displays.
3. To position the first caliper at the start point, move the **Trackball**.
4. To fix the trace start point, press **Set**. The first caliper turns yellow. The second caliper appears at the same position as the first caliper and is green.

**NOTE:** *When pressing the **Clear** key once, the second caliper disappears and the first caliper is activated.*

*If **Clear** is pressed again, the first caliper disappears and the Spline trace is cancelled.*

5. To position the second caliper, move the **Trackball** and press **Set**. The third caliper appears at the same position.

**NOTE:** *The **Clear** key functionality is the same as noted in the previous step.*

The spline trace requires at least three points to draw the trace. Continue setting the points of the trace until the desired points are set.

6. Press **Set** again after the last caliper is fixed to finalize the spline trace. All points are removed from the line and the spline trace turns yellow.

**NOTE:** *Pressing **Set** twice finishes the trace measurement.*

If **Clear** is pressed twice when more than 3 points exist on the trace, all points are removed and the first caliper again displays.

### Circumference and area (spline trace) measurement (continued)

#### Edit the spline trace

1. Select **Cursor Select**. The spline trace changes to green and all points appear on the trace as yellow.

A pick-caliper appears on the center of the image and the message "Edit spline trace" displays at the bottom of the screen.

**NOTE:** *The pick-caliper is used to select and move the trace points.*

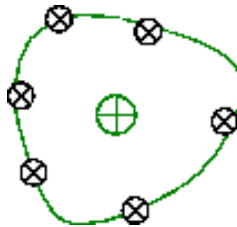

Figure 7-16. Edit spline trace

Select **Cursor Select** again. The trace is deactivated (changes to yellow) and all points, including the pick-caliper, are removed.

If the previous/next fixed caliper exists on the image, it is activated.

**NOTE:** *Pressing **Clear** at this time removes all points and the trace graphic.*

2. Move the pick-caliper to the desired point and press **Set**. The point is activated and turns green.
3. Move the point to the desired position and press **Set**. The point is fixed and turns yellow. The pick-caliper appears on the center of the image.

**NOTE:** *The spline trace is updated at run time.*

**NOTE:** *To remove a point, press **Clear** while moving the point. The trace turns green and the remaining points continue to be shown as yellow. If there are less than three points, the spline trace is removed.*

4. Press **Set** again. All points are removed from the trace and the trace is shown as yellow.

## Intensity (Echo level) measurement

To make an echo level measurement:

1. Press **Measure**.
2. Press the top Trackball key to select Intensity. A caliper displays.
3. To position the caliper at the start point, move the **Trackball**.
4. To fix the trace start point, press **Set**. The caliper changes to an active caliper.
5. To trace the measurement area, move the **Trackball** around the anatomy. A dotted line shows the traced area.
6. To complete the measurement, press **Set**. The system displays the echo level, as EL \_\_ dB, in the Results Window.

*NOTE: The echo level measurement is only available on a frozen image, not on a B-paused image.*

*NOTE: Echo Level is not available through the factory default. To enable echo level, modify the Measure Key Sequence preset, found in the Utility -> Measure -> Advanced preset.*

## Doppler Mode Measurements

Four basic measurements can be made in Doppler Mode.

- Velocity
- TAMAX and TAMEAN (Manual or Auto Trace)
- Two Velocities with the Time Interval and Acceleration between them
- Time Interval
- Volume Flow

*NOTE: The following instructions assume that you do the following:*

1. In the B-Mode part of the display, scan the anatomy you want to measure.
2. Go to the Doppler Mode part of the display.
3. Press **Freeze**.

### Velocity

To measure velocity:

1. Press **Measure**; an active caliper with a vertical dotted line displays.
2. To position the caliper at the desired measurement point, move the **Trackball**.
3. To complete the measurement, press **Set**. The system displays the velocity measurement in the Results Window.

### Slope (Velocity, Time Interval and Acceleration)

To measure two velocity values, the time interval (ms), and acceleration ( $\text{m/s}^2$ ):

1. Press **Measure**. Press the top Trackball key to select Slope; an active caliper with vertical and horizontal dotted lines displays.
2. To position the caliper at the start point, move the **Trackball**.
3. To fix the start point, press **Set**. The system fixes the first caliper and displays a second active caliper.
4. To position the second caliper at the end point, move the **Trackball**.
5. To complete the measurement, press **Set**. The system displays the two peak end point velocities, the time interval, and the acceleration in the Results Window.

### Time interval

To measure a horizontal time interval:

1. Press **Measure**. Press the top Trackball key to select Time; an active caliper with vertical and horizontal dotted lines displays.
2. To position the active caliper at the start point, move the **Trackball**.
3. To fix the start point, press **Set**. The system fixes the first caliper and displays a second active caliper.
4. To position the second caliper at the end point, move the **Trackball**.
5. To complete the measurement, press **Set**. The system displays the time interval between the two calipers in the Results Window.

## TAMAX and TAMEAN

### Manual Trace

The value measured depends upon the Vol Flow Method preset. The two selections available are: Peak (TAMAX) and Mean (TAMEAN).

To do a manual trace of TAMAX or TAMEAN:

1. Press **Measure**. Press the top Trackball key to select Trace; a caliper displays. Select **Manual** on the Touch Panel.
2. To position the caliper at the trace start point, move the **Trackball**.
3. To fix the start point, press **Set**.
4. To trace the velocity spectrum boundary, move the **Trackball**.

*NOTE: To edit the trace line, move the Trackball.*

5. To complete the measurement, press **Set**. The system displays the measurement values in the Results Window.

### Auto Trace

The value measured depends upon the Vol Flow Method preset. The two selections available are: Peak (TAMAX) and Mean (TAMEAN).

To auto trace TAMAX:

1. Press **Measure**. Press the top Trackball key to select Trace; an active caliper with a vertical dotted line displays. Select **Auto** on the Touch Panel.
2. To position the caliper at the trace start point in the Doppler spectrum, move the **Trackball**.
3. To fix the start point, press **Set**.
4. To position the vertical caliper at the end point, move the **Trackball**.
5. To complete the measurement, press **Set**. The system automatically fixes both calipers and traces the maximum value between the two points. The system displays this value in the Results Window.

*NOTE: When you set the Auto Trace for Both (above and below), the system picks up the maximum power of the signal, NOT the maximum velocity. If the maximum velocity is not the maximum power, the system may not trace accurately. If you want to use maximum velocity, select either Above or Below.*

### Edit Trace

Auto Trace can be edited after taking an Auto Trace measurement.

1. After taking an Auto Trace measurement, select the measurement result on the result window. The Edit Trace (Edit Peak or Edit Mean) menu window appears.

*NOTE: If the system cannot take the trace data correctly from the image, Edit Trace does not work.*

2. Select Edit Trace. The first caliper (manual trace caliper) appears on the center of the image. Use the **Trackball** to move the caliper on the trace line to the start point.

*NOTE: To cancel Edit Trace at this time, press **Clear**, **Scan**, or **Freeze**.*

3. Press **Set** to fix the first caliper. The second caliper appears. Edit the trace manually using the second caliper.

The Ellipse control is used to edit the trace.

*NOTE: When pressing the **Clear** key once at this time, the second caliper disappears and the first caliper appears in the center of the image.*

*NOTE: If you press **Scan** or **Freeze** at this time, the caliper is automatically fixed and the result window updates.*

4. Press **Set** to fix the second caliper. The trace and the result window update. The trace data (TAMAX and TAMEAN) are updated, though the other points (e.g. PS, ED) are not updated by trace. The points can be edited with **Cursor Select**.

*NOTE: While in Edit Trace, Cursor Select is disabled.*

5. Repeat Edit Trace as needed.



### Doppler Auto Calc Average Cycle

When using Auto Calc, a selection is available to average a number of cycles automatically. There is also a preset selection in the Utility Imaging PW page for this feature. When using average cycle:

- Selected cardiac cycle lines display on the image. Point calipers are not displayed.
- When changing the number of cycles from 1 to >1, all the data is reacquired from the image, recalculated and updated.
- When multiple cycles are selected in AutoCalc, the average values calculate and display automatically.
- When selecting Peak Value (PV), average cycle is not available.

**NOTE:** *You cannot edit the lines while in Average Cycle. Cursor Select is not available at that time.*

**NOTE:** *Average Cycle data is acquired from the display image area only, for both live and frozen. The average cycle data fails if the setting for the number of cycles is larger than the number of image cycles.*



Figure 7-17. PW Touch Panel

### Volume Flow - Manual Calc

You perform a manual Volume Flow measurement using the TAMAX plus a Volume Flow coefficient compensation.

1. To perform the Volume Flow measurement using the TAMAX plus a Volume Flow coefficient compensation, in Utility-->Measure-->Advanced, select the following:
  - Trace = Manual
  - Vol Flow Method = TAMAX [you MUST also select a Volume Flow coefficient for use with TAMAX.]
  - Vol Flow Compensation with TAMAX = [select value from 0.5 to 1.0]
2. Set Auto Calcs to Off via Doppler Mode-->Modify Auto Calcs-->Off.
3. Select a folder in Doppler Mode-->select a calculation folder-->select Show All.
4. Select **Volume Flow**. You'll notice that TAMAX is automatically selected.

*NOTE: Ensure that you have placed the caliper in the spectral window when selecting the Volume Flow measurement.*

5. Trace the TAMAX. The system prompts you to "Mark the first point on the spectral doppler." Press **Set**.
6. The system prompts you to "Trace the velocity spectrum boundary." Press **Set**.

*NOTE: You can back up while tracing the TAMAX by using the Trackball.*

7. Trace the vessel diameter. The system prompts you to "Mark first point of vessel diameter for volume flow calculation." Press **Set**.
8. The system prompts you to "Mark last point of vessel diameter for volume flow calculation." Press **Set**.
9. The Volume Flow is calculated in ml/min.

## Volume Flow - Auto Calc

You can perform an automatic Volume Flow measurement using TAMEAN or using the TAMAX and a Volume Flow coefficient.

1. To perform the Volume Flow measurement using the TAMEAN, in Utility-->Measure-->Advanced, select the following:
  - Trace = Auto
  - Vol Flow Method = TAMEANOR, to perform the Volume Flow measurement using the TAMAX plus a Volume Flow coefficient compensation, select the following:
  - Trace = Auto
  - Vol Flow Method = TAMAX [if you use TAMAX, you MUST also select a Volume Flow coefficient for use with TAMAX.]
  - Vol Flow Compensation with TAMAX = [select value from 0.5 to 1.0]
2. Set Auto Calcs to Live via Doppler Mode-->Modify Auto Calcs-->Live.
3. Perform the scan.
4. Select **Volume Flow** via Doppler Mode-->Modify Auto Calcs-->VOLUME FLOW. The system prompts you through the measurement.
5. Take vessel diameter for volume flow calculation. Set the first cursor.
6. Mark last point of vessel diameter for volume flow calculation. Press **Set**.
7. The calculation automatically completes the Volume Flow measurements as ml/min.

**NOTE:** *If you change the TAMAX coefficient, the Volume Flow is automatically adjusted when in Auto Calcs (but not in Manual Calcs).*

### Flow Volume (FV)

Flow Volume estimates the volume of blood that flows through a vessel per unit time. It is derived from a vessel's cross-sectional diameter obtained from the B-Mode portion of the image and the mean velocity of flow in the vessel obtained from the Doppler portion of the image. It is measured in milliliters. When the FV measurement is made, FVO is automatically calculated.

To measure flow volume:

1. Select **FV** from Doppler Touch Panel.
2. Place the dotted horizontal line caliper at each of the time base on the Doppler spectrum.
  - If Trace Auto is selected, the waveform is automatically traced.
  - If Trace Auto is not selected, manually trace the desired portion of the waveform.

The caliper moves to the B-Mode area.

3. Use the Ellipse or Trace method to measure the circumference and area of the vessel.

The flow volume (FV) is calculated and displayed in milliliters. The flow volume output (FVO) is also calculated and displayed in milliliters/minute.

### Flow Volume Output (FVO)

This measurement is used to measure the flow volume output in a vessel on the Doppler spectrum. It is measured in milliliters/minute. When the FVO measurement is made, FV is automatically calculated.

## Auto vs. Manual Calculations

The same calculations can be performed using either manual or auto calcs.

### Manual Calcs

To perform manual calcs:

1. To turn Auto Calcs off and perform manual measurements, choose **Auto Calcs -> OFF** on the PW tab of the Touch Panel.
2. After obtaining a waveform, press **Measure**. Choose the appropriate vessel folder or calculation. The system walks you through the measurement.

*NOTE: To program which calculations are done under manual calcs when using measurement folders for measuring specific vessels, press the Utility key. Select Measure -> Doppler and program your manual calcs (Auto Calcs OFF). Each vessel must be programmed individually and saved after each change.*

### Auto Calcs

To perform auto calcs:

1. Ensure that the auto calcs function is on by choosing **Auto Calcs -> Frozen or Live** on the Doppler tab of the Touch Panel.
  - Live: Auto calculation activates when the system is in real-time.
  - Frozen: Auto calculation activates when you press Freeze.
  - Off
2. After obtaining a waveform, press **Measure**. Choose the appropriate vessel folder, side and location. The measurements that are pre-programmed are performed automatically and entered in the worksheet.

To modify auto calcs:

1. Select **Modify Auto Calcs** on the Touch Panel.
2. Choose the measurements to be performed with this preset.
3. To save these measurements:
  - If this is a temporary change, press **Return**.
  - If this is a permanent change, select **Save as default**.

The measurements are saved and can be performed with the auto calcs function.

### Edit Auto Calcs

Auto Calcs can be edited after taking an Auto Trace measurement.

1. After taking an Auto Calc with a trace, select the measurement result on the result window. The Edit Trace menu window appears.

*NOTE: If the system cannot take the trace data correctly from the image, Edit Trace does not work.*

2. Select Edit Trace. The first caliper (manual trace caliper) appears on the center of the image. Use the **Trackball** to move the caliper on the trace line to the start point.

*NOTE: To cancel Edit Trace at this time, press **Clear**, **Scan**, or **Freeze**.*

3. Press **Set** to fix the first caliper. The second caliper appears. Edit the trace manually using the second caliper.

The Ellipse control is used to edit the trace.

*NOTE: When pressing the **Clear** key once at this time, the second caliper disappears and the first caliper appears in the center of the image.*

*NOTE: If you press **Scan** or **Freeze** at this time, the caliper is automatically fixed and the result window updates.*

4. Press **Set** to fix the second caliper. The trace and the result window are updated. The data is retaken from the trace and updated.

*NOTE: While in Edit Trace, **Cursor Select** is disabled.*

The trace data (TAMAX and TAMEAN) is updated, but the other selections (e.g. PS, ED) are not updated by trace. The points can be edited using **Cursor Select** if needed.

5. Repeat Edit Trace as needed.

## Modify Auto Calcs

When you select this key, the Modify Calculation menu is displayed as below. In this menu, you select parameters to display in the Auto Vascular Calculation window. Only parameters that can be used by the calculation are displayed.

Select **Save as Default** to save the selected parameters as the default calculations for this application.

Select **Return** to return to the previous Touch Panel screen.

If you select **PV**, all selected parameters are turned off. When you deselect **PV**, the system returns to the previously selected calculation.

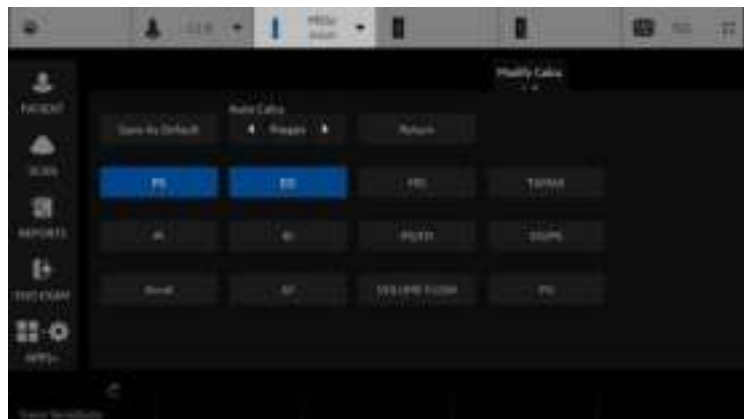

Figure 7-18. Modify Auto Calculation Menu

### M-Mode Measurements

Basic measurements that can be taken in the M-Mode portion of the display are:

- Tissue Depth (Distance)
- Time Interval
- Time Interval and Velocity



CAUTION

DO NOT perform a depth measurement using 4D probes.

*NOTE:* The following instructions assume that you do the following:

1. In the B-Mode part of the display, scan the anatomy you want to measure.
2. Go to the M-Mode part of the display.
3. Press **Freeze**.

### Tissue depth

Tissue depth measurement in M-Mode functions the same as distance measurement in B-Mode. It measures the vertical distance between calipers.

1. Press **Measure** once; an active caliper with a vertical and horizontal dotted line displays.
2. To position the active caliper at the most anterior point you want to measure, move the **Trackball**.
3. To fix the start point, press **Set**.  
The system fixes the first caliper and displays a second active caliper.
4. To position the second caliper at the most posterior point you want to measure, move the **Trackball**.
5. To complete the measurement, press **Set**.

The system displays the vertical distance between the two points in the Results Window.



## Time interval

To measure a horizontal time interval and velocity:

1. Press **Measure**. Press the top Trackball key to select Time; an active caliper with vertical and horizontal dotted lines displays.
2. To position the caliper at the start point, move the **Trackball**.
3. To fix the first caliper, press **Set**. The system fixes the first caliper and displays a second active caliper.
4. To position the second caliper at the end point, move the **Trackball**.
5. To complete the measurement, press **Set**. The system displays the time interval between the two calipers in the Results Window.

## Slope (Time interval and Velocity)

To measure time and velocity between two points:

1. Press **Measure**. Press the top Trackball key to select Slope; an active caliper with vertical and horizontal dotted lines displays.
2. To position the active caliper at the start point, move the **Trackball**.
3. To fix the start point, press **Set**.  
The system fixes the first caliper and displays a second active caliper.
4. To position the second caliper at the end point, move the **Trackball**.
5. To complete the measurement, press **Set**.  
The system displays time(s) and slope between the two points in the Results Window.

# Worksheet

## **Introduction**

The worksheet function enables the user to review, edit, delete or print data independently of a report. All measurements and calculations taken during the examination can be viewed at any time using the worksheet.

As you complete measurements, the system puts measurement data in the appropriate worksheets.

*NOTE: Worksheets are not saved if the system crashes.*

## To view a worksheet

To view a worksheet, select **Worksheet** on the Touch Panel.

OR

Select **Worksheet** on the measurement summary window.

The system displays the worksheet for the current study.



Figure 7-19. OB Worksheet

The OB Worksheet has three sections of information:

1. Patient data
2. Measurement information
3. Calculation information

To return to scanning, do one of the following:

- Select **Worksheet**.
- Press **Esc**.
- Select the **Exit** button.

### To view a worksheet (continued)

To view a different worksheet, select the worksheet key for the desired exam.

To view worksheet data for a particular mode, select the key for that mode. To view a worksheet with data for more than one mode, select **Expand**. When Expand is selected, it defaults to view all measurements, noted by mode, on the worksheet.

If a worksheet has more data on a second page, to view the next page, adjust the **Page Change** control.

### To edit a worksheet



Some fields on the worksheet are view only, and others you can change or select. To easily see which fields you can change or select, move the **Trackball**. As the cursor moves over a field that you can change or select, the field is highlighted.

### Change data

1. Select **Worksheet** from any page of the Vascular Calculation Touch Panel.
2. Position the cursor at the field you want to change by moving the **Trackball**.  
The cell is highlighted. Press **Set**. The field backlights.
3. Type the new data in the field and move the cursor to another place. Press **Set**. The new data, displayed in blue with an asterisk, is appended to the updated value and resultant value to indicate that it was manually entered.

The average measurements, calculations and ratios are automatically updated to reflect the edited values.

**NOTE:** *If the user moves the cursor to the edited value and presses the **Set** key once, the value returns to the original value before the edit was made.*

## To edit a worksheet (continued)

### Exclude data

When the user selects a particular value on the Worksheet and selects **Exclude Value**, this value is excluded from result line and resultant value is re-calculated without this value and also calculation values using this value is 'blank'.

1. To position the cursor at the field you want to delete or exclude, move the **Trackball**. The field is highlighted.
2. Do one of the following:
  - To exclude the field, select **Exclude Value**.  
The data in the field is not visible and is not included in worksheet calculations.
  - To include a value that you previously excluded, select **Exclude Value**.

### Delete data

1. Select **Worksheet** from any page of the Vascular Calculation Touch Panel Menu.
2. Position the cursor at the field you want to delete or exclude by moving the **Trackball**.  
The field is highlighted.
3. Select **Delete Value** from the Touch Panel.

For Example:

1. If the user measured RI 4 times, the latest 3 sets of RI measurements are displayed in the worksheet.

Table 7-5: Example of Latest Measurements in Worksheet

Result Number	#2	#3	#4
PS	0.500	0.600	0.700
ED	0.100	0.200	0.300
RI	0.800	0.667	0.571

To edit a worksheet (continued)

- 2. Then, the user deleted PS value of #3 from the worksheet.
- 3. Then, if the user deletes the PS value in column #3 from the worksheet, the whole set of measurements from column #3 is deleted from the worksheet and measurements from column #1 are shifted and displayed, as below.

Table 7-6: Example of Latest Measurements in Worksheet

Result Number	#1	#2	#4
PS	0.500	0.600	0.700
ED	0.100	0.200	0.300
RI	0.800	0.667	0.571

Examiner's comment

To type a comment on a worksheet:

- 1. Select **Examiner's Comments**. The Examiner's Comments window opens.
- 2. Type comments about the exam.
- 3. To close the Examiner's Comments window, select **Examiner's Comments**.

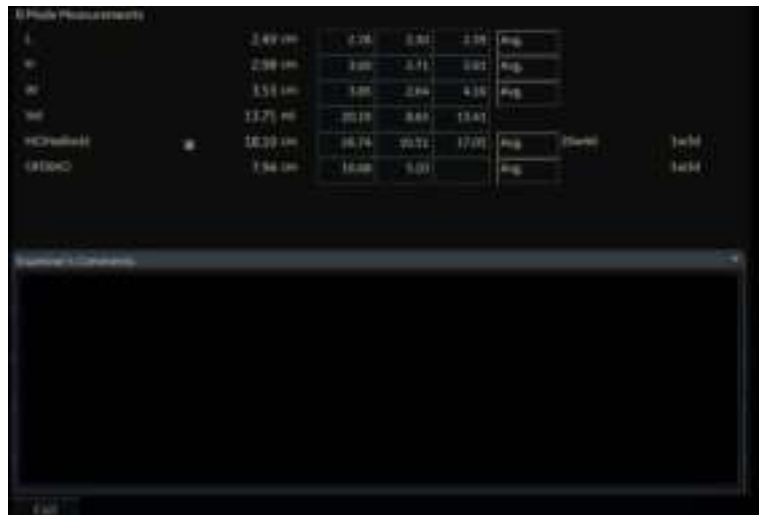

Figure 7-20. Examiner's comments field

## To edit a worksheet (continued)

### Volume measurement value off

1. Select the method type **Off**. The value field becomes blank.

### To select a method

1. Move the cursor over the value in the method column and press **Set**.
2. The pull-down menu displays. Move the cursor to select the method and press **Set**. The selected method is displayed in the column.



Figure 7-21. Pop-up menu of methods - example

1. Avg.: Average of the measurements taken
2. Max.: Maximum measurement
3. Min.: Minimum measurement
4. Last: Last measurement that was taken

### Delete All Worksheet Values

You can delete all worksheet values on a worksheet.

1. When the Worksheet is displayed on the monitor, press the **Clear** key; the following warning message appears:



Figure 7-22. Delete All Warning Message

2. Select **OK** to delete all.  
Select **Cancel** to cancel the deletion.

### Recording Worksheet

The worksheet can be saved as you would any ultrasound image. Once it is displayed on the screen, it can be recorded on the DVR, printed on the B/W printer, stored on media with the Image Archive option, or placed on regular paper with a line printer.



## OB Worksheet

### Patient data

The Patient data section, at the top of the worksheet, lists information from the Patient Data Entry screen.

You can select the following fields:

- FetusNo – if this is a multi-gestational patient, you can select the fetus in this field. You can also adjust the **Fetus** selection to change the fetus.
- CUA/AUA – select the ultrasound age calculation method
  - Composite Ultrasound Age (CUA) – regression calculation
  - Average Ultrasound Age (AUA) – an arithmetic average

You can select the method in this field, or adjust the **Select CUA/AUA** control.

**NOTE:** *CUA/AUA is only available when you select USA OB Type in the Utility -> System -> System Measure menu.*

You can enter information in the following fields:

- FetusPos – type information about the fetus position.
- PLAC – type information about the placenta.

### Calculation information

This section of the worksheet provides calculation choices and lists calculation results.

- EFW – lists the parameters used to calculate EFW. This is followed by the calculation result.

To change which parameters are used:

- a. Select this field or press **Select EFW**.
- b. Select the desired parameters.

- EFW GP – lists the source used to calculate EFW–GP (growth percentile). This is followed by the growth percentile.

To change the source:

- a. Select this field or press **Select GP**.
- b. Select the desired source.

The remaining calculation information shows ratios for several measurements, and the Cephalic Index (CI).

The worksheet shows if any of the ratios are out of range (OOR). Out of range indicates one of the following:

- The measurement is out of the normal range based on the gestational age that is calculated from the LMP. The system determines OOR from the ultrasound age compared to the gestational age. The gestational age is calculated from the last menstrual period or the estimated delivery date.
- The measurement is outside of the range for the data used in the calculation. That means that the measurement is either less than or more than the range of measurements used to determine fetal age based on the measurement.

For more information about how to use the worksheet, see 'Worksheet' on page 7-58 for more information.

## Vascular Worksheet

### Intravessel ratio

On the Vessel Worksheet page, to calculate the Intravessel ratio, you need a measurement of assessing pressure and stenotic velocities.

1. Select **Intrav. Ratio** from the Touch Panel. The Intravessel Ratio pop-up window displays in the header section of the worksheet.

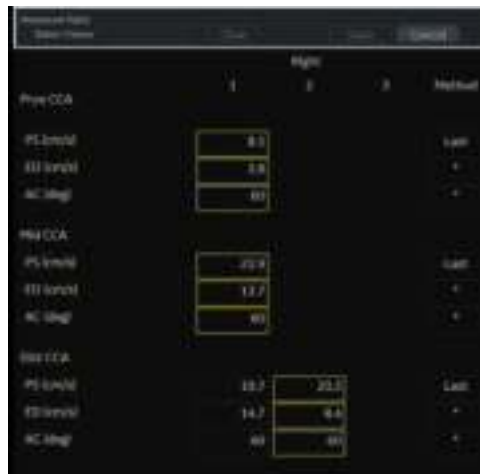

Figure 7-23. Intravessel Pop-up Window

2. Select the first velocity. The value displays in the window. The value is displayed in the window.

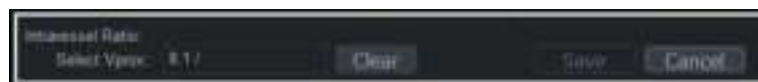

Figure 7-24. Intravessel ratio one

### Intravessel ratio (continued)

3. Select the second velocity.

The second value and Result value display in the window.

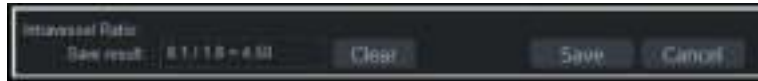

Figure 7-25. Intravessel ratio two

- To save the Intravessel ratio to the Vessel Summary, move the cursor to **Save** and press **Set**.
- To clear values, move the cursor to **Clear** and press **Set**.
- To cancel and exit Intravessel ratio, move the cursor to **Cancel** and press **Set**.

**NOTE:** *Intravessel Ratio is only displayed and saved in the Vessel Summary as Intra-Ratio.*

### Vessel Summary

The Vessel Summary is designed to automatically display measurements made at specific anatomical sites. Calculated ratios are automatically summarized and displayed.

The Vessel Summary can be displayed at any time during the exam by selecting **Vessel Summary** from the Vascular Worksheet Touch Panel.



	Right			Left		
	PS	FS	ac	PS	FS	ac
Right CCA	8.12cm/s	7.8cm/s	95%	11.0cm/s	10.0cm/s	91%
Right ICA	20.9cm/s	22.2cm/s	106%	22.2cm/s	8.3cm/s	37%
Left CCA	25.5cm/s	8.6cm/s	34%	19.4cm/s	11.5cm/s	59%
Intra Ratio	4.51					

Figure 7-26. Vessel Summary Example

## Vessel Summary (continued)

1. The first row, indicating Right or Left, is not displayed when the side is not defined in the vessel. In the third column on the second line, you select the calculations. Move the cursor to the third column, and the pop-up menu is displayed. The selected parameter is displayed in every third column.



Figure 7-27. Pop-up menu

2. Vessel Name with location information.
3. Check Box. Use to select the vessel velocity for calculating the vessel ratio (ex. ICA/CCA). You can only select one location (position) in a vessel.
4. Result value column. This value cannot be changed or excluded from this page.
5. Calculation name and result. ICA/CCA: The ICA/CCA ratio selects the highest systolic ICA and CCA velocities when calculating this ratio, and displays the velocities.

### Carotid Study

In the configuration page for ICA/CCA ratio, you can specify which portion of the CCA vessel (Prox, mid, distal) is chosen. You can override the selections on the Vessel summary.

The ICA/CCA ratio is able to be configured for either systole or diastole.

The vertebral vessel also has systole and diastole selections. In the summary page, there is a box to select flow reversal for vertebral flows. The choices are Ante (Antegrade), Retr (Retrograde), and Abs (Absent).

To select the method:

Move cursor to the box and press **Set**. After the pop-up menu (Blank, Ante, Retr, Abs) is displayed, select from a menu of choices. The selected choice is displayed in the column.

The box is independent of Left and Right.

### Renal Artery Study

For renal arteries, you can calculate RENAL/AORTIC ratio (RAR) based on peak systolic velocities.

You can combine the two renal summary pages, and have a heading to separate the different measurements (main renal, intra renal). You can scroll between the measurements. The most commonly used, the main renal artery, is the default.

### Lower Extremity Artery Study

For the lower extremity artery, you need an intra vessel ratio (assessing pre vs. stenotic velocities). You can specify which (ratio is stenotic/pre).

The intra-vessel ratio needs to be available for all vascular measurements. This appears on the worksheet only if used.

### Recording Worksheet

The worksheet can be saved as you would any ultrasound image. Once it is displayed on the screen, it can be recorded on the DVR, printed on the B/W printer, stored on media with the Image Archive option, or placed on regular paper with a line printer.

### Print All Pages

When there are multiple pages, a "Print All Pages" button is displayed on the Touch Panel Default is ON. If Print All Pages is set to ON, press the Print button; then all pages are stored/printed, depending on the how the print button is configured.

# Anatomical Survey

## Overview

The Anatomical Survey page provides a checklist that indicates which anatomy was imaged and its appearance.



Figure 7-28. OB Anatomical Survey



Figure 7-29. Abdominal Anatomical Survey



Figure 7-30. GYN Anatomical Survey

## Editing

1. To activate the Anatomical Survey, select **Anatomy** on the Worksheet Touch Panel.
2. Fill the required field.

Table 7-7: Abdomen Anatomical Survey

Field	Description
ANATOMY	Enter the following information for each part of the anatomy imaged: 1. Imaged?: Check the box that you did image this part of the anatomy. 2. Appearance: If you checked the Imaged? box, indicate whether the appearance was normal or abnormal.
	You can add additional anatomy to this worksheet. Up to 9 additional items can be added.  Move the Trackball to the blank field.  Enter the anatomy name.
COMMENTS	Free text

Table 7-8: OB Anatomical Survey

Field	Description
Fetus Pos	Indicate the fetal position within the uterus.
PLAC	Identify the location of the placenta.
ANATOMY	Enter the following information for each part of the anatomy imaged: 1. Imaged? : Check the box that you did image this part of the anatomy. 2. Appearance : If you checked the Imaged? box, indicate whether the appearance was normal or abnormal.
	You can add additional anatomy to this worksheet. Up to 9 additional items can be added.  Move the Trackball to the blank field.  Enter the anatomy name.
BIOPHYSICAL	The score is _ of 10 possible total points, depending upon the number of parameters entered. Enter the following information to assess the fetus's biophysical well-being.
Movement	Type 0, 1 or 2
Tone	Type 0, 1 or 2
Breathing	Type 0, 1 or 2
Fluid	Type 0, 1 or 2



Table 7-8: OB Anatomical Survey (Continued)

Field	Description
Reactive NST (Reactive non-stress test)	Type 0, 1 or 2
COMMENTS	Free text

Table 7-9: GYN Anatomical Survey

Field	Description
ANATOMY	<p>Enter the following information for each part of the anatomy imaged:</p> <ol style="list-style-type: none"> <li>1. Imaged?: Check the box that you did image this part of the anatomy.</li> <li>2. Appearance: If you checked the Imaged? box, indicate whether the appearance was normal or abnormal.</li> </ol> <p>You can add additional anatomy to this worksheet. Up to 9 additional items can be added.</p> <p>Move the Trackball to the blank field.</p> <p>Enter the anatomy name.</p>
COMMENTS	Free text

3. Select **Exit** to return to the Scan screen.

Select **Worksheet** to return to the Worksheet.

**NOTE:** *The patient specific contents input on the Anatomical Survey page are returned to the factory default settings after starting a new patient.*

# Measurement and Calculation Setup

Measurements and studies are organized for typical work flows. If you want, you can change this set up. You can specify which studies are in each exam category, and which measurements and calculations are in each study. You can change the measurements that are available on the Touch Panel. The LOGIQ Totus allows you to quickly and easily set up your system so that you can work most efficiently.

This section describes how to:

- Change a study to include different measurements
- Add a new study or measurement
- Remove a study from an exam category
- Change measurement parameters
- Create a measurement formula to correctly handle unit conversions
- Edit user-defined calculations
- Define application-specific measurement parameters
- Specify the default manual calc measurements for a selected study or folder

## Starting Study and Measurement Setup

You can make changes to studies and measurements in the Measurement & Analysis screen. To open the screen:

1. On the Touch Panel, select **Utility**.
2. On the Touch Panel, select **Measure**.
3. The system displays the Measurement & Analysis screen on the monitor display.



Figure 7-31. Measurement & Analysis screen

- **Selection menu:** select exam category, study, or measurement folder/measurement.
- **Measurement menu:** add and delete studies (folders) and measurements; select mode.
- **Folder or measurement:** define studies and measurements. This section changes between Folder and Measurement, depending on what you select in the Selection menu.

### Select the exam category

To select the exam category you want to work with:

1. Move the cursor to the exam category at the top of the Selection menu.
2. Press **Set**.  
The system displays a list of exam categories.
3. Move the cursor to the desired exam category.
4. Press **Set**.

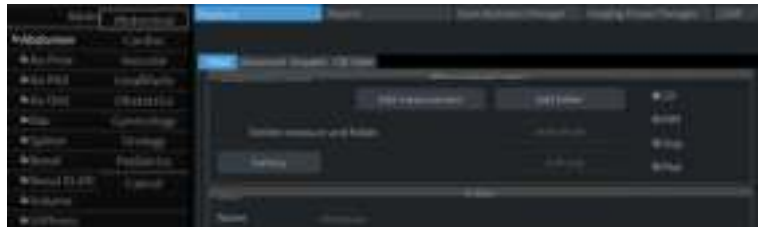

Figure 7-32. Select the exam category

## Select the study

1. Move the cursor to the current study in the Selection menu.

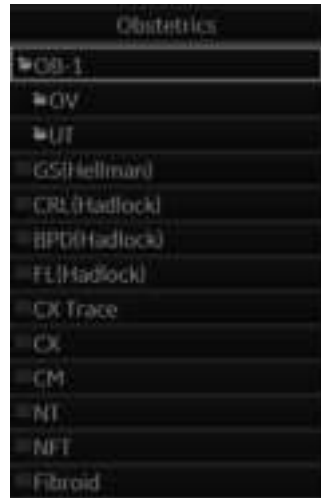

Figure 7-33. Select the study

2. Press **Set**. All study displays.



Figure 7-34. Select the study

3. Move the cursor to the desired study you want to open.
4. Press **Set**.

### Select a measurement folder or a measurement

1. Move the cursor to the desired measurement folder or the desired measurement in the Selection menu.
2. Press **Set**.
  - If you select a measurement folder, the Folder section displays information about the selected folder.



Figure 7-35. Folder - example

- If you select a measurement, the Measurement section displays information about the selected measurement.

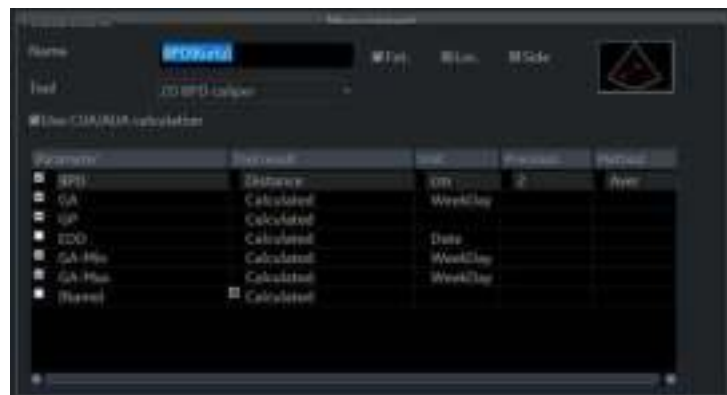

Figure 7-36. Measurement - example

## Select the measurement mode

In the Measurement menu, select the measurement mode which you work with.

- 2D (B-Mode)
- MM (M-Mode)
- Dop (Doppler Mode)
- Plot (Plot Mode—The measurement on the plot graph of the TIC/QAnalysis)



Figure 7-37. Measurement menu

## Display/hide a folder or a measurement in the Touch Panel

The Folder section of the Measurement & Analysis screen has two lists of folders and measurements. This is where you specify which items go in a study or folder.

- **Available folders and measurements.** The list contains all possible folders and measurements for the selected study or folder.
- **Measure & Study.** The list defines where the folder or measurement is located on the Touch Panel.

To display an item in the Touch Panel:

1. In the Measure & Study list, move the **Trackball** to highlight which folder you want to put the item in, and press **Set**.
2. Move the **Trackball** to highlight an item in the Available folders and measurements list, and press **Set**. The selected item is assigned to the Touch Panel.

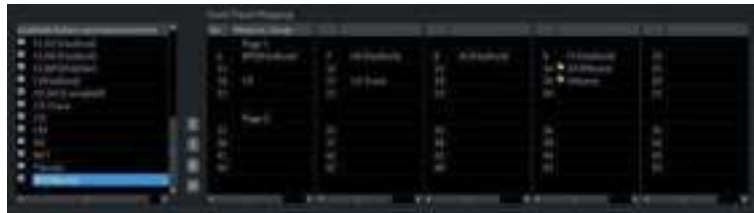

Figure 7-38. Select the position and an item



Figure 7-39. Measure & Study list: New item added

The selected item is now displayed in the Touch Panel and the Summary Window.



## Touch Panel positions

Each Touch Panel has 25 positions, five across and five down. The items in the first row across are numbered 1–5, in the second row 6-10, and so on. Positions 1-5 are system programmed and cannot be edited.



Figure 7-40. Measure & Study display with Touch Panel positions, Page 1

### Touch Panel positions (continued)

Page 2 of the Touch Panel has 25 positions, five across and five down. The items in the first row across are numbered 26-30, in the second row 31-35, and so on. Positions 26-30 are system programmed and cannot be edited.



Figure 7-41. Measure & Study display with Touch Panel positions, Page 2

## Move, Remove or Hide Touch Panel Items



Figure 7-42. Move (1), Remove (2) and Hide (3) Icons

### Move Touch Panel Items

To move items on the Touch Panel, change the item position in the Measure & Study list.

1. Highlight an item in the Measure & Study list.
2. Move the cursor to the Up or Down Arrow Icon and press **Set** (see **1** in Figure 7-42 on page 7-83).

The item is displayed at the selected position on the Touch Panel.

### Remove Touch Panel Items

To remove items from the Touch Panel, remove the item from the Measure & Study list.

1. Move the **Trackball** to highlight the item in the Measure & Study list and press **Set**.
2. Select the Trash Icon to the right of the list (see **2** in Figure 7-42 on page 7-83).

The system removes the item from the Measure & Study list and from the Touch Panel. The item is still listed in the Available folders and measurements list.

### Hide Touch Panel Items

Modifiers for Stenosis, as well as Prox, Mid, Distal and Origin location identifiers, can be hidden on the Touch Panel using the Hide command in the Measure & Study list.

1. Move the **Trackball** to highlight the item in the Measure & Study list and press **Set**.
2. Select the Hide Icon to the right of the list (see **3** in Figure 7-42 on page 7-83).

The system hides the modifier from the Measure & Study list and from the Touch Panel. Once a modifier is hidden, another measurement can be assigned to the Touch Panel location.

To reestablish the hidden modifier, highlight the hidden modifier in the Measure & Study list, press **Set** and select the Hide Icon.

*NOTE: If a modifier is hidden in either 2D or Doppler mode, it will be hidden in both modes.*

## Setting up an automatic measurement flow

In some cases, related measurements are put in a measurement folder. This allows you to logically organize measurements. It also allows you to specify that the system automatically start each measurement in a folder, one after the other. This is the automatic sequence feature. To use this feature:

1. In the Selection menu, select the folder that contains the measurements you want.
2. In the Folder section, select Auto sequence.



Figure 7-43. Measurement & Analysis screen: Auto sequence

### Change the tool used to make a measurement

You can make changes to some of the measurements. For example, Head Circumference can be measured with an ellipse, a trace, or two distances. You can select the measurement tool you want to use.

1. Select the measurement you want to change in Selection menu.
2. In the Measurement section, select the desired tool from the Tool list.

**NOTE:** *If the Tool field is gray, it cannot be changed.*

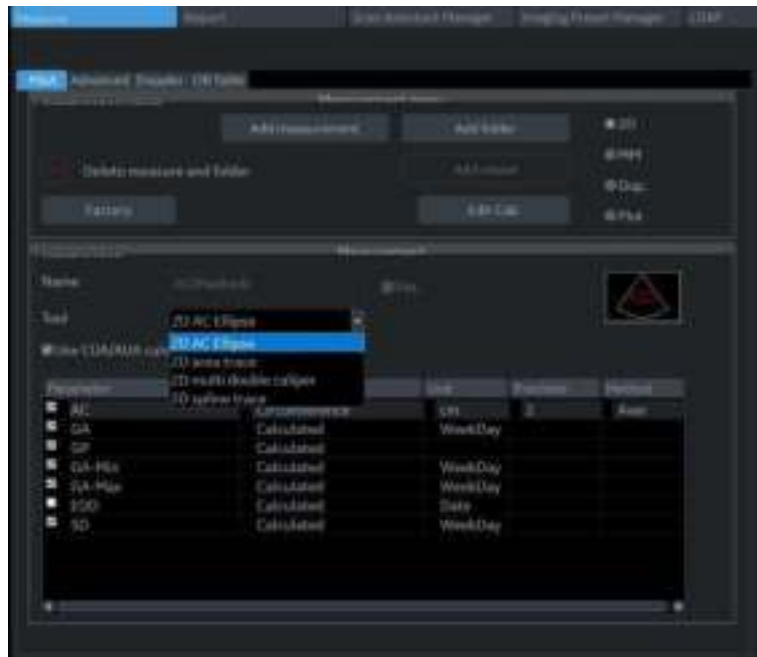

Figure 7-44. Change the tool

**NOTE:** *The diagram to the right of the Tool list shows the measurement type. In the following example, ellipse is selected and the diagram shows an ellipse.*

## Adding Folders and Measurements

### Adding a folder

When you add a folder, it can be a study, or a measurement folder that includes related measurements.



Figure 7-45. Measurement & Analysis: Add folder

1. In the Selection menu, select the study or folder where you want to add the folder.
2. Select the mode in the Measurement menu.

### Adding a folder (continued)

3. In the Measurement menu section, select Add folder.
  - If you select Blank, the system adds a folder with a name such as USERDEFS1. It is listed in the Selection menu.

**NOTE:** *For Generic study, you can only use Blank.*

- If you want to use an existing folder, select Insert, and then select a folder from the list.



Figure 7-46. Add folder Window

4. Select the user-defined folder in the Selection menu.
5. Move the **Trackball** to the Name field and press **Set** twice.  
Type the name.

**NOTE:** *DO NOT use "single quotes" for a parameter name, a measurement name, a folder name or an author name.*

6. Add a measurement to the folder.



## Adding a Measurement



### DANGER

Please remember that you are responsible for confirming the correctness and accuracy of the user input formula that you enter or is entered into the system on your behalf. Failure to confirm the correctness and accuracy of user defined calculations could lead to patient injury.

You can add a measurement to the folder.

**NOTE:** *DO NOT use “single quotes” for a parameter name, a measurement name, a folder name or an author name.*

1. In the Selection menu, select the study or folder where you want to add the measurement.
2. In the Measurement menu section, select Add measurement.

The system displays the Add Measurement window.



Figure 7-47. Add Measurement window

3. Do one of the following:
  - If you want to create this measurement from a copy of an existing measurement, select Use copy of, and then select a measurement from the list. The list includes all measurements defined for the current exam category and selected mode.

**NOTE:** *This only applies to OB and Cardiac.*

- If you want to use an existing formula, select Insert, and then select a measurement from the list. The list includes all measurements defined for the current exam category and selected mode. You cannot edit this formula.
- If you want to create a blank new measurement, select Blank.

### Adding a Measurement (continued)

4. Select OK.
  - If you created a blank measurement, the system adds a measurement with a name such as USERDEFM3.
  - If you created a measurement from a copy of an existing measurement, the system lists the measurement and its parameters in the Measurement section.
5. When you create a new measurement, the measurement name is automatically highlighted. Type a name for the new measurement. You can change the name of a measurement you created from a copy.

**NOTE:** *2D Dual Caliper, 2D Dual Area, 2D Dual Ellipse, and 2D Dual Spline Trace are not available through the factory default. To enable these measurements, add a new measurement using “2D Dual Caliper”, “2D Dual Area”, “2D Dual Ellipse”, or “2D Dual Spline Trace” tool.*

### Changing measurement parameters



#### DANGER

Please remember that you are responsible for confirming the correctness and accuracy of the user input formula that you enter or is entered into the system on your behalf. Failure to confirm the correctness and accuracy of user defined calculations could lead to patient injury.

To change a measurement parameter:

1. In the Selection menu, select the measurement.
2. To change the name of the Parameter, move the **Trackball** to the parameter name and press **Set** twice. Type a name for the parameter.

## Adding measurement parameters

To add a measurement parameter:

1. In the Selection menu, select the measurement.
2. To change the tool used to make a measurement:  
In the Measurement section of the Measurement & Analysis screen, select the desired tool from the Tool list. Select the arrow to display the drop-down list.

*NOTE: If the Tool field is gray, it cannot be changed.*

3. If necessary, check Fetus (OB only), Location (Loc), or Side:
  - Fetus: If this is an OB measurement, check this box. (Default ON).
  - Location: If this measurement includes a Prox, Mid, or Dist location, check this box.
  - Side: If this measurement includes a Left or Right side, check this box.
4. In the Measurement section, move the **Trackball** to an empty line at the bottom of the Parameter list. Press **Set**.  
The system adds a parameter with a name of (Name).

### Adding measurement parameters (continued)

5. To change the name of the Parameter, move the Trackball to the (Name) and press **Set** twice. Type a name for the parameter.
6. Move the **Trackball** to the Tool result field, and double click the **Set** key.  
The Edit Formula window is displayed.



Figure 7-48. Edit Formula

7. To create a formula:
  - a. In the Value Type field, select a value.
  - b. Do one of the following:
    - Type a formula in the Formula field.
    - Select formula components from the Operators, Parameters, and Functions drop-down lists. When you select a component, the system displays it in the Formula field.
8. To test the formula, select Check.  
If there are no problems, the system displays "Syntax OK!".  
If there are any problems with the formula, the system displays an Error message in place of the Formula field label.
9. When the formula is correct, select OK to save it.  
The Edit Formula window closes. The formula is displayed in the Tool result field.

## Formula Unit Conversion

When you create a formula, the system changes the calculation result into an output unit as defined in the following table.

Table 7-10: Formula Unit Conversion

Unit		Conversion (coefficient value)
Time		
	s	x1
	ms	x1,000
	min	x0.0167
	h	x0.00027778
Ratio		
	%	x100
Frequency		
	bpm or BPM	x1.0
Angle		
	rad	x1.0
	deg	x57.2958
	grad	x63.6620
Distance		
	cm	x100
	m	x1
	dm	x10
	mm	x1,000
	inch	x39.37
	feet	x3.281
	pixels	x1
Velocity		

## General Measurements and Calculations

Table 7-10: Formula Unit Conversion (Continued)

Unit		Conversion (coefficient value)
	m/s	x1
	dm/s	x10
	cm/s	x100
	mm/s	x1,000
	inch/s	x39.37
Acceleration		
	m/s <sup>2</sup>	x1
	dm/s <sup>2</sup>	x10
	cm/s <sup>2</sup>	x100
	mm/s <sup>2</sup>	x1,000
	inch/s <sup>2</sup>	x39.37
Area		
	m <sup>2</sup> or m <sup>2</sup>	x1
	dm <sup>2</sup>	x100
	cm <sup>2</sup> or cm <sup>2</sup>	x10,000
	mm <sup>2</sup> or mm <sup>2</sup>	x1,000,000
	inch <sup>2</sup>	x1550
Volume		
	m <sup>3</sup>	x1
	dm <sup>3</sup>	x1,000
	cm <sup>3</sup>	x1,000,000
	l	x1,000
	dl	x10,000
	cl	x100,000
	ml	x1,000,000
	gallon	x264,178
	quart	x1056.71
Volume Flow		

Table 7-10: Formula Unit Conversion (Continued)

Unit		Conversion (coefficient value)
	m <sup>3</sup> /s	x1
	dm <sup>3</sup> /s	x1,000
	cm <sup>3</sup> /s	x1,000,000
	mm <sup>3</sup> /s	x1,000,000,000
	l/s	x1,000
	dl/s	x10,000
	cl/s	x100,000
	ml/s	x1,000,000
	m <sup>3</sup> /min	x60
	dm <sup>3</sup> /min	x60,000
	cm <sup>3</sup> /min	x60,000,000
	mm <sup>3</sup> /min	x60,000,000,000
	l/min or L/min	x60,000
	dl/min	x600,000
	cl/min	x6,000,000
	ml/min	x60,000,000
	ml/m <sup>2</sup>	x1,000,000
Pressure		
	mmHg	x1
	Pa	x133.322
	kPa	x0.133322
	bar	x0.00133322
Pressure/Time		
	mmHg/s	x1
Mass		
	kg	x1
	g	x1,000
	ounce	x35.273962
	pound	x2.2046226

Table 7-10: Formula Unit Conversion (Continued)

Unit		Conversion (coefficient value)
Others		
	l/minm <sup>2</sup>	x60000.0
	g/m <sup>2</sup>	x1000.0
	cm/m <sup>2</sup>	x100.0
	cm <sup>2</sup> /m <sup>2</sup>	x10000.0
	ml/kg/min	x60000000.0

For example, when a Volume formula is created:

$$\text{Vol [ml or cm}^3\text{]} = 0.523598 \cdot \{D1\} \cdot \{D2\} \cdot \{D3\}$$

(D1, D2, and D3 indicate a measurement result.)

In this case, the measurement (D1, D2, and D3) is a distance measurement, so the measured data is a meter [m] unit according to the above table.

To change into a milliliter, the system multiplies each measurement value by 100. As a result, it multiplies a formula by 1,000,000.

The standard unit of volume is a cube meter, so the system multiplies the result by 1,000,000.

The system multiplies the calculation result by the coefficient and converts it. To get a correct result, when you define the formula, you must convert the coefficient itself, such as the coefficient of 10<sup>^</sup>.



## Formula Unit Conversion (continued)

For example, if you want to define the following formula:

$$\text{efg[g]} = 10^{(1.5662-0.0108*\{P1\}+0.0468*\{P2\}+0.171*\{D1\}+0.00034*\{P1\}*\{P1\}-0.003685*\{P2\}*\{D1\})}$$

D1[cm]: Distance

P1[cm]: Perimeter

P2[cm]: Perimeter

The system defines the standard value of each measurement as a meter [m]. If the unit of each measurement value of this formula is defined as centimeter [cm], you must define the formula as follows:

$$\text{efw[g]} = 10^{(1.5662-0.0108*\{P1\}*100 + 0.0468*\{P2\}*100 + 0.171*\{D1\}*100 + 0.00034*\{P1\}*\{P1\}*100*100 - 0.003685*\{P2\}*\{D1\}*100*100)}$$

(This converts each measurement value to a centimeter [cm], since the system standard unit is a meter [m].)

The output unit of this formula is a gram. Since the standard unit of the system is defined as a kilogram [kg], the system multiplies the output by 1,000.

Because the output of this formula is defined as a gram, it is necessary to define the formula as follows.

$$\text{efw[g]} = 10^{(1.5662-0.0108*\{P1\}*100 + 0.0468*\{P2\}*100 + 0.171*\{D1\}*100 + 0.00034*\{P1\}*\{P1\}*100*100 - 0.003685*\{P2\}*\{D1\}*100*100)/1,000}$$

As shown, you can obtain an exact calculation result.

### Editing Calculations

To modify user-defined calculations:

1. Select Add Measurement from the Measurement menu. The system displays the Add Measurement window.
2. Select Blank and OK.
3. Type the appropriate name and select “Calculation” from the Tool pull-down menu.

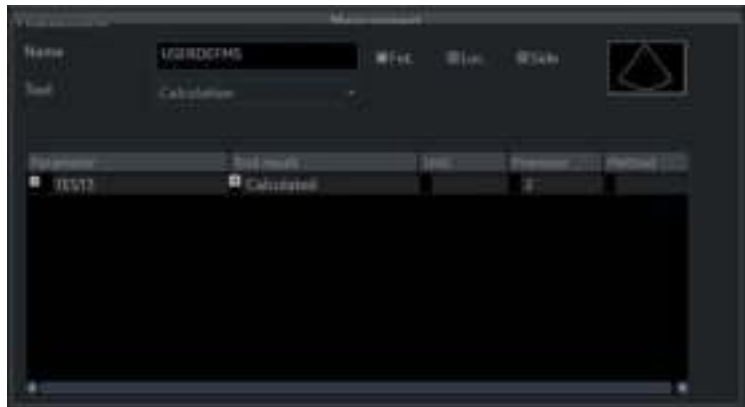

Figure 7-49. Measurement window

4. Type the parameter name.
5. Double click on the = Calculated symbol under Tool Result. The Edit Formula window displays.
6. Select OK.
7. In the Measurement menu section, select *Edit Calc*.



Figure 7-50. Edit Calc

The Modify User CALC window displays.

## Editing Calculations (continued)

8. In the User Defined list, select the calculation that you want modified, then select OK.



Figure 7-51. Modify User CALC window

9. The Measure tab for user-defined calculations displays. Double click on the equals sign symbol under Tool Result for the desired parameter.
10. Edit the formula as needed and select OK.

## Deleting a Folder or Measurement

**NOTE:** *You can only delete user-defined folders or measurements. You cannot delete default system folders or measurements.*

1. Select the folder or measurement in the Selection menu.
2. In the Measurement menu section, select the Trash icon next to Delete measure and study.

### M & A Advanced Preset

The Advanced tab allows you to specify application-specific values for certain parameters.

1. On the monitor display, select the Advanced tab.

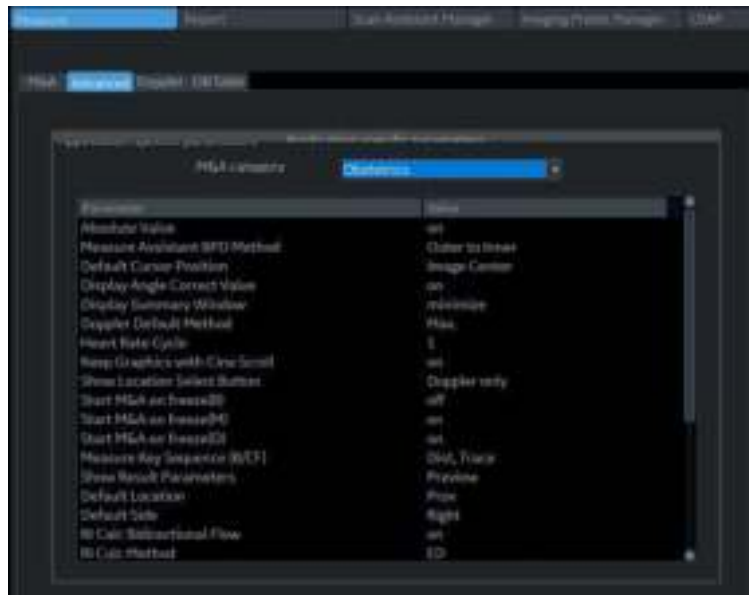

Figure 7-52. M&A Advanced Preset Menu

**M&A Category:** Display and select current exam category.

**Parameter:** Lists application specific parameters.

**Value:** Select the value for a parameter.

2. Select an exam category.  
The Parameters list displays parameters for the selected category.
3. Select a value for a parameter.

**NOTE:** *The parameters that appear are category dependent.*

**M & A Advanced Preset (continued)**

Table 7-11: M&A Advanced

Preset Parameter	Description
Absolute Value	Displays the absolute value of the Doppler Velocity measurement (On or Off)
Default Cursor Position	Image Center/Summary Window Select the display position of the cursor when the measurement key is pressed.
Display Angle Correct Value	On or Off
Display Sample Volume Depth (TCD)	On or Off
Display Summary Window	On or Off
Doppler Default Method	Avg, Max, Min or Last
Heart Rate Cycle	1, 2, 3, 4, 5, 6, 7, 8, 9, or 10 <i>NOTE: For Cardiac, you can select only "1".</i>
Keep Graphics with Cine Scroll	If you select "On", the measurement graphics remain while in CINE scroll. The measurement graphic redisplay on the frame where the measurement was taken in B-Mode.
Start M&A on a Freeze (B)	Off: Select measurement manually on Freeze
Start M&A on a Freeze (M)	On: Measurement menu appears automatically on Freeze.
Start M&A on a Freeze (D)	Caliper: Measurement menu and caliper appear automatically on Freeze.
Measure Key Sequence (B/CF)	2 Sequences: Dist, Trace; Dist, Spline 2 Sequences: Dist, Open Trace; Dist, Open Spline 3 Sequences: Dist, Trace, Spline; Dist, Spline, Trace; Dist, Spline, Intensity; Dist, Trace, Intensity; Dist, Trace, Open Trace; Dist, Spline, Open Trace 4 Sequences: Dist, Trace, Spline, Intensity; Dist, Spline, Trace, Intensity; Dist, Spline, Trace, Open Trace; Dist, Trace, Open Trace, Spline
Show Result Parameters	Preview or After Set cursor: Preview: Displays while taking the measurement. After Set Cursor: Displays after completing the measurement.
Default Location	Off, Prox, Mid or Dist
Default Side	Left, Right or Off
PI Calc Method	MD or ED
RI Calc Bidirectional Flow	On or Off
RI Calc Method	MD or ED
Shear Measure Size	Sets the Default Diameter size of the shear wave measurement circle.

## General Measurements and Calculations

Table 7-11: M&A Advanced (Continued)

Preset Parameter	Description
Shear Measure Fixed Size	On or Off
Shear Calculation Method	Specify Mean or Median <ul style="list-style-type: none"> <li>• Mean averages all of the shear wave points within the measurement circle.</li> <li>• Median sorts, then selects the middle point of all points within the measurement circle.</li> </ul>
Shear Units Determine Folder	If you have preset shear wave units via the Display Units on the Utility -> System -> System Imaging page, then when you specify On, the unit specified pre-selects the measurement folder. If m/s is specified as the unit, then the Velocity folder is used; if kPa is specified as the unit, then the Stiffness folder is used.
Show Location Select Button	Both on B and Doppler, Doppler only or No Display NOTE1: Only Abdominal, Vascular, Obstetrics and Gynecology have this preset. NOTE2: For Obstetrics and Gynecology, you can select only Doppler only or No Display.
Show BM Folder Name on Worksheet	On or Off
Show Measure Name on Worksheet	On or Off
Show Point Velocity	On or Off
Show Tissue Depth	On or Off
Keep Result Window	Auto, On or Off
Trace	Auto or manual
Length Unit	mm, cm, Default
Velocity Unit	mm/s, cm/s, m/s, Default
Acceleration Unit	mm/s <sup>2</sup> , cm/s <sup>2</sup> , m/s <sup>2</sup> , Default
Area Unit	mm <sup>2</sup> , cm <sup>2</sup> , Default
Volume Unit	cm <sup>3</sup> , ml, l, Default
Volume Flow Unit	cm <sup>3</sup> , ml, l, Default
Time Unit	ms, s, Default
Show Area Value While Tracing	On or Off
Vol Flow Method	TAMEAN or TAMAX
Vol Flow Compensation with TAMAX	If you select TAMAX as the volume flow method, then you MUST specify the coefficient to use. Select from 0.5 to 1.0.
Worksheet Default Display	Mode/Expand (Abdominal, Small Parts, Obstetrics, Gynecology, Urology and Pediatrics) or Worksheet Summary (Vascular)

Table 7-11: M&A Advanced (Continued)

Preset Parameter	Description
Primary Worksheet	For Abdominal and Small parts. Abdominal: Worksheet or Summary, Small parts: Worksheet or SWE summary
Doppler AutoCalc Velocity Unit	Velocity, Hz, Both or Auto
Default CCA location for ICA/CCA ratio	Prox/Mid/Dist/Off Select the default location of CCA which is used for the ICA/CCA ratio.
MCA/ICA Ratio	TAMAX or PS
Default ICA location for MCA/ICA ratio	Prox/Mid/Dist/Off Select the default location of CCA which is used for the MCA/ICA ratio.
WMS Freeze Loop at ES	On or Off
WMS Segment Model	16 segments or 18 segments
WMS Initial Scoring	Undefined or Normal
WMS Scoring Legend	ASE, European or Asian
Hip Orientation	Cranial-left or Caudal-left
Show area value while tracing	On or Off
Measure Assistant BPD Method	Outer to Inner, Outer to Outer
Restrict Breast Contour Caliper Edit	On or Off
AFI/AutoEF autoprocessing	Off, delay 1s, delay 2s, delay 3s or delay 4s
AFI/AutoEF ROI method	Auto ROI or 3 Points
AFI/AutoEF YOYO	Play or Stop
AFI Default Color Palette	Red-Blue, Green-Yellow-Red
AFI segment model	17 segments, 18 segments
AFI PSS/PSI Mode	PSS only, PSS&PSI
Auto sequence - Trigger for next measurement	Measure or Freeze
Link contents	Select to link parameters by cardiac cycle.
Default value for RAP	Blank, 3, 5, 7, 8, 10,15 (system default is 3)
UGAP Print and Unfreeze	On or Off
Length unit	Default, mm or cm
Velocity unit	Default, mm/s cm/s, or m/s
Acceleration unit	Default, mm/s <sup>2</sup> , cm/s <sup>2</sup> , or m/s <sup>2</sup>

Table 7-11: M&A Advanced (Continued)

<b>Preset Parameter</b>	<b>Description</b>
Area unit	Default, mm <sup>2</sup> , or cm <sup>2</sup>
Volume unit	Default, cm <sup>3</sup> /s, ml/s, l/s, cm <sup>3</sup> /min, ml/min, or l/min
Volume Flow unit	Default, cm <sup>3</sup> /s, ml/s, l/s, cm <sup>3</sup> /min, ml/min, or l/min
Time unit	Default, ms, or s
Primary Worksheet	Worksheet or Summary



## Doppler tab - Modify Calculation

The Doppler tab allows you to preset the parameters for manual calculations.

1. On the monitor display, select the Doppler tab.
2. The following example describes how to configure the Carotid Doppler calculations.

Select Vascular next to M&A Categories. The Vascular measurement category is displayed.

3. Select Carotid. The available calculations are displayed in Modify Calcs.



Figure 7-53. M&A Doppler Preset Menu

4. Check the desired calculations to be performed.

### Application Measurement Preset

The Application Measurement presets allow different calculation packages to be available under different application presets.

The presets allow you to configure the Measurement Categories and Measurement Exam Calcs. These presets are found on the Utility -> Application -> Measurements screen.

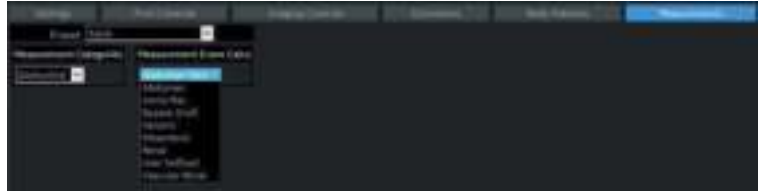

Figure 7-54. Application Measurements Menu

---

# Chapter 8

## Application M&A

*Describes how to perform application specific measurements and calculations.*

# General Information

## Overview

Measurements and calculations derived from ultrasound images are intended to supplement other clinical procedures available to the attending physician. The accuracy of measurements is not only determined by the system accuracy, but also by use of proper medical protocols by the user. When appropriate, be sure to note any protocols associated with a particular measurement or calculation. Formulas and databases used within the system software that are associated with specific investigators are so noted. Be sure to refer to the original article describing the investigator's recommended clinical procedures.

## General Guidelines

New Patient information must be entered before beginning an exam. See 'Beginning an Exam' on *page 4-2 for more information*.

Any measurement can be repeated by selecting that measurement again from the Touch Panel.

The system retains all measurements, but the worksheet retains only the last six measurements of each type.

# Abdomen

## Overview

Abdominal measurements offer a few different types of measurement studies. Select the desired study.

- Generic—Common to all applications. See ‘Generic Measurements’ on *page 7-18 for more information.*
- Abdomen
- Renal
- Bypass Graft
- Aorta Iliac
- Vascular Renal
- Mesenteric
- Abdomen Vein

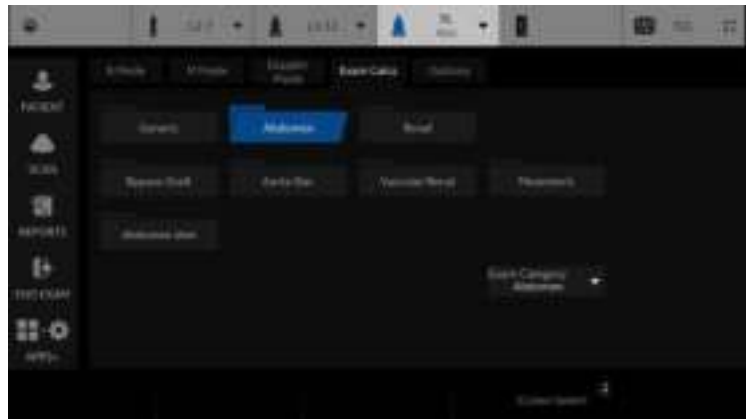

Figure 8-1. Abdomen Exam Category Touch Panel

# Small Parts

## B-Mode Measurements

The Small Parts exam category includes the following two folders:

- Generic—Common to all applications. See ‘Generic Measurements’ on *page 7-18 for more information.*
- Small Parts, which includes the breast, thyroid and scrotal measurement packages.

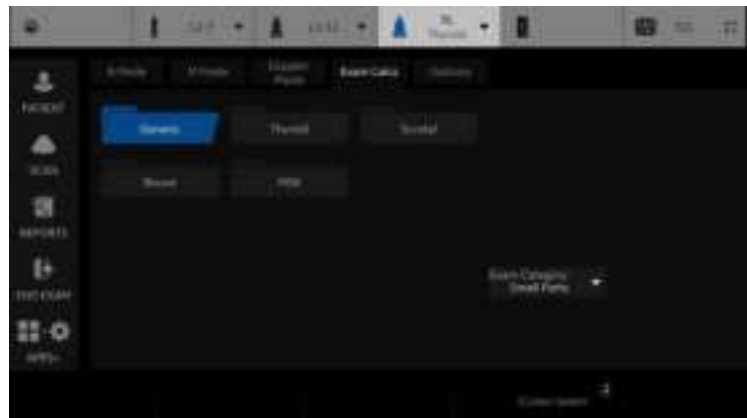

Figure 8-2. Small Parts Exam Category Touch Panel

## Thyroid

### Thyroid Left/Right

Each of these is a standard distance measurement. Length and height are typically measured in the sagittal plane. Width is measured in the transverse/axial plane.

To measure thyroid length, width, or height:

1. On the **Exam Calcs**, select **Small Parts**.
2. Select **Thyroid**.
3. Select **Lt or Rt Thyroid**. Change the orientation (side), if necessary.
4. Select **Thyroid L**, **Thyroid W**, or **Thyroid H**.  
An active caliper displays.
5. Perform a standard distance measurement.

### Isthmus AP

To measure the anterior/posterior isthmus tissue, perform a distance measurement.

## Scrotal

### Scrotal Left/Right

Each of these is a standard distance measurement. Length and height are typically measured in the sagittal plane. Width is measured in the transverse/axial plane.

To measure scrotal length, width, or height:

1. On the **Exam Calcs**, select **Small Parts**.
2. Select **Scrotal**.
3. Select **Lt or Rt Testicle**. Change the orientation (side), if necessary.
4. Select **Testicle L**, **Testicle W**, or **Testicle H**.  
An active caliper displays.
5. Perform a standard distance measurement.

## Epididymis

To measure the epididymis structure, perform a distance measurement.

## Introduction

Out of Range – If the system indicates that a measurement is out of range (OOR), it means one of the following:

- The measurement is out of the normal range based on the gestational age that is calculated from the LMP. The system determines OOR from the ultrasound age compared to the gestational age. The gestational age is calculated from the last menstrual period or the estimated delivery date.
- The measurement is outside of the range for the data used in the calculation. That means that the measurement is either less than or more than the range of measurements used to determine fetal age based on the measurement.

*NOTE: Calculation formulas are listed in the Advanced Reference Manual.*

*NOTE: Nuchal Translucency is not available through the factory default. To enable Nuchal Translucency, add NT to the measurement folder in Utility -> Measure -> M&A -> Add measurement (Insert).*



## OB Type change

The LOGIQ Totus system includes measurements for the following studies: USA, Europe, Tokyo, Osaka and ASUM.

Select OB Type in Utility -> System -> System Measure.



Figure 8-3. OB Type selection



Figure 8-4. OB Type: Tokyo - example

**NOTE:** ASUM studies include the following measurements:

- ASUM: AC, BPD, and CRL
- ASUM 2001: AC, BPD, CRL, FL, HC, HL, and OFD

## To Start an Obstetrics Exam

**NOTE:** *Calculation formulas are listed in the Advanced Reference Manual.*

To begin an Obstetrics exam, you enter patient data or, if the patient data from a previous exam is saved in the system, find the patient information.

1. On the control panel, press **Patient**.  
The Patient Data Entry screen is displayed.
2. On the Patient Data Entry screen, select New Patient.
3. To choose an Obstetrics exam, move the **Trackball** to highlight Obstetrics, then press **Set**.  
The obstetric fields are listed in the Exam Information section of the Patient Data Entry screen.
4. Do one of the following:
  - If the patient data is already stored in the system, search for the data. Use the search fields in the bottom section of the Patient Data Entry screen. For information about how to search for patient data, see 'Changing Patient Information or an Exam' on *page 4-24* for more information.

When the correct patient data is listed in the search list, move the **Trackball** to highlight the patient name and press **Set**. The system displays the patient data.

**NOTE:** *To change patient data, use the **Trackball** to move the cursor to the field and press **Set**. Press **Backspace** to delete the data, and then type the correct data.*

- If the patient data is not stored in the system, enter the data. To enter data in a field, move the **Trackball** to highlight the field and then press **Set**. Use the **Tab** key to move between fields. Obstetric patient fields are listed in the following table.

**NOTE:** *For information about entering general patient data such as Patient ID and name, see 'Beginning an Exam' on *page 4-2* for more information.*

## To Start an Obstetrics Exam (continued)

Table 8-1: Obstetric fields

Field	Description
LMP	Last Menstrual Period; enter the date that the patient started her last menstrual period. You must enter 4 digits for the year. When you type the month and day, the system fills in the /. The Date Format preset chosen in Utility -> System -> General determines the required format.
BBT	Basal Body Temperature.
EDD by LMP	Estimated Delivery Date by LMP; the system fills in the date after you enter the LMP.
GA by LMP	Gestational Age by LMP; the system fills in the age after you enter the LMP.
Gravida	Number of pregnancies.
Para	Number of births.
AB	Number of abortions.
Ectopic	Number of ectopic pregnancies.
Fetus #	Number of fetuses; default is 1. Can be 1-4.
Accession #	Exam number used with hospital information system (DICOM). This is a tracking number from the worklist.
Exam Description	Describe the type of exam.
Perf Physician	The physician who performs the exam. Choose from the list or type the name.
Ref. Physician	The physician who requested the exam. Choose from the list or type the name.
Operator	The person (not a physician) who performs the scan. Choose from the list.

**NOTE:** To fill in the following information, move the **Trackball** to highlight the **Detail** button and press **Set**.

## To Start an Obstetrics Exam (continued)

Table 8-2: Obstetric fields: Detail

Field	Description
Indications	Why the patient needs the ultrasound exam.
Comments	Comments about the exam.

After you complete the patient information, you can begin the scan.

- To change from the Patient Data Entry screen to the Scan screen, do one of the following:
  - On the keyboard, press **Esc**.
  - On the Touch Panel, select **Scan**.
  - On the Control Panel, select **Patient** or **Freeze**.
  - On the Control Panel, press the **B-Mode** key.

The system displays the Scan screen.

- To choose the appropriate probe, select the probe icon on the Touch Panel.
- On the Control Panel, press **Measure**.

The default Obstetrics study is displayed on the Touch Panel.



Figure 8-5. OB-General Study

## To choose a study

1. To change the study on the exam category, select **Probe**. The Obstetrics exam category allows you to choose from the following studies:
  - Generic
  - OB-1
  - OB-2/3
  - OB-General
  - Fetal Heart
  - OB/GYN Vessel
2. To select a study, select the appropriate study on the Touch Panel.



Figure 8-6. OB Study Touch Panel

**NOTE:** *The folders you see on the Touch Panel may be different if your system has been customized.*

## OB Measurements Performed Over Multiple Planes

### Gestational Sac

To calculate the gestational sac, you make three distance measurements in two scan planes. To display two scan planes, press the **L** or **R** key. Get an image in each scan plane and press **Freeze**.

1. Select **GS**; an active caliper displays.
  - a. To position the active caliper at the start point, move the **Trackball**.
  - b. To fix the start point, press **Set**.

The system fixes the first caliper and displays a second active caliper.
  - c. To position the second active caliper at the end point, move the **Trackball**.

A dotted line connects the measurement points.
  - d. To complete the measurement, press **Set**.

The system displays the distance value in the Results Window and displays an active caliper.
2. To make the second and third distance measurement, repeat steps a–d.

After you complete the third distance measurement, the system displays the gestational sac measurement in the Results Window.

To calculate the gestational sac by a one distance measurement:

1. Select **GS**; an active caliper displays.
  - a. To position the active caliper at the start point, move the **Trackball**.
  - b. To fix the start point, press **Set**.

The system fixes the first caliper and displays a second active caliper.
  - c. To position the second active caliper at the end point, move the **Trackball**.

A dotted line connects the measurement points.
  - d. To complete the measurement, press **Set**.

After you complete the measurement, the system displays the gestational sac measurement in the Results Window.

## Amniotic Fluid Index (AFI)

To calculate the amniotic fluid index, you make measurements of the four quadrants of the uterine cavity. The system adds these four measurements together to calculate the Amniotic Fluid Index.

*NOTE: The four quadrants can be measured with distance (caliper) or circumference (circle) measurements. Press the appropriate AFI quadrant Touch Panel key to toggle between caliper and circle.*

1. Select **AFI**.  
The first distance measurement, AFI-Q1, is already selected.
2. Make a standard distance measurement for the first quadrant:
  - a. To position the active caliper at the start point, move the **Trackball**.
  - b. To fix the start point, press **Set**.  
The system fixes the first caliper and displays a second active caliper.
  - c. To position the second active caliper at the end point, move the **Trackball**.  
A dotted line connects the measurement points.
  - d. To complete the measurement, press **Set**.  
The system displays the distance value in the Results Window.
3. When the measurement of the first quadrant is completed, unfreeze and move to the second quadrant.
4. After you obtain the image, press **Freeze** and then **Measure**.  
The system prompts you to continue with the AFI measurements. Make sure that the next quadrant has been selected.

## Amniotic Fluid Index (AFI) (continued)

5. Perform a standard distance measurement for the second, third, and fourth quadrants (see step 2).

When all four quadrants have been measured, the system calculates the AFI total and displays it in the Results Window.



### HINTS

- If you unfreeze the image after doing an AFI measurement, the system does not delete the previous measurements. Unfreeze and change scan planes as necessary.
- To specify that an unassigned distance measurement be used for an AFI measurement:
  - Select **AFI**.
  - Press the top **Trackball** key.
  - Move the **Trackball** to highlight the unassigned distance measurement in the Results Window.
  - Select the AFI measurement on the Touch Panel.
- If the fluid in a pocket is zero, set the second caliper on top of the first one to give it a zero value.
- You can measure an AFI quadrant that is zero (0) by pressing **Set** twice.



## OB Calculation

### SonoNT (Nuchal Translucency)

**NOTE:** *This measurement can be adjusted and customized in the system setup.*

To measure the contour detection of the NT border:

1. Select NT. The measurement cursor appears.
2. Select the fetal position ("Face Up" or "Face Down").
3. Position and fix the first point (P1) of the rectangular ROI.
4. Position and enter the second point (P2) of the rectangular ROI. The NT border detection is performed. If a valid result is found, the borders are shown in red and the NT distance is displayed with two crosses.
5. If the measurement is correct according to the guidelines, accept and confirm the result to store in the report. If the system cannot detect a result, a warning message appears.

**NOTE:** *To edit the measurement, move the trackball and/or press Change to readjust the start and end point before accepting the measurement.*

**NOTE:** *It is possible to select the calculation method by pressing Method: (i-i: inner-inner or i-m: inner-middle).*

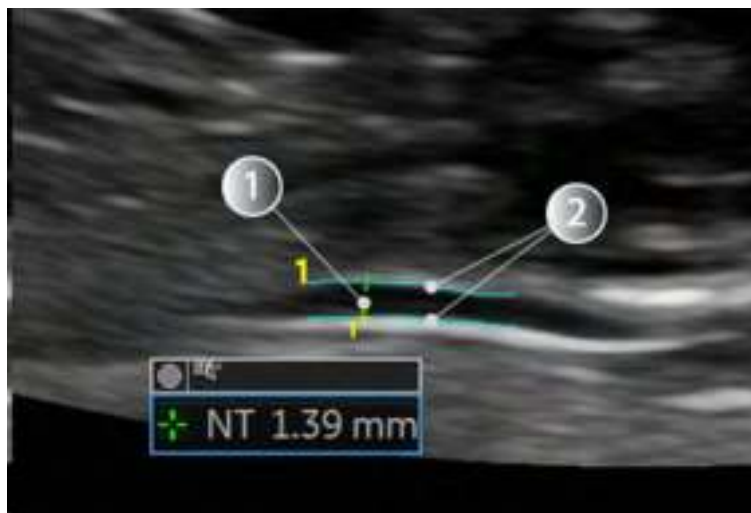

Figure 8-7. SonoNT

1. SonoNT Measurement

2. Detected NT Border

## **SonoNT (Nuchal Translucency) (continued)**

### **SonoIT (Intracranial Translucency)**

SonoIT (Sonography based Intracranial Translucency) is a system supported measurement for Intracranial Translucency. Starting from the routinely used midsagittal view of the fetal face, obtained for assessment of the Nuchal Translucency and nasal bone, the ultrasound system uses a semi-automated mode to measure the anterior-posterior diameter of the fourth ventricle recognizable as intracranial translucency.

The workflow is identical to SonoNT.

## OB Graphs

### Overview

OB Graphs allow you to assess fetal growth compared to a normal growth curve. When a patient has completed two or more ultrasound exams, you can also use the graphs to look at fetal trending. For multi-gestational patients you can plot all fetuses and compare the growth on the graphs.

The LOGIQ Totus provides the following two basic types of graphs:

- **Fetal Growth Curve graphs** – show one measurement per graph. These graphs show the normal growth curve, positive and negative standard deviations or applicable percentiles, and ultrasound age of the fetus using the current measurement. For multi-gestational pregnancies, you can view all fetuses. If previous exam data is available, the graph can show fetal trending.
- **Fetal Growth Bar graph** – shows the ultrasound age and the gestational age based on patient data. Plots all measurements on one graph.

### To View OB Graphs

To view OB graphs:

1. Press **Measure**.
2. Select **Graph**.

The system displays the OB Graph keys.

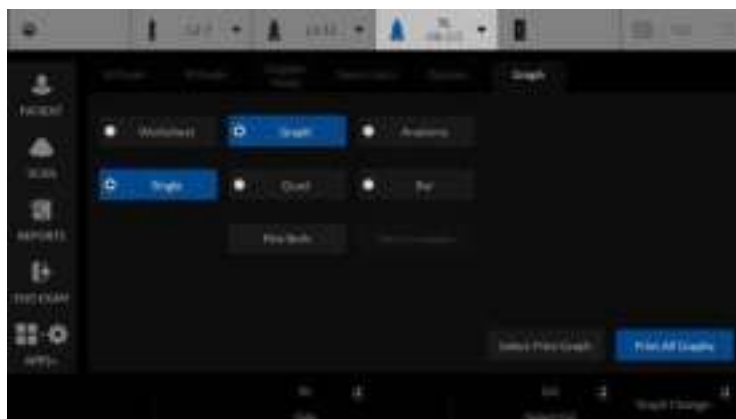

Figure 8-8. OB Graph keys on Touch Panel

## Fetal Growth Curve Graph

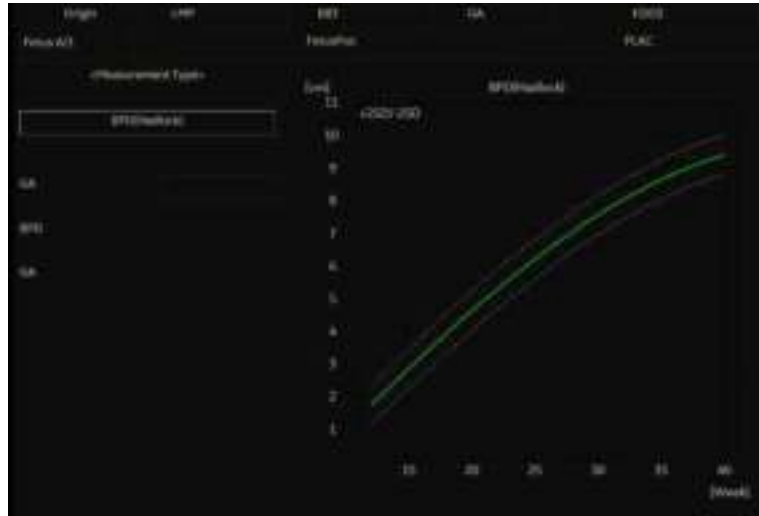

Figure 8-9. Fetal Growth Curve Graph (Single)

The horizontal axis shows the fetal age in weeks. The system determines this age from the data on the Patient Data Entry screen. The vertical axis shows one of the following:

- For measurements, mm or cm
- For ratios, percent
- For fetal weight, grams

The Fetal Growth Curve Graph shows the following information for the selected measurement:

- The normal growth curve
- The standard deviations or relevant percentiles
- The gestational age of the fetus, using patient data (vertical dotted line)
- Using the current ultrasound measurement data, where the fetus is on the growth curve

---

## Fetal Growth Curve Graph (continued)

### To select the measurement

To select which measurement you want to display on the Fetal Growth Curve Graph, do one of the following:

- To select a specific measurement:
  - a. On the graph display, move the **Trackball** to the Measurement Type field and press **Set**.  
The system displays a list of measurements.
  - b. Move the **Trackball** to select the desired measurement and press **Set**.  
The system displays the Fetal Growth Curve Graph for the selected measurement.
- To scroll through all Fetal Growth Curve Graphs, adjust the **Graph Change** control.

### To select the age to use

To plot the fetus age, the system allows you to use the gestational age (GA) from the LMP, or to use the composite ultrasound age (CUA). To select, adjust the **Select GA** control. The information in the left column changes between CUA and GA(EDD), and the data may change.

### To view a single or four graphs

You can view either a single Fetal Growth Curve Graph or you can view four graphs at the same time. To select each view, press **Single** or **Quad** to view 4 graphs at once.

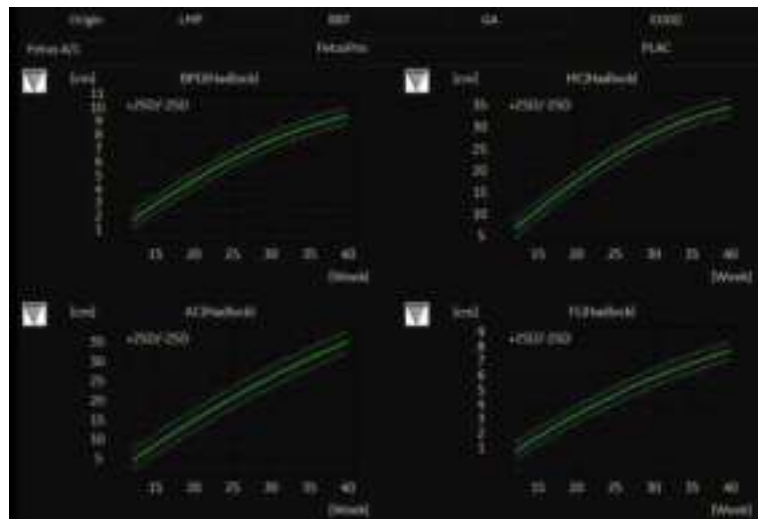

Figure 8-10. Fetal Growth Curve Graph: Quad View

The measurement values are displayed at the bottom of the graph.

---

### To change measurements in quad view

When you view four graphs simultaneously, you can select which four you want to see. To change each graph in quad view:

1. On the graph display, use the **Trackball** to move the cursor to the small box that is upper left of each graph, then press **Set**.

The system displays a list of measurements.

2. Move the **Trackball** to select the desired measurement and press **Set**.

The system displays the Fetal Growth Curve Graph for the selected measurement.

To scroll through all Fetal Growth Curve Graphs, adjust the **Graph Change** control.

The order of a quad graph view can be saved by selecting **Save**.

## Fetal Trending

When you have ultrasound data for more than one exam for a patient, you can use the data to look at fetal trending on the Fetal Growth Curve Graphs.

1. Select **Graph Display** and select the desired Fetal Growth Curve Graph.
2. Select **Plot Both**.

The system automatically finds the data from previous ultrasound exams, and displays it on the graph with the present data.

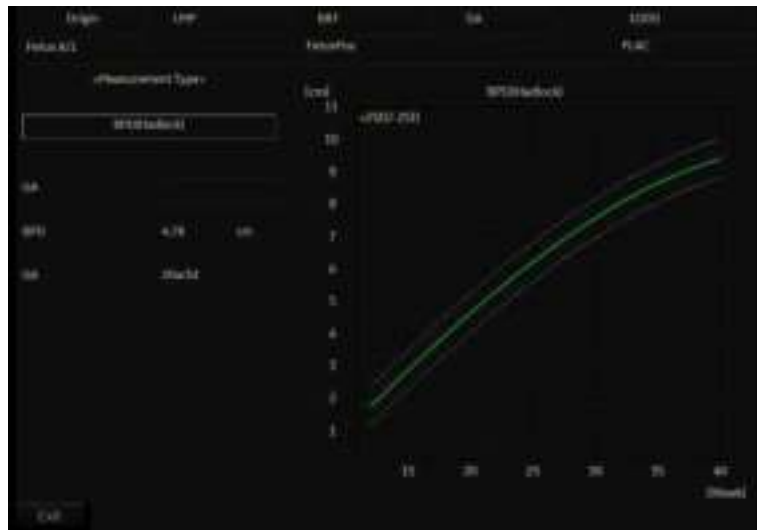

Figure 8-11. Fetal Trending on Fetal Growth Curve Graph

The legend at the bottom of the graph shows the symbols and colors that indicate Past and Present data.



## Fetal Trending (continued)

### To manually enter past exam data

If you have data from a previous ultrasound exam that you want to use for fetal trending, but it is not in the system, you can manually enter the data.

1. After you have registered the patient for this exam, on the Patient Data Entry screen, in the Exam Information (Obstetrics) section, select Past Exam.  
The system displays the Input Past Exam screen. See Figure 8-12.
2. Enter the data from previous exams.
3. To enter data on page 2, select Next.
4. After you enter the previous exam data, select Exit to Save.

The system saves the previous exam data. When you view the Fetal Growth Curve Graphs, select **Plot Both** to view fetal trending. The system automatically uses the data you entered.

Exam Date (MM/DD/YYYY)	BW (kg)	AMU (cm)	HC (cm)	AC (cm)	FL (cm)

Past Exam Data is used for plotting on Fetal Trend Graph only.

Figure 8-12. Input Past Exam screen, page 1

### To edit patient data

When you are working with graphs, you can change or enter the following patient data.

- GA(LMP) – this field is computed using the LMP date on the Patient Data Entry screen. To change this field:  
*NOTE: You can only change this field on the Fetal Growth Curve Graph in single view.*

- a. Move the **Trackball** to the field, which is left of the graph. To select the field, press **Set**.  
The system displays a window with the GA weeks and days.
- b. To select each field, move the **Trackball** to the field and press **Set**.
- c. Type the correct weeks or days.
- d. Select OK.

The system makes the following changes:

- GA (LMP) is now GA (GA) and shows the age you entered.
- In the Patient Data section, the GA changes.
- In the Patient Data section, The EDD (LMP) changes to EDD(GA) and shows an updated date, using the GA you entered.

The LMP is erased.

- FetusPos – type information about the fetus position.
- PLAC – type information about the placenta.

### To return from a graph to the scan display

After viewing graphs, to return to the scan display, do one of the following:

- On the graph display, select Exit.
- On the Touch Panel, select **Graph**.

## Fetal Growth Bar Graph

The fetal growth bar graph shows current exam measurements and the normal growth range based on the gestational age. It shows all measurements on one graph.

To view the Fetal Growth Bar Graph:

1. Press **Measure**.
2. Select **Graph**.
3. Select **Bar**.



Figure 8-13. Fetal Growth Bar Graph

- The horizontal axis shows the gestational weeks.
- The red vertical line shows the gestational age using the patient data.
- The blue dotted vertical line shows the ultrasound age using the current measurements.
- The yellow x shows the ultrasound age for each measurement.
- The green rectangle shows the normal age range for the measurement.

You cannot do fetal trending or view multiple gestation data on the bar graph.

## OB-Multigestational

### Multiple Fetus

LOGIQ Totus allows you to measure and report multiple fetus development. The system can report a maximum of four fetuses.

#### To enter the number of fetuses

If more than one fetus is imaged during the exam, enter the number of fetuses in the Patient Data Entry Menu.



Figure 8-14. Fetus Number

When you start an OB exam, the system automatically fills in the Fetus # field with 1. To change the number:

1. Move the cursor to the fetus number and press **Set** twice.  
The number is highlighted.
2. Type the correct number and press **Set**.  
The system displays a message to confirm that you want to change the fetus number.
3. Select Yes.

## To identify each fetus

For measurements, calculations, and worksheet displays, the system labels each fetus A, B, C, or D. Each fetus is identified by a letter and the total number of fetuses. For example, fetus A/3 is fetus A from a total of 3.

When scanning, you can enter information about the fetus position and placenta location. You can enter the information in the Patient Data section of the worksheets and the graphs. You can type up to 23 characters in the FetusPos and PLAC fields.

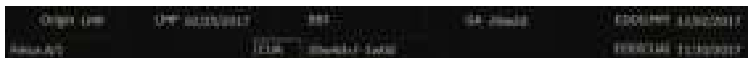

Figure 8-15. Patient Data section of the OB Worksheet

## To select a fetus

During measurements and calculations, to change between fetuses, do one of the following:

- Adjust the **Fetus** selection.
- Move the **Trackball** to the Summary Window and select the fetus.

You can change between fetuses at any time during the exam.

**NOTE:** *After you change to the next fetus, any measurements you make are recorded and reported to that fetus. If you have any active measurement or calculation that is not completed when you change the fetus, the system cancels the measurement or calculation.*

## To view multiple fetuses data on graphs

You can view multiple gestation data on fetal growth curve graphs. After you have made measurements for each fetus, select **Graph**.

1. To view the graph for each fetus, do one of the following:
  - Adjust the **Fetus** selection.
  - In the Patient Data section, move the **Trackball** to highlight the FetusNo field. In the list of fetuses, move the **Trackball** to select the fetus you want, and press **Set**.
2. To display data for multiple fetuses on the same graph, select **Fetus Compare**.

The legend at the bottom of the graph shows the symbols and colors that represent each fetus.

### To compare multiple fetus data on a worksheet

With multiple fetuses, you can list and compare measurements of the fetuses on the worksheet.

Select **Worksheet**, then select **Fetus Compare**.

When you select **Fetus Compare**, the system lists the measurement results for each fetus on the Worksheet.

### To Show Fetal Trending for Multiple Fetuses

When you have data for more than one exam, you can show fetal trending and compare fetuses on one graph.

To view fetal trending for multiple fetuses:

1. Select **Graph**.
2. Select **Fetus Compare**.
3. Select **Plot Both**.

**NOTE:** *You can only view fetal trending for multiple fetuses in single graph display.*

The symbol key for fetal trending and multiple fetuses is shown at the bottom of the graph.

## OB Table Editor

You can add user programmable OB tables to the system.

### OB Table Settings Menu

You add OB Tables in the Measurement & Analysis menu. To open the menu:

1. On the Touch Panel, select **Utility**, then select **M&A**.
2. Check the Exam Category on the far left of the monitor screen. Make sure that Obstetrics is selected.

If it is not selected, select Obstetrics and continue selecting the folders until the appropriate area is selected as to where this new OB Table will be entered. For example, select Obstetrics, then select OB-2/3. If there are further folders within OB-2/3, select that appropriate folder.

## OB Table Settings Menu (continued)

3. On the monitor display, select the OB Table tab.  
The system displays the OB Table settings menu.

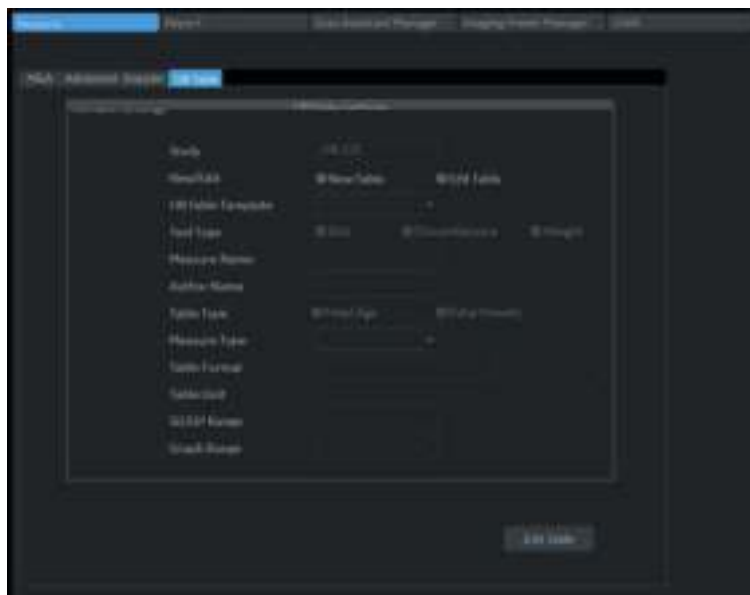

Figure 8-16. OB Table settings

4. The OB Table settings menu lists OB Table parameters. Specify the following parameter values as appropriate:
  - **Study:** Shows the study to which this measurement table belongs.
  - **New/Edit:** To create a new OB table, select New Table. To edit an existing user-programmable OB table, select Edit Table.

**NOTE:** *You cannot edit the system's OB Tables.*

## OB Table Settings Menu (continued)

- **OB Table Template:** To create a new OB table, select the Template (1 - 7) which you want to use as the basis of the user programmable OB Table. See 'OB Table Templates' on *page 8-31 for more information*.  
To edit an existing user OB table, select the desired OB table to edit.
- **Tool Type:** Select the type of measurement: Distance or Circumference.
- **Measure Name:** Type the name of measurement that will display on the Touch Panel.
- **Author Name:** Type the author's name.
- **Table Type:** If necessary, select the Table Type: Fetal Age or Fetal Growth.
- **Measure Type:** Select a measurement type that can be used to calculate EFW, for example BPD.

*NOTE: Measure Type is used only when calculating EFW.*

*NOTE: The following items are display only: Table Format, Table Unit, SD/GP Range, and Graph Range. The system determines these values automatically, based on the type of OB table you are creating.*

5. After specifying all parameter values, move the **Trackball** to *Edit Table* and press **Set**.

The system displays the Edit Menu.

*NOTE: If any of the OB table parameters are not correct, the Edit Menu is not displayed.*



## OB Table Templates

Tool Type:

- Distance: 2D Caliper
- Circumference: 2D Ellipse, 2D Trace, 2D Caliper

### Template 1

Table 8-3: Template 1 (based on Hadlock)

Template 1: SD Range Table				
Fetal Age Table	Table Format	MEAS	MEAN	SD
	Table Unit	mm	Week	Week
	Table Range	1SD		
	Graph Range	1SD		
Measurement Result	Value [cm]			
	GA [#w#d]			
	Min [#w#d]			
	Max [#w#d]			
Fetal Growth Table	Table Format	AGE	MEAN	SD
	Table Unit	Week	mm	Week
	Others are same as above			

Template 2

Table 8-4: Template 2 (based on Tokyo)

Template 2: SD Range Table				
Fetal Age Table	Table Format	MEAS	MEAN	SD
	Table Unit	mm	Day	Day
	Table Range	1SD		
	Graph Range	1SD		
Measurement Result	Value [cm]			
	GA [#w#d]			
	SD: day(+/-)			
	EDD (Date)			
	GA-Min [#w#d]			
	GA-Max [#w#d]			
Fetal Growth Table	Table Format	AGE	MEAN	SD
	Table Unit	Day	mm	Day
	Others are same as above			

## Template 3

Table 8-5: Template 3 (based on Osaka)

Template 3: SD Table				
Fetal Age Table	Table Format	MEAS	MEAN	SD
	Table Unit	mm	Day	mm
	Table Range	1SD		
	Graph Range	1SD		
Measurement Result	Value [cm]			
	GA [#w#d]			
	SD: $sd=(mv-pv)/sd$			
	EDD (Date)			
	GA-Min [#w#d]			
	GA-Max [#w#d]			
Fetal Growth Table	Table Format	AGE	MEAN	SD
	Table Unit	Day	mm	mm
	Others are same as above			

**Template 4**

Table 8-6: Template 4 (based on several European tables)

<b>Template 4: 5%-95% Table</b>					
Fetal Age Table	Table Format	MEAS	MIN	MEAN	MAX
	Table Unit	mm	WeekDay	WeekDay	WeekDay
	Table Range	5%:95%			
	Graph Range	5%:95%			
Measurement Result	Value [cm]				
	GA [#w#d]				
	GP [%] GP is calculated by Fetal Growth Table. If you did not edit Growth Table, GP is not calculated by the system,				
	EDD (Date)				
	GA-Min [#w#d]				
	GA-Max [#w#d]				
Fetal Growth Table	Table Format	AGE	MIN	MEAN	MAX
	Table Unit	WeekDay	mm	mm	mm
	Table Range	5%:95%			
	Graph Range	5%:95%			

**Template 5**

Table 8-7: Template 5 (based on several European tables)

<b>Template 5: 5% - 95% Table</b>				
Fetal Age Table	Table Format	MEAS	MEAN	SD
	Table Unit	mm	WeekDay	mm
	Table Range	1SD		
	Graph Range	5%:95%		
Measurement Result	Value [cm]			
	GA [#w#d]			
	GP [%] GP is calculated by Fetal Growth Table. If you did not edit Growth Table, GP is not calculated by the system,			
	EDD (Date)			
	GA-Min [#w#d]			
	GA-Max [#w#d]			
Fetal Growth Table	Table Format	AGE	MEAN	MAX
	Table Unit	WeekDay	mm	mm
	Table Range	1SD		
	Graph Range	5%:95%		

**Template 6**

Table 8-8: Template 6 (based on several European tables)

<b>Template 6: 5%-95% Table</b>					
Fetal Age Table	Table Format	MEAS	MIN	MEAN	MAX
	Table Unit	mm	WeekDay	WeekDay	WeekDay
	Table Range	10%:90%			
	Graph Range	10%:90%			
Measurement Result	Value [cm]				
	GA [#w#d]				
	GP [%] GP is calculated by Fetal Growth Table. If you did not edit Growth Table, GP is not calculated by the system,				
	EDD (Date)				
	GA-Min [#w#d]				
	GA-Max [#w#d]				
Fetal Growth Table	Table Format	AGE	MIN	MEAN	MAX
	Table Unit	WeekDay	mm	mm	mm
	Table Range	10%:90%			
	Graph Range	10%:90%			

**Template 7**

Table 8-9: Template 7 (Based on several European tables)

<b>Template 7: 10% - 90% Table</b>				
Fetal Age Table	Table Format	MEAS	MEAN	SD
	Table Unit	mm	WeekDay	mm
	Table Range	1SD		
	Graph Range	10%:90%		
Measurement Result	Value [cm]			
	GA [#w#d]			
	GP [%] GP is calculated by Fetal Growth Table. If you did not edit Growth Table, GP is not calculated by the system,			
	EDD (Date)			
	GA-Min [#w#d]			
	GA-Max [#w#d]			
Fetal Growth Table	Table Format	AGE	MEAN	MAX
	Table Unit	WeekDay	mm	mm
	Table Range	1SD		
	Graph Range	10%:90%		

## OB Table Edit Menu

The data you enter in the OB Table Edit Menu depends on whether the table type is Fetal Age or Fetal Growth.

### Fetal Age Table

If you are creating or editing a Fetal Age table, the OB Table Edit Menu is as follows:

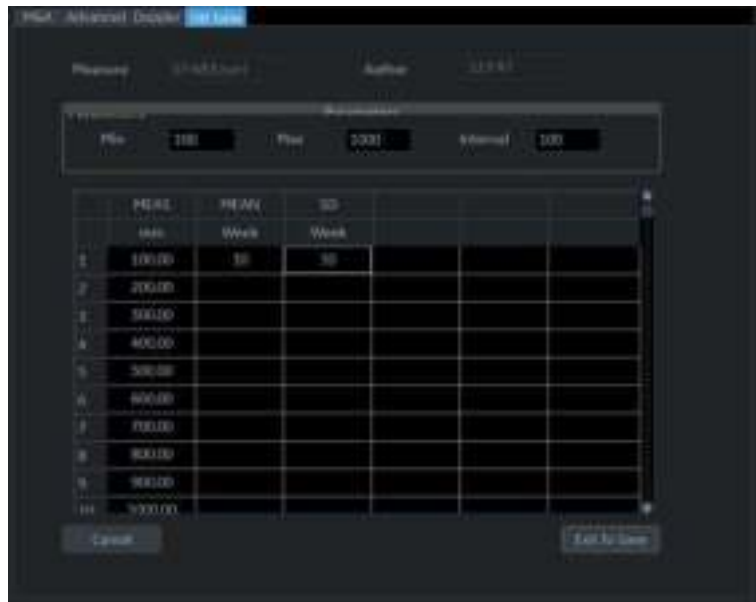

Figure 8-17. OB Table Edit Menu: Fetal Age Table

### Complete the field

1. Input value to Min, Max and Interval of the Parameters field. The system automatically fills in the MEAS column. Input value to the columns of MEAN and SD.

**NOTE:** To move between the fields in the table, use the up, down, left, and right arrow keys.

**NOTE:** You must enter a minimum of two rows of data. Any lines with a blank cell are not saved.

To save the Table Data, move the **Trackball** to Exit to Save and press **Set**. If you want cancel this table, move the **Trackball** to Cancel and press **Set**.



## Fetal Growth Table

If you are creating or editing a Fetal Growth table, the OB Table Edit Menu is as follows:

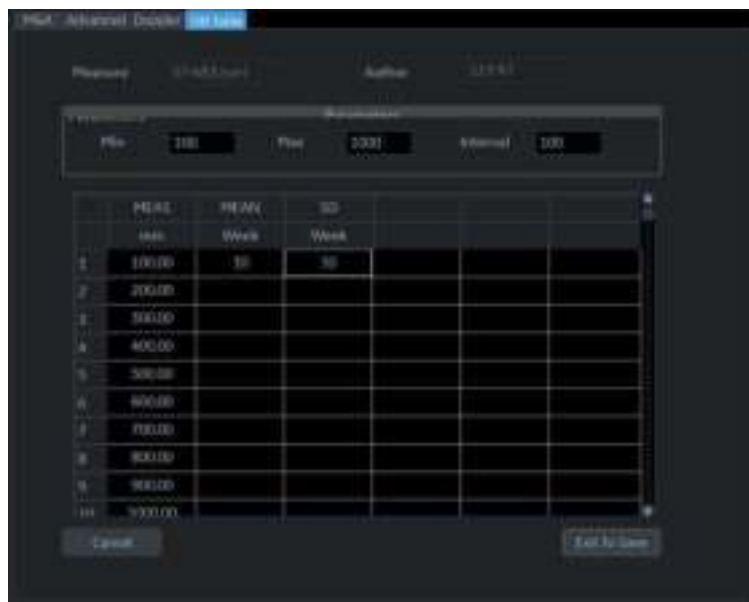

Figure 8-18. OB Table Edit Menu: Fetal Growth Table

### Complete the field

1. Input value to the required columns.

**NOTE:** To move between the fields in the table, use the up, down, left, and right arrow keys.

**NOTE:** You must enter a minimum of two rows of data. Any lines with a blank cell are not saved.

2. To save the Table Data, move the **Trackball** to Exit to Save and press **Set**. If you want cancel this table, move the **Trackball** to Cancel and press **Set**.

After you complete the OB table, it is now available for the selected study. To use the measurement, you must assign it to a Touch Panel. See 'Measurement and Calculation Setup' on page 7-74 for more information.

## EFW for OB User Table/Formula Editor

### EFW Table Editor

You can edit an EFW Formula at the OB Table Editor.

1. Select Utility -> Measure -> OB Table.
2. Select the appropriate parameters and press **Edit Table**.
  - New/Edit: Select “New Table”
  - OB Table Template: Select appropriate template.
  - Tool Type: Select “Weight”
  - Measure Name: Enter measurement name.
  - Author Name: Enter author’s name.
  - Table Type: Select “Fetal Age”



Figure 8-19. OB Table Tab Screen

## EFW Table Editor (continued)

3. Edit the table data and press **Exit To Save**.

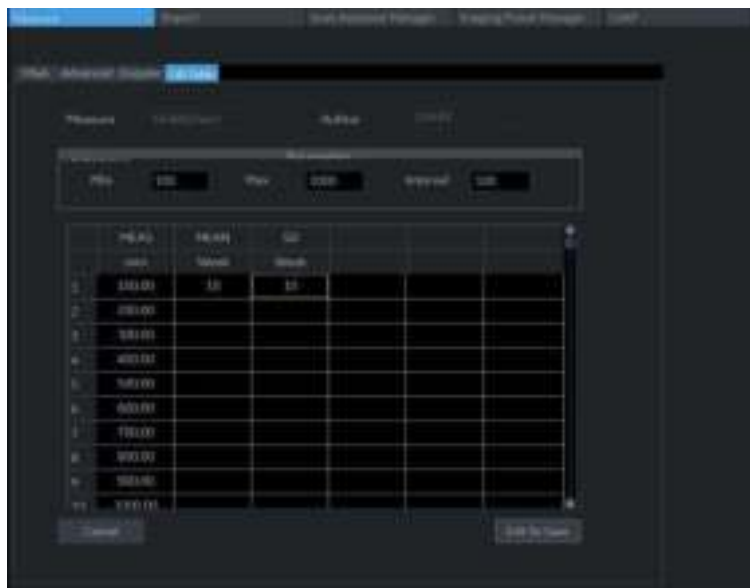

Figure 8-20. OB Table Editor Screen

## EFW Formula Editor

1. Select the M&A tab and select **Edit Calc**. The Modify User CALC window displays.  
Select the user table previously added from the User Defined pull-down menu and press **OK**.
2. Select the "Calculated" button for the EFW parameter.
3. The EDIT FORMULA window displays. Edit the formula and select **OK**.

**NOTE:** *When you edit a formula, be careful of the following points.*

- If you want to calculate EFW by centimeter, add " \*100 " to the {parameter}.
- If EFW is calculated in grams, add " /1000 " to the formula.

or example,

$$10^{(1.56\{AC[\text{Hadlock}]\} * 100 + 0.08 * \{FL[\text{Hadlock}]\} * 100) / 1000}$$

## Introduction

The Gynecology exam category includes the following three studies:

- Generic. This study is common to all exam categories. 'Generic Measurements' on *page 7-18*.
- General Gynecology. This study includes uterine, ovarian, ovarian follicle, and endometrium measurements.
- OB/GYN Vessel. This study includes the following vessels: uterine, ovarian, umbilical, middle cerebral artery, aorta, placenta, and descending aorta.

*NOTE: The calculation formulas are listed in the Advanced Reference Manual.*

## B-Mode Measurements

In B-Mode, you make the measurements in the General Gynecology study. These measurements include:

- Ovarian follicle
- Endometrium thickness
- Ovarian length, width, and height
- Uterine length, width, and height
- Cervix
- Fibroid

## Follicle measurements

You can make left and right ovary follicle measurements from one, two, or three distances.

To select the left or right, adjust the **Side** selection.

## Endometrium thickness

To measure the endometrium thickness, make one distance measurement.

1. Select **Endometrium**; an active caliper displays.
2. To position the active caliper at the start point, move the **Trackball**.
3. To fix the start point, press **Set**.  
The system fixes the first caliper and displays a second active caliper.
4. To position the second active caliper at the end point, move the **Trackball**.  
A dotted line connects the measurement points.
5. To complete the measurement, press **Set**.  
The system displays the endometrium thickness in the Results Window.

## Ovary length, width, and height

You can measure the length, width, and height of the left and right ovaries. Each measurement is a typical distance measurement made in the appropriate scan plane.

Typically, length and height are measured on the sagittal plane while the width is measured on the axial/transverse plane.

To measure ovarian length, width, or height:

1. Scan the patient's right or left ovary in the appropriate plane.
2. To select left or right, adjust the **Side** selection.
3. Select the **OV** folder, then select **OV L**, **OV W**, or **OV H**.
4. Perform a standard distance measurement.

## Uterus length, width, and height

Each of these is a standard distance measurement. Typically, length and height are measured on the sagittal plane while the width is measured on the axial/transverse plane.

To measure uterus length, width, or height:

1. Scan the patient in the appropriate scan plane.
2. Select the **UT** folder, then select **UT L**, **UT W**, or **UT H**.  
An active caliper displays.
3. Perform a standard distance measurement.

## Cervix measurements

You can make cervix measurements from one distance or spline trace.

# Cardiac

## Overview

Cardiology measurements offer two different types of measurement studies, Generic and Cardiac.

- Generic—Common to all applications. See 'Generic Measurements' on *page 7-18 for more information..*
- Cardiac – This study includes all cardiac measurements.

## Naming Format for Cardiac Measurements

When you make a measurement, on the Touch Panel you select the abbreviation for the measurement. Most abbreviations are made using acronyms. The following table lists acronyms used for naming cardiac measurements.

Table 8-10: Cardiology Abbreviations

Acronym	Name
% STIVS	% Interventricular Shortening
A	Area
Acc	Acceleration
AccT	Flow Acceleration Time
ALS	Aortic Leaflet Separation
Ann	Annulus
Ao	Aorta
AR	Aortic Regurgitation
Asc	Ascending
ASD	Atrial Septal Defect
AV	Aortic Valve
AV Cusp	Aortic Valve Cusp Separation
AVA	Aortic Valve Area
AV-A	Aortic Valve Area by Continuity Equation

Table 8-10: Cardiology Abbreviations (Continued)

Acronym	Name
BSA	Body Surface Area
CI	Cardiac Index
CO	Cardiac Output
d	Diastolic
D	Diameter
Dec	Deceleration
DecT	Deceleration Time
Desc	Descending
Dur	Duration
EdV	End Diastolic Volume
EF	Ejection Fraction
EPSS	E-Point-to-Septum Separation
EsV	End Systolic Volume
ET	Ejection Time
FS	Fractional Shortening
FV	Flow Volume
FVI	Flow Velocity Integral
HR	Heart Rate
IVRT	IsoVolumetric Relaxation Time
IVS	Interventricular Septum
L	Length
LA	Left Atrium
LAA	Left Atrium Area
LAD	Left Atrium Diameter
LPA	Left Pulmonary Artery
LV	Left Ventricle
LVA	Left Ventricular Area
LVID	Left Ventricle Internal Diameter
LVL	Left Ventricle Length
LVM	Left Ventricular Mass



Table 8-10: Cardiology Abbreviations (Continued)

Acronym	Name
LVPW	Left Ventricle Posterior Wall
ML	Medial to Lateral
MPA	Main Pulmonary Artery
MR	Mitral Regurgitation
MV	Mitral Valve
MVcf	Mean Velocity Circumferential Fiber Shortening
MVO	Mitral Valve Orifice
OT	Outflow Tract
P	Papillary Muscles
PA	Pulmonary Artery
PAP	Pulmonary Artery Pressure
PDA	Patent Ductus Arteriosis
PEP	Pre-Ejection Period
PFO	Patent Foramen Ovale
PG	Pressure Gradient
PHT	Pressure Half Time
PI	Pulmonary Insufficiency
PISA	Proximal Isovelocity Surface Area
PR	Pulmonic Regurgitation
PV	Pulmonic Valve
PV-A	Pulmonic Valve Area by Continuity Equation
PVein	Pulmonary Vein
PW	Posterior Wall
Qp	Pulmonic Flow or CO
Qs	Systemic Flow or CO
RA	Right Atrium
RAA	Right Atrium Area
Rad	Radius
RAD	Right Atrium Diameter
RPA	Right Pulmonary Artery

Table 8-10: Cardiology Abbreviations (Continued)

Acronym	Name
RV	Right Ventricle
RVA	Right Ventricle Area
RVAW	Right Ventricle Anterior Wall
RVD	Right Ventricle Diameter
RVID	Right Ventricle Internal Diameter
RVL	Right Ventricle Length
RVOT	Right Ventricle Outflow Tract
s	Systolic
SI	Stroke Index
ST	Shortening
SV	Stroke Volume
SVI	Stroke Volume Index
T	Time
TA	Tricuspid Annulus
TAML	Tricuspid Annulus Medial to Lateral
TR	Tricuspid Regurgitation
TV	Tricuspid Valve
TVA	Tricuspid Valve Area
Vcf	Velocity Circumferential Fiber Shortening
Vel	Velocity
VET	Valve Ejection Time
Vmax	Maximum Velocity
Vmean	Mean Velocity
VSD	Ventricular Septal Defect
VTI	Velocity Time Integral

In this manual, the abbreviation for each measurement is listed in parenthesis after the measurement, as follows:

- Aortic Root Diameter (***Ao Diam***)
- Left Ventricle Posterior Wall Thickness, Diastolic (***LVPWd***)

For example, to measure the Aortic Root Diameter, you select ***Ao Diam*** on the Touch Panel.

---

## Cardiac Doppler Measurements

### E/E' Ratio

The ratio of early transmitral velocity to early diastolic velocity of the mitral annulus (E/E') is measured in Doppler Mode and TVD mode.

1. First, measure MV E/A Velocity to get "E".
2. Measure E'.

The system calculates E/E' ratio automatically.

## Introduction

Vascular measurements offer several different types of measurement studies:



Figure 8-21. Vascular Exam Category Touch Panel

- Generic – Common to all applications. See ‘Generic Measurements’ on *page 7-18 for more information..*
- Carotid
- LEA (Lower Extremity Artery)
- LEV (Lower Extremity Vein)
- TCD (Trans Cranial Doppler)
- UEA (Upper Extremity Artery)
- UEV (Upper Extremity Vein)
- Renal
- Bypass Graft
- UEV (Upper Extremity Vein) Map
- LEV (Lower Extremity Vein) Map

## Introduction (continued)

A vascular study is a group of particular vessels. You can customize the vessel exam calcs in the configuration menu. See 'Measurement and Calculation Setup' on *page 7-74 for more information..*

When you use Auto Vascular calculation, you use the vessel keys on the Touch Panel to post-assign vascular calculations. When you are not using Auto Vascular calculation, the vessel key is used for manual measurement.

## Naming format for vessels

When you want to measure a vessel, on the Touch Panel you select the folder for the vessel. Many vessel folders are labeled with an abbreviation. The following table lists abbreviations used for naming vascular vessels.

Table 8-11: Vascular Vessel Abbreviations

Acronym	Name
ACA	Anterior Cerebral Artery
Acc RA	Accessory Renal Artery
ACoMA	Anterior Communicating Artery
Anast	Anastomosis
ArcA	Arcuate Artery
ATA	Anterior Tibial Artery
ATV	Anterior Tibial Vein
AVF	Arteriovenous Fistula
Axill	Axillary Artery
Axill V	Axillary Vein
BA	Basilar Artery or Brachial Artery
Bas V	Basilic Vein
BasV Antecub	Basilic Vein Antecubital Fossa
BIF IMT F/N	Bifurcation Intima Media Thickness Far/Near
Brac V	Brachial Vein
CA	Celiac Artery
CCA	Common Carotid Artery

Table 8-11: Vascular Vessel Abbreviations (Continued)

Acronym	Name
Ceph V	Cephalic Vein
Ceph V Antecub	Cephalic Vein Antecubital
CFA	Common Femoral Artery
CFV	Common Femoral Vein
CHA	Common Hepatic Artery
Com Femoral	Common Femoral Artery
CIA	Common Iliac Artery
CIV	Common Iliac Vein
Com Iliac A	Common Iliac Artery
DFA	Deep Femoral Artery
DFV	Deep Femoral Vein
Dors Pedis	Dorsalis Pedis
DPA	Dorsalis Pedis Artery
ECA	External Carotid Artery
EIA	External Iliac Artery
EIV	External Iliac Vein
Fr. Branch	Frontal Branch
FV	Femoral Vein
GBWall	Gall Bladder Wall
GDA	Gastroduodenal Artery
GR	Graft
GSV	Greater Saphenous Vein
HA	Hepatic Artery
Hilar A	Hilar Artery
HV	Hepatic Vein
IIA	Internal Iliac Artery
IIV	Internal Iliac Vein
ICA	Internal Carotid Artery (Transcranial Doppler)
ICA	Interior Carotid Artery (Carotid Artery)
IJV	Internal Jugular Vein

Table 8-11: Vascular Vessel Abbreviations (Continued)

Acronym	Name
IMA	Inferior Mesenteric Artery
IMT	Intima Media Thickness
IMV	Inferior Mesenteric Vein
Inn	Innominate
Int. Lobular A	Interlobular Artery
IVC	Inferior Vena Cava
LSV	Lesser Saphenous Vein
MCA	Middle Cerebral Artery
Mcub V	Median Cubital Vein
Mid Hep V	Middle Hepatic Vein
MPV	Main Portal Vein
MRA	Main Renal Artery
Par. Branch	Parietal Branch
PCA	Posterior Cerebral Artery
PCoMA	Posterior Communicating Artery
Peron	Peroneal
POP	Popliteal
Pseudo	False Artery (aneurysm)
PTA	Posterior Tibial Artery
PTV	Posterior Tibial Vein
PV	Portal Vein
RA	Renal or Radial Artery
RV	Renal or Radial Vein
SA	Splenic Artery
Sap Fem Junc	Sapheno-Femoral Junction
Seg. A	Segmental Artery
SFA	Superficial-Femoral Artery
SFJV	Sapheno-Femoral Junction Vein
SMA	Superior Mesenteric Artery
SMV	Superior Mesenteric Vein

Table 8-11: Vascular Vessel Abbreviations (Continued)

Acronym	Name
SSV	Small Saphenous Vein
STA	Superficial Temporal Artery
SUBC	Subclavian Artery
SUBC V	Subclavian Vein
SV	Splenic Vein
SV Pop Junc	Small Saphenopopliteal Junction
TCD	Transcranial Doppler
TIPS	Transjugular Intrahepatic PortalSystemic Shunt
UA	Ulnar Artery
UV	Ulnar Vein
VERT	Vertebral Artery
VES	Vessel



## IMT Measurement

You can measure the average of the intima media thickness for use as the index of arterial sclerosis.

IMT can be measured both on the posterior and the anterior walls of the vessel.

**NOTE:** *Due to the physical properties of ultrasound imaging, the posterior IMT measurement is generally more accurate than the anterior IMT measurement.*

### IMT Measurement - Auto

Auto IMT automatically measures the thickness of the Intima Media on the far and near vessel walls. Near Wall IMT is the distance between the trailing edges of the adventitia and intima; the Far Wall IMT is the distance between the leading edges of the adventitia and intima.

Set up the parameters you want to record on the worksheet on the Utility -> Measure -> M&A page while are in the Carotid application. Select CCA/ICA/BIF -> IMT Far/Near -> Parameter (Average, Max, Min, Standard Deviation, Points, or Distance).

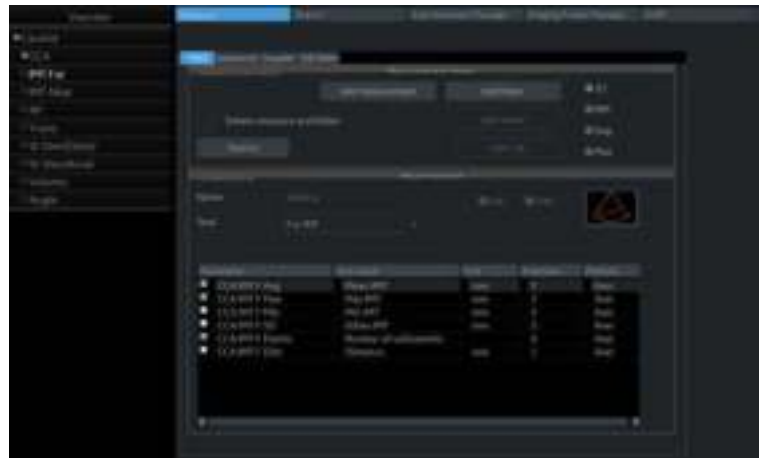

Figure 8-22. Configuring Auto IMT

**IMT Measurement - Auto (continued)**

In the Vascular Carotid application, the Auto IMT measurement is available.



Figure 8-23. Auto IMT Touch Panel

The following controls are available.

Table 8-12: Auto IMT Touch Panel Description

Parameter	Description
Worksheet	Select to view the Worksheet
IMT Far	Select to begin the Far Field IMT measurement.
IMT Near	Select to begin the Near Field IMT measurement.
AP	Anterior Posterior
Trans	Transverse
Length/Offset Rotary	Push to save Length/Offset as a preset. -40/+40 Length. At zero, you can freely adjust the length, but only vertically. Press key to save value as default. Offset distance, -20 (Left) / +20 (Right)
Overall / IMT Trace Fit / Intima	Adjusts (remeasures) the IMT automatically measured by the system.
Rt / Lt Side	Select Left / Right Side.
Cursor Select	Allows you to update cursor placement.

## IMT Measurement - Auto (continued)

To measure the IMT,

1. In the Carotid application, press **Freeze**, press **Measure**.
2. Position the cursor, then select **IMT Far**.
3. Use the **Trackball** to set the length.

Or

Use the **Length / Offset** control on the Touch Panel to set the length and offset distance. The Offset key controls how far away from the vertical line the measurement starts.

Length is the length of the tool itself. If set to zero, you can adjust it anywhere on the image.

4. Press **Set**.

You can either adjust the trace prior to pressing the Print key or press the Print key to store the image which also saves the measurement to the Worksheet.

To adjust the trace, use the **Overall IMT Trace Fit Intima** control on the Touch Panel. The Trace fit (up/down) adjusts the inter luminal line whereas the overall (rotate) adjusts both IMT lines.

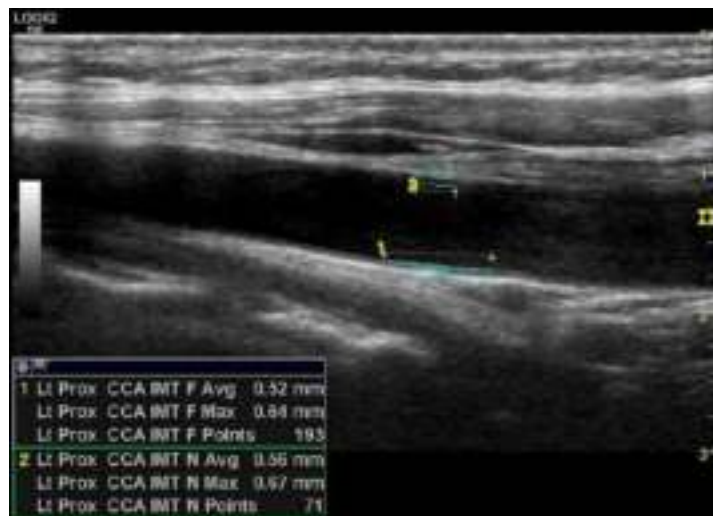

Figure 8-24. Example of Auto IMT Far Measurement

## IMT Measurement - Auto (continued)

5. Position the cursor, then select IMT Near.
6. Use the **Trackball** to set the length.  
Or  
Use the **Length / Offset** control on the Touch Panel to set the length and offset distance.
7. Press **Set**. “Store image to accept IMT measurement” displays in the message area. If the traces fit both layers of the wall, approve the measurement by pressing the **Print** key to store the image.

To adjust the trace prior to pressing the Print key, use the IMT Trace Fit control on the Touch Panel. The measurement is saved to the Worksheet.

*NOTE: Since the IMT measurements are semi-automatic, the operator has to approve the detection by visual inspection before storing the results in the worksheet and report.*

## IMT Measurement - Manual

1. Before you measure the IMT, add the IMT measurement to the Carotid folder via the Measurement & Analysis screen (by selecting one of the three types of IMT measurements under Add Measurement in the M&A screen).
    - IMT: Three vertical lines are parallel. Place the start point on the line and place the end point anywhere.
    - IMT2: Each vertical line can be rotated with the **Ellipse** control. You must place the start and end points on the line.
    - 5mm Scale: The horizontal line can be rotated with the **Ellipse** control. A maximum of 20 distance values which produce one average value can be taken. The number of distance values is specified when adding the measurement in the M&A screen.
- IMT and IMT2 have three kinds of measurements:
- IMT --+/IMT2 --+: Measure from right to left.
  - IMT -+-/IMT2 -+ -: First measure at the center, then right and left are last.
  - IMT+--/IMT2 --+: Measure from left to right.
2. Acquire a longitudinal scan of the carotid artery and optimize the image. Then press **Freeze**.
  3. Scroll to an end-diastolic frame where the intima layer is clearly visible.

## IMT Measurement - Manual (continued)

4. Press **Measure**, then select **IMT1**, **IMT2** or **5mm scale**. An active caliper displays.



Figure 8-25. IMT caliper (Example)

5. Use the **Trackball** to move the caliper and the **Ellipse** control to adjust the angle. Press **Set** to fix the caliper.

**NOTE:** *The interval of the vertical line for IMT1 and IMT2 is 1cm and for the 5mm scale is 5mm.*

6. Measure the thickness of three points for IMT1 and IMT2.  
OR

Measure the thickness of the specified number of points for the 5mm scale.

**NOTE:** *The caliper moves to the next point automatically.*

## IMT Measurement - Manual (continued)

7. After you complete the measurement, the system calculates the average automatically.



Figure 8-26. IMT Measurement

## IMT Measurement - Manual C(10)

1. Before you measure the IMT C10, create the IMT C10 measurement in the Carotid folder via the Measurement & Analysis screen.
  - IMT C10: Two vertical lines are parallel. One is the base line. Each vertical line can be rotated with the Ellipse control. Place the start point on the line and place the end point anywhere.
  - IMT2 C10: Two vertical lines are parallel. One is the base line. Each vertical line can be rotated with the Ellipse control. You must place the start and end points on the line.

IMT C10 and IMT2 C10 have two kinds of measurements:

- IMT C10 -+/IMT2 C10 -+: Base vertical line shows right side.
- IMT C10 +/-IMT2 C10 +/-: Base vertical line shows left side.

**IMT Measurement - Manual C(10) (continued)**

2. Acquire a longitudinal scan of the carotid artery and optimize the image. Then press **Freeze**.
3. Scroll to an end-diastolic frame where the intima layer is clearly visible.
4. Press **Measure**, then select **IMT C10**. An active caliper displays.

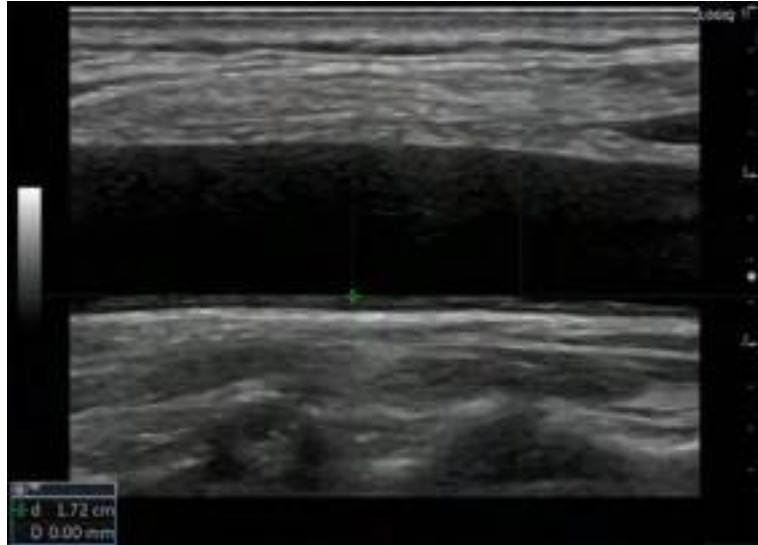

Figure 8-27. IMT C10 Active Caliper

5. Use the trackball to move the caliper and the Ellipse control to adjust the angle. Press **Set** to fix the caliper.

**NOTE:** *The interval of the vertical line for IMT1 and IMT2 is 1cm.*

6. Measure the thickness for IMT C10.

**IMT Measurement - Manual C(10) (continued)**

7. After you complete the measurement, the system shows base vertical line.

*NOTE: The base vertical line length is 1cm.*

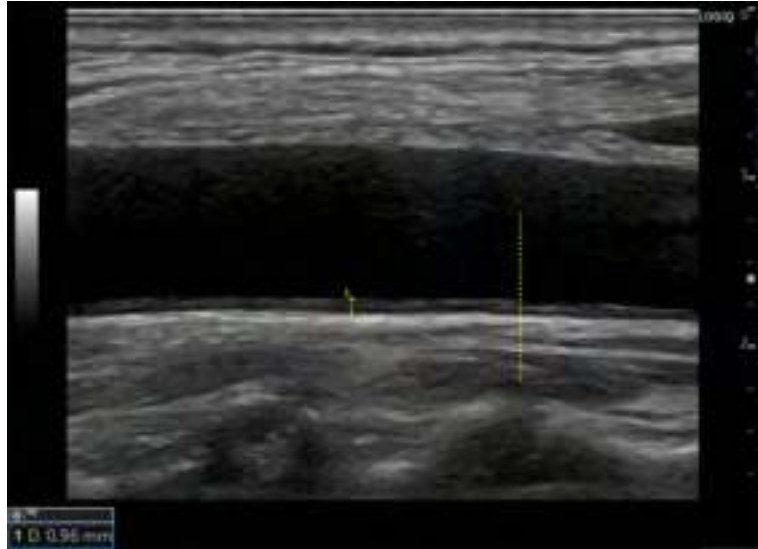

Figure 8-28. Base Vertical Line



## Plaque Score Tool

1. Before you measure, add Plaque Score to the Carotid folder at the Utility -> Measure -> Measurement & Analysis screen (by selecting 2D Plaque Score under Add Measurement in the M&A screen).

Label the parameters you want measured:

- Distance value (up to 20)
  - Sum (greater or equal to 1.1 mm)
  - Count (greater or equal to 1.1 mm)
  - Maximum value of each area
  - Average value
  - Average value of each area
2. Scan the carotid artery and press **Freeze**. Display dual images to measure across split screen images.
  3. Press **Measure** and select **Plaque Score Tool**. An active caliper, one horizontal line and five vertical lines display. The interval of the vertical lines are 1.5 cm.

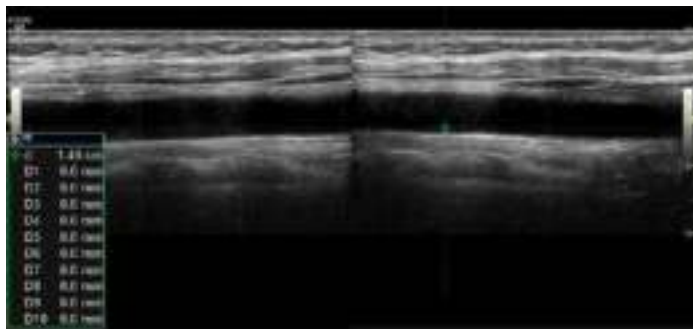

Figure 8-29. Plaque score example

4. Use the **Trackball** to move the caliper and the **Ellipse** control to adjust the angle. Press **Set** to fix the caliper.

## Plaque Score Tool (continued)

5. Measure the thickness (up to twenty times) on any place as necessary.

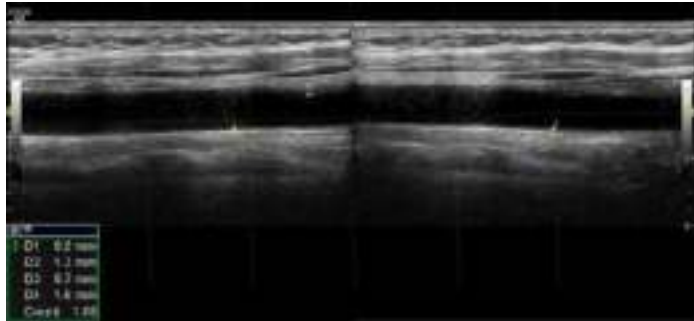

Figure 8-30. Plaque Score Example 2

6. The system displays the measurement result.

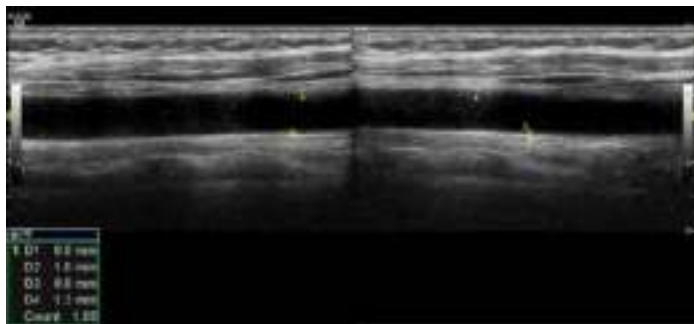

Figure 8-31. Plaque Score Example 3

**NOTE:** *Only calculates the value larger than 1.1mm.*

7. Double click the **Set** key to finish the measurement.

## Auto Vascular Calculation

Auto Vascular Calculation enables the LOGIQ Totus to detect and identify a cardiac cycle. It allows you to assign measurements and calculations during live timeline imaging, while the image is frozen, or in CINE. Peak values are detected for venous flow.

During cardiac cycle detection, the system identifies the cardiac cycle using calipers, vertical bars, and/or highlighting of timeline data. Use of identifiers is based on measurements and calculations selected by an operator for the current application. The system may place calipers at early systolic peak, peak systole, minimum diastole and end diastole. Vertical bars may also be placed to indicate the beginning and end of the cardiac cycle. The peak and/or mean trace may be highlighted. You can edit the cardiac cycle identified by the system or select a different cardiac cycle.

You can select the calculations to be displayed in the M&A Result window during live scanning or on a frozen image. These calculations are displayed at the top of M&A Result Window located adjacent to the image. These calculations are presettable by application which means you can set up the default calculations to be displayed for each application.

## Activating Auto Vascular Calculation

To activate Auto Vascular Calculation, select **Auto Calc** from Live (calculations displayed on the real-time image), or Freeze (calculations displayed on the frozen image).

To deactivate Auto Vascular calculation, select Off.

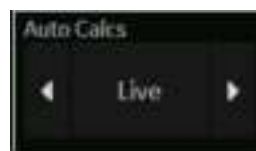

Figure 8-32. Auto Calculation Touch Panel key

## Setting up Auto Vascular Calculation Parameters

- **Selecting Auto Trace**

You can select to have a continuous auto trace of the max or mean velocities.

- Select Max or Mean using the **Trace Method** Touch Panel pull-down menu.

- **Selecting Trace Direction**

Trace Direction lets you use peak timeline data above, below, or composite (above and below) the baseline.

- Select Positive, Negative or Both to set the peak timeline data.

- **Modify Calculation**

- a. Select the **Modify Calcs** Touch Panel key.  
The Modify Calculation menu is displayed.
- b. Select which measurements and calculations are to be displayed in the Auto Vascular calculation window.

You can select the following parameter: PS, ED, MD, HR, TAMAX, PI, RI, Accel, PS/ED, ED/PS, AT, Volume Flow, PV.

## Auto Vascular Calculation Exam

1. Preset the system.
2. Perform the scan and press **Freeze**.
3. Activate Auto Vascular Calculation.

The system performs a calculation automatically.

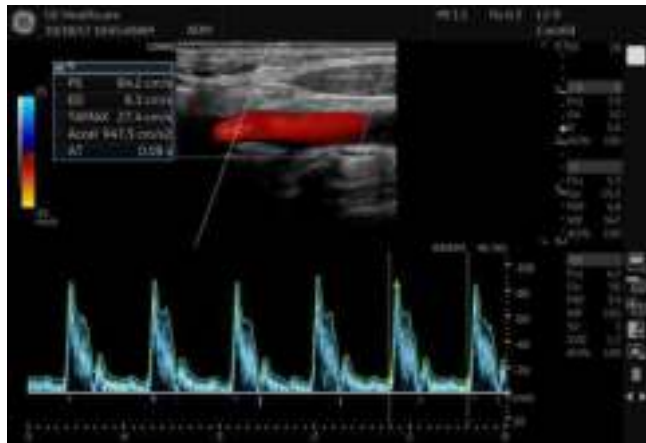

Figure 8-33. Auto Vascular Calculation

## Auto Vascular Calculation Exam (continued)

The Auto Vascular calculation is assigned to particular vessel measurements.

1. Press **Measure** to display the Measurement menu.
2. Select the location of the vessel (Prox, Mid, or Dist) and Side (Right or Left).
3. Select the desired vessel name from the Touch Panel.

Selected vessel measurements are automatically assigned with the Auto Vascular calculation. The results are then displayed in the Results Window.

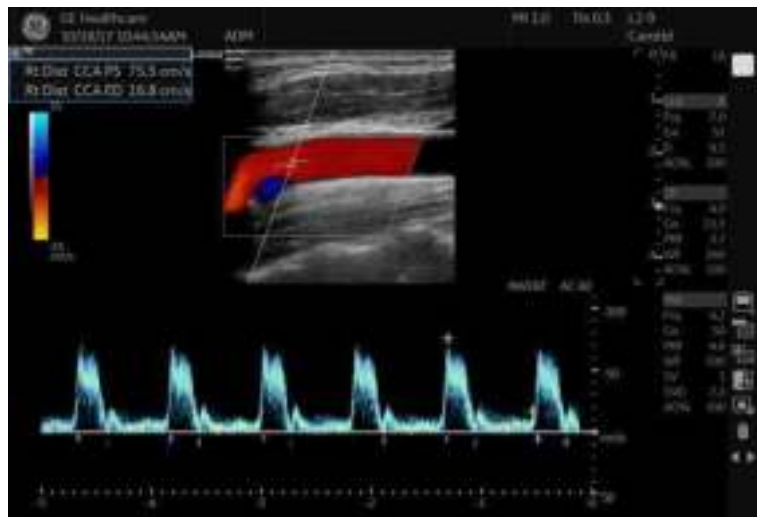

Figure 8-34. Assigned Vessel

**NOTE:** When you want to cancel the assignment, you can use the **Cancel Transfer** Touch Panel key. See 'Cancel Transfer' on page 7-32 for more information..

## Auto Vascular Calculation (continued)

During the course of an exam, the cardiac cycle may be indicated between two yellow bars; the peak trace and the mean trace may appear in green; calculation indicators appear on the spectral trace as a caliper identifier (these vary, depending on the selected calculation in the Results Window).

The right-most, most complete cycle is typically chosen to be the selected cardiac cycle. You can select a different cardiac cycle.

To select a different cardiac cycle:

- Move through CINE memory with the Trackball until the desired cardiac cycle is selected by the system.
- Use the **Cycle Select** control to cycle to a different cardiac cycle.

*NOTE: You need several good cycles in front of the new cardiac cycle for this to be successful. Oftentimes, this is problematic near a freeze bar.*

*NOTE: You need several good cycles in front of the new cardiac cycle for this to be successful. Oftentimes, this is problematic near a freeze bar.*

To move the systole or diastole position:

- Use the **Cursor Select** control to move the start systole position or the end diastole position.

## Manual Vascular Calculation

You can perform the following calculations manually when Auto Doppler Calculation is not activated.

1. Press **Measure**.  
If necessary, you can select another Exam Calc and then select parameters from Modify Calculation.
2. Select the location of the vessel (Prox, Mid, or Dist) and Side (Right or Left).
3. Select the desired vessel folder.  
The Measurement menu is displayed.



Figure 8-35. Measurement Menu Example

4. Make the required measurements according to the system, or select your preferred measurements.

### To select vascular measurements

Your system is set up to show the measurements that you usually make for each vessel. To make a measurement that is not shown for the selected vessel:

1. Select the folder for the vessel you want to measure.
2. Select **Show All**.  
The system displays all possible vessel measurements.
3. Select the desired measurement.

**NOTE:** *The following instructions assume that you first scan the patient and then press **Freeze**.*

## Intravessel ratio

On the Vessel Worksheet page, to calculate the Intravessel ratio, you need a measurement of assessing pressure and stenotic velocities.

1. Select **Intrav. Ratio** from the Touch Panel. The Intravessel Ratio pop-up window displays in the header section of the worksheet.

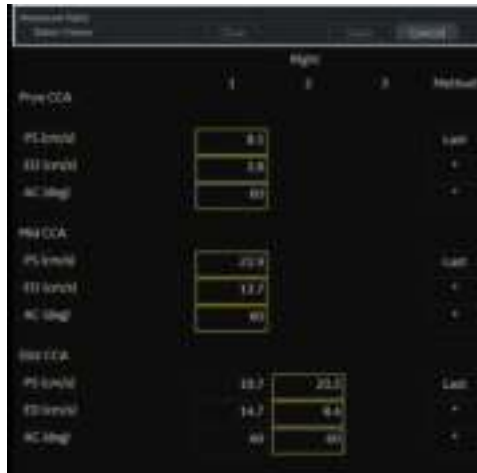

Figure 8-36. Intravessel Pop-up Window

2. Select the first velocity. The value displays in the window. The value is displayed in the window.

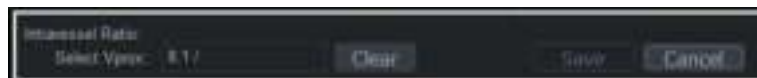

Figure 8-37. Intravessel ratio one



## Intravessel ratio (continued)

3. Select the second velocity.  
The second value and Result value display in the window.

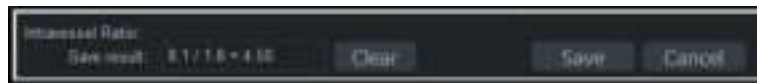

Figure 8-38. Intravessel ratio two

- To save the Intravessel ratio to the Vessel Summary, move the cursor to **Save** and press **Set**.
- To clear values, move the cursor to **Clear** and press **Set**.
- To cancel and exit Intravessel ratio, move the cursor to **Cancel** and press **Set**.

**NOTE:** *Intravessel Ratio is only displayed and saved in the Vessel Summary as Intra-Ratio.*

	Right			Left		
	PS	ES	AC	PS	ES	AC
Prox. CCA	8.1cm/s	1.8cm/s	4.57	11.0cm/s	2.0cm/s	5.50
Mid CCA	20.0cm/s	22.0cm/s	1.10	22.0cm/s	8.0cm/s	2.75
Dist. CCA	25.0cm/s	8.0cm/s	3.13	24.0cm/s	11.0cm/s	2.18
Intra Ratio	4.57					

Figure 8-39. Vessel Summary Example

## Bypass Graft Anastomosis Graph

If there aren't any known Grafts associated with the current exam, you can create a Graft by describing its anastomosis locations and anastomosis modifiers.

**NOTE:** *You can always create another new Graft by selecting one from the "Choose to Add" table, and then modifying it into what you want.*

To graph Bypass Graft anastomosis,

1. Select Bypass Graft on the Touch Panel. The Add/Edit Grafts pop-up appears.

**NOTE:** *This pop-up appears if there are not any known Grafts.*



Figure 8-40. Add/Edit Graft

2. Use the Trackball to assign graft locations on the Add/Edit Grafts pop-up. Press Continue.

**NOTE:** *You can select a Graft by choosing it in the table of Grafts that exist in the current exam.*

**NOTE:** *You can always modify the selected Graft by choosing new anastomosis locations and anastomosis modifiers.*

**NOTE:** *The Stent pop-up is nearly identical to the Graft pop-up, except that you also have the ability to specify the Stent's laterality.*

## Bypass Graft Anastomosis Graph (continued)

- Graft assignments now appear on the Touch Panel: This is saved on the system and can be edited. Specify the Topographic Modifier (location), Stenosis Modifier, and Anatomic Modifier for any measurement you would like to take.

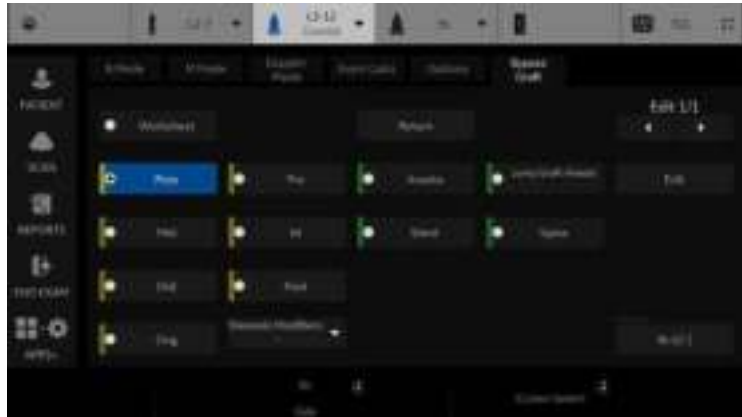

Figure 8-41. Graft table update

**NOTE:** *For each measurement within a blood vessel, you can choose a Topographic Modifier (i.e., location) and a Stenosis Modifier. For Grafts and Stents, you can also choose an Anatomic Modifier (i.e., eye, ankle, or liver).*

- To edit the Bypass Graft Anastomosis, select the “Edit 1/1” toggle on the Touch Panel to specify which of the Grafts you are measuring within.



**Very Important:** When creating Grafts or Stents, it is always recommended to perform the accompanying measurements. The measurements folder can be found in the lower, right-hand portion of the Touch Panel.

## Bypass Graft Anastomosis Graph (continued)

5. On the Doppler Mode M&A Touch Panel, you have the option to select the Stenosis Modifiers, Pre-Steno, At-Steno, or Post-Steno.



Figure 8-42. Select the Stenosis Modifier

## Introduction

Urology measurements offer three different types of measurement studies:

- Generic—Common to all applications. See ‘Generic Measurements’ on *page 7-18 for more information..*
- Urology
- Pelvic Floor. See ‘Pelvic Floor Measurements’ on *page 8-78 for more information.*

**NOTE:** *Bladder(0.7) Vol, Bladder Vol, Post Void Vol, Prostate Vol, Renal Vol, Renal (0.8) Vol and Volume can be displayed on the Touch Panel if preset at the Utility -> Measure screen.*

## Bladder Volume

This calculation uses a standard distance measurement. Length is typically measured in the sagittal plane. Width and height are measured in the axial plane.



Figure 8-43. Bladder Volume Touch Panel

## Renal Volume

This calculation uses a standard distance measurement. Length is typically measured in the sagittal plane. Width and height are measured in the axial plane.

To select the left or right, adjust the **Side** selection.

To measure Renal Volume:

## Prostate Volume

This calculation uses a standard distance measurement. Length is typically measured in the sagittal plane. Width and height are measured in the axial plane.

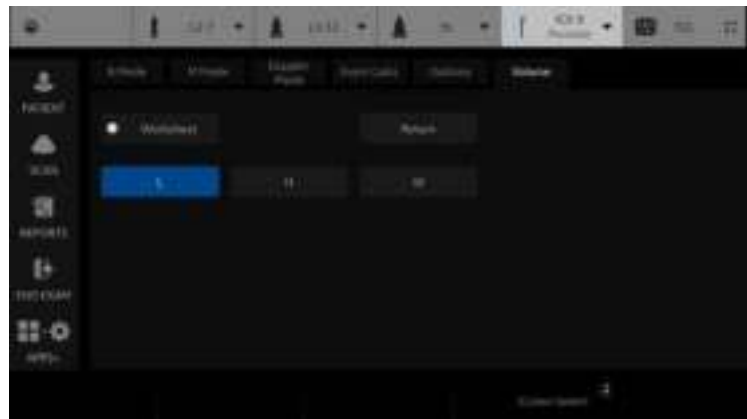

Figure 8-44. Prostate Volume Touch Panel

## Prostate Volume (continued)

### PSA Measurement

If you enter the value of PSA (Prostatic Specific Antigen) and PPSA Coefficient at the Urology Patient screen, PSAD and PPSA are automatically calculated.

The values are displayed on the Worksheet and Report (if set appropriately on the Report Designer page).



Figure 8-45. Urology Patient Screen

 A screenshot of a measurement result window displaying the following data:
 

1	Prostate L	2.88 cm
2	Prostate H	2.86 cm
3	Prostate W	2.15 cm
	Prostate Vol	9.29 ml
	PSAD	0.00
	PPSA(1)	1.12
	PPSA(2)	1.12

Figure 8-46. Measurement result window

PSAD: Prostatic Specific Antigen (PSA) Density – defined as:  
 $PSAD = PSA/Volume$

PPSA: Predicted Prostate Specific Antigen – defined as:  $PPSA = Volume \times PPSA \text{ Coefficient}$

## Pelvic Floor Measurements

Pelvic floor measurements can be performed in the Pelvic Floor study. The measurements are located in the Exam Calc folder in the Urology preset.



Figure 8-47. Pelvic Floor Study Touch Panel

### BN (Bladder Neck) Rest

Obtain an image with the patient at rest (relaxed).

1. Create a straight line (zero or baseline) to line up with the inferior/posterior of symphysis pubis bone.
2. Once the baseline is positioned, a caliper appears. Position the caliper at the anterior margin of the bladder neck. A positive number displays since the caliper is placed below the baseline.
3. A distance is calculated in millimeters.

### BN (Bladder Neck) Stress

Obtain an image after the patient performs the Valsalva maneuver.

1. Create a straight line (zero or baseline) to line up with the inferior/posterior of symphysis pubis bone.
2. Once the baseline is positioned, a caliper appears. Position the caliper at the anterior margin of the bladder neck.

If the bladder neck is below the baseline, the Bladder Neck Stress is a positive number. If the bladder neck is above the baseline (closer to the transducer face), the number is negative.



## Pelvic Floor Measurements (continued)

### BN (Bladder Neck) Descent

The Bladder Neck Descent is a calculation that should be calculated after measuring the Bladder Neck Rest and Bladder Neck Stress.

$BND = \text{Bladder Neck Rest} - \text{Bladder Neck Stress}$

*NOTE: If the Bladder Neck Stress is a negative number, it becomes positive and is added to the bladder neck rest measurement.*

### DWT (Detrusor Wall Thickening)

Three distance measurements of the bladder wall dome are calculated into a mean dimension and displayed in millimeters.

### UT (Uterine) Descent Max

1. Create a straight line (zero or baseline) to line up with the inferior/posterior margin of symphysis pubis bone.
2. Measure using a 2-caliper dimension to the inferior position of the uterus in a stress image and display in millimeters

### Rect Amp Des Max (Rectal Ampulla Descent Max)

1. Create a straight line (zero or baseline) to line up with the inferior/posterior margin of symphysis pubis bone.
2. Measure using a 2-caliper dimension to the inferior position of the rectal ampulla in a stress image and displayed in millimeters

### Rectocele (Depth and Width)

Two 2-caliper diameter measurements to measure depth and width of the rectocele. Displayed in millimeters.

## **Pelvic Floor Measurements (continued)**

### **Lev Hiatt Stress (Levator Hiatus Stress)**

Two 2-caliper diameter measurements and calculate an area displayed as cm squared.

### **Residual Urine**

Two 2-caliper diameter measurements calculate as:

(x) times (y) times 5.9 minus 14.9 equals Residual Volume displayed in ml.

# Pediatrics

## Overview

Pediatrics measurements offer two different types of measurement studies:

- Generic. The Generic Calculations study is common to all applications. See 'Generic Measurements' on *page 7-18 for more information..*
- Pediatric Hip (PedHip).

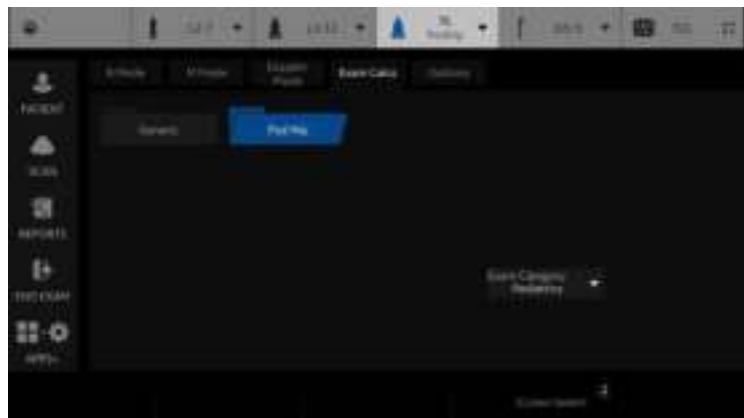

Figure 8-48. Touch Panel - Pediatrics Exam Calcs

## Pediatrics Hip



Figure 8-49. B-Mode Measurement Touch Panel – PedHip

## Hip Dysplasia Measurement

The HIP calculation assists in assessing the development of the infant hip. In this calculation, three straight lines are superimposed on the image and aligned with the anatomical features. The two angles are computed, displayed, and can be used by the physician in making a diagnosis.

The three lines are:<sup>1</sup>

1. The baseline connects the osseous acetabulum convexity to the point where the joint capsule and the perichondrium unite with the iliac bone.
2. The inclination line connects the osseous convexity to labrum acetabulare.
3. The Acetabulum roof line connects the lower edge of the osilium to the osseous convexity.

## Hip Dysplasia Measurement (continued)

The  $\alpha$  (Alpha) angle is the supplement of the angle between 1 and 3. It characterizes the osseous convexity. The  $\beta$  (Beta) angle is the angle between lines 1 and 2. It characterizes the bone supplementing additional roofing by the cartilaginous convexity.

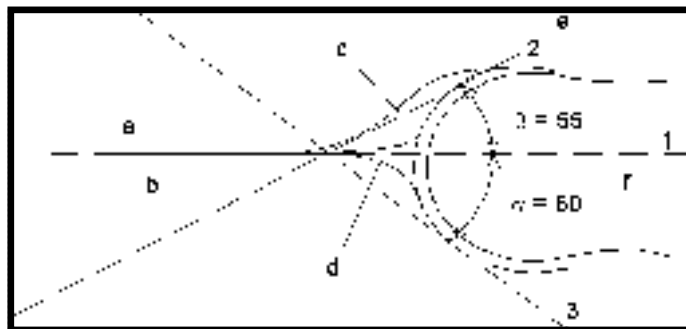

Figure 8-50. Hip Dysplasia

### Anatomical Landmarks

- |               |                                  |
|---------------|----------------------------------|
| a. Ilium      | d. Bony Roof                     |
| b. Iliac Bone | e. Cartilaginous acetabular roof |
| c. Labrum     | f. Femoral Head                  |

<sup>1</sup>Source: R GRAF, Journal of Pediatric Orthopedics, 4: 735-740(1984)

To make a Hip Dysplasia measurement:

1. From the Touch Panel, select either the **right** or **left side** (orientation) and then select **Beta Alpha HIP**.  
A horizontal dotted line displays.
2. To place the baseline, move the **Trackball**. Position the crosshairs edge at the osseous convexity of the ilium.
3. To rotate or change inclination, adjust the **Ellipse** control or **Hip Rotate**.
4. To fix the baseline, press **Set**.  
The system displays a second dotted line at an angle.

## Hip Dysplasia Measurement (continued)

5. To place the line along the inclination line of the osseous convexity to labrum acetabulare, move the **Trackball**.
6. To rotate or change inclination, adjust the **Ellipse** control or **Hip Rotate**.
7. To fix the second measurement line, press **Set**.  
The system displays a third dotted line at an angle.
8. To place the caliper along the acetabular roof line, move the **Trackball**.
9. To rotate or change inclination, adjust the **Ellipse** control or **Hip Rotate**.
10. To fix the third measurement line and complete measurement, press **Set**.

The system displays the hip measurements ( $\alpha$  and  $\beta$ ) in the Results Window.

## Alpha HIP

The Alpha HIP measurement measures the angle between the iliac baseline and the bony roof line. To make an Alpha HIP measurement:

1. From the Touch Panel, select either the **right** or **left side** (orientation) and then select **Alpha HIP**.  
A horizontal dotted line displays.
2. To place the baseline, move the **Trackball**. Position the crosshairs edge at the osseous convexity of the ilium.
3. To rotate or change inclination, adjust the **Ellipse** control or **Hip Rotate**.
4. To fix the baseline, press **Set**.  
The system displays a second dotted line at an angle.
5. To place the caliper along the acetabular roof line, move the **Trackball**.
6. To rotate or change inclination, adjust the **Ellipse** control or **Hip Rotate**.
7. To fix the second measurement line, press **Set**.

The system displays the alpha hip measurement ( $\alpha$ ) in the Results Window.

## d:D Ratio Measurement

The d:D Ratio measurement measures the percentage of the femoral head coverage under the bony roof. To make this measurement:

1. From the Touch Panel, select either the **right** or **left side** (orientation) and then select **d:D Ratio**.  
A horizontal dotted line displays.
2. Use the **Trackball** to place the baseline along the ilium. Position the crosshairs edge at the osseous convexity of the ilium.
3. Use the **Ellipse** control to adjust or change inclination or **Hip Rotate**.
4. Press **Set** to fix the baseline.
5. The system displays a circle representing the femoral head. Use the **Trackball** to position the circle.
6. Use the **Ellipse** control to size the femoral head circumference.
7. Press **Set** to fix the femoral head circumference.

The system displays the d:D ratio for the femoral head in the Results Window.





---

## *Chapter 9*

# Recording images

*Describes how to record images.*

# Getting Set Up to Record Images

## Overview

A typical workflow for connectivity might be as follows (this setup varies by each user setup):

1. Select the dataflow, worklist for example.
2. Start a new exam. Select the patient.
3. Perform the patient scan.
4. Store images as multi-frame CINE Loops and Raw DICOM data via the **P1** key.
5. Store secondary capture for DICOM print via **P2** key.
6. Store images to the color printer or B/W printer via **P3** key.
7. Check the DICOM Job Spooler via **F4** to verify delivery.
8. End the exam.
9. Permanently store images via the Patient menu to permanent storage.

During an examination, the operator stores data, images and cineloops for immediate purposes. The LOGIQ Totus includes an integrated patient archiving system for data and image storage.

The LOGIQ Totus enables also storing of data and images to external databases (removable media).

## Overview (continued)

Dataflow combines archive, data, DICOM, and onboard records into one coherent workflow. Destination devices are configured and assigned to the print keys. You select the appropriate dataflow (Portable, etc.) according to your requirements. You manage the patient database (local, shared, or via a worklist broker).

- DO NOT use the internal hard drive for long-term image storage. Daily backup is recommended. External storage media is recommended for image archive.

*NOTE: DICOM images are stored to external media storage devices separately from patient data, which also needs to be backed up to a dedicated database-formatted external storage media.*

- If working off-line with a dataflow pointing to a DICOM server, the images stored during the examination may have to be manually resent in the DICOM spooler when reconnecting the unit. Resend all jobs that failed or are on hold.

In addition, stored images and cineloops can be saved to a removable media in the standard formats JPEG, WMV, and DICOM.

- You need to set up a process for locating images stored to external storage media for easy recall
- GE HealthCare **IS NOT** responsible for lost data if you do not follow suggested back-up procedures. GE HealthCare **WILL NOT** aid in the recovery of lost data.

Refer to the Customizing Your System chapter for instructions on setting up your system's connectivity.

## Image Management Guide

### Save As to View on any PC

Use this to save images in a computer-friendly format so you can view it on any PC.

### EZBackup Images to Archive

Use this to take images off your Ultrasound system onto removable media for long-term archive. This is the way to free up hard disk space, rather than deleting images.

### Export/Import Data/Images Between Systems

Use this to copy both patient data and images for specified patient(s) from one system to another.

## Media Requirements

The system **ONLY** supports medical grade USB Hard Disk Drive and USB Flash Drive.

## Media Handling Tips

To eject the media, always press **F3**. **DO NOT** press the eject button on the drive:

1. Press **F3**. The Eject device menu is displayed.
2. Select the relevant media.
3. Select USB Drive from the pull-down menu to disconnect the USB Drive. Disconnect the USB drive after the success dialogue is displayed.

Remove the USB Drive from the USB port.

**NOTE:** *If the unsuccessful dialogue is displayed, retry after a while.*

**NOTE:** *Verify is NOT available on Flash Drive or Hard Disk Drive media.*

## **Adding Devices**

To add a destination device (printer, worklist server, etc.) to this system, see 'MyComputer Device Page' on *page 10-72*.

To verify a DICOM device, see 'Dicom Page' on *page 10-81*.

## **Adding a Dataflow**

To add a new dataflow to this system, see 'Dataflow Page' on *page 10-119*.

## **Adding Devices to a Print Button**

To add devices/dataflows to a print button, see 'Print Button Page' on *page 10-116*.

# Storing Images and Cineloops

Images and cineloops that are stored during a current examination are displayed as thumbnails on the clipboard.

When an image is stored, all the additional information that is displayed is saved with it (i.e. probe and application selected, image setting, annotations or measurements).

See Dataflow in Connectivity for detailed settings related storing image/Cine.

Image archive is set by the dataflow selected (See Dataflow in Connectivity for more information.)

When you want to print/store an image, P1 is most commonly used for the primary destination and internal hard drive.

## Storing an image

To store an image,

1. While scanning, press **Freeze**.
2. Scroll through the cine Loop and select the desired image.
3. Press the appropriate Print key.

The selected image is stored (per your preset instructions) and a thumbnail is displayed on the clipboard.

**NOTE:** *LOGIQ Totus numbers the images which are saved in the Local Archive (Instance Number). But Instance Number may change or get duplicated when adding/deleting images to the exam. So for identification, the recommendation is to use Content Date/Content Time on the DICOM server instead of Instance Number.*

## Storing a cine loop

A Cine loop is a sequence of images recorded over a certain time frame. The stored cine Loops are displayed chronologically on the clipboard.

Cine loops can be stored at any time during scanning. You can choose to preview the cine loop before storage and save the cine loop directly, as described below.

The system can be configured to perform either

- Prospective clip: The system begins storing Cine from when you press the Print button, based on the Time Span setting.
- Retrospective clip: The system stores Cine predetermined time before you press the Print button, based on the Time Span setting.

Refer to 'Retrospective Cine/Prospective Cine' on *page 9-9* about the setting.

**NOTE:** *LOGIQ Totus numbers the images which are saved in the Local Archive (Instance Number). But Instance Number may change or get duplicated when adding/deleting images to the exam. So for identification, the recommendation is to use Content Date/Content Time on the DICOM server instead of Instance Number.*

## Previewing and Storing a CINE Loop

1. While scanning, press **Freeze**.
2. Move the Trackball to activate Cine.
3. Use the trackball or **Frame by Frame** to scroll through the acquisition and find the sequence of interest.
4. Press **Start Frame** or **End Frame** to set the corresponding cineloop boundary to the current frame as necessary.  
Rotate **Start Frame** and **End Frame** to trim or expand the cineloop boundaries.
5. Press **Run/Stop** to run the cineloop and then press the print key to store the cineloop.  
Cine loops stored on the clipboard are indicated with a movie strip icon.
6. Press **Run/Stop** again to stop the cine loop.
7. Press **Freeze** to return to live scanning.

Depending on whether the system has been configured to enable or disable "Preview Loop before store" (see 'Print Controls' on page 10-58), the following procedures enable the cine loop to be stored directly.

### Storing a cine loop without Preview

If “Preview Loop before store” is disabled,

1. While scanning, press the appropriate print key.
2. The last valid cine loop is stored in the archive and a movie clip thumbnail is displayed on the clipboard.
3. Scanning resumes immediately.

### Storing a cine loop with Preview

If “Preview Loop before store” is enabled,

1. While scanning, press the appropriate print key.
2. The last valid cine loop is previewed.
3. Adjust the cine loop, as necessary.
4. Press the appropriate print key.

The movie clip thumbnail is displayed on the clipboard.

### Preview

Loop Preview can now be enabled independently for Time-Based Store, ECG-Based Store, and Mark CINE. This is useful for setting preview preferences based on the application.

*NOTE: The Contrast Time Span setting overrides the Time Span when in Contrast Mode.*



## Retrospective Cine/Prospective Cine



Figure 9-1. Print Control

### Retrospective CINE

When you select to store a Cine loop retrospectively, the system stores cine for a specified time before you press the Print Button.

1. Set Live Store P1 - P4 to "Retrospective Clip" via Utility -> Application -> Print controls.
2. Specify the recording time in Time-Based Store or ECG-Based Store.
3. Press **Save**.

**NOTE:** *A Print button can be configured to store a Single Image during Retrospective Cine, without stopping the Cine loop.*

### Prospective CINE

When you select to store a cine loop prospectively, the system begins storing cine from when you press the Print button.

1. Set Live Store P1 - P4 to "Prospective Clip".
2. Specify the recording time in Time-Based Store or ECG-Based Store.
3. Press **Save**.

**NOTE:** *A Print button can be configured to store a Single Image during Prospective Cine, without stopping the Cine loop.*

**NOTE:** *The CINE gauge turns green when a Prospective CINE Clip is pending.*

**NOTE:** *You can cancel Prospective Store by pressing Freeze/Unfreeze or by changing Modes.*

# Review images in archive

There are two ways to access to archived images:

- Review the images from a selected examination.
- Select images from the Active Image screen displaying all the images sorted by examination for the actual patient record.

## Review the patient exam/image

To review the patient exam,

1. Move the cursor to the patient in the Patient View and double-click. Exam View displays.

or

Move the cursor to the patient and select Exam View tab or **Review**. Exam View Displays.

2. Move the cursor to the desired exam and double-click.
3. Active Images screen displays. Move the cursor to the image and double click or press **Review**.
4. The review screen displays. Select the image from clipboard.

*NOTE:* See 'Clipboard' on page 9-21 for more information.

## Active Images

Active Images displays the images of the exam.

**NOTE:** *CINE loops are not played interactively as you view the active images on the Patient screen.*



Figure 9-2. Active Images Screen

1. Select the exam which includes the image to review.
2. Select **Active Images**.
3. Select the image and press **Review** or double click on the image. The image is displayed.

If you select 2 - 4 images and select **Review**, the archived images are displayed in the split screen.

**NOTE:** *If the size of an image is larger than 2GB, the image does not display on the Active Image screen. Take care when you scan a long CINE Loop, such as in Contrast.*

## Active Images (continued)

Table 9-1: Active Images

Parameters	Description
Delete Images Delete Selected Images/ Delete All Temp. Images	To delete selected images, select the image in the active screen, then select <b>“Delete”</b> on the monitor display or <b>“Delete Selected Images”</b> on the Touch Panel. To delete all images, select the image, then select <b>“Delete All Temp. Images”</b> on the Touch Panel.
Permanent Store	Select the images which you want save to the Local hard disk drive.
Standard Print	To print an image, 1. Select the image you want to print from the Active Images screen. You can print one (1) image per sheet or 2x3 images per sheet. 2. Press <b>Standard Print</b> . NOTE: If the printer is not assigned to the button, you will get a message telling you to Check Printer Button Configuration. NOTE: There is no warning to let you know that the printer is not functioning. Check the printer. You need to configure the printer to the Standard Print button via <b>Utility --&gt; Connectivity --&gt; Button</b> .
SaveAs Images	Refer to ‘SaveAs’ Images’ on <i>page 9-28</i> for the detail. You can select the multiple images collectively in Active Image screen which you want save by SaveAs. NOTE: We suggest that you save the images page by page with ‘SaveAs’ Images in Active Images. It takes time if you have many images or raw data.
Select Images/Select All Unselect All	<ul style="list-style-type: none"> <li>• To select one or multiple image, place the cursor on the image and press Set.</li> <li>• To select all images, press Select all on the Touch Panel.</li> <li>• To deselect images, press Deselect all on the Touch Panel.</li> </ul>
Send To	Note: “Send To” button is not displayed in Active Images menu and the Touch Panel if the patient is not selected.

## Analyzing Images

To analyze the archived images, select the image, then select **Review**. The archived images is displayed with the date and time of archival.

To compare the analyzed image to a live image, press **L/R**. Now both the archived and live images appear on the monitor display. Unfreeze the live image area.

## Image Tags

Image Tag buttons included on the Active Images Touch Panel screen can be used to tag or untag selected images. There are three Image Tag options :

- Red mark
- Green mark
- Yellow mark

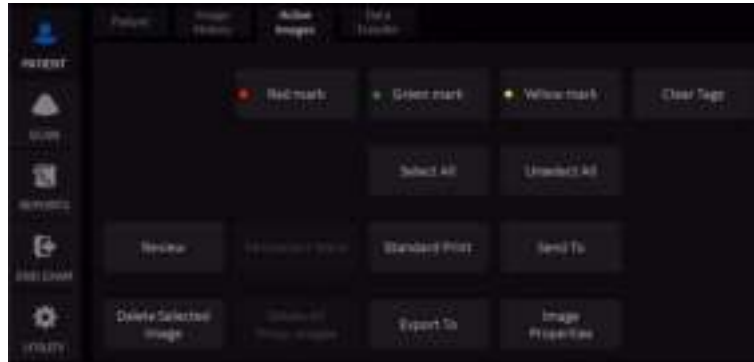

Figure 9-3. Active Images Touch Panel Screen

## Tagging Recalled Images

When recalling an image, the “Tags” tab displays.

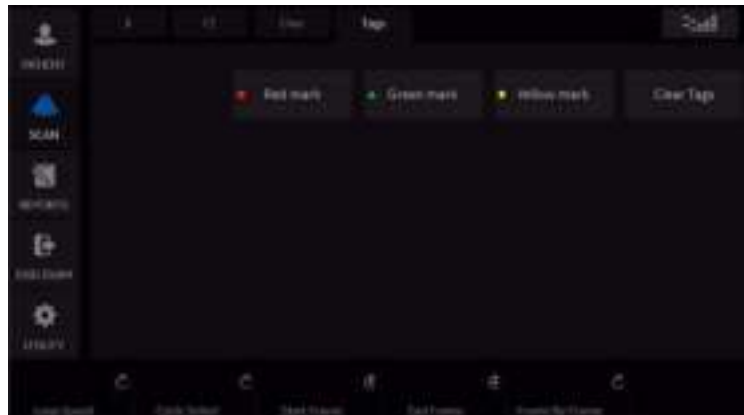

Figure 9-4. Touch Panel Screen

## Tag Icons on Image Clipboards

All image clipboards display the image tag icons on the image thumbnails.



Figure 9-5. Active Images Screen Clipboard

## Patient View/Exam View Tags Column

Image Tags icons are also displayed in a “Tags” column in the Patient View and Exam View screens. The “Tags” column can also be sorted by tags by clicking the “Tags” column heading.



Figure 9-6. Patient View Tags Column

## Patient Search by Tags

A patient search can be performed using Tags as a Search key



Figure 9-7. Tag Based Search

## Image Tag Presets

Image Tag preset configurations are available on the Utility > System > System Display screen. A custom label can be entered for each tag icon, which will be displayed as the button label.

Tags can be set for a specific Print button and the tags are applied automatically on the images saved with that Print button. The ultrasound system provides the option to show/hide the Tagging option for recalled images.



Figure 9-8. Image Tag Presets

Image Tag options are as listed below.

Table 9-2: Image Tags Presets

Preset Parameter	Description
Image Tag Labels	Edit the text to create custom labels for each image tag.
Image Tagging on Print buttons	Print buttons Assign Image Tagging on Print buttons.
Image Tag Options	Enable Image Tags when recalling images.



## Tagged Image Export

Images can be exported based on selected tags from the Patient View and Exam View screens.

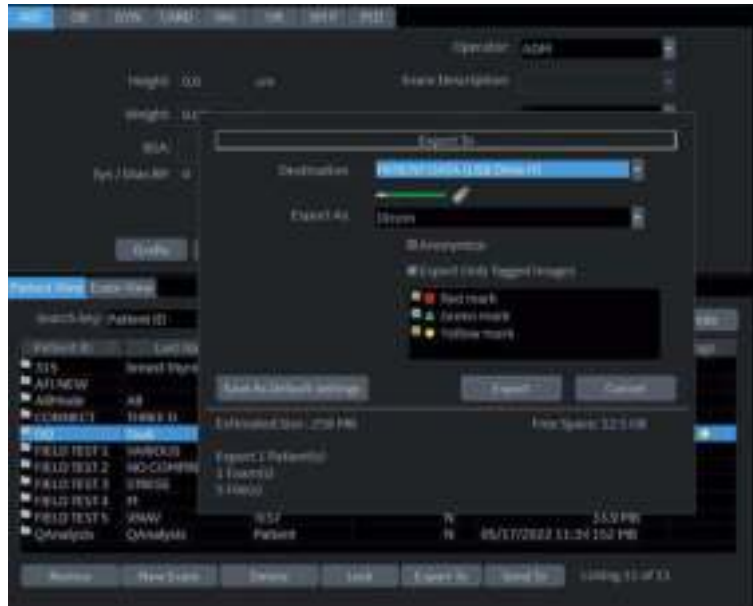

Figure 9-9. Export Tagged Images

## Image Reorder

To reorder the sequence of the images displayed on the Active Images screen:

1. Select Image Reorder on the left side of the screen.
2. Select the image(s) you wish to move with the left and right trackball buttons.



Figure 9-10. Select Image(s)

3. There are three ways you can freeze the selection and toggle from Choose to Move mode:
  - Press the top trackball button
  - Double-click the left or right trackball button
  - Drag and drop by holding the left or right trackball button

## Image Reorder (continued)

4. Move the placement cursor with the trackball to the position you want to move the images to.



Figure 9-11. Move/Paste Image(s)

5. Press the top trackball button to paste the image(s) in the new location. After pasting, the system switches from Move mode to Choose mode.
6. Select Save Reorder to save the new image order, Reset Reorder to return to the original order, or Exit Reorder to return to the Active Images screen.

## Image History

Image History displays the images of each exam in chronological order of the patient.

1. Select the patient.
2. Select **Image History**.
3. Select the appropriate button which shows the old exam by date and storage location. 'Active Exam' is displayed on the button.



Figure 9-12. Image History Screen

4. Move the cursor to the required image for review.
5. Select **Review**. The selected image (maximum of 4 images) is displayed.

If the image data is saved on a disk and you do not insert the disk when displaying the Image History page, a triangle icon displays instead of a thumbnail.

Place the cursor on the icon. The disk name displays under the preview window. Insert the appropriate disk.

- Name of the disk displayed under the preview window
- Raw data B-Mode image appears in gray.
- Raw data Color image appears in color
- Image which does not have raw data (screen capture image) appears with a question mark.

## Viewing two different studies from the same patient

To view images side-by-side from two different studies on the same patient,

1. Select the patient.
2. Go to the Image History page.
3. Select the first image.
4. Select the next image from the other exam.
5. Press **Review**.

---

# Clipboard

The clipboard displays thumbnail images of the acquired data for the current exam. Images from other exams are not displayed on the current patient's clipboard.

**NOTE:** *If you have unsaved images in the clipboard and change the exam, the dialogue "You have unstored images. They will be saved to your current exam" displays. The unsaved images are saved to the current exam.*

All of the images can be viewed in the Active Images screen or in the Image History screen, available from the display or from the Patient menu.

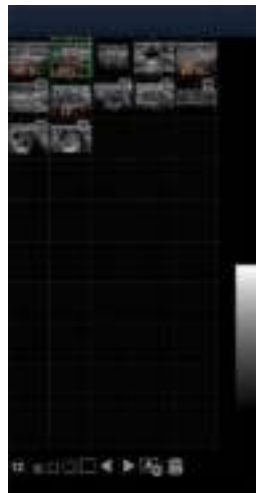

Figure 9-13. Clipboard example

## Clipboard icon



Figure 9-14. Side clipboard icon

1. Number of Images in Exam  
The number of images in an exam is tracked on the bottom of these Monitor Display Controls.
2. Thumbnail Size  
Place the cursor on one of the Thumbnail size box icons and press Set.
3. Prev/Next Image
4. Save As
5. Delete recalled image / Delete last image

## Saving the image /cine to the Clipboard

The active image/cine is stored and placed on the clipboard when you press the print key (this assumes that you have already set up a print key to do this). The clipboard contains preview images with enough resolution to clearly indicate the contents of the image. CINE Loops are indicated by a movie clip icon.

The clipboard fills from left to right, starting in the left-hand corner. Once the top row is full, the second row starts to fill. Once both rows are full, the next image stored starts to fill a 'third' row (the first row disappears from the clipboard display, with the second row now becoming the first row, and the third row now becoming the second row).

## Previewing Clipboard Images

1. Select the Pointer key to obtain a cursor arrow.
2. Move the **Trackball** to position the pointer over the clipboard image you want to recall.
3. An enlarged preview of the image is displayed on the left-hand side of the monitor.

## Recalling Images from the Clipboard

To recall images from the clipboard,

1. Select the Pointer key to obtain a cursor arrow.
2. Move the **Trackball** to position the pointer over the clipboard image you want to recall.
3. Press **Set** to recall the image.
4. Press the left/right arrow of Menu icon to move to the previous/next image.

## To delete an image from the clipboard

1. If in images live, press **Freeze**.
2. Select the **Pointer** key to obtain a cursor arrow.
3. Place the cursor on the clipboard image you want to delete, then press **Set** to select the image.
4. Place the cursor on the Delete icon and press **Set**.  
A warning message is displayed asking the user to confirm the action to perform.
5. Select **Yes**.

## Overview

Images and cineloops can be saved to a removable media storage to View on a **Windows PC** in the following standard formats:

- Still images: JPEG, DICOM and RawDICOM (Raw data + DICOM)
- Cineloops: WMV, DICOM and RawDICOM (Raw data + DICOM)

## SaveAs

To save images to the media:

1. Insert the media into the drive or connect the USB drive to the system.
2. On the scan screen, press the left **Set** key. The arrow cursor displays.
3. Place the cursor on the image or CINE Loop in the clipboard to be saved and press **Set**. The image displays on the screen.
4. Select **SaveAs** in the lower, right-hand corner of the screen. The Save As menu appears.

*NOTE: If you have not formatted the media, the media will be formatted when you select Save As.*

*NOTE: If you save the image as an .WMV file, run the CINE Loop before you select SaveAs.*

*NOTE: You cannot save a 2D cineloop image as a .jpeg file.*



## SaveAs (continued)

5. Select the media from the Save in Archive pull-down menu.
6. Folder name: You can create the folder for the saved file.
  - Default is blank (The folder is not created)
  - Max 32 characters

**NOTE:** *You cannot edit the folder name when the folder is opened.*

7. File Name: The name of the file is automatically filled in, but you can type a file name as well.
  - Max 64 characters

**NOTE:** *DO NOT use the following special characters when saving images: !, @, #, \$, %, ^, &, \*, (, ), |, :, ;, <, >, ?, /, ~, [, ], {, }, and Yen sign.*

8. Store: Select Image only or Secondary capture.
  - Image only: Saves only the ultrasound image area
  - Secondary capture: Saves the ultrasound image area, title bar, and scan information area. Not available for DICOM or RawDICOM images.

**NOTE:** *If you select "WMV" for Save as type, Secondary capture is disabled.*

9. Compression: Specify Compression.
  - None
  - Rle
  - Jpeg
  - Jpeg2000
  - Lossless-Jpeg

**NOTE:** *If you select "WMV" for Save as type, Compression is disabled.*

10. Quality: Specify image quality (between 10-100). A high quality setting gives a lower compression.

**NOTE:** *If you select "WMV" for Save as type, Quality is disabled.*

## SaveAs (continued)

11. Save as type: Select one of the following.
- RawDICOM: saves the still image or CINE Loop in both GE HealthCare raw format and DICOM format.
  - DICOM: saves the still image or CINE Loop in pure DICOM format.
  - WMV: Saves the CINE Loop in WMV(Windows Media Video) format.

*NOTE:* Store "Image Only" is available if you select WMV for Type.

*NOTE:* WMV type is only available with CINE loop image.

- JPEG: Saves the still image in jpeg format.
- JPEG2000: Saves the still image in jpeg2000 format.

*NOTE:* The Save button is disabled when you select "AllFiles". Select each Save as type when you want to save data.

If you want to see all data saved onto the local drive, select "AllFiles(\*)". All the data names display in the window.

12. For images transferring to USB, press **Save**.

The images are saved directly to the USB drives storage whenever you press Save.

- If free space of the destination is not enough to save all selected images, then warning dialog appears.
- If the same file name exists in the destination, the warning dialog displays.

**OK:** Overwrite file and continue to save selected images.

**Cancel:** Cancel.

**SaveAs (continued)**

*NOTE: The Report Save As feature is somewhat different. As soon as you select to save a report, the report is saved.*

*NOTE: If you save 3D image as an WMV file, an annotation text "COMP" appears at the top of the saved image which represents the compressed image.*

*NOTE: Time line image can be saved as multi frames image with SaveAs.*

Table 9-3: Save As Formats

	<b>.wmv format</b>
B, B+CF	Multi frames
B+Doppler	Multi frames
B+M	Multi frames
3D	N/A

*NOTE: Verify the saved image works correctly on the Windows PC. If the image does not work, please save it again on the LOGIQ Totus.*

### 'SaveAs' Images

You can select multiple images to save at one time by selecting '**SaveAs**' in the Active Image screen.

Features are almost the same as the SaveAs feature. See 'Save As' on page 9-24 for more information.

**NOTE:** *We suggest that you save the images page by page with '**SaveAs**' Images in Active Images. It takes time if you have many images or raw data.*

**NOTE:** *If the image has a filmstrip icon, this indicates a CINE Loop, which gets saved as a .wmv file; single images are saved as a jpeg file.*

**NOTE:** *'SaveAs' Images function doesn't support images which are query/retrieved.*

1. In the Active Images screen, place the cursor on the image or CINE Loop to be saved and press **Set**. You can select multi images with multi pages.
2. Press '**SaveAs**' **Images** on the monitor display or the Touch Panel. The SaveAs menu appears.
3. Ensure that Jpeg&WMV is selected, then press Save.

### Storing Images with More Resolution

To store images with more resolution than is available with the JPEG selection, select Save As and select WMV as the Save As Type. You can save single images as .WMV files.

Table 9-4: Store Options

Image Type	Store as Image Only	Store as Secondary Capture
CINE Loop	Gives you a loop of just the image (no title bar and scan information).	Gives you a single image of the video area. DO NOT DO THIS BECAUSE YOU DO NOT KNOW WHICH IMAGE FROM THE LOOP THAT YOU ARE GETTING.
Still Image	Gives you a single image (no title bar and scan information).	Gives you a single image of the video area.

# Unified Background Export

## Export from Patient Screen

1. Export exams from the Exam List on the Patient screen by selecting **Export To**.



Figure 9-15. Patient Exam List

- Selected exams can be exported as DICOM or MediaFileType formats (WMFV, JPEG, etc). (DICOM is the default format.) If Export Only Tagged Images is selected the Tags will be displayed to select.



Figure 9-16. Export Dialogue with Tags

After selecting “Export” a message box appears with Anonymize Patient information. Select “OK” on the popup to proceed and select “OK” for the desired Anonymization to submit the exams to spooler for background export.

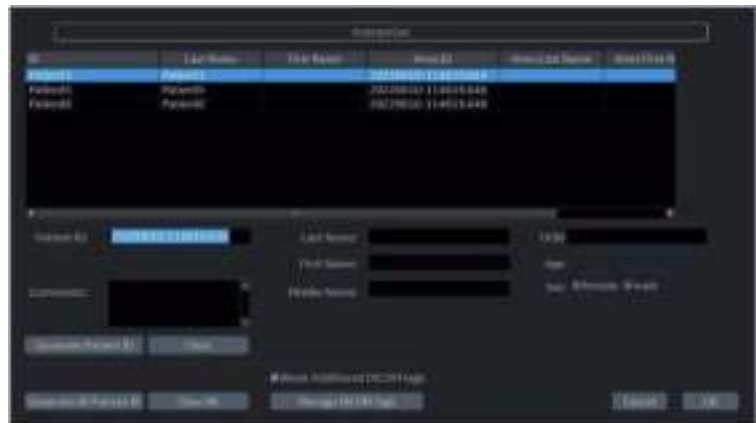

Figure 9-17. Anonymization

**NOTE:** *If the export Patient ID already exists, a prompt will appear to confirm that existing exam information may be overwritten.*

3. After submitting the job to the spooler, a message box displays the background job submission status.



Figure 9-18. Background Export Submission Status

## Export from Active Image Screen

1. Export images from the Active Images screen by selecting the images and selecting **Export To** from the menu. Images can be exported as DICOM or MediaFileType formats (WMFV, JPEG, etc). (MediaFileType is the default format.)



Figure 9-19. Active Image Export

2. After submitting the job to the spooler, a message box displays the background job submission status.

## Spooler Screen

Launch the spooler by pressing the F4 key on the keyboard or by clicking the status bar media icon. The status bar media icon updates based upon the status of the media spooler. The DICOM spooler is accessed on the **Network Jobs** tab and the Media spooler on the **Media Jobs** tab.



Figure 9-20. Spooler Screen



For failed spooler jobs, the error description and recommendations are displayed. **The Retry** and **Transfer To...** selections are be enabled based upon the nature of the error.



## Spooler Status Icons

The Media spooler status updates with the media icons, displayed in the status bar.

Table 9-5: Media Spooler Status

Icon	Spooler Status
	Export to USB media is active.
	Failed export jobs to USB in the spooler.

If media is ejected while an active job is saving to that media, a warning message displays.

On system Shutdown, if any export is active a shutdown confirmation dialogue displays. The shutdown can be cancelled, the spooler status can be checked, or the shutdown can be continued. If the shutdown is continued, ongoing and pending spooler jobs are suspended.

**NOTE:** *The suspended jobs will not be auto resumed when the system is powered on again.*

# DICOM Viewer

This feature enables the export of a self-contained DICOM viewer to removable media, along with the transfer of selected images.

*NOTE: The exported DICOM Viewer software is a GE HealthCare developed DICOM Viewer. It is standalone software to display ultrasound images exported from GE HealthCare LOGIQ Ultrasound systems.*

*NOTE: This viewer is NOT intended to be a diagnostic tool. It is only meant to be used for reference.*

## Installing the DICOM Viewer

DICOM Viewer allows the user to transfer examinations to DICOM removable media together with the DICOM Viewer. To install :

1. Place the media in any Windows PC. Open the media and click the DicomViewer.exe file to install the DICOM Viewer.

*NOTE: Minimal Windows PC requirements are Windows 10/ Windows 11.*

2. The License Agreement appears. Select I Agree.



Figure 9-21. License Agreement

3. The DICOM Viewer is displayed.



Figure 9-22. DICOM Viewer

### Configuring the DICOM Viewer

The user can configure the embedding of the DICOM viewer on the media on the Export To screen.

1. Export exams from the Exam List on the Patient screen by selecting Export
2. Check Add DICOM Viewer to Media. The DICOM Viewer will be exported when transferring examinations to the corresponding DICOM removable media.



Figure 9-23. Add DICOM Viewer to Media



Figure 9-24. Create Local Copy

# Data Transfer

## Overview

The user can select and access the Exam Transfer services from the Exam Data Transfer screen.

- Import
- Export
- Worklist
- Q/R (Query/Retrieve)

**NOTE:** *Ensure that all patients are exported or backed up BEFORE deleting them.*

## Export/Import

To move exams from one Ultrasound system to another system or to back up/retrieve exam information, you need to export/import exam information.

**NOTE:** *Both database information and images are exported. No data is deleted from the local archive when exporting data.*

**NOTE:** *Export/Import patient records may take more than ten (10) minutes. Please allow sufficient time to export/import patients.*

**NOTE:** *You MUST verify the media you use BEFORE performing Export/Import. You must do this once each session. If you encounter problems, eject the media and then re-insert the media; then try the Export/Import again.*

**NOTE:** *If you try exporting a previously backed-up exam, the message "Can't Find Source file" displays. The image data has already been removed from the hard disk drive with EZBackup.*

**NOTE:** *It is STRONGLY recommended that you verify files on Eject when using Export.*

## Importing Data

To import an exam(s) to another Ultrasound system:

1. At the other Ultrasound system, insert the media.
2. Press **Patient** and select **Data Transfer**.
3. The Data Transfer screen displays. Press Import.
4. Select the media from the Transfer From pull-down menu.
5. The Transfer From search field shows the patients available for import from the removable media you just loaded onto the system.
6. Select the patient(s) or the exam(s) from the list to be imported.
7. Press Transfer. The progress bar displays during the transfer.
8. Please wait for the patient information to be copied to this Ultrasound system. Informational messages appear while the import is taking place.
9. Press **F3** to eject the media.

*NOTE: Use Import to restore EZBacked up and images.*

*NOTE: You can retrieve from the media to the local drive, playback, or process exam information on the system as Raw Data.*

## DICOM Import

You can import the graphics which has DICOM DIR from USB.



### CAUTION

If the following message displays, there is a possibility that Import may not work properly (“Data detected is not LOGIQ Totus. Measurements and RawData will not transfer.”).

## **Worklist (Search and retrieve the Patient/Exam information)**

*NOTE: Before you retrieve data from the Worklist server, make sure that default IP address is input in the Default Gateway field in Utility -> Connectivity -> TCP/IP.*

*NOTE: You need to select the patient prior to sending images to a PACS.*

1. Press **Patient** and select **Data Transfer**. The Data Transfer screen displays.
2. Select Worklist. The patient/exam list in the Local Archive displays in the Transfer To section.

*NOTE: Only "Local Archive - Int.HD" is enabled for Transfer To.*

3. The Worklist used last time is displayed on the monitor display. Press Refresh to refresh the list or select another Worklist server from the Transfer From pull-down menu.

*NOTE: The worklist server is configured in the Utility screen. Multiple servers are able to be configured.*

*NOTE: You can configure whether the auto-refresh worklist has been enabled/disabled in the Utility screen. The system automatically refreshes the list when the exam data transfer accesses the Worklist server or changes the Worklist server.*

4. Select the patient(s) or the exam(s) from the list.
5. Press Transfer. The progress bar displays during the transfer.

# External drives

## Intended Use

Removable media can be used for the following purposes:

- Backup of patient database and system configuration presets (see 'System Backup and Restore Preset Menu' on page 10-20)
- Export to copy a set of patient records to a third party DICOM review station.
- Copy of system configuration presets between to units using the Backup/Restore feature (see 'Preset Synchronization Using Media' on page 10-193).
- SaveAs: Save images as JPEG, WMV, DICOM and RawDICOM for review on a standard Windows computer.
- Privacy and Security Encryption. See Chapter 12 for more information.

## Supported removable media

The following removable media are supported:

- USB Flash Drive
- USB external hard disk drive

No matter which media is used, it is always highly recommended to make a backup of the media, which is the responsibility of the customer.



### HINTS

Keeping your media disc in an original media case or caddy all the time will prevent it from becoming dirty or damaged.

## USB Hard Disk Drive and USB Flash Drive

### Cautions and Warnings



**WARNING**

Before removing the USB drive from the USB port, press Eject (F3) and select USB Drive from the pull-down menu. Disconnect the USB drive after the success dialogue is displayed. If the unsuccessful dialogue is displayed, retry after a while. Failure to follow these instructions could result in loss of patient data.



**WARNING**

If a problem occurs while exporting to the USB-HDD, such as a crash, the export may not have completed. Try again with a smaller number of patients.



**WARNING**

DO NOT use “Select All” when you export the patient data to the USB-HDD.

**NOTE:** *Connect USB Flash Drives and Hard Disk Drives to the USB ports located on the Touch Panel (USB 3.0). Connect peripheral devices to the USB ports located at the rear of the system. (USB3.0).*

**NOTE:** *Do not insert USB Memory devices (hard drives or flash drives) that contain multiple partitions into the scanner. Use single partitioned USB Drives.*

**NOTE:** *Some USB memory device manufacturers allow for executable partitions or ship pre-formatted new USB memory devices with multiple partitions pre-configured. BEFORE inserting any memory device into the scanner, insert it into a PC or MAC to verify that there is only a single partition. If multiple partitions exist, contact the USB manufacturer for the steps in reformatting the memory to a single partition.*



## USB Ports



### CAUTION

Non-supported peripheral devices that use their own AC power source **CANNOT** be attached to the LOGIQ Totus. **DO NOT** connect the peripheral device's power cord into the LOGIQ Totus system. Only peripheral devices purchased from GE HealthCare with the purpose of being used with the LOGIQ Totus system should be used.

Use a USB printer cable that is less than 3 meters in length.

Failure to follow these instructions could lead to unexpected diagnostic performance.

## System USB Ports

### Side of Monitor

The two Monitor USB 2.0 Ports **SHOULD ONLY BE USED** for Bus-powered USB Hard Disk Drives and USB Flash Drives. The following configurations can be used:

- One or two USB Flash Drives
- One Flash Drive and One Bus-powered Hard Disk Drive
- One Bus-powered Hard Disk Drive



### CAUTION

**DO NOT** plug in **TWO** Bus-powered Hard Disk Drives at the same time.

### Operator Panel and Rear of System

The two USB 3.0 ports on the Touch Panel and at the back of the system SHOULD ONLY BE USED for the following devices:

- Color or Report Printer

*NOTE: When connecting an external printer to the LOGIQ Totus via the USB port on the back of the system, you MUST ensure that the power supplied to the printer is fed from the same power feed as the LOGIQ Totus. This assures compliance to leakage currents.*

- Footswitch
- PC Printer with isolation USB
- USB Storage (USB-HDD and USB Flash Device)

### Ejecting a USB Flash Drive/USB HDD

1. To eject a removable media, always press **F3**.
2. The Eject device menu is displayed. Select the relevant media.
3. Select USB Drive from the pull-down menu to disconnect the USB Drive. Disconnect the USB drive after the success dialogue is displayed.

Remove the USB Drive from the USB port.

*NOTE: If the unsuccessful dialogue is displayed, retry after a while.*

*NOTE: Verify is NOT available on Flash Drives or Hard Disk Drive media.*

## SaveAs

*NOTE:* See 'Save As' on page 9-24 for more information.

To save images to the USB Flash Drive or USB HDD,

1. Insert the USB Drive into the USB port.
2. Select the image(s) to be saved.
3. Select **Save As** menu in the lower, right-hand corner of the screen. Select the USB Drive as the archive media.
4. Specify: Image only or Secondary Capture, type of compression, quality, and image save format (Raw DICOM, DICOM, Jpeg, or WMV).
5. Press **Save**. When the images have been saved, press **Eject (F3)**.

*NOTE:* If you perform the SaveAs function to the USB drive (:Export) by RawDICOM format and review the data on your PC, the title of the data appears as  
“:\GEMS\_IMG\2006\_Oct\08(date)\xxxx(PatientID)”.

## Direct SaveAs

You can save the image directly to the USB Drive just by pressing a **Print** key.

1. Insert the USB Drive into the USB port.
2. Select **Save As** from the pull-down menu in Utility -> Connectivity -> Service. Press **Add**.
3. Select **Save As** in the list. Rename it in the Name field if needed.
4. Select USB Drive in the Destination field.
5. Verify the service.
6. Press **Save**.
7. Assign Save As to the appropriate print key in Button tab.
8. Display the image on the monitor and press the print key.

### Export/Import

To export/import exams using the USB Flash Drive or USB HDD,

*NOTE: Before you export exams to the USB HDD, check “Export to USB HDD: Create DICOMDIR” in Utility -> Connectivity -> Miscellaneous. If you uncheck this parameter, you must import the data to review.*

1. Insert the USB Drive into the USB port.
2. On the Patient menu, select Data Transfer, then Export/Import. Specify USB Drive in the transfer To: pull-down menu. Select the patient/exam you want to transfer. Press **Transfer**.
3. When Export/Import has completed, press **F3**.

### EZBackup (USB HDD only)

1. Select “USB Drive” on the Utility -> Backup/Restore -> EZBackup -> Media.
2. Follow instructions for EZBackup. See ‘EzBackup’ on page 10-73
3. When EZBackup has completed, press **F3**.

## USB Quick Save

USB Quick Save easily sends images to a USB flash drive storage.

The images are stored either in .jpg or .WMV format.

## USB Quick Save Setup

In Utility -> Connectivity -> Service, select USB Quick Save.



Figure 9-25. Service USB Quick Save

## Assigning USB Quick Save to Print Keys

The USB Quick Save service can also be assigned to the Print keys via the Utility -> Connectivity -> Button preset menu.



Figure 9-26. Assigning USB Quick Save to Print Keys

# Printing Options

## Setting up Digital Peripherals

Set up digital peripherals from the Utility --> System --> Peripherals menu.

The following printers can be connected to the power outlet supplied by the system.

- BW Printer: UP-D898DC

For the UP-DR80MD and UP-D25MD, insert the USB cable into the USB port of the rear panel and plug it into a wall socket.

*NOTE: Printing using a standard printing service overrides the orientation and N-up feature of the printer preferences. Printer preferences are set up in the printer folder (via Utility --> System --> Peripherals. Select Properties under Standard Printer Properties).*

## Digital Printer Setup

There are two steps to do when setting up a digital printer:  
1) follow the procedure below for each printer, then 2) set up specific properties for each printer (specific instructions are provided for each printer following this section).



### CAUTION

- Before powering on the LOGIQ Totus, connect the printer via the USB cable and turn the printer power on.
- DO NOT remove the cable while the LOGIQ Totus is powered on.

Follow this procedure for each printer:

1. Select Utility--> Connectivity--> Service. Add the Standard Print service. Select the printer from the Printer pull-down Properties menu. For the UP-D898DC printer, select "Portrait" as orientation.
2. Type the printer name in the Name field. This name is used on the Button screen. After you select the printer from the Printer pull-down Properties menu again, it turns white. Press Save.
3. Select Button. Select the appropriate print key (Print1, Print2...) from the Physical Print Buttons section. Select the printer from the MyComputer column and press >> to move it to the Printflow View column. Press Save.

## Sony UP-D25MD Instructions

Follow these steps to set up the paper size of Sony UP-D25MD printer.

1. Press Utility-->System-->Peripherals. Select the UP-D25MD from the pull-down menu under Standard Printer Properties. Click **Properties**.



Figure 9-27. Standard Printer Properties

2. Select Properties.



Figure 9-28. Properties

3. Select Printing Preferences. Select Paper Size. Press **Apply**. Press **OK**. Press **Save**, then **Exit**.



Figure 9-29. Printing Preferences



## Notes for Sony UP-DR80MD



### CAUTION

- Before powering on the LOGIQ Totus, connect the UP-DR80MD and turn the printer power on.  
There is no warning to let you know that the printer is not functioning. Check the printer.
- DO NOT remove the cable while the LOGIQ Totus is powered on.
- DO NOT plug in a DR80MD while the LOGIQ Totus is turned on.

## UP-D898DC Printer Settings

Preferred printer settings for the UP-D898DC are shown below; and instructions follow.

Table 9-6: Recommended Settings

Recommendations	Use These Settings
Recommended Setting	<ul style="list-style-type: none"> <li>• Paper Size: <b>1920x1280</b></li> <li>• Windows Orientation: <b>Landscape</b></li> <li>• Utility--&gt; Connectivity--&gt; Service--&gt; Standard Print--&gt; Orientation: <b>Landscape</b></li> </ul>
Avoid using WIDE Setting	Utility--> System--> System Display--> Use the settings below: <ul style="list-style-type: none"> <li>• Utility--&gt; System--&gt; System Display--&gt; Image Display--&gt; Image Display Area: <b>Default or Large</b></li> <li>• Utility--&gt; System--&gt; System Display--&gt; Use Wide Screen For... -- <b>turn OFF all parameters</b></li> </ul>
Use Large Print Setting	<ul style="list-style-type: none"> <li>• Paper Size: <b>1920x1280</b></li> <li>• Windows Orientation: <b>Landscape</b></li> <li>• Utility--&gt; Connectivity--&gt; Service--&gt; Standard Print--&gt; Orientation: <b>Portrait</b></li> </ul>

### Setting up the UP-D898DC Printer Settings

1. Select Portrait for Orientation in Utility -> Connectivity -> Service--> Standard Print and press Save.
2. Select Utility ->System ->Peripherals.
3. Select the printer to adjust (UP-D898DC) from the pull-down menu under Standard Printer Properties. Click Properties.
4. Select Properties from the Printer pull-down menu.
5. Click Printing Preferences at the bottom of Properties Window.
6. Select the Layout tab and select:
  - Paper: 1920x1280
  - Orientation: Landscape
  - Interpolation Method: Bilinear
7. Select the Density Adjust tab and select:
  - Gamma: TONE2
  - Sharpness = 0; Dark = 0; Light = 0; Sharpness = 2
8. To save the adjusted printer settings, click Apply and then OK.
9. Close the 'Printers' window with the close button.
10. Exit System Setup with Save&Exit.
11. Assign the Printer to the remote keys.

## Network Printer

A network printer can be added to the system.

**NOTE:** *It is solely the customer's responsibility to determine printer and network settings and configuration to enable and ensure the specific network printer usage and functionality.*

### Add Network Printer

To add a network printer, the user must be logged on to the system as an administrator.

1. On the Utility ->System ->Peripherals page, Under "Network Printer," select **Add Network Printer**.

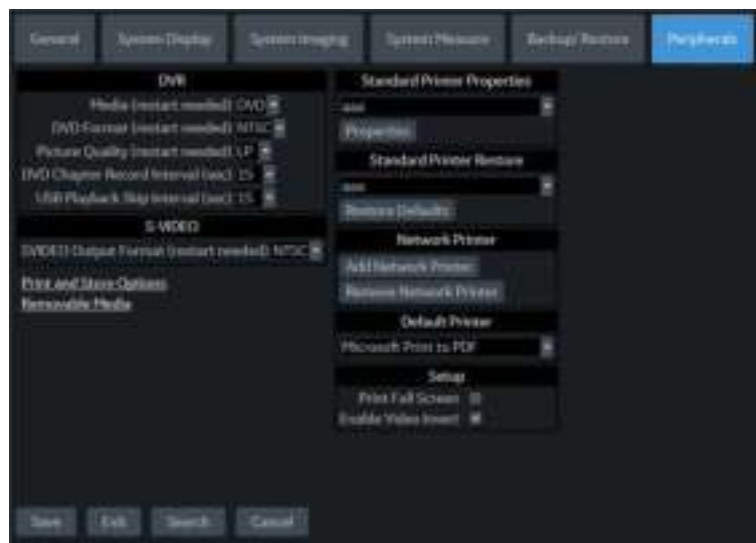

Figure 9-30. Network Printer

The "Add Printer" Dialog Box appears.

### Add Network Printer (continued)

2. In the Add Printer dialog box, enter a Printer Name, the IP Address of the desired printer, and select the Printer Driver. Select “Add Printer.”

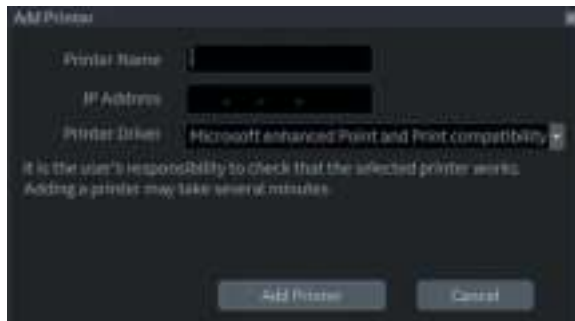

Figure 9-31. Add Printer

Adding a printer may take several minutes. A dialog box confirming installation displays when the printer has installed. Select “OK.”

**NOTE:** *Printer installation does not guarantee the printer will function correctly. The printer may install even if the IP address is incorrect or inaccessible.*

3. After installing the printer, go to Utility -> Connectivity to add a Standard Print Service and a Print Button (see ‘Digital Printer Setup’ on page 9-47).

Print a test exam image or report and verify the full image or all information has printed. Verify the resolution, aspect ratio, clarity and color accuracy of the prints.

## Remove Network Printer

To remove a network printer, the user must be logged on to the system as a Network Administrator.

1. On the Utility ->System ->Peripherals page, Under “Network Printer,” select **Remove Network Printer** (Figure 9-30 on page 9-51).
2. Select the printer to remove from the drop-down list and select “Remove Printer.”

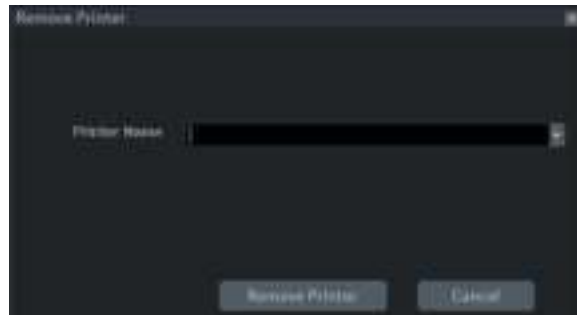

Figure 9-32. Remove Printer

A dialog box confirming printer removal displays when the printer has been uninstalled. Select “OK.”

## External Paper Printer

You can connect an external paper printer via the USB connection.



CAUTION

ONLY plug in devices to the USB ports located at the rear of the system WHILE the LOGIQ Totus is NOT powered up. If you plug in a device while the LOGIQ Totus is powered on, your system may become unusable.



CAUTION

DO NOT place an external paper printer inside the patient environment. This assures compliance to leakage current.

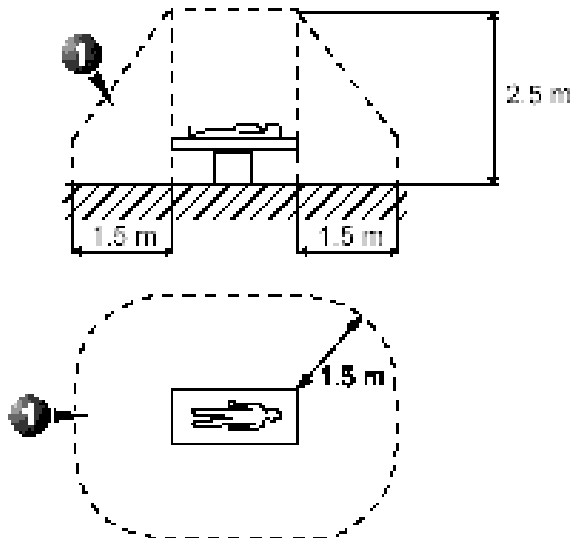

Figure 9-33. Patient Environment

## External Paper Printer Setup

**NOTE:** *The printer driver is customized for the LOGIQ Totus at the factory; you do not need to change the settings.*

1. Connect the printer to the USB port.
2. Select **Utility--> Connectivity--> Service**. Add the **Standard Print** service.



Figure 9-34. Connectivity -> Service Screen

3. Select the printer from the Printer pull-down Properties menu.

**NOTE:** *After selecting the printer, the field turns white.*

4. Set the following parameters in Properties: Rows, Columns, Orientation, and Right Margin.
  - *Rows=3*
  - *Columns=2*
  - *Orientation=Portrait*
  - *Right Margin (mm)=10*

5. Type the printer name in the *Name* field.

**NOTE:** *This name is used on the Button screen.*

## External Paper Printer Setup (continued)

6. Press Save, then select the Button tab.
7. Select the appropriate print key (Print1, Print2...) from the Physical Print Buttons section.
8. Select the printer from the MyComputer column and press ">>" to move it to the Printflow View column.



Figure 9-35. Connectivity -> Button Screen

9. If you want to assign this printer to the Standard Print Button on the Active Image Screen, select this printer at the Active Image Printer section.
10. Press Save.

**NOTE:** *Adjust the rows, columns, and margins as necessary to obtain the image size and quality that you find acceptable.*



## Setting up the Printer to Print Reports and Patient List Print

To set up the external printer to print reports and Patient List Print,

1. Press **Utility--> System--> Peripherals** and select *Printers* under Setup.
2. Select the printer from Default Printer pull-down menu.



Figure 9-36. Report Printer Setup

3. Press **Save**.
4. Press Print on the Report screen to print the report.

# Portable Exam

## Perform a Portable Exam (Using the Worklist)

To perform a portable exam (using the worklist),

1. Go to the worklist and get the patient(s) you will need for this portable exam(s).
2. Ensure that images will be saved to the local hard drive.
3. Press the Power On/Off switch.
4. Proceed to perform the exam(s). Press Power On/Off. Select the patient, do the exam. Store images. Images are held in the spooler.
5. If there are additional patients to scan, repeat steps 4 and 5. After you have completed all portable exams, press Power On/Off.
6. When you have returned from performing the portable exam(s), reconnect to the network. Press Power On/Off.
7. Press F4. Send all of the images in the spooler to the printer/storage device.

---

## *Chapter 10*

# Customizing Your System

*Describes how to create system, user, and exam presets.*

## Overview

Preset Menus provide the following functionality:

### Utility, Page 1 Configuration Menus



Figure 10-1. Utility Menu, Page 1

- **System presets.** View and update general system configuration settings, measurement and analysis settings, and video settings; backup and restore data and configuration files.
- **Imaging presets.** View and update exam and imaging parameters.
- **Comment library presets.** Set up comment libraries by application.
- **Body Pattern library presets.** Set up body pattern libraries by application.
- **Application and User Defined presets.** Configure application- and user-specific settings.

## Overview (continued)

### Utility, Page 1 Configuration Menus (continued)

- **User Specific.** Configure My Desktop.
- **3D/4D.** Real-time 4D and Static 3D scanning.
- **Connectivity Setup.** Define connection and communication setup, DICOM, Wireless Networking, Tricefy, and includes exam dataflow information.
- **Measurement and Analysis presets.** Customize exam studies, create measurements, set up manual sequencing, and create OB Tables. Refer to the “General Measurement and Calculations” chapter for more information.
- **Reports Presets.** Allows you to edit the report template, diagnosis codes, and report comments. Refer to the Advanced Features chapter for more information.
- **Administration presets.** Perform system administrator activities such as setting up user IDs and logon format.
- **Scanner Apps.** Configure AFI and AutoEF.
- **Image Preset Manager.** Activates the Image Preset Manager to create, edit, import, and export user imaging presets.
- **Scan Assistant.** Create, import/export, and manage Scan Assistant programs.
- **Search.** You can search for a parameter on the Utility pages (Measure, Reports, and Service pages cannot be searched.)

### Overview (continued)

#### Utility, Page 2 Configuration Menus



Figure 10-2. Utility Menu, Page 2

- **Electronic Instructions for Use (eIFU) Icon.** Activates the Online User Manual.
- **Haptic Feedback.** Controls the strength of the haptic feedback.
- **Barcode.** Configures barcode input setting.
- **Scan Screen.** Activate the Scan Screen so that you can adjust the monitor's brightness/contrast via the **Room Profile** control and adjust the monitor's RGB level/color temperature/gamma via the **Color Profile** control.
  - **Room Profile.** Change Brightness and Contrast of main display when set to **User Defined**.
  - **Color Profile.** Control RGB level, color temperature, gamma, etc.
  - **Gamma.** Set the Gamma at 2.2 or 2.4.
  - **Color Space (OLED only).** Select ITU 709 Standard for High Definition TV, Native 1 for most vivid OLED colors, or Native 2 for a setting between ITU 709 and Native 1.
  - **Reset Monitor.** Resets the monitor to system default settings.
- **Test Patterns.** Test the Monitor screen's performance.
- **Service.** Activate the Service Browser.

To access these functions, select the **Utility** tab on the Touch Panel, then select the appropriate Touch Panel key.

---

## Overview (continued)

In addition, you can adjust the following via the rotaries located beneath the Touch Panel.

- **Master Volume.** Select to adjust the system volume, e.g., Doppler volume.
- **Effects Volume.** Select to adjust the system notifications, e.g., Touch Panel pushes, Print sounds, etc.
- **Touch Panel Light.** Select to adjust the brightness of the Touch Panel.
- **Kbd/Touch Lock.** Select to lock the Keyboard and Touch Panel controls in order to clean the system.
- **Brightness/Contrast.** Select to adjust the monitor brightness/contrast.
  - User-adjustable when **Room Profile** is set to “**User Defined.**”
- **Control panel backlight.** Controls the level of brightness of the blue and green backlights on the hard keys.
- **Accent Light.** Controls the level of brightness of the probe port LED.

# System Presets

## Overview

System presets allows you to view or change the following parameters

- **General** – Location, Date/Time, Patient Info, Key Usage, and Utility configuration
- **System Display** - Presets related to the monitor display format.
- **System Imaging** – CINE Loop Store, Cardiac, Biopsy Guides, and Image Control and Display configuration
- **System Measure** – Measurement, Cursor, and Results Window configuration
- **Backup/Restore** – Backup, Media, EZBackup, Detailed Restore of User Defined
- **Peripherals** – DVR, Print and Store Options, and Setup configuration
- **User Configurable Key** -- BT (Breakthrough) Key, Keyboard Key
- **About** – Release information and part numbers for: Application Software (including version), Online Help, Service Platform, Security Package, Base Image and Base Image Update.
- **Licenses** – Licenses for software used on the LOGIQ Totus.
- **Scanner Apps Info** – Information of the installed Plug-in Applications.



## Changing system parameters

To change system parameters:

1. On the Touch Panel, select **Utility**.
2. On the Touch Panel, select **System**.  
The System screen is displayed.
3. On the monitor display, move the **Trackball** to select the tab that has the information you want to change.
4. Select values for the parameters you want to change.
5. To save the changes, select the **Save** button. Select **Exit** to return to scanning. In some cases, you may need to reboot the system for the change to take effect.

## System/General Preset Menu

The System/General screen allows you to specify hospital name and system date and time.

Table 10-1: Location

Preset Parameter	Description
Hospital	Type the institution's name.
Department	Type the institution's department name.
Machine Description (1&2)	Type the machine name.
Preset Region (restart needed)	Select region (None or Europe).
Language (restart needed)	Select the appropriate language from the drop-down list. Note: If you select Japanese (JPN), only the warning and status messages are displayed in Japanese. You can not type in Japanese.
Online Help Language	Select the language you would prefer to use to read the online user manual.
Units	Select metric or US units of measurement.
Regional Options (restart needed)	Select to set up the keyboard.

Table 10-2: Date/Time

Preset Parameter	Description
Time Format	Select the time format: 12 Hr. AM/PM or 24 Hr.
Date Format	Select the date format: dd/mm/yyyy, mm/dd/yyyy, or yyyy/mm/dd.
Default Century	Select the default century for the system to use.
Date/Time (restart needed)	Select to display the Date/Time Properties window, to specify the system date, time, time zone, and to auto adjust for daylight savings time.

Table 10-3: General User Interface

Preset Parameter	Description
Color Level (restart needed)	Select the darkness of the utility pages and any message windows: Brightest, Bright, Standard (Dark Text), Standard (Light Text), Dark, Darkest.

Table 10-4: Title Bar

Preset Parameter	Description
Hide Patient Data	<ul style="list-style-type: none"> <li>• <i>Always</i> - Patient information is removed from the scanning screen Title bar (and while storing images).</li> <li>• <i>On Store</i> - Patient information is removed only when storing the image.</li> <li>• <i>Never</i> - Patient information is always displayed.</li> </ul> <p>NOTE: Upon recall of images with measurements, Dual image and/or V Nav, the DICOM image is recalled. In this case, there is no patient data burned into the DICOM image. If you want the data to appear on the image, set to <b>Never</b>.</p>
Hide DateTime	<ul style="list-style-type: none"> <li>• <i>Always</i> - Date and time is removed from the scanning screen Title bar (and while storing images).</li> <li>• <i>On Store</i> - Date and time is removed only when storing the image.</li> <li>• <i>Never</i> - Date and time is always displayed.</li> </ul> <p>NOTE: Upon recall of images with measurements, Dual image and/or V Nav, the DICOM image is recalled. In this case, the date and time are not burned into the DICOM image. If you want the date and time to appear on the image, set to <i>Never</i>.</p>
Font Size (restart needed)	Select to display patient information in the title bar using a small or large font size. You need to reboot the system for this change to take effect.

Table 10-5: Worksheet

Preset Parameter	Description
Use Bold Worksheet Fonts (Restart Needed)	Select to bold fonts in Worksheets. The setting will take effect when the system is restarted.

Table 10-6: Trackball

Preset Parameter	Description
Speed	Set how fast you want the Trackball to move while performing actions such as tracing the anatomy. Speed is used for Menu and Scan Mode. 0=Slow; 20=Very Fast
Acceleration	Set how fast you want to Trackball to move across the display. Acceleration is used for Menu and Scan Mode. 0, 1, and 2 with 0 being the slowest acceleration.

Table 10-7: Key Usage

Preset Parameter	Description
Run Fast Key speed	Select the maximum value of the key interval when running Fast Key.

Table 10-8: Utility

Preset Parameter	Description
Prompt for Save on Exit	If selected, the system prompts you to save data when you select exit without saving.

Table 10-8: Utility (Continued)

Preset Parameter	Description
Utility Font Size	Select the font size you want to use to view the Utility menus: Small, Medium, or Large.

Table 10-9: Scan Assistant

Preset Parameter	Description
Use Doppler Cursor	Use the Doppler Cursor when you activate Scan Assistant.

Table 10-10: Start Assistant

Preset Parameter	Description
Use Start Assistant	<ul style="list-style-type: none"> <li>• <i>On: Use Exam Description (default)</i> - Saves exam mapping automatically from worklist</li> <li>• <i>On: Use Scan Assistant only</i> - Exam description is ignored and selection of probe and preset is based on Scan Assistant protocol only. Exam Category and Scan Assistant program are not automatically selected. Start Assistant Editor does not show the Exam description column. Manual entry of an Exam Description for table entry is prevented.</li> <li>• <i>Off</i></li> </ul>
Create/Edit	Select to open Start Assistant Mapping Editor.

Table 10-11: V Nav

Preset Parameter	Description
Max.non US images per exam on Image History	Specify the number of non-Ultrasound images per exam to appear on the Image History page.

Table 10-12: Touch TGC

Preset Parameter	Description
Delay Time for Auto Hide (sec)	Off, 3, 6, 8, 12, 16
Custom Settings	Select Application or Category
Include TGC Curve when Saving Presets	Check to select.

Table 10-13: Miscellaneous

Preset Parameter	Description
Reset Control Panel Park Lock	Press to reset operator panel park lock.

Table 10-14: Touch Keyboard

Preset Parameter	Description
Auto Popup Keyboard on Patient Screen	Display Touch Keyboard automatically when Patient screen is selected.
Auto Hide Delay Time for Touch Keyboard (sec)	Off, 6, 8, 12, 16, 20, 24, 30
Display Keyboard with Comment Button	Display Touch Keyboard automatically when Comment mode is activated.

Table 10-15: Voice Control

Preset Parameter	Description
Enable Voice Control	Select to enable Voice Control.
Language	Choose the language you want to use for Voice Control. Voice Control is currently available only for US English.
Wake with 'Hey LOGIQ'	Select to activate Voice Control with your voice.
'Hey LOGIQ' Sensitivity	Choose how sensitive Voice Control to be when it responds to "Hey LOGIQ" (0, 1, 2, 3, 4).
Time Out after No Speech (sec)	Stop Voice Control after a specified period of no speech (5, 15, 30, 120, Never)
Show Live Captions	Display live captions in real-time
Continuous Mode	Check if you want the voice control is on continuously.
Cine Back on Freeze (sec)	Select time by which cine back after recognition of the Freeze command (0.0, 1.0, 1.5, 2.0, 2.5).
Audio Input	Adjust the audio input volume.

Table 10-16: Front LED

Preset Parameter	Description
Front LED Brightness	Select the brightness of front LED : Low, Medium, or High.
Ambient Light Color	Select the color for the ambient light: Off, White, Blue, Purple, or Pink.
Enable Voice Control Indicator	Check to enable Voice Control Indicator
Voice Control	No function, Front LED color for Voice Control Indicator
Enable Battery Indicator	Check to enable Battery Indicator
Battery Mode	No function, Front LED color on Battery Mode
Low Battery	No function, Front LED color on Low Battery
Battery Warning	No function, Front LED color on warning of low battery

## System/System Display Preset Menu

The System/System Display screen allows you to specify parameters for the Monitor Display.

Table 10-17: Image Display

Preset Parameter	Description
Image Display Area	Select Image Display Area Size: Default, Large, Extra Large
Image size (probe selection required)	Select Default or Large.
Use Magnification Zoom (preset selection required)	Select to enable Magnification Zoom on images (enabled by default).

Table 10-18: Side Panel Content

Preset Parameter	Description
Side Clipboard	Display On/Off.
My Desktop	
Measurement Summary	

Table 10-19: Clipboard

Preset Parameter	Description
Preview Image	Display On/Off
Show Zoom Reference Image	
Bottom Clipboard	Display On (Always display)/ Off (Never display)/ Auto (Display whenever there is no side clipboard)
Bottom Clipboard Auto Dimming	On/Off/Auto When the windows pointer is moved over the clipboard area, the pointer is undimmed.
Side Clipboard Auto Dimming	

Table 10-20: Use Wide Screen for...

Preset Parameter	Description
Dual Screen	Automatically switch to Wide Screen when in Dual Screen.
DualView (Simultaneous)	Automatically switch to Wide Screen when in Simultaneous DualView Screen.
Contrast DualView	Automatically switch to Wide Screen when in Contrast DualView Screen.
LOGIQView	Automatically switch to Wide Screen when in LOGIQView.

Table 10-20: Use Wide Screen for... (Continued)

Preset Parameter	Description
Volume Nav	Automatically switch to Wide Screen when in Volume Navigation.
QAnalysis	Automatically switch to Wide Screen when in QAnalysis. Side by Side Timeline automatically switches to wide screen when in Timeline mode.
Display Format Horizontal Timeline	Side by Side Timeline automatically switches to wide screen when in Timeline mode.
Single Image	On/Off/Auto Auto turns on wide screen if 2D image exceeds width of non wide screen image area.

Table 10-21: Display

Preset Parameter	Description
Horizontal Scale	Select to display width markers.
TGC Display	Select to display TGC curve.
PW Velocity Units in cm/s	Select to change scale on timeline from centimeters per second to meters per second.
Shear Elasto Display Units	Select m/s or kPa.
Shear Stiffness and Velocity Measurement	Specify whether to display Shear Wave Stiffness and Velocity measurements.
Shear Elasto Color Map	Select Red as Hard or Blue as Hard.
Strain Elasto Color Map	Select Red as Hard or Blue as Hard.
UGAP Display Units	Select dB/cm/Mhz or dB/m
Attenuation Coefficient and Rate Measurement	Select to display Attenuation Coefficient and Rate Measurement
Image Parameter Size (restart needed)	Choose Small, Medium, Large, or Extra Large. Must reboot the system.
Highlight Image Parameter Changes	Select if you want the display to indicate which controls you adjusted by highlighting the new value on the display.
Use Thicker V Nav Graphics	Select to display thicker V Nav graphics
Overlay Color (single visible dataset)	Select Red, Green, Blue or BW (Black/White).
PET Color in V Nav (if grayscale-only dataset)	Select Hot Body, Hot Metal, Warm Metal, BW (Black/White).
Hide Multiple Dataset Menu When Storing	Select to hide the Multiple Dataset Menu when storing.
Live/Freeze Indicator	Display On/Off.

Table 10-21: Display (Continued)

Preset Parameter	Description
Enable DICOM grayscale display mode (GSDF)	Enable On/Off. Adjust Gamma curve on DICOM GSDF. <i>Note: With GSDF disabled, the monitor still uses a gamma curve that may be selected on the Touch Panel (for backwards compatibility with sites that are happy with their PACS or may have a mix of older systems). With GSDF enabled, the gamma button on the touch panel affects the image, emulating the appearance of that gamma, but does not affect the monitor.</i>
Room Profile	Dark, Semi Dark, Light, User Defined, Last Used



## System/System Imaging Preset Menu

The System/System Imaging screen allows you to specify parameters for key usage and image control and display.

Table 10-22: Biopsy Guides

Preset Parameter	Description
Show Center Line	Displays center biopsy guideline.
Show Outer Lines	Displays outer biopsy guidelines.
Enable 0.5cm markers	Activates biopsy depth markers every 0.5cm.
Show Biopsy Mark on CFM Simultaneous Mode	Displays the Biopsy Guideline on the image while in Simultaneous Mode.
Show Biopsy Mark on Dual View Mode	Displays the Biopsy Guideline on the image while in Dual View Mode.
Show Biopsy Circle	Specify whether to display the Biopsy Circle with the Biopsy guideline.

Table 10-23: Compare Assistant

Preset Parameter	Description
Comparison Image Side	Select Left or Right.
Comparison Image Date	Select All Dates, Different Date or None.
Copying Settings	Select Automatic: Imaging and Annotations, Automatic: Imaging Only, Automatic: Annotations Only, Manual: Imaging and Annotations, Manual: Imaging Only, Manual: Annotations Only or Off.

Table 10-24: Image Label Layout

Preset Parameter	Description
Clipboard	Select 1-Line Label, 2-Line Label, 1-Line Timer (Contrast Clock), 2-Line Timer (2 Contrast Clocks), 2-Line Both (1 Label and 1 Contrast Clock) or No Label.
Active Images	
Image History	

Table 10-25: Image Label Color

Preset Parameter	Description
Clipboard	Select the color of the Clipboard Image Label.
Active Images	Select the color of the Active Image Label.
Image History	Select the color of the Image History Image Label.

Table 10-26: Image Timer Color (Contrast Clock)

Preset Parameter	Description
Clipboard	Select the color of the Clipboard Image Timer.
Active Images	Select the color of the Active Image Timer.
Image History	Select the color of the Image History Image Timer.

Table 10-27: Contrast Clock Highlight (Interval notification for contrast examination)

Preset Parameter	Description
Clipboard	Select the interval notification by contrast clock highlight.
Active Images	Select the duration of contrast clock highlight
Image History	Select the sound of contrast clock highlight.

Table 10-28: Controls

Preset Parameter	Description
Auto Invert on Linear Steer	When selected, automatically inverts the color scale or spectral timeline when the Steer function is used.
Auto Invert on ASO	Automatically inverts the spectrum with ASO.
Link Color/Doppler Invert	When selected, the Doppler timeline scale inverts along with the color ROI.
Pushing Depth Rotary Performs Image Reverse	When selected, you can reverse the image when you push down on the Depth rotary.
Toggling Zoom Rotary Performs Depth	When selected, you can adjust the Depth by moving the toggle up and down.
Audio Volume	Adjusts the Doppler audio volume via a drop-down menu (for example, 0=softer; 20=louder).
Auto Freeze Time (probe selection required)	Automatically freezes the system after 10, 30 minutes, 1 hour of inactivity, or never.
Countdown Time For Contrast (sec)	Specify time for the Contrast Clock to countdown during a contrast study, 0 (off), 3, and 5 seconds.
Reverse Depth Control	Changes key direction for the Depth control.
Reverse Steer Controls	Changes key direction for the Steer controls.
Turn Off CrossXBeam for LOGIQView (non-linear probes)	Deactivates CrossXBeam when you activate LOGIQView.
3D Postprocessing when reloading	When selected, the system re-processes the recalled 3D CINE Loop.
Tru 3D/Easy 3D Resolution	Set Easy 3D/Tru 3D Resolution: Default, High, or Very High.
Doppler Scroll Priority	Set to 2D, Doppler, or Last Live Mode.

Table 10-28: Controls (Continued)

Preset Parameter	Description
Start Doppler in Update	Select to allow the B/CF image to continue live while the PW image is frozen in triplex.
Assign PW Sample Volume control to rotary	Select to assign PW Sample Volume control to rotary.
CF Knob Changes Shear Gain	Enables Shear Wave Elastography gain control via the CF knob on the console. Check box to enable Shear gain control with CF knob (Off by default).
Default Rotation when changing mode	Sets the default rotation when changing mode.
Default MyPreset	Check the box to start MyPreset. Uncheck the box to start ConventionalExam tab (Default).

Table 10-29: Auto Preset Assistant

Preset Parameter	Description
Enable	Enables this feature.
Default Auto Mode in new patient	Sets the default mode for automatic preset change when new patient is created. - "Automatic" : Preset is changed automatically, when scan image is classified to a different preset with a high score. - "Air Detected" : Preset is changed with a delay when scan image is classified with a high score. More specifically, preset change happens when air is detected. This is to avoid sudden preset change during scanning. - "OFF" : Preset is not changed automatically. A button (or trackball key) needs to be pressed to change preset.
Turn off Auto after changing preset	If checked, automatic preset change is disabled once preset is changed. In other words, Auto Mode becomes "OFF".
Automatically Retain Field Of View	If checked, Field Of View is retained after preset change.
Check before automatic change	If checked, a dialog is displayed to let user change or cancel preset change, during automatic preset change.
Recommendation without specifying preset	If checked, recommendation messages in the status bar do not include name of suggested preset.

Table 10-30: Auto Abdominal Color Assistant

Preset Parameter	Description
Enable	Enables this feature.
Auto Flow Model selection	If checked, automatic flow model change can happen with a high classification score.
Turn off Auto after manual Flow Model selection	If checked, automatic flow model change is disabled, if user manually selects a flow model.

Table 10-31: V Nav 3D Marker

Preset Parameter	Description
Inner Alpha	0-100
Margin Alpha	0-100
Color	Yellow, Orange, Red, Blue, Purple, Pink, or White
Margin Color	Yellow, Orange, Red, Blue, Purple, Pink, or White
Diameter (mm)	1-100
Margin Dist. (mm)	0-15 in 0.5 mm increments
Short Axis	1-100
Long Axis	1-100
Reposition	Check to reposition.

Table 10-32: EZ Settings

Preset Parameter	Description
EZ Touch Panel Page	Check to enable EZ Touch Panel on first page of B and flow mode tabs. Uncheck disable EZ Touch Panel (default).
MyPreset Shortcuts	Select "By Probe (Default)" or "By Category".
Maintain icon usage	Select "Always", "With EZ touch panel" or "Never".
B mode button	No function, Colorize, SRI HD, Reverse
Color mode button	No function, Map, Radiant Flow, Biopsy Guideline.
PDI mode button	No function, Map, Radiant Flow, Biopsy Guideline.
BFlow mode button	No function, Visualization, Background
MVI mode button	No function, Map, Radiant Flow, Biopsy Guideline.
PW mode button	No function, Simultaneous, Colorize, Wall Filter, Modify Auto Calcs, Trace Sensitivity, Quick Angle
CW mode button	No function, Simultaneous, Modify Auto Calcs, Trace Sensitivity, Trace Method, Map

## System/System Measure Preset Menu

The System/System Measure screen allows you to specify measurement parameters such as the type of default OB measurements and calculations. You can also define cursor and Results Window default functionality.

Table 10-33: Measurement

Preset Parameter	Description
Repeat Measurement	Select Repeat, No, DefaultMeasure Repeat = After you take a measurement, the system automatically starts the same measurement again. No = After you take a measurement, you have to touch a Touch Panel key or Trackball key to start another measurement. DefaultMeasure = After you take a measurement, the system automatically starts a default measurement based on the current scanning mode (B-Mode = basic length measurement, M-Mode = basic length measurement, Doppler Mode = velocity measurement except after a volume flow calculation).
OB Type	Select which OB measurements and calculations studies to use: USA, Europe, Tokyo, Osaka, or ASUM.
EFW GP	Select the source used to calculate EFW-GP (Estimated Fetal Weight-Growth Percentile): Hadlock, Williams, Brenner, Kramer (f), Kramer (m), WHO.
CUA/AUA for Hadlock	Select to use CUA (Composite Ultrasound Age) or AUA (Average Ultrasound Age) as the default
Hadlock Table Type	Select Hadlock 82 or Hadlock 84 tables
EFW Formula (Europe)	Select the source used to calculate EFW (Europe) (Estimated Fetal Weight), Hadlock, Hansmann, Merz, Rich/Berk, Shep/Wars
EFW Formula (Tokyo)	Select the source used to calculate EFW (Tokyo) (Estimated Fetal Weight): Tokyo, Tokyo S-1, Tokyo S-2, Tokyo S-3.
Add 1 week to EDD	Select to add additional week to estimated date of delivery
OB Graph Display	Select Single or Quad for displaying OB Graphs.
OB Graph Single Display	Select Last Meas or EFW Single OB Graph displayed by default.
Fix Caliper by Print key	Select to use the Print key like the Set key. <i>NOTE: If you select this during a generic volume measurement, the print key does not function like the Set key, but instead ends the measurement sequence and initiates the volume calculation based on the number of measurements taken so far.</i>
LV Study using straight line	Sets straight line as the default for 2D LV studies.
Side selections of Rt, Lt and Off	Select to use "Rt, Lt and Off" for Side Selection. When not selected, displays only "Rt and Lt".
Dual Caliper on V Nav and Simultaneous.	Select to enable Dual Caliper on Volume Navigation and Simultaneous.

Table 10-33: Measurement (Continued)

Preset Parameter	Description
Map Cycle Select to Trackball Key	Map "AutoCalc cycle select" to Left/Right Set key.
Use WeekDay format for OB GA in DICOM SR	Select to use WeekDay format.
Volume Method	Select Single or Multiple for calculating volume. Single: Single volume is calculated when taking multiple L, H and W. Ex.) When take L, H, and W, then volume is calculated. After that take L, then volume is recalculated using the second L. Multiple: Each volume is calculated when taking multiple L, H and W. Ex.) When take L, H, and W, then volume is calculated. After that take L, H, and W, then the second volume is calculated.
Display AutoContour	Check box to display the trace line of Auto Contour.

Table 10-34: Worksheet (USA/ASUM)

Preset Parameter	Description
Show Individual Growth Percentiles	Check to display individual growth percentiles on the Worksheet.
OB Range Type	Selections: Min-Max, Standard Deviation.

Table 10-35: Cursor

Preset Parameter	Description
Cursor Type	Select whether to mark measurements with numbers or symbols.
Cursor Size	Specify 12x12 or 9x9.
Cursor Line Display	If selected, after you press Set to complete a measurement, the cursor line is displayed. If not selected, after you press Set to complete a measurement, only the cursor number or symbol is displayed.
Cursor Ellipse Cross Line Display	Check box to display the cross line in Ellipse.
D Manual Trace Cross Line Display	Check box to display the cross line with the caliper.
Cursor Position	Select 1st Cursor, 2nd Cursor, or Image Center.
Color When Set (restart needed)	Select white, yellow, bright red, or orange.
Cursor is Displayed when Trackball is moved	The active cursor does not display until you move the Trackball. This assumes the following presets are set: Repeat Measurement, Repeat, Default Measurement, and Cursor.

Table 10-36: Results Window

Preset Parameter	Description
Result Window Mode Depend	Select this if you want the measurement result window to be repositioned, depending on the mode.
Result Window Position X[0-800]	You can set the coordinates for the measurement result window when you do not have the result window set to be mode dependent. This is the X coordinate (left/right)
Result Window Position Y[0-600]	You can set the coordinates for the measurement result window when you do not have the result window set to be mode dependent. This is the Y coordinate (up/down)
Result Window Location-2D	Select the Result Window location on the Monitor Display: Left-Bottom, Left-Top, Right-Bottom, Right-Top, Extreme Right-Top, or Extreme Right-Bottom.
Result Window Location-TimeLine	Select the Result Window location: Left-Bottom, Left-Top, Right-Bottom, Right-Top, Extreme Right-Top, or Extreme Right-Bottom.
Result Window Format	Select Wide or Narrow.
Font Color (restart needed)	Select White, Off White, Yellow, Bright Red or Orange (reboots the system)
Font Size (restart needed)	Select mini, small, medium, large, or extra large (reboots the system)

## System Backup and Restore Preset Menu

Table 10-37: Backup

Preset Parameter	Description
User Defined Configuration	Select to back up the user-defined configuration settings.
Service	Select to back up Service (InSite and Network) settings.
For Report templates, use Utility-> Report-> Export	
Backup	Select to begin the backup.

Table 10-38: Backup To/Restore From

Preset Parameter	Description
Location	Select media type to use for Backup, Restore and Detailed Restore. USB Drive F, Local Backup or Cloud.

Table 10-39: EZBackup

Preset Parameter	Description
Reminder Dialog Interval days	Specify the number of days after the last backup that you want the system to prompt you to perform an EZBackup procedure (only for moving images).
Enable Reminder Dialog	Select to activate the EZBackup reminder pop-up dialog.
Media	Select media type.

Table 10-40: Restore

Preset Parameter	Description
User Defined Configuration	Select to restore the user-defined configuration settings.
Service	Select to restore service InSite and Network settings.
Restore	Select to begin the restore process for the selected configuration files from media storage backup.



## System Backup and Restore Preset Menu (continued)

The detailed section of this menu allows you to restore one area at a time from the user defined configuration. This allows you to selectively restore what you want to restore across multiple machines. Check the box(es) you want to restore, insert the appropriate media, and press Restore.

Table 10-41: Detailed Restore of User Defined

Preset Parameter	Description
Imaging Presets	Select to restore imaging presets.
Connectivity Configuration	Select to restore connectivity configurations.
Measurement Configuration	Select to restore measurement configurations.
Comment/Body Pattern Libraries	Select to restore comment and body pattern configurations.
Protocol Templates	Select to restore protocol (Scan Assistant) templates.
Report Templates (Same Software Version Only)	Select to restore Report templates.
3D/4D	Select to restore 3D/4D settings.
Fast Key	Select to restore Fast Key.
Utility->Application Presets	Select to restore Utility-> Application presets.
Custom Scan Assistant Programs	Select to restore Scan Assistant programs.
All Others	Select to restore all other configurations not listed in the Detailed Restore section. This includes parameters defined on the System preset menus.
Detailed Restore	Select to begin the restore process for the selected configuration files from media backup.

Table 10-42: Local Backup or Local and Cloud Backup

Preset Parameter	Description
Backup Automatically	Select to automatically backup user-defined configuration settings to the system hard drive after a new setting or configuration is saved on the Utilities pages.

## System/Peripherals Preset Menu

The System/Peripherals screen allows you to specify video and system setup parameters.

Table 10-43: DVR

Preset Parameter	Description
Media (restart needed)	Select recording media: USB storage.
DVD Format (restart needed)	Select NTSC or PAL.
Picture Quality (reboot required)	SP, HQ, EP, LP. Extended Play or Long Play.
DVD Chapter Record Interval (sec)	Select the Interval of time recording DVD chapter from 15, 30, 60 and 120 seconds.
USB Playback Skip Interval (sec)	Select the Interval of time skipping for USB playback from 15, 30, 60 and 120 seconds.

Table 10-44: S-Video

Preset Parameter	Description
SVIDEO Output Format (restart needed)	Select NTSC or PAL.

**Print and Store Options.** Press Print and Store Options to go to the Utility --> Connectivity --> Miscellaneous setup page.

**Removable Media.** Press Removable Media to go to the Utility --> Connectivity --> Removable Media page.

Table 10-45: Standard Printer Properties

Preset Parameter	Description
Properties	Select to add an additional standard printer via the USB serial port and to configure digital printers. This activates the Windows Add Printer wizard. NOTE: Most printer drivers are available via Windows; however, newer printers may require you to load the manufacturer-supplied print driver. Refer to the Basic Service Manual for more information.

Table 10-46: Standard Printer Restore

Preset Parameter	Description
Restore Defaults	Select to restore the selected printer to default settings.

Table 10-47: Network Printer

<b>Preset Parameter</b>	<b>Description</b>
Add Network Printer	Select to add network printer.
Remove Network Printer	Select to remove network printer.

Table 10-48: Default Printer

<b>Preset Parameter</b>	<b>Description</b>
Default Printer	Select to choose default printer.

Table 10-49: Setup

<b>Preset Parameter</b>	<b>Description</b>
Print Full Screen	Select for the standard printer to print the full screen.
Enable Video Invert	Select for the standard printer to print black on white rather than white on black.

## System/User Configurable Key

The User Configurable Key screen allows you to reconfigure the User Configurable Keys and configure Trackball Key functionality.



Figure 10-3. Programmable Operator Panel Controls

Table 10-50: User Configurable Keys

Preset Parameter	Description
1 User Defined Key	Select desired function to each User Defined key.
2 - User Defined Trackball Set Key	Specify which controls you want to be used on the Trackball: <ul style="list-style-type: none"> <li>• B/B-Flow/Contrast: Auto or Frequency</li> <li>• Color Flow/TVI/PDI: Auto, Steer, or PRF</li> <li>• PW, CW, TVD: Auto, Baseline, or PRF</li> <li>• Use Set keys to change BSteer Angle (On or Off)</li> </ul>
3 - Replaceable Key caps	Replaceable key caps are provided and can be chosen to Reconfigure the user configurable keys.
Keyboard Key 0 - 9 (Not pictured)	Check "Enable" in Keyboard key menu. Select desired function to each Keyboard key.

## System/User Configurable Key (continued)



Figure 10-4. User Configurable Key Preset Menu

To reconfigure User Defined key (UD), numeric Keyboard Keys, or Trackball Keys,

1. Press Utility--> System--> User Configurable Key.  
To configure the User Defined Keys, select the function for each key (refer to Figure 10-3). There are 10 User Defined Keys.
2. To configure the numeric Keyboard Keys, select the function for each Keyboard key (refer to the illustration above). There are ten (10) Keyboard keys that are configurable.
3. To configure the Trackball Keys, select the function for each user-defined Trackball Set Keys by mode.
4. Press Save.

### Replace User Defined Key caps

To move and replace a User Defined key cap,

1. Insert the flat blade of a screwdriver into the hole on the top side of the key cap and lift it up to remove it.

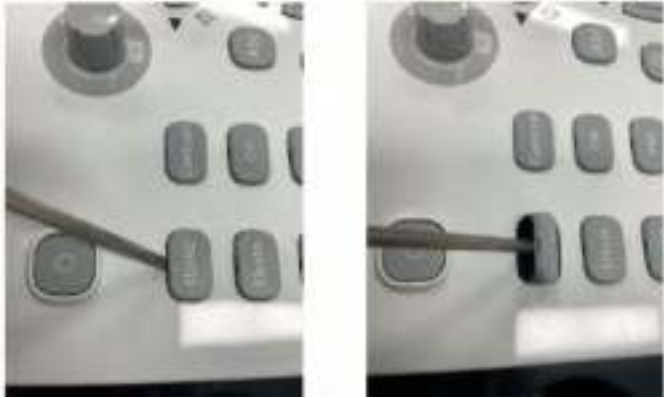

2. Repeat for each key, to match how you have configured the User Defined keys.
3. Replace the key caps by positioning it and pushing down on the key cap until it clicks into place.

## System/About Preset Menu

The System/About screen lists information about the system software.

Table 10-51: Installed Software Packages

Preset Parameter	Description
Application Software	The version, revision and part number of the current software on this system.
Online Help	The current version and part number of the Online Help on this system.
Application Service Patch	The current version and part number of the Service Platform on this system.
Security Package	The current version and part number of the Security Package on this system.
Base Image	The current version and part number of the Base Image on this system.
Base Image Update	The current version and part number of the Base Image Update on this system.

Table 10-52: Copyright

Preset Parameter	Description
Copyright	Lists the copyright for the system.

## Licenses

The Licenses screen lists information about the software licensed for use on the LOGIQ Totus.

Table 10-53: Software

Preset Parameter	Description
License Titles	Scroll to select the License; the license is displayed in the License window.

## System/Scanner Apps Info

The Scanner Apps Info lists information about the installed plug-in applications.

Table 10-54: Scanner Apps Info

Preset Parameter	Description
Installed Plug-in Applications	Information of the installed Plug-in Applications.

# Imaging Presets

## Overview

Imaging screens allow you to specify parameters by Preset and Probe by Mode. For information about the specific parameters, refer to Chapter 5 Optimizing the Image.

- B-Mode (B)
- Color Flow Mode (CF)
- Power Doppler Imaging (PDI)
- Micro Vascular Imaging (MVI)
- Elastography (ELASTO)
- UGAP
- M-Mode (M)
- Anatomical M-Mode (AMM)
- Pulse Wave Mode (PW)
- Continuous Wave Mode (CW)
- Harmonics (HAR)
- B-Flow (BF)
- Contrast Reference (Ref)
- Contrast (CON)
- Tissue Velocity Imaging (TVI)
- Tissue Velocity Doppler (TVD)
- General



Figure 10-5. Imaging Preset Example

1. Preset/Application-dependent setup parameters.
2. Probe-dependent setup parameters.



## Changing imaging presets

To change imaging presets:

1. On the Touch Panel, select **Utility**.
2. On the Touch Panel, select **Imaging**.  
The system displays the Imaging screens.
3. In the row across the top of the screen, select the mode.  
The system displays two sets of parameters and settings. The left column lists all settings for the exam (for example, Abdomen). The right column(s) list settings that apply only to the exam and probe combination.
4. In the Preset list, select the exam.
5. In the Probe list, select the probe.
6. To change a parameter, do one of the following:
  - Select the value from a list
  - Select one value from a choice of two or more buttons
  - Select or clear a check box
7. After changing the parameters, to save the changes, select the Save button.

**NOTE:** *When you Save changes to imaging parameters, the system saves changes to all modes, not just the mode currently displayed.*

**NOTE:** *If you have problems with imaging, you can return parameters back to the original settings. Select the exam, probe, and mode, and then select Reload Factory Defaults. The system returns the selected parameters to the original settings.*

For information about the specific parameters, refer to Chapter 5 Optimizing the Image.

## General

You can specify a default probe per application and a default application per probe, ECG Display or Sync Mode.

### Default probe per application

1. To specify a default probe per application, select Utility --> Imaging --> General.
2. Check the parameter if you want to start it automatically.
3. Select the default probe from the pull-down menu.

### Default mode and application per probe

1. To specify a default application per probe, select Utility --> Imaging --> General.
2. Under Probe, specify the desired mode and application from the pull-down menu.

Checkmark the following fields when you want the system to activate a certain display. Values vary by probe.

- Simultaneous
- Automatically Retain Field of View  
If selected, the system automatically activates the Retain Field of View control when a field of view setting is changed. If not selected, you can activate the Retain Field of View manually from the Probe Touch Panel.
- Application Default Mode
  - B-Mode
  - Harmonic
  - Steer knob activates B Steer+
- Default PDI
  - PDI
  - MVI
- Default Elasto
  - Shear
  - Strain
- PDI/TVI button
  - PDI
  - TVI
- BF/CHI button
  - BF
  - CHI
- ECG
  - ECG Display
  - Sync Mode

# Comments Libraries Presets

## Overview

Comment screens allow you to specify comment text and pointer options, to define comment libraries, and assign comment libraries to applications.

## Comments Libraries/Libraries Preset Menu

On the comments *Libraries* tab, you can change and create comment libraries. A comment library is a list of comments that are associated with a specific application. The comments are listed in the library in the order in which they display on the Touch Panel. For each library, you can define two Touch Panel displays of comments (Page1 and Page2), with 30 comments on each Touch Panel. Home and Arrow controls can also be added to the Touch Panel displays.

You can configure these comment color groupings via Utility--> Comments--> Libraries (up to 5 groups).



Figure 10-6. Comment Libraries Preset Menu

## Comments Libraries/Libraries Preset Menu (continued)

Table 10-55: Libraries

Preset Parameter	Description
Library	The name of the comment library.
Reload Factory Defaults	Select to reload factory defaults.
Small List	Fields where you define a small list.
User Defined Library	The name of a new comment library that you want to create/delete.
Copy from Existing	You can add to or delete from the selection of comments.

### Defining Comments

1. In the *Library* field, select the library you want.  
The system displays all comments for the library. You can have two Touch Panel displays of comments for each library. The comments are listed in the order that they are shown on the Touch Panel when you use comments.
2. To change or add an comment, select the comment or blank location and press **Set**, then do one of the following:
  - Type the comment.
  - Select the comment in the *Copy from Existing* list, and press **Set**.
3. To save the changes, select the **Save** button.

### Creating a new comments library

1. In the *User Defined Library* field, type a name for the library, then select **Create**.  
The system creates a new library.
2. Enter comments as described in step 2 above.
3. To save the changes, select the **Save** button.

## Deleting a user defined library

1. Select the library name which you want to delete from the pull-down menu.
2. Press **Delete**.
3. Press **Save** to save the changes.

## Creating a small list

A small list is a list of up to three comments attached to one comment location on the Touch Panel. You can use a small list to group similar comments, such as those indicating a probe location. For example, you can specify that a small list include the following comments: Long, Transverse, and Coronal. To make comments easier to use, you can define the small list in the same location in each comment library.

To define a small list:

1. Move the **Trackball** to the comment field on Page1 or Page2 where you want to create a small list, and press **Set**.
2. Move the **Trackball** to the first field in the *Small List* section, and press **Set**.
3. To enter comments in the fields in the Small List section, select the field and press **Set**, then do one of the following:
  - Type the comment
  - Select the comment in the Copy from Existing list, and press **Set** twice.

You can enter up to three comments. When you enter an comment in the first field of the Small List section, the selected comment field on Page1 or Page2 changes to SMALL LIST.

4. To save the changes, select the **Save** button.

**NOTE:** *The small list can be displayed as a pop-up window or as a toggle field. The Small List Operation field on the General tab allows you to specify how it is displayed.*

## Comments Libraries/Comments Preset Menu

On the Comments tab you can specify text and pointer options.

Table 10-56: Text

Preset Parameter	Description
Text Font Size	Specify the font size. The font size increases as the number increases.
Text color (Text1 and Text2)	Select the color for comment Text1 and Text2.
Arrow Color	Select the color for comment Arrow.
Text Boundary	Select Group Move or Word Wrapping.
Small List Operation	Select whether you want small list options to display in a Pop-up window, by a Toggle function, or in a Pop-up with replace.
Enable Type Over Mode	Select to type over existing comments. Position the cursor over the text to be changed, then start typing.
Reset Small List	Select to indicate that small lists should not be reset to the first item.
Automatically Set Text	Sets the comment as you are typing it.
Replace Mode	Select to replace comment.

Table 10-57: Arrow

Preset Parameter	Description
Arrow Length	Select the default pointer length.
Arrow Size	Select the default pointer size.
Keep Arrow Angle	Keep the angle of arrow pointer head until next change.

Table 10-58: General

Preset Parameter	Description
Retain while entering or leaving timeline mode	If selected, the system keeps the comment(s) on the monitor display when you enter or leave timeline mode.
TextOverlay in Multiple Image	When selected, and you select the F8 key to hide or show comments, if you are in multiple image, the system hides the text in both images. When cleared, the system only hides the text for the active image.
TextOverlay Sequence	You can specify to display Text1, Text2, or both. This allows you to have some comments that do not change during the exam while allowing you to change other comments. Toggle the F8 key to cycle through the 3 Text1/Text2 states.
Erase when the probe or application is changed	Deletes annotations when you change the application or probe.

Table 10-58: General (Continued)

Preset Parameter	Description
Clear Non Active Image Comments	Select if you want comments to be removed from the non-active multi image.

After you change comment options, select **Save** to save the changes.

## Comments Libraries/Applications Preset Menu

The Comments Libraries/Applications tab is a link to the Applications preset menu. The Applications preset screen allows you to specify which libraries belong to an application. You also specify which is the default library that displays when you use comments.

The Applications/Comments screen can be accessed through either the Comments Libraries or Applications Touch Panel key.

## Specifying which libraries belong to an application

1. On the Applications tab, in the Application field, select the application.
2. In the Library Group Tabs fields, select the libraries for this application. You can select up to six libraries.
3. In the Default Library Group field, select the default library you want the system to display when you use comments.

**NOTE:** *When you use comments, the default library is displayed. To use other libraries for the application, press the tab for the library.*

4. To save the changes, select the Save button.

Table 10-59: Applications

Preset Parameter	Description
Preset	The name of the application preset.
Tabs	A list of libraries for the application. You can select up to six libraries.
Default Tab	The default library that the system displays when you use comments.

## Using comments from a library

To use comments, press the **Comment** key on the Control Panel. Comments are then displayed on the Touch Panel.

To select a comment library, press the appropriate tab (e.g. the tabs are OB23 and OB23\_1).



Figure 10-7. OB 2/3 Comments Touch Panel



## Comments Libraries/Mapping Preset Menu

The system uses the annotation/body pattern information associated with the image to automatically assign the segment/position qualifier of the breast lesion.

On the Mapping tab, you add/delete/reset the user-defined mapping for the qualifier.



Figure 10-8. Comment Mapping

Table 10-60: Mapping preset

Preset Parameter	Description
Annotation to Location Conversion	Add/Delete/Reset the use-defined mapping annotation for the qualifier for Breast. <ul style="list-style-type: none"> <li>• <b>Add:</b> Add the use-defined mapping annotation</li> <li>• <b>Delete:</b> Delete selected user-defined mapping.</li> <li>• <b>Reset:</b> Reload factory default mappings to the selected qualifier.</li> </ul>
Use Auto Positioning	Configure a mapping of annotation and body pattern to location (Position and Segment) mappings. Note: This is effective only against the following body pattern: Breast4 Lt/Rt, Breast5 Lt/Rt, Breast6 Lt/Rt, Breast7 Lt/Rt, Breast8 Lt/Rt

After you change Mapping options, select Save to save the changes.

## Comments Libraries/Mapping Preset Menu (continued)

For example,

1. Select Qualifier "12 O'Clock" from the pull-down menu.
2. Type the mapping annotation "12" and press Add.
3. Check "Use Auto Positioning".



Figure 10-9. Comment Mapping

4. In Utility-> Body Pattern-> Libraries, select SMLP from pull-down menu.
5. Select an empty cell of the Library table.
6. Select Breast4\_Rt in Copy from Existing to add.



Figure 10-10. Comment Mapping - SMLP

## Comments Libraries/Mapping Preset Menu (continued)

7. Press Save and Exit.
8. Scan the patient.
9. Type "Right Breast 12 Zone 1" as Comment on the image.
10. Activate Breast measurement and select Lesion folder from the Touch Panel for add Lesion1.

Position Rotary is set 12 O'Clock, Segment Rotary is set A, and "12 O'Clock A" displays as measurement name automatically.

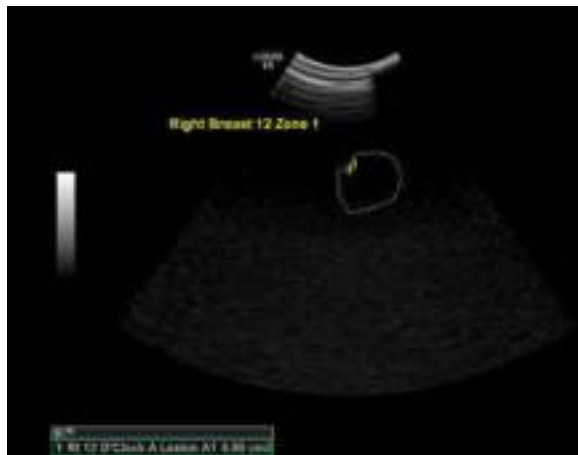

Figure 10-11. Comment Mapping - Measurement

**NOTE:** *The system assigns "-" to position qualifier if the value is not found in the annotation or body pattern information associated with the image.*

11. Select the frame for Lesion 2.
12. Select Breast4\_Rt as Body pattern on the image and locate the probe mark in the appropriate position.
13. Activate Breast measurement and select Lesion folder from the Touch Panel.
14. Position Rotary and Segment Rotary is set automatically associated with the position and segment of the probe mark.

# Body Patterns Presets

## Overview

Body patterns screens allow you to specify body pattern options, to define body pattern libraries, and assign body pattern libraries.

## Body Pattern Libraries/Libraries Preset Menu

On the Body Patterns Libraries tab, you can change and create body pattern libraries. A body pattern library is a list of body patterns that are associated with a specific application. The body patterns are listed in the library in the order in which they display on the Touch Panel. For each library, you can define two Touch Panel displays of body patterns (Page1 and Page2), with 15 body patterns on each Touch Panel.



Figure 10-12. Body Patterns Libraries Preset Menu

Table 10-61: Body Patterns Libraries

Preset Parameter	Description
Library	The name of the body pattern application library.

Table 10-61: Body Patterns Libraries (Continued)

Preset Parameter	Description
Reload Factory Defaults	Select to reload factory defaults.
Body Pattern Image	Displays the image of the currently selected body pattern.
User Defined Libraries-Create	The name of a new body pattern application library that you want to create.
User Defined Libraries-Delete	Allows the selection of the user defined library to be deleted.
Copy from Existing	A list of body patterns you can use to create an application library.

### Defining body patterns

1. In the *Library* field, select the application library you want. The system displays all body patterns for the library. You can have two Touch Panel displays of body patterns for each library. The body patterns are listed in the order that they are shown on the Touch Panel.
2. To change or add a body pattern, select the body pattern or blank location and press **Set**, then do one of the following:
  - Type the body pattern name.
  - Select the body pattern in the *Copy from Existing* list, and press **Set**.

*NOTE:* When you select a body pattern name in a Touch Panel location or in the *Copy from Existing* list, the system displays the pattern in the lower left corner of the screen.

3. To save the changes, select the **Save** button.

### Creating a new body pattern library

1. In the *User Defined Libraries* field, type a name for the library, then select Create. The system creates a new library.
2. Enter body patterns as described in step 2 above.
3. To save the changes, select the **Save** button.

## Body Pattern Libraries/Body Patterns Preset Menu

Table 10-62: Body Patterns

Preset Parameter	Description
Erase When the probe or application is changed	If checked, when you change probes or applications, the system erases the body pattern.
Erase When the image is unfrozen	If checked, when you unfreeze the image, the system erases the body pattern.
Copy to active side in multiple image	If checked, when you use dual B-Mode, the system copies the body pattern to the active side of the dual image.
Body pattern background	Select whether you want the body pattern background to be Transparent or Opaque.
Use Zoom Rotary knob to select Body pattern	If selected, you can scroll through the body patterns with the Zoom control.
Body Pattern knob Recall On	<p>When the image is recalled, Body pattern knob works as below.</p> <p>Body Pattern on: Activate Body Pattern by press or move Up/Down/Left/Right the Body Pattern knob.</p> <p>U/D: Body Pattern On, L/R: Prev/Next image: Move Body Pattern knob Up and Down to Body Pattern On, Move left recalls previous image, move right recalls next image.</p> <p>Prev/Next image: Move up and left recall previous image, move down and right recall next image.</p> <p>None: Activate Body Pattern by press the Body Pattern knob.</p>
Body Pattern knob Recall Off	<p>When the image is not recalled, Body pattern knob works as below</p> <ul style="list-style-type: none"> <li>• Body Pattern on: Activate Body Pattern by press or move Up/Down/Left/Right the Body Pattern knob.</li> <li>• U/D: Body Pattern On, L/R: Prev/Next image: Move Body Pattern knob Up and Down to Body Pattern On, Move left recalls previous image, move right recalls next image.</li> <li>• Prev/Next image: Move up and left recall previous image, move down and right recall next image.</li> <li>• None: Activate Body Pattern by press the Body Pattern knob.</li> </ul>
Body Pattern knob: Scan Assistant On	<p>When Scan Assistant is activated,</p> <ul style="list-style-type: none"> <li>• Scan Assistant Control: Navigate Scan Assistant protocol by move Up/Down the Body Pattern knob. Pause/Resume Scan Assistant by move Left/Right the Body Pattern Knob.</li> <li>• None: Activate Body Pattern by press the Body Pattern knob.</li> </ul>

After you change body pattern options, select Save to save the changes.

## Body Pattern Libraries/Applications Preset Menu

The Body Patterns Library/Applications tab is a link to the Applications preset menu. The Body Patterns Applications tab allows you to select body pattern application libraries. You also specify which is the default library that displays when you use body patterns.

The Applications/Body Patterns screen can be accessed through either the Body Pattern Libraries or Applications Touch Panel keys.

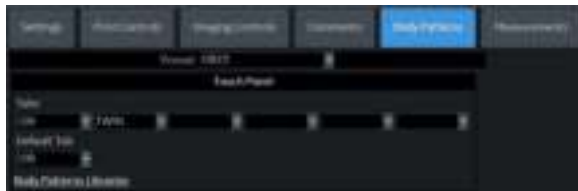

Figure 10-13. Body Patterns Applications Preset Menu

Table 10-63: Applications

Preset Parameter	Description
Preset	Defines the Body Pattern option.
Tabs	A list of body pattern applications.
Default Tab	The default library that the system displays when you use body patterns.

### Selecting body pattern application libraries

1. On the Applications tab, in the Application field, select the body pattern.
2. In the Library Group Tabs fields, select the application libraries for Body Patterns. You can select up to six libraries.
3. In the Default Library Group field, select the default application library you want the system to display when you use body patterns.

**NOTE:** *When you use body patterns, the default library is displayed. To use other application libraries, press the tab for the library.*

4. To save the changes, select the **Save** button.

## Using body pattern application libraries

See the following Body Patterns Small Parts Touch Panel.



Figure 10-14. Body Patterns Small Parts Touch Panel

To select a body pattern library, select the tabs (for example, ABD or OB).

To select body patterns, use the **Ellipse/Body Pattern** control on the Control Panel.



# Application Presets

## **Overview**

Application Presets allow you to configure the application-specific settings (presets).

## Settings

Table 10-64: Preset

Preset Parameter	Description
Preset	Select the application that you want to specify the presets. Along with the various applications available on the system, there are four user-defined application presets that can be set.

Table 10-65: Image Control and Display

Preset Parameter	Description
Show kHz scale	When selected, displays the kHz scale on the left side of the Doppler spectrum.
Show Doppler Rate	When selected, displays the Doppler rate (mm/s) below the Doppler spectrum.
Anatomical Angle Correction	Select to keep the angle constant with regard to the anatomy.
Join Dual Image for Linear	Select to place linear probe dual images directly next to each other.
Hide Mode Cursor Key	Select to unmap (hide) the Mode Cursor key, which normally appears on the left Trackball key during live scanning in B-Mode or Color Flow Modes.
Horizontal Display for Biplane	Display of the two planes of the Biplane probe in a top and bottom layout.

Table 10-66: Auto Zoom Linear Probe Images at Shallow Depth...

Preset Parameter	Description
Check Desired Setting	<ul style="list-style-type: none"> <li>• Single Screen</li> <li>• Dual Screen and DualView</li> <li>• Virtual Convex</li> <li>• B Steer+</li> </ul>

Table 10-67: When Entering Dual Image...

Preset Parameter	Description
Duplicate Frozen Image to Opposite Side	When entering Dual Image, duplicate the frozen image to the opposite side.
Duplicate Live Image to Opposite Side	When entering Dual Image, duplicate the live image to the opposite side.

Table 10-68: Patient Info

Preset Parameter	Description
Titlebar Line 1	Select the patient information to display on the scanning screen Title bar.
Titlebar Line 2	Select the patient information to display on the scanning screen Title bar.

Table 10-68: Patient Info (Continued)

Presets Parameter	Description
Titlebar Line 3	Select the patient information to display on the scanning screen Title bar.

Table 10-69: Comments

Presets Parameter	Description
Active function at Freeze	Select None, Body Pattern, or Comments. If Body Pattern or Comment is selected, the Body Pattern or Comment is activated automatically when freezing the system.
Erase when the image is unfrozen	Select to erase image when system Freeze is deactivated.

Table 10-70: Footswitch

Presets Parameter	Description
Left, Middle, Right	Specify from the following for each footswitch pedal: No Function, Record/Pause, Freeze, Next Heartcycle, Previous Heartcycle, Print 1,2,3,4, Update, Next Step (Scan Assistant), Previous Step (Scan Assistant), Scan Assistant Pause/Resume, or Mark Cine.

Table 10-71: Protocol

Presets Parameter	Description
Show Protocol Tab	Check to display the Protocol Tab on the Touch Panel.
Template	Select the default stress echo template: Bicycle Normal, Bicycle Sporty, Contrast Pharmacological, Pharmacological 4x4, Pharmacological 8x5, Exercise 2x4, Exercise 2x4 B, Pharmacological US 4x4

Table 10-72: ECG

Presets Parameter	Description
Show ECG Tab	Check to display the ECG Tab on the Touch Panel.
ECG Lead	Specify the number of ECG Leads (1, 2, or 3).

Table 10-73: ELASTO

Presets Parameter	Description
Show Quality Bar	Check to display a Quality Bar for Elastography. The more bars, the better the quality. As the quality increases, the bars go from red, to yellow, to green.
Show Quality Graph (restart needed)	Select to display a Quality Graph for Elastography. The higher the level, the higher the data quality for the frames.

Table 10-74: User Label

Preset Parameter	Description
Show Label	If selected, the system displays the User label in the Preview Window at the bottom left portion of the monitor.
Label 1-8	User Labels have eight (8) text lines. Each User Label is limited to 50 characters.

## Print Controls

Table 10-75: Live Store

Preset Parameter	Description
P1, P2, P3, P4, PrintScreen	Select Retrospective Clip (CINE prior to pressing Print), Prospective Clip (CINE after pressing Print), Single Image or None to store from a live image.

Press the “Connectivity/Buttons/Physical Print Buttons” hyperlink to go directly to the Connectivity Print Button Setup page.

Table 10-76: Time-Base Store

Preset Parameter	Description
Time span (s)	Select the number of seconds of CINE Loop storage. The default is 3 seconds.
3D/4D Time span (s)	Select the number of seconds of CINE Loop storage while in 3D/4D.
Contrast Time span (s)	Select the number of seconds of CINE Loop storage while in Contrast.
Preview clip before store	When selected, allows you to review cine loops before storage.
Segment prospective loops longer than time span	Specify length of Clip (15, 30, or 45 seconds, Off, or Max).

Table 10-77: ECG-Based Store

Preset Parameter	Description
Time before heart cycle [ms]	Sets the storage time span before R-wave of the first heart cycle.
Time after heart cycle [ms]	Sets the storage time span after R-wave of the last heart cycle.
Number of heart cycles	Select the number of heart cycles to store. (Must be de-selected for single frame.)
Preview cine clip before store	When selected, allows you to review Cine loops before storage.

Table 10-78: Mark Cine

<b>Preset Parameter</b>	<b>Description</b>
Enable Mark Cine Control	Lets you mark where you want the Cine Loop to start (prospective CINE).
Preview Loop Longer than... (s)	When selected, allows you to review Cine loops before storage for loops longer than selected timeframe (in seconds).

### Imaging Controls

You can select which controls you want to be available via the Touch Panel during a clinical scan. When you select Preset--> Application and Control Mode--> Clinical, deselect the controls you **DO NOT** want to appear while scanning in this clinical application.

**NOTE:** *If you select Research, all controls appear.*



Figure 10-15. Imaging Controls, Research

Clinical vs Research Touch Panel Example. To view all controls press the View All/View Less control (circled).



Figure 10-16. Clinical Control Mode

## Imaging Controls (continued)

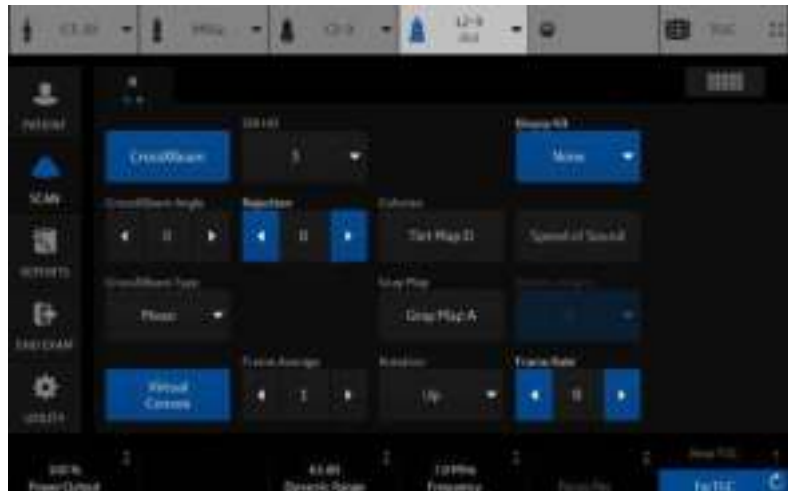

Figure 10-17. Research Control Mode

## Comments and Body Patterns

Comments and Body Patterns were described earlier in this chapter.

## Measurements

You can set the exam category measurement and calculation package you want to appear when you select the exam category Preset.

# User Specific

Refer to “Monitor Display” in Chapter 3 for more information.



# Test Patterns

For more information, see **Test Patterns** in the Wide Monitor section of Chapter 3.

## Overview

3D/4D presets allow you to set up application-specific settings (presets) for each 4D image acquisition type. You can define different application-specific settings for each probe. Refer to Chapter 5 for more information.

## 4D Presets

To set up 4D presets:

1. On the Touch Panel, select **Utility**.
2. On the Touch Panel, select **3D/4D**.  
The system displays the 4D Presets screen.
3. To select a probe, click on the plus sign (+) that appears next to the desired probe.
4. To select the application, click on the plus sign (+) that appears next to the desired application.
5. To select the acquisition type, click on the plus sign (+) that appears next to the desired application.
6. Double-click the desired application under the acquisition type. The Display tab is selected.

## Display Presets Tab

Table 10-79: Image Display

Preset Parameter	Description
Tile	Determines the number of display windows. Values include: 1 (Single), 2 (Dual), and 4 (Quad).
Visualization	Determines the method of display for working with images. Selections available: Sectional, Render, VOCAL, VCI static and TUI.
3D Orientation (degrees)	Determines the orientation of the ROI on the monitor display. Values include: 0, 90, 180, 270.
Zoom Factor	Determines the magnification factor of the zoom. Values include: 0.3 through 4.0, in .01 increments.
Orientation Help	Activate Orientation Help.
Gain	Set the desired Gain.

Table 10-80: Pre-mode ROI

Preset Parameter	Description
ROI Center (cm)	Determines the vertical center of the region of interest. Values vary by probe.
ROI Span (cm)	Determines the height of the region of interest. Values vary by probe.
Tilt (degrees)	Determines the degree of tilt from the vertical center location of the ROI. Values vary by probe.
Width (degrees)	Determines the width of the ROI. Values vary by probe.
Volume Angle	Set the range of the volume sweep. Values vary by probe. Listed in degrees for curved probes, cm for linear probes.

Table 10-81: Quality Setting

Preset Parameter	Description
Setting	Set quality setting -- balances speed with line density. Selections are Low, Mid1, Mid2, Hi1, Hi2, Max. High combines the highest density with the slowest speed. Low combines the lowest density with the highest speed.
CF Setting	Set quality setting -- balances speed with line density. Selections are Low, Mid1, Mid2, Hi1, Hi2. High combines the highest density with the slowest speed. Low combines the lowest density with the highest speed.

## Render Tab

Table 10-82: Render and Render for VCI Static

Preset Parameter	Description
Render Mode 1:Mode2 (Gray Inversion, and VCI Static)	Set render mode values. Surface Smooth, Surface Texture, Transp Max, Transp X-Ray, TransMin (Render 1), or HDlive Texture Surface Smooth, Light, Gradient Light, Transp Max, Transp X-Ray, Transp Min (Render 2), or HDlive Smooth.
Mix/Mix Inversion/eMixVCI Static (% Render Mode 2)	Set mix of Render 1 / Render 2 Mode, 0-100.
Lower Threshold	Set a lower threshold below which weaker echoes are removed, 0-255.
Transparency/ Transparency (Inversion)	Set the transparency of the image, 10/20-250. The higher the number, the more transparent the gray scale information.
Render Direction	Set the direction in which the ROI is viewed.
SonoRenderLive	Check to use SonoRenderLive.
SonoRenderLive Sensitivity	Set the SonoRenderLive sensitivity from 1-100.
[VCI Static] Slice Thickness	Set slice thickness, 2-20.

## Color / PDI Render tab

Table 10-83: Color / PDI Render

Preset Parameter	Description
Render Mode 1 (Color) / Render Mode 2 (Color)	Determine the render mode, selected from Render Mode 1 and Render Mode 2.
Mix (Color)	Set the percentage of Render Mode 1 to be mixed with Render Mode 2.
Lower Threshold (Color)	Set the lower threshold below which weaker echoes are removed.
Transparency (Color)	Determine the transparency of the image. The higher the number, the more transparent the gray scale information. Values: 20 to 255.
Render Gray : Color)	Determine the render mode, selected from Render Mode 1 and Render Mode 2.
Mix (Gray Color)	Set the percentage of Render Mode 1 to be mixed with Render Mode 2.

## VOCAL tab

Table 10-84: VOCAL

Preset Parameter	Description
Vocal Method	Set Sphere, Manual, Contour Detect, or Semi-Auto Contour Detect.
Vocal Semi-Auto-Detect type	Set Hypo, Cystic, or Hyper/Iso.
Vocal Rotation step	Set 6, 9, 15, or 30.

## TUI tab

Table 10-85: TUI

Preset Parameter	Description
Display Format	Set 1x1, 1x2, 2x2, or 3x3.
Total Slices	Set 3, 5, 7, 9, 11, 13, 15, 17, or 19.
Slice Distance (mm)	Set 0.5-40 (0.1 step increments).

## OmniView tab

Table 10-86: OmniView

Preset Parameter	Description
Show OmniView View Direction Marker	Select to view the direction marker in OmniView.

**Advanced tab**

Table 10-87: Advanced

<b>Preset Parameter</b>	<b>Description</b>
Upper Threshold	Sets the higher threshold above which weaker echoes are removed.
Volume Calibration Shift	See a Field Service Engineer for information on this parameter.

# Configuring Connectivity

You use Connectivity functionality to set up the connection and communication protocols for the ultrasound system. The following page gives an overview of each of the Connectivity functions. Each function is described in detail in the following pages.

### Connection Manager

Connection Manager allows configuration of all connectivity functions on the Ultrasound system. Select Connectivity on the Utility Touch Panel page to launch Connection Manager.

If Connectivity was not previously set up on the Ultrasound system, the Scanner page appears when Connectivity is selected.

It is recommended to initially set up each area of Connectivity in the sequence they are listed across the top of the Connection Manager page, from left to right.

Navigate through Connection Manager from left to right by selecting the icons at the top of the screen or by selecting Next or Previous at the bottom of the screen. The recommended setup sequence is:

- 'Scanner Page' on *page 10-63*
- 'Network Page' on *page 10-65*
- 'MyComputer Device Page' on *page 10-72*
- 'Dicom Page' on *page 10-81*
- 'Special Devices Page' on *page 10-92*
- 'Print Button Page' on *page 10-116*
- 'Dataflow Page' on *page 10-119*
- 'Advanced Settings Page' on *page 10-121*

If Connection Manager has previously been set up, the Summary page appears when Connectivity is selected.

Navigate to the desired Connection Manager configuration screens by selecting the icons at the top of the screen or by selecting Next or Previous at the bottom of the screen to advance to through the screens.



## Scanner Page

Use the Scanner page to configure or modify details about the DICOM properties used for the Ultrasound system.

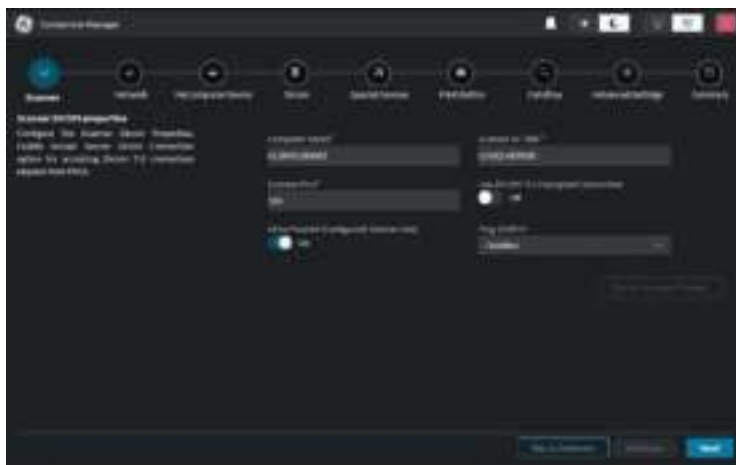

Figure 10-18. Scanner Page

This table shows all the preset parameters available on Scanner with descriptions.

Table 10-88: Scanner Page

Preset Parameter	Description
Computer Name	Enter a name for the Ultrasound system. This may be the same as the station name.
Scanner AE Title	Assign an AE Title to the Ultrasound system. (AE stands for Application Entity. DICOM services use this to identify the Ultrasound system.) AE Title is case-sensitive. This title may contain the Computer Name. Maximum number of characters in AE Title is 16 characters. It is NOT recommended to use the factory default. This is not prohibited, but more than one system with the same AE Title can cause confusion
Scanner Port	If needed, edit the default port number of 104. Restricted port numbers are listed in the user manual.
Allow Trusted (Configured) Devices Only	To prevent unsolicited inbound DICOM conversations, enable Allow Trusted (Configured) Devices Only. When enabled, the Ultrasound system only responds to TCP/IP ping or DICOM Echo from a defined DICOM source IP address. On = Enabled/Off - Disabled
Use DICOM TLS Encrypted Connection	To allow DICOM connectivity to a secure network connection using encryption and certificates using the TLS (transport layer security) protocol, enable Use DICOM TLS Encrypted Connection. Internal communication is still DICOM-structured. On = Allowed/Off = Not allowed

Table 10-88: Scanner Page

Preset Parameter	Description
Ping ICMPV4	To allow the Ultrasound system to respond to a network ping or traceroute command from another device on the network. Disabled = Ultrasound system will not respond to incoming IP ping requests from any remote device LocalSubnet = Ultrasound system responds to all incoming IP ping requests from any remote device that belongs to same local subnet. Any = Ultrasound system responds to all incoming IP ping requests from any remote device.
Discard Scanner Changes	Select to remove any changes made to Scanner.

### Configure Scanner

1. Navigate to **Connectivity > Connection Manager > Scanner**.
2. In **Computer Name**, enter a name for the Ultrasound system.
3. In **Scanner AE Title**, enter an AE Title for the Ultrasound system.
4. In **Scanner Port**, enter a port number for the Ultrasound system. The default port number is 104.
5. To allow DICOM connectivity to a secure network connection using encryption and certificates using the TLS (transport layer security) protocol, enable **Use DICOM TLS Encrypted Connection**.
6. To prevent unsolicited inbound DICOM conversations, enable **Allow Trusted (Configured) Devices Only**.
7. Under **Ping ICMPV4**, select to allow the Ultrasound system to respond to a network ping or traceroute command from another device on the network. Select Disabled if you do not want the Ultrasound system to respond to incoming IP ping requests from any remote device

## Network Page

Use the Network page to configure or modify network properties for the Ultrasound system.



Figure 10-19. Network Page

Refer to the following sections for more information:

- *'General' on page 10-66*
- *'Wired' on page 10-67*
- *'Wireless' on page 10-68*
- *'Proxy' on page 10-70*

### General

Use Scanner Network Properties - General to configure the protocol setting.

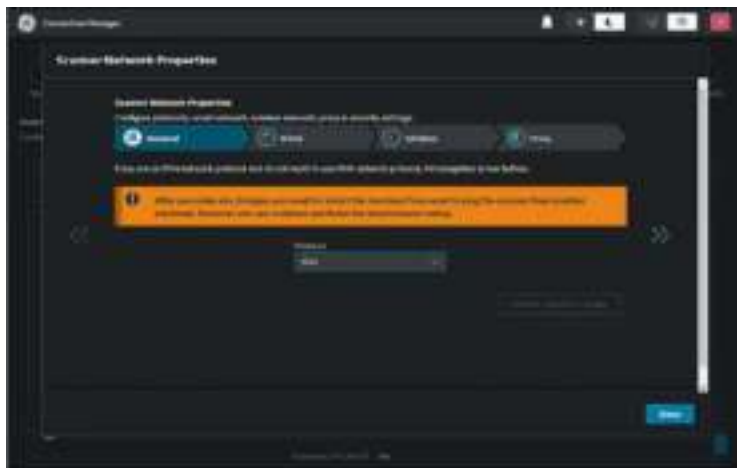

Figure 10-20. Scanner Network Properties - General

This table shows all the preset parameters available on Scanner Network Properties - General with descriptions.

Table 10-89: Scanner Network Properties - General

Preset Parameter	Description
Protocol	Select either the IPV4 or IPV6 static IP setting.

#### Add Scanner Network Properties - General

1. Navigate to **Connectivity > Connection Manager > Network**.
2. Select **General**.
3. Under **Protocol**, select either the IPV4 or IPV6 static IP setting.
4. Select **Done**.

**Wired**

Use Scanner Network Properties - Wired to configure the local area network settings.



Figure 10-21. Scanner Network Properties - Wired

This table shows all the preset parameters available on Scanner Network Properties - Wired with descriptions

Table 10-90: Scanner Network Properties - Wireless

Preset Parameter	Description
Automatic IP (DHCP)	Enable to automatically configure your wired network settings. On = Enabled/Off - Disabled
Network Speed	Select the network speed (Auto Detect, 10Mbps/Half/Full Duplex, or 100 Mbps/Half/Full Duplex, and 1000Mbps/Auto-negotiate).
Network adapter details	Displays the actual network configuration the Ultrasound system is currently using and has recognized.

**Add Scanner Network Properties - Wired**

1. Navigate to **Connectivity > Connection Manager > Network**.
2. Select **Wired**.
3. To automatically configure your wired network settings, enable **Automatic IP (DHCP)**.
4. Under **Network Speed**, select the network speed.
5. Select **Done**.

## Wireless

Use Scanner Network Properties - Wired to configure the local area network settings.



Figure 10-22. Scanner Network Properties - Wireless

This table shows all the preset parameters available on Scanner Network Properties

Table 10-91: Scanner Network Properties - Wireless

Preset Parameter	Description
Wireless Network Name	Name used for the wireless network.
IP Address	IP Address of the Ultrasound system. IP stands for Internet Protocol. Every device on the network has a unique IP address.
Default Gateway	Default gateway address (optional).
Subnet Mask	IP address filter that eliminates communication/messages from network devices of no interest to your system
Primary DNS Server	IP address for the primary DNS server (optional - at least one valid DNS address is needed for Insite remote service connectivity).
Secondary DNS Server	IP address for the secondary DNS server (optional). Do not configure Secondary DNS server only; if only one DNS IP address is being used, enter it in the Primary DNS Server field.
MAC Address	Unique network card address.
Speed (Mbps)	Actual network speed in Megabits per second.
Connected (min)	Number of minutes the Ultrasound system has been connected to the network.

Table 10-91: Scanner Network Properties - Wireless

Preset Parameter	Description
Connection Status	Current network status. <ul style="list-style-type: none"> <li>• Operational: Network adapter has been disabled, for example because of an address conflict.</li> <li>• Unreachable: Network adapter that is not connected.</li> <li>• Disconnected: For LAN adapters: network cable disconnected. For WLAN adapters: no carrier.</li> <li>• Connecting: Network adapter that is in the process of connecting.</li> <li>• Connected: Network adapter that is connected to a remote peer.</li> </ul>
Configure wireless network	Select to display the Wireless Network Configuration page.

**Add Scanner Network Properties - Wireless**

1. Navigate to **Connectivity > Connection Manager > Network**.
2. Select **Wireless**.
3. Select **Configure Wireless Network**.
4. On the Wireless Network Configuration dialog box, select the wireless connection and select **Connect**.
5. When prompted, enter the new wireless network properties.
6. Select **Done**.

## Proxy

Use Scanner Network Properties - Proxy to configure a proxy server.



Figure 10-23. Scanner Network Properties - Proxy

This table shows all the preset parameters available on Scanner Network Properties - Proxy with descriptions.

Table 10-92: Scanner Network Properties - Proxy

Preset Parameter	Description
Use Proxy	Enable to use a proxy server. On = Enabled/Off = Disabled
Proxy Server	When Use Proxy is enabled, enter a proxy server address of the facility.
Proxy Port	When Use Proxy is enabled, enter a port number for the proxy server.
Proxy Credentials	Enable to use credentials for a proxy server. On = Enabled/Off = Disabled
Proxy User Name	When Proxy Credentials is enabled, enter an account user name for the proxy server.
Proxy Password	When Proxy Credentials is enabled, enter an account password for the proxy server.
Discard Proxy Changes	Select to remove any changes made to Scanner Network Properties - Proxy.



## **Add Scanner Network Properties - Proxy**

1. Navigate to **Connectivity > Connection Manager > Network**.
2. Select **Proxy**.
3. To use a proxy server, enable **Use Proxy**.
4. When Use Proxy is enabled, in **Proxy Server**, enter a proxy server address of the facility.
5. When Use Proxy is enabled, in **Proxy Port**, enter a port number for the proxy server.
6. To use proxy credentials, enable **Use Proxy Credentials**.
7. When Use Proxy Credentials is enabled, in **Proxy User Name**, enter an account user name for the proxy server.
8. When Use Proxy Credentials is enabled, in **Proxy Password**, enter an account password for the proxy server.
9. Select **Done**.

### MyComputer Device Page

Use the MyComputer Device page to configure or modify details about the Ultrasound system.

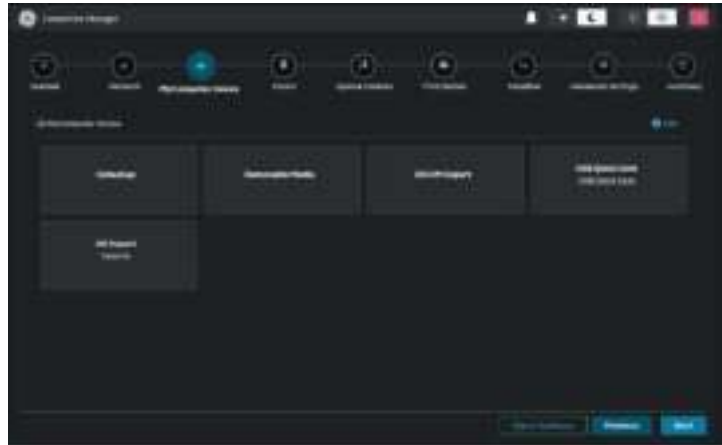

Figure 10-24. MyComputer Device Page

Refer to the following sections for more information:

- *'EzBackup' on page 10-73*
- *'Removable Media' on page 10-75*
- *'DICOM Export' on page 10-77*
- *'USB Quick Save' on page 10-79*
- *'HD Export' on page 10-80*

## EzBackup

Use EzBackup to manage hard disk space while maintaining the patient database on the Ultrasound system and back up the patient database and images by copying the data from the local drive to removable media.



Figure 10-25. Edit EzBackup

This table shows all the preset parameters available on Edit EzBackup with descriptions.

Table 10-93: Edit EzBackup

Preset Parameter	Description
Name	Logical name of the service.
Convert Clips	When enabled, the raw cine clips get converted to DICOM multi-frames during EzBackup operation. On = Enabled/Off = Disabled
Convert Volumes	When enabled, the raw volumes get converted to Enhanced US Volume (DICOM 3D) format during EzBackup operation. On = Enabled/Off = Disabled
Apply Display Precision to Measurements	When enabled, the measurement values are rounded to configured number of decimal places. On = Enabled/Off = Disabled
Dicom Coding Scheme	Measurements are encoded with configured coding scheme in DICOM SR objects.
Use Button Settings	When enabled, uses button settings. On = Enabled. The Ultrasound system will use the default image storage and compression presets./Off = Disabled. Properties menu expands and image storage and compression presets can be defined.

### Add EzBackup

1. Navigate to **Connectivity > Connection Manager > MyComputer Device**.
2. Select **EzBackup > Configure**
3. In **Name**, enter a logical name of the service.
4. To have raw cine clips converted to DICOM multi-frames during EzBackup operation, enable **Convert Clips**.
5. To have raw volumes get converted to Enhanced US Volume (DICOM 3D) format during EzBackup operation, enable **Convert Volumes**.
6. To round measurement values to configured number of decimal places, enable **Apply Display Precision to Measurements**.
7. Under **Dicom Coding Scheme**, select how measurements are encoded with configured coding scheme in DICOM SR objects.
8. To use button settings, enable **Use Button Settings**.
9. Select **Done**.

## Removable Media

Use Removable Media to do the following:

- Verify the DICOM directory on removable media.
- Verify the free space of the media.
- Verify that the media is finalized or unfinalized.
- Verify that the media is formatted or unformatted.
- Format removable media (rewritable CD/DVD or USB device).



Figure 10-26. Edit Removable Media

This table shows all the preset parameters available on Edit Removable Media with descriptions.

Table 10-94: Edit Removable Media

Preset Parameter	Description
Removable Media	Select the removable media to format or verify.
Label	Type a label for a new removable media (free text).
SetLabel	When text has been entered under Label, select to set the text.
Format	Select to format the media. New media should always be formatted.
Media Properties	Shows properties for the configured media.
Done	Select to save the removable media settings.

### Add Removable Media

1. Navigate to **Connectivity > Connection Manager > MyComputer Device**.
2. Select **Removable Media > Configure**.
3. Under **Removable Media**, select the removable media to format or verify.
4. Under **Label**, enter a label for a new removable media (free text).
5. If you entered a label, select **SetLabel**.
6. Select **Format** to format the removable media.
7. Select **Done**.

## DICOM Export

Use DICOM Export to export DICOM content in either .mp4 and .avi formats.

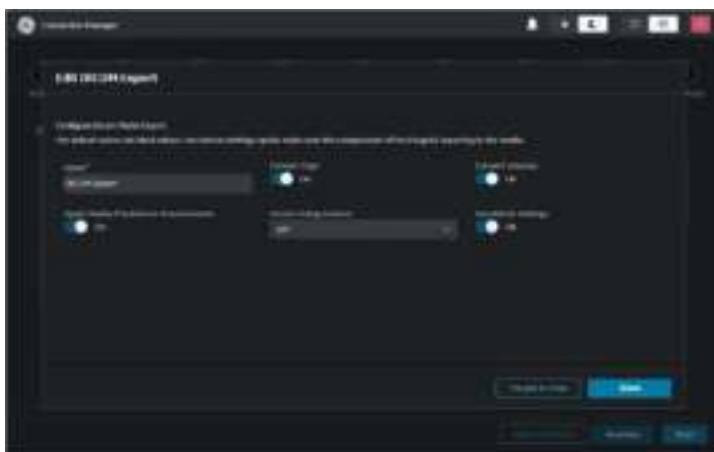

Figure 10-27. Edit DICOM Export

This table shows all the preset parameters available on Edit DICOM Export with descriptions.

Table 10-95: Edit DICOM Export

Preset Parameter	Description
Name	Logical name of the service.
Convert Clips	When enabled, the raw cine clips get converted to DICOM multi-frames during DICOM Export operation. On = Enabled/Off = Disabled
Convert Volumes	When enabled, the raw volumes get converted to Enhanced US Volume (DICOM 3D) format during DICOM Export operation. On = Enabled/Off = Disabled
Apply Display Precision to Measurements	When enabled, the measurement values are rounded to configured number of decimal places. On = Enabled/Off = Disabled
Dicom Coding Scheme	Measurements are encoded with configured coding scheme in DICOM SR objects.
Use Button Settings	When enabled, uses button settings. On = Enabled. The Ultrasound system will use the default image storage and compression presets./Off = Disabled. Properties menu expands and image storage and compression presets can be defined.

### Add DICOM Export

1. Navigate to **Connectivity > Connection Manager > MyComputer Device**.
2. Select **DICOM Export > Configure**.
3. In **Name**, enter a logical name of the service.
4. To have raw cine clips converted to DICOM multi-frames during EzBackup operation, enable **Convert Clips**.
5. To have raw volumes get converted to Enhanced US Volume (DICOM 3D) format during EzBackup operation, enable **Convert Volumes**.
6. To round measurement values to configured number of decimal places, enable **Apply Display Precision to Measurements**.
7. Under **Dicom Coding Scheme**, select how measurements are encoded with configured coding scheme in DICOM SR objects.
8. To use button settings, enable **Use Button Settings**.
9. Select **Done**.



## USB Quick Save

Use USB Quick Save to save images or video clips to a USB flash drive with a print button. The images are stored in either .jpg or .wmv formats.

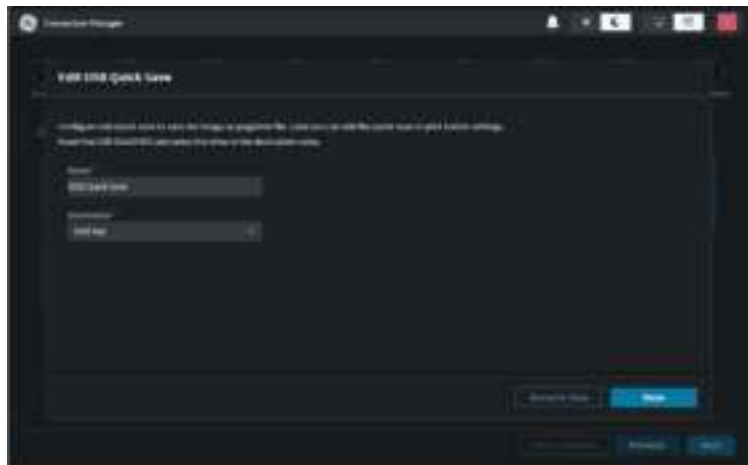

Figure 10-28. Edit USB Quick Save

This table shows all the preset parameters available on Edit USB Quick Save with descriptions.

Table 10-96: Edit USB Quick Save

Preset Parameter	Description
Name	Logical name of the service.
Destination	Destination device for the service.

### Add USB Quick Save

1. Navigate to **Connectivity > Connection Manager > MyComputer Device**.
2. Select **USB Quick Save > Configure**.
3. In **Name**, enter a logical name of the service.
4. Under **Destination**, enter a destination device for the service.
5. Select **Done**.

### HD Export

Use HD Export to save images or video clips to a USB flash drive or HD media with a print button. The images are stored in DICOM format.



Figure 10-29. Edit HD Export

This table shows all the preset parameters available on Edit HD Export with descriptions.

Table 10-97: Edit HD Export

Preset Parameter	Description
Name	Logical name of the service.
Destination	Destination device for the service

### Add HD Export

1. Navigate to **Connectivity > Connection Manager > MyComputer Device**.
2. Select **HD Export > Configure**.
3. In **Name**, enter a logical name of the service.
4. Under **Destination**, enter a destination device for the service.
5. Select **Done**.

## Dicom Page

Use the Dicom page to add a Dicom device and then add one or more Dicom services to that device.



Figure 10-30. Dicom Page

This table shows all the preset parameters available on Dicom with descriptions.

Table 10-98: Dicom Page

Preset Parameter	Description
System Information	Information settings for the Ultrasound system.
Enable Dicom Verbose Logging	When enabled, DICOM traffic messages are logged to protected logs. The default time limit is set for 5 minutes. On = Enabled/ Off = Disabled
Devices	List of created devices.
Show special Dicom devices	When enabled, displays special dicom devices. By default, special dicom devices are hidden. When special devices (for example, Koios and Tricefy) are activated, the Ultrasound system automatically creates special dicom devices on the DICOM page.
Add Dicom Device	Select to add a new Dicom device.
Services	List of created services.
Add Dicom Service	Select to add a new Dicom service.

Refer to the following sections for more information:

- *'Add Dicom Device' on page 10-82*
- *'Add Dicom Service' on page 10-84*

## Add Dicom Device

Use Add Dicom Device to add a destination device (printer, worklist server, etc.) to the Ultrasound system.

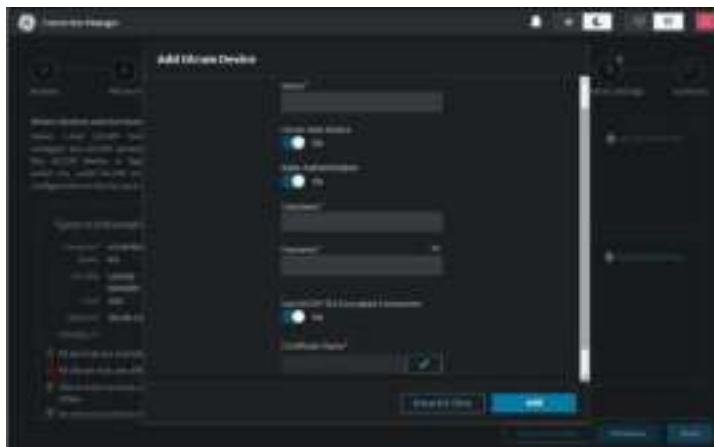

Figure 10-31. Add Dicom Device (with Dicom Web Device On)

This table shows all the preset parameters available on Add Dicom Device with descriptions.

Table 10-99: Add Dicom Device

Preset Parameter	Description
Name	Name for the DICOM device.
Dicom Web Device	Determines whether the device is a web device. On = Enabled/ Off = Disabled
Basic Authentication	When Dicom Web Device is enabled, determines whether basic authentication is used for the device. On = Enabled/ Off = Disabled
Username	Username used when Basic Authentication is enabled.
Password	Password used when Basic Authentication is enabled.
IP Address	When Dicom Web Device is Off, IP address for the device. IP stands for Internet Protocol. Every device on the network has a unique IP address.
Use DICOM TLS Encrypted Connection	When enabled, the Ultrasound system communicates securely with all the configured services for that device with secure communication by encrypting the DICOM objects during transfer through TLS1.2 protocol. On = Enabled/ Off = Disabled
Certificate Name	When Use DICOM TLS Encrypted Connection is enabled, name of imported certificate.

Table 10-99: Add Dicom Device

Preset Parameter	Description
Ping Status	When Dicom Web Device is Off, indicates whether a ping to the device is allowed.
Ping	When Dicom Web Device is Off, select to confirm that the device is connected.
Add	Select to add the DICOM device.
Discard and Close	Select to discard any changes you have made and to close the dialog box.

### Add a Dicom device

1. Navigate to **Connectivity > Connection Manager > Dicom.**
2. To display special Dicom devices, enable **Show special Dicom devices.**
3. Select **Add Dicom Device.**

*NOTE:* To edit an existing device, select the **Edit** for the device.

4. In **Name**, enter a name for the Dicom device.
5. To add a device (not a web device), set **Dicom Web Device** to Off.
6. In **IP Address**, enter an IP address for the device.
7. If **Use DICOM TLS Encrypted Connection** is On, select the pencil icon to display the TLS Encrypted Configuration dialog box to add a certificate.
8. Select **Add.**

### Add a Dicom Web device

1. Navigate to **Connectivity > Connection Manager > Dicom.**
2. To display special Dicom devices, enable **Show special Dicom devices.**
3. Select **Add Dicom Device.**

*NOTE:* To edit an existing device, select **Edit** for the device.

4. In **Name**, enter a name for the Dicom device.
5. To add a web device, set **Dicom Web Device** to On.
6. If Basic Authentication is On, enter a **Username** and **Password.**
7. If **Use DICOM TLS Encrypted Connection** is On, select the pencil icon to display the TLS Encrypted Configuration dialog box to add a certificate.
8. Select **Add.**

### Add Dicom Service

For each added device, set up the service(s) that the device supports (you must be an administrator to update these screens).

Use Add Dicom Service to set the properties for the service. The name and properties in this section change, depending on what service is currently selected.



Figure 10-32. Add Dicom Service

Refer to the following sections for more information:

- *'Add Dicom Service - Service' on page 10-85*
- *'Add Dicom Service - Connection' on page 10-86*
- *'Add Dicom Service - Content' on page 10-87*
- *'Add Dicom Service - Compression' on page 10-89*
- *'Add Dicom Service - Summary' on page 10-90*

## Add Dicom Service - Service

Use Add Dicom Service - Service to set the properties for the service. The name and properties in this section change, depending on what service is currently selected.

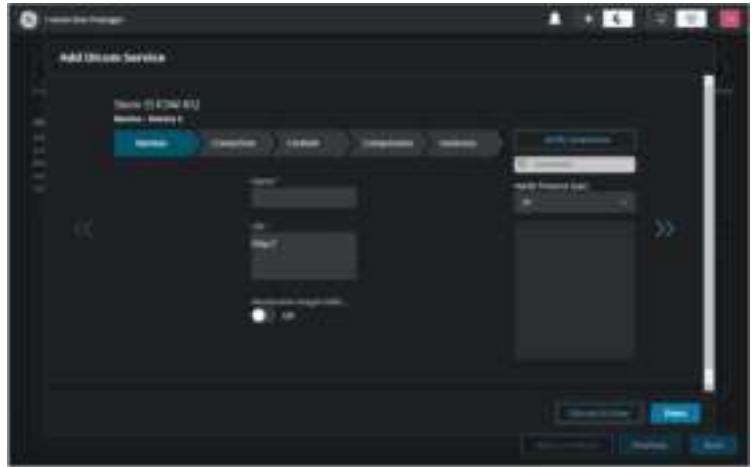

Figure 10-33. Add Dicom Service - Service

This table shows all the preset parameters available on Add Dicom Service - Service with descriptions.

Table 10-100: Add Dicom Service - Service

Preset Parameter	Description
Name	Descriptive name for the service.
URL	URL for the service
Anonymize images Before	When enabled, anonymizes patient data. On = Enabled/ Off = Disabled

## Add Dicom Service - Connection

Use Add Dicom Service - Connection to set the properties for the service. The name and properties in this section change, depending on what service is currently selected.



Figure 10-34. Add Dicom Service - Connection

This table shows all the preset parameters available on Add Dicom Service - Connection with descriptions.

Table 10-101: Add Dicom Service - Connection

Preset Parameter	Description
Maximum Retries	Maximum number of times to try establishing a connection to the service.
Retry Interval (sec)	Specify how often (in seconds) the Ultrasound system should try to establish a connection to the service.
Transmission Timeout (sec)	Specify the amount of time (in seconds) after which the Ultrasound system will stop trying to establish a connection to the service.



## Add Dicom Service - Content

Use Add Dicom Service - Content to set the properties for the service. The name and properties in this section change, depending on what service is currently selected.



Figure 10-35. Add Dicom Service - Content

This table shows all the preset parameters available on Add Dicom Service - Content with descriptions

Table 10-102: Add Dicom Service - Content

Preset Parameter	Description
Color Support	Select Mixed or Color. Best performance when set to Color.
Allow Raw Data	Select to save data in both TruAccess (raw data) and DICOM format. Clear to save in DICOM format only.
Allow Clips	Select to allow cine loop storage. Deselect to send only Stills to PACS.
Allow Enhanced DICOM Objects	Select to allow enhanced DICOM objects.
Key Image Notes	Image deletion notification. ONLY available for the Direct Store Workflow and ONLY generated when there are images deleted during the exam. Selecting this lets the reader at the PACS system know which images have been deleted. An indicator is placed on deleted images with a reason, "Rejected for Quality Reasons" for example.
Enable Structured Reporting	Select for Structured Reporting.
Dicom Coding Scheme	

Table 10-102: Add Dicom Service - Content

<b>Preset Parameter</b>	<b>Description</b>
Apply Display Precision to Measurements	When Enable Structured Reporting is selected, Apply Display Precision to Measurements is available; select to apply the same precision for a Structured Report that is used on the scanner display. (Apply Display Precision to Measurements is always available for a DICOM SR Storage service.)

## Add Dicom Service - Compression

Use Add Dicom Service - Compression to set the properties for the service. The name and properties in this section change, depending on what service is currently selected.



Figure 10-36. Add Dicom Service - Compression

This table shows all the preset parameters available on Add Dicom Service - Compression with descriptions.

Table 10-103: Add Dicom Service - Compression

Preset Parameter	Description
Use Button Settings	If “Use Button Settings” is checked, the system will use the default system image storage and compression presets. If “Use Button Settings” is unchecked, the Properties menu expands and the user can define the image storage and compression presets as desired.

## Add Dicom Service - Summary

Use Add Dicom Service - Summary to set the properties for the service. The name and properties in this section change, depending on what service is currently selected.



Figure 10-37. Add Dicom Service - Summary

This table shows all the preset parameters available on Add Dicom Service - Summary with descriptions.

Table 10-104: Add Dicom Service - Summary

Preset Parameter	Description
Service	Summary of the service settings for the service. See <i>'Add Dicom Service - Service'</i> on page 10-85
Connection	Summary of the connection settings for the service. See <i>'Add Dicom Service - Connection'</i> on page 10-86
Content	Summary of the content settings for the service. See <i>'Add Dicom Service - Content'</i> on page 10-87
Compression	Summary of the compression settings for the service. See <i>'Add Dicom Service - Compression'</i> on page 10-89
Verify Connection	Checks the connection status with the server and the compatibility with the PACS device.
Verify Timeout	Amount of time after which the system will stop trying to establish a connection to the service.

## Add a Dicom service

1. Navigate to **Connectivity > Connection Manager > Dicom**.
2. Do one of the following:
  - a. If the service is already displayed in Services, select **Edit** for the service.
  - b. If the service is not displayed in Services, select **Add Dicom Service**.
  - c. Select **Service** and then configure the fields on the page.
  - d. Select **Connection** and then configure the fields on the page.
  - e. Select **Content** and then configure the fields on the page.
  - f. Select **Compression** and then configure the fields on the page.
  - g. Select **Summary** to review the settings.
  - h. Select **Done**.

### Special Devices Page

Use the Special Devices page to configure or modify details about the special devices used with the Ultrasound system.

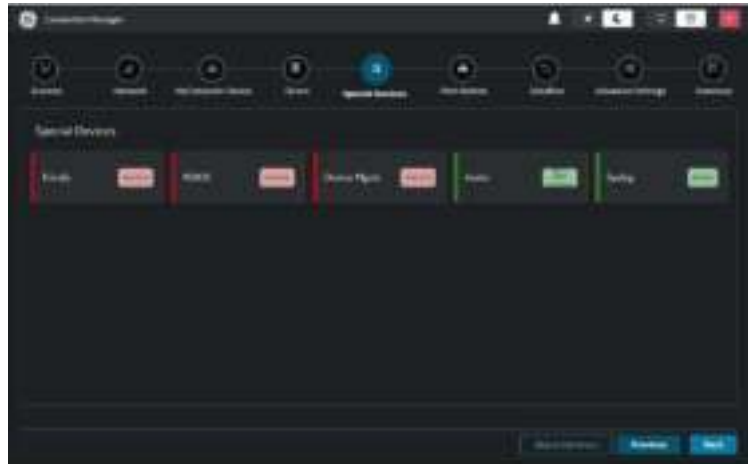

Figure 10-38. Special Devices Page

Refer to the following sections for more information:

- *'Tricefy' on page 10-93*
- *'KOIOS' on page 10-95*
- *'Device Mgmt' on page 10-103*
- *'Insite' on page 10-105*
- *'Syslog' on page 10-109*
- *'Data Streaming' on page 10-112*
- *'Vscan Air' on page 10-114*

## Tricefy

Tricefy is a cloud-based image viewer and a platform to archive, collaborate, and share. The corresponding DICOM destinations can be used through the Print keys. An internet connection is necessary for uploading data to Tricefy. DICOM connectivity to the optional Tricefy Cloud PACS system occurs over a proprietary protocol protected by TLS/HTTPS encryption, although the internal communication is still DICOM-structured.

As soon as the Tricefy option is enabled, relevant Tricefy items are displayed.



Figure 10-39. Tricefy Page

This table shows all the preset parameters available on Configure Special Devices - Tricefy with descriptions.

Table 10-105: Configure Special Devices - Tricefy

Preset Parameter	Description
Account Email	Email address for the Tricefy account.
Account Name	Name for the Tricefy account.
Customer Name	Name for the customer on the Tricefy account.
Uplink ID	Uplink ID for the Tricefy account.
Account Status	Status of the Tricefy account.
Activate	Select to activate the Tricefy option.
Discard Tricefy Changes	Select to remove any changes made to the Tricefy settings.

### Configure Tricefy

1. Navigate to **Connectivity > Connection Manager > Special Devices**.
2. Select **Tricefy**.
3. Configure the fields on the page.
4. Select **Activate**.
5. Select **Done**.



## KOIOS

Koios DS is a Breast and Thyroid Analysis Option. Koios DS is integrated with the system via DICOM and is configured similar to a DICOM Service. The user can accept/dismiss analysis results. If accepted, these results are included in the DICOM Structured Report.



Figure 10-40. KOIOS Page

This table shows all the preset parameters available on Configure Special Devices - KOIOS with descriptions.

Table 10-106: Configure Special Devices - KOIOS

Preset Parameter	Description
IP Address	IP address for the Koios DS server.
Account Status	Status of the Koios DS account. Active or inactive.
Activate	Select to receive notification that you have successfully connected to the Koios DS server and the required device, service, and printflows will be automatically created.

Refer to the following sections for more information:

- *'KOIOS DS Breast' on page 10-96*
- *'KOIOS DS Breast - Results Dialog' on page 10-97*
- *'KOIOS DS Breast - Assessment Menu' on page 10-98*
- *'KOIOS DS Breast - Summary' on page 10-99*
- *'KOIOS DS Thyroid - Results Dialog' on page 10-100*
- *'Accept Key' on page 10-101*
- *'Review Key' on page 10-102*

**KOIOS DS Breast**

Use Scanner Network Properties - General to configure the protocol setting.



Figure 10-41. KOIOS Page - KOIOS DS Breast

This table shows all the preset parameters available on KOIOS DS Breast with descriptions.

Table 10-107: KOIOS Page - KOIOS DS Breast

Preset Parameter	Description
Lesion Classification System	Select BI-RADS or U1-U5.
Include Result in DICOM SR	Select to save Koios Breast results to Structured Reporting.

## KOIOS DS Breast - Results Dialog



Figure 10-42. KOIOS Page - KOIOS DS Breast Results Dialog

This table shows all the preset parameters available on KOIOS DS Breast Results Dialog with descriptions.

Table 10-108: KOIOS Page - KOIOS DS Breast Results Dialog

Preset Parameter	Description
Show Classification Name	Select to show classification name.
Show Banner in Color	Select to show banner in color.

## KOIOS DS Breast - Assessment Menu



Figure 10-43. KOIOS DS Breast - Assessment Menu

This table shows all the preset parameters available on KOIOS DS Breast - Assessment Menu with descriptions.

Table 10-109: KOIOS DS Breast - Assessment Menu

Preset Parameter	Description
Show Classification Name	Select to show classification name.
Show Banner in Color	Select to show banner in color.

## KOIOS DS Breast - Summary



Figure 10-44. KOIOS DS Breast - Summary

This table shows all the preset parameters available on KOIOS DS Breast - Summary with descriptions.

Table 10-110: KOIOS DS Breast - Summary

Preset Parameter	Description
Show Classification Name	Select to show classification name.
Show Banner in Color	Select to show banner in color.

## KOIOS DS Thyroid - Results Dialog



Figure 10-45. KOIOS DS Thyroid - Results Dialog

This table shows all the preset parameters available on KOIOS DS Thyroid - Results Dialog with descriptions.

Table 10-111: KOIOS DS Thyroid - Results Dialog

Preset Parameter	Description
Show Classification Name	Select to show classification name.
Show Banner in Color	Select to show banner in color.
Show Recommendation	Select to show recommendation

## Accept Key



Figure 10-46. KOIOS Page - Accept Key

This table shows all the preset parameters available on KOIOS Page - Accept Key with descriptions.

Table 10-112: KOIOS Page - Accept Key

Preset Parameter	Description
Display Key	Select to display this key in the Results dialog.
Save Image for Off Scanner Koios Analysis	Select to save the image sent to Koios in the exam for off scanner analysis.
Save Descriptors to Exam	Select to save Descriptors from Koios Analysis to the exam.
Save Koios Analysis to Exam	Select to save Koios Analysis result to the exam.

## Review Key



Figure 10-47. KOIOS Page - Review Key

This table shows all the preset parameters available on KOIOS Page - Review Key with descriptions.

Table 10-113: KOIOS Page - Review Key

Preset Parameter	Description
Display Key	Select to display this key in the Results dialog.
Save Image for Off Scanner Koios Analysis	Select to save the image sent to Koios in the exam for off scanner analysis.
Save Descriptors to Exam	Select to save Descriptors from Koios Analysis to the exam.
Save Koios Analysis to Exam	Select to save Koios Analysis result to the exam.

### Configure KOIOS

1. Navigate to **Connectivity > Connection Manager > Special Devices**.
2. Select **KOIOS**.
3. Configure the fields on the page.
4. Select **Activate**.
5. Select **Done**.



## Device Mgmt

Device Mgmt is a remote device management tool that enables bi-directional management capabilities on the device. Device Mgmt allows Cloud management of system preset configurations to a fleet of systems on network, as well as one to one system preset configuration Cloud backup and restore.

**NOTE:** For Cloud operation please refer to Device Mgmt online user manual after sign-up at <http://AVURI.gehealthcare.com/signup>



Figure 10-48. Device Mgmt Page

This table shows all the preset parameters available on Configure Special Devices - Device Mgmt with descriptions.

Table 10-114: Configure Special Devices - Device Mgmt

Preset Parameter	Description
Account Email	Email address for the Device Management account.
Account Status	Indicates whether Device Management is active or not. Valid values are Inactive or Active. This field will be Inactive after activation has failed. Otherwise, the field will be empty. If you never activated or activated and then deactivated, this field will be empty
Server Information	When enabled, displays the server information for the Device Management account. On = Enabled/Off = Disabled
Registration Key	Registration key for the Device Management account. Product specific key strings, pre-populated by the device (can be overwritten if necessary).
Server URL	URL of registration server strings, pre-populated by the device (can be overwritten if necessary).
Use Proxy	Enable to use a proxy server. On = Enabled/Off = Disabled

Table 10-114: Configure Special Devices - Device Mgmt

Preset Parameter	Description
Use System Proxy	When selected, uses the proxy settings configured under the Network page > Proxy tab.
Proxy Server	Name of the proxy server IP provided by the customer. This field is optional unless required by the customer facility infrastructure.
Proxy Port	Number of the proxy server port provided by the customer. This field is optional unless required by the customer facility infrastructure.
Proxy Credentials	Enable to use credentials for a proxy server. On = Enabled/Off = Disabled
Proxy User Name	Name of the proxy user provided by the customer. This field is optional unless required by the customer facility infrastructure.
Proxy Password	Password for the proxy user name provided by the customer. This field is optional unless required by the customer facility infrastructure.
Activate	Select to activate/deactivate Device Management.
Service Certificate	Select to download the certificate for Device Management from the backoffice server.
Remove Registration	Select to remove registration for Device Management from the backoffice server.

### Configure Device Mgmt

1. Navigate to **Connectivity > Connection Manager > Special Devices**.
2. Select **Device Mgmt**.
3. Configure the fields on the page.
4. Select **Activate**.
5. Select **Done**.

Insite



Figure 10-49. Configure Special Devices - Insite

This table shows all the preset parameters available on Configure Special Devices - Insite with descriptions.

Table 10-115: Configure Special Devices - Insite

Preset Parameter	Description
Serial Number	Serial number of the agent (read-only). If the agent is not registered with a serial number, this field is populated with the serial number of the Ultrasound system. The serial number of the agent is tied to the serial number of the Ultrasound system.
Agent Model Number	GE part number for the Ultrasound system. The same number as listed on the rating plate.
CRM No	Customer Relationship Management (CRM) number. System identifier assigned to the customer unit by the service region. This number must match the System ID loaded in Siebel CRM and the GE CARES sticker.
Display Name	Displayed name of the agent.
Agent Version	When Agent Connected is Yes, version of the RsVP Agent that is installed on the machine which facilitates the connectivity to the backoffice.

Autoconnect

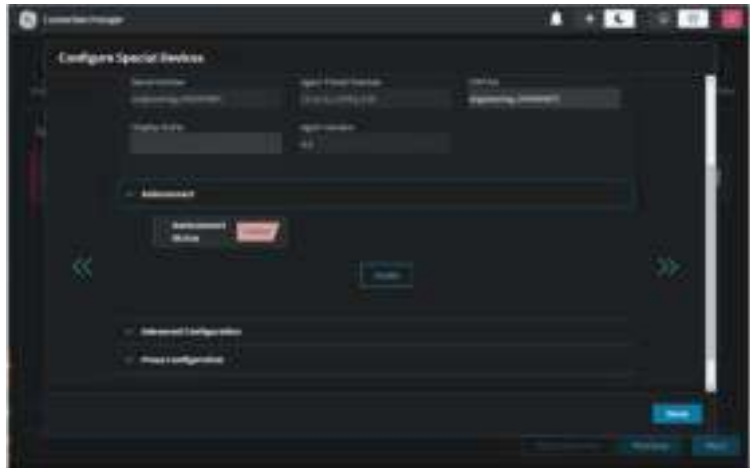

Figure 10-50. Insite Page - Autoconnect

This table shows all the preset parameters available on Autoconnect with descriptions.

Table 10-116: Insite Page - Autoconnect

Preset Parameter	Description
Autoconnect Status	Indicates whether Autoconnect to Insite is enabled or disabled.
Enable/Disable	Select to enable or disable Autoconnect to Insite.



**WARNING**

Please note that this device is configured to automatically enable InSite connection to GE HealthCare. For any installations where remote connections are not approved, please disable InSite connection.

Advanced Configuration

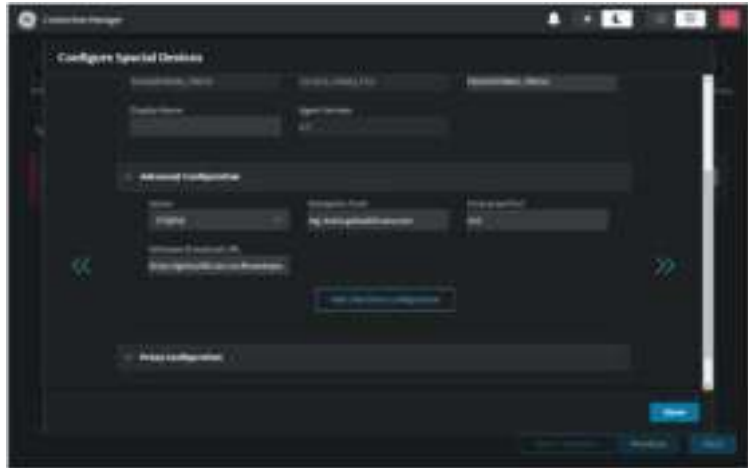

Figure 10-51. Insite Page - Advanced Configuration

This table shows all the preset parameters available on Advanced Configuration with descriptions.

Table 10-117: Insite Page - Advanced Configuration

Preset Parameter	Description
Server	Name of the enterprise server. This field should be normally set to Production for USCAN customers. Valid values are: <ul style="list-style-type: none"> <li>• Production - Use to configure an enterprise server for USCAN.</li> <li>• Production-EU - Use to configure an enterprise server for Europe.</li> <li>• CURRENT - Use to configure an enterprise server. CURRENT will be available after configuring a server with the Others selection.</li> <li>• Others - Use to configure a staging server. Select Others, add the server url (stginsite.healthcare.ge.com) and port (443). Do not use the IP address of the enterprise server using the Others selection as Windows 10 has removed the ability to bypass a certificate error that occurs when using the IP address. This error can block connectivity.</li> </ul>
Enable/Disable	Name of the enterprise host. This field should be normally set to insite.gehealthcare.com.
Enterprise Port	Number of the enterprise port. This field should be normally set to 443.
Software Download URL	Address where software will be downloaded from to the Ultrasound system.
Add Enterprise Configuration	Use as an alternative option to add an enterprise server. Once you use Add Enterprise Configuration to add an enterprise server, that enterprise server will be listed under Server. Add Enterprise Configuration can be used instead of Others.

## Proxy Configuration

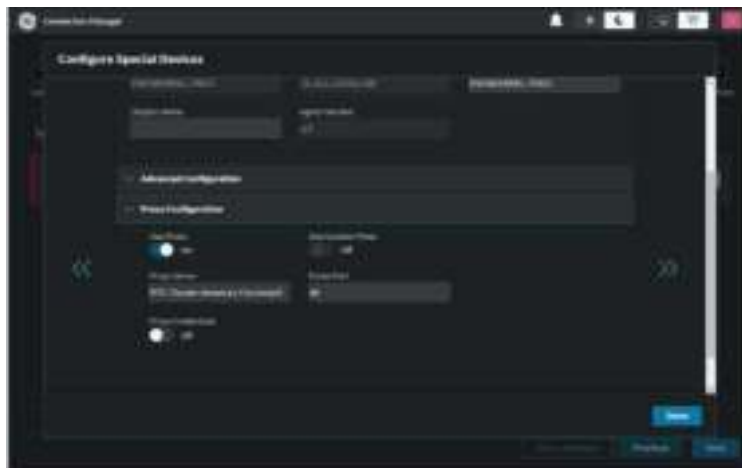

Figure 10-52. Insite Page - Proxy Configuration

This table shows all the preset parameters available on Proxy Configuration with descriptions.

Table 10-118: Insite Page - Proxy Configuration

Preset Parameter	Description
Use Proxy	Enable to use a proxy server. On = Enabled/Off = Disabled
Use System Proxy	When enabled, uses the proxy settings configured under the Network page > Proxy tab. On = Enabled/Off = Disabled
Proxy Server	When Use Proxy is On, provide proxy server address of the facility.
Proxy Port	When Use Proxy is On, provide port number of the proxy server.
Proxy Credentials	When Use System Proxy is Off, enable to use credentials for a proxy server. On = Enabled/Off = Disabled
Proxy User Name	When Proxy Credentials is On, provide account user name of the proxy server.
Proxy Password	When Proxy Credentials is On, provide account password of the proxy server

### Configure Insite

1. Navigate to **Connectivity > Connection Manager > Special Devices**.
2. Select **Insite**.
3. Configure the fields on the page.
4. Select **Submit**.
5. Select **Done**.

**Syslog**



Figure 10-53. Configure Special Devices - Syslog

This table shows all the preset parameters available on Configure Special Devices - Syslog with descriptions.

Table 10-119: Configure Special Devices - Syslog

Preset Parameter	Description
Server IP Address/ Hostname	IP address of the server.
Mode of Transfer	Mode of transferring the data to the server (UDP, TCP, or TLS).
UDP Listener Port	User Datagram Protocol Listener Port. This is the port which we transfer logging data to use the syslog data protocol. It can be done by UDP or TCP, depending on the configuration of the customer logging server.
Ping Status	Indicates whether the connection has been confirmed or not.
Ping	Select to confirm that the server is connected.

## WindowsEventLog



Figure 10-54. Syslog - WindowsEventLog

This table shows all the preset parameters available on WindowsEventLog with descriptions.

Table 10-120: Syslog - WindowsEventLog

Preset Parameter	Description
Transfer Application Event Log	When enabled, allows the transfer of application event logs. On = Enabled/Off = Disabled
Transfer Security Event Log	When enabled, allows the transfer of security event logs. On = Enabled/Off = Disabled
Source of application event log to transfer	Where to draw data from for the audit report.
Add Source	Select to specify where to draw data from for the audit report.



**Transfer**

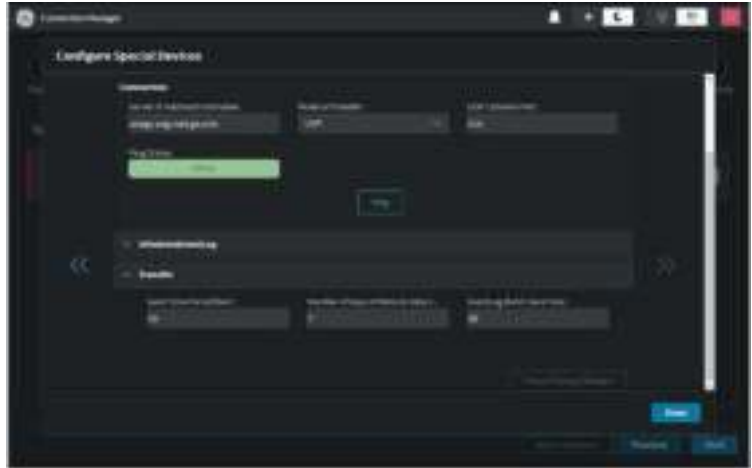

Figure 10-55. Syslog - Transfer

This table shows all the preset parameters available on Transfer with descriptions.

Table 10-121: Syslog - Transfer

Preset Parameter	Description
Send Time Period (Sec)	How often the system will attempt to contact the logging server to send logs.
Number of days of Historic data to send	If logging server connectivity has not been available, how many days of history should be sent when it is restored?
EventLog Batch Send Size	When sending historic data, how much to send in each transaction - this can help manage network traffic and server load, not typically necessary to change this.

**Configure Syslog**

1. Navigate to **Connectivity > Connection Manager > Special Devices**.
2. Select **Syslog**.
3. Configure the fields on the page.
4. Select **Ping**.
5. Select **Done**.

### Data Streaming

Use Data Streaming to stream live/recall/CINE ultrasound image data over the network connection to enabled devices. The data stream will contain grayscale, color map, geometry, view settings (flip/rotate/reverse), probe and system information, VNav position information with ultrasound data. No patient information is transferred with the streamed data.

It is recommended to use a 1 Gbps network connection for Data Streaming. The required bandwidth often lies in the 100-300 Mbps range. Usage of a 100 Mbps network leads to dropped frames and the risk of latency buildup.

The Data Streaming option key needs to be installed to enable the Data Streaming page.



Figure 10-56. Configure Special Devices - Data Streaming

This table shows all the preset parameters available on Configure Special Devices - Data Streaming with descriptions.

Table 10-122: Configure Special Devices - Data Streaming

Preset Parameter	Description
System Information	Shows system information properties for the configured Ultrasound system.
Enable Streaming	When enabled, data streaming is allowed.
Close Stream on Patient/Exam Change	When enabled, data streaming will close when the patient/exam is changed.
PortNo	Port number used for data streaming.
Revoke Selected	Select to remove selected client certificates.
Revoke All Expired	Select to remove all expired client certificates.

**Configure Data Streaming**

1. Navigate to **Connectivity > Connection Manager > Special Devices**.
2. Select **Data Streaming**.
3. Configure the fields on the page.
4. Select **Done**.

## Vscan Air

Use Vscan Air to pair the Vscan Air CL probe with the Ultrasound system.

The Vscan Air CL probe is a battery-operated, wireless, general-purpose diagnostic handheld ultrasound imaging system.

The Vscan Air option key needs to be installed to enable the Vscan Air page.



Figure 10-57. Configure Special Devices - Vscan Air (Not Paired with the Probe)



Figure 10-58. Configure Special Devices - Vscan Air (Paired with the Probe)

This table shows all the preset parameters available on Configure Special Devices - Vscan Air with descriptions.

Table 10-123: Configure Special Devices - Vscan Air

Preset Parameter	Description
Connection Status	Indicates the pairing status (with the serial number) of the Vscan Air probe.
Wi-Fi Environment	Indicates whether the current Wi-Fi environment (signal strength, channel usage) is appropriate for Vscan Air usage and displays errors if there are issues with Wi-Fi hardware.
Country Code	Setting for the Vscan Air probe to meet country regulations (for example, Wi-Fi frequencies).
Use probe button as	Maps the Vscan Air probe button to different functions (for example, Freeze/Print/Toggle).
Probe Serial Number	Serial number of the paired Vscan Air probe.
Probe Model	Model of the paired probe.
Probe Firmware Version	Firmware version on the paired Vscan Air probe.
Battery Level	Battery level for the paired Vscan Air probe.
Probe Temperature	Current temperature of the paired Vscan Air probe.
Activation Status	Indicates whether the Vscan Air probe is activated or not.
Acoustic Output Table (R1)	Link to the acoustic power output table for the paired Vscan Air probe.
Supporting Documents	Link to manuals and tips for the Vscan Air probe (if applicable)
Firmware Compatibility	Lists all the compatible Vscan Air probe firmware versions that can be paired with the Ultrasound system. If the firmware on the paired probe is not compatible with the Ultrasound system, firmware downgrade menu will be activated to allow user to downgrade probe firmware to a compatible probe firmware version.

### Configure Vscan Air CL

1. Navigate to **Connectivity > Connection Manager > Special Devices**.
2. Select **Vscan Air**.
3. Configure the fields on the page.
4. Select **Done**.

## Print Button Page

Use the Print Button page to configure or modify details about the print buttons used for the Ultrasound system.



Figure 10-59. Print Button Page

## Configure Print Button

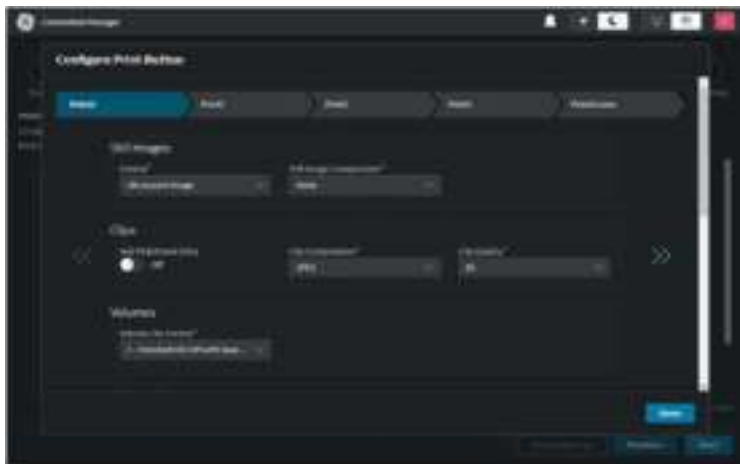

Figure 10-60. Configure Print Button



Figure 10-61. Configure Print Button - Advanced

This table shows all the preset parameters available on Configure Print Button with descriptions.

Table 10-124: Configure Print Button

Preset Parameter	Description
Format	Format: Ultrasound Image, Secondary Capture (Image, Video, Screen)
Still Image Compression	Compression: None, Rle, Jpeg, Jpeg2000
Add Multiframe Data	Clips: Add Multiframe Data: Checkbox
Clip Compression	Compression: None, Rle, Jpeg, Jpeg2000
Clip Quality	Quality: Lossless, 99, 98, 97, ... 50
Volume File Format	1-Standard DICOM (Default), 2-Standard DICOM with Raw Data; 3-Enhanced DICOM, 2&3 (2 files)
Compare Assistant	Compare Assistant: Comparison view (Default), New image, Both Comparison & New (2 files)
VNav Data	VNav Data: V Nav View (Default), Ultrasound Only, or VNav & Ultrasound (2 files)
Scan Assistant Advance	Scan Assistant Advance: On, Off, Use program (system uses setting from the Scan Assistant program which allows a user to configure two print keys identically except that one advances Scan Assistant and the other does not.) On =advances to the next step when that print key is pressed independently of the program setting. Off = does not advance to the next step when the print key is pressed independently of the program setting

### **Configure a print button**

1. Navigate to **Connectivity > Connection Manager > Print Button**.
2. Select **Print button**.
3. Configure the fields on the page.
4. Select **Done**.



## Dataflow Page

Use the Dataflow page to configure or modify details about the data flow properties used for the Ultrasound system.

A dataflow is a set of pre-configured services. When you select a dataflow, the ultrasound system automatically works according to the services associated with the dataflow. The Dataflow tab allows you to select and review information about dataflows. You can also create, change, and remove dataflows.

Set up dataflows for the services.

**NOTE:** You must be logged on as Administrator to use the Dataflow tab.



Figure 10-62. Dataflow Page

This table shows all the preset parameters available on Dataflow Page with descriptions.

Table 10-125: Dataflow Page

Preset Parameter	Description
Direct Store	Select to store data directly to archive (no buffer storage).
Hidden	Select so that this dataflow does not appear as a Dataflow on the Patient menu.
Set As Default	Select to use this dataflow as the default dataflow when the Ultrasound system starts.
Add New Dataflow	Select to add a new dataflow.

### Add a dataflow

1. Navigate to **Connectivity > Connection Manager > Data flow**.
2. Select **Add New Dataflow**.
3. Configure the fields on the page.
4. Select **Add**.

## Advanced Settings Page

Use the Advanced Settings page to configure or modify details about the advanced setting properties used for the Ultrasound system.

Refer to the following sections for more information:

- *'Advanced Settings - Patient Screen page' on page 10-122*
- *'Advanced Settings - Search Settings page' on page 10-124*
- *'Advanced Settings - Worklist Settings page' on page 10-125*
- *'Advanced Settings - Dataflow Settings page' on page 10-126*
- *'Advanced Settings - Dataflow Notification page' on page 10-127*
- *'Advanced Settings - Transfer Settings page' on page 10-129*
- *'Advanced Settings - Print Button Settings page' on page 10-131*
- *'Advanced Settings - Image Numbering page' on page 10-133*
- *'Advanced Settings - Imaging Insights page' on page 10-134*
- *'Advanced Settings - Measurement page' on page 10-135*
- *'Advanced Settings - Spooler Settings page' on page 10-136*
- *'Advanced Settings - LOGIQ Apps page' on page 10-137*

Advanced Settings - Patient Screen page



Figure 10-63. Advanced Settings - Patient Screen

This table shows all the preset parameters available on Advanced Settings - Patient Screen with descriptions.

Table 10-126:

Preset Parameter	Description
Automatic generation of patient ID	In the Search/Create Patient window: When selected, the Patient ID is not required when entering a new patient in the archive. The system automatically generates an ID number. When cleared, the Patient ID is required when entering a new patient in the archive. On = Enabled/Off - Disabled
Show BBT	Show BBT field on the OB patient screen to input the basal body temperature. On = Enabled/Off - Disabled
Use birthdate	In the Patient information window, enter either the patient age or the birth date: When selected, enter birth date, then the age is calculated. When cleared, enter age (birth date field not available). On = Enabled/Off - Disabled
Detail Mode	Select to display Detail Mode, rather than Exam View, when you select the patient name in the patient list on the Patient menu. You can also type comments while in Detail Mode. On = Enabled/Off - Disabled
Quick New Patient Entry	Select to store new patient automatically by pressing the Patient key. On = Enabled/Off - Disabled

Table 10-126:

Preset Parameter	Description
Enable Other ID	Not selected is the Default. If selected, allow entering Other ID, such as Citizen Service Number, Burger Service Number (BSN), National Health System (NHS) number, along with patient ID information on the Patient Screen. On = Enabled/Off - Disabled
Validation Format	If the Enable Other ID preset is selected, the system validates the format of "Other ID" when an ID is entered. Choose: NHS Number *** ** *****, Letters and Numbers, Numbers, or Any (no restriction).
Columns in examination listing	Create new columns, remove columns, and select the information to display in a column. Use the arrows (<< or >>) to reposition column headings.

**Configure Patient Screen**

1. Navigate to **Connectivity > Connection Manager > Advanced Settings**.
2. Select **Patient Screen**.
3. Configure the fields on the page.
4. Select **Next** to proceed to Search Settings.

Advanced Settings - Search Settings page



Figure 10-64. Advanced Settings - Search Settings

This table shows all the preset parameters available on Advanced Settings - Search Settings with descriptions.

Table 10-127: Advanced Settings - Search Settings

Preset Parameter	Description
Auto search for Patient	In the Search/Create Patient window: When selected, the system automatically searches through the selected patient archive, while the user enters patient information. When cleared, the automatic search tool is turned off. If you are trying to keep the past patient data confidential, DO NOT use this feature. On = Enabled/Off - Disabled
Keep Search String	Search string is kept rather than cleared. On = Enabled/Off - Disabled
Remember cursor position on Transfer Screen	Enable to set a default cursor location on the Data Transfer screen. On = Enabled/Off - Disabled

**Configure Search Settings**

1. Navigate to **Connectivity > Connection Manager > Advanced Settings**.
2. Select **Search Settings**.
3. Configure the fields on the page.
4. Select **Next** to proceed to Worklist Settings.

## Advanced Settings - Worklist Settings page

Use Scanner Network Properties - General to configure the protocol setting.

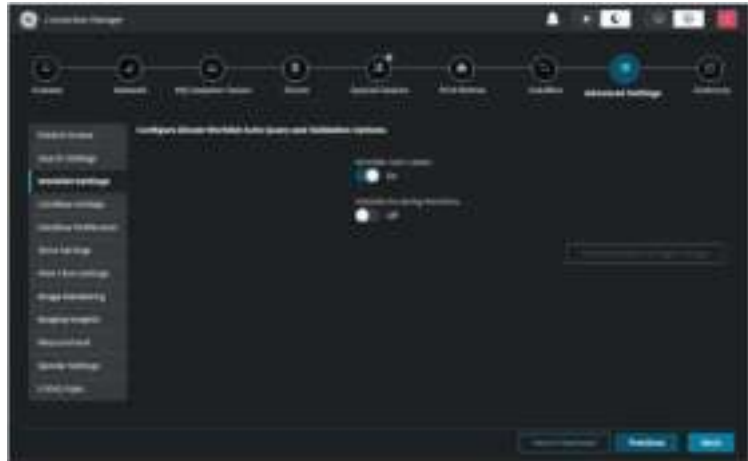

Figure 10-65. Advanced Settings - Worklist Settings

This table shows all the preset parameters available on Advanced Settings - Worklist Settings with descriptions.

Table 10-128: Advanced Settings - Worklist Settings

Preset Parameter	Description
Worklist Auto Query	Automatically queries the worklist server. On = Enabled/Off - Disabled
Validate Incoming Worklists	Confirm incoming Worklists are valid. On = Enabled/Off - Disabled

### Configure Worklist Settings

1. Navigate to **Connectivity > Connection Manager > Advanced Settings**.
2. Select **Worklist Settings**.
3. Configure the fields on the page.
4. Select **Next** to proceed to Dataflow Settings.

## Advanced Settings - Dataflow Settings page

Use Scanner Network Properties - General to configure the protocol setting.



Figure 10-66. Advanced Settings - Dataflow Settings

This table shows all the preset parameters available on Advanced Settings - Dataflow Settings page with descriptions.

Table 10-129: Advanced Settings - Dataflow Settings

Preset Parameter	Description
Automatic Disable Patient Data	Select to automatically disable patient data. If selected, locks the patient name, date of birth and gender (like Patient ID). The Factory Default for this preset is unchecked. On = Enabled/Off - Disabled
Auto Archiving Patient Data	Archives patient data automatically. On = Enabled/Off - Disabled
After [End Current Patient], go to:	Select Worklist screen or Patient screen.
Double click on patient list to start	Select Review or New Exam to display each time you double click on the patient name in the patient list on the Patient menu.

### Configure Dataflow Settings

1. Navigate to **Connectivity > Connection Manager > Advanced Settings**.
2. Select **Dataflow Settings**.
3. Configure the fields on the page.
4. Select **Next** to proceed to Dataflow Notification.



Advanced Settings - Dataflow Notification page



Figure 10-67. Advanced Settings - Dataflow Notification

This table shows all the preset parameters available on Advanced Settings - Dataflow Notification with descriptions.

Table 10-130: Advanced Settings - Dataflow Notification

Preset Parameter	Description
Warn image store without patient	Select to receive a warning when you press the Print key without an active patient. On = Enabled/Off - Disabled
Warn image store to Read Only dataflow	The system posts a warning message if you attempt to store images to a read-only Dataflow. On = Enabled/Off - Disabled
Warn register to No Archive	Select to receive a warning when you register a patient to the "No Archive" data flow. Select a different data flow for permanent storage of patient data. On = Enabled/Off - Disabled
Request acknowledge of End Exam action	When selected, the user is asked to confirm action when ending an examination. On = Enabled/Off - Disabled
Warn video titles exist in the internal storage	The system posts a warning if the video titles exist on the internal DVR flash memory. On = Enabled/Off - Disabled

### Configure Dataflow Notification

1. Navigate to **Connectivity > Connection Manager > Advanced Settings**.
2. Select **Dataflow Notification**.
3. Configure the fields on the page.
4. Select **Next** to proceed to Transfer Settings.

Advanced Settings - Transfer Settings page



Figure 10-68. Advanced Settings - Transfer Settings

This table shows all the preset parameters available on Advanced Settings - Transfer Settings with descriptions.

Table 10-131: Advanced Settings - Transfer Settings

Preset Parameter	Description
Send Images via Wireless	When enabled and connected to the network through a wireless LAN, images will be sent to the DICOM device over the wireless LAN. If disabled, images spooled in the Spooler will be sent when the Ultrasound system is connected to the wired network. On = Enabled/Off - Disabled
Receive Images Wireless	When enabled and connected to the network through a wireless LAN, images will be received from the DICOM device over the wireless LAN. If disabled, images will be received when the Ultrasound system is connected to the wired network. On = Enabled/Off - Disabled
Send To: Default Service	Select default Send To service from the dropdown list.
Process Dicom Job Without Network	When enabled, preset that allows communication between the Ultrasound system and the Koios Server VM (installed in the Ultrasound system) even when there is no network. On = Enabled/Off - Disabled

### Configure Transfer Settings

1. Navigate to **Connectivity > Connection Manager > Advanced Settings**.
2. Select **Transfer Settings**.
3. Configure the fields on the page.
4. Select **Next** to proceed to Print Button Settings.

**Advanced Settings - Print Button Settings page**

Use Scanner Network Properties - General to configure the protocol setting.



Figure 10-69. Advanced Settings - Print Button Settings

This table shows all the preset parameters available on Advanced Settings - Print Button Settings with descriptions.

Table 10-132: Advanced Settings - Print Button Settings

Preset Parameter	Description
Allow press and hold print key to replace an image	Select to enable pressing and holding print key to replace an image. On = Enabled/Off - Disabled
Enable Smart Capture Area	Check box to select. On = Enabled/Off - Disabled
Add Titlebar information to Multiframe loops	Adds a title bar to the DICOM image. On = Enabled/Off - Disabled
Store Dicom MultiFrame When Collecting RF Data	Select to store DICOM multiFrame images when collecting RF Data. On = Enabled/Off - Disabled
Store 2D Loop with Timeline Data	Check box to select. On = Enabled/Off - Disabled
Add Scan Parameter information to Multiframe Loops	Adds scan parameter(s) to the DICOM image. On = Enabled/Off - Disabled
Store Dicom MultiFrame in QAnalysis pack	Select to store DICOM MultiFrame images in Quantitative Analysis mode. Selected by default. On = Enabled/Off - Disabled

Table 10-132: Advanced Settings - Print Button Settings

Preset Parameter	Description
Patient List Print - Font Size	Select font size.
P[1-4] Key Sound	Select None, Click, Chimes, Ding, Ding-Dong, or Whoosh.

### Configure Print Button Settings

1. Navigate to **Connectivity > Connection Manager > Advanced Settings**.
2. Select **Print Button Settings**.
3. Configure the fields on the page.
4. Select **Next** to proceed to Image Numbering.

## Advanced Settings - Image Numbering page

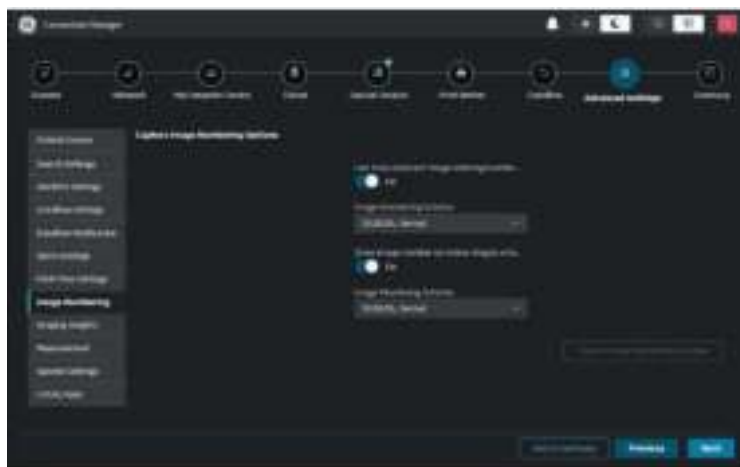

Figure 10-70. Advanced Settings - Image Numbering

This table shows all the preset parameters available on Advanced Settings - Image Numbering with descriptions.

Table 10-133: Advanced Settings - Image Numbering

Preset Parameter	Description
Use Scan Assistant image ordering/numbering	When enabled, uses Scan Assistant image reordering/renumbering. On = Enabled/Off - Disabled
Image Numbering Scheme	Preset that defines how the images are numbered during the examination/scanning process.
Show image number on Active Images screen	When enabled, shows the image number on the Active Images screen. On = Enabled/Off - Disabled
Image Reordering Scheme	Preset that defines how the images are numbered during image reorder operation.

### Configure Image Numbering

1. Navigate to **Connectivity > Connection Manager > Advanced Settings**.
2. Select **Image Numbering**.
3. Configure the fields on the page.
4. Select **Next** to proceed to Imaging Insights.

Advanced Settings - Imaging Insights page



Figure 10-71. Advanced Settings - Imaging Insights

This table shows all the preset parameters available on Advanced Settings - Imaging Insights with descriptions.

Table 10-134: Advanced Settings - Imaging Insights

Preset Parameter	Description
Store incremental analytic data in each image	Select to store incremental data in each image. On = Enabled/Off - Disabled
Send consolidated analytic data to server	Select to send consolidated analytic data to server. On = Enabled/Off - Disabled
Image Analytics Server	Select server from dropdown list.
Trigger interval outside an exam (hours)	Off, 1, 2, 3, 5

**Configure Imaging Insights**

1. Navigate to **Connectivity > Connection Manager > Advanced Settings**.
2. Select **Imaging Insights**.
3. Configure the fields on the page.
4. Select **Next** to proceed to Measurement.



**Advanced Settings - Measurement page**



Figure 10-72. Advanced Settings - Measurement

This table shows all the preset parameters available on Advanced Settings - Measurement with descriptions.

Table 10-135: Advanced Settings - Measurement

Preset Parameter	Description
Link Measurement to Images	Links measurements to images when sent to PACS. On = Enabled/Off - Disabled
Verify all Measurements have Image References	Verifies that all measurements have image references when sent to PACS. On = Enabled/Off - Disabled

**Configure Measurement**

1. Navigate to **Connectivity > Connection Manager > Advanced Settings**.
2. Select **Measurement**.
3. Configure the fields on the page.
4. Select **Next** to proceed to Spooler Settings .

## Advanced Settings - Spooler Settings page



Figure 10-73. Advanced Settings - Spooler Settings

This table shows all the preset parameters available on Advanced Settings - Spooler Settings with descriptions.

Table 10-136: Advanced Settings - Spooler Settings

Preset Parameter	Description
Media Spooler Jobs Display Time (mins)	Number of minutes completed jobs will display in the media spooler.
Network Spooler Jobs Display Time (mins)	Number of minutes completed jobs will display in the network spooler.

### Configure Spooler Settings

1. Navigate to **Connectivity > Connection Manager > Advanced Settings**.
2. Select **Spooler Settings**.
3. Configure the fields on the page.
4. Select **Next** to proceed to LOGIQ Apps.

Advanced Settings - LOGIQ Apps page

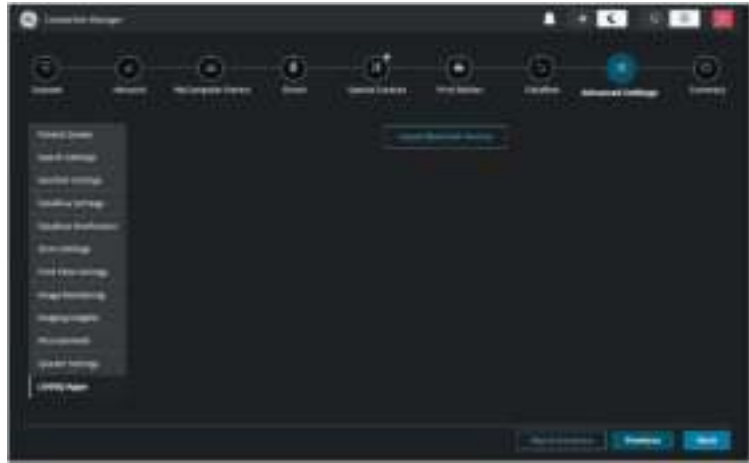

Figure 10-74.

This table shows all the preset parameters available on Advanced Settings - LOGIQ Apps with descriptions.

Table 10-137: Advanced Settings - LOGIQ Apps

Preset Parameter	Description
Unpair Bluetooth Devices	Select to unpair the LOGIQ Apps device.

**Configure LOGIQ Apps**

1. Navigate to **Connectivity > Connection Manager > Advanced Settings**.
2. Select **LOGIQ Apps**.
3. Configure the fields on the page.
4. Select **Next** to proceed to Summary.

### Connection Manager Summary Page

The Summary page lists the status of the wired or wireless connectivity and proxies configured on the left and Dicom Devices and Services on the right



Figure 10-75. Summary Page

Device status is noted with different colors:

- Green - Device and all services are available
- Red - Device is offline, or all the services are offline
- Orange - Device is available. However, one more of its services are offline
- Gray - Device has no service or service status is being updated

Navigate to configure connectivity functions by clicking the icons at the top of the screen to access the desired configuration screen, or by selecting Next or Previous at the bottom of the screen.

# Measure

Please refer to Chapter 7, General Measurements and Calculations for more information on setting up Measurement and Analysis Presets.

# Reports

Refer to Chapter 13 for more information.

# System Administration

## Overview

The Admin screen has the following sections:

- **System Administration** – lists all the options implemented in the system.
- **Users** – allows you to define user IDs, specify operator's registration, operator's rights, registration of staff related to an examination (for example, referral doctors and sonographers) and password update requirements.
- **Logon** – defines logon procedures, allows the System Administrator to set password policies, and LDAP Configuration.
- **Groups** – The System Administrator can set up user groups on this page.
- **System Password** – Password for the Application Windows Logon Account.
- **Disk Encryption** – The System Administrator can encrypt the disk for highest system security, if required.
- **Audit Report** – Generates an audit report.
- **Vulnerability Scan Mode** – Part of the Advanced Security Option. Vulnerability Scan Mode configures the system so that an external scanner can analyze the LOGIQ Totus.

*NOTE: Only the System Administrator can access the pages.*

### **Administrator Tasks**

Here are the tasks typically performed by the LOGIQ Totus System Administrator. Instructions for each of these tasks can be found in this chapter.

- Privacy and Security Configuration options
- Define connection options for LDAP Directory Server
- Control encryption of the Patient Data drive
- Create Users/Groups
- Change rights for Users/Groups
- Change Encryption status for the system
- Change/Add Encryption Passwords
- Save/Print Recovery keys for encrypted drives
- Configure Password Policies
- Configure Session Policies
- Vulnerability Scan Mode
- Generate Audit Reports
- Configure Remote Logging Servers

### **Privacy and Security**

Privacy protects both personal and private interests and information of persons. Security protects both system and information from risks to confidentiality, integrity, and availability. The LOGIQ Totus Privacy and Security capabilities are discussed in Chapter 12; Privacy and Security configuration is discussed below, followed by a description of each system administrative page.



## Creating Password Policies and User Groups

The foundation of setting up effective privacy and security is controlling user groups, users, and their system permissions.

### Enabling Password Policies

Check the “Enable Password Policies” box on the Utility-> Admin-> LOGON page.

In addition, set the password policy for each selection. These policies should be set **BEFORE** creating new users. Save the changes and reboot the system. This applies rules for the passwords.



Ensure the ADM password is known **BEFORE** rebooting the system.



Figure 10-76. Enable Password Policies

## Groups

You define Group access rights via the Utility-> Admin-> Groups page. When each user logs in, they will have access to the system according to the rights assigned to their group(s). Default system groups are preset with pre-determined access rights. To view these access rights, highlight a group name in the Group List column on the left, then look in the Groups Rights column to see the permissions by group.



HINTS

Admin has full access rights.



Figure 10-77. Groups Page

## Adding users

You define Group access rights via the Utility-> Admin-> Users page.



Figure 10-78. Page to Add Users

## Creating a user

1. Press **Add**.
2. Type the user ID.



### HINTS

ENSURE that you DO NOT include the following characters in a user's ID: slash (/), dash (-), asterisk (\*), question mark (?), an underscore (\_), ampersand (&), or blank spaces.

3. Type the user's information in the Identity section, ensuring that you are using the defined policies. User IDs are enforced as all uppercase letters for local users.

### NOTE:

*If a password is created, the user will be required to enter the password when logging on, even if Password Policies is not enabled. Remember, passwords are case-sensitive.*

4. Select the user's group(s). Multiple groups can be selected, if needed.

### Creating a user (continued)

5. If the user needs full configuration and advanced operations access, select **Admin**.
6. Press **Save**.

*NOTE: DO NOT add users with the same User ID. The system allows you to do this; however, the first user is erased and only the second user remains.*

*NOTE: When adding a new user, press Add first. Then edit the ID from the default of "NewUser" and edit the other fields. **DO NOT** press Add again unless you actually want to create another user. Press Save after adding one or more users. The user listed as NewUser on the list will be updated with the edited ID when you re-enter this screen.*

### User Login

After the system administrator adds a new user, the new user should login with their new user name and password. If designated by the system administrator, they may be required to change their password.

The user will be prompted for their password when logging into the system or when selecting their user name from the Patient menu as well.

After logging in, the user will have access according to the rights available to them within their assigned group(s).

### Changing a user configuration

The system administrator can update a user. The system administrator can also specify whether the user's account is "Active," "Blocked," or requires a password change. If needed, select the check box, "User must change password." Then the user will be prompted to change their password the next time they log into the LOGIQ Totus.

1. Move the **Trackball** to a user ID in the User List.
2. Make the desired changes.

## Deleting a user

The system administrator can delete a user.

1. Move the **Trackball** to a user ID in the User List.
2. Select **Remove**. This marks the account as inactive.  
The user is removed from the User List.
3. Select Remove again.

*NOTE: Accounts are not removed immediately because User data is retained for auditing purposes. This can be useful because their name will still appear in audit reports. Also, they can be reactivated.*

If you permanently remove the user, by selecting "Remove" on an inactive user, this traceability will be lost.

## User Accounts and Password Policies Frequently Asked Questions

Here are answers to some frequently-asked questions:

**Q** I lost or forgot my password.

**A** System Admin can change your password.

**Q** I entered the wrong password multiple times and now the system says I am locked out.

**A** Wait until you are unlocked, enter the correct password. If you have forgotten your password, the System Admin can access the system and user details. Utility>Admin>Users

**Q** I am locked out after multiple attempts to remember my password, does the System Admin have to wait until my account is unlocked before accessing the system?

**A** The System Admin can logon with their own logon information before the users blocked time is over. The box "Block user account" Utility>Admin>User, should be unchecked to allow the user to logon.

**Q** I have created a list of users on one u/s system, I have three more in the department, can I do a backup to disk and restore the user list onto the other systems?

**A** Yes, you can copy both User and Password.

## **User Accounts and Password Policies Frequently Asked Questions**

**(continued)**

**Q** I have a sonographer who left the facility, how do I delete this user?

**A** The System Admin can deactivate or delete a user. Utility>Admin>Logon. Select the user and press “remove”

**Q** I have a sonographer who is on medical leave for a few weeks. I do not want to remove their user logon but I want to make sure they cannot access the system while not working.

**A** The System Admin can block a user account. Utility>Admin>Logon, select the user and check “Block user account,” or deselect “active user account.”

**Q** We have information that a weekend users password may have been compromised, I need to ask the user to change their password the next time they logon.

**A** The System Admin can require the user to change their password. Utility>Admin>Logon, select the user and check “Require password change”

**Q** I have created a new user for a new sonographer, how do I assign the correct group?

**A** When a new user is added to the list, the groups list is located on the right column of the screen. Assign the user to a group or multiple groups with the appropriate access rights.

**Q** Can I change the access rights for a pre-defined group?

**A** Currently this is not supported. You can select multiple groups from the factory default list for any user that needs additional access but not full admin rights; or create your own groups with desired rights.

**Q** The default “ADM” user account does not have a password, can I create a password for this account?

**A** Yes, you can create a password for the default ADM. Be sure to write this down for anyone who will need access to the system, such as GE HealthCare Service.

## User Accounts and Password Policies Frequently Asked Questions

(continued)

**Q** I was the last user on the system, the screen has gone black, do I need to logon again?

**A** Yes, once the Screen Lock time has been reached touch any button or the trackball on the operator panel to display the logon screen. Logon with your current credentials.

**Q** Can I use the Auto Logon feature?

**A** Yes, the Auto logon if checked will logon with the last user if the “Use password policies” is unchecked and the user has blank password. If the user is not assigned a password they will be logged on with no other entry required. If the user is assigned a password the logon window will pop-up requiring the password to be entered.

### Locking the Screen and Logon

You define Automatically Lock Screen via the Utility-> Admin-> Logon page by checking the Enable Session Timeout (Lock Screen) box. Then go to the bottom of the column to designate after how many minutes the screen should be locked (Session Lock Screen Timeout (min)).



Figure 10-79. Enable Lock Screen

The screen will lock after the designated time. During this time, the system will be completely black. To reactivate the system, the user will need to logon again.

**NOTE:** *If “use password policies” is unchecked and no password is set to the user, and when Auto Logon is checked, the system will start by using the ID of the last operator. If Admin is used as the operator, assure that all characters are removed from the password field.*

To lock the screen,

- Type [Alt+L].

## System Admin

The System Admin screen has information about any options implemented for the system.



Figure 10-80. Administrative System Admin Preset Menu

Table 10-138: Product

Preset Parameter	Description
Product	The name of the product.
HW Number	The hardware number of the product.

Table 10-139: Software Option Key

Preset Parameter	Description
Enter New Option Key	Type the key for the option you wish to add and press Add. <i>Note: The Option Key may contain alphanumeric characters (2-9, A-H, J-N, P-Z) and special characters ("?", "%" and "&amp;").</i>
Installed Option Keys	Lists the key for the installed options.
Add	Press to add a software option key.
Remove	To remove a software option key, select the key in the SW Option Key list, and then select Remove.
Import	Used to import option strings stored on media (USB) or in the system (OptionKeys.txt may be stored at d:\service). When you press Import, a dialog box comes up that allows you to select from the following locations: USB drive and d:\service.



Table 10-140: Service

Preset Parameter	Description
Enable Automatic Request for Service	Check this box to enable the system to send system-generated requests for service, without your intervention.
Transfer Machine Logs to GE HealthCare	Allows transfer of monitoring errors and status logs to GE HealthCare back office for data analytics.
Transfer Operator Information to GE HealthCare	Allows transfer of operator information to GE HealthCare back office for usage analytics.
Enable Automatic Probe Diagnostics	Enable Automatic Probe Diagnostics to run and save data to log file for transfer to GE HealthCare backoffice for analysis.
Transfer Images (captured without patient information) to GE HealthCare	Allows transfer of images for analysis.
Include Annotation with Image transfer to GE HealthCare	Usage Analysis: Allows transfer of operator information to GE HealthCare back office for usage analytics.

If your site decides to deactivate the InSite ExC Agent, then Remote Connectivity is no longer available on the LOGIQ Totus. This also means that Remote Service can no longer connect to the LOGIQ Totus via Disruptive Mode to diagnose system issues. and the “Service” section will be removed from this Utility page. In addition, you will not be able to initiate a Request for Service or Clinical Support Request via the “GE HealthCare InSite ExC” icon control located at the bottom of the Monitor Display.



Figure 10-81. Remote Connectivity Deactivated; Service Fields Removed

Table 10-141: Protecting Health Information (PHI)

Preset Parameter	Description
Prevent Writing to Removable Media USB (requires reboot)	Check this box to prevent users from copying/saving information to removable media.

Table 10-142: USB External Media

Preset Parameter	Description
USB External Media disabled (requires reboot) By Checking this box you will disconnect all external USB Mass Storage devices	Select to disable any USB media from connecting to the LOGIQ Totus. <b>Please remember to enable this feature to reload software or to install the eIFU USB Media.</b>

Table 10-143: Rights

Preset Parameter	Description
Require Admin Operator Rights to Save Imaging Settings	Check this box to require the User to have Administrative rights in order to save image settings.

Table 10-144: Option Status

Preset Parameter	Description
Options	A list of the option name and status.
Status	Lists each option's effectivity.

## Users

The Users screen allows you to define user IDs. It also allows you to specify operators registration, operator’s rights setting, and registration of staff related to an examination (for example, referring and interpreting physicians).



Figure 10-82. Users Preset Menu

Table 10-145: User List

Preset Parameter	Description
User List	Lists the user ID for all system users.
Identity	Type the operator’s user ID, Password, Prefix, Last Name, First Name, Middle Name, Suffix, Phone Number.
User Controls	The System Administrator can specify whether a user’s account is active, blocked, or requires a password update.
Group Membership	Select the user’s group: Operator (sonographers, doctors, or any person using the ultrasound system); Ref.Phys. (referring physician can be associated to the patient examination in the extended Patient information window); Perf.Phys. – physician performing the exam can be associated to the patient examination in the extended Patient information window. Note, other groups may exist as set up by the System Administrator.

## Logon

The Logon section defines log on procedures.



Figure 10-83. Administrative Logon Preset Menu

Table 10-146: Logon

Preset Parameter	Description
Auto Logon	Specifies logon procedures: <ul style="list-style-type: none"> <li>• Use Auto Logon                             <ul style="list-style-type: none"> <li>• When selected, the system is started automatically, using the last user logon.</li> <li>• When blank, the user must select a user ID and enter a password when logging on.</li> </ul> </li> </ul> Note: Auto LOGON only works when password policies are disabled and if there is no password assigned to the user. <ul style="list-style-type: none"> <li>• Allow Auto Logon for Admin users: The system is started automatically when logging in as an ADM user.</li> <li>• Allow Emergency User: The system will allow the EUSR user for emergency use.</li> </ul>
Common Network Login	Specifies the user ID and password used to access the network. <ul style="list-style-type: none"> <li>• User – User ID for network access</li> <li>• Password – Password for network access</li> </ul>
Connectivity Maintenance	Reset to factory default.
LDAP Configuration	Refer to the next section for LDAP instructions.

Table 10-146: Logon (Continued)

Preset Parameter	Description
Security Baseline	<p><b>Choose Security Baseline.</b> Select a baseline set of security policies for password and session management. For example:</p> <p><b>Lowest (default):</b> Autologon available. No password complexity rules.</p> <p><b>Medium:</b> Autologon unavailable. Passwords must meet the following criteria:</p> <ul style="list-style-type: none"> <li>• Minimum password length of 8.</li> <li>• Minimum of 2 character sets.</li> <li>• Password should not contain username.</li> <li>• Password should not be any of the last 10 passwords.</li> </ul> <p><b>High:</b> Autologon unavailable. Passwords must meet the following criteria:</p> <ul style="list-style-type: none"> <li>• Minimum password length of 10.</li> <li>• Minimum of 4 character sets.</li> <li>• Minimum of 1 lower case characters.</li> <li>• Minimum of 1 upper case characters.</li> <li>• Minimum of 1 special characters.</li> <li>• Minimum of 1 digits.</li> <li>• Password should not contain username.</li> <li>• Password should not be any of the last 15 passwords.</li> </ul> <p><b>Highest:</b> Autologon unavailable. Passwords must meet the following criteria:</p> <ul style="list-style-type: none"> <li>• Minimum password length of 14.</li> <li>• Minimum of 4 character sets.</li> <li>• Minimum of 1 lower case characters.</li> <li>• Minimum of 1 upper case characters.</li> <li>• Minimum of 1 special characters.</li> <li>• Minimum of 1 digits.</li> <li>• Password should not contain username.</li> <li>• Password should not be any of the last 25 passwords.</li> </ul> <p><b>Reset Security Baseline:</b> Clears the stored value for customer-selected security baseline. This forces the dialog which allows you to choose a baseline to be presented at the next Admin logon.</p>

Table 10-147: Policies

Preset Parameter	Description
Enable Password Policies	Specify whether to enable establishing policies for acceptable passwords, This specifies Password requirements such as # of letters, numbers, symbols, etc.
Enable Session Timeout (Lock Screen)	<p>2-step logout:</p> <ol style="list-style-type: none"> <li>1. System will display a lock screen after a set amount of time (configurable below under "session Lock Screen Timeout").</li> <li>2. System attempts to logout the user if "Automatic Logoff" is enabled and the timeout for it is reached or another user logs in instead.</li> </ol>
Enable Session Timeout (Automatic Logoff)	This logs out a user automatically after a set amount of time.
Require Logon At Startup	Select to require logon with password at startup.

Table 10-148: User Name Policies

Presets Parameter	Description
Display Login User List	Check this box to display a list of Users.

Table 10-149: Password Policies

Presets Parameter	Description
Password cannot contain username	Password policy stating that the password cannot contain the user's name.
Minimum Password Length	Password policy for password minimum length.
Minimum Number of Character Sets	Password policy for minimum number of characters types (Upper-Case, Lower-Case, Digits, Symbols).
Minimum Number of Upper Case Letters	Password policy for minimum number of upper-case letters allowed (A, B, C, etc.)
Minimum Number of Lower Case Letters	Password policy for minimum allowed for number of lower-case letters (a, b, c, etc.)
Minimum Number of Digits	Password policy for minimum number of numbers (1, 2, 3, etc.)
Minimum Number of Symbols (~#\$% etc.)	Password policy for minimum number of symbols allowed (#, @, etc.).
Minimum Password Age (hours)	Password policy for the minimum age for a password, in hours.
Maximum Password Age (days)	Password policy for the maximum age for a password, in days.
Minimum Changes Between Passwords	Password policy for the minimum number of changes between passwords.
Maximum Number Of Repeated Characters	Password policy for the maximum number of repeated password characters.
Maximum Number Of Sequential Characters	Password policy for the maximum number of sequential password characters.
Password Reuse History Count	Password policy -- users can't reuse old password -- # of old passwords it stores so you can't reuse it
Failed Logins Before Account Blocked	Password policy for the number of failed attempts to login that are allowed.
Do Not Allow Common Passwords	Select to disallow commonly used passwords.
Account Block Time (min)	There's a policy which will block an account for a certain amount of time after a certain number of failed logins -- you can set how long that time is
Session Lock Screen Timeout (min)	Password policy for the time, in minutes, before the system will lock the screen.

Table 10-149: Password Policies

Preset Parameter	Description
Session Auto Logoff Timeout (min)	Password policy for the time, in minutes, before the system will automatically log a user off the system.

## Logon Banner

The Power On Logon Banner displays the text at power-on and requires user confirmation to complete booting the system. This is user-configurable.

### Updating the Logon Banner Page

You can change the text that displays when the user logs onto the LOGIQ Totus via the Utility-> Admin-> Login screen.

There are three login screens that can be used:

- GE HealthCare Default Login Screen
- Department of Defense (DoD) Default Login Screen
- User-customized Login Screen

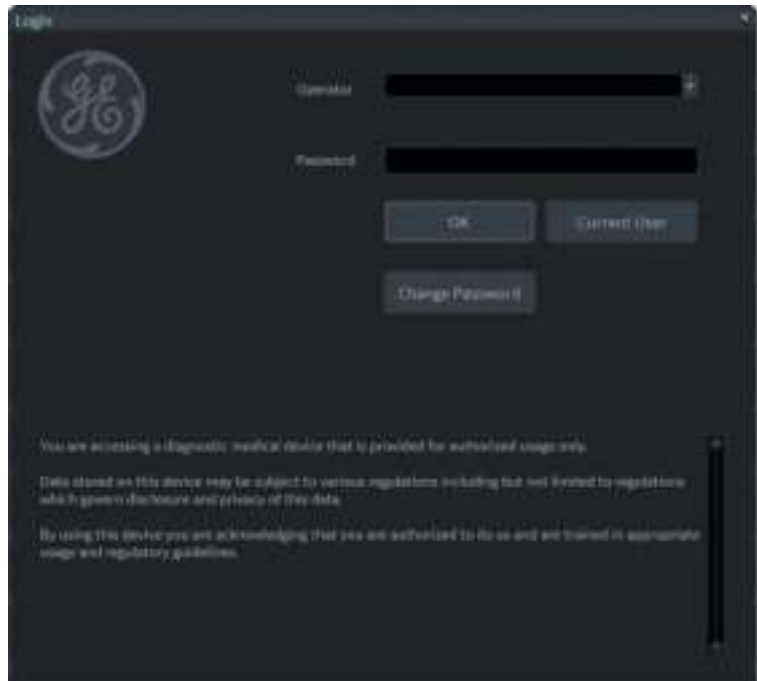

Figure 10-84. GE HealthCare Default Login Window

### Updating the Logon Banner Page (continued)

To configure a customer-specific Login Banner page,

1. Access the Utility-> Admin-> Login screen.



Update the Logon Banner portion of this screen:



2. Type the Title into Logon Title Text.
3. Type the text into Logon Disclaimer Text.
4. Press Save.



### Updating the Logon Banner Page (continued)

To set the GE HealthCare Default as the Login window, press Load GE HealthCare Default. Then press OK-> Save.



Figure 10-85. Default GE HealthCare Logon Banner

To set the DoD Default as the Login window, press Load DoD Default. Then press OK-> Save.



Figure 10-86. Department of Defense Logon Banner

### Enabling the Power On Logon Banner

To ensure the Power On Logon Banner displays and requires user confirmation to complete booting the system,



Figure 10-87. Power On Logon Banner

1. Access the Utility-> Admin-> Login screen.
2. Checkmark **Enable Power On Logon Banner**.
3. Press Save and Exit.

## Adding a Logon Logo

The system default logo on the LOGIQ Totus is the GE HealthCare Logo. To add your own Logo,

1. Insert the USB Flash Drive with the Logo into a USB port on the LOGIQ Totus.

Specifications: The 'Logo' image should be a bitmap image (.BMP) format ONLY, with a size of 128x128.

2. Navigate to the Utility-> Admin-> Login screen.
3. Select Browse Logo. A pop-up window appears for you to navigate to the USB Flash Drive and Logo you want to add.
4. Select the Logo. Select OK. Then Save.

## Adding a "Lock Screen" Image

You can add a custom lock-screen image.

Specifications: The 'Lock Screen' image should be a bitmap image (.BMP) format ONLY, with a size of 1920x1080.

**NOTE:** *Please select a screen that does not have high contrast or bright colors.*

To add a 'Lock Screen' image,

1. Insert the USB Flash Drive with the image into a USB port on the LOGIQ Totus.
2. Navigate to the Utility-> Admin-> Login screen.
3. Select Lock Screen Image. A pop-up window appears for you to navigate to the USB Flash Drive and image you want to add.
4. Select the image. Select OK. Then Save.

## LDAP Configuration

To enable LDAP authentication, check the “Enable LDAP authentication” box at the top of the LDAP Configuration page.

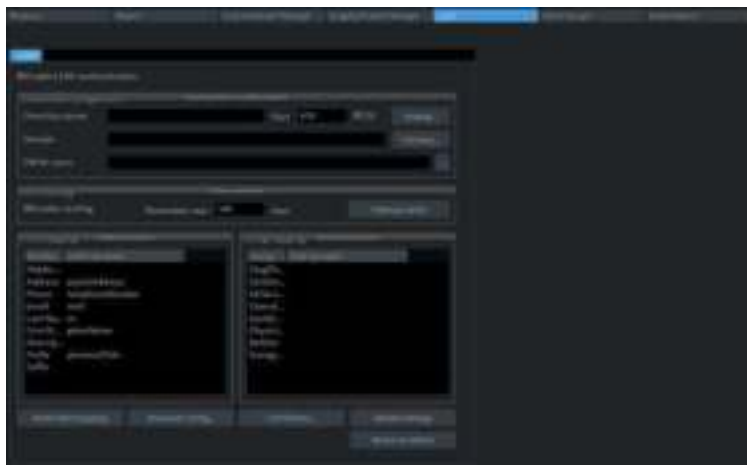

Figure 10-88. LDAP Configuration

Table 10-150: Connection Configuration

Preset Parameter	Description
Enable LDAP authentication	The administrator can select to enable system credentials using LDAP
Connection Configuration:	
Directory Server	URL for the Directory Server
Port	Port for the Directory Server
SSL	SSL (Secure Sockets Layer) -- Select to enable LDAPs (LDAP over SSL).
Lookup...	Button that opens up a Query pop-up for groups, domain, LDAP server, etc.
Domain	Domain name for LDAP server (if needed).
Connect...	Select to connect to server as...
DN for users	Distinguished Name for users. The LDAP API references an LDAP object by its distinguished name (DN). A DN is a sequence of relative distinguished names (RDN) connected by commas.
...	Select to open a list of DNs supported by the server.
User caching:	
Enable caching	The administrator can select to allow the user to cache their password credentials.

Table 10-150: Connection Configuration (Continued)

Preset Parameter	Description
Remember user ____ days	This field specifies the number of days to remember the user for caching purposes.
Cleanup cache	The user can cache credentials. When they select this, it clears out the cache of credentials.
Field mapping:	
Field mapping	The mapping between attributes on the Ultrasound system and LDAP attributes. This allows you (for instance) to select which of several phone numbers that may be stored in your AD server are mapped to the Phone Number field of a user on the system or to refrain from mapping any AD element to that field.
Group mapping:	
Group mapping	Maps an LDAP group to a local group on the machine.
Selection buttons on bottom of screen:	
Reset field mapping	Resets field mapping to the factory defaults
Advanced config...	Entries in this menu should only be changed by experienced network administrators.
Certificates...	Server Certificate
Reload settings	Reloads LDAP settings.
Return to Admin	Press to go back to the Utility--> Admin configuration screens.

### Lookup LDAP Servers

To look up LDAP Servers, select "Lookup" from the LDAP Configuration menu. Select the Domain from the pull-down menu, then select the LDAP Server from the list and press OK.

### Logging on to the LDAP Server

To logon to the LDAP server, type your User Name and Password, then press OK.

### Cleaning Up the Cache of Credentials

To clean up (empty) the cache of credentials, type your User Name and Password, then press OK.

### Certificate Management

The Certificate Manager displays the system’s Intermediate and Trusted Root Certification Authorities, as noted on the Certificate Manager’s Tabs (Intermediate Certification Authorities and Trusted Root Certification Authorities). You can import or remove certificates.

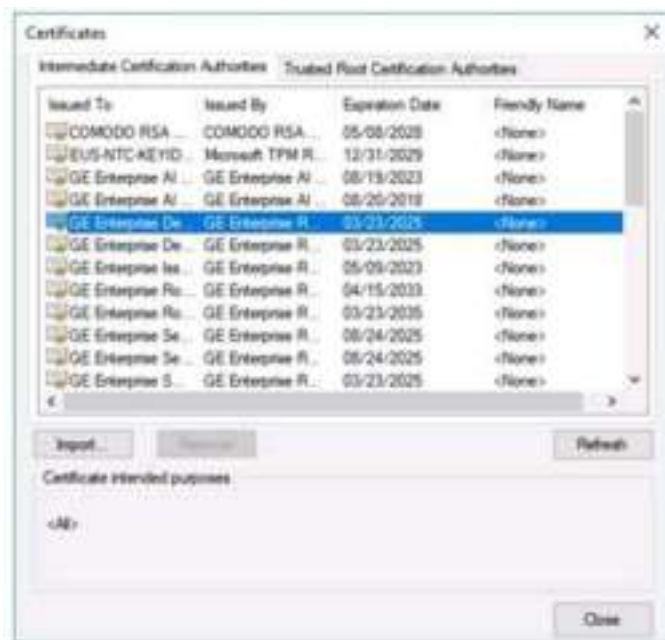

Figure 10-89. Certificate manager

Select the appropriate Certification Authority, then press “Import” to import Certificates or press “Remove” to remove Certificates.



Figure 10-90. Certificate Import Dialog

### Advanced LDAP Configuration

Advanced LDAP Configuration Settings can be set on the Advanced LDAP Configuration menu.

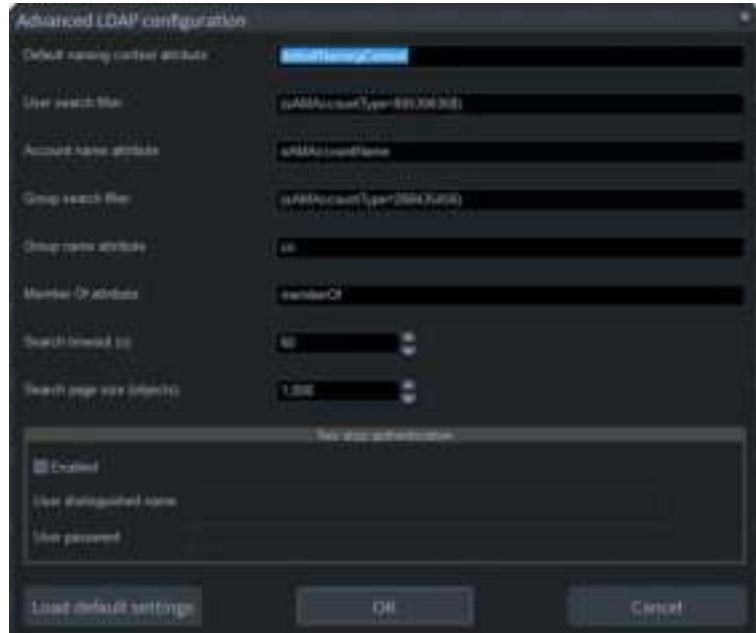

Figure 10-91. Advanced LDAP Configuration

Table 10-151: Advanced LDAP Configuration

Preset Parameter	Description
Default naming context attribute	Attribute name for the naming context.
User search filter	Search for the user using a keyword
Account name attribute	Attribute name for LDAP Attribute to be used as Account/User Name
Group search filter	Search for the group using a keyword
Group name attribute	Attribute name for the LDAP group.
Member Of attribute	Attribute name for the "Member Of".
Search timeout(s)	Limits the time to perform a search
Search page size (objects)	Limits the number of search results
Two step authentication	Under LDAP there's a option for a secondary authentication so you give it a user name and password to login to the LDAP server. (Advanced Configuration)
Enabled	Check this box to enable two-step authentication.
User distinguished name	The user's distinguished name.

Table 10-151: Advanced LDAP Configuration (Continued)

<b>Preset Parameter</b>	<b>Description</b>
User password	The user's password.
Load default settings	The user can select to load system default settings.



## Groups

System rights are set by the Administrator. If you do not have rights to a feature/function, please contact the Administrator. If access is denied, a message in red will appear in the status line (such as “You do not have the required permission to perform...” or a dialog will be displayed with more information. In some cases, buttons or sections of the screen may simply be disabled if you do not have appropriate rights.



Figure 10-92. Groups Configuration

Table 10-152: Group List

Preset Parameter	Description
Add	This creates a new group.
Default Groups	BioMed, DiagPhys, Emergency User, Lead Sonographer, Operator, Physician, RefDoc, Sonographer, and SysAdmin.
SysAdmin	All Group Rights
BioMed	All Group Rights, except Admin. Can edit Imaging/Connectivity Utility pages. Can change the system time and date. Can access the Service Desktop. Cannot edit Admin Utility pages.
Lead Sonographer	Login, Create/Update/Delete/Transfer/Export Patient Data, Basic/Imaging Configuration, Authorize Remote Service Access, and Capture Logs. Can edit Imaging Utility pages. Cannot edit Connectivity or Admin Utility pages and cannot change the system time and date.
Sonographer	Login, Create/Update/Transfer/Export Patient Data, Basic Configuration, Authorize Remote Service Access, and Capture Logs

Table 10-152: Group List (Continued)

Preset Parameter	Description
Physician	Login, Create/Update/Delete/Transfer/Export Patient Data, Basic/Imaging Configuration, Authorize Remote Service Access, and Capture Logs
Emergency User	Login, Create/Transfer Patient Data. Only access to the Utility System and Search Tabs.

Table 10-153: Name and Description

Preset Parameter	Description
Id	The Id, from the Group List.
Description	A description of the Group List Id.

Table 10-154: Group Rights

Preset Parameter	Description
Rights assigned to each Group, by default	
Login	Allows users in this group to logon to the system.
Admin	Allows users in this group to have system administrator's rights. Can add/remove users and enable/disable encryption, etc.
Create Patient Data	Allows users in this group to create patient and exam data. This right is needed to register a patient and start an exam. Access to the following controls is prohibited without this right: New Patient, Register, and Save and Exit.
Update Patient Data	Allows users in this group to change patient and exam data. This right is needed to view patient and exam information stored in the patient database. Access to the following is prohibited without this right: Patient List, Exam List, Data Transfer screen, ability to delete images from the clipboard or active images screen, ability to delete reports from the Reports screen, ability to change to the USB Read Only workflow, ability to see all the jobs (except one's own) in the Spooler.

Table 10-154: Group Rights (Continued)

Preset Parameter	Description
Delete Patient Data	Allows users in this group to delete patient and exam data. This right is needed to use the Delete button on the Patient List and Exam List. Access to the following is prohibited without this right: Patient delete via Patient Registration and Patient List.
Transfer Patient Data	Allows users to transfer patient and exam data over DICOM. This right is needed for DICOM transfers over the network configured for Print keys and with Workflows. Access to the following is prohibited without this right: DICOM Image Storage, DICOM SR Storage, DICOM MPPS, DICOM Storage Commitment, and DICOM Print; Print button and Workflow; Koios DS in TCS; and Sent To from Patient Registration and Active Image Patient screens.
Export Patient Data	Allows users to export patient and exam data to media. This right is needed to Export, Save As, USB quick Save to media and for print functionalities. Access to the following is prohibited without this right: Executing a Save As, USB Quick Store, or Video Capture via a configured Print key, EZBackup, Printing or Saving a Report As, Print the Patient List; in TCS Standard Print Button, and Save As Images controls, Data Transfer screen functionality to perform an Export.
Import Patient Data	Allows users to import patient and exam data from media. This right is needed to import from media, Worklist download, or to use the Query/Retrieve feature.
Basic Configuration	Allows access to and modification of basic Utility pages, which everyone has access to, except members of the Emergency User's Group.
Imaging Configuration	Allows modification of imaging preset Utility pages. Note, If the "Require Admin Operator Rights to Save Imaging Settings" is checked on the Utility page, then the "Imaging Configuration" right can only be used by a SysAdmin.
Advanced Configuration	Allows access to and modification of advanced configuration pages.
Device Mgmt Configuration	Allows users in this group to activate and configure Device Mgmt Cloud configuration management tool.
Authorize Remote Service Access	Allows users to authorize service engineers to connect to the system remotely and perform service tasks.
Capture Logs	Allows users in this group to capture and export a system log to monitor system performance.
Capture Logs with PHI	Allows users in this group to export log files with PHI included.
Access Service Desktop	Allows users in this group to access the Service Desktop.
Software Management	Allows users in this group to access Software Download.

To set up a new group,

1. Select the Group.
2. Assign the Rights you wish this Group to have.

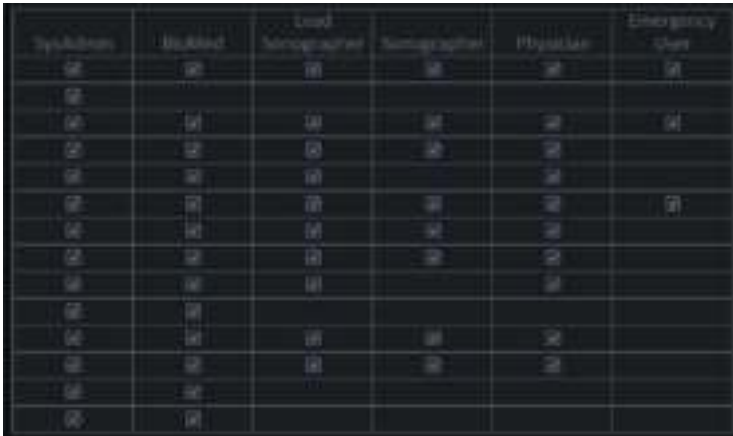
### System Password

The System Password is the Windows Password used by the LOGIQ Totus to automatically log into Windows. Users of the system will never need to use this password. The only reason to change the password will be if the user, for security reasons, prefers to define their own password instead of using the factory-created default password. As with all passwords, this should be treated with care and archived appropriately so that it can be provided to service personnel if necessary.

If you have changed the System Password, you must have the Current Password to change it.

To change the System Password,

1. Type your current password in the System Password field



**NOTE:** *There is no need to enter the “current password” to change the System Password if the System Password has not been previously changed from the factory default. The same is true for the Database Password.*

2. Type the new password in the New Password field.
3. Type the new password again in the Confirm Password field.
4. Press Save to save the new Password; then press Exit.

**NOTE:** *‘Windows System password’ is the password for the underlying Windows OS user running this application. Do not change this password unless you are the system administrator of the device. This password is not needed for users of the system. It will only be needed by GEHC service in special situations. If you change the password, be sure to keep the new password secured and available if needed by GEHC service.*

## Disk Encryption

Disk Encryption is designed to protect data privacy and assist your organization with HIPAA/HITECH compliance. Safeguards include:

- All patient data on the system's patient archive drive can be encrypted to provide protection in the event of a stolen device or hard drive.



### WARNING

If you've selected "Encryption ON. Key is stored on USB / password is entered manually" encryption and both password and recovery key are lost, you will not be able to access archived patient data (images and measurements included) nor store new patient data on this system.

The only way to recover the system to allow storing patient data is to reset the entire disk, which deletes all the archived patient data on the disk.

It is strongly recommended that all the patient data be stored in PACS or backed up to media prior to encrypting the disk.

In addition, it is recommended that the recovery key be stored on a USB storage device, printed, and kept in a secure location, ensuring that it will not be lost.



### CAUTION

Make sure the system power cable is plugged into external power. **DO NOT** attempt to perform the initial encryption function on battery power.

### Disk Encryption (continued)

The system encrypts patient data by default (Encryption On. Disks are unlocked automatically).

1. If you wish to change the default encryption setting, select the desired Encryption Policy, then press Accept.

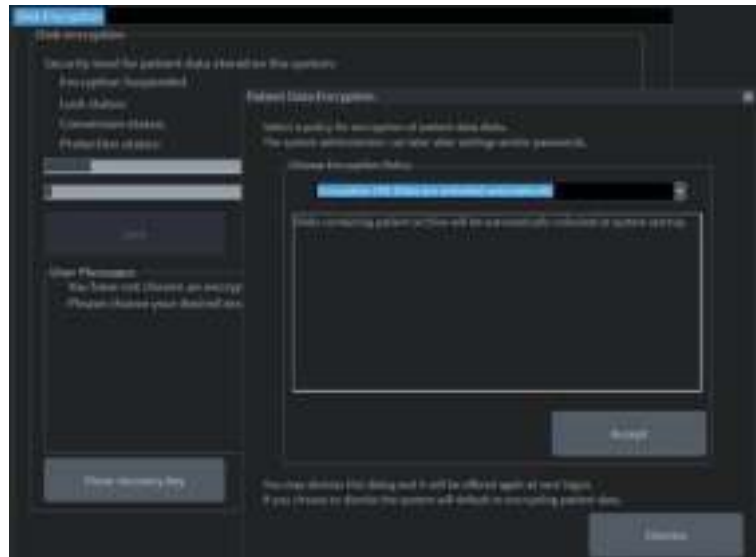

Figure 10-93. Initialize System Encryption

**NOTE:** *If you (or the Field Service Engineer) reloads system software, you will need to press “Initialize System Encryption” to encrypt the system and reset System Encryption password and preferences.*

## Disk Encryption (continued)

Table 10-155: Encryption Policy Selections

Encryption Policy	Description
Encryption OFF	Patient Data will not be encrypted. Selecting "OFF" will unencrypt the drive. System drive and recovery partition will remain encrypted.
Encryption ON. Disks are unlocked automatically	System Default. Patient data is encrypted and unlocked at system boot-up. Recovery Key and Password tied to the hard drive.
Encryption On. Require Pre-Boot PIN/Password before unlocking system drives	The system will not boot until the Pre-Boot PIN or Password has been entered. Unlike other manual key entry configurations, no system functionality is available without the PIN/Password. This encryption policy is intended for high security environments or customers with specific needs.
Encryption ON. Key is stored on USB / password is entered manually	The system will request the encryption password or recovery key at system startup. The system is not accessible until this password or a disk recovery key is provided. Requiring a password to access the patient archive may prevent emergency usage of the system.

**NOTE:** *If you choose to dismiss this dialog, you will be reminded to continue configuring encryption at each logon.*

## Disk Encryption (continued)

2. You must set the Encryption Password and record the Recovery Key in order to ensure access to your institution's patient data (required if replacing the system drive, ECB Board, or reformatting the C:\ Drive).
  - a. To reset the Encryption Password, "Change password."

NOTE:

*Press **NO** if this question pop-up appears: "Password is already set on a disk. Do you want to reuse it? Press Yes to reuse existing password. Press No to delete existing password. You will be prompted to set new."*

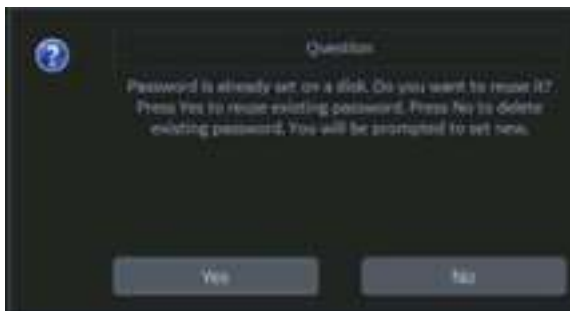

You can now update the encryption password, then press OK.





## Disk Encryption (continued)

3. Recovery Keys are not backed up by the system; you must record / archive the Recovery Key in order to retrieve patient data.



### CAUTION

Make sure to keep the password, recovery key, and any backup of these in a secure place, not accessible for any unintended audience.

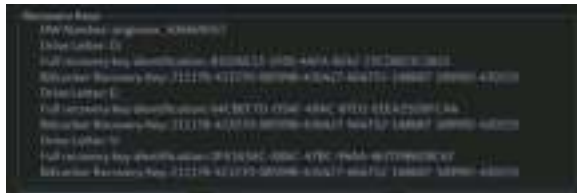

You can Show or Hide the Encryption key. Store the Recovery Key in a secure location, accessible to the ADM user as necessary.

- a. Insert the USB flash drive into a USB port to save the recovery key.

### NOTE:

*Use the USB flash drive as the repository only for the recovery key. DO NOT use it for data archiving or DVR recording.*

Save recovery key to a USB Flash Drive by pressing **Save recovery keys**.

- b. View the Recovery Key by pressing **Show recovery key**, then print it to a local printer or PACS.

Press the **Print key** to print the recovery key on the local printer.

- c. Press **Show recovery key** to display the recovery key on the screen.

Press **Hide recovery key** to hide the recovery key.

### Change password

Press **Change Password** to change the password as necessary.

### Change the recovery key

If you want to change the recovery key, select **Change recovery key** to generate a new key.

*NOTE: Generating a new key causes the previous key to expire.*

### Disk Encryption Frequently Asked Questions

Here are answers to some frequently-asked questions:

**Q** What type of encryption technology is used on my ultrasound system?

**A** The system uses Microsoft Bitlocker FDE configured to use FIPS-Compliant encryption protocols.

**Q** The system was accidentally turned off or lost power during the disk encryption process.

**A** Restart the system, and then go to Utility>Admin>Disk Encryption, select "On", ...resume, the disk encryption will continue

**Q** The USB recovery key was accidentally formatted. How do I access the system?

**A** If a password was created or the recovery key was written down, enter the information in the pop up window. Then go to Utility>Admin>Disc Encryption and Select **Change recovery key**. Be sure to print and save the new recovery key and store the USB in a secure location.

## **Disk Encryption Frequently Asked Questions (continued)**

**Q** Is it possible to stop encrypting the data?

**A** Utility>Admin>Disk encryption, select the “Off” radio button.  
The process to unencrypt may take up to 15 minutes.

**Q** Is there a step I need to take every day to encrypt new data?

**A** No, the encryption will happen in the background without the need for any additional manual steps.

**Q** The encryption was done it took nearly 90 minutes, is this going to happen every time the data is encrypted?

**A** No, after the initial encryption process is completed, new data will be encrypted automatically.

**Q** How does this protect the patient data?

**A** The data is unreadable by anyone who attempts to use the system without entering the password or recovery key.

**Q** I am using the system portable with Power Assistant, do I have to enter the password or recovery key after each exam?

**A** No, the password or recovery key will only need to be entered at each full boot up.

**Q** I do not have Power Assistant but I take the system portable occasionally do I need to enter the recovery key or password each time?

**A** Yes, the recovery key or password must be entered each time the system is turned on. If the USB with Recovery key is connected with each start up you will not need to manually enter the password or recovery key.

## **Disk Encryption Frequently Asked Questions (continued)**

**Q** The USB recovery key has been lost, how do I unlock the system?

**A** Manually enter the password or recovery key, then create a new USB key from the Disk Encryption page.

**Q** The USB recovery key and the password has been lost how do I unlock the disk?

**A** Contact your service, the system will need a base image and application reload. Create a new encryption key. \*Note the patient data on the system is not recoverable from this scenario. Always store patient data to a PACS or backup to external media.

**Q** If it is not possible to unlock the data can I still scan and what cannot be used?

**A** Yes: Unless the "Require Pre-Boot PIN/Password" Encryption policy option is selected, Live scan, measurement, "Save As" can be used to store on other media (USB, printer, etc). You can not access patient information, cannot access system Archive, cannot create an exam, cannot store to the hard drive, and DICOM Transfer is not possible.

## Audit Report and System Log Server Configuration



Figure 10-94. Audit Report

Table 10-156: Audit Report

Preset Parameter	Description
Report Filter: Specify the following criteria.	
Search Type	Select the type of search.
Date Range	Specify the "From" and "To" date range.
Status	Specify the status.
Anonymize	Indicate whether to anonymize the report (remote patient data).
Generate Report	Press to generate the report.
Report Information: Generated report information.	
Report File Path	The location where to place the generated report.
Report Status	Report status.

## Audit Report and System Log Server Configuration (continued)

The Audit Report System Log Server Configuration page allows you to customize where to draw information from for the Audit Report.

You are also able to connect the LOGIQ Totus to a centralized logging database at your institution to monitor for pattern analysis. This way, if your system is compromised, the data can be analyzed for incident response.

This centralizes all the system's data in the customer's data center -- It's like a DICOM connection page, but connects logs to a central location.

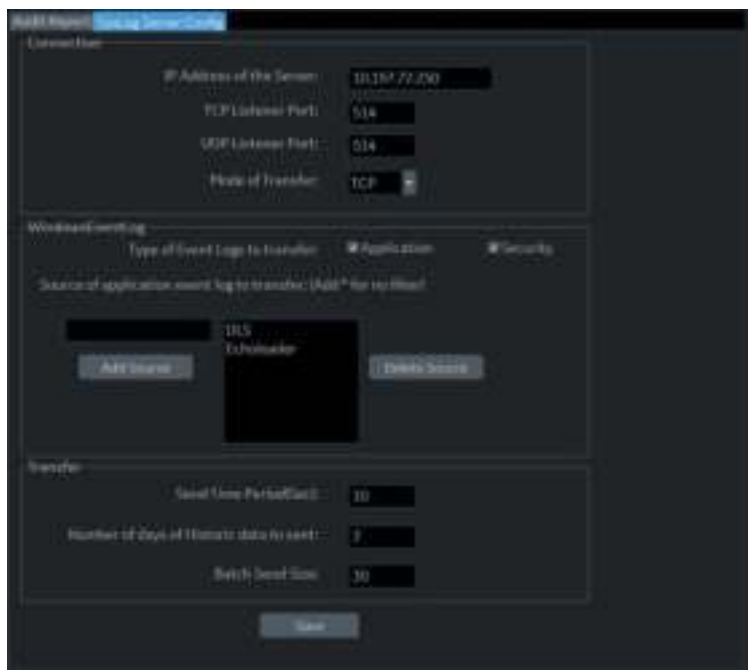

Figure 10-95. System Log Server Configuration

Table 10-157: System Log Server Configuration

Preset Parameter	Description
Connection.	
IP Address of the Server	The Server's IP address
TCP Listener Port	Transfer Control Protocol Listener Port. This is the port which we transfer logging data to use the syslog data protocol. It can be done by UDP or TCP, depending on the configuration of the customer logging server.

Table 10-157: System Log Server Configuration

Preset Parameter	Description
UDP Listener Port	User Datagram Protocol Listener Port. This is the port which we transfer logging data to use the syslog data protocol. It can be done by UDP or TCP, depending on the configuration of the customer logging server.
Mode of Transfer	Mode of transferring the data to the server (UDP, TCP, or TLS).
Windows Event Log	
Type of Logs to transfer	<ul style="list-style-type: none"> <li>• Application Logs</li> <li>• Security Logs</li> </ul>
Source of application event log to transfer: (Add * for no filter)	<ul style="list-style-type: none"> <li>• Add Source: The user needs to specify where to draw data from for the audit report.</li> <li>• Delete Source: Delete the event log source from the application.</li> </ul>
Transfer	
Send Time Period (Sec):	How often the system will attempt to contact the logging server to send logs.
Number of days of Historic data to send:	If logging server connectivity has not been available, how many days of history should be sent when it is restored?
EventLog Batch Send Size	When sending historic data, how much to send in each transaction – this can help manage network traffic and server load, not typically necessary to change this.

# Imaging Preset Manager

## Overview

The Imaging Preset Manager allows you to:

- Create and Edit User Presets
  - Update User Presets
  - Rename User Presets
  - Delete User Presets
- Arrange presets on the Touch Panel
- Share User Presets across LOGIQ Totus systems
  - Export User Presets
  - Import User Presets
- Configure MyPreset for probe
  - Update MyPreset Config for each probe if desired. Need for each probe separately. See 'Arranging MyPreset Tab' on *page 4-29 for more information.*

## Creating a User-Defined Application Preset

To create a User-Defined Application Preset,

1. From the Touch Panel, select the **Probe** icon at the top of the Touch Panel.
2. Select the **Application** you want to use as a basis for the new Application Preset.

You are now ready to create your own user preset.



## Creating a User-Defined Application Preset (continued)

3. Press **Save**. A pop-up menu appears: The Create New Application menu appears.



Figure 10-96. Create New User Pop-up Menu

4. Select **Create New**. The Create New Application menu appears.

**NOTE:** *The new user application is based upon the current exam and application, plus any modifications you have made, including the comment library and M&A calcs.*

**NOTE:** *The name of the new application cannot include spaces or symbols. However, the name can include numbers and letters.*

**NOTE:** *There is no limit to the number of user-defined application presets you can create for each exam category; you do not need to map all created presets to the Touch Panel.*

After you select to create the new preset, the Imaging Preset Manager screen appears. The preset you just created now appears in the Available Imaging Presets column. You'll notice that it has the name you assigned it ("GE HealthCare").

### Arranging Presets on the Touch Panel

On this screen, you specify where you want the new user (and existing) presets to appear on the exam's Touch Panel screen.



Figure 10-97. Steps to Add a User Preset

You can move the location of where the application appears on the Touch Panel via the Imaging Preset Manager (accessed from the Utility Touch Panel).

To reposition an application on the Touch Panel grid,

1. Select the Application to copy. Right click and select Create New.
2. Provide the new name.
3. The Imaging Preset Manager page appears (number not shown above).
4. Position the new application to appear at the desired Touch Panel location.
5. The new application appears on the Touch Panel.

## Updating User Presets

You can edit, reset to factory default, or delete any user preset you create, as long as you have selected it in the “Available Imaging Presets” column on the left.

### ***Editing Imaging Parameters***

To view/edit the parameters for the user-defined preset,

1. Adjust the image while in the user preset you want to edit.
2. Press the **probe** at the top of the Touch Panel screen.
3. Press **Save-->Overwrite** [Preset Name].
4. From the Utility--> Imaging menus.

### **To view/edit the parameters for the user defined preset**

1. Press Utility--> Imaging Preset Manager. Select the user preset you want to view/edit from Available Imaging Presets Column.

2. Press **Edit**. The Imaging page appears.
3. Edit the presets as necessary and press **Save**.

or

1. Adjust the image while in the user preset you want to edit.
2. Press the **probe**.
3. Press **Save-->Overwrite** [**Preset Name**].

## Renaming a User Preset

To rename a user preset,

1. Press Utility--> Imaging Preset Manager. Select the user preset you want to rename.
2. Press Rename. The Rename Preset pop-up menu appears.
3. Type the new name and press Rename.

### **Deleting a User Preset**

To delete a user preset,

1. Press Utility--> Imaging Preset Manager. Select the user preset you want to delete.
2. Press Delete. The Delete Preset pop-up menu appears.
3. Confirm that you want to delete this user preset and press OK.

## Sharing User Presets between LOGIQ Totus Systems

You can share the user presets you have created between LOGIQ Totus systems by exporting/importing the preset(s) you want to share.

To move a user preset from one LOGIQ Totus to another LOGIQ Totus system (same software level), first export the user preset(s) you wish to share.

### Exporting User Presets

To export a user preset (or presets),

1. Activate the *Imaging Preset Manager* from the Utility Touch Panel.
2. Insert the media.
3. Press **Export** (on the bottom).
4. An Export Presets pop-up menu appears that indicates:
  - a. destination location (USB Flash Drive/Hard Disk Drive drive location).
  - b. preset directory where the preset should be saved (Preset Export).
  - c. available presets on the scanner.

Select the name for the Preset Directory from the Preset Directory pull-down.

5. Select the User Defined Presets under Available presets on Scanner and press Export.
6. Upon a successful Export, an informational message will pop-up indicating that "1 preset successfully exported." Press Ok. Then press Exit to close the Export Presets pop-up menu.
7. Press F3 to Eject the media. Take the media to the other LOGIQ Totus and follow the Importing User Presets instructions below.

### Importing User Presets

To import a User Preset,

1. Activate the **Imaging Preset Manager** from the Utility Touch Panel.
2. Insert the media (Flash Drive, USB Hard Drive).
3. Press Import. The Import Presets pop-up appears and displays the Source Directory and Available Imaging Presets.
4. Select the “User Defined Presets” under Available Imaging Presets and press Import.

If these presets are already on this LOGIQ Totus, you will be asked whether you want to:

- Overwrite this preset (Yes, Yes to All, No, or No to All).
  - Rename this preset (Type the new name and press Rename).
  - Cancel
5. Upon a successful Import, an informational message will pop-up indicating that “1 preset successfully imported.” Press Ok. Then press Exit to close the Import Presets pop-up menu.
  6. Press F3 to Eject the media.

### Retain Field of View

Selecting Retain Field of View ensures that the Imaging Parameters shown in the table below stay constant over Probe and Preset changes.

Table 10-158: Retain Field of View

Mode	Probe	Retain Field of View Imaging Parameters
B-Mode, Harmonics, Contrast and B-Flow	Convex and Sector	Depth, Tilt, Zoom, Width
	Linear	Virtual Convex, Zoom, Depth, Steer
Color Flow Mode	Convex and Sector	ROI Size/Position
	Linear	ROI Size/Position, CF Virtual Convex, CF Steer
Doppler Mode		Doppler Cursor Position

# Backup and Restore

## Overview

The Backup/Restore function enables the user to copy and restore system presets, settings and service configurations, and enables the user to configure several units with identical configurations (providing the units have the same software version).

Depending on the system, you can use either a USB Flash Drive, or USB Hard Disk for system backup/restore.

To minimize accidental loss of data, backup system presets, settings and service configurations, **DAILY** to formatted media and/or to the local hard drive (manually or automatically). Presets and service configurations can be restored to the local hard drive using the restore procedure.

*NOTE: To perform backup and restore procedures, you must login with administrator privileges.*

### Backup

#### Media Backup

1. Insert media into the drive or USB device into a USB port.
2. On the Touch Panel, press **Utility**.
3. On the Utility Touch Panel, press **System**.
4. On the monitor display, select **Backup/Restore**.  
The Backup/Restore screen is displayed.

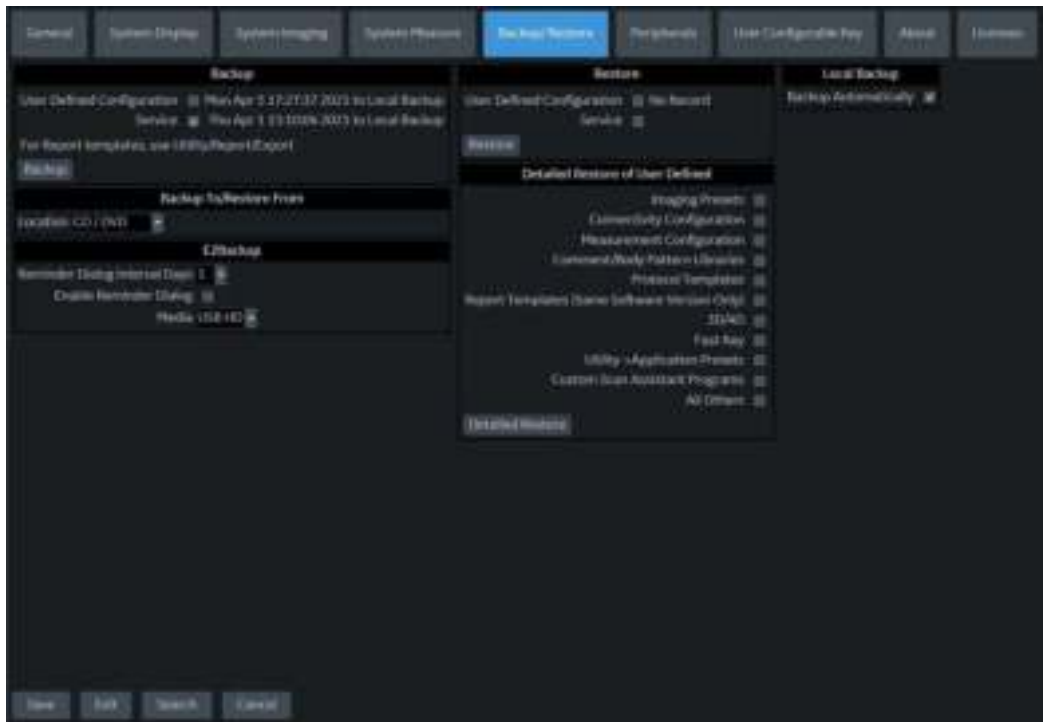

Figure 10-98. System/Backup/Restore Preset Menu

5. In the *Backup* field, select *User Defined Configuration* and/or *Service* to copy system presets, settings and service configurations.
6. Select USB Drive F to save data in the Backup To/Restore From field.



### **Media Backup (continued)**

7. Select **Backup**.  
The system performs the backup. As it proceeds, status information is displayed on the Backup/Restore screen.
8. At the end of the process, the Backup completed message is displayed on the monitor.  
Press **Eject** (F3) to eject media/disconnect USB device.
9. Make sure to physically label the media. An identification of the system should also be noted on the media and a backup log should be kept.  
Store the media in a safe place.

### **Local Backup**

Select *Backup Automatically* under *Local Backup* to automatically backup User Defined configurations to the system hard drive when the configuration is changed and saved.

Select Manual Backup to manually backup User Defined configurations to the system hard drive.

### **Backup Automatically**

1. Check **Backup Automatically** under Local and Cloud Backup.
2. Select **Local Backup** under Backup To/Restore From.
3. Press **Save**.

User Defined Configuration files are automatically backed up to Local Backup, when configuration is changed and then saved.

### **Manual Backup**

1. Select **Local Backup** under Backup To/Restore From.
2. Press **Backup** under Backup.

### Restore from Media or Local Backup



#### WARNING

The restore procedure overwrites the existing database on the local hard drive. Make sure to insert the correct media. You cannot restore system presets, settings and service configurations between systems with different software versions. To minimize accidental loss of data, perform backup of the patient archives stored on the local hard drive periodically.

1. On the Touch Panel, press **Utility**.
2. On the Utility Touch Panel, press **System**.
3. On the monitor display, select **Backup/Restore**.  
The Backup/Restore screen displays. (See Figure 10-98 on page 10-190.)
4. In the *Restore* list, select *User Defined Configuration* and/or *Service* to restore system presets, settings and/or service configurations.
5. **If restoring from Media:** Ensure the appropriate source device is selected in the *Media* field and select **Restore from Media**.  
**If restoring from Local Backup:** Select **Restore from Local Backup**.  
The system performs the restore. As it proceeds, status information displays on the Backup/Restore screen.
6. The LOGIQ Totus restarts automatically when Restore is done.

## **Preset Synchronization Using Media**

The procedure for preset synchronization of several scanners using media is as follows:

1. Make a backup of the user-defined configurations on a removable media from a fully configured LOGIQ Totus system.
2. Restore user-defined configurations from the removable media to another LOGIQ Totus system (you can restore all the user-defined presets or select specific presets to restore via Detailed Restore).

*NOTE: User Defined Configurations are compatible with LOGIQ E10, E10s and Fortis, EXCEPT for Imaging preset.*

## Utility Parameter Search

Opens up a search window to find a parameter on the utility pages.

To search for a utility parameter,

1. Press **Search** from the Utility Touch Panel or from another Utility page.
2. Type in the search string. For instance, if you're searching for Zoom you would just type 'zoom'.
3. A list of possible matches appears to the right. Select the correct match.

*NOTE: You cannot perform a search on the Measure, Reports, Imaging Preset Manager, Scan Assistant, or Service Utility pages.*

---

# Chapter 11

## Probes and Biopsy

*This chapter consists of the information of each probe and describes some special concerns, biopsy kits and accessories as well as basic procedures for attaching a biopsy guide to the different types of probes.*

# Probe Overview

## Ergonomics

Probes have been ergonomically designed to:

- Handle and manipulate with ease
- Connect to the system with one hand
- Be lightweight and balanced
- Have rounded edges and smooth surfaces.
- Stand up to typical wear by cleaning and disinfectant agents, contact with approved gel, etc.

Cables have been designed to:

- Connect to system with appropriate cable length

## Supported Probes

### Introduction

The LOGIQ Totus supports the following types of probes:

- Matrix Array probes
- Convex Array probes
- Linear Array probes
- Micro Convex Array probes
- Sector Phased Array probes
- Split Crystal
- Volume Probes (4D)



**CAUTION**

Probes for transvaginal and transrectal applications require special handling. Transvaginal/transrectal examinations and probe insertions should be performed only by personnel with adequate training. Refer to the user documentation enclosed with these probes.

**Probe Description**

Table 11-1: Probe Applications and Features

Probe	Clinical Applications	Capabilities and Features	Illustration
C1-6-D	<ul style="list-style-type: none"> <li>• Abdomen (incl. Pleural)</li> <li>• OB/GYN</li> <li>• Pediatric</li> <li>• Peripheral Vascular</li> <li>• General musculoskeletal</li> </ul>	<ul style="list-style-type: none"> <li>• Easy3D/Avanced3D</li> <li>• Tru3D</li> <li>• PDI</li> <li>• M-Mode</li> <li>• Anatomical M-Mode</li> <li>• LOGIQView</li> <li>• Contrast</li> <li>• B-Flow/Hybrid B-Flow</li> <li>• CrossXBeam</li> <li>• Shear Wave and Strain Elastography</li> <li>• UGAP</li> <li>• MVI/Contrast MVI</li> <li>• Biopsy</li> </ul>	
C1-6VN-D		<ul style="list-style-type: none"> <li>• Easy3D/Avanced3D</li> <li>• Tru3D</li> <li>• V-Nav</li> <li>• PDI</li> <li>• M-Mode</li> <li>• Anatomical M-Mode</li> <li>• LOGIQView</li> <li>• Contrast</li> <li>• B-Flow/Hybrid B-Flow</li> <li>• CrossXBeam</li> <li>• Shear Wave and Strain Elastography</li> <li>• UGAP</li> <li>• MVI/Contrast MVI</li> <li>• Biopsy</li> </ul>	

Table 11-1: Probe Applications and Features (Continued)



Probe	Clinical Applications	Capabilities and Features	Illustration
C2-7-D	<ul style="list-style-type: none"> <li>• Abdomen</li> <li>• Pediatric</li> </ul>	<ul style="list-style-type: none"> <li>• Easy3D/Avanced3D</li> <li>• PDI</li> <li>• M-Mode</li> <li>• Anatomical M-Mode</li> <li>• LOGIQView</li> <li>• CrossXBeam</li> <li>• Contrast</li> <li>• B-Flow</li> <li>• Biopsy</li> </ul>	
C2-7VN-D		<ul style="list-style-type: none"> <li>• Easy3D/Avanced3D</li> <li>• PDI</li> <li>• M-Mode</li> <li>• Anatomical M-Mode</li> <li>• LOGIQView</li> <li>• CrossXBeam</li> <li>• Contrast</li> <li>• V-Nav</li> <li>• Tru3D</li> <li>• B-Flow</li> <li>• Biopsy</li> </ul>	
C3-10-D	<ul style="list-style-type: none"> <li>• Neonatal</li> <li>• Pediatric</li> <li>• Neonatal transcranial</li> <li>• Peripheral Vascular</li> <li>• Small Parts</li> <li>• Abdomen</li> </ul>	<ul style="list-style-type: none"> <li>• Easy3D/Avanced3D</li> <li>• PDI</li> <li>• M-Mode</li> <li>• Anatomical M-Mode</li> <li>• LOGIQView</li> <li>• CrossXBeam</li> <li>• Contrast</li> <li>• B-Flow</li> <li>• V-Nav</li> <li>• Tru3D</li> </ul>	
IC5-9-D	<ul style="list-style-type: none"> <li>• OB/GYN</li> <li>• Urology</li> </ul>	<ul style="list-style-type: none"> <li>• Easy3D/Avanced3D</li> <li>• PDI</li> <li>• M-Mode</li> <li>• Anatomical M-Mode</li> <li>• LOGIQView</li> <li>• Contrast</li> <li>• Shear Wave and Strain Elastography (GYN and Urology only)</li> <li>• V-Nav</li> <li>• Tru3D</li> <li>• Biopsy</li> </ul>	



Table 11-1: Probe Applications and Features (Continued)



Probe	Clinical Applications	Capabilities and Features	Illustration
9L-D	<ul style="list-style-type: none"> <li>• Peripheral Vascular</li> <li>• Abdomen (incl. Pleural)</li> <li>• OB/GYN</li> <li>• Small Parts</li> <li>• Pediatrics</li> <li>• Neonatal*</li> <li>• Neonatal transcranial*</li> <li>• General musculoskeletal</li> <li>• Superficial musculoskeletal</li> <li>• Breast</li> </ul>	<ul style="list-style-type: none"> <li>• Easy3D/Advanced3D</li> <li>• PDI</li> <li>• M-Mode</li> <li>• LOGIQView</li> <li>• Virtual Convex</li> <li>• Contrast</li> <li>• CrossXBeam</li> <li>• B-Flow/Hybrid B-Flow</li> <li>• MVI/Contrast MVI</li> <li>• Shear Wave and Strain Elastography</li> <li>• V-Nav</li> <li>• Tru3D</li> <li>• Biopsy</li> </ul>	
L6-24-D (May not be available in all countries.)	<ul style="list-style-type: none"> <li>• Musculoskeletal</li> <li>• Small Parts</li> <li>• Neonatal Abdomen</li> <li>• Neonatal Transcranial</li> <li>• Breast</li> <li>• Peripheral Vascular</li> <li>• Abdomen</li> </ul>	<ul style="list-style-type: none"> <li>• LOGIQView</li> <li>• Virtual Convex</li> <li>• CrossXBeam</li> <li>• B-Flow/Hybrid B-Flow</li> <li>• MVI</li> <li>• PDI</li> </ul>	
L3-12-D	<ul style="list-style-type: none"> <li>• Vascular</li> <li>• Abdomen (incl. Pleural)</li> <li>• OB</li> <li>• Small Parts</li> <li>• General musculoskeletal</li> <li>• Superficial musculoskeletal</li> <li>• Neonatal</li> <li>• Neonatal transcranial</li> <li>• Pediatrics</li> <li>• Breast</li> </ul>	<ul style="list-style-type: none"> <li>• Easy3D/Advanced3D</li> <li>• PDI</li> <li>• M-Mode</li> <li>• LOGIQView</li> <li>• Virtual Convex</li> <li>• Contrast</li> <li>• CrossXBeam</li> <li>• B-Flow/Hybrid B-Flow</li> <li>• MVI/Contrast MVI</li> <li>• Strain and Shear Wave Elastography</li> <li>• Biopsy</li> </ul>	

Table 11-1: Probe Applications and Features (Continued)



Probe	Clinical Applications	Capabilities and Features	Illustration
ML6-15-D	<ul style="list-style-type: none"> <li>• Abdomen</li> <li>• Small Parts</li> <li>• Peripheral Vascular</li> <li>• Pediatrics</li> <li>• Neonatal</li> <li>• Neonatal transcranial</li> <li>• General musculoskeletal</li> <li>• Superficial musculoskeletal</li> <li>• Breast</li> </ul>	<ul style="list-style-type: none"> <li>• Easy3D/Avanced3D</li> <li>• PDI</li> <li>• M-Mode</li> <li>• LOGIQView</li> <li>• Virtual Convex</li> <li>• Contrast</li> <li>• CrossXBeam</li> <li>• B-Flow/Hybrid B-Flow</li> <li>• MVI/Contrast MVI</li> <li>• Shear Wave and Strain Elastography</li> <li>• V-Nav</li> <li>• Tru3D</li> <li>• Biopsy</li> </ul>	
M5Sc-D	<ul style="list-style-type: none"> <li>• Adult cardiac</li> <li>• Pediatric cardiac</li> <li>• Adult cephalic</li> <li>• Abdomen (incl. Pleural)</li> </ul>	<ul style="list-style-type: none"> <li>• Easy3D/Avanced3D</li> <li>• PDI</li> <li>• M-Mode</li> <li>• Anatomical M-Mode</li> <li>• Curved Anatomical M-Mode</li> <li>• Color M</li> <li>• LOGIQView</li> <li>• Virtual Convex</li> <li>• Contrast</li> <li>• Anatomical M-Mode</li> <li>• B-Flow</li> <li>• CW</li> <li>• TVI/TVD</li> <li>• V-Nav</li> <li>• Tru3D</li> <li>• Biopsy</li> </ul>	
6S-D	<ul style="list-style-type: none"> <li>• Pediatric cardiac</li> <li>• Pediatric abdomen (incl. Pleural)</li> </ul>	<ul style="list-style-type: none"> <li>• Easy3D/Avanced3D</li> <li>• PDI</li> <li>• M-Mode</li> <li>• Anatomical M-Mode</li> <li>• Curved Anatomical M-Mode</li> <li>• Color M</li> <li>• LOGIQView</li> <li>• Virtual Convex</li> <li>• CW</li> <li>• TVI/TVD</li> </ul>	

Table 11-1: Probe Applications and Features (Continued)







Probe	Clinical Applications	Capabilities and Features	Illustration
RAB6-D	<ul style="list-style-type: none"> <li>• OB/GYN</li> <li>• Abdomen</li> <li>• Pediatric</li> <li>• Neonatal</li> </ul>	<ul style="list-style-type: none"> <li>• PDI</li> <li>• M-Mode</li> <li>• Anatomical M-Mode</li> <li>• LOGIQView</li> <li>• Contrast</li> <li>• CrossXBeam</li> <li>• Realtime 4D</li> <li>• Static3D</li> <li>• Biopsy</li> </ul>	
RIC5-9-D	<ul style="list-style-type: none"> <li>• OB/GYN</li> <li>• Urology</li> </ul>	<ul style="list-style-type: none"> <li>• PDI</li> <li>• M-Mode</li> <li>• Anatomical M-Mode</li> <li>• LOGIQView</li> <li>• Contrast</li> <li>• CrossXBeam</li> <li>• Realtime 4D</li> <li>• Static3D</li> <li>• BetaView</li> <li>• Biopsy</li> </ul>	
12S-D	<ul style="list-style-type: none"> <li>• Pediatrics</li> <li>• Pediatric cardiac</li> <li>• Neonatal cardiac*</li> </ul>	<ul style="list-style-type: none"> <li>• CW</li> <li>• Virtual Convex</li> <li>• PDI</li> <li>• M-Mode</li> <li>• Anatomical M-Mode</li> <li>• Curved Anatomical M-Mode</li> <li>• Color M</li> <li>• TVI/TVD</li> <li>• Easy3D/Advanced3D</li> </ul>	
P2D	<ul style="list-style-type: none"> <li>• Adult cardiac</li> <li>• Pediatric cardiac</li> <li>• Peripheral vascular</li> <li>• Adult cephalic</li> </ul>	<ul style="list-style-type: none"> <li>• CW</li> </ul>	
P6D	<ul style="list-style-type: none"> <li>• Adult cardiac</li> <li>• Pediatric cardiac</li> <li>• Peripheral vascular</li> <li>• Adult cephalic</li> </ul>	<ul style="list-style-type: none"> <li>• CW</li> </ul>	

Table 11-1: Probe Applications and Features (Continued)

Probe	Clinical Applications	Capabilities and Features	Illustration
Vscan Air CL (Curved array transducer)	<ul style="list-style-type: none"> <li>• Abdomen</li> <li>• Cardiac</li> <li>• MSK</li> <li>• OB</li> <li>• Vascular</li> <li>• Lung</li> </ul>	<ul style="list-style-type: none"> <li>• B-Mode</li> <li>• Color Folw</li> <li>• Easy3D</li> <li>• LOGIQView</li> </ul>	
Vscan Air CL (Linear array transducer)	<ul style="list-style-type: none"> <li>• Vascular</li> <li>• Nerves</li> <li>• Small Parts</li> <li>• MSK</li> <li>• Lung</li> <li>• Neo Head</li> </ul>	<ul style="list-style-type: none"> <li>• B-Mode</li> <li>• Color Folw</li> <li>• Easy3D</li> <li>• LOGIQView</li> </ul>	

\*This application is not supported in Canada

## **Beta View**

Beta View enables you to steer the probe head in elevation direction without moving the probe. This feature is available on the 4D RIC5-9-D probe during live scanning and is especially useful during an endovaginal or neonatal head exams.

The Beta View Touch Panel control appears on the B-Mode Touch Panel when you select either of these two probes. You can adjust the Beta View control Right/Left or Up/Down. When you press down on the Beta View control, the probe head re-centers itself.

Beta View is not available while the image is Frozen, during an image Recall, during a Biopsy procedure, or during Volume Navigation. When these controls are selected, the Beta View Touch Panel control is hidden and unavailable.

## Probe orientation

Each probe is provided with an orientation marking. This mark is used to identify the end of the probe corresponding to the side of the image having the orientation mark on the display.

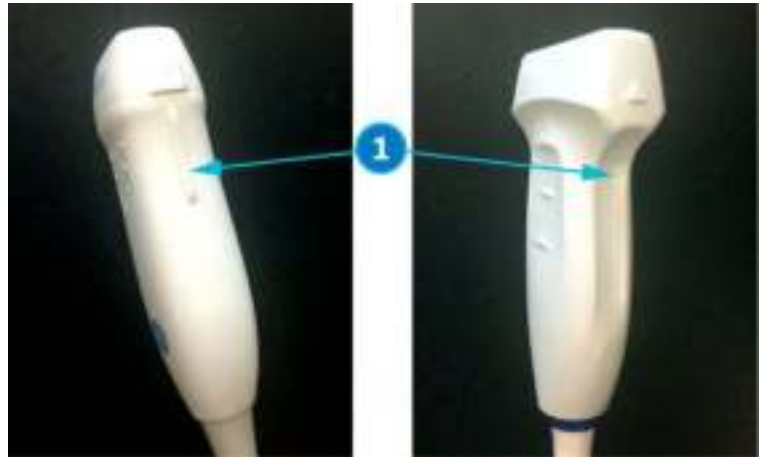

Figure 11-1. Orientation Marking on Probe (Example)



Figure 11-2. Probe orientation marker on the display

1. Orientation Mark

## Probe Naming Conventions

Table 11-2: Probe Naming Convention

Real Time 4D	Type	Application	Frequency	Connector Type
"R"	C=Convex L=Linear M=Matrix S=Sector	AB=Abdominal IC=Intracavitary	"1-5"	D=DLP RS= RS Connector with RS-DLP Adapter LC=Long Cord

# Probe Safety

## Care and Handling

The following recommendations help to reduce preventable probe damage.



**WARNING**

Failure to follow the precautions listed in the Probe Care Recommendations table can result in serious injury and/or equipment damage.



**WARNING**

3D/4D probes should not be used for continuous scanning for more than 25 minutes. Continuous scanning is defined as scanning without freezing the image. 3D/4D probes can be used for more than 25 minutes during an exam in cases where imaging is periodically frozen.

**NOTE:** *If 3D/4D probes are operated in continuous 4D mode for an unusually extended period of time, the surface temperature of the handle might get warm and exceed the limit specified in IEC60601-1. The temperature of the applied part will stay within the limits according to IEC60601-2-37.*

Table 11-3: Probe Care Recommendations

Do:	Don't Do:
Handle all probes with extreme care.	DO NOT drop or knock the probe or probe lens. Impacting the probe lens face can cause fractures of the crystal elements leading to failure.
Ensure that connected probes are placed in the probe holder yoke when not in use. Be sure to utilize the endocavitary probe holder and the probe inserts for the 3D and small aperture probes that were provided at delivery.	DO NOT leave probes in places where they may be knocked over or dropped.
Use wall-mounted probe holders with lens facing upward.	Ultrasonic cleaning IS NOT approved for GE HealthCare probes.

Table 11-3: Probe Care Recommendations (Continued)

Do:	Don't Do:
<p>Visually inspect probes and cables for damage prior to connecting them to the LOGIQ Totus. If a probe appears to be damaged, discontinue use and notify your GE HealthCare Customer Service Representative. Possible damage may include, but is not limited to:</p> <ul style="list-style-type: none"> <li>• Bent or broken probe pins</li> <li>• Cable cuts or splitting</li> <li>• Surface cracks</li> <li>• Exposed wires or shielding</li> <li>• Fluid leaks</li> </ul>	<p>DO NOT drop probes into holders or into disinfectant containers with the probe's lens face down. Even a short drop can damage a probe.</p>
<p>Disconnect probes from the system prior to cleaning or disinfecting the probe.</p>	<p>DO NOT let probe cables dangle loosely from the LOGIQ Totus where they might be caught in the wheels/casters while moving.</p>
<p>Ensure you follow the chemical manufacturer recommendations regarding the use and handling of the chemical.</p>	<p>DO NOT immerse probes deeper than permissible levels. NEVER immerse the connector or adapter into any liquid.</p>
<p>Clean and disinfect all probes following the procedures contained in this manual.</p>	<p>DO NOT kink, tightly coil, or apply excessive force on the probe cable or TEE shaft. Insulation failure may result.</p>

## Handling precautions



### DANGER

Ultrasound probes are highly sensitive medical instruments that can easily be damaged by improper handling. Use care when handling and protect from damage when not in use. DO NOT use a damaged or defective probe. Failure to follow these precautions can result in an increase probability of disease progression, injury and equipment damage.



### CAUTION

Endocavity probes require a special handling. Refer to the user documentation enclosed with these probes.



## Electrical shock hazard



Electrical  
Hazard

The probe is driven with electrical energy that can injure the patient or user if live internal parts are contacted by conductive solution:

- **DO NOT** immerse the probe into any liquid beyond the level indicated by the immersion level diagram. Refer to the immersion illustration in the Probe Cleaning Process section. Never immerse the probe connector or probe adaptors into any liquid.
- **DO NOT** drop the probes or subject them to other types of mechanical shock or impact. Degraded performance or damage such as cracks or chips in the housing may result.
- Prior to each use, visually inspect the probe lens and case area for cracks, cuts, tears, and other signs of physical damage. **DO NOT** use a probe which appears to be damaged until you verify functional and safe performance. You must perform a more thorough inspection, including the cable, strain relief, and connector, each time you clean the probe.
- Before inserting the connector into the probe port, inspect the probe connector pins. If a pin is bent, do not use the probe until it has been inspected and repaired/replaced by a GE HealthCare Service Representative.
- **DO NOT** kink, tightly coil, or apply excessive force on the probe cable. Insulation failure may result.
- Electrical leakage checks should be performed on a routine basis by GE HealthCare Service or qualified hospital personnel. Refer to the service manual for leakage check procedures.

## Special handling instructions

### Using protective sheaths



**WARNING**

Protective barriers may be required to minimize disease transmission. Probe sheaths are available for use with all clinical situations where infection is a concern. Use of legally marketed, sterile probe sheaths is mandatory for intra-cavitary and intra-operative procedures. Failure to follow these instructions could lead to exposure to infectious agents.



**WARNING**

Devices containing latex may cause severe allergic reactions in latex sensitive individuals. Refer to FDA's March 29, 1991 Medical Alert on latex products.



**WARNING**

DO NOT use an expired probe sheath. Before using probe sheaths, verify whether the term of validity has expired. Failure to follow these instructions could lead to exposure to infectious agents.



**CAUTION**

Do not use pre-lubricated condoms as a sheath. In some cases, they may damage the probe. Lubricants in these condoms may not be compatible with probe construction.

**Instructions.** Custom made sheaths are available for each probe. Each probe sheath kit consists of a flexible sheath used to cover the probe and cable and elastic bands used to secure the sheath.

Sterile probe sheaths are supplied as part of biopsy kits for those probes intended for use in biopsy procedures. In addition to the sheath and elastic bands, there are associated accessories for performing a biopsy procedure which are included in the kit. Refer to the biopsy instructions for the specific probes in the Discussion section of this chapter for further information.

**Reordering.** To reorder sheaths, please contact your local distributor or the appropriate support resource.

## Endocavitary Probe Handling Precautions

If the disinfectant solution comes out of the endocavitary probe, please follow the cautions below.



### WARNING

Sterile/sanitary sheaths are to be used on the probe during its actual use with patients. Wearing gloves protects the patient and operator. Failure to follow these instructions could lead to exposure to infectious agents.



### WARNING

**Disinfectant Exposure to Patient (e.g., Cidex)**—Contact with a disinfectant to the patient's skin or mucous membrane may cause an inflammation. If this happens, refer to the disinfectant's instruction manual.

**Disinfectant Exposure from Probe Handle to Patient (e.g., Cidex)**—DO NOT allow the disinfectant to contact the patient. Only immerse the probe to its specified level. Ensure that no solution has entered the probe's handle before scanning the patient. If disinfectant comes into contact with the patient, refer to the disinfectant's instruction manual.

**Disinfectant Exposure from Probe Connector to Patient (e.g., Cidex)**—DO NOT allow the disinfectant to contact the patient. Only immerse the probe to its specified level. Ensure that no solution has entered the probe's connector before scanning the patient. If disinfectant comes into contact with the patient, refer to the disinfectant's instruction manual.

**Endocavitary Probe Point of Contact**—Refer to the disinfectant's instruction manual.

Failure to follow these instructions could lead to inflammation of skin or mucous membrane.

**NOTE:** *Sporadically, silicone grease can leak in small amounts from the probes' cable bushing. This leakage is not a failure and is not harmful to the human body. Silicone grease does not contain any hazardous substances and is only use to seal the cable bushing. In the case of a leakage, wipe the grease with a cloth.*

## Probe handling and infection control



**WARNING**

ALWAYS clean and disinfect the probe according to the probe specific instructions, including probe compatible chemicals between patients to the level appropriate for the type of examination and use FDA-cleared probe sheaths where appropriate. Failure to follow these instructions could lead to exposure to infectious agents.



**WARNING**

Adequate cleaning and disinfection are necessary to prevent disease transmission. It is the responsibility of the equipment user to verify and maintain the effectiveness of the infection control procedures in use. Always use sterile, legally marketed probe sheaths for intra-cavitary and intra-operative procedures.



**WARNING**

To minimize the risk of infection from blood-borne pathogens, you must handle the probe and all disposables which have contacted blood, other potentially infectious materials, mucous membranes, and non-intact skin in accordance with infection control procedures. You must wear protective gloves when handling potentially infectious material. Use a face shield and gown if there is a risk of splashing or splatter.

This information is intended to increase user awareness of the risks of disease transmission associated with using this equipment and provide guidance in making decisions directly affecting the safety of the patient as well as the equipment user.

Diagnostic ultrasound systems utilize ultrasound energy that must be coupled to the patient by direct physical contact. Depending on the type of examination, this contact occurs with a variety of tissues ranging from intact skin in a routine exam to recirculating blood in a surgical procedure. The level of risk of infection varies greatly with the type of contact.

One of the most effective ways to prevent transmission between patients is with single use or disposable devices. However, ultrasound transducers are complex and expensive devices that must be reused between patients. It is very important, therefore, to minimize the risk of disease transmission by using barriers and through proper processing between patients.

# Care and Maintenance

## Before first use

- Inspect the probe
- Clean the probe
- Disinfect the probe

## Inspecting probes



### WARNING

If any damage is found, do not use the probe until it has been inspected and repaired/replaced by a GE HealthCare Service Representative. Failure to follow these precautions can result in injury and equipment damage.

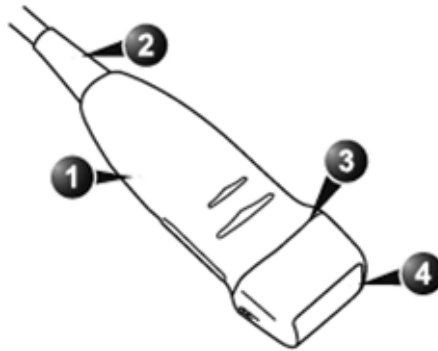

Figure 11-3. Probe parts

- |                  |         |
|------------------|---------|
| 1. Casing        | 3. Seal |
| 2. Strain relief | 4. Lens |

## **Visual Inspection**

Housing, connection, operating elements, display facilities, labels, accessories, user manual.

## **Perform After Each Use**

Inspect the probe's lens, cable, casing, and connector. Look for any damage that would allow liquid to enter the probe.

*NOTE: Keep a log of all probe maintenance, along with a picture of any probe malfunction.*

## Probe Reprocessing

### Probe Care Cards

The Probe Care Card contains a list of chemicals that have been tested for compatibility with GE HealthCare Ultrasound probes. The reprocessing instructions provided in this document have been validated with the chemicals specified in Table 11-6 on page 11-36.

Additional requirement to the already available reprocessing Instruction (5661328): Each probe shall be cleaned and disinfected before initial use.

The Probe Care Card is supplied with every probe and may also be downloaded from:

Table 11-4: Documentation Web Site

<b>Support Documentation Web Site</b>
<a href="https://www.gehealthcare.com/documentation">https://www.gehealthcare.com/documentation</a>

Adequate cleaning and disinfection between patient cases are necessary to prevent transmission of disease. All probes must be thoroughly cleaned prior to disinfection. The level of disinfection required is based on patient contact.

- To verify probe chemical compatibility, a full list of chemicals tested is available at the GE HealthCare Probe website Table 11-5 on page 11-19.
- Probes that contact mucosal or non-intact skin require cleaning followed by High-Level Disinfection either soaking or use of a trophon® EPR or trophon2.
- Probes that contact intact skin require cleaning followed by Intermediate-Level Disinfection (wipe or spray).

Table 11-5: Probe Web Site

<b>Ultrasound Probe Web Site</b>
<a href="https://www.gehealthcare.com/transducers">https://www.gehealthcare.com/transducers</a>

## Probe Pre-Treatment at the Point of Use (Required for All Probes)

The pre-treatment step is for removal of gel and gross contamination.

1. After each use, remove protective sheath from the probe and remove the coupling gel by wiping from the strain relief to the lens with a soft, low-lint cloth.



### CAUTION

DO NOT use abrasive products or brushes when cleaning or wiping a GE HealthCare Ultrasound probe. The use of abrasive wipes can damage the soft lens (acoustic window). To extend the life of the probe lens, pat dry only.

2. Wipe the cable with one of the wipes listed in probe compatibility website from the strain relief to the connector. Wipe the cable with a low-lint cloth dampened with potable water to remove chemical residue. Dispose of the cloth, wipe and gloves in the clinical trash.

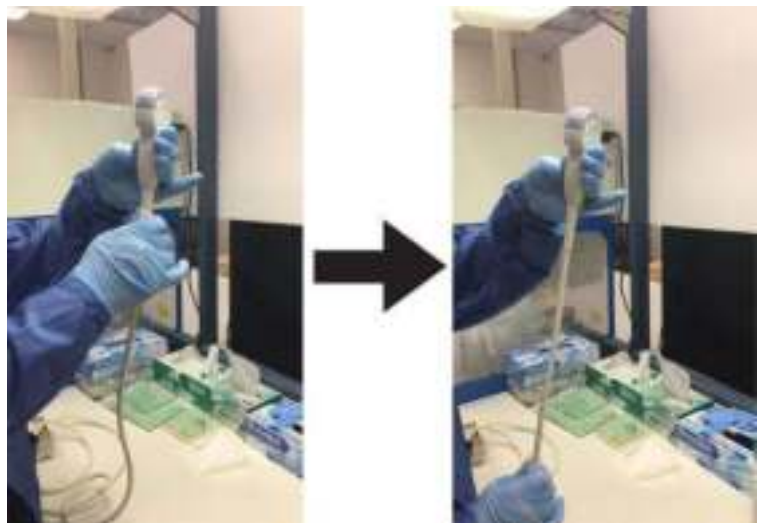

Figure 11-4. Cleaning the Probe Cable

**NOTE:** *Use of wipes listed in the Ultrasound Probe website may result in discoloration of the cable.*



## Probe Pre-Treatment at the Point of Use (Required for All Probes)

(continued)



### CAUTION

Use caution when cleaning the connector. This cable connector should only be cleaned with a slightly dampened cloth or wipe. Exposure to excessive moisture will result in damage to the probe and possibly the ultrasound console. DO NOT wet the connector/console interface surface or labels.

3. After each use, inspect the lens, cable, and housing of the probe. Look for any damage that would allow liquid to enter the probe.



### DANGER

If the probe is damaged, do not place it into any liquid (e.g. for disinfection) and do not use it until it has been inspected and repaired/replaced by a GE HealthCare Service Representative.



Figure 11-5. Inspect the Lens, Cable, and Probe House After Each Use

1. Cleaning only portion
2. Cleaning only or cleaning and disinfection portion
3. Cleaning followed by appropriate level of disinfection

### Probe Manual Cleaning Instructions

Thorough cleaning is a mandatory first step to allow adequate subsequent disinfection or sterilization. **Choose the most convenient method, either the wipe or enzymatic soak.**



#### WARNING

DO NOT clean the probe in an automated washer-disinfector, due to the possible damage of the connector/console interface.

Use necessary precautions (e.g., gloves, face screen and gown), as directed by your facility.

### Cleaning with Wipes

1. Hold the probe by the handle near the cable strain relief. **DO NOT** suspend or hold the probe by the cable as this may damage the probe.
2. Dispense a cleaning wipe from the wipe canister.
3. Gently wipe the probe with a cleaning wipe from the cable strain relief to the acoustic lens (i.e. from cleanest to dirtiest area). Gently wipe the probe's acoustic lens.

#### NOTE:

***Pay special attention to acoustic lens, edges, and crevices, removing all gel, product, and body fluids.***

4. Turn the probe and continue wiping until the entire surface of the probe has been wiped. As the wipe becomes visibly soiled, discard the wipe into clinical trash and dispense fresh wipes as needed.
5. As needed for additional focused cleaning to crevices, wrap a clean wipe around a soft nylon bristle brush or other suitable instrument to access crevices, such as biopsy notches.
6. Visually inspect the probe for any remaining soil and, if necessary, repeat steps 3 through 5 until the probe is visibly clean.
7. Thoroughly dry the probe using a clean, low-/non-linting, soft cloth or wipe. Pat dry acoustic lens.

#### NOTE:

*Clean the probe holder of the ultrasound system before returning the probe back to the system. (Refer to the probe holder cleaning instruction in ultrasound system user manual for details).*

### Cleaning with Enzymatic Detergent

1. Ensure the probe has been disconnected from the console. Replace gloves and fill a sink or basin with warm potable water (30 - 40°C) to a level allowing immersion of the probe up to the immersion line shown in the user manual.
2. Prepare the cleaning solution in accordance with the detergent manufacturer's instructions.
3. Immerse the probe in the prepared cleaning solution up to the immersion line and ensure no air bubbles are trapped on the surface.



CAUTION

DO NOT submerge probe beyond the immersion line shown in the Ultrasound console's user manual.

*NOTE: For IC5-9-D, E8C and E8C-RS, see Figure 11-12 on page 11-32 for special immersion instructions.*

*NOTE: Over-exposing ultrasound probes to cleaning solution may damage the ultrasound probe.*

4. Brushing with a clean, soft, nylon bristle brush from the base of the cable strain relief to the distal tip is critical to ensure cleaning and disinfection efficacy.



Figure 11-6. Cleaning the probe using a brush



CAUTION

Do not use the brush on the probe lens.

### Cleaning with Enzymatic Detergent (continued)



Figure 11-7. Probe Lens Examples

5. Continue brushing the probe for not less than the minimum contact time listed on the detergent manufacturer's label.
6. Visually inspect the probe for soil. Repeat Steps 3 through 5 until all visible soil has been removed from the surface of the probe.
7. Rinse the probe under running warm potable water (30 - 40°C) for not less than 2 minutes. Scrub the surface of the probe with a clean, soft, nylon bristle brush from the base of the cable strain relief to the distal tip.



#### CAUTION

DO NOT use the brush on the probe lens.

**NOTE:** *Discard solutions and rinse waters in accordance with local regulations.*

8. Visually inspect the device in a well-lit area to ensure all surfaces are free from residual cleaning solution. Repeat Step 7 if visible cleaning solution is observed.
9. Thoroughly dry the probe using a clean, low-lint, soft cloth or wipe. Pat dry lens.



#### CAUTION

DO NOT use a twisting motion or abrasive paper products when wiping the probe as this may damage the soft lens. To extend the life of the probe lens, pat dry only.

**NOTE:** *Clean the probe holder of the ultrasound system before returning the probe back to the system. (Refer to the probe holder cleaning instruction in ultrasound system user manual for details).*

## Cable and Connector Manual Cleaning

The connector can be cleaned with a wipe dampened with alcohol. Use caution when cleaning the connector, wring wipe to remove excess of liquid before wiping the connector. Prevent introduction of foreign objects in the system connector assembly. Do not apply excessive force on any component of the system connector



### WARNING

Exposure to excessive moisture will result in damage to the probe and possibly the ultrasound console. DO NOT wet the connector/console interface surface or labels (Refer to red circles in picture below). DO NOT clean the probe in an automated washer-disinfector.



Figure 11-8. Connector/console interface surface and label

The cable should be processed using cleaning/disinfectant wipes. If the cable has been in contact with risk factors, such as blood and/or mucous, cleaning should be followed by disinfection.

1. Dispense a cleaning/disinfectant wipe from the wipe canister

2. Wipe the cable with a cleaning/disinfectant wipe from the handle strain relief to the connector strain relief. As the wipe becomes visibly soiled, discard the wipe into clinical trash and dispense fresh wipes as needed

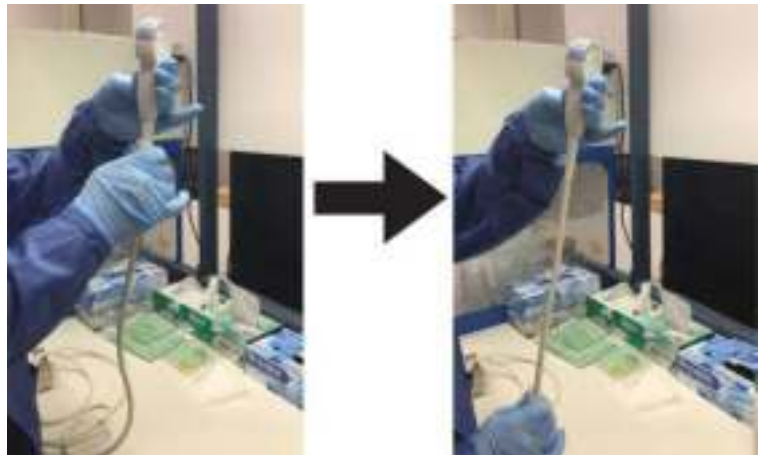

Figure 11-9. Cleaning the Probe Cable

**NOTE:** *Some detergents and disinfectants might cause discoloration to the probe's cable.*

3. Visually inspect the cable for any remaining soil and, if necessary, repeat cleaning until the cable is visibly clean  
If disinfection is needed, dispense a new cleaning/disinfectant wipe and continue wiping the cable. Use as many wipes as needed, to ensure all surfaces remain wet for the minimum required contact time mentioned in Table 11-6 on page 11-36. Discard the wipes into clinical trash.
4. Saturate a soft, low-/non-linting cloth with Critical Water (remove excess water, wipe should be damp but not dripping) and thoroughly wipe all surfaces of the cable to remove chemical residues. Discard the cloth into clinical trash.

**NOTE:** *Critical Water is water that is treated (usually by a multistep treatment process that could include a carbon bed, softening, DI, and RO or distillation) to ensure that the microorganisms and the inorganic and organic material are removed from the water to an appropriate level (Refer to AAMI TIR34/ST108). Use of this type of water will reduce the recontamination of probes during processing.*

5. Let the cable air dry until visibly dry

## Probe Intermediate-Level Disinfection (ILD)

**For Intermediate-Level Disinfection of intact skin contacting probes, choose either the spray or wipe method.**

**NOTE:** *Probes that contact only intact skin may be disinfected in this manner. All probes that contact non-intact skin or mucous membranes (e.g., endocavitary, Transesophageal) require High-Level Disinfection.*



### CAUTION

After each use, inspect the lens, cable, and housing of the probe. Look for any damage that would allow liquid to enter the probe.



### DANGER

If the probe is damaged, **DO NOT** place it into any liquid (e.g. for disinfection) and **DO NOT USE** until the probe has been inspected and repaired/replaced by a GE HealthCare Service Representative.

## Probe ILD - Disinfectant Spray or Wipe

**NOTE:** *Disinfectant exists either in pre-impregnated wipe or in spray. The spray should be sprayed onto a low-/non-linting cloth and then used in same way as a pre-impregnated wipe. In steps 1 to 4 of this section, “wipe” will then stand for a pre-impregnated wipe as well as for a low-/non-linting cloth saturated with disinfectant.*

Do not spray disinfectant onto the probe directly.

Use necessary precautions (e.g. gloves, face screen and gown), as directed by your facility.

1. Dispense a new wipe.
2. Holding the probe near the strain relief, wipe the acoustic lens and handle areas. Slightly rotate the probe after each wiping pass and continue wiping until all areas of the probe and handle have been wetted. Wring the wipe above recessed areas and ridges for dripping liquid directly onto the less accessible surfaces.
3. Using fresh wipes, repeat step 2 as many times as needed to ensure all surfaces remain wet for the minimum required contact time listed in Table 11-6 on page 11-36

**Probe ILD - Disinfectant Spray or Wipe (continued)**

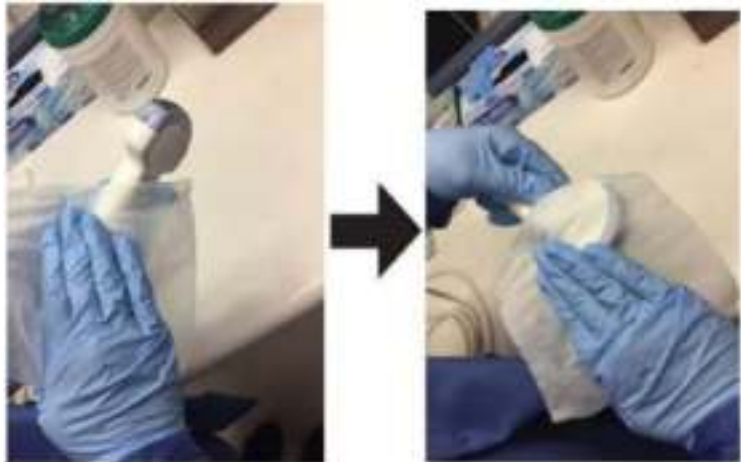

Figure 11-10. Disinfecting the Probe with slight rotation

4. Saturate a soft, low-/non-linting wipe with Critical Water (remove excess water, wipe should be damp but not dripping) and thoroughly wipe all surfaces of the probe to remove chemical residue. Discard the wipe into clinical trash.

**NOTE:** *Critical Water is water that is treated (usually by a multistep treatment process that could include a carbon bed, softening, DI, and RO or distillation) to ensure that the microorganisms and the inorganic and organic material are removed from the water to an appropriate level (Refer to AAMI TIR34/ST108). Use of this type of water will reduce the recontamination of probes during processing.*

5. Thoroughly dry all surfaces of the probe using a soft, low-lint wipe or cloth, changing wipes/cloths when necessary to ensure the probe is completely dry. Pat dry acoustic lens. Visually inspect the probe to ensure all surfaces are dry. Repeat drying steps if any moisture is visible.
6. If the probe is not immediately reused, store the probe in a manner that will protect and keep the probe from being recontaminated. Refer to the Probe Transportation and Storage section for additional information.

**NOTE:** *Ensure that probe holder of the ultrasound system has been disinfected before returning the probe back to the system (refer to the probe holder disinfection instruction in ultrasound system user manual for details).*



## Probe High-Level Disinfection (HLD)

**High-Level Disinfection is required for devices that contact intact mucous membranes or non-intact skin. High Level Disinfection can be performed using either disinfectant wipes (only for some probes), a disinfectant soaking method or an automated system such as trophon EPR and trophon2.**



### WARNING

**DO NOT** disinfect the probe in an automated washer-disinfector, due to the possible damage of the connector/console interface.



### DANGER

If the probe is damaged, remove it from patient use. Clean and disinfect the probe before contacting your GE HealthCare Service Representative for inspection and repair/replacement.



### CAUTION

After each use, inspect the acoustic lens, cable, and housing of the probe. Look for any damage that would allow liquid to enter the probe.

*NOTE: Handles of semi-critical probes that are not submerged during High-Level Disinfection require at minimum Intermediate-Level Disinfection to avoid cross contamination.*

*NOTE: All probes must be thoroughly cleaned and dried prior to High-Level Disinfection.*

### Probe HLD - Soak

1. Ensure the probe has been disconnected from the console. Replace gloves and fill a sink or basin with High-Level Disinfectant diluted in accordance with the disinfectant manufacturers instructions to a level allowing immersion of the probe up to immersion line shown in Figure 11-11 *on page 11-31*.



#### CAUTION

Ensure no liquid comes into contact with the probe connector pins or labels.

2. Immerse probe in the disinfectant up to the immersion line and ensure no air bubbles are trapped. Ensure the probe remains in the disinfectant for at least the minimum contact time listed in the disinfectant manufacturer's instructions for use.

Probe HLD - Soak (continued)

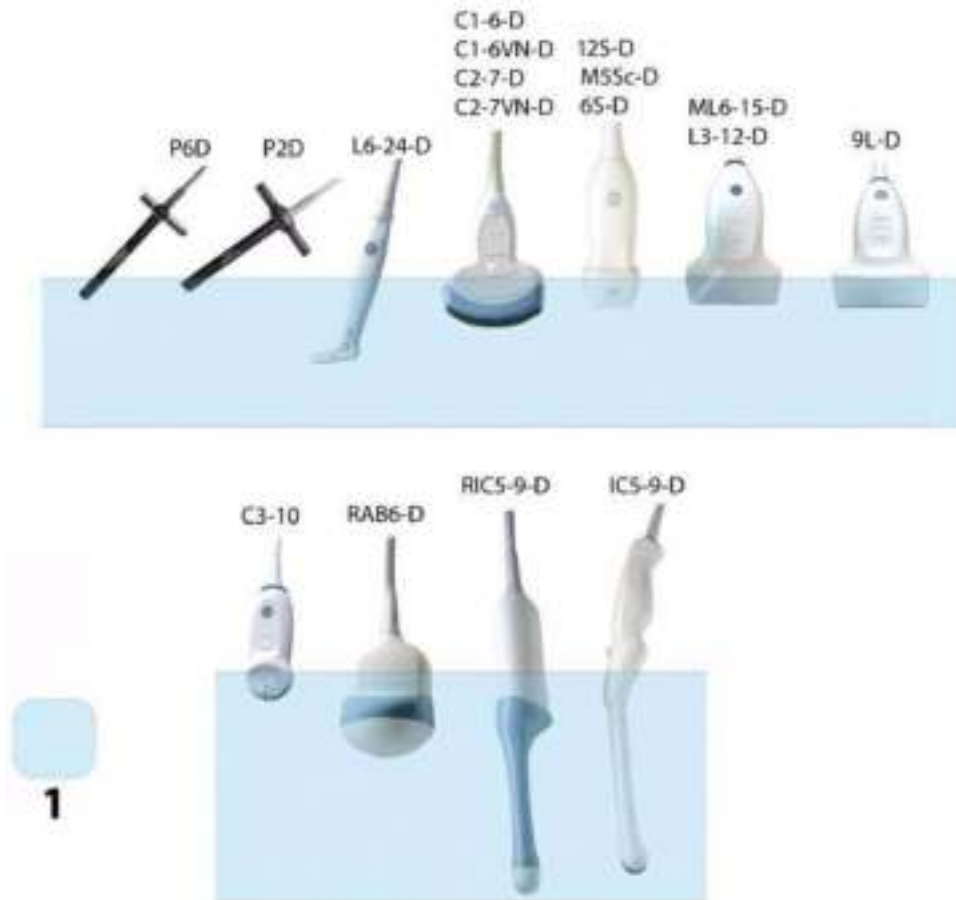

Figure 11-11. Probe Immersion Levels, 1 = Fluid Level

For IC5-9-D probe with serial numbers listed below or greater, refer to Figure 11-12 *on page 11-32* for the soaking level:

- IC5-9-D: 780333WX1 or greater (example 780334WX1, 780335WX1)

The prefix number, i.e. 780333 for 780333WX1, indicates serial number sequence.

Probe HLD - Soak (continued)



Figure 11-12. Probe Immersion Level for IC5-9-D

1. Serial number location

**NOTE:** *Over-exposing ultrasound probes to high-level disinfectants may damage the ultrasound probe. NEVER exceed the disinfectant manufacturer's maximum exposure time.*



**CAUTION**

Ensure that the probe is suspended. The probe face should not be resting against the tank/basin surface and should be in full contact with the liquid. Carefully place the probe in the basin, taking care not to damage the transducer lens.



Figure 11-13. Probe suspended in disinfectant basin

3. Thoroughly rinse the probe by immersing it in a large volume of critical (purified) water for a minimum of 1 (one) minute. Remove the probe and discard the rinse water. Do not reuse the water. Always use fresh volumes of water for each rinse. Repeat Step 3 two additional times, for a total of 3 (three) rinses.

**NOTE:** *Critical Water is water that is treated (usually by a multistep treatment process that could include a carbon bed, softening, DI, and RO or distillation) to ensure that the microorganisms and the inorganic and organic material are removed from the water to an appropriate level (Refer to AAMI TIR34/ST108). Use of this type of water will reduce the recontamination of probes during processing.*

## Probe HLD - Soak (continued)



### CAUTION

Failure to properly rinse probes with water following disinfection may cause skin irritation. Failure to follow these instructions could lead to inflammation to skin or mucosal membrane.

4. Thoroughly dry all surfaces of the probe using a soft, low-lint wipe or cloth, changing wipes' cloths when necessary to ensure the probe is completely dry. Pat dry lens. Visually inspect the probe to ensure all surfaces are clean and dry. Repeat drying steps if any moisture is visible.
5. If the probe is not immediately reused, store the probe in a manner that will protect and keep the probe from being recontaminated. This may be accomplished by placing the probe in a storage cabinet with filtered air flow and/or by using a disposable storage cover placed over the probe.

The instructions provided above have been validated to properly prepare GE HealthCare Ultrasound probes for re-use. It remains the responsibility of the processor to ensure that the processing is performed as specified in this document. This may require verification and routine monitoring of the process.

### Probe HLD - trophon® EPR or trophon2

When performing High-Level Disinfection of GE HealthCare ultrasound probes with the trophon EPR and trophon2, it is not necessary to disconnect the probe from the ultrasound system. The probe must be inactive (not selected) during the disinfection cycle.

1. This automated disinfection replaces the manual HLD, but manual cleaning still needs to be performed prior to automated HLD. Refer to manual cleaning instructions mentioned in this document.
2. Follow the trophon instructions for probe placement and operation of the trophon system. Incorrect positioning of the probe may lead to probe/cable damage and High-Level Disinfection not being achieved.



#### CAUTION

Damage to the cable may occur if improperly hung. Damage to the probe may occur if the probe is placed in contact with the trophon chamber wall. Curved probes must be correctly positioned in the chamber using the Curved Probe Positioner (CPP) supplied with the trophon EPR system, or with the Integrated Probe Positioner (IPP) of trophon2 system.

3. Once the trophon High-Level Disinfection cycle is complete, use necessary precautions (e.g. gloves), as directed by your facility and promptly remove the probe from the trophon machine. DO NOT store the probe in the trophon chamber.
4. Hold the probe's handle near the strain relief cable. DO NOT suspend or hold the probe by the cable, as this may damage the probe.

**Probe HLD - trophon® EPR or trophon2 (continued)**

5. Wipe the probe from the acoustic lens to strain relief with a clean, low-/non-linting, soft cloth or wipe to remove any possible residual hydrogen peroxide from the probe surface.



**CAUTION**

USE non-abrasive cloth or wipe, such as Kimwipes™, Delicate Task Wipers or equivalent. DO NOT use a twisting motion when wiping the probe. To extend the life of the probe acoustic lens, pat dry only.

6. If the probe is not immediately reused, store the probe in a manner that will protect and keep the probe from being recontaminated. Refer to the Probe Transportation and Storage section for additional information.

## Chemicals Used for Efficacy Validation

The table below lists the products and intended use (clean, Intermediate-Level Disinfection, High-Level Disinfection) that were validated.

Table 11-6: Chemicals used for Efficacy Validation

Product Type	Trade Name	Manufacturer	Minimum Contact Time	Active Ingredient
Cleaning (Wipe)	Oxivir® Tb	Diversey	N/A	Hydrogen Peroxide
Enzymatic Detergent (Soak)	Enzol® (Cidezyme®)	Advanced Sterilization Products® (J&J)	1-Minute Soak	Proteolytic Enzymes
	MetriZyme™	Metrex™		
	Prolystica® 2X Concentrate Presoak & Cleaner	Steris		
Intermediate-level Disinfectant (wipe)	Oxivir® Tb	Diversey	10-Minute Exposure	Hydrogen Peroxide
High-level Disinfectant (Soak)	Cidex® OPA	Advanced Sterilization Products (J&J)	10-Minute Soak	Ortho-phthalaldehyde
	McKesson OPA/28	McKesson		

A full list of chemicals tested for compatibility is available at the GE HealthCare Probe Web Site:

Table 11-7: Probe Web Site

Ultrasound Probe Web Site
<a href="http://www.gehealthcare.com/transducers">http://www.gehealthcare.com/transducers</a>

**NOTE:** *The tables in this manual indicate the status when this manual was published. Please visit the website for the latest information.*



## Covering the Transducer using a Sterile, Protective Sheath



CAUTION

Probe sheaths are disposable and must not be reused.



CAUTION

Protective barriers may be required to minimize disease transmission, but their use does not replace cleaning and disinfection. Probe sheaths are available for use with all clinical situations where infection is a concern. Use of legally marketed, sterile probe sheaths is recommended for intra-cavitary, intra-operative, and biopsy procedures.

1. Place an appropriate amount of gel inside the protective sheath and/or on the transducer face.

**NOTE:** *Failure to use imaging gel may result in poor image quality.*

2. Insert transducer into sheath, making sure to use proper sterile technique. Pull cover tightly over transducer face to remove wrinkles and air bubbles, taking care to avoid puncturing the sheath.

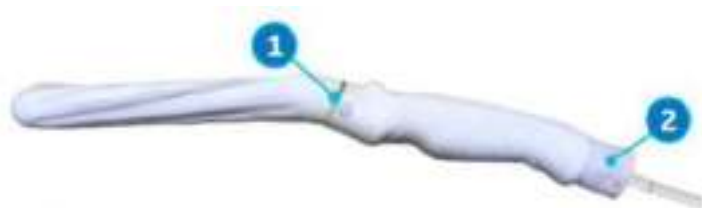

Figure 11-14. Applying the Sheath

1. Secure the Sheath with a rubber band.
2. The probe sheath should extend past the end of the probe to the probe's cable.

**NOTE:** *No gel was applied to the probe in this photo.*

3. Secure the sheath in place.

**NOTE:** *Failure to use a sheath that fully covers the transducer to the cable strain relief may lead to cross-contamination of the transducer.*

4. Inspect the sheath to ensure there are no holes or tears. If the sheath becomes compromised, stop the procedure and replace immediately.
5. After usage, discard the sheath into clinical trash.

## Probe Cleaning and Disinfecting Notes



### CAUTION

Each probe shall be cleaned and disinfected before initial use.



### DANGER

Ultrasound transducers can easily be damaged by improper handling and by contact with certain chemicals. Failure to follow these precautions can result in serious injury and equipment damage.

- Do not immerse the probe into any liquid beyond the level specified for that probe. Never immerse the transducer connector or probe adapters into any liquid.
- Avoid mechanical shock or impact to the transducer and do not apply excessive bending or pulling force to the cable.
- Transducer damage can result from contact with inappropriate coupling or cleaning agents:
  - Do not soak or saturate transducers with solutions containing alcohol, bleach, ammonium chloride compounds or hydrogen peroxide (except in the case of using trophon's hydrogen peroxide).
  - Avoid contact with solutions or coupling gels containing mineral oil or lanolin
  - Avoid temperatures above 60°C (except with trophon for approved probes).
- Inspect the probe prior to use for damage or degeneration to the housing, strain relief, lens and seal. Do not use a damaged or defective probe.
- Use only the products that are listed on the Transducer website or on the Probe Care Card enclosed with the probe. In addition, refer to the local/national regulations.



### WARNING

Do not steam, heat autoclave on general surface probes.

## Probe Cleaning and Disinfecting Notes (continued)



CAUTION

### CREUTZFELDT-JAKOB DISEASE

Neurological use on patients with this disease must be avoided. If a probe becomes contaminated, there is no adequate disinfecting means.



CAUTION

DO NOT expose the system/probe connector to any moisture or liquids.



CAUTION

Take extra care when handling the lens face of the Ultrasound transducer. The lens face is especially sensitive and can easily be damaged by rough handling. NEVER use excessive force when cleaning the lens face.



CAUTION

In order for liquid chemical disinfectants to be effective, all visible residue must be removed during the cleaning process. Thoroughly clean the probe, as described earlier before attempting disinfection.

You MUST disconnect the probe from the LOGIQ Totus prior to cleaning/disinfecting the probe. Failure to do so could damage the system.

DO NOT soak probes in liquid chemical disinfectant for longer than is stated by the disinfectant instructions for use. Extended soaking may cause probe damage and early failure of the enclosure, resulting in possible electric shock hazard.

## Probe Cleaning and Disinfecting Notes (continued)



CAUTION

Avoid cross-contamination, follow all infection control policies established by your office, department or hospital as they apply to personnel and equipment.



CAUTION

- Do not use paper products or products that are abrasive when cleaning the probe. They damage the soft lens of the probe.
- Before storing the probes, ensure that they are thoroughly dry. If it is necessary to dry the probe after cleaning, blot the probe with a soft cloth.



CAUTION

Probes must be cleaned and disinfected before they are replaced or disposed of.

**NOTE:** *Cleaning products should be as close to neutral PH as possible. Any gel, cleaning, or disinfectant products containing concentrations, surfactants, methanol, ethanol, benzyl or methyl alcohol, mineral oil, lubricant oil, oil-based lotions, acetone, ammonia, anhydrous ammonia, iodine, iodine compounds, acids with 5PH or greater may damage or discolor your probe. Ultrasonic cleaning is not approved for GE HealthCare probes.*

**NOTE:** *DO NOT re-use cloths or wipes. Soap, detergents, or enzymatic cleaners should be used in accordance with the manufacturer's instructions. GE HealthCare is not responsible for damage incurred during the cleaning process for products which no material compatibility evaluation has been conducted.*

## Probe Disinfectants

### Choosing a Disinfectant

**NOTE:** For latest chemicals tested for compatibility, check the GE HealthCare Probe Website at the link listed in Table 11-8.

Table 11-8: Probe Web Link

Ultrasound Probe Web Site
<a href="http://www.gehealthcare.com/transducers">http://www.gehealthcare.com/transducers</a>

When choosing a disinfectant, determine the required level of disinfection. If the possibility of cross-contamination or exposure to unhealthy or non-intact skin exists, then high level disinfection should be performed. Good hand hygiene practice is highly recommended to help further reduce the risk of cross-contamination.



**CAUTION**

Disinfectant wipes and topical spray products are not FDA cleared high level disinfectants and do not provide adequate protection should the probe become cross contaminated or in contact with unhealthy or non-intact skin. Failure to appropriately disinfectant could lead to exposure to infectious agent(s).



**CAUTION**

Review the probe care card that is packed with each probe.

**NOTE:** For additional information about cleaning and disinfection, refer to the recommendations of the Association for Professionals in Infection Control (APIC), the U.S. Food and Drug Administration (FDA), and the U.S. Centers for Disease Control (CDC). For country-specific disinfection regulations, check with your local regulatory infection control authorities.

**NOTE:** GE HealthCare publishes a list of material-compatible disinfectants (see below and also refer to the GE HealthCare website at [http://www3.gehealthcare.com/en/Products/Categories/Ultrasound/Ultrasound\\_Probes](http://www3.gehealthcare.com/en/Products/Categories/Ultrasound/Ultrasound_Probes)). DO NOT use non-GE HealthCare-approved disinfectants or products that have not been evaluated by GE HealthCare for material compatibility. Damages linked to the use of disapproved

*chemicals are not covered under product warranty or service contract.*

## trophon EPR Probe High-Level Disinfection

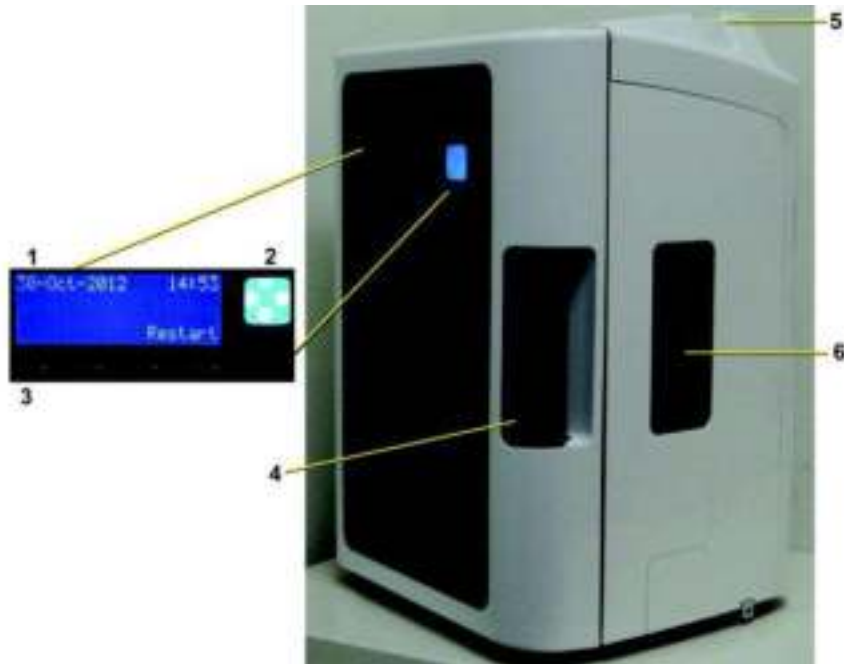

Figure 11-15. trophon EPR

1. Screen Display
2. Start Button
3. Soft key buttons

4. Chamber door handle
5. Probe cable clamp
6. Cartridge door



### CAUTION

Only those individuals previously trained on the trophon EPR or trophon2 unit may use the device. Refer to the trophon EPR or trophon2 user documentation for more information on disinfecting approved probes.

## trophon EPR Instructions for Use

### Installing the disinfectant cartridge

1. The cartridge door automatically opens when a cartridge needs replacing.
2. Screen message: “Load Cartridge” or “Cartridge Empty, Replace Cartridge Now” displays.
3. Wear disposable gloves and chemical resistant goggles. These should be worn at all times while using the trophon EPR.
4. Press the soft key button under “Yes” to open the cartridge replacement door.
5. Remove the cartridge lid and insert the bottle on the side of the unit.
6. Rotate the cartridge until it drops into place and cannot rotate any further.
7. Close the cartridge door. Do not use excessive force to accomplish this. The door clicks into place and locks.

### Disinfecting probe in trophon EPR

8. When the screen message reads “Load Probe”, open the chamber door.
9. Clean and rinse the probe. Dry the probe.
10. Place Chemical Indicator on the bottom of the device chamber.
11. While holding the probe handle, press the top of the probe into the chamber’s seal. Ensure the probe is straight and not touching either the walls or bottom of the chamber. Strain relief (interface between cable and probe body) must be positioned at the top of the chamber. The tip of the probe must be above the horizontal line marked in the chamber.

**NOTE:**

*The probe must be cleaned, per the manufacturer’s guidelines, and dried before disinfection.*



**CAUTION**

Do NOT allow the probe surface or lens to touch the chamber’s wall during the disinfection process. This could cause permanent damage to the probe.



**trophon EPR Instructions for Use (continued)**

12. Press the probe's electrical cable into the cable clamp, found at the top of the chamber.
13. Close the chamber door. It will automatically lock.
14. The screen message "Is the probe clean and dry?" appears, select Yes.
15. Press "Start" to begin the disinfecting process.
16. Discard disposable gloves.

**Removing the Probe after 7-minute cycle time**

1. Wear a new pair of disposable gloves.
2. When "Cycle complete" displays on the screen, open the chamber door.
3. Check the Chemical Indicator color change and refer to the Chemical Indicator on the box.
4. Remove the Chemical Indicator from device and discard.
5. Remove the probe from the trophon EPR.
6. Wipe the probe prior to use with an absorbent, single-use, dry, low-lint cloth.
7. Remove and discard the disposable gloves.

## Coupling Gels



**CAUTION**

Do not use unrecommended gels (lubricants). They may damage the probe and void the warranty.

Table 11-9: Probe Gels

Gel	9L-D	L3-12-D	L6-24-D	ML6-15-D	M5Sc-D	6S-D	12S-D	C1-6-D/C1-6VN-D	C2-7-D/C2-7VN-D	Vscan Air CL	C3-10-D	IC5-9-D	RAB6-D	RIC5-9-D	P2D	P6D
Aquasonic 100	X	X	X	X	X	X	X	X	X	X	X	X	X	X	X	X
Clear Image	X	X		X	X	X	X	X		X	X	X				
EcoGel 200 Ultrasound Gel	X	X		X	X	X	X	X		X	X	X	X	X		
EcoVue Ultrasound Gel	X	X		X	X		X	X		X	X	X	X	X		
Haiyin	X	X		X		X	X	X		X		X				
Kendall Life Trace Ultrasound Gel	X	X		X	X	X	X	X		X	X	X	X	X		
Konix Ultrasound Gel	X	X		X	X	X	X	X		X	X	X	X	X		
MediChoice Standard Ultrasound Gel	X	X		X	X	X	X	X		X	X	X	X	X		
Medline Ultrasound Gel/ Ultrasound Transmission Gel	X	X		X	X	X	X	X		X	X	X	X	X		
Natural Image			X						X							
Scan	X	X		X	X	X	X	X		X	X	X	X	X		
Sonogel	X	X		X	X	X	X	X		X	X	X	X	X		
Wavelength Multi-Purpose Ultrasound Gel	X	X		X	X	X	X	X		X	X	X	X	X		

## Coupling Gels (continued)

### Applying

In order to assure optimal transmission of energy between the patient and probe, a conductive gel or couplant must be applied liberally to the patient where scanning will be performed.



### CAUTION

Do not allow gel contact with eyes. If there is gel contact with the eye, flush eye thoroughly with water.

### Precautions

Coupling gels should not contain the following ingredients as they are known to cause probe damage:

- Methanol, ethanol, isopropanol, or any other alcohol-based product
- Mineral oil
- Iodine
- Lotions
- Lanolin
- Aloe Vera
- Olive Oil
- Methyl or Ethyl Parabens (para hydroxybenzoic acid)
- Dimethylsilicone
- Polyether glycol based
- Petroleum

## Sterile Ultrasound Procedures

**ONLY** ultrasound gel that is labeled as sterile, is sterile.

Ensure you always use sterile ultrasound gel for those procedures that require sterile ultrasound gel.

Once a container of sterile ultrasound gel is opened, it is no longer sterile and contamination during subsequent use is possible.

## **V Nav Cleaning Requirements**

### **Cleaning and Disinfecting V Nav Probe Brackets**

The probe bracket **SHOULD NOT** be autoclaved or gas sterilized. The bracket can be sterilized with Cidex. Details are in the CIVCO reference guide that is included with the bracket kit.

### **Cleaning and Disinfecting Cables, and Transmitter**

Periodically clean the equipment (transmitter, sensor, and cables) by wiping them down with a cloth dampened in a cleaning solution such as mild soap and water, isopropyl alcohol, or a similar acceptable cleaning solution. If the tracker's components come in contact with biological fluid or tissue, be sure to follow your organization's procedures for proper cleaning and disinfection. The transmitters and sensors are not designed to withstand autoclaving or gamma radiation. Sensors are ETO-compatible. **DO NOT** immerse the transmitter, sensor, or cables in liquids. Components are not waterproof.

### **Disinfecting and Sterilizing General Purpose Sensor**

High-level disinfect general purpose sensor using CIDEX OPA® ortho-Phthalaldehyde Solution (Johnson & Johnson) or equivalent .55% ortho-phthalaldehyde-based solution. Follow manufacturer's instructions and recommendations for concentration, time of contact and postprocess procedure.

High-level disinfect or sterilize general purpose sensor using CIDEX® Activated Dialdehyde Solution (Johnson & Johnson) or equivalent 2% glutaraldehyde-based solution, CIDEX Plus® (Johnson & Johnson) or equivalent 3.4% glutaraldehyde-based solution, or a hydrogen peroxide-based solution. Follow manufacturer's instructions and recommendations for concentration, time of contact and post-process procedure.

**DO NOT** gas sterilize or autoclave general purpose sensor.

### **Covers**

Covers can be used to go over the probe, bracket, sensors, and transmitter.

## Planned Maintenance

The following maintenance schedule is suggested for the system and probes to ensure optimum operation and safety.



**DANGER**

Improper handling can lead to early probe failure and electric shock hazards.

Failure to do so will void probe warranty.

DO follow the specific cleaning and disinfection procedures provided in this chapter and the disinfectant manufacturer's instructions.

Table 11-10: Planned Maintenance Program

Do the Following	Daily	After Each Use	As Necessary
Inspect the Probes	-	X	X
Clean the Probes	X	X	X
Disinfect Probes	-	X	X
Disinfect all other probe types	-	X	X

## Automatic Probe Diagnostics

Automatic Probe Diagnostics uses automated lens echo acquisition and advanced processing to provide real-time probe health information.

Enable Automatic Probe Diagnostics by selecting "Enable Automatic Probe Diagnostics" on the Utility>Admin page.



Figure 11-16. Enable Automatic Probe Diagnostics

Automatic Probe Diagnostics will execute once at each system startup (on only the first supported probe connected from the left to right) and generate a dump file in the "D:\log\diags\VITA" directory. The dump file will be transferred to the Back Office together with other files under D:\log directory every day.

**NOTE:** *Pencil Probe does not support Probe check.*

**NOTE:** *M5Sc-D Probe check only supports inner row 80 elements.*

## Probe Check (not available in all countries)

The **Probe Check** utility appears on the B-Mode Touch Panel Page 2. (The Probe Check utility does not appear while Scan Assistant is running.) A manual probe check can be run with this utility.

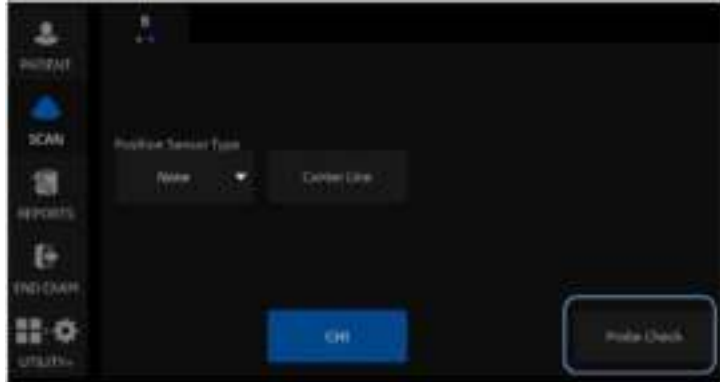

Figure 11-17. Probe Check

**NOTE:** *Pencil Probe does not support Probe check.*

**NOTE:** *M5Sc-D Probe check only supports inner row 80 elements.*

### Run Probe Check

Ensure the probe lens surface is clean and free of dirt, water or coupling gel before beginning probe check.

1. Select the **Probe Check** button on the Touch Panel (see Figure 11-17).
2. A pop-up appears specifying to ensure the probe lens surface is clean. If the lens is clean, select **Yes** on the pop-up (see Figure 11-18). The probe check takes approximately 2 to 10 seconds.



Figure 11-18. Probe Check Pop-up

## Run Probe Check (continued)

3. When the probe check is complete, a pop-up displays specifying if the probe “Passed” or “Failed” the test (see Figure 11-19). If the probe passed the test, continue using the probe. If the probe failed the test, follow the instructions on the pop-up.



Figure 11-19. Probe Check Pass or Fail Pop-ups

**NOTE:** *While Probe Check can correctly identify most damaged probes, there are some less common types of probe defects that Probe Check is not able to detect. If a probe passes the probe check but the image quality of the probe is unacceptable, please contact your service partner.*



## Automatic Probe Check

Automatic Probe Check runs during probe selection at a time interval specified at Utility >Admin page > Enable Automatic Probe Diagnostics (see Figure 11-20). The time interval options are: Every Time, Once a day, Once a week, Once a month and Never.

Automatic Probe Check runs for all supported probes with NOTE. Automatic Probe Check increases the probe selection time by about five seconds. If the probe fails the probe check, a pop-up displays (see Figure 11-19). If the probe fails the check, follow the instructions on the pop-up.



Figure 11-20. Automatic Probe Check

**NOTE:** *Pencil Probe does not support Probe check.*

**NOTE:** *M5Sc-D Probe check only supports inner row 80 elements.*

## Probe Care Cards

### Perform After Each Use

Ultrasound probes can be disinfected using liquid chemical disinfectants. The level of disinfection is directly related to the duration of contact with the disinfectant. Increased contact time produces a higher level of disinfection. Refer to the Probe Care Card that was shipped with each LOGIQ Totus probe.

Table 11-11: Description of Pictogram on Probe Care Cards









Pictogram	Description
	<p>“ATTENTION” - Consult accompanying documents” is intended to alert the user to refer to the operator manual or other instructions when complete information cannot be provided on the label.</p>
	<p>“CAUTION” - Dangerous voltage (the lightning flash with arrowhead) is used to indicate electric shock hazards.</p>
	<p>Biohazard - Patient/user infection due to contaminated equipment. Usage</p> <ul style="list-style-type: none"> <li>• Cleaning and care instructions</li> <li>• Sheath and glove guidelines</li> </ul>
	<p>Ultrasound probes are highly sensitive medical instruments that can easily be damaged by improper handling. Use care when handling and protect from damage when not in use.</p>
	<p>Do not immerse the probe into any liquid beyond the level specified for that probe. Refer to the user manual of the ultrasound system.</p>
	<p>Since there is a possibility of having negative effects on the probe, observe the specified immersing time by the disinfectant manufacturer strictly. Do not immerse the probe in liquid chemical disinfectants more than the time prescribed in the care card.</p>
	<p>“Consult accompany document” - Refer to the ultrasound system user manual for important probe care and cleaning instruction.</p>

Table 11-11: Description of Pictogram on Probe Care Cards (Continued)

Pictogram	Description
	<p>Symbol indicates useful information</p>
	<p>This is to illustrate compatible ultrasound coupling gels</p>
	<p>This is to illustrate compatible cleaners or disinfectants available in spray format (to be used according to instruction from the manufacturers of these products).</p>
	<p>This is to illustrate compatible cleaners or disinfectants available in wipes format (to be used according to instruction from the manufacturers of these products)</p>
	<p>This is to illustrate compatible cleaners or disinfectants available in powder (to be used according to instruction from the manufacturers of these products).</p>
	<p>This is to illustrate compatible cleaners or disinfectants available in liquid format (to be used according to instruction from the manufacturers of these products).</p>
	<p>This is to illustrate compatible automated reprocessors (to be used according to instruction from the manufacturers of these products).</p>

## **Returning/Shipping Probes and Repair Parts**

US Department of Transportation and GE HealthCare policy requires that equipment returned for service **MUST** be clean and free of blood and other infectious substances.

When you return a probe or part for service (Field Engineer or customer), you need to clean and disinfect the probe or part prior to packing and shipping the equipment.

Ensure that you follow probe cleaning and disinfection instructions provided in the Basic User Manual.

This ensures that employees in the transportation industry as well as the people who receive the package are protected from any risk.

# Biopsy Special Concerns

## Precautions Concerning the Use of Biopsy Procedures



**WARNING**

Do not freeze the image during a biopsy procedure. The image must be live to avoid a positioning error.

Biopsy guide zones are intended to assist the user in determining optimal probe placement and approximate the needle path. However, actual needle movement is likely to deviate from the guideline. Always monitor the relative positions of the biopsy needle and the target mass during the procedure, otherwise it could result in repeated biopsies or patient injury.



**WARNING**

NEVER reuse the TR5° disposable biopsy guide attachment, disposable sterile Ultra-Pro II needle guide kits or Verza Needle guide kits. Failure to follow the manufacturer's instructions could lead to potential exposure to infectious disease.



**WARNING**

The use of biopsy devices with accessories that have not been evaluated for use with this equipment may not be compatible and could result in injury. Failure to follow these instruction could result in repeated biopsies or patient injury.

## Precautions Concerning the Use of Biopsy Procedures (continued)



### WARNING

The invasive nature of biopsy procedures requires proper preparation and technique to control infection and disease transmission. Equipment must be cleaned as appropriate for the procedure prior to use.

- Follow the probe cleaning and disinfection procedures and precautions to properly prepare the probe.
- Follow the manufacturer's instructions for the cleaning of biopsy devices and accessories.
- Use protective barriers such as gloves and probe sheaths.
- After use, follow proper procedures for decontamination, cleaning, and waste disposal.

Failure to follow these instructions could lead to exposure to infectious agents.



### CAUTION

Improper cleaning methods and the use of certain cleaning and disinfecting agents can cause damage to the plastic components that will degrade imaging performance or increase the risk of electric shock.

See 'Probe Safety' on *page 11-11 for more information.*



### WARNING

Consult the biopsy needle manufacturer's instructions for acceptable reprocessing of biopsy needles. Failure to follow the manufacturer's instructions could lead to exposure to infectious agents.



### CAUTION

The biopsy needle and the biopsy needle guide (and the bore inside) must be sterile.



### CAUTION

Before starting a biopsy procedure with a 3D/4D probe always perform a volume scan first. This is important to ensure proper mechanical alignment and centering of the transducer element before the biopsy is performed.

## Freehand Biopsy



**CAUTION**

When performing a freehand biopsy, i.e. without a biopsy guide, it is the user's responsibility to use appropriate equipment.



**CAUTION**

Always only use basic modes when performing a freehand biopsy

**NOTE:** *A water bath alignment verification is also necessary before performing freehand biopsy procedures*

## **Biopsy Guide Sterilization**

Sterilization with autoclave is possible for the reusable stainless steel Biopsy Guides for the following probes:

- IC5-9-D
- RIC5-9-D
- RAB6-D

See 'Probe Biopsy Reprocessing' on *page 11-89 for more information.*



# Performing a Biopsy

## Displaying the Guidezone

Activate the Biopsy Kit by selecting it from the B-Mode Touch Panel.



Figure 11-21. B-Mode Touch Panel Menu

The available biopsy options appear when Biopsy Kit is selected. There are fixed and adjustable angle biopsy kits and plastic/disposable and reusable biopsy guides available with the LOGIQ Totus depending on the probe. Select the desired biopsy kit.



### CAUTION

Some angles (for example, if outside of the Field of View) may not be supported on all probes.

**NOTE:** *You can display the biopsy guideline on the CFM image in simultaneous mode. Enabling Color Flow allows for visualization of the vascular structure around the area to be biopsied. Select the Show Biopsy Mark on CFM simultaneous Mode preset in the Utility -> System -> System Image -> Biopsy Guide screen.*

## Displaying the Guidezone (continued)

**NOTE:** Be sure to match the angle setting on the bracket to the Biopsy Kit setting on the system.

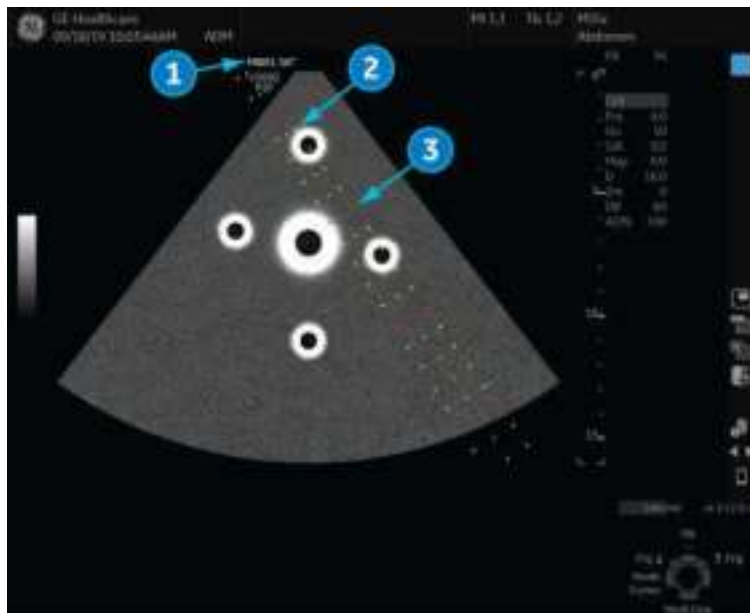

Figure 11-22. Biopsy Guidezones for the M5Sc Probe

1. Biopsy Kit Name and Biopsy Needle Angle
2. 1 cm increments
3. 5 cm increments

The biopsy guidezone represents the path of the needle. The dots which make up the guidezone represent the depth readout, where:

- Yellow represents 1 cm increments.
- Red represents 5 cm increments.

The display should be carefully monitored during a biopsy for any needle deviation from the center line or guidezone.

Before scanning, verify the needle can be visualized within the imaging plane. Use appropriate needle length to reach target area. Adjust the guide settings on the system and confirm they pass through the target, then match the setting on the system to the pin settings on the guide.

## Displaying the Guidezone (continued)

**NOTE:** *Biopsy Needle Angle is defined with respect to the horizontal axis. This is equivalent to (90 deg) – (angle specified by CIVCO). Displayed angle may be slightly different from CIVCO's specifications due to part variability.*

The Biopsy Guidezone adjusts along with image adjustments, such as image inversion/rotations, zoom and depth changes.

The needle may vary from the center line or guidezone for various reasons:

- Needle barrel to needle clearance or strength.
- Bracket manufacturing tolerance.
- Needle deflection due to tissue resistance.
- Needle size chosen. Thinner needles may deflect more.



### WARNING

Failure to match the guidezone displayed to the guide may cause the needle to track a path outside the zone.

It is extremely important that when using the adjustable angle biopsy guides, the angle displayed on the screen matches the angle set on the guide, otherwise the needle will not follow the displayed guidezone which could result in repeated biopsies or patient injury.



### CAUTION

The default biopsy lines provided with the system software, must be verified at least once by the user. The procedure must be repeated if probes and/or biopsy guides are exchanged.



### CAUTION

Depending on the needle stiffness/thickness and the elasticity and composition of the different tissue-types in the path of the biopsy needle, the actual needle track can deviate from the predicted biopsy line. The biopsy needle might bend and not follow a straight line.

## Guide circle on the biopsy line

You can use a guide circle on the biopsy line.

Mode: B/CF/PDI/Elastography/Contrast/Volume Navigation

Display format: Single/Dual



Figure 11-23. Guide circle

- Guide circle
- Biopsy line
- The system displays current size of Target diameter (inside circle) and margin distance in the status area.

### **Preset for guide circle**

Check “Show Biopsy Circle” in Utility -> System -> System Imaging to display a guide circle control on the monitor display and the trackball key.

### **Biopsy circle control**



Figure 11-24. Biopsy circle control

1. Target diameter
2. Margin distance
3. Guide circle display On/Off
4. Circle position (move Trackball Up/Down)

## Preparing the Biopsy Guide Attachment

Convex, Sector and Linear probes have optional biopsy guide attachments for each probe. The guide consists of a non-disposable bracket to attach to the probe, disposable needle clip to attach to the bracket, sheath, gel (sterile gel if necessary) and disposable needle barrels.

The disposable needle barrels are available for a variety of needle sizes.



### CAUTION

**DO NOT** attempt to use the biopsy bracket and needle guide until the manufacturer's instructions, provided with the biopsy bracket and needle guide in the kit, have been read and thoroughly understood. Failure to follow these instructions could result in repeated biopsies or patient injury.

The bracket is packaged non-sterile and is reusable. To avoid possible patient contamination, ensure bracket is properly cleaned, sterilized or disinfected before each use.

Disposable components are packaged sterile and are single-use only. Do not use if integrity of packing is violated or if expiration date has passed.

## Fixed Needle Biopsy Guide Assembly



### WARNING

DO NOT attempt to use the biopsy bracket and needle guide until the manufacturer's instructions, provided with the biopsy bracket and needle guide in the kit, have been read and thoroughly understood. Failure to follow these instructions could result in repeated biopsies or patient injury.

1. Identify the appropriate biopsy guide bracket by matching the label on the bracket with the probe to be used.
2. Orient the bracket so that the needle clip attachment will be on the same side as the probe orientation mark (ridge).

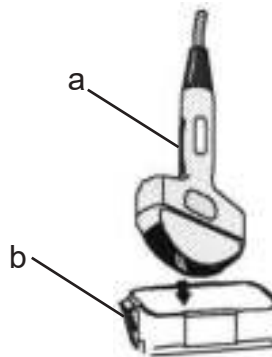

Figure 11-25. Probe/Bracket Alignment

- a. Probe Orientation Mark
  - b. Bracket
3. Attach the biopsy bracket to the probe by sliding the bracket over the end of the probe until it clicks or locks in place.
  4. Place an adequate amount of coupling gel on the face of the probe.

**Fixed Needle Biopsy Guide Assembly (continued)**

5. Using a sterile technique, place the proper sanitary sheath over the probe and biopsy bracket. Use the rubber bands supplied to hold the sheath in place.

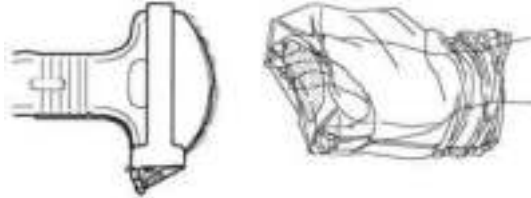

Figure 11-26. Applying Sanitary Sheath

6. Snap the fixed or adjustable needle clip onto the biopsy guide bracket.

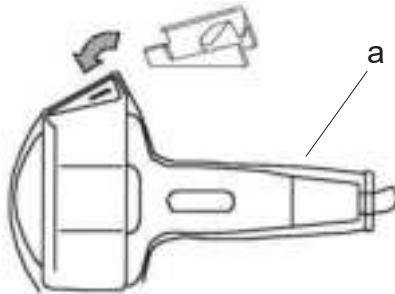

Figure 11-27. Fixed Needle Clip Attachment

- a. Sheath



## Fixed Needle Biopsy Guide Assembly (continued)

7. Push the locking mechanism towards the bracket to secure the lock. Make sure the needle guide is firmly attached to the bracket.



Figure 11-28. Locking the Needle Clip

**NOTE:** *If using an in-plane needle guide, the needle clip appears as shown here. Be sure to choose an in-plane guide that matches the gauge of the needle being used. The in-plane guide does not support any on-screen graphics. This is because the guide allows variable angles. For in-plane needle guides, steps 8 and 9 are not applicable.*



Figure 11-29. Example of In-Plane Needle Guide

## Fixed Needle Biopsy Guide Assembly (continued)

8. Choose the desired gauge (size) needle barrel. Twist it back and forth to remove it from the plastic tree.



Figure 11-30. Needle Barrel Selection

9. Place the needle barrel into the needle clip with the desired gauge facing the needle clip and snap into place.



Figure 11-31. Needle Barrel Installation



### WARNING

Ensure that all guide parts are seated properly prior to performing a biopsy. Failure to follow these instructions could result in repeated biopsies or patient injury.

## Multi Angle Biopsy Guide Assembly



### WARNING

DO NOT attempt to use the biopsy bracket and needle guide until the manufacturer's instructions, provided with the biopsy bracket and needle guide in the kit, have been read and thoroughly understood. Failure to follow these instructions could result in repeated biopsies or patient injury.

1. Scan the patient and identify the target for biopsy. Move the probe to locate the target to the center of the image. Enable the system biopsy guidezone and try guidezone angles MBX1 to MBX3 to decide the best angle setting for needle path.

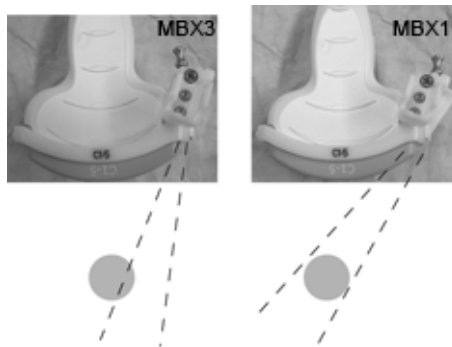

Figure 11-32. Example

2. Pull up on the pin (Figure 11-33 a) to freely move the needle guide attachment. Align the pin with the selected position of the needle guide attachment.

Push the pin down (Figure 11-33 b) into the desired slot to secure the angle position of the needle guide attachment.



Figure 11-33. Pull up and push down the pin

### **Multi Angle Biopsy Guide Assembly (continued)**

3. Fit a convex piece of the biopsy bracket (a) into the concave position of the probe (b).

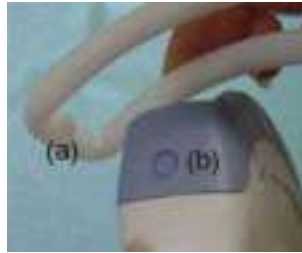

Figure 11-34. Probe/Bracket Alignment

Hold the side (a) and tuck down the needle guide side (b) until it clicks or locks in place.



Figure 11-35. Probe/Multi-angle Bracket Alignment 2

4. Place an adequate amount of coupling gel on the face of the probe.

**Multi Angle Biopsy Guide Assembly (continued)**

5. Place the proper sanitary sheath tightly over the probe and biopsy bracket. Use the rubber bands supplied to hold the sheath in place.

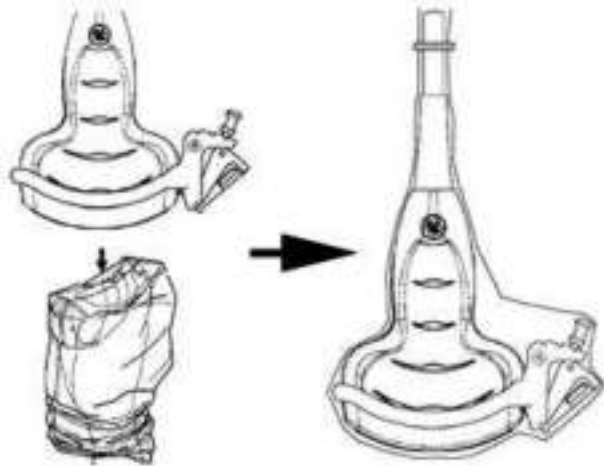

Figure 11-36. Applying Sanitary Sheath

6. Snap the needle guide onto the biopsy guide bracket.

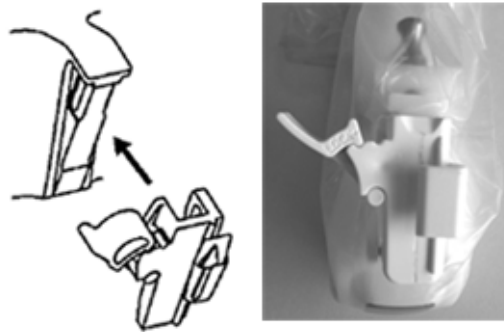

Figure 11-37. Snap the needle guide

## Multi Angle Biopsy Guide Assembly (continued)

7. Push the locking mechanism towards the bracket to secure the lock (a). Make sure the needle guide is firmly attached to the bracket.



Figure 11-38. Lock the Needle guide

8. Choose the desired gauge (size) needle barrel. Twist it back and forth to remove it from the plastic tree.



Figure 11-39. Needle Barrel

9. Place the needle barrel into the needle clip with the desired gauge facing the needle clip and snap into place.



Figure 11-40. Needle Barrel Installation

## Multi Angle Biopsy Guide Assembly (continued)

### Remove the biopsy guide

1. Hold the other side and push out the needle clip attachment side. See Figure 11-41.



Figure 11-41. Remove the biopsy guide



**CAUTION**

Prevent damage to the probe lens with finger nails.

## Releasing the needle

According to the following procedure, you remove the needle from a probe and an assembly without moving the needle.

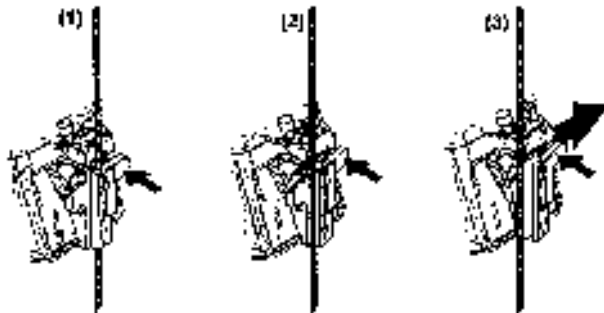

Figure 11-42. Release the needle from assembly

- a. Push the knob portion of a sleeve in the direction of the arrow.
- b. The needle is released from the assembly.
- c. Push the probe and the assembly in the direction of the larger arrow to remove the needle.



## Endocavitary Probe Biopsy Guide Assembly - Representative Example



WARNING

**DO NOT** use the needle with the catheter (soft tube). There is a possibility of breaking the catheter in the body.



WARNING

Before inserting the needle, scan the patient to determine the correct puncture depth and site. Only the sterile/sanitary sheath and rubber band are on the probe during the pre-needle placement scanning. Failure to follow these instructions could result in repeated biopsies or patient injury.

### Preparation

To prepare the endocavitary probe for use:

1. Remove the probe from the box and carefully examine it for any damage.
2. If the biopsy guide is to be attached, use the filling removal tool to clean out the attachment area on the probe head.

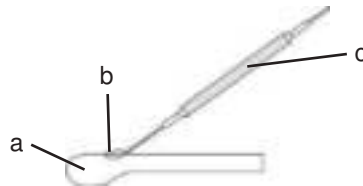

Figure 11-43. Attachment Filling Removal

- a. Probe Head
  - b. Attachment
  - c. Filling Removal Tool
3. Clean, then disinfect the probe.

**NOTE:** *Ensure that protective gloves are worn.*

### Installing the sheath

To install the sheath:

1. Remove the sheath from its package. Do not unroll the sheath.

**NOTE:** *Remember to rinse all sanitary probe sheaths of powder before placing on the probe. Powder can degrade the displayed image.*

2. Place an adequate amount of ultrasound gel inside the sheath tip (the gel is between the sheath inner surface and the probe aperture).

**NOTE:** *Ensure that only acoustic coupling gel is used for this purpose.*

3. Place the sheath tip over the probe aperture and then pull the sheath end toward the probe handle.
4. Inspect the sheath for nicks, cuts or tears.



Figure 11-44. Endocavitary Probe with Sheath

1. Secure the Sheath with a rubber band.
2. The probe sheath should extend past the end of the probe to the probe's cable.
5. Rub a finger over the tip of the probe to ensure all air bubbles have been removed.

## Endocavitary Probe Biopsy Guide Preparation

1. If a biopsy is to be performed, snap the metal or plastic biopsy guide on to the probe over the sheath.



### WARNING

Ensure that all guide parts are seated properly prior to performing a biopsy. Failure to follow these instructions could result in repeated biopsies or patient injury.

### NOTE:

2. Fix with a screw  
*For the RIC5-9-D and IC5-9-D probes, use the TR5 guidelines for the plastic (disposable-only) biopsy guides; use the RU guidelines with the stainless steel reusable biopsy guides.*
3. Place an adequate amount of ultrasound gel on the gel-filled sheath tip's outer surface.
4. Ensure the guide is properly seated and secure by pushing forward on the needle insertion end of the guide until the attachment node is firmly in place in it's hole.

## 4D Biopsy Guide Assembly - Representative Example

### 4D Probe

1. Place the needle guide onto the probe.
2. Push the needle forward until the bracket catches in the support on the housing of the probe (a).



Figure 11-45. Support on the housing

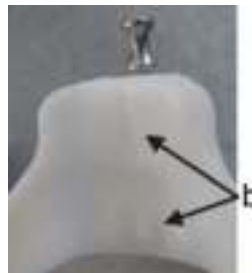

Figure 11-46. Biopsy Needle Guide

3. Fix the biopsy guide by locking the frame on the opposite side (b).



Figure 11-47. Mounting the Biopsy Needle Guide to the 4D Probe

**NOTE:** *Needle guide sterilization with autoclave possible.*

#### 4D Endocavitary Probe

1. Place an adequate amount of ultrasound gel inside the sheath tip (the gel is between the sheath inner surface and the probe aperture).

*NOTE: Ensure that only acoustic coupling gel is used for this purpose.*

2. Place the sheath tip over the probe aperture and then pull the sheath end toward the probe handle.
3. Inspect the sheath for nicks, cuts or tears.
4. Rub a finger over the tip of the probe to ensure all air bubbles have been removed.
5. Position the small swelling of the needle guide on the notch at the probe tip. Snap the needle guide.



Figure 11-48. Installation (without probe sheath)

*NOTE: Material: Stainless Steel*

*NOTE: Needle guide sterilization with autoclave possible.*

## Verza Biopsy Needle Guide

The Versa Biopsy Needle Guide is available for the C1-6-D and C1-6VN-D probes.

Activate the Biopsy Kit by selecting it from the B-Mode Touch Panel.



Figure 11-49. B-Mode Touch Panel Menu

The available biopsy options appear when Biopsy Kit is selected. Select the desired biopsy kit.



**CAUTION**

Be sure to match the 'pin' setting on the bracket to the pin setting on the system.

**Verza Needle Guide Attachment Procedure**

*NOTE: The following procedure is shown with a C1-6-D probe.*

Table 11-12: Verza Biopsy Guide Attachment Procedure



Step	Instructions	Illustration
1.	Attach the Biopsy Guide Bracket to the probe. a. Match the indentations on the Biopsy Guide Bracket and the probe.	
2.	Tightly secure the Biopsy Guide Bracket to the probe. NOTE: Be sure you are using the correct bracket for the probe. The bracket and probe are clearly marked.	
3.	Attach the probe sheath. a. Apply gel. b. Cover the probe. c. Attach the rubber band.	

Table 11-12: Verza Biopsy Guide Attachment Procedure (Continued)







Step	Instructions	Illustration
4.	Tightly secure the Needle Guide to the Biopsy Guide Bracket through the sheath.	
5.	Unlock angle lock to adjust the needle guide angle; then re-lock.	<div style="display: flex; justify-content: space-around;"> <div data-bbox="727 997 806 1024">Locked</div> <div data-bbox="973 997 1063 1024">Unlocked</div> </div> 
	Adjust Needle Guide Angle	<div style="display: flex; justify-content: space-around;"> <div data-bbox="252 1290 696 1544">  </div> <div data-bbox="727 1252 973 1606"> <div style="text-align: center;">Re-lock</div>  </div> </div>



Table 11-12: Verza Biopsy Guide Attachment Procedure (Continued)

Step	Instructions	Illustration
6.	Insert correct Needle Gauge Holder. 	
7.	Push the Quick Tab Release, insert the biopsy needle into the needle guide. Close the Quick Tab Release.	

## 4D Probe Biopsy Needle Path Selection

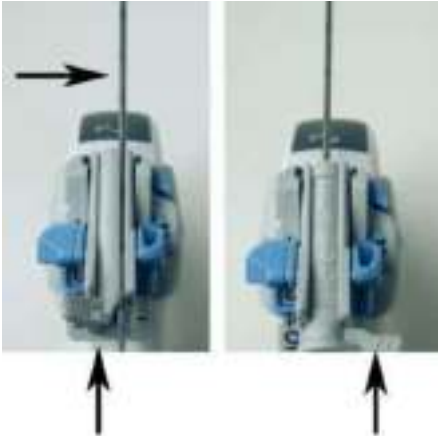
To select the needle path and verify that the path of the needle is accurately indicated within the guidezone on the system monitor, perform the following before use:

1. Properly install the bracket and biopsy guide.
2. Scan in a container filler with water (47° C).
3. Select **Biopsy kit**. The available biopsy options from the Touch Panel.

Select the biopsy guidezone where the needle echo passes through the center of the guidezone. Use the selected biopsy guidezone when performing the biopsy.

## Biopsy Needle Path Verification

To verify that the path of the needle is accurately indicated within the guidezone on the system monitor, perform the following:

- Properly install the bracket and biopsy guide.
- Scan in a container filled with water (47° C).
- Display the biopsy guidezone on the monitor.
- Ensure that the needle echo falls within the guidezone markers.



CAUTION

The needle used for water bath alignment must not be used for a biopsy performed on a patient.

## The Biopsy Procedure



**WARNING**

Biopsy procedures must only be performed on live images. Failure to follow these instructions could result in repeated biopsies or patient injury.



**WARNING**

Ensure that all guide parts are seated properly prior to performing a biopsy. Failure to follow these instructions could result in repeated biopsies or patient injury.

1. Place coupling gel on the scanning surface of the probe/sheath/biopsy guide assembly.
2. Activate the biopsy guidezone on the system through the B-Mode Touch Panel. When using multi-angle guides, ensure that the proper guidezone angle is displayed.
3. Scan to locate the target. Center the target in the electronic guidezone path.

**NOTE:**

*Enabling color flow would allow for visualization of the vascular structure around the area to be biopsied.*

4. Place the needle in the guide between the needle barrel and needle clip. Direct it into the area of interest for specimen retrieval.

## **Post Biopsy**

When the biopsy is complete, remove the needle barrel, needle clip and probe sheath. Properly dispose of these items in accordance with current facility guidelines.

Clean and disinfect the probe. See 'Probe Reprocessing' on *page 11-19 for more information.*

The biopsy bracket can be cleaned and disinfected in a recommended disinfecting agent and reused.



### **WARNING**

When the biopsy needle guide kit is opened, all parts must be discarded after the procedure whether they have been used or not. Failure to follow these instructions could result in repeated biopsies or patient injury.

## Probe Biopsy Reprocessing

### Manual Cleaning

**NOTE:** *Efficacy of this manual cleaning process has been shown using ENZOL Enzymatic Detergent.*

1. Remove the biopsy guide and protective sheath(s) from the probe.
2. Whenever possible the biopsy guide should be rinsed immediately after use. If the biopsy guide cannot be cleaned immediately after use, maintain moisture by placing them in a clean container. Cover the container with a towel dampened with purified water. Devices may remain in this condition for a maximum of 4 hours.
3. Remove all visible soil. Flush the biopsy guide using potable water (30 - 40°C) for not less than 2 minutes.
4. Prepare an enzymatic detergent safe for use with metal instruments according to the manufacturer's recommendations, using potable water.
5. Submerge the biopsy guide in the prepared solution and soak for no less than 2 minutes.
6. After the 2-minute soak, while the biopsy guide is submerged in the detergent water, vigorously scrub the device with a soft nylon bristle brush.
7. Use a round nylon cleaning brush to clean the biopsy lumen. Use a syringe to flush detergent water through the lumen. Scrub the device for a minimum of 2 minutes.
8. Remove the device from the detergent water and rinse thoroughly in running potable water (30 - 40°C) taking care to remove any visible detergent. Rinse the device for a minimum of 1 minute.
9. Visually inspect the device for any residual soil or detergent. Repeat steps 6 through 8 until the device is visibly clean.

**NOTE:** *Discard solutions and rinse waters in accordance with local regulations*



#### CAUTION

Do not clean any portion of the attachment with methanol, ethanol, isopropanol, or any other alcohol base detergent. Such substances can cause irreparable damage to the attachment.

## High-Level Disinfection

*NOTE: High-Level disinfection efficacy of this manual process has been shown using Cidex OPA.*

1. Fill a sink or basin with high-level disinfectant prepared in accordance with the disinfectant manufacturer's instructions to a level allowing immersion of the biopsy guide.
2. Immerse the devices in the disinfectant solution and agitate to ensure all air bubbles are removed from the surface of the device.
3. Allow the devices to soak in the disinfectant solutions for least the minimum contact time listed in the disinfectant manufacturer's instructions for use.
4. Thoroughly rinse the device by immersing in a large volume of critical (purified) water for a minimum of 1 minute.

*NOTE: Critical Water is water that is treated (usually by a multistep treatment process that could include a carbon bed, softening, DI, and RO or distillation) to ensure that the microorganisms and the inorganic and organic material are removed from the water to an appropriate level. (Refer to AAMI TIR34/ST108).*

5. Repeat Step 4 two additional times, for a total of 3 (three) rinses using fresh volumes of water for each rinse.

*NOTE: Discard solutions and rinse waters in accordance with local regulations*

6. Thoroughly dry the biopsy guide using a sterile, lint-free wipe. Visually inspect the biopsy guide to ensure all surfaces are clean and dry. Visually inspect the biopsy to ensure all surfaces are dry. Repeat drying steps if any moisture is visible.

## Autoclave Sterilization

**NOTE:** Sterilization efficacy testing was performed using worst-case parameters for time, temperature and load density. Parameters listed in the tables are the minimum required to ensure a Sterility Assurance Level (SAL) of  $10^{-6}$  or better.

1. Place the cleaned and disinfected biopsy guide in an approved autoclave pouch.
2. Autoclave using the following parameters:

Table 11-13: Autoclave parameters

Parameter	Cycle Type 1	Cycle Type 2
Sterilizer	Pre-vacuum	Pre-vacuum
Preconditioning Pulses	3	3
Temperature (Minimum)	132 degrees C	134 degrees C
Exposure Time (Minimum)	4 Minutes	3 Minutes
Drying Time (Minimum)	15 Minutes	15 Minutes
Package Configuration	Tyvek Pouch (14 x 25 cm)	Tyvek Pouch (14 x 25 cm)





---

# Chapter 12

## User Maintenance

*This chapter supplies system data, assistance information, and system care and maintenance instructions.*

## Features/Specifications

Table 12-1: Physical Attributes

<p><u>Dimensions and Weight (for Transport)</u></p> <ul style="list-style-type: none"> <li>• Height                      Transport position : 1285mm, 50.6 in                      Normal use position (LCD monitor) : 1425mm - 1825mm, 56.1 in - 71.9 in                      Normal use position (HDU monitor) : 1465mm - 1865mm, 57.7 in - 73.4 in</li> <li>• Width                      Base width : 490mm , 19.3 in                      Monitor width (LCD monitor) : 545mm, 21.5 in                      Monitor width (HDU monitor) : 565mm, 22.2 in</li> <li>• Depth: 835mm, 32.9 in</li> <li>• Weight: 73kg, 160.9 lb.</li> </ul> <p><u>User interface</u></p> <ul style="list-style-type: none"> <li>• Operating keyboard adjustable in height and rotation</li> <li>• Ergonomic hard key layout</li> <li>• Interactive Back-Lighting</li> <li>• Integrated recording keys for remote control of up to 4 peripheral or DICOM devices</li> <li>• Integrated Gel Warmer (Option)</li> </ul> <p><u>Electrical Power</u></p> <ul style="list-style-type: none"> <li>• Voltage:100 - 240 Vac</li> <li>• Frequency: 50/60 Hz</li> <li>• Power consumption maximum of 0.65 KVA with peripherals.</li> </ul> <p><u>Touch Screen</u></p> <ul style="list-style-type: none"> <li>• 14 inch Capacitive Touch Panel</li> <li>• FHD 1920 x 1080(16:9) pixel Resolution.</li> <li>• Brightness adjustment</li> <li>• User-configurable layout</li> </ul>	<p><u>Console Design</u></p> <ul style="list-style-type: none"> <li>• 4 Active Probe Ports</li> <li>• Integrated SSD (1TB)</li> <li>• On-board storage for peripherals: Thermal printer.</li> <li>• Integrated speakers</li> <li>• Integrated locking mechanism that provides rolling lock and caster swivel lock</li> <li>• Integrated cable management</li> <li>• Front and Rear handles</li> <li>• Easily-removable air filters</li> </ul> <p><u>HDU Display</u></p> <ul style="list-style-type: none"> <li>• 23.8" Wide screen High-Resolution HDU Display</li> <li>• Monitor translation: 350mm, 13.7 in. horizontal; 120mm, 4.7 in. vertical; 90 degree swivel</li> <li>• Fold-down and Lock Mechanism for transport</li> <li>• Brightness &amp; contrast adjustment</li> <li>• Resolution 1920 x 1080</li> <li>• Anti Glare</li> <li>• Viewing Angle 89/89/89/89 degrees</li> </ul> <p><u>LCD Display</u></p> <ul style="list-style-type: none"> <li>• 23.8" Wide screen High-Resolution LCD Display</li> <li>• Monitor translation: 350mm, 13.7 in. horizontal; 120mm, 4.7 in. vertical; 90 degree swivel</li> <li>• Fold-down and Lock Mechanism for transport</li> <li>• Brightness &amp; contrast adjustment</li> <li>• Resolution 1920 x 1080</li> <li>• Anti Glare</li> <li>• Viewing Angle 89/89/89/89 degrees</li> </ul>
---	---

Table 12-2: System Overview

<p><u>Applications</u></p> <ul style="list-style-type: none"> <li>• Abdominal</li> <li>• Obstetrical</li> <li>• Gynecological</li> <li>• Breast</li> <li>• Small parts</li> <li>• Peripheral Vascular</li> <li>• Transcranial (Adult and neonatal)</li> <li>• Pediatric and neonatal</li> <li>• Musculoskeletal (general and superficial)</li> <li>• Urological</li> <li>• Cardiac (adult and pediatric)</li> </ul> <p><u>Operating modes</u></p> <ul style="list-style-type: none"> <li>• B-Mode</li> <li>• M-Mode</li> <li>• Color Flow Mode (CFM)</li> <li>• B-Flow (Option)</li> <li>• Extended field of view (LOGIQView)</li> <li>• Power Doppler Imaging (PDI)</li> <li>• PW Doppler</li> <li>• CW Doppler (Option)</li> <li>• Volume Mode (3D/4D) (Option) <ul style="list-style-type: none"> <li>• 3D Static</li> <li>• 4D Real Time</li> </ul> </li> <li>• Anatomical M-Mode</li> <li>• Coded Contrast Imaging (Option)</li> <li>• Strain Elastography</li> <li>• Shear Wave Elastography (Option)</li> <li>• UGAP (Option)</li> </ul> <p><u>Scanning methods</u></p> <ul style="list-style-type: none"> <li>• Electric sector</li> <li>• Electric convex</li> <li>• Electric linear</li> <li>• mechanical volume sweep</li> </ul> <p><u>Transducer Types</u></p> <ul style="list-style-type: none"> <li>• Sector Phased Array</li> <li>• Convex Array</li> <li>• Micro convex Array</li> <li>• Linear Array</li> <li>• Matrix Array</li> <li>• Volume probe (4D)</li> <li>• Split Crystal</li> </ul>	<p><u>Standard Features</u></p> <ul style="list-style-type: none"> <li>• Automatic Optimization</li> <li>• CrossXBeam</li> <li>• Advanced Speckle Reduction Imaging</li> <li>• Fine Angle Steer</li> <li>• Coded Harmonic Imaging</li> <li>• Virtual Convex</li> <li>• Patient information database</li> <li>• Advanced 3D</li> <li>• Raw Data Analysis</li> <li>• Real-time Automatic Doppler Calculations</li> <li>• OB Measurements/Calculations</li> <li>• Fetal Trending</li> <li>• Multigestational Calculations</li> <li>• Hip Dysplasia Calculations</li> <li>• Gynecological Calculations</li> <li>• Vascular Calculations</li> <li>• Urological Calculations</li> <li>• Renal Calculations</li> <li>• Cardiac Calculations</li> <li>• InSite Capability</li> <li>• On-board electronic documentation</li> <li>• Auto Doppler Assist</li> <li>• Privacy and Security, including user and rights management</li> <li>• LOGIQView</li> <li>• External USB Printer connection</li> <li>• Network Printer Support</li> <li>• HDMI output available for compatible devices</li> </ul>
--	---

Table 12-2: System Overview (Continued)

<p><u>Options</u></p> <ul style="list-style-type: none"> <li>• DICOM</li> <li>• Adv. Security</li> <li>• Coded Contrast</li> <li>• Cardiac AFI</li> <li>• Report Writer</li> <li>• Stress Echo</li> <li>• Tricefy (Not for sale)</li> <li>• LOGIQ Apps</li> <li>• Scan Assistant</li> <li>• Advanced Probes</li> <li>• AUTO IMT</li> <li>• B Steer+</li> <li>• B-flow</li> <li>• flow QA</li> <li>• Measure Assist Breast</li> <li>• Measure Assist OB</li> <li>• Elastography</li> <li>• Elasto QA</li> <li>• Shear Wave Elastgraphy</li> <li>• UGAP</li> <li>• Hepatic Assistant - SWE-UGAP</li> <li>• Software DVR</li> <li>• Omni View</li> <li>• STIC</li> <li>• TUI</li> <li>• VCI-Static</li> <li>• VOCAL_II</li> <li>• SonoNT SonoIT</li> <li>• Compare Assistant</li> <li>• Thyroid Productivity</li> <li>• Breast Productivity</li> <li>• VITA on Demand (option for regions except for USA)</li> <li>• Auto Real-time Preset Selection</li> <li>• Voice Control</li> <li>• KOIOS INSTALL</li> <li>• KOIOS Thyroid</li> <li>• KOIOS Breast</li> <li>• CW Doppler</li> <li>• Realtime 4D</li> <li>• Power Assistant and Scan on battery</li> <li>• Small battery (3 packs)</li> <li>• Big battery (6 packs)</li> <li>• Pencil CW</li> <li>• ECG Option</li> <li>• ECG CABLE - AHA STYLE</li> <li>• ECG CABLE - IEC STYLE</li> </ul>	<ul style="list-style-type: none"> <li>• TVTR Probe Holder</li> <li>• PROBE CABLE HANGER</li> <li>• Control panel REAR TRAY</li> <li>• REAR BASKET</li> <li>• REAR HANDLE CABLE HOOK</li> <li>• Ultrasound Probe Rack (USA only)</li> <li>• Ethernet Protection Cable</li> <li>• Vscan Air CL</li> <li>• Auto Preset Assistant</li> <li>• eDelivery</li> <li>• Verisound Fleet</li> <li>• UPS Document Kit</li> </ul> <p><u>Peripheral Options</u></p> <ul style="list-style-type: none"> <li>• Sony BW Printer</li> <li>• Sony Color Printer</li> <li>• USB FOOTSWITCH 3 BUTTON</li> <li>• Barcode Reader USBee1000A</li> <li>• Magnetic Card Reader (Japan and AKA Only)</li> <li>• Powervar144k120v MG UPS (US and LATAM only)</li> <li>• Powervar144k 230V MG UPS (EU only)</li> <li>• EMI Filter</li> <li>• Wireless LAN</li> <li>• S-Video output available for compatible device</li> <li>• Digital Expert Cables and Video Grabber</li> <li>• Digital Expert with tablet</li> <li>• Microsoft Surface Tablet with Case</li> </ul> <p><u>Display Modes</u></p> <ul style="list-style-type: none"> <li>• Live and Stored Display Format: Full and Split Screen -- both with thumbnails for Still and CINE</li> <li>• Review Image Format: 4x4 and Thumbnails for Still and CINE</li> <li>• Time line Display [Independent Dual B or CrossXBeam/PW Display; CW; Display Formats; Top/Bottom or Side/Side selectable Format; 2 Timeline Methods: Scrolling or Moving Bar</li> <li>• Virtual Convex</li> <li>• Simultaneous Capability [B or CrossXBeam/PW, B or CrossXBeam/CW (Option), B or CrossXBeam/CFM or PDI, B/M, B/CrossXBeam, Realtime Triplex Mode [B/CrossXBeam + CFM/PDI + PW]</li> <li>• Selectable alternating Modes [B or CrossXBeam/PW; B or CrossXBeam + CFM (PDI)/PW; B/CW (option)]</li> <li>• Multi Image Split/Quad Screen [Live and/or Frozen, B or CrossXBeam+B or CrossXBeam/CFM or PDI, PW/M, Independent Cine playback]</li> </ul>
--	--

Table 12-3: System Parameters

<p><u>Controls Available on Freeze or Recall</u></p> <ul style="list-style-type: none"> <li>• Automatic Optimization</li> <li>• Advanced SRI Type 1</li> <li>• CrossXBeam (display non-compounded and compounded image simultaneously in split screen)</li> <li>• 3D Reconstruction from a stored CINE loop</li> <li>• B/M/CrossXBeam Mode (Gray Map Optimization; TGC, Colorized B and M; Frame Average [Loops only]; Dynamic Range)</li> <li>• Anatomical M-Mode</li> <li>• Magnification Zoom</li> <li>• Pan Zoom</li> <li>• Baseline Shift</li> <li>• Sweep speed</li> <li>• PW-Mode (Gray Map; Post Gain; Baseline Shift; Sweep Speed; Invert Spectral Waveform; Compression; Rejection, Colorized Spectrum; Display Format; Angle Correct; Quick Angle Correct, Auto Angle Correct, Doppler Audio)</li> <li>• Color Flow (Overall Gain [Loops and Stills]; Color Map; Transparency Map; Frame Averaging [Loops only]; Flash Suppression, CFM Display Threshold; Spectral Invert for Color/Doppler)</li> <li>• Anatomical M-Mode on CINE Loop</li> <li>• 4D (Gray Map, Colorize; Post Gain; Change display between single or rendered)</li> </ul> <p><u>Controls Available While “Live”</u></p> <ul style="list-style-type: none"> <li>• Magnification Zoom: Magnifies the entire image on the screen without zoom ROI</li> <li>• Pan Zoom: Magnifies the display of the data within the ROI</li> <li>• HD Zoom: Magnifies the image within the zoom ROI, with higher spatial resolution than original images</li> <li>• B/M/CrossXBeam-Mode (Gain; TGC; Dynamic Range; Acoustic Output; Frame Rate Control, Sweep Speed for M-Mode; # of Angles for CrossXBeam)</li> <li>• PW-Mode (Gain; Dynamic Range; Acoustic Output; Transmission Frequency; PRF; Wall Filter; Spectral Averaging; Sample Volume Gate for PW-Mode Length and Depth; Velocity Scale)</li> <li>• Color Flow (CFM Gain; CFM Velocity Range; Acoustic Output; Wall Echo Filter; Frame Rate Control; CFM Spatial Filter; CFM Frame Averaging; CFM Line Resolution; Frequency/ Velocity Baseline Shift)</li> </ul>	<p><u>Connectivity</u></p> <ul style="list-style-type: none"> <li>• Ethernet network connection</li> <li>• Wireless LAN 802.11ac/a/b/g/n (option)</li> <li>• DICOM 3.0 (option) with Verify, Print, Store, Modality Worklist, Storage Commitment, Modality Performed Procedure Step [MPPS], Media Exchange, Off network/mobile storage queue, Query/Retrieve)</li> <li>• Public SR Template</li> <li>• Structured Reporting - compatible with Vascular, OB, Cardiac, and Breast standard</li> <li>• InSite capability</li> <li>• Advanced privacy and security (Option)</li> </ul> <p><u>Scanning Parameters</u></p> <ul style="list-style-type: none"> <li>• Displayed Imaging Depth: 0-50cm [Minimum: 0-2 cm (Zoom); Maximum: 0-50 cm] (Probe dependent)</li> <li>• Continuous Dynamic Receive Focus/Continuous Dynamic Receive Aperture</li> <li>• Adjustable Dynamic Range</li> <li>• Adjustable Field of View (FOV)</li> <li>• Image Reverse: Right/ Left</li> <li>• Image Rotation: 0, 90, 180, 270 degrees</li> </ul> <p><u>Image Storage</u></p> <ul style="list-style-type: none"> <li>• On-board database of patient information from past exams</li> <li>• Storage Format: DICOM (compressed/ uncompressed, single/multiframe, enhanced [3D/ 4D], with/without Raw Data), Export JPEG, and WMV.</li> <li>• Storage Devices: USB Memory Stick (64MB to 64GB, for exporting individual images/clips); Hard Drive Image Storage (~730GB)</li> <li>• Compare previous exam images with current exam</li> <li>• Reload of archived data sets</li> </ul> <p><u>CINE Memory/Image Memory</u></p> <ul style="list-style-type: none"> <li>• 1 GB of CINE Memory</li> <li>• Selectable CINE Sequence for CINE Review</li> <li>• Prospective CINE Mark</li> <li>• Measurements/Calculations &amp; Annotations on CINE Playback</li> <li>• Scrolling timeline memory</li> <li>• Dual Image CINE Display</li> <li>• Quad Image CINE Display</li> <li>• CINE Gauge and CINE Image Number Display</li> <li>• CINE Review Loop</li> <li>• CINE Review Speed</li> </ul>
---	---

Table 12-4: Measurements and Calculations

<p><u>B-Mode</u></p> <ul style="list-style-type: none"> <li>• Depth and Distance</li> <li>• Circumference and Area (Ellipse/Trace)</li> <li>• Volume (Ellipsoid)</li> <li>• Angle between 2 Lines</li> <li>• % Stenosis (Area or Diameter)</li> <li>• Dual B-Mode capability</li> </ul> <p><u>M-Mode</u></p> <ul style="list-style-type: none"> <li>• M Depth and Distance</li> <li>• Time</li> <li>• Slope</li> <li>• Heart Rate</li> </ul> <p><u>Doppler Measurements/Calculations</u></p> <ul style="list-style-type: none"> <li>• Velocity</li> <li>• Time</li> <li>• Peak Systole</li> <li>• End Diastole</li> <li>• Acceleration</li> <li>• Acceleration Time</li> <li>• Ratios             <ul style="list-style-type: none"> <li>• A/B Ratio (Velocities/Frequency Ratio)</li> <li>• Peak Systole/End Diastole (PS/ED Ratio)</li> <li>• End Diastole/Peak Systole (ED/PS Ratio)</li> </ul> </li> <li>• Heart Rate</li> <li>• TAMAX (Time Averaged Maximum Velocity)</li> <li>• Volume Flow [TAMEAN and Vessel Area]</li> <li>• PI (Pulsatility Index)</li> <li>• RI (Resistivity Index)</li> </ul> <p><u>Shear Wave Measurements/Calculations</u></p> <ul style="list-style-type: none"> <li>• Stiffness</li> <li>• Velocity</li> </ul> <p><u>Vascular Measurements/Calculations</u></p> <ul style="list-style-type: none"> <li>• Carotid, Vertebral, Subclavian Measurements, Auto IMT</li> <li>• Summary Worksheet</li> <li>• Summary Report</li> </ul> <p><u>Small Part Measurement Analysis</u></p> <ul style="list-style-type: none"> <li>• Koios DS Breast Lesion Decision Support</li> <li>• Koios DS Thyroid Lesion Decision Support</li> </ul>	<p><u>Obstetrics Measurements/Calculations</u></p> <ul style="list-style-type: none"> <li>• Gestational Age Calculation</li> <li>• Calculations and Ratios</li> <li>• EFW Calculation</li> <li>• Growth Percentiles</li> <li>• Multi-Gestational Calculation</li> <li>• Fetal Qualitative Description (Anatomical Survey)</li> <li>• Fetal Environmental Description (Biophysical profile)</li> <li>• Programmable OB Tables</li> <li>• Fetal Graphical Trending</li> <li>• Measurements / Calculations by: ASUM, ASUM 2001, Alexander, Bahlmann, Baschat, Berkowitz, Bertagnoli, Brenner, Campbell, CFEF, Chervenak, Chitty, Doubilet, Ebbing, Eik-Nes, Ericksen, Goldstein, Hadlock, Hansmann, Hellman, Hill, Hohler, Jeanty, JSUM, Kurmanavicius, Kurtz, Mari, Mayden, Mercer, Merz, Moore, Nelson, Osaka University, Paris, Pexsters, Rempen, Robinson, Shepard, Shepard/Warsoff, Sonek, Tokyo University, Tokyo/Shinozuka, WHO, Yarkoni</li> <li>• Over 20 selectable OB Calcs</li> <li>• Summary Worksheet</li> <li>• Summary Report</li> </ul> <p><u>Gynecology Measurements/Calculations</u></p> <ul style="list-style-type: none"> <li>• Ovarian, Uterine, Pelvic Floor, Endometrium, Follicular Measurements, Cervix</li> <li>• Summary Worksheet</li> <li>• Summary Report</li> <li>• Qualitative Description (Anatomical Survey)</li> </ul> <p><u>Urology Measurements/Calculation</u></p> <ul style="list-style-type: none"> <li>• Bladder, Prostate, Renal, Generic, Post-Void Bladder Volume Measurements</li> <li>• Summary Worksheet</li> <li>• Summary Report</li> </ul> <p><u>Cardiology Measurements/Calculations</u></p> <ul style="list-style-type: none"> <li>• Cardiology Measurements and Calculations</li> <li>• Summary Worksheet</li> <li>• Summary Report</li> </ul>
---	---

Table 12-5: Biopsy Guides

<ul style="list-style-type: none"> <li>• Single-Angle, disposable with a reusable bracket</li> <li>• Multi-Angle, disposable with a reusable bracket</li> </ul>	<ul style="list-style-type: none"> <li>• Single-Angle, disposable with a disposable bracket</li> </ul>
---	--

Table 12-6: Inputs and Outputs Signal

<ul style="list-style-type: none"> <li>• HDMI (with stereo audio)</li> <li>• S-Video</li> </ul>	<ul style="list-style-type: none"> <li>• Ethernet</li> <li>• Multiple USB 3.0 ports</li> </ul>
---	--

## Clinical Measurement Accuracy

### Basic Measurements

The following information is intended to provide guidance to the user in determining the amount of variation or measurement error that should be considered when performing clinical measurements with this equipment. Error can be contributed by equipment limitations and improper user technique. Be sure to follow all measurement instructions and develop uniform measurement techniques among all users to minimize the potential operator error. Also, in order to detect possible equipment malfunctions that could affect measurement accuracy, a quality assurance (QA) plan should be established for the equipment that includes routine accuracy checks with tissue mimicking phantoms.

Please be advised that all distance and Doppler related measurements through tissue are dependent upon the propagation velocity of sound within the tissue. The propagation velocity usually varies with the type of tissue, but an average velocity for soft tissue is assumed. This equipment is designed for, and the accuracy statements listed on are based on, an assumed average velocity of 1540 m/s. The percent accuracy when stated applies to the measurement obtained (not the full scale range). Where the accuracy is stated as a percent with a fixed value, the expected inaccuracy is the greater of the two.

**Basic Measurements (continued)**

Table 12-7: System Measurements and Accuracies

Measurement	Units	Useful Range	Accuracy	Limitations or Conditions
Depth	mm	Full Screen	±20%	
Distance:				
Axial (Equal to 1540m/s)	mm	Full Screen	±3% or ±1mm, whichever is greater	
Lateral (Equal to 1540m/s)	mm	Full Screen	±5% or ±1mm, whichever is greater	Linear Probes
Lateral (Equal to 1540m/s)	mm	Full Screen	±6.5% or ±3.5mm, whichever is greater	Convex Probes
Lateral (Equal to 1540m/s)	mm	Full Screen	±5% or ±1mm, whichever is greater	Sector Probes
Axial/Lateral (Not Equal to 1540m/s)	mm	Full Screen	±7.5% or ±5.0mm, whichever is greater	All probes Not Equal To 1540m/s
Circumference:				
Trace (Equal to 1540m/s)	mm	Full Screen	±5% or ±1mm, whichever is greater	
Ellipse (Equal to 1540m/s)	mm	Full Screen	±5% or ±1mm, whichever is greater	
Trace (Not Equal to 1540m/s)	mm	Full Screen	±7.5% or ±5mm, whichever is greater	All probes Not Equal To 1540m/s
Ellipse (Not Equal to 1540m/s)	mm	Full Screen	±7.5% or ±5mm, whichever is greater	All probes Not Equal To 1540m/s
Area:				
Trace (Equal to 1540m/s)	mm <sup>2</sup>	Full Screen	±10% or ±5mm <sup>2</sup> , whichever is greater	
Ellipse (Equal to 1540m/s)	mm <sup>2</sup>	Full Screen	±10%, or ±5mm <sup>2</sup> , whichever is greater	
Trace (Not Equal to 1540m/s)	mm <sup>2</sup>	Full Screen	±20% or ±20mm <sup>2</sup> , whichever is greater	All probes Not Equal To 1540m/s
Ellipse (Not Equal to 1540m/s)	mm <sup>2</sup>	Full Screen	±20% or ±20mm <sup>2</sup> , whichever is greater	All probes Not Equal To 1540m/s
Time	s	Timeline Display	±5%, not to exceed 10ms	M or Doppler Mode
Slope	mm/s	Timeline Display	±5%, not to exceed 1mm/s	M-Mode Only



Table 12-7: System Measurements and Accuracies (Continued)

Measurement	Units	Useful Range	Accuracy	Limitations or Conditions
Doppler Sample Volume Depth (SVD)	mm	Full Screen	2mm (0.2cm) in any direction	When SVD is at least half the depth of the image
Velocity	cm/s	Full Range	10%	PW and CW Doppler Mode
Doppler Angle Correction	degrees	From 0-59° From 60-90°	±1% ±2%	
<b>Shear Wave Speed Variation and Precision with Depth</b>				
Velocity	m/s	Shear wave ROI	Absolute range $\leq 0.5$ m/s or relative range $\leq 15\%$ , whichever is greater, for C1-6-D and C1-6VN-D. Absolute range $\leq 0.5$ m/s or relative range $\leq 10\%$ , whichever is greater, for all other probes with shear wave elastography.	Normalized SD less than or equal to 5% for multiple repeated measurements over the range of depths for which measurements can be made, limited by shear wave penetration.
<p>The formula for Stiffness: <math>E = 3 * \rho * c^2</math>            Where E = Young's modulus of tissue  <math>\rho</math> = density of tissue (assumed to be 1 g/cc)            c = shear wave speed in m/s  <i>Note: The conversion from shear wave speed (m/s) to Young's modulus is done under the assumption that the underlying material in which the shear wave propagates is linear, isotropic, incompressible, and homogenous.</i>  <i>Note: Relative Range = (Absolute Range / Actual Velocity).</i>  <i>Note: Normalized SD = (SD) / Average Velocity.</i></p>				

## **Clinical Calculation Accuracy**

Estimate the overall inaccuracy of a combined measurement and calculation by including the stated inaccuracy from the basic measurement accuracy statements.

Calculation formulas and databases are provided as a tool to assist the user, but should not be considered an undisputed database, in making a clinical diagnosis. The user is encouraged to research the literature and judge the equipment capabilities on an ongoing basis in order to assess its utility as a clinical tool.

## V Nav Magnetic Field Data

### For the Patient



#### DANGER

DO NOT use the Volume Navigation feature on any patient relying on life-sustaining electronic equipment, such as a pacemaker or defibrillator. Failure to follow this instruction could lead to interference with patient electronic device(s).



#### WARNING

The Tracker's magnetic fields may possibly interfere with nearby electrical systems, e.g., an EKG. It is the users's responsibility to identify nearby devices to ensure their performance is not degraded when you are simultaneously using Volume Navigation.

Electromagnetic Field Strength is measured in units called Tesla, or for smaller fields, milliTesla (mT). According to this article from the World Health Organization (WHO), <https://www.who.int/peh-emf/publications/facts/fs299/en/>, people with pacemakers should avoid fields that exceed 0.5 mT.

The electromagnetic field created by the transmitter in our Volume Navigation offering is 0.5 mT once you are 7.5cm away from the transmitter face and goes down quickly after that (0.1 mT at 18cm away, e.g.). Nevertheless, we recommend not using V Nav on patients relying on a pacemaker or defibrillator.

### V Nav Magnetic Field Data (continued)

#### For the Operator

The World Health Organization website addresses many items regarding exposure to electro-magnetic (EM) fields at <http://www.who.int/peh-emf/about/WhatisEMF/en/index.html> (see extract below).

#### Extracted from World Health Organization:

“Many people are surprised when they become aware of the variety of magnetic field levels found near various appliances. The field strength does not depend on how large, complex, powerful or noisy the device is. Furthermore, even between apparently similar devices, the strength of the magnetic field may vary a lot. For example, while some hair dryers are surrounded by a very strong field, others hardly produce any magnetic field at all. These differences in magnetic field strength are related to product design. The following table shows typical values for a number of electrical devices commonly found in homes and workplaces. The measurements were taken in Germany and all of the appliances operate on electricity at a frequency of 50 Hz. It should be noted that the actual exposure levels vary considerably depending on the model of appliance and distance from it.”

In the context of this, the VNav transmitter has the following EM field strengths at various distances from the transmitter face:

- 928 $\mu$ T at 5.1cm (2 inches) distance
- 287 $\mu$ T at 10.2cm (4 inches) distance
- 64 $\mu$ T at 20.3cm (8 inches) distance
- 11 $\mu$ T at 40.6cm (16 inches) distance
- 2.4 $\mu$ T at 71cm (28 inches) distance

**NOTE:** *Note that the field is only active when the green light on the position sensing electronics unit is on. This is the same unit that the transmitter plugs into.*

**V Nav Magnetic Field Data (continued)****Typical Magnetic Field Strength Data**

Typical magnetic field strength commonly found in your home are shown below:

Table 12-8: Typical magnetic field strength of household appliances at various distances

<b>Electric Appliance</b>	<b>3 cm Distance ( <math>\mu\text{T}</math> )</b>	<b>30 cm Distance ( <math>\mu\text{T}</math> )</b>	<b>1 m Distance ( <math>\mu\text{T}</math> )</b>
Hair Dryer	6 – 2000	0.01 – 7	0.01 – 0.03
Vacuum Cleaner	200 – 800	2 – 20	0.13 – 2
Portable Radio	16 - 56	1	< 0.01
Microwave Oven	73 - 200	4 - 8	0.25 - 0.6
Fluorescent Light	40 – 400	0.5 - 2	0.02 - 0.25
Electric Oven	1 - 50	0.15 - 0.5	0.01 - 0.04

# Privacy and Security

## Introduction

Privacy & Security considerations, capabilities and configuration of the LOGIQ Totus Ultrasound System are described in the LOGIQ Totus Privacy and Security Manual, available in the GE HealthCare Product Security Portal at the GE HealthCare Documentation Library website at:

<https://www.gehealthcare.com/support/documentation>

## Privacy & Security Environment

The GE HealthCare LOGIQ Totus Ultrasound System has been designed for an intended use with the following expectations of Privacy & Security protections included in the environment where this product will be used:

- The system should be connected to a secured LAN or VLAN, configured and segmented according to appropriate networking best practices, not open to unintended users or generally connected to a WAN.
- The LOGIQ Totus Ultrasound System should be physically secured in such a way that it is not accessible to unintended users.
- Default application users and passwords should be replaced with customized users and passwords.
- External media containing images, patient data, reports and logs should be secured. When no longer used, the data should be securely erased and/or the media should be securely deleted.
- The monitors of the LOGIQ Totus Ultrasound System should be placed in a way limiting the visibility of the screen content to the user only.

## How to contact GE HealthCare

For privacy and security concerns regarding GE HealthCare products, visit to : <https://www.gehealthcare.com/security>

## Identity Provisioning

The provisioning of user accounts includes the steps of account creation, maintenance, and suspension of the account when it is no longer needed. A user account is created for the use by a specific individual. It is associated with access rights.

### Management of user accounts

User accounts are created, maintained and suspended by users with administrator privileges. When received from factory the system has three predefined user accounts:

- “ADM”: an administrative user account
- “USR”: a normal user account template without administrative privileges
- “EUSR” : an emergency user account template with limited privileges

When receiving the LOGIQ Totus Ultrasound System, it is recommended to do the following steps to ensure control of the user accounts on the system:

- Change the password of the “ADM” account.
- Change the password of the “USR” user account.
- Create groups for local or LDAP users and set their rights/ privileges appropriately for your workflows and operating environment.
- Create user accounts for each individual user of the system:
  - Give each user the needed group memberships / privileges.
  - Make sure to give administrative privileges only to users intended to perform administrative tasks on the system, like configuring dataflows, managing users on the system, inspecting audit logs etc. As administrative privileges may give the user access to privacy and security related configurations on the system, there should be a limited number of users with these privileges.
  - It is recommended to create individual users for each user of the system. This is particularly relevant for the audit logging, to associate actions performed on the system with individual persons.

### Identity Provisioning (continued)

#### **Maintenance of user accounts**

It is recommended to establish administrative routines for removing user accounts no longer being used.

#### ***User information stored on the system***

The following information can be entered for a user defined on the system:

- User ID / User name (Required)
- Display ID (Optional)
- Last name (Required)
- First name (Optional)
- Title (Optional)
- Phone number (Optional)
- E-mail address (Optional)
- Address (Optional)

The user password is encrypted and not accessible in the system.

#### **User name and password restrictions**

The restrictions for usernames and passwords are:

- User names can be 1 - 32 characters long.
- Password can be 0 - 256 characters long.

It is recommended to enable and configure username and password policies as described below.

#### **Identity provisioning by use of Backup/Restore**

Users defined on a system can be copied from one system to another by use of the system's built-in Backup/Restore functionality.

### Network Infrastructure

The infrastructure of the network where the LOGIQ Totus Ultrasound System is connected must be configured to allow traffic. For information on inbound and outbound firewall configuration, refer to the LOGIQ Privacy and Security Manual, available in the GE HealthCare Product Security Portal at:

<https://www.gehealthcare.com/en-US/security>



# Anti-Virus Software Note

## LOGIQ Totus Security

Since the LOGIQ systems are integrated into your IT-network, GE HealthCare wants to make sure that you are aware of the proactive measures we are taking to secure the system. Below are measures we have implemented to secure the LOGIQ systems.

- Use of Windows\* Embedded Standard 10, a componentized version of Windows 10 specifically made for embedded systems. Only the components required are used for the LOGIQ scanners, thereby reducing the OS attack surface. Please note that Windows 10 IoT Enterprise is NOT the same operating system as Windows 10.
- Disabled the user's ability to access the internet and Windows desktop.
- Disabled, or made inaccessible, functionality that is typically used as malware vectors for spreading viruses (e.g. email services, web browsers).
- Disabled AutoRun functionality on removable media.
- Closed network entry points that are not in use by the LOGIQ scanner software by strict firewall configuration and by disabling Services. The only Internet connection needed is on outbound port to GE HealthCare's remote service platform (Insite™ ExC), which is only opened on request by the user and through a secure HTTPS connection (port 443), and inbound and outbound connections through port 104 for DICOM connectivity.

## **LOGIQ Totus Security (continued)**

- System provides user access controls under customer management to control scanner access.
- Uses secure integration and communication between systems (Scanners, Workstations and Servers).
- Monitor public security bulletins from software vendors and news services, analyze for applicability to the LOGIQ scanner, and include third party software security patches as necessary within GE HealthCare software.
- Release GEHC Ultrasound validated software or use other measures as necessary to resolve or mitigate product vulnerabilities.
- Assess potential vulnerabilities of our systems using up-to-date commercially available vulnerability scanning tools. Identified vulnerabilities are mitigated as appropriate based on risk assessment of the product.

GE HealthCare believes that this Defense in Depth strategy using the combination of the security measures above and the security standards of Microsoft Windows 10 IoT Enterprise will provide security against malware, especially for a system used in a professional hospital grade networking environment that itself should provide a high level of security measures.

Finally, a few points as to why GE HealthCare (as well as all other manufacturers of PC-based medical Ultrasound devices) do not use Anti-Virus software: Commercial Anti-Virus software is commonly used on general-purpose computers to detect the presence of malicious software (e.g. virus, Trojan horse, worm). Anti-Virus software is useful on general-purpose computers as they typically cannot be sufficiently hardened against the attack vectors used by malicious software.

## **LOGIQ Totus Security (continued)**

The LOGIQ ultrasound systems however are single purpose (dedicated) devices that have controlled intended use, and thus are well hardened. For the LOGIQ ultrasound systems, the potential patient safety and security risks introduced by using commercial Anti-virus software would outweigh the security benefits. Such risks include:

- Real-time anti-virus scanning can affect ultrasound system performance.
- The effectiveness of Anti-Virus software depends on regular updates of the virus definitions files. This would typically require internet connectivity for the ultrasound system.
- The Anti-Virus software itself is a popular attack vector.
- Disruptive nature of the support of the Anti-Virus software throughout the life cycle of the medical device. The operating system of a medical ultrasound system is part of a medical device that requires a special and controlled release process. Any update of the Anti-Virus software would require a change of the system software.

Due to the cited risks, the use of commercial anti-virus software is not part of the LOGIQ systems product security strategy.

\*Microsoft and Windows are trademarks of Microsoft Corporation.

# Loading Windows Patches

## Loading a Windows Patch

As part the product lifecycle management, GE HealthCare regularly analyzes and integrates software updates from our third party vendors into our products. These are typically released as part of regular updates or software releases.

To load a Windows patch onto the LOGIQ Totus:

1. Power down the LOGIQ Totus and insert the Windows Patch USB Flash Drive into a rear USB port.

*NOTE: Ensure that the system is USB Device Enabled (check setting on System Admin Utility page).*

2. Power on the LOGIQ Totus. Windows Patch files will be loaded onto the LOGIQ Totus automatically, following several screen prompts:
  - a. Select **Install SW...** on the Start Application screen.
  - b. Select OK on the first StartLoader screen.
  - c. Select the package and then select Install on the second StartLoader screen; software patch installation will begin.

*NOTE: The Patch package is installed at the root folder or under the SWLoad directory in the root folder of the USB.*

Multiple screens appear during the software re-imaging installation process. **DO NOT** interrupt this process **AND** follow instructions as they appear on the display.

- d. Once the installation is complete, a message displays saying that the “Software Installation completed successfully. System will reboot soon.” The LOGIQ Totus restarts.
3. When the system starts up after the software installation has finished, the following dialog displays: the “New Software Verification” Checklist.

## Performing Software Patch Verification

The Software Patch Verification dialog is **critical**. You **MUST** perform software verification after downloading and installing a software update.

- a. If you are able to successfully perform each function, then Pass all of the items and type your name into the Signature box and press OK. Press the Question Mark if you have questions about how to perform this task.



### CAUTION

Perform a check for all the features listed. You **MUST** ensure that the entire system functions normally, as expected, in each of the categories listed on the New Software Verification checklist.

These verification results are tracked for regulatory purposes, sent back to GE HealthCare for tracking, and approved with your signature.

- b. As you verify that each feature works correctly, select “Passed.” If all features work correctly and “Passed” is filled in for all features, then the signature field is enabled at the bottom of the New Software Verification Checklist.

Type your signature (minimum of three characters) and press **OK**. The system is now ready for use.

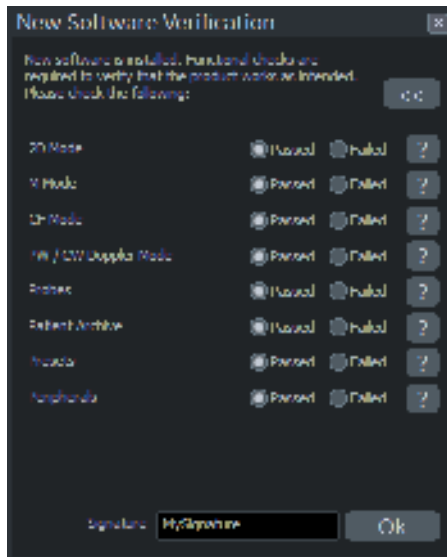

## Performing Software Patch Verification (continued)



### CAUTION

If any of the features **DID NOT** function as expected, you need to select “Failed” next to the feature that failed. Type your signature (minimum of three characters) and press **Reload**.

The version of the installed Patch appears on the Utility--> System--> About page.

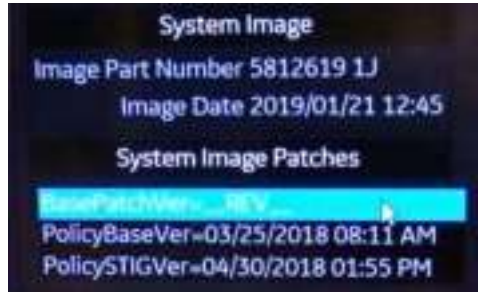

## Performing Software Patch Verification (continued)

- c. If one of the steps fails, then Fail the item(s).



- d. Type your **Signature**, then press **Reload**. The previous version of software will be reloaded onto the system automatically.
- e. Load the latest system patch which should be stored with the software located under the LOGIQ Totus covers.

### **Patch Installation Notes**

If by accident you try to load a patch that is not compatible with the software on the LOGIQ Totus, an error message will notify you of this incompatibility.

If there is any issue with the media, an error message will indicate “The package cannot be installed. The package is not compatible or has been tampered. Please contact GE HealthCare Service.”

The system may reboot multiple times during patch/software update.

If the software reload fails, an error message will indicate “Software Reload operation failed. Please contact GE HealthCare Service.”

### **Reloading Software**

When reloading software, you will need to reload the latest system patches which should be stored with the software located under the LOGIQ Totus covers.







# Software Download

## Overview

The LOGIQ Totus is designed to download software updates when they are available. Software Download monitors, notifies, delivers and installs available system software updates. This feature requires active InSite ExC connectivity.

When system software is available for download, a Software Download icon appears in the system status bar at the bottom of the monitor screen.

Table 12-9: Software Download Icons

	Software Download Available Icon
	Software Download In Progress Icon
	Software Download Paused Icon
	Software Download Complete/Ready to Install Icon
	Software Download Information Icon

## Software Download Available

When the “Software Download Available” icon appears in the status bar, select the icon to bring up the following Software Download and Install menu. Choose the desired option.



Figure 12-1. Software Download and Install Menu

## Start Software Download and Install

1. Select **Start** to begin the software download. The software download status displays in the menu and the Software Download in Progress icon appears in the system status bar at the bottom of the monitor.



Figure 12-2. Software Download in Progress

While the software is downloading, you can choose to pause the download, hide the Software Download and Install menu or stop the download.

- Select **Pause** to temporarily pause the download. The Software Download Paused icon appears in the system status bar. Select the icon again to bring up the Software Download menu and press **Resume** to resume the download from the previous download point.

**Start Software Download and Install (continued)**

- Select **Hide** to hide the Software Download menu (the download continues in the background). The Software Download in Progress icon appears in the system status bar. Select the icon again to bring up the Software Download menu.
  - Select **Stop Download** to discontinue the download process. The download progress is not saved, and the Software Download Available icon must be selected again to bring up the Software Download menu to restart the software download process.
2. When the download is complete the Software Download and Install menu informs you the software is ready to install.



Figure 12-3. Software Ready to Install Menu

Select **Start** to begin the installation. The installation begins and the software Installation in Progress status is displayed.

**Start Software Download and Install (continued)**

3. **New Software Verification** - When the software package installation is complete, the system shuts down and restarts. When the system restarts, the New Software Verification checklist dialog displays. You **MUST** perform the new software verification.



Figure 12-4. New Software Verification Dialog



**CAUTION**

Perform a check for all the features listed. You **MUST** ensure that the entire system functions normally, as expected, in each of the categories listed on the New Software Verification checklist.

As you verify that each feature works correctly, select “Passed.” If all features work correctly and “Passed” is filled in for all features, then the signature field is enabled at the bottom of the New Software Verification Checklist. Type your signature (minimum of three characters) and press OK. The system is now ready for use.

If any of the features **DID NOT** function as expected, you need to select “Failed” next to the feature that failed. Type your signature (minimum of three characters) and press Reload.

Contact your GE HealthCare Service Representative for assistance.

## More Info

Select **More Info** from the Software Download and Install menu to see details about the available software download.



Figure 12-5. More Info

## Remind Me Later

Select **Remind Me Later** to close the Software Download and Install Menu and download the software at a later time. The Software Download Available icon remains in the system status bar at the bottom of the monitor screen.

## Decline

Select **Decline** to decline the software download package. A popup displays.



Figure 12-6. Decline Software Download Package Popup

You can then select **OK** or **Cancel**.

- Select **OK** to decline the package. You must then enter a signature consisting of three or more characters.  
OR
- Select **Cancel** to go back to the Software Download and Install menu.

# Base Image and Software Load

## **Base Image and Software Load Procedure**

For the Base Image and Software Load procedure, refer to the LOGIQ Totus Basic Service Manual.

# Copyrighted Material

## Viewing Copyrighted Third Party Software License Information

The LOGIQ Totus contains copyrighted material. For more information, you can view Copyrighted Third Party Open Source Software Licenses via the Utility-> System-> Licenses page.

- Select Utility-> System-> Licenses
- Scroll to select the license you wish to view in the License Title section. Press Set.



Figure 12-7. Third Party Software License Information

- The selected software license appears in the License window. Use the Set+Trackball to scroll through the license.

# System Care and Maintenance

## Overview

Refer to Section 10 of the LOGIQ Totus Service Manual for any additional maintenance guidance.

The user must ensure that safety inspections are performed at least every 12 months according to the requirements of the patient safety standard IEC 60601-1. Refer to the Service manual, Chapter 10.

Only trained persons are allowed to perform the safety inspections mentioned above.

Technical descriptions are available on request.

To ensure that the unit constantly operates at maximum efficiency we recommend that the following procedures be observed as part of the customer's internal routine maintenance program.

Contact the local Service Representative for parts or periodic maintenance inspections.

## Expected Service Life Description

The expected service life for the LOGIQ Totus system and probes is identified in this table:

Table 12-10: Expected Service Life

Equipment / Accessory	Expected Service Life
LOGIQ Totus system	The expected service life for the LOGIQ Totus is at least seven (7) years from the manufacturing date under the provision of regular maintenance by authorized service personnel.
LOGIQ Totus Probes	The expected service life for the LOGIQ Totus probes meets or exceeds five (5) years from the date the probe is placed in service, under the provision that the customer follows the care instructions provided on the Probe Care Card / Accompanying LOGIQ Totus Instructions for Use.



## Maintenance Schedule

Follow this Maintenance Schedule to maintain optimum system function and patient care:

Table 12-11: LOGIQ Totus Maintenance Schedule

Monthly	Weekly	Daily	After Each Patient
<p>Inspect the following on a monthly basis:</p> <ul style="list-style-type: none"> <li>• Connectors on cables for any mechanical defects.</li> <li>• Entire length of electrical and power cables for cuts or abrasions.</li> <li>• Equipment for loose or missing hardware.</li> <li>• Control panel and keyboard for defects.</li> <li>• Casters for proper movement and locking operation.</li> </ul>	<p>Clean the following on a weekly basis:</p> <ul style="list-style-type: none"> <li>• Console                             <ul style="list-style-type: none"> <li>• System Cabinet</li> <li>• Removable Trackball/Trackball</li> </ul> </li> <li>• Air Filters (weekly, or as needed)</li> <li>• Footswitch</li> <li>• B/W Printer</li> <li>• Monitor and Monitor Frame</li> <li>• Operator Controls and Touch Panel</li> </ul>	<p>Clean and Disinfect the following areas where Cross Contamination can occur:</p> <ul style="list-style-type: none"> <li>• Operator Panel and Touch Panel</li> <li>• Monitor Frame</li> <li>• Front and Rear Handles</li> </ul>	<p>Clean and Disinfect the following after each patient:</p> <ul style="list-style-type: none"> <li>• Probe</li> <li>• Biopsy Bracket, as applicable</li> </ul> <p>Additionally, Clean and Disinfect any area on the system that has visible contamination from the previous exam.</p> <p>Note: Biopsy Accessories must be cleaned and disinfected or disposed of after each patient. Refer to the Probes Chapter, for probe cleaning and disinfecting instructions.</p>



### DANGER

To avoid electrical shock hazard, do not remove panels or covers from console. This servicing must be performed by qualified service personnel. Failure to do so could cause serious injury.

If any defects are observed or malfunctions occur, do not operate the equipment but inform a qualified service person. Contact a Service Representative for information.

## Cleaning and Disinfecting the System



**WARNING**

All cleaners and disinfectants **NOT** on this list are **unapproved** by GE HealthCare. Failure to follow guidelines could result in damage to the device.



**CAUTION**

When reprocessing the operator control panel, make sure not to spill or spray any liquid on the controls, into the system cabinet, or in the probe connection receptacle.



**CAUTION**

To avoid liquids entering the product, **DO NOT** spray any liquid directly onto the surfaces. **ALWAYS** use a cloth or wipe.



**CAUTION**

Avoid using ALCOHOL (ISOPROPANOL) 70% inside the trackball. ALCOHOL (ISOPROPANOL) 70% may also compromise the durability of the paint used on the console controls.



**CAUTION**

Oxivir TB Wipes may compromise the durability of the paint used on the console handles and controls. Avoid the use of any Hydrogen Peroxide (H<sub>2</sub>O<sub>2</sub>) based disinfectants on the HDU monitor, as it may result in damage to screen.

These cleaners/disinfectants can be used anywhere on the console (Operator Panel, Monitor, Probe Holders, etc.), except for the probes. Refer to 'Probe Disinfectants' on *page 11-41* for probe disinfectant information and web links.

Always consult the cleaner or disinfectant manufacturer's instructions for proper use of their product. Wear appropriate PPE as indicated by the manufacturer.

## Cleaning and Disinfecting the System (continued)

Appropriate cleaners/disinfectants for the console that have been validated for compatibility are shown below:

Table 12-12: Appropriate Cleaners/Disinfectants

Product	Manufacturer	Notes	Chemistry	Locale	Cleaner/ Disinfectant
Acryl-Des Wipes	Schülke & Mayr GmbH	Same as Mikrozyd Sensitive Wipes also by Schulke	Quat	Europe	Cleaner/ Disinfectant
Alcohol (Isopropanol) 70%	Generic		Alcohol	Global	Disinfectant
Cleanisept Wipes	Dr. Schumacher GMBH	Same as GE HealthCare branded Septiwipes	Quat	Europe	Cleaner/ Disinfectant
Clinell Clorox Wipes	GAMA HealthCare	Same formula as Clorox Healthcare Bleach Germicidal Wipes sold in USA	Bleach	Europe	Cleaner/ Disinfectant
Clinell Universal Sanitizing Wipes	GAMA HealthCare		Quat+ Polyhexanide (PHMB)	Europe	Cleaner/ Disinfectant
Clorox HealthCare Bleach Germicidal Wipes	Clorox Professional	Same formula as Clinell Clorox Wipes	Bleach	US Canada Europe	Cleaner/ Disinfectant
Easy Screen Cleaning Wipes	Professional Disposables Inc. (PDI)	This product is 70% IPA	Alcohol	US	Disinfectant
Mikrobac Tissues	BODE Chemie GmbH		Quat	Europe	Cleaner/ Disinfectant
Mikrozyd Sensitive Wipes	Schülke & Mayr GmbH	Same formula as Acryl-Des wipes	Quat	Europe	Cleaner/ Disinfectant
Oxivir TB Wipes	Sealed Air		H2O2	US Canada	Cleaner/ Disinfectant
Protex Ultra Wipes	Parker Laboratories	Same formula as SONO Wipes	Quat	US	Cleaner/ Disinfectant

Table 12-12: Appropriate Cleaners/Disinfectants (Continued)

Product	Manufacturer	Notes	Chemistry	Locale	Cleaner/ Disinfectant
Sani-Cloth HB Germicidal Disposable Wipe	Professional Disposables Inc. (PDI)		Quat	US	Cleaner/ Disinfectant
Sani-Cloth Plus Germicidal Disposable Cloth	Professional Disposables Inc. (PDI)	Same Formula as Asepti Wipes II	Quat + Alcohol	US	Cleaner/ Disinfectant
Sani-Cloth Prime Germicidal Disposable Cloth	Professional Disposables Inc. (PDI)		Quat + Alcohol	US	Cleaner/ Disinfectant
Septiwipes	EDM Medical Imaging	Same formula as Cleanisept Wipes	Quat	Europe	Cleaner/ Disinfectant
Sodium Hypochlorite 5.25% (Bleach) diluted 10:1	Generic	Same formula as Clorox Healthcare Bleach Germicidal Wipes sold in USA	Bleach	Worldwide	Cleaner/ Disinfectant
SONO ULTRASOUND WIPES	Advanced Ultrasound Solutions, Inc.		Quat	US	Cleaner/ Disinfectant
Super Sani-Cloth Germicidal Disposable Wipes	Professional Disposables Inc. (PDI)		Quat + Alcohol	US	Cleaner/ Disinfectant
Tristel Distel	Tristel		Quat+PHMB	Europe	Cleaner/ Disinfectant
Trophon Companion Cleaning Wipes	Nanosonics	Same formula as SONO Wipes	Quat	US	Cleaner/ Disinfectant
Virox Accel TB wipes	Virox Technologies Inc. (owned by Sealed Air)	Same formula as Oxivir TB	H2O2	CAN	Cleaner/ Disinfectant

## Console

### Cleaning the LOGIQ Totus Console

The LOGIQ Totus Console includes the System enclosure, Monitor, Monitor Frame, Operator Panel, Touch Panel, and Probe Holders. For Probes Reprocessing, see 'Probe Reprocessing' on *page 11-19*.

Always clean visible soil from surfaces first before disinfecting the Console.

Follow the cleaning/disinfecting frequency suggested in 'Maintenance Schedule' on *page 12-33*.

To clean the system,

1. Moisten a soft, non-abrasive folded cloth with a mild, general purpose, non-abrasive soap and water solution or approved cleaning/disinfecting agent.

**NOTE:** *The cloth/wipe should be damp, not dripping wet and running. Moisture should not drip into the crevices anywhere on the console.*

**NOTE:** *Refer to Table 12-12 on page 12-35 for a list of acceptable solutions to be used on the Console.*

2. Use a gentle wiping action to clean any surface on the console.



#### HINTS

A scrubbing action with the wipe may be necessary to help remove stubborn soil from the surfaces. However be careful with this action over cervices and gaps in the surface to prevent liquid from being scraped off the wipe and entering the product.

3. Wipe off excess cleaning agents.

**NOTE:** *Do not spray any liquid directly into the unit.*

**NOTE:** *DO NOT scratch or press on the panel with any sharp objects, such as pencils or pens, as this may result in damage to the panel.*

### Disinfecting the LOGIQ Totus Console

For disinfectants to be effective, the surface must first be clean. Refer to 'Cleaning the LOGIQ Totus Console' on *page 12-37*.

**ALWAYS** follow the manufacturer's instructions concerning the use of the disinfectant and follow the contact time to be sure the disinfectant's kill claims are accomplished.

Follow the cleaning/disinfecting frequency suggested in 'Maintenance Schedule' on *page 12-33*.

Disinfect the desired surfaces of the console. To prevent cross contamination, surfaces that are often touched during exams should be disinfected after every patient. To disinfect the system,

1. Moisten a sterile cloth with a liquid disinfectant or remove pre-moistened disinfectant wipe from the container.



#### CAUTION

If a cleaner/disinfectant wipe was used to clean off visible soil per the above section, a second, fresh cleaner/disinfectant product should be used for the disinfectant step.

2. Wet the surfaces by gently applying the cloth or wipe. Avoid high pressure or squeezing the wipe to avoid having the liquid enter the gaps and cervices of the Console. Scrubbing is not necessary in the disinfecting step; evenly applying the liquid is the goal.
3. Let the surface remain wet for the appropriate contact time.
4. If the surface does not remain wet for the full contact time, apply an additional application of the disinfectant, as necessary, to extend the time.
5. After the contact time has expired, remove excess liquid with a dry sterile cloth.
6. To avoid disinfectant buildup, or to remove disinfectant residue which may cause skin irritation, perform a rinse step with a sterile damp cloth.

### Probe Cleaning Notes

When cleaning/disinfecting probes, take care **NOT** to damage the Console with a solution that is approved for the probe but that **IS NOT APPROVED** for the Console. Refer to 'Probe Disinfectants' on *page 11-41* for a list of acceptable solutions to be used on the Console. Refer to the Probes Chapter, for probe cleaning and disinfecting instructions.



#### CAUTION

NEVER use any cleaner or disinfectant containing alcohol.

When cleaning/disinfecting probes using a spray cleaner/disinfectant, **DO NOT** spray the probe while the probe is set in its probe holder on the Ultrasound system.



Figure 12-8. DO NOT Spray a Probe While in its Holder

1. Spraying the probe while the probe is set in its probe holder can damage the Control panel.
2. If you are cleaning/disinfecting probes while they are on the ultrasound system, use a wipe cleaner/disinfectant.
3. Keep away from the ultrasound system while using a spray cleaner.

### Monitor and Monitor Frame

#### Monitor

To clean the Monitor:

1. Moisten a soft, non-abrasive folded cloth with a mild, general purpose, non-abrasive soap and water solution.

*NOTE: The cloth should be damp, not dripping wet.*

2. Wipe down the top, front, back, and both sides of the monitor.
3. Wipe off excess cleaning agents.

*NOTE: Never use thinner, benzene, alcohol (ethanol, methanol, or isopropyl alcohol), abrasive cleaners, or other strong solvents, as these may cause damage to the monitor.*

#### Monitor Frame

To clean the monitor frame:

1. Moisten a soft, non-abrasive folded cloth with a mild, general purpose, non-abrasive soap and water solution.

*NOTE: The cloth should be damp, not dripping wet.*

2. Wipe down the top, front, back, and both sides of the monitor frame.
3. Wipe off excess cleaning agents.

Other acceptable cleaning agents are:

- Ammonia
- Bleach (10 to 1 ratio of water to 5% home bleach)
- Hydrogen Peroxide / Hydrogen Peroxide Wipes

*NOTE: DO NOT scratch or press on the panel with any sharp objects, such as pencils or pens, as this may result in damage to the panel.*



### Operator Controls and Touch Panel

**ONLY USE** the following cleaners on the LOGIQ Totus Operator Panel:

- Palmolive Dishwashing Liquid (manufactured by Colgate-Palmolive, [www.colgatepalmolive.com](http://www.colgatepalmolive.com))
- Sani-Cloth® HB, green cap (manufactured by Professional Disposables International, [www.wearepdi.com](http://www.wearepdi.com)). *NOTE: May cause yellowing to the operator panel and probe cabling.*
- Super Sani-Cloth®, purple cap (manufactured by Professional Disposables International, [www.wearepdi.com](http://www.wearepdi.com))
- Sani-Cloth® Prime, plum cap (manufactured by Professional Disposables International, [www.wearepdi.com](http://www.wearepdi.com))
- Sono® Ultrasound Wipes (manufactured by Advanced Ultrasound Solutions, Inc, [www.UltrasoundWipes.com](http://www.UltrasoundWipes.com))
- Bleach (10 to 1 ratio of water to 5% home bleach)
- Hydrogen Peroxide / Hydrogen Peroxide Wipes

**DO NOT USE:**

- Cleaners or Disinfectants **NOT** listed above

### **Cleaning the Trackball**

To clean the Trackball,

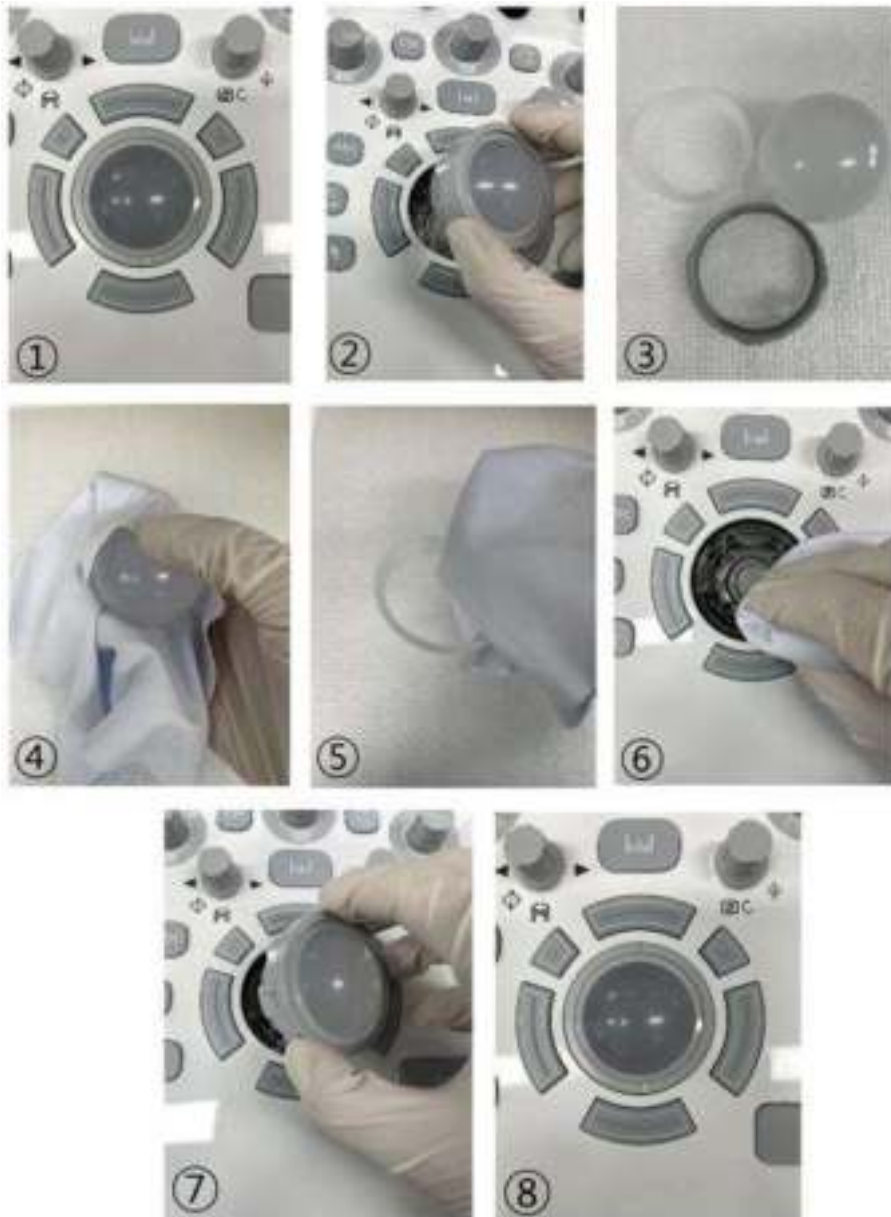

1. Twist and remove the trackball prior to cleaning both the trackball and trackball housing. (1-3)
2. Clean the trackball and trackball housing with dry, soft cloth. (4-6)
3. After cleaning the trackball, replace and twist the trackball into the trackball housing. (7-8)

## Other Maintenance

### Cleaning the air filter

Clean the system's air filters to ensure that a clogged filter does not cause the system to overheat and reduce system performance and reliability. It is recommended the filters be cleaned every two weeks, but the requirements will vary due to your system use.



#### CAUTION

Be sure to lock the wheels before cleaning the air filters to avoid injury by any unexpected movement of the system.

DO NOT operate the unit without the air filters in place.

Allow the air filters to dry thoroughly before re-installing them on the unit.

### Cleaning rear cover air filter

1. Pull the rear cover.



Figure 12-9. Remove the rear cover

### Cleaning rear cover air filter (continued)

2. Unlock the air filter and pull out from the rear cover.

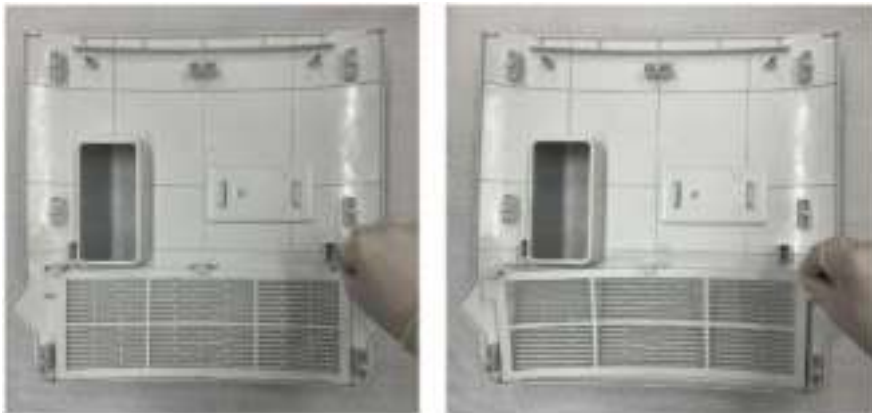

Figure 12-10. Remove the air filter

3. Dust the filter with a vacuum cleaner and/or wash it with a mild soapy solution.  
If washed, rinse and dry the filter before re-installation.
4. Put back the air filter into rear cover and assemble the rear cover.

### Cleaning side cover left/right air filter

1. Pull out the side cover left or right.



Figure 12-11. Remove the side cover left or right

**Cleaning rear cover air filter (continued)**

2. Unhook the air filter and pull out from the frame.

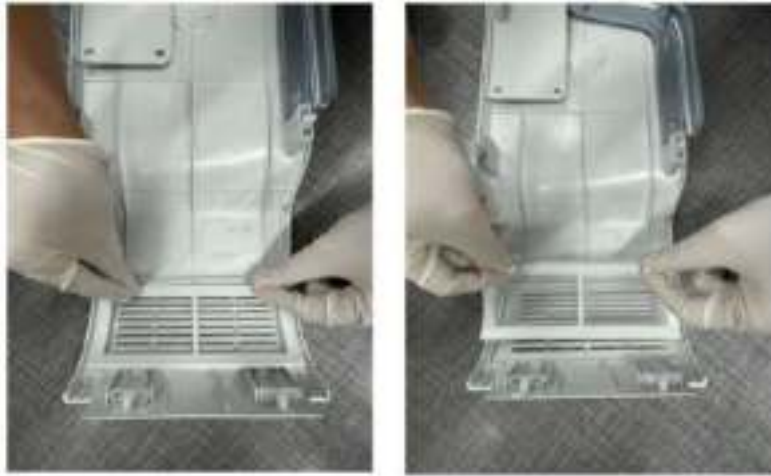

Figure 12-12. Remove the air filter

3. Dust the filter with a vacuum cleaner and/or wash it with a mild soapy solution.  
If washed, rinse and dry the filter before re-installation.
4. Put back the air filter into side cover left or right and assemble the rear cover.

## **Cleaning Storage Tray and TVTR probe holder**

### **Cleaning Base Tray**

1. Push up the base tray from the bottom and disassemble from the system.
2. Wash the tray with mild detergent.
3. Thoroughly dry the tray using a clean, low-lint, soft cloth or wipe.
4. Attach the tray to the system.



Figure 12-13. Disassemble the base tray

### **Cleaning the Control panel rear tray (Option)**

1. Unhook 3 hooks on the bottom of the tray.
2. Pull the tray with the arrow direction.
3. Wash the tray with mild detergent.
4. Thoroughly dry the tray using a clean, low-lint, soft cloth or wipe.
5. Attach the tray to the system.



Figure 12-14. Disassemble the Control panel rear tray

### Cleaning the Control panel rear tray (Option)

1. Grab the rear basket with 2 hands and pull up to disassemble.
2. Wash the tray with mild detergent.
3. Thoroughly dry the tray using a clean, low-lint, soft cloth or wipe.
4. Attach the tray to the system until the clicking sound heard.



Figure 12-15. Disassemble the rear basket



## **Cleaning Storage Tray and TVTR probe holder (continued)**

### **Cleaning TVTR Probe Holder**

1. Pull the hook to disassemble the probe holder from the system.
2. Wash the probe holder with mild detergent.
3. Thoroughly dry the probe holder using a clean, low-lint, soft cloth or wipe.
4. Put the probe holder to the original position.



Figure 12-16. Pull the hook to disassemble the probe holder

### Replacing key caps

Contact a local Service Representative when a key cap needs to be replaced.

For Feature Keys, the user can rearrange these keys if desired. Please see 'System/User Configurable Key' on *page 10-26* for more information on how to remove and replace these Feature keycaps.

### Footswitch

To clean the footswitch:

1. Disconnect the footswitch from the LOGIQ Totus.
2. Moisten a soft, non-abrasive folded cloth with a mild, general purpose, non-abrasive soap and water solution.

*NOTE:*

*The cloth should be damp, not dripping wet.*

3. Wipe the external surfaces of the unit then dry with a soft, clean, cloth.

# Quality Assurance

## Introduction

A good Quality Assurance Evaluation program consists of periodic systematic actions that provide the user with adequate confidence that their diagnostic ultrasound system will produce consistently high quality images and quantitative information.

Therefore, it is in the best interests of every ultrasound user to routinely monitor equipment performance.

The frequency of Quality Assurance evaluations should be based on user's specific needs and clinical practice.

Periodic monitoring is essential in order to detect the performance changes that occur through normal aging of system components. Routine equipment evaluations may also reduce the duration of exams, number of repeat exams, and maintenance time required.

*NOTE: For information on setting up the Image Quality Check, refer to Image Quality Check .*

For details on system and peripheral routine preventive maintenance instructions, See 'System Care and Maintenance' on *page 12-32 for more information.*

### Typical Tests to Perform

Quality assurance measurements provide results relating to system performance. Typically these are:

- Axial Measurement Accuracy
- Lateral Measurement Accuracy
- Axial and Lateral Resolution
- Penetration
- Functional & Contrast Resolution
- Gray Scale Photography.

With these tests, a performance baseline can be set at installation with the phantom in your department. Future test results can be compared to the baseline in order to maintain a record of system performance trends.

The phantom shown is shown as a representative example of a phantom. You can select from any number of phantoms available on the market.

### Frequency of tests

Quality assurance tests are used to determine whether a scanner is providing the same level of performance from day to day.

The frequency of testing varies with the amount of system usage and modes to be tested. It is recommended that the user perform quality assurance tests at least every three months or every 400 patient studies. Tests should also be performed when a question about system performance exists.

A mobile system may require more frequent tests.

Image quality should also be tested immediately after the following events:

- Service calls
- System upgrades/modifications
- Dropped probe, power surge, etc.

## Phantoms

Quality Assurance Evaluations may be done with phantoms and test objects that are applicable to the parameters being evaluated or to the user's clinical practice.

Typical phantoms are composed of material that acoustically mimic human tissue. Pins, anechoic and echogenic targets are physically positioned to provide information for a variety of tests.

The RMI 403GS phantom is shown in the illustration below as a representative example of a phantom.

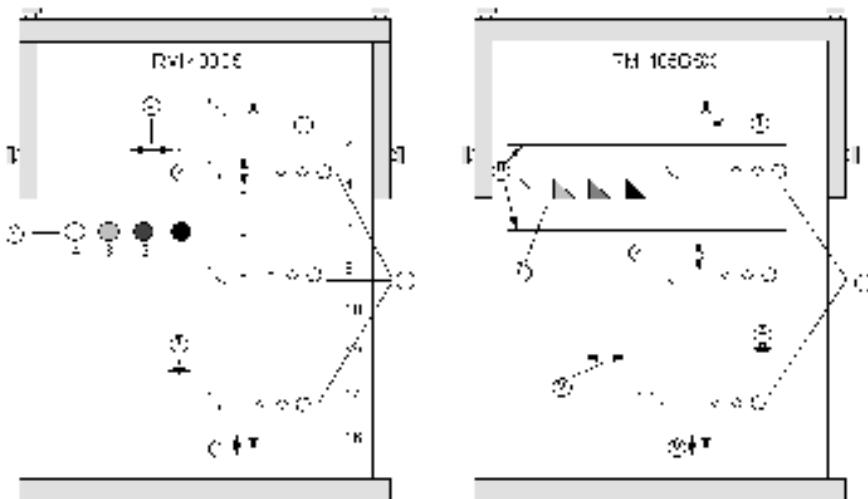

Figure 12-17. Representative Phantom Example

1. Penetration
2. Axial Distance Measurement
3. Functional Resolution
4. Lateral Resolution
5. Lateral Distance Measurement
6. Axial Resolution
7. Contrast Resolution and Gray Scale Photography
8. Gray Scale Plane Targets

### Baselines

An absolute necessity for a quality assurance program is establishing baselines for each test or check. Baselines are established after the system has been verified to be working properly at installation or after a repair. If a probe or major assembly is replaced, new baselines should be generated.

Baselines can be made by adjusting system parameters to prescribed levels or to the best possible image. The key factor to remember is reproducibility. The same conditions must be reproduced for each periodic check.

All system parameters not displayed on the monitor should be recorded for the permanent record.

### Periodic Checks

Periodic checks should be performed in accordance with your facility's quality assurance requirements. For the data to be valid, periodic checks should mimic the baseline setup parameters.

The resulting image, when scanning the phantom exactly as before, should be recorded and compared to the baseline. When a matching image is obtained, it can be assumed that the system performance has not degraded from the baseline.

If a significant difference between the baseline and periodic check is noted, double check the system setup and repeat the test. If the difference between the baseline and periodic check persists, contact a local Service Representative.

Failing to reproduce the control settings as in the baselines will introduce errors in the data and potentially invalidate the results.

## Results

Lack of standardization among test instruments, the wide range of acceptance criteria, and incomplete knowledge regarding the significance of certain performance parameters prohibit the establishment of absolute performance criteria for these tests.

Quality Assurance Evaluation results should be compared to previously-recorded results.

Performance trends can then be detected. Unacceptable performance or diminishing trends should be identified for maintenance or repair before a malfunction or inappropriate diagnosis occurs.

The user should determine the best method for recording and archiving the baseline and periodic checks. In most cases the choice is hard copy.

It is important to maintain good consistent records for inspections that may arise, as well as to detect system performance trends.

## System Setup

The user should tailor the tests to their particular needs. It is certainly not necessary to make all checks with all probes. A representative example, with the probes used most often by the customer, should be adequate in judging system performance trends.

Use a gray scale phantom as the scan object for the tests. Commercial phantoms are supplied with its own operator manual. Be familiar with proper phantom operating procedures prior to use for quality assurance evaluations.

1. Adjust image monitor. Brightness and contrast should be set to the normal viewing of a good gray scale image.
2. Check all recording devices for proper duplication of image monitor. Ensure that what is seen is what is recorded.
3. Annotate non-displayed image processing controls.
4. Set TGC slide pots to center (detent) position.
5. Place focal zone marker(s) in area of interest for an optimum image.

## **Test Procedures**

The following are recommended Quality Assurance tests. A brief description of the test, the benefit it provides and steps to accomplish the test are supplied.

The importance of recording scan parameters and consistent record keeping cannot be stressed enough. Reproducibility to monitor system trends is the key to quality assurance evaluations.

Using the system's dual image display format is often very convenient and saves recording media.



## Axial distance measurements

### Description

Axial measurements are the distance measurements obtained along the sound beam. See Figure 12-17 for more information.

### Benefit

The accurate measurement of the size, depth and volume of a structure is a critical factor in determining a proper diagnosis. Most imaging systems use depth markers and/or electronic calipers for this purpose.

### Method

Axial distance should be measured in the near, mid and far fields as well as in zoom. If necessary, different depths or fields of view can be tested.

### Procedure

To measure axial distance:

1. Scan a test phantom with precisely-spaced vertical pin targets. Adjust all scan controls, as necessary, for the best image of the pin targets to typical depths for the probe being used.
2. Press **Freeze** to stop image acquisition and perform a standard distance measurement between the pins at different points in the image. Record all images for archiving.
3. Scan the vertical pins in zoom or at different depth/scale factors.
4. Press **Freeze** to stop image acquisition; repeat the distance measurements between pins and record the images for archiving.
5. Document the measurements for reference and future comparison.

Contact a Service Engineer if vertical measurements differ by more than 1.50% of the actual distance.

### Lateral distance measurements

#### Description

Lateral measurements are distance measurements obtained perpendicular to the axis of the sound beam. See Figure 12-17 for more information.

#### Benefit

The purpose is the same as vertical measurements. Precisely-spaced horizontal pin targets are scanned and results compared to the known distance in the phantom.

#### Method

Lateral distance should be measured in the near, mid and far fields as well as in zoom. If necessary, different depths of fields of view can be tested.

#### Procedure

To measure lateral distance:

1. Scan a test phantom with precisely-spaced horizontal pin targets. Adjust all scan controls, as necessary, for the best image of the pin targets from side to side.
2. Press **Freeze** to stop image acquisition and perform a standard distance measurement between the pins at different points in the image. Record all images for archiving.
3. Scan the horizontal pins in zoom or at different depth/scale factors.
4. Press **Freeze** to stop image acquisition; repeat the distance measurements between pins and record the images for archiving.
5. Document the measurements for reference and future comparison.

Contact a Service Engineer if horizontal measurements differ by more than 3mm or 3% of that distance, whichever is greater.

## Axial resolution

### Description

Axial resolution is the minimum reflector separation between two closely-spaced objects to produce discrete reflections along the axis of the sound beam. It can also be monitored by checking the vertical size of known pin targets. See Figure 12-17 for more information.

Axial resolution is affected by the transmitting section of the system and the probe.

### Benefit

In clinical imaging, poor axial resolution displays small structures lying close together as a single dot. This may lead to improper interpretation of the ultrasound image.

### Procedure

To measure Axial resolution:

1. Scan a test phantom with precisely-spaced vertical pin targets.
2. Adjust all scan controls, as necessary, for the best image of the pin targets to typical depths for the probe being used.
3. Press **Freeze** to stop image acquisition.
4. Perform a standard distance measurement of the pin vertical thickness at different points in the image. Record all images for archiving.
5. Scan the vertical pins in zoom or at different depth/scale factors.
6. Press **Freeze** to stop image acquisition; repeat the vertical thickness measurements of the pins and record the images for archiving.
7. Document the measurements for reference and future comparison.

Axial resolution should remain stable over time. Contact a Service Engineer if any changes are observed.

### Lateral resolution

#### Description

Lateral resolution is the minimum reflector separation between two closely spaced objects to produce discrete reflections perpendicular to the axis of the sound beam. It can also be monitored by checking the horizontal size of known pin targets. See Figure 12-17 for more information.

Lateral resolution is dependent upon the beam width produced by the probe. The narrower the beam, the better the lateral resolution.

The beam width is affected by the frequency, degree of focusing, and distance of the object from the face of the probe.

#### Benefit

Clinically, poor lateral resolution will display small structures lying close together as a single dot. This may lead to improper interpretation of the ultrasound image.

#### Procedure

To measure lateral resolution:

1. Scan a test phantom with precisely-spaced horizontal pin targets.
2. Adjust all scan controls, as necessary, for the best image of the pin targets from side to side.
3. Press **Freeze** to stop image acquisition and perform a standard distance measurement of the horizontal thickness of a pin at different points in the image. Record all images for archiving.
4. Scan the horizontal pins in zoom or at different depth/scale factors.
5. Press **Freeze** to stop image acquisition; repeat the horizontal thickness measurements of the pins and record the images for archiving.
6. Document the measurements for reference and future comparison.

Pin width should remain relatively constant over time ("1mm). Dramatic changes in pin width may indicate beamforming problems. Contact a Service Engineer if beam width changes consistently over 2 to 3 periodic tests.

## Penetration

### Description

Penetration is the ability of an imaging system to detect and display weak echoes from small objects at large depths. See Figure 12-17 for more information.

Penetration can be affected by the system's:

- Transmitter/receiver
- Degree of probe focusing
- Attenuation of the medium
- Depth and shape of reflecting object
- Electromagnetic interference from local surroundings.

### Benefit

Weak reflecting echoes are commonly produced from the internal structure of organs. Definition of this tissue texture is important in the interpretation of the ultrasound findings.

### Method

Scan a phantom to see how echoes begin to fade as depth is increased. The maximum depth of penetration is the point at which homogeneous material in the phantom begins to lose brightness.

### Procedure

To measure penetration:

1. Set the front panel TGC slide pots to their center (detent) position.
2. Gain and acoustic output can be adjusted, as necessary, since these values are displayed on the monitor.
3. Scan a test phantom along the vertical pin targets to typical depths for the probe being used.
4. Perform a standard distance measurement from the top of the image displayed to the point at which homogeneous material in the phantom begins to lose brightness.
5. Document the depth measurement for reference and future comparison.

Contact a Service Engineer if the depth of penetration shifts more than one centimeter (1cm) when using the same probe and same system settings.

### Functional resolution

#### Description

Functional resolution is an imaging system's ability to detect and display the size, shape, and depth of an anechoic structure, as opposed to a pin target. See Figure 12-17 for more information.

The very best possible image is somewhat less important than reproducibility and stability over time. Routine tests at the same settings should produce the same results.

#### Benefit

The data obtained will give a relative indication of the smallest structure the system is capable of resolving at a given depth.

#### Procedure

To measure functional resolution:

1. Set the front panel TGC slide pots to their center (detent) position.
2. Gain and acoustic output can be adjusted as necessary, since these values are displayed on the monitor.
3. Scan a test phantom with a vertical row of anechoic cyst targets to typical depths for the probe being used.
4. Evaluate the cysts at various depths for a good (round) shape, well-defined borders and no fill in. Remember, TGC slide pots are centered and should remain fixed. This may NOT provide optimal cystic clearing.
5. Document all results for future reference and comparison.

Contact a Service Engineer if a greatly distorted image is obtained.

## Contrast resolution

### Description

Contrast resolution is the ability of an imaging system to detect and display the shape and echogenic characteristics of a structure. See Figure 12-17 for more information.

Specific values measured are less important than stability over time. Routine tests at the same settings should produce the same results.

### Benefit

A correct diagnosis is dependent upon an imaging system's ability to differentiate between a cystic or solid structure versus echo patterns from normal surrounding tissue.

### Method

A phantom with echogenic targets of different sizes and depths should be used.

### Procedure

To measure contrast resolution:

1. Set the front panel TGC slide pots to their center (detent) position. Set dynamic range to 54 db.
2. Gain and acoustic output can be adjusted, as necessary, since these values are displayed on the monitor.
3. Scan a test phantom with echogenic targets at the depths available.
4. Evaluate the echogenic targets for contrast between each other and between the surrounding phantom material. Remember, TGC slide pots are centered and should remain fixed. This may NOT provide an optimal scan image.
5. Document all results for future reference and comparison.

Contact a Service Engineer if the echogenic characteristics or shapes of the targets appear distorted.

### Gray Scale photography

#### Description

Poor photography will cause loss of low level echoes and the lack of contrast between large amplitude echoes. See Figure 12-17 for more information.

#### Benefit

When photographic controls and film processors are properly adjusted, weak echoes, as well as strong echoes, are accurately recorded on film.

#### Procedure

1. Adjust the camera according to the manufacturer's instructions until the hard copy and video display are equal.
2. Scan the phantom and it's echogenic contrast targets.
3. Make a hard copy photograph of the display and compare it to the image on the video monitor for contrast and weak echo display.
4. Document all results for future reference and comparison.

Contact a Service Engineer if camera cannot duplicate what is on the image monitor.

*NOTE: Optimization of brightness/contrast controls on the display monitor is imperative in order to make sure that the hardcopy and monitor look alike.*

The display monitor is adjusted first. The hardcopy camera or printer is adjusted to match the display monitor.



## Setting up a Record Keeping System

### Preparation

The following is needed:

- Quality Assurance binder.
- Hard copy or electronic file of images.
- Quality Assurance Checklists.
- Display the following information while testing quality assurance:
  - Acoustic Output
  - Gain
  - Depth
  - Probe
  - Dynamic Range
  - Set up new patient to be the name of the test.
- Annotate the following:
  - Any control where its value is **NOT** displayed.
  - Significant phantom information.

### Record Keeping

Complete the following:

1. Fill out the Ultrasound Quality Assurance Checklist for each probe, as scheduled.
2. Make a hard copy or archive the image.
3. Compare images to baseline images and acceptable values.
4. Evaluate trends over previous test periods.
5. File hard copy or electronic file of images and checklist in Quality Assurance binder.

## Ultrasound Quality Assurance Checklist

Table 12-13: Ultrasound Quality Assurance Checklist (Part 1)

Performed By		Date
System		Serial Number
Probe Type	Probe Model	Serial Number
Phantom Model	Serial Number	Room Temperature
Acoustic Output	Gain	Focal Zone
Gray Map	TGC	Depth
Monitor Setting		
Peripheral Settings		
Other Image Processing Control Settings		

Table 12-14: Ultrasound Quality Assurance Checklist (Part 2)

Test	Baseline Value Range	Tested Value	Image Hardcopy/Archived	Acceptable? Yes/No	Service Called (Date)	Date Resolved
Vertical Measurement Accuracy						
Horizontal Measurement Accuracy						
Axial Resolution						
Lateral Resolution						
Penetration						
Functional Resolution						
Contrast Resolution						
Gray Scale Photography						

# Image Quality Check

## Image Quality Check (IQC)

Image Quality Check is intended to facilitate Image Quality checks during Quality Assurance Evaluations. Quality Assurance tests are used to determine whether a scanner is providing the same level of performance year after year.

By using the same settings year after year, this ensures that the data collection is consistent, independently of who performs the test.

This preset only includes fundamental settings for B-Mode. Processing modes like SRI, Harmonics, etc., are turned off.

To do an Image Quality Check (IQC),

1. Activate IQC via Utility--> Imaging Preset Manager--> Category (select the Category first).
2. Click on the plus sign in front of IQC for Service and select IQC.
3. Assign IQC to a Touch Panel key by using the right arrow key.
4. Map the IQC to the location you want it to appear on the Touch Panel.
5. Select Probe. Then select IQC.

## Supplies/Accessories





Not all features or products described in this document may be available or cleared for sale in all markets.

Contact the distributor, GE HealthCare affiliate or sales representative for approved peripherals. For HCATs, contact your sales person. For field service replacement part numbers (FRUs), these are service replacement part numbers that may be either new or refurbished, please consult the Basic Service Manual. To order these, contact CARES in the US, or call service in Europe and Asia.

The following supplies/accessories have been verified to be compatible with the system:

## Peripherals

Table 12-15: Peripherals and Accessories

Accessory	Illustration/Photo
Onboard Printer installation kit (UP-D898DC)	
Sony UP-D25M Color Printer	
Footswitch, USB	
Powervar144k120v MG UPS UPS	N/A
Powervar144k 230V MG UPS	N/A
Magstripe Card Reader	
ASUS Z380M-A2-GR ZenPad 8 Tablet	N/A
Digital Expert (Microsoft-Surface)	N/A
Ethernet protection cable (GES.2203369.01)	N/A

Console

Table 12-16: Console Accessories







Accessory	Illustration/Photo
AN keyboard English	
AN keyboard German	
AN keyboard French	
AN keyboard Greek	
AN keyboard Norwegian	
AN keyboard Russian	
AN keyboard Swedish	
Power Cord - North American	
Power Cord - Argentina	
Power Cord - Europe	
Power Cord - UK-Ireland	
Power Cord - Switzerland	
Power Cord - Denmark	
Power Cord - Italy	
Power Cord - Israel	

Table 12-16: Console Accessories (Continued)



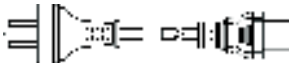

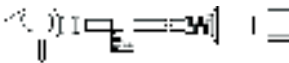
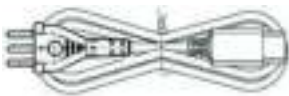
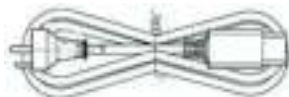

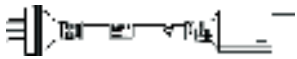
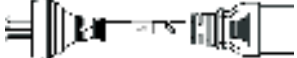

Accessory	Illustration/Photo
Power Cord - Japan	
Power Cord - China	
Power Cord - Australia/New Zealand	
Power Cord - India	
Power Cord - South Africa	
Power Cord - Brazil	
Power Cord - Taiwan	
TVTR Probe Holder Assembly	
Probe Cable Hanger	
Rear basket	

Table 12-16: Console Accessories (Continued)

Accessory	Illustration/Photo
Drawer	
Rear handle cable hook	
Gel warmer	
OPIO rear tray	



## Volume Navigation

Table 12-17: Volume Navigation

<b>Accessory</b>
V Nav Active Tracker (Omni TRAX) Starter Kit
V Nav Needle Tracking Storage Insert
V Nav eTRAX <ul style="list-style-type: none"> <li>• 18/20g Starter Kit</li> <li>• 14g Starter Kit</li> <li>• 12g Starter Kit</li> </ul>
V Nav Probe Sensor
Probe Holder Insert
Volume Navigation Stand
V Nav Needle Tracker Starter Kit
V Nav Needle Virtual Tracker Starter Kit (VirtuTRAX)
Virtual Tracker Sensor
Volume Navigation Bracket Starter Kit
V Nav Upgrade to Needle Tracking Kit

### V Nav Shelf Load Description

Shelf load for the V Nav wire shelf on the V Nav Stand is 10 lbs.

## Hardware options

Table 12-18: Hardware options

Accessory
CW Doppler Option
Realtime 4D
ECG Option
Battery Option
Volume Navigation
WLAN (AX210)
UVSC Option
Pencil CW Hardware Kit
EMI Filter (TNC, BF-10A)
Gel warmer
Vscan Air Charger
HDU monitor

## ECG Accessories

Table 12-19: ECG Accessories

Accessory
ECG Cables, IEC, AHA Style for Americas
ECG Cables, IEC Style
ECG Cable Kit

## Probes

Table 12-20: Probes and Accessories

Probe	Biopsy Guide	V Nav Capable
C1-6-D Convex	Verza starter Kit Note: ONLY support Verza Starter Kit.	No
	Biopsy Starter Kit	
C1-6VN-D Convex	Verza starter Kit Note: ONLY support Verza Starter Kit.	Yes
C2-7-D Convex	Multi-angle disposable with a reusable bracket	No
	Multi-Angle Reusable Stainless Bracket	
C2-7VN-D Convex	Multi-angle disposable with a reusable bracket	Yes
	Multi-Angle Reusable Stainless Bracket	
Vscan Air CL	N/A	No
C3-10-D Convex	N/A	Yes
IC5-9-D Micro Convex Intracavitary	Single Angle	Yes
	Disposable with a Plastic Bracket or	
	Reusable with a Stainless Steel Bracket	
9L-D Linear	Multi-angle	Yes
L3-12-D	Multi-angle	No
L6-24-D Linear Array	N/A	No
M5Sc-D XDclear Active Matrix Single Crystal Phased Array Transducer	Multi-angle disposable with a reusable bracket	Yes
ML6-15-D Matrix Array Linear	Multi-angle	Yes
RIC5-9-D 4D Convex Volume Intracavitary	Single Angle, Reusable Biopsy Kit for RAB Light or Disposable with a Plastic Bracket	N/A
RAB6-D 4D Volume	Starter Kit	N/A
	RAB Biopsy Starter Kit	
6S-D	N/A	No

Table 12-20: Probes and Accessories (Continued)

<b>Probe</b>	<b>Biopsy Guide</b>	<b>V Nav Capable</b>
12S-D	N/A	No
P2D Pencil Probe	N/A	N/A
P6D Pencil Probe	N/A	N/A

## Options

*NOTE: Not all options are available in all countries.*

Table 12-21: Options

Option
Advanced Security
*Coded Contrast - AM
Cardiac Automated Functional Imaging (AFI)
Report Writer
Stress Echo
Tricefy (Not for sale)
LOGIQ Apps
KOIOS SW
Thyroid Assistant, Powered by Koios DS
Scan Assistant
Advanced Probes
Auto IMT
B-Steer+
B-Flow
Compare Assistant
DICOM
Flow Quantification (Q-Analysis)
Breast Measure Assist
OB Measure Assistant
Elastography
Elastography QA
Shear Wave Elastography
Ultrasound Guided Attenuation Parametre (UGAP)
Hepatic Assistant
SonoNT/SonoIT
DVR
SRI HD Type2

Table 12-21: Options (Continued)

Option
OmniView
STIC
TUI
VCI Static
VOCAL II
Thyroid Productivity
Breast Productivity
VITA on Demand
Vscan Air CL
Auto Preset Assistant
Voice Control
eDelivery
Verisound Fleet
UPS Document Kit
<p>*The LOGIQ Totus is designed for compatibility with commercially available Ultrasound contrast agents. Because the availability of these agents is subject to government regulation and approval, product features intended for use with these agents may not be commercially marketed nor made available before the contrast agent is cleared for use. Contrast-related product features are enabled only on systems for delivery to an authorized country or region of use.</p>

**Gel**

Table 12-22: Gel — Refer to Accessories Catalog

Accessory	Units
Thermasonic Gel Warmer	Holds three plastic bottles (250ml or 8 oz)
Aquasonic 100 Scan Gel	5 liter jug
	250 ml plastic bottles (12/case)
Scan Ultrasound Gel	8 oz plastic bottles (12/case)
	1 gallon plastic jug
	Four 1-gallon plastic jugs

**Disinfectant**

Table 12-23: Disinfectant — Refer to Accessories Catalog

Accessory	Units
Cidex Activated Dialdehyde	16/1 quart bottles
	4/1 gallon bottles
	2/2.5 gallon bottles

**Ultrasound Probe and Cord Sheath Sets**

Table 12-24: Probe and Cord Sheath Sets — Refer to Accessories Catalog

Accessory	Units
Sterile Ultrasound Probe Sheath Set	20 Per Set
Sterile Ultrasound Cord Sheath Set	20 Per Set
Sanitary Rectal/Vaginal Probe Cover	20 Per Set
Sterile Combination Probe and Cord Cover Set	12 Per Set
Sterile Ultrasound Probe Sheath Set for Wide (2.5 and 3.5) Aperture Sector Probes	20 Per Set





---

# Chapter 13

## Advanced Features

*Describes Advanced system features and options.*

# Table of Contents

'Using 4D' on page 13-4

'Contrast Imaging' on page 13-55

'Strain Elastography' on page 13-100

'Elastography Analysis' on page 13-106

'Shear Wave Elastography' on page 13-111

'Ultrasound-Guided Attenuation Parameter (UGAP) Option' on page 13-141

'Continuous Wave Doppler (CWD)' on page 13-147

'Tissue Velocity Imaging (TVI)' on page 13-149

'Quantitative Analysis (QAnalysis)' on page 13-152

'Stress Echo' on page 13-172

'Cardiac Automated Functional Imaging (Cardiac Strain)' on page 13-208

'Auto EF' on page 13-231

'ECG' on page 13-238

'Volume Navigation' on page 13-244

'Breast Productivity Package' on page 13-302

'Thyroid Productivity Package' on page 13-308

'Start Assistant' on page 13-315

'Scan Assistant' on page 13-320

'Compare Assistant' on page 13-358

'OB Measure Assistant' on page 13-369

'Hepatic Assistant' on page 13-371

'Vscan Air™ CL (Option)' on page 13-378

'EZ Imaging' on page 13-398

'Anonymize the patient' on page 13-407

'Report Writer' on page 13-409

'Configuring DICOM' on *page 13-466*

'Configuring the Wireless Network' on *page 13-470*

'Tricify Uplink' on *page 13-482*

'Device Mgmt' on *page 13-488*

'Smart Device Apps' on *page 13-505*

'Digital Expert' on *page 13-515*

'Service and Applications Support' on *page 13-516*

'Service Desktop' on *page 13-525*

'Battery Power Mode' on *page 13-526*

'Magstripe Card Reader' on *page 13-537*

'Footswitch' on *page 13-538*

'DVR' on *page 13-539*

'Auto Preset Assistant' on *page 13-545*

'Voice Control' on *page 13-558*

'Data Streaming (Option)' on *page 13-565*

## 4D Introduction

4D provides continuous, high volume acquisition of 3D images. 4D adds the dimension of “movement” to a 3D image by providing continuous, real-time displays. With 4D, you can apply rendering techniques to smooth out the appearance of an anatomical structure, for example, a baby’s spine.

You can perform the following types of volume acquisitions within the 4D feature:

Table 13-1: 4D Package Options

4D Type	Description	Acquisition Mode
4D	Designed for continuous volume acquisition of a 3D image.	B, 4D
Static 3D	Designed for single volume acquisition of a 3D image.	B, 3D

## Features supported with 4D

The following features are supported with 4D:

- Most B-Mode controls
- Annotations
- Measurements and Calculations

The following post-processing controls are available with 4D:

- CINE
- Zoom

## 4D Principles of Operation

The acquisition of volume starts with a 2D image using special probes designed for performing 3D sweeps and 4D scans. The volume box defines the region of interest to be used for the volume sweep.

Volume sweep refers to the range of the sweep of the 2D image to be transformed into a rendered, 3D or 4D image. Static 3D acquisition involves a single volume sweep. 4D involves multiple, continuous volume sweeps.

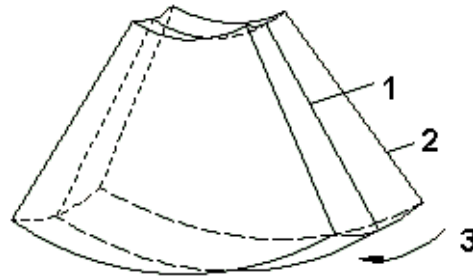

Figure 13-1. Volume Sweep

1. Central 2D scan
2. Start 2D scan
3. Range of VOI sweep

When you initiate a volume sweep, you can adjust the angle of the volume.

## What is Interactive 3D Rendering?

Interactive 3D rendering allows you to visualize certain structures and to view and analyze different sections of the volume.

## Region of Interest (ROI) / Render Box

The Region of Interest (ROI) - also referred to as the Render Box in rendering - contains the section of the volume you want to render. Therefore, objects that are not inside of the box are not included in the render process and are cut out (this is important in surface mode to allow a free line of sight). This may or might not be the entire Volume of Interest (VOI).

You can adjust the view direction of the ROI.

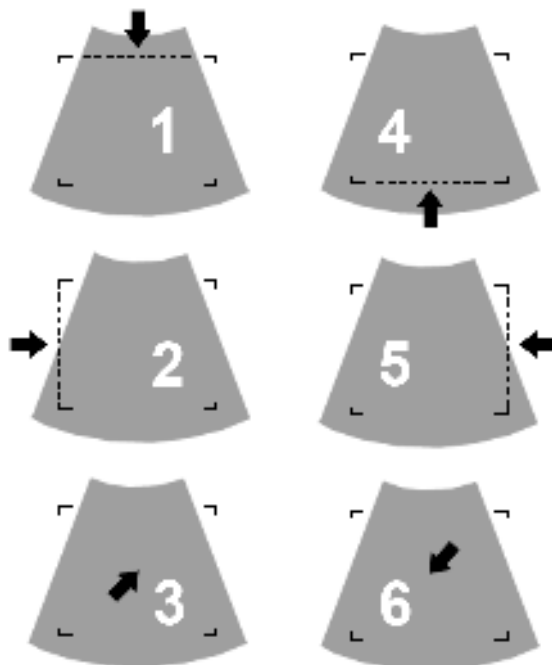

Figure 13-2. Render View Directions

- |               |               |
|---------------|---------------|
| 1. Up/Down    | 4. Down/Up    |
| 2. Left/Right | 5. Right/Left |
| 3. Front/Back | 6. Back/Front |

## Render View

In Render view, only the rendered image displays - no reference images.

## Image Orientation

Orientation of Image in Sectional view

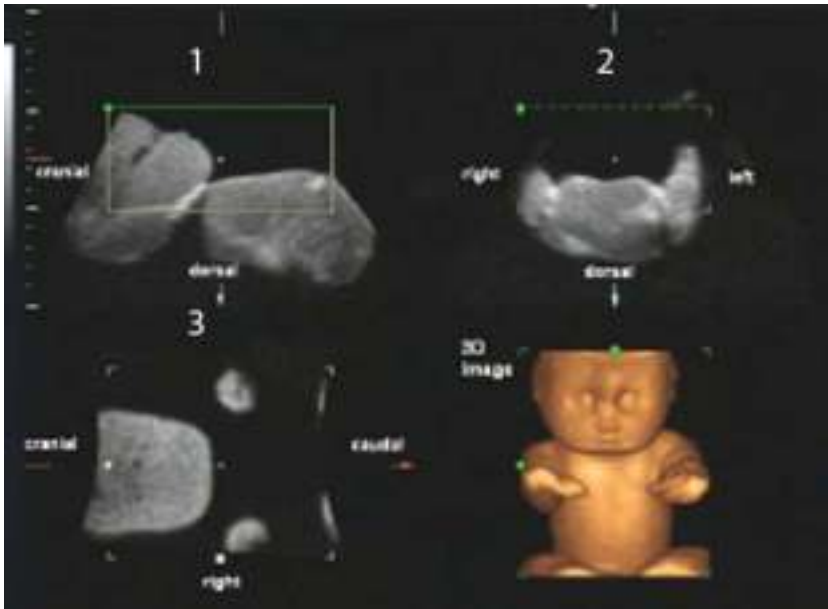

Figure 13-3. Quad Render Visualization Mode

1. Longitudinal
2. Transverse
3. Coronal

## Principle of Sectional Planes

Sectional planes represent three different planes of the same 3D volume. There are three separate planes, A (Longitudinal), B, (Transverse) and C (Coronal).

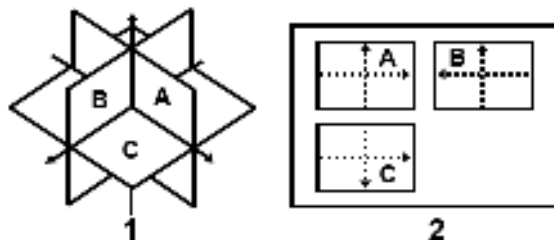

Figure 13-4. Illustration of Sectional Planes

The presentation of three orthogonal sectional planes is different from the conventional patient orientation in 2D sonography.

**NOTE:** *Whenever you select the usual, longitudinal section of the patient to display in field A, the conventional orientation for longitudinal and transverse sections is valid.*



## Reference Images

Reference images are the individual image displays within the corresponding sectional plane. Reference image A represents the longitudinal view; reference image B the transverse view, and reference image C represents the coronal view.

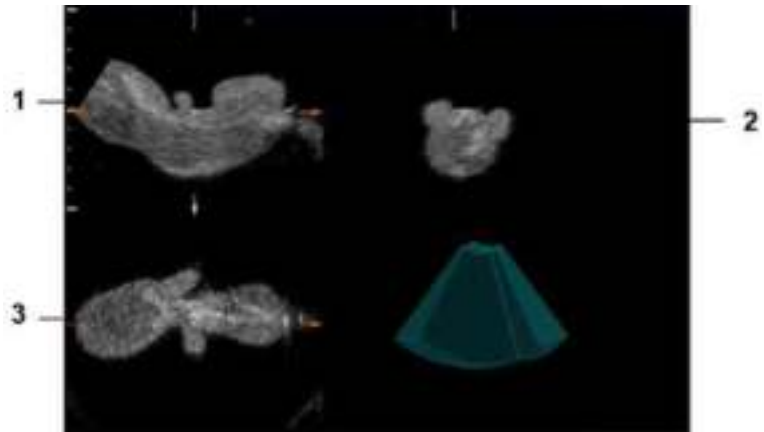

Figure 13-5. Monitor Display of Reference Images in Sectional View

1. Reference Image A (Longitudinal)
2. Reference Image B (Transverse)
3. Reference Image C (Coronal)

**Orientation Help.** When you view a 4D image on the display, it's sometimes difficult to recognize the orientation. To help, the system displays a three-dimensional drawing to illustrate the orientation. This drawing displays **ONLY** in sectional view.

Reference Images (continued)

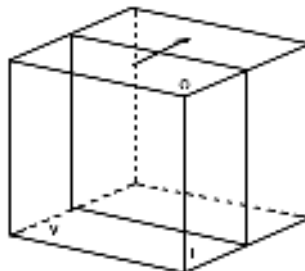

Figure 13-6. Reference Image A

For Reference image A, the transducer plane migrates from the FRONT to the REAR through the volume body.

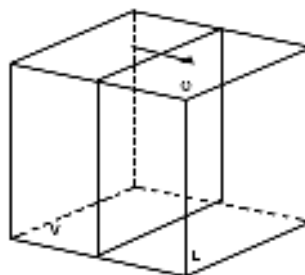

Figure 13-7. Reference Image B

For Reference image B, the transducer plane migrates from the LEFT to the RIGHT through the volume body.

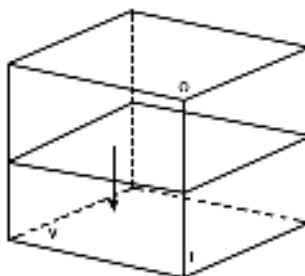

Figure 13-8. Reference Image C

For Reference image C, the transducer plane migrates from the TOP to the BOTTOM through the volume body.

## Reference Images (continued)

### Examples of Probe Orientation with Reference Planes

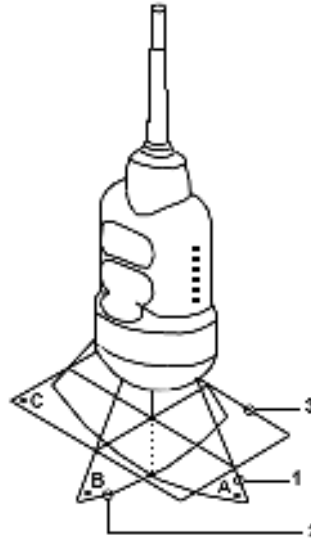

Figure 13-9. Abdominal Probe Orientation

1. Image Plane A
2. image Plane B
3. Image Plane C

**Reference Images (continued)**

**Examples of Probe Orientation with Reference Planes**

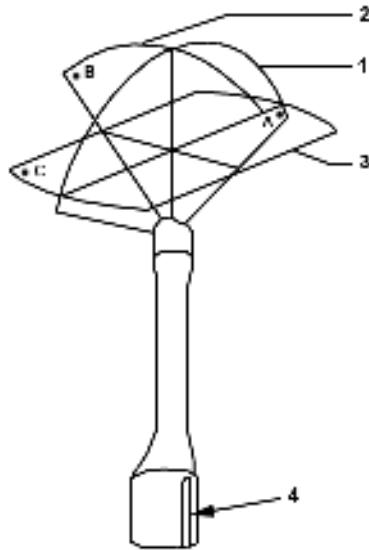

Figure 13-10. Endocavity Probe Orientation

1. Image Plane A
2. Image Plane B
3. Image Plane C
4. Groove

## 4D Operational Controls

### Control Panel Overview

When you enter 3D/4D mode, the behavior of some of the Control Panel buttons changes. For example, in 3D/4D mode, you use the PW-Mode, CF-Mode, M-Mode buttons (along with Depth) to manipulate the Volume of Interest (VOI).

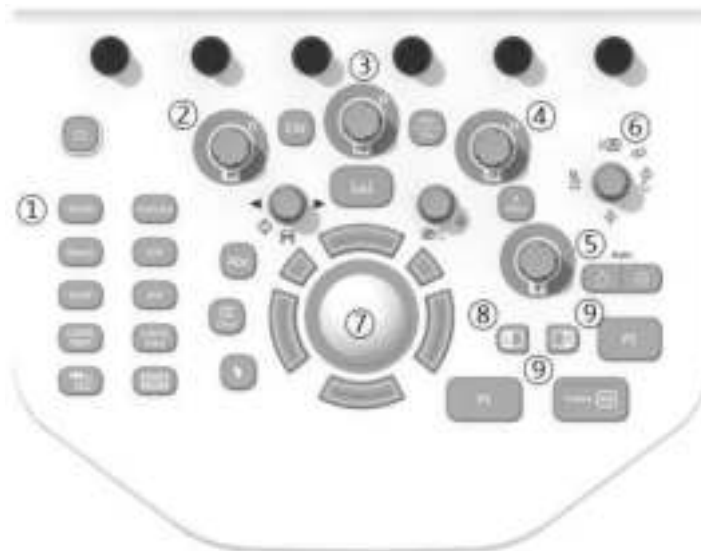

Figure 13-11. Control Panel Buttons

1. User-configurable controls.
2. M key, M-Mode key used to rotate about the X axis.
3. PW key, PW-Mode key used to rotate about the Y axis.
4. CF Key, CF-Mode key used to rotate about the Z axis.
5. Depth key, used as a transverse translation through the image.
6. Width key, used to adjust the size and position of the VOI.
7. Trackball, used to move the VOI. Also, the 4 keys surrounding the Trackball map to additional functionality, as shown on the monitor display.
8. L (left) key, used to begin a 4D acquisition.
9. Freeze or R (right) key, used to freeze a 4D image.

### **4D Monitor Display**

Imaging parameters are displayed in the upper right-hand portion of the display. The 4D specific parameters are Quality (Q), Volume Angle (A) and Volume Rate (VR). The Status Bar contains instructions on the tasks you can perform at each stage of the 4D imaging process. Remember to take a look at the Status Bar as needed.

## 4D Touch Panel Overview

The following is the first Touch Panel that appears when you press **3D/4D**.

### Common 4D Touch Panel Controls

Most 4D Touch Panel screens contain some similar controls. Refer to the table below for descriptions of these controls. Controls that are unique to or that contain slightly different functionality are described in their respective sections.

Table 13-2: Common 4D Touch Panel Controls

Preset Parameter	Description
Tile	You can divide the display into 1, 2, or 4 windows for Render view (Render = On) and 1 or 4 windows for Sectional view (Render = Off).
Reset Curve	Resets the three-point curve to a straight line.
Direction	Adjusts the view direction of the ROI.
Visualization	Sectional, Render, VCI, or Tomographic Ultrasound Imaging (TUI). Render view displays one rendered image, or reference image(s) and rendered image.
Focus Position	Adjusts the focal position.
Volume Angle	Sets the range of the volume sweep.
Quality	Balances speed with line density. Max combines the highest density with the slowest speed; Low combines the lowest density with the highest speed.

### 4D Presets

#### Real-Time 4D/Static 3D Presets

1. When you enter 3D/4D mode, press the **Preset** tab.
2. Select one of the preset settings for data acquisition and display. Presets are defined in the preset file and differ by application.

Table 13-3: Common 4D Touch Panel Controls

Preset Parameter	Description
Save	Selections: Overwrite, Create New, Cancel. <b>Overwrite</b> . Overwrite the application preset file with the changes you just made. <b>Create New</b> . Create a new user application preset file based upon the current exam category and application. <b>Cancel</b> . Cancel without saving preset parameters.
Pre-defined Preset	Reloads the presets for the selected application.
User1, User2, User3, User4	Used to define new user presets for a given application.

#### Static 3D Presets

1. When you enter 3D/4D mode, press **Static 3D**, then the **Preset** tab.
2. Select one of the preset settings for data acquisition and display. Presets are defined in the preset file and differ by application.



## Performing a 4D Scan

### Visualizations

4D provides two types of views for displaying and working with images: Sectional, Render, and Tomographic Ultrasound Imaging (TUI).

#### Sectional View

Sectional view contains one display for each sectional plane.



Figure 13-12. Monitor Display in Sectional View

1. Sectional Image A
2. Sectional Image B
3. Sectional Image C

## Visualizations (continued)

### Render View

The LOGIQ Totus continuously displays the 4D rendered image.

*NOTE: When the tile selection is single, only the rendered 4D image appears. When the tile selection is quad, the sectional images are located in 3 quadrants with the rendered 4D image in the fourth.*

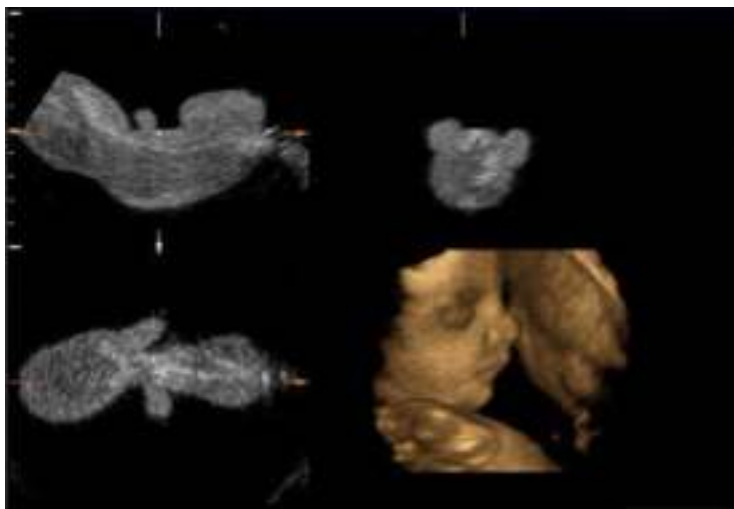

Figure 13-13. Quad Tile Render View

## Visualizations (continued)

### Orientation Help

When you view a 4D image on the display monitor, it's sometimes difficult to recognize the orientation. To help, the system displays a three-dimensional drawing to illustrate the orientation. This drawing displays ONLY in sectional view.

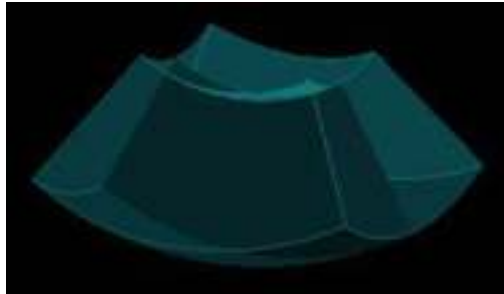

Figure 13-14. Orientation Help Graphic

### Acquiring and Rendering a 4D VOI

#### Starting with a 2D Image

To create a 4D image, you start with an optimized 2D image. The 2D image serves as the mid-line for the resulting 4D image.

1. Connect the appropriate 4D-compatible probe, leaving the probes in their respective holders. Follow the guidelines in Chapter 3 for connecting probes.

**NOTE:** *If the appropriate 4D probe is not connected, the original 3D Touch Panel appears.*

2. Obtain a 2D image. Optimize the image as usual.

#### Entering 3D/4D Mode

In 3D/4D mode, you choose the type of scan you want to perform: 4D or Static 3D.

1. Press **3D/4D** to enter 3D/4D mode. The first time you press 3D/4D, the system is in B Pre mode.

**NOTE:** *The location of the number of focal zones might change when you enter 3D/4D mode, since the number of zones is pre-determined by the default ROI.*

The default acquisition mode varies by application. If you are in OB, the default acquisition mode is Real-Time 4D; for all other applications, Static 3D is the default acquisition mode. When you enter pre-mode, an ROI graphic may appear on the monitor display that defines the initial ROI (Region of Interest) of the volume.



Figure 13-15. ROI Graphic

2. Press the **Preset** tab. Select one of the preset settings for data acquisition and display. Presets are defined in the preset file and differ by application.

## Quick Acquisition Steps

1. Connect the appropriate 4D-compatible probe, leaving the probes in their respective holders. Follow the guidelines in Chapter 3 for connecting probes.
2. Select a 4D probe from the probe indicator.
3. Obtain a 2D image. Optimize the image as usual.
4. Press **3D/4D**. An ROI graphic appears. 4D is selected.
5. Define the Volume of Interest (VOI) to be scanned. Use the **Trackball** to move the VOI and the **Width** button to re-size and re-position the VOI. Only the area defined within the VOI is rendered.
6. Adjust the volume angle and quality. This defines the range of the volume sweep. A small sweep angle results in a lower number of slices with a high volume rate.
7. To begin 4D acquisition, press the **L** key.

You DO NOT have to hold the probe steady during data acquisition.

During data acquisition, you can manipulate the VOI to see different views of the image. To rotate the VOI left or right, use the **PW** control. To rotate the VOI forward or backward, use the **CF** control. To rotate the VOI in a circular motion, use the **M** control.

To return to 3D/4D pre-mode, press **L**.

**NOTE:**

*If the volume size is too large, the message "Volume Size Too Big - Quality Degraded" displays in the status bar. The system changes the quality automatically to below the upper limit and displays the proper Quality value in the information window.*

8. Set Render to On.
9. To complete the acquisition, press **Freeze** or **R**.
10. Store the image.

### 4D

4D provides continuous, high volume acquisition of 3D images. You can apply rendering techniques to smooth out the appearance of an anatomical structure, for example, a baby face.

4D imaging contains two main viewing modes: Sectional, Render, and Tomographic Ultrasound Imaging (TUI). Sectional mode displays three separate representations of the image: Longitudinal (original 2D image), Transverse (elevational), and Coronal (horizontal). Render mode displays one rendered 4D image.

#### Acquiring a 4D Volume of Interest (VOI)

Once you have acquired an optimized 2D image, you can perform a 4D scan to acquire the 4D image.

During 4D image acquisition:

- Frame Averaging is disabled.
- You cannot change the transmit frequency.

To acquire a 4D VOI:

1. Press **4D**.
2. Make sure the VOI is defined appropriately. If necessary, adjust the volume angle. This defines the range of the volume sweep. A small sweep angle results in a lower number of slices with a higher volume rate.  
See *Manipulating the Volume of Interest (VOI)* for more information.
3. To begin 4D acquisition, press the **L** key. The system will perform continuous sweeps across the VOI. You do not have to hold the probe steady during a 4D scan.  
To return to 4D pre-mode, press **L**.
4. Set the Render to On.

## Sectional VOI Acquisition

Sectional view provides three separate views of the same image: Longitudinal (original image), Transverse (elevational), and Coronal (horizontal).

1. In the 4D tab, Render defaults to On (Render mode). Change Render to Off for Sectional view.
2. To select a reference image, use the Ref Image control on the Touch Panel. The reference image selected contains the focus for control panel keys, allowing you to manipulate or optimize that image.

Table 13-4: 4D Data Acquisition Parameters

4D Parameter	Description
Restore View	Resets all parameters back to the original values or chosen presets.
Tile	Selections: Single, Quad. You can divide the display into 1 or 4 windows.
Visualization	Sectional, Render, or Tomographic Ultrasound Imaging (TUI). Render view displays one rendered image, or reference image(s) and rendered image.
Ref Image	Use to select the reference image that has focus for use with the control panel keys and <b>Trackball</b> .
Orientation Help	Displays a three-dimensional drawing to illustrate the orientation. Only displays in sectional view.
Volume Angle	Sets the range of the volume sweep.
B Quality	Selections: Max, Hi2, Hi1, Mid2, Mid1, Low. Used to balance speed with line density. Max combines the highest density with the slowest speed. Low combines the lowest density with the highest speed. BQ displays on the display.

### Render VOI Acquisition

Rendering allows you to distinguish subtle anatomical detail. You can render all areas of an VOI, or just certain regions of the VOI. The region you define for rendering is referred to as the Render Box.

1. Define the area you want to render. For example, if you have an image of an entire fetus, you might only want the fetal face to be rendered. Therefore, you would define the fetal face as the VOI.
2. Set Render to On.

Table 13-5: 4D Data Acquisition Parameters - Render Mode

4D Parameter	Description
Restore View	Select to reset all parameters back to the original values or chosen presets.
Tile	Selections: Single, Dual, Quad. You can divide the display into 1, 2, or 4 windows.
Visualization	Sectional, Render, or Tomographic Ultrasound Imaging (TUI). Render view displays one rendered image, or reference image(s) and rendered image.
3D Orient	When selected, changes the orientation of the image on the monitor display. Selections include: 0 degrees, 90 degrees, 180 degrees, and 270 degrees.
Ref Image	Use to select the reference image that has focus for use with the control panel keys and <b>Trackball</b> . This control is enabled only if Tile is set to Quad.
Volume Angle	Sets the range of the volume sweep.
Quality	Selections: Max, Hi2, Hi1, Mid2, Mid1, Low. Used to balance speed with line density. Max combines the highest density with the slowest speed. Low combines the lowest density with the highest speed.
Activate Curve	Define a three-point curved surface for the render window using the Trackball.
Reset Curve	Reset the three-point curve to a straight line.
Mix	Selections: 0-100% in increments of 2. Allows you to mix a Rend Mode 1 mode with a Rend Mode 2 mode. Always select two modes.
Lower Threshold	Selections: 0-255. Sets a lower threshold below which weaker echoes are removed.



**Render VOI Acquisition (continued)**

1. Select the **Render Setting** tab.

The Render Setting tab allows you select and combine gray-scale and color rendering modes.

**HINTS**

If you are using Surface modes, we recommend that you adjust the Lower Threshold to recognize border structures more clearly.

Table 13-6: 4D (Data Acquisition) Render Parameters

4D Parameter	Description
Direction	The ROI determines the region that is rendered during 4D acquisition. You can change the direction in which this ROI is viewed. Selections: <b>Up/Down, Down Up, Left/Right, Right/Left, Front/Back, Back/Front.</b>
Gray Map	Displays the gray map selections on the display monitor. Select maps using the <b>Trackball.</b>
Colorize	Displays the tint map selections on the display monitor. Select maps using the <b>Trackball.</b>
Render Mode	Select Gray or Inversion. If you select Inversion, inverts the gray values of the rendered image (e.g., image information that was black becomes white and vice versa).
Render 1	Allows you to combine render mode values from render mode 1. Select the render map combination from the upper-left portion of the monitor display. Select map combinations using the <b>Trackball.</b> Render Mode 1 Selections: Surface Smooth, Surface Texture, Transp Max, Transp X-ray, Transp Min, HDlive Texture. <b>Surface Smooth</b> - Surface displays in a smoothed texture mode, which means that the gray values of the surface are identical with the gray values of the original 2D scan. <b>Surface Texture</b> - Surface displays in texture mode, which means that the gray values of the surface are identical with the gray values of the original 2D scan. <b>Transp Max.</b> - Displays the maximum intensity of gray values in the ROI. This is helpful for viewing bony structures. <b>Transp X-Ray</b> - Displays the mean value of all gray values in the ROI. <b>Trans Min.</b> - Displays the minimum number of gray values in the ROI. This is helpful for viewing vessels and hollow structures. <b>HDlive Texture</b> - Uses an illumination source that can be positioned by the user around the rendered 3D object on a spherical coordinate. By highlighting structures from the side, the three-dimensional impression can be improved considerably.

Table 13-6: 4D (Data Acquisition) Render Parameters (Continued)

4D Parameter	Description
Render 2	<p>Allows you to combine render mode values from render mode 2.            Render Mode 2 Selections: Surface Smooth, Light, Gradient Light, Transp Max, Transp X-ray, Transp. Min., HDlive Smooth.</p> <p><b>Surface Smooth</b> - Surface displays in a smoothed texture mode, which means that the gray values of the surface are identical with the gray values of the original 2D scan. <b>Light</b> - Surface displays in light mode. Structures in the near field are brighter; structures in the far field are darker. <b>Gradient Light</b> - Surface displays as if it is illuminated from a spot light source. This is helpful if the displayed surface is surrounded by hypoechoic structures (for example, liquids). <b>Transp Max.</b> - Displays the maximum intensity of gray values in the ROI. This is helpful for viewing bony structures. <b>Transp X-ray</b> - Displays the mean value of all gray values in the ROI. <b>Transp Min.</b> - Displays the minimum number of gray values in the ROI. This is helpful for viewing vessels and hollow structures. <b>HDLive Smooth</b> - Smoothed HDlive texture mode. When Render 1 value is set to HDlive Texture, the only available mode for Render 2 is HDlive Smooth. Note: HDlive rendering is not available if VCI is active.</p>
Edit Light	<p>Activates the light editor for the virtual light source in HDlive render mode. User can position the light source by moving the Trackball, A light icon on the main display indicates the direction of the light. Note: The <b>Edit Light</b> parameter is only available for the HDlive rendering modes.</p>
Transparency	<p>Selections: 20 to 250. Sets the transparency of the image. The higher the number, the more transparent the gray scale information.</p>

## Manipulating the Volume of Interest (VOI)

Imagine you are able to manipulate the 4D volume of interest (VOI) in your hand. The 3D/4D ROI is a tangible anatomical object that you can see and manipulate easily using the **Trackball** and other control panel keys.

If the monitor display is in Sectional view, select the desired reference image before you manipulate the image.

*NOTE: The manipulation examples are with A set as the reference image.*

### Rotating the 4D VOI Left/Right or Forward/Backward

You can rotate the VOI around the X, Y, and Z axes. To rotate the VOI around the Z axis, turn the **CF** control left/right.

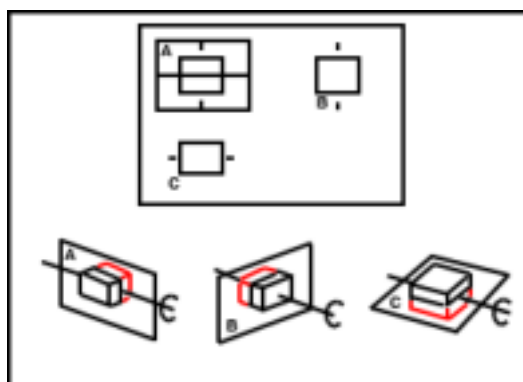

Figure 13-16. Rotate about Z Axis with CF Control

## Manipulating the Volume of Interest (VOI) (continued)

To rotate the VOI around the Y axis, turn the **PW** left/right.

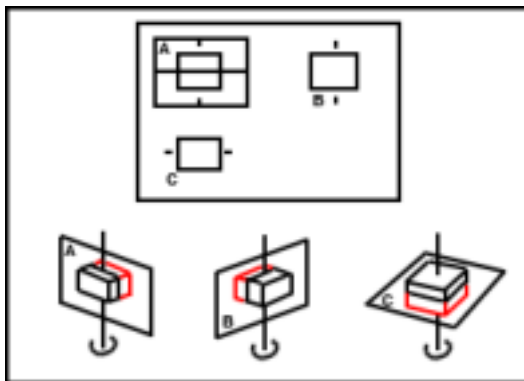

Figure 13-17. Rotate about Y Axis with PW Control

### Rotating the 4D Image in a Circular Motion

To rotate the VOI around the X axis, turn the **M** control left/right.

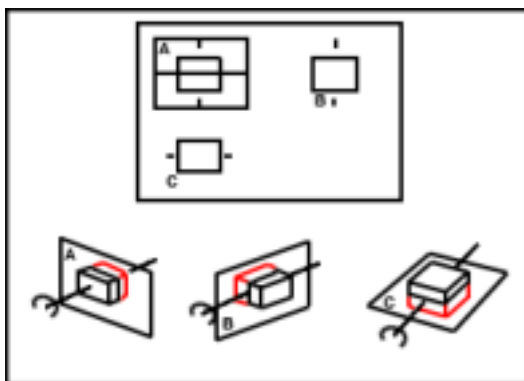

Figure 13-18. Rotate about X Axis with M Control

**NOTE:** To speed up the rotation, press the **PW**, **CF**, or **M** controls before you turn them. To slow down the rotation, press **PW** or **CF** again.

---

## Manipulating the Volume of Interest (VOI) (continued)

### Moving through the VOI

To move through the image to view a particular slice, press **Depth**.

This allows a displacement of the center of rotation along the intersection lines of the sectional planes A, B, and C. The displacement of the center of rotation leads to the display of parallel sectional images. See 'Reference Images' on *page 13-9 for more information*.

### Zooming the Image

Rotate **Zoom** to zoom on the image.

### Moving the VOI Position

To move the position of the VOI, move the **Trackball** left, right, up and down, as needed.

### Resizing the VOI

To re-size the VOI, use the **Width** control panel button. See the Width section in this chapter.

## Stopping 4D Image Acquisition

To stop acquiring a 4D image, press **Freeze** or R if you are in Render view or just **Freeze** if you are in Sectional view.

## 4D VOI Post-Processing

When you press **Freeze** or **R**, one of the following Touch Panel displays, depending on whether you are in Render view or Sectional view.

### Volume CINE

The system constantly stores CINE images so you can play back and review those images. CINE is useful for focusing on images during the specific part of the heart cycle or to view short segments of a scan session.

To activate CINE in 4D:

1. Press **Freeze**.
2. Select the **VolCine** tab.

Table 13-7: 4D Cine Parameters

Preset Parameter	Description
Loop Mode	Selections include: One Way, BiDirectional (two-way). <b>One Way</b> - plays one loop sequence forward. <b>BiDirectional</b> - plays the sequence forward and backward.
First	Displays the first volume in the CINE loop.
Last	Displays the last volume in the CINE loop.
Run/Stop	Starts and stops the CINE loop.
Loop Speed	Adjusts the CINE loop speed.
Volume by Volume	Used to select an individual volume in the CINE loop.

3. If you were in Render visualization mode when you entered 4D CINE mode; press **L** to return to Pre-Mode.  
If you were in Sectional visualization mode when you entered 4D CINE mode; press **L** to return to Pre-Mode.
4. To re-start real-time 4D acquisition, press **Freeze**.

## Static 3D

You can create a single sweep, single volume static 3D image.

### Performing a Static 3D Scan

1. Connect the appropriate 4D-compatible probe, leaving the probes in their respective holders. Follow the guidelines in Chapter 3 for connecting probes.
2. Select a 4D probe from the probe indicator.
3. Obtain a 2D image. Optimize the image as usual.
4. Press **3D/4D**.
5. Press **Static 3D**. Set Visualization to Render.
6. Set the Volume of Interest (VOI) to be rendered. Use the **Trackball** to move the VOI and **Width** to re-size the ROI.
7. Adjust the volume angle. This defines the range of the volume sweep. A small sweep angle results in a lower number of slices with a high volume rate.
8. Set the probe down on the patient, making sure the probe is held steady. Press the **L** key to start acquisition.

**NOTE:** *During 3D acquisition, no control panel keys are not available, except for 'R.'*

**NOTE:** *When the 3D acquisition begins, the Touch Panel appears blank for a brief moment.*

9. Hold the probe steady until the system stops automatically. You will know the acquisition has stopped when the **Touch Panel** changes to display the Render Setting, 3D Rotational Cine, and Scalpel tabs.  
To stop the acquisition manually, press the **R** key.
10. Save the image.
11. To further manipulate the 3D image, press **Static 3D**.

The Touch Panel that displays depends on the visualization mode selected prior to freeze, Sectional, Render, TUI or VCI.

### Static 3D Sectional View

Table 13-8: 3D After Acquisition Parameters - Sectional View

Preset Parameter	Description
Orientation Help	Displays a 3-dimensional drawing to illustrate the orientation. Only displays in sectional view.

### Static 3D Render View

Table 13-9: 3D After Acquisition Parameters - Render View - Page 1

Preset Parameter	Description
Edit/Accept ROI	Selections include Edit, Accept. <b>Edit</b> - Select to adjust the size of the Region of Interest (ROI). <b>Accept</b> - accepts the active 3D image.
3D Orient	When selected, changes the orientation of the image on the monitor display. Selections include: 0 degrees, 90 degrees, 180 degrees, and 270 degrees.

### VCI

#### Introduction

VCI (Volume Contrast Imaging) allows you to sweep smaller slices of data with a higher volume rate. The resulting image shows an average, integrated gray value of the tissue contained within the ROI. VCI improves the contrast resolution and signal/noise ratio. It also reduces image speckle. This may facilitate finding diffuse lesions in organs.

#### Touch Panel

The data is represented as in Static 3D - Sectional Planes. However, the three planes are VCI renderings (tissue information of a thick slice) computed from the 3D dataset.

Table 13-10: VCI View

Preset Parameter	Description
Slice Thickness	Select the slice thickness



## Static 3D Color

To view Static 3D Color,

1. Acquire the anatomy you want to view in B-Mode.
2. Activate Color Flow or PDI.
3. Activate 3D/4D. The Pre-3D displays. Select the desired Visualization.

*NOTE:* 4D cannot be selected from Pre-Mode with Color active.

4. Press 'L' to render the image.

The color is rendered. You can adjust the Render Mode (default is Glass Body):

- **Gray.** Gray, no color.

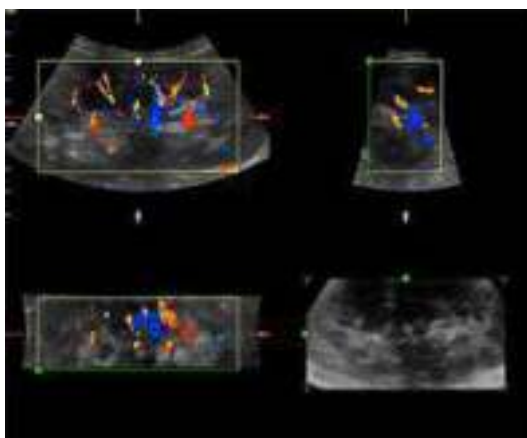

Figure 13-19. 3D Color - Gray

- **Inversion.** Inverts the grayscale.

### Static 3D Color (continued)

- **Color.** Displays Color-Flow.  
Select the rendering method ([Rend Color1] (Surface only) or [Rend Color2]) and the mixing ratio.

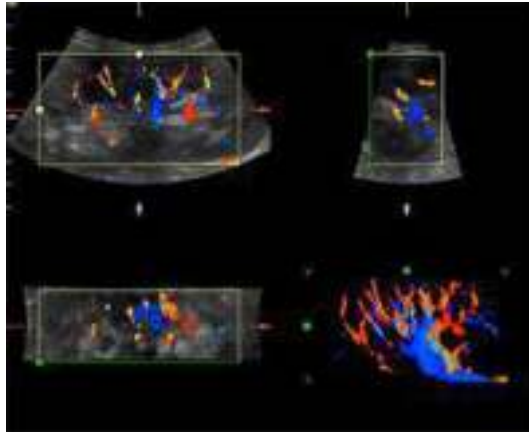

Figure 13-20. 3D Color - Color

- **Glass Body.** Displays both Color-Flow and B-Mode.  
Select the rendering method ([Rend Gray] or [Rend Color]) and the mixing ratio.

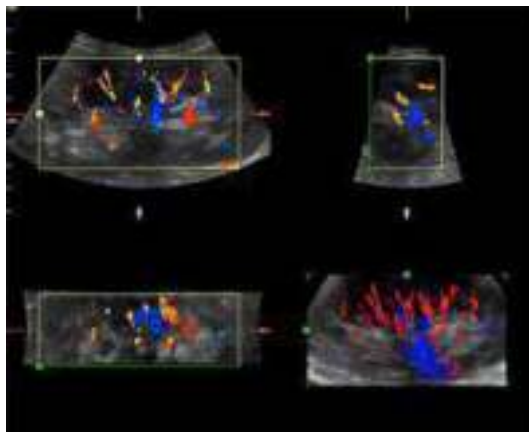

Figure 13-21. 3D Color - Glass Body

To hide the color on the sectional planes, select **Color Off** from the Touch Panel.

**NOTE:** *If you scan in Render mode and select Tile as Quad, you can hide the color with the Color Off Touch Panel key.*

## Volume Review

You can post process VOI (the entire volume of interest) and scroll through acquisition planes via Volume Review. This allows you to review all of the frames within this volume set.

In Volume Review, start in Run/Stop so that every frame in the volume is displayed.

**NOTE:** *If you adjust the screen while in Volume Review, these changes ARE NOT reflected on the Static 3D volume.*

## Scalpel

Scalpel allows you to edit/cut sections of a 3D image. Scalpel is available only on a rendered image.

1. Press **Scalpel**.

Table 13-11: Scalpel Parameters

Preset Parameter	Description
Cut Mode	Selections: Inside Contour, Outside Contour, Inside Box, Outside Box, Eraser Big, Eraser Small. <b>Inside Contour, Outside Contour</b> - Allows you to trace the portion of the image you want to cut. Trace Outside removes all portions of the image that fall outside your traced region. Trace Inside removes all portions of the image that fall inside your traced region. <b>Inside Box, Outside Box</b> - Displays a box you can use to define the portion of the image you want to cut. Outside Box removes all portions of the image that fall outside the box. Inside Box removes all portions of the image that fall inside the box. <b>Eraser Big, Eraser Small</b> - Provides a big and small eraser tool you can use to define the portion of the image to cut by hand. Available only if Depth is Full.
Cut Depth	Selections: Full, Define. <b>Full</b> -The entire depth of the selected region will be cut. <b>Define</b> - Allows you to define the depth to cut using the Depth control panel knob.
Undo Last	Undoes the last cut only.
Redo	Select to redo scalpel.
Undo All	Undoes all cuts since you entered Scalpel mode.
Done	Applies to User Defined Cut Depth when complete.

### Scalpel (continued)

2. Select the cut mode.
3. Use the **Trackball** and **Set** key to define the portion of the image to cut. Press **Set** to start, move the **Trackball** to define the region, then press **Set** again to cut the image. The portion is removed.

To undo the last cut, select **Undo Last**.

To undo all cuts in the current session, select **Undo All**.

**NOTE:** *With the cut image displayed, if you attempt to switch to the Static 3D tab to edit the ROI, the following warning message appears: Scalpel changes will be lost. Do you want to continue? [Yes/No].*

### 3D Rotation CINE

3D Rotation CINE allows you to view the 3D image from various angles.

To activate rotation CINE in 3D:

1. Press **Freeze**.
2. Select the 3DRot Cine tab.

Table 13-12: 3D Rotation Cine Parameters

Preset Parameter	Description
Rotational Angle	Sets the rotational angle of the 3D image over which the CINE loop is played. Typical values are 30, 45, 60, 90, 180 and 360 degrees.
Step Angle	Sets the step angle between individual frames in the CINE loop.
Rotation Axis	Sets the axis about which the CINE loop is calculated. Selections X and Y.
Loop Mode	Selections include: One Way, BiDirectional (two-way). <b>One Way</b> - plays one loop sequence forward. <b>BiDirectional</b> - plays the sequence forward and backward.
First	Displays the first volume in the CINE.
Last	Displays the last volume in the CINE.
Run/Stop	Starts and stops the CINE sequence.
Start Angle	Used to select the starting angle in the CINE loop range. The default Start Image is calculated from the rotational angle as: $-1 \times \text{Rotational angle} / 2$ . If you adjust the Start Image, the Rotational Angle is re-set to be the value of the adjusted Start Image.
End Angle	Used to select the ending angle in the CINE loop range. The default End Image is calculated from the rotational angle as: $\text{Rotational angle} / 2$ . If you adjust the End Image, the Rotational Angle is re-set to be the value of the adjusted End Image.
Image by Image	Used to select an individual image in the CINE loop.

**VOCAL**

You use VOCAL (Virtual Organ Computer-aided Analysis) to visualize and calculate the volume of anatomical structures, such as a tumor lesion, cysts, and the prostate. VOCAL is available after a Static 3D or Real-Time 4D acquisition.

1. Press **Vocal**. Specify the volume calculation method (**Manual**, **Contour Detect**, **SemiAuto Detect**, or **Sphere**). Select the reference image you want to use to perform the trace by selecting **Ref Image** A, B, or C. Press **Start**.
2. Trace the anatomy using the **Trackball**. Press **Set** to start and end the trace. You must go across the dotted line for the trace to take effect (it turns yellow). The trace is performed on each image slice, separated by the rotational step angle. Rotate the **Rot. Ref** dial until you have completed the total of the required rotations (for example, if you've selected 30 degrees, you need to complete six traces if you've selected Manual). After you've completed the trace target, the **Calc Volume** button is active for you to press. The calculated VOCAL image appears in the lower, right-hand corner of the display. You are now in the edit state.

*NOTE: Trace not used for Sphere. For Sphere, set the Poles.*

3. Edit as necessary. You can apply a shell, adjust its thickness, navigate through the reference angles, or restart the VOCAL.

VOCAL Touch Panel states are described in the following tables.

Table 13-13: VOCAL Parameters on Setup Touch Panel

Parameter	Description
Manual	When you select the Manual method, you need to perform a manual trace on each of the rotation angles.
Contour Detect	When you select the Contour Detect method, you need to perform a manual trace on each of the rotation angles.
SemiAuto Detect	When you select the Semi Automatic Detect method, you need to perform a trace on only two rotation angles. The system applies an algorithm to define the traces.
Structure	Structure is only available with the SemiAuto Detect method. Select Hypo, Cystic, or Hyper/Iso.
Sphere	Calculates the volume based on the pole settings.
Pole 1	Adjust the upper contour point (green arrow) of the structure.
Pole 2	Adjust the lower contour point (green arrow) of the structure.

Table 13-13: VOCAL Parameters on Setup Touch Panel (Continued)

Parameter	Description
Rotational Step Angle	Specify the angular spacing between contour traces. Typical values are 6, 9, 15, and 30 degrees. The number of planes varies by this formula: 180 degrees / selected rotational step angle.
Ref Image	Use this to select the image you want to use to perform the trace.
Start	Press Start when you're ready to perform the trace.
Rot.Ref ### Back/Next	Select Next/Back to move to the next image for contour definition in the rotation step.

Table 13-14: VOCAL Calculate Volume Touch Panel

Parameter	Description
Calc Volume	Press Calc Volume to initiate the VOCAL image calculation.
Clear	Press Clear to remove the trace from the image.
Restart Vocal	Press Restart Vocal to return to the initial VOCAL state.

The Shell Modes allows you to construct a shell or contour “around” the structure of interest, which enables you to distinguish between the contour of the targeted structure and the contours the inside and outside of the structure.

Table 13-15: VOCAL Parameters on Edit Touch Panel

Parameter	Description
Shell Off	Select Shell Off if you do not want a shell around the VOCAL image.
Inside	Select Inside if you want a shell inside the volume.
Outside	Select Outside if you want a shell outside the volume.
Symmetric	Select Symmetric if you want half of the shell thickness inside and half outside the volume's perimeter.
Shell Thickness	Adjust to vary the thickness of the shell.

### Static 3D Render Setting

Table 13-16: 3D After Acquisition Parameters - Render View - Page 1

Preset Parameter	Description
Edit/Accept ROI	Selections include Edit, Accept. <b>Edit</b> - Select to adjust the size of the Region of Interest (ROI). <b>Accept</b> - accepts the active 3D image.
3D Orient	When selected, changes the orientation of the image on the monitor display. Selections include: 0 degrees, 90 degrees, 180 degrees, and 270 degrees.

### Static 3D Volume Review

You can post process VOI (the entire volume of interest) and scroll through acquisition planes via Volume Review. This allows you to review all of the frames within this volume set.

In Volume Review, start in Run/Stop so that every frame in the volume is displayed.

*NOTE: If you adjust the screen while in Volume Review, these changes ARE NOT reflected on the Static 3D volume.*

### Storing 4D Images

You store 4D images exactly as you would your 2D images. Because 4D images contain more data, they also require more space. Pay close attention to the size of the volumes.

- Still image: Store as Raw Data
- CINE: Store as Raw Data when “Enhanced DICOM” is selected for printing 4D.



## Tomographic Ultrasound Imaging (TUI)

Tomographic Ultrasound Imaging (TUI) is a visualization mode which presents data as parallel slices (planes) through the dataset. This method of visualization is consistent with CT and MRI. The distance between the different planes can be adjusted.

1. Select TUI as the Visualization mode.
2. Press 'L' to start acquisition.
3. If in 4D, press 'R' to end the acquisition. This step is not required in Static 3D.

The reference image + the number of specified slices appears. The reference image always displays and indicates which slices you are currently viewing as solid lines.

## Tomographic Ultrasound Imaging (TUI) (continued)

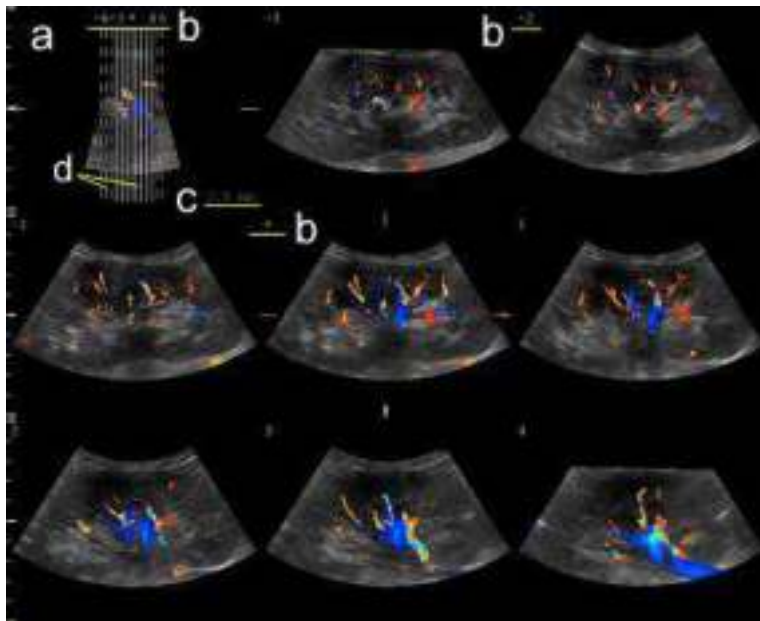

Figure 13-22. TUI 3x3 Example

- a. The TUI reference image that shows the slice position. This image is orthogonal to the reference image.
- b. The number and green asterisk shows the position of each slice. A green asterisk indicates the center image (A, B or C-plane).
- c. Slice distance displays when the slices are in certain intervals.
- d. A solid line indicates the slice appears on the monitor. A dotted line indicates the slice did not appear on the monitor.

**NOTE:** *TUI with Color is only available with Static 3D, not with 4D.*

---

## Tomographic Ultrasound Imaging (TUI) (continued)

4. Adjust the number of slices and slice distance.

You can adjust the number of slices by using the **Slices** rotary. You can adjust the distance between the slices using the **Slice Distance** rotary. Max value is 40mm.

- Move forward/backward through the slices via **Prev./Next Slice**.
- Change the center image via **Ref. Image** if needed (Reference image A, B or C).
- Select **Display Format** from 1X1, 1X2, 2X2 and 3X3.
- The following features are supported in TUI: Zoom, Rotation (X/Y/Z), Trackball (Move the position), Translation and Gain.
- To hide the color, select **Color Off** from the Touch Panel.

## Tomographic Ultrasound Imaging (TUI) (continued)

You can adjust each slice position with **Adjust Slices**.

1. Press **Adjust Slices** on the Touch Panel.
2. The pointer displays. Select a slice by using the **Trackball**.

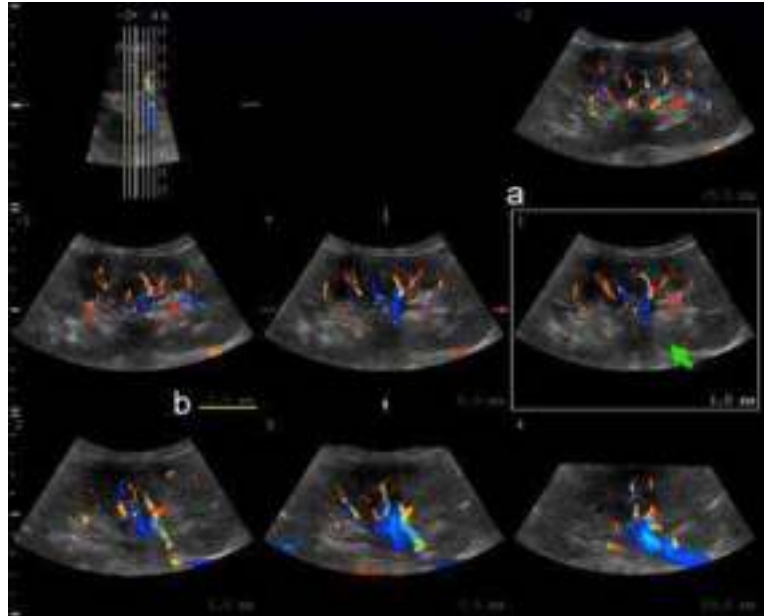

Figure 13-23. Adjust Slice screen (example)

- a. Selected slice displays with yellow border
  - b. Distance from the center image
- Adjust the slice distance from the reference image by using **Slice Position**. Slice Position only affects the selected slice.

**NOTE:**

*If you place the pointer on the reference image and rotate **Slice Position**, the position of the reference image and all slices are moved.*

- Adjust the number of right and left slices off the center image by using **Left Slices** or **Right Slices**.
3. After the adjustment is finished, press **Set**. The slice is marked with an "X". To print this slice, press a print key.

## SonoRenderlive

SonoRenderlive helps to find the render start position to easily separate solid tissue in front of the render object.

The SonoRenderlive algorithm “looks” for the transition from solid to liquid tissue and positions the “Render Start” into the liquid area visualized by the green render start line. The render start line is not a straight line but a “free” trace for optimal adaptation to the render object.

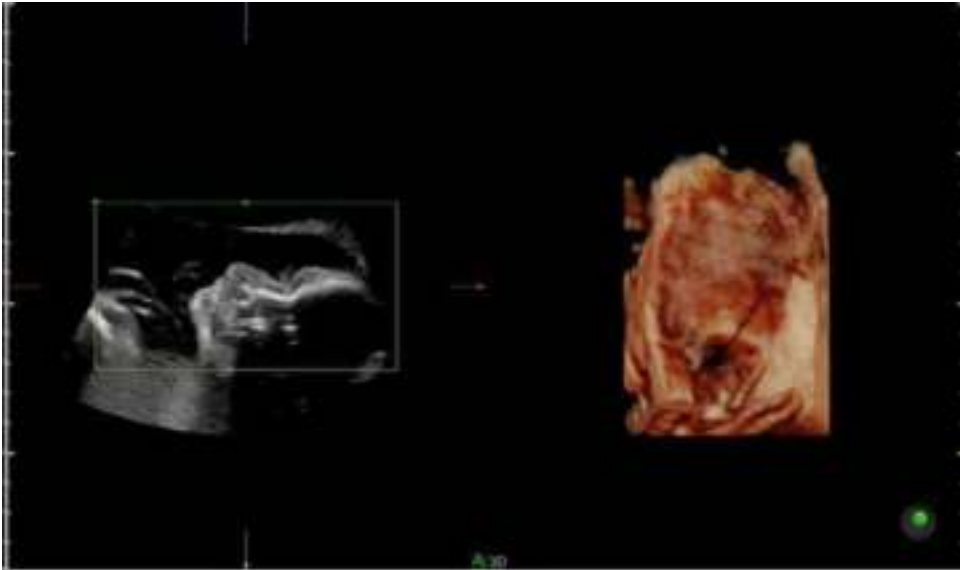

Figure 13-24. Screen Display Off

## SonoRenderlive (continued)



Figure 13-25. Screen Display On

### Using SonoRenderlive

1. Start the Render Visualization Mode.
2. Press the **SonoRenderlive** Rotary control.
3. To adjust the distance between the render start position and the render object, rotate the **Sensitivity** control below the Touch Panel. A high value indicates a smaller distance.

*NOTE: If SonoRenderlive is not used, the Render Start line can also be modified manually. Press the trackball button Curve to activate Curved Render Start and move the trackball to modify the line.*

## **OmniView**

OmniView provides an arbitrary cross-sectional plane, as opposed to a strict coronal plane. In VCI OmniView, the rendering box is very thin so you can visualize the tissue information of a thick slice. The resulting image shows the average (integrated) gray value of the tissue contained within the narrow box.

VCI OmniView improves the contrast resolution and the signal/noise ratio and therefore facilitates the detection of diffuse lesions in organs. The result is an image with no speckle pattern and a highly improved tissue contrast.

- 4D Real Time
- 3D Static
- STIC

### OmniView Workflow

1. Press **3D/4D**.
2. Select **OmniView**.
3. Adjust Volume Angle and B Quality as necessary.
4. Press the right **Set** key to start acquisition.  
The volume acquisition starts and the acquired images are displayed.
5. The cross cursor displays on the reference image.
6. Select the appropriate trace mode to display the sectional plane.
  - Line: Select the sectional image by using straight line.
  - Curve: Select the sectional image by using curved line.  
Move the cursor to the start point and press **Set**. Move the cursor to the end point and press **Set**. Use the **Trackball** to make a curved line and press **Set**.
  - Trace: Select the sectional image by using any arbitrary curve.
  - Polyline: Select the sectional image by using a continuous line composed of one or more line segments. You can create a polyline by specifying the endpoints of each segment by press **Set**.



## OmniView Main Menu

Table 13-17: OmniView Parameters on Edit Touch Panel

Parameter	Description
View Icon	Show or hide the OmniView Icon.
View Line	Show or hide the OmniView Line.
VCI OmniView	Switch to VCI Omniview.
Trace Mode	Four tracking line methods are available.
Tile	Select a display format (Single, Dual, Quad)
Clear All	All existing lines are deleted and a new line entry is started.
Ref. OmniV	To activate OmniView Ref. Line view.
Ref. Image	Select the Reference image.
OmniV. Rot	Rotates the OmniView line.
Undo	To re-adjust the traced line.
Mix	Selections: 0-100% in increments of 2. Allows you to mix a Rend Mode 1 mode with a Rend Mode 2 mode. Always select two modes.
Slice Thickness	Select the slice thickness

## OmniView Control



Figure 13-26. OmniView Control

Table 13-18: OmniView Parameters on Line Edit Mode: New

Parameter	Description
Img.	Activate the image.
Redo	Restart the line.
OmniView	Activate OmniView Line
View#	Select the next OmniView image and line as 1, 2, or 3.
Next	Select to activate the next OmniView Ref. Line view.

## **STIC (Spatio-Temporal Image Correlation)**

### **Overview**

With this acquisition method the fetal heart or vascularity can be visualized. It is not a Real Time 4D technique, but a post processed 3D acquisition.

STIC is designed for beating (fetal heart) as well as blood perfused organs. Only STIC can synchronize structures that have a pulsation in Doppler mode, but no visible pulsation in B-Mode.

Data is acquired for a predefined period of time. The acquired images are post processed to calculate a Volume Cine sequence representing one complete heart cycle.

In order to achieve a good result, try to adjust the size of the volume box and the sweep angle to be as small as possible. The longer the acquisition time, the better the spatial resolution will be. The user must be sure that there is minimal movement of the participating persons (e.g., mother and fetus), and that the probe is held absolutely still throughout the acquisition period. Movement will cause a failure of the acquisition. If the user (trained operator) clearly recognizes a disturbance during the acquisition period, the acquisition has to be canceled.

A good STIC data set shows a regular and synchronous beating of the fetal heart or of an artery. Please make sure that the borders of the fetal heart or the artery are smooth and there are no sudden discontinuities. Always adopt a critical attitude to images created in STIC mode.

If the expected frame rate is too low (10Hz) for a good STIC quality, a warning is displayed in STIC mode.

After the STIC acquisition is finished the calculation process starts to calculate the volume cine sequence. If a result is detected by the system, the Volume cine sequence is shown in run mode and the STIC accept menu appears. As soon as the result is accepted the system releases the volume cine mode. If the result is not accepted but canceled, the system switches back to STIC pre mode.

### Overview (continued)

One or more of the following artefacts in the data set indicate a disturbance during acquisition:

- Sudden discontinuities in the reference image B: These are due to the motion of the mother, the fetus or fetal arrhythmia during acquisition.
- Sudden discontinuities in the color display: Motion of the mother, the fetus or fetal arrhythmia affects the color flow in the same way it affects the gray image.
- Fetal heart rate far too low or far too high: After acquisition the estimated fetal heart rate is displayed. If the value does not correspond to the estimations based on other diagnostic methods at all, the acquisition failed and has to be repeated.
- Asynchronous movement in different parts of the image: e.g., the left part of the image is contracting and the right part is expanding at the same time.
- The color does not fit the structures displayed in gray mode: The color is displayed above or below the actual vessel.
- Color “moves” through the image in a certain direction: This artefact is caused by a failure in detecting the heart rate due to low acquisition frame rate. Use higher acquisition frame rate for better result.

**NOTE:** *In all of the above cases the data set has to be discarded and the acquisition has to be repeated.*

When is it not allowed to perform the STIC fetal cardio acquisition?

- Severe fetal arrhythmia

Following STIC acquisition modes are available:

- STIC
- STIC CFM
- STIC PDI

## Performing STIC Scan

**NOTE:** *STIC can only be used in OB applications.*

1. Select a 4D probe from the probe indicator.
2. After obtaining a feasible 2D image of the fetal heart or an artery, press 3D/4D to activate the Volume mode.
3. Select **STIC**.
4. Set the Volume of Interest (VOI) to be rendered. Use the Trackball to move and resize the VOI.

**NOTE:** *Press top Trackball key to switch Pos and Size.*

5. Adjust the **Acquisition Time**.
6. Set the volume sweep angle by using **Volume Angle**.

**NOTE:** *In order to acquire a good result, try to adjust the ROI and the sweep angle to be as small as possible. The longer the acquisition time, the better the spatial resolution will be.*

7. Hold the probe still and ask the patient not to move.
8. Press the right **Set** key to start the acquisition.

**NOTE:** *When the STIC acquisition begins, the Stop Acquisition button appears. If the user recognizes a movement of the probe, fetus or the patient during the scan, press Stop acquisition to cancel the acquisition.*

9. Hold the probe steady until the system stops automatically. Estimated Fetal Heart Rate and Accept/Cancel buttons appears on the Touch Panel.
10. Press **Accept** if the fetal heart rate displayed on the Touch Panel is accepted. STIC image is displayed.

If the result is not accepted, select **Cancel**. The system switches back to STIC-pre mode.

**NOTE:** *If the user (trained operator) clearly recognizes a disturbance during the acquisition period, the acquisition has to be canceled.*

## Screen Layout

The yellow caution icon and the calculated heart rate are displayed as well.

**NOTE:** *Displayed Heart Rate indicates the heart rate [B/min] calculated from the delta time length per beat. A yellow caution icon indicates that the displayed heart rate is only an estimation. Do not diagnose based on this value.*



Figure 13-27. Screen Layout

## STIC Controls

Touch Panel/All hard key and trackball controls are the same as in 4D/Static 3D mode. Therefore only the STIC relevant controls are described here:

Table 13-19: STIC Pre-mode Touch Panel

Relevant controls	Description
Acq. Time	Only available in STIC. Acquisition time can be set.
Volume Angle	Adjusts the volume angle.

# Contrast Imaging

## Overview

**NOTE:** *The LOGIQ Totus is designed for compatibility with most commercially available Ultrasound contrast agents. Because the availability of these agents is subject to government regulation and approval, product features intended for use with these agents may not be commercially marketed nor made available before the contrast agent is cleared for use. Contrast-related product features are enabled only on systems for delivery to an authorized country or region of use.*



### WARNING

#### **Misdiagnosis based on image artifacts**

Misdiagnosis in ultrasound contrast images may be caused by several artifacts, most importantly:

**Motion artifacts:** Give rise to signals independent of contrast presence. This may be caused by patient movement (including respiration) or by probe movement influenced by the operator.

**Regional drop outs:** Caused by unintentional destruction of the contrast agent, too low concentration of contrast agent, poor acoustic penetration due to rib/lung shadows or the system failing to detect the contrast agent due to erroneous settings induced by the operator.

**Tissue harmonics:** Creates contrast-like signals independently of the presence of contrast agent.



### CAUTION

Cardiac rhythm disturbances during cardiac perfusion studies using gas ultrasound contrast agents have been observed in the diagnostic range of Mechanical Index (MI) values. See the specific package insert for the contrast agent being used for details.



### CAUTION

Read and follow contrast agent instructions provided by the manufacturer.



## Contrast Imaging Overview

By adjusting the acoustic output, you can enhance either contrast harmonics or stimulated acoustic emission (SAE).

See Chapter 11 for probe availability.

Coded Contrast Imaging utilizes three technologies: Amplitude Modulation (AM), Phase Inversion (PI), and Coded Harmonic Angio (CHA).

- Contrast: Amplitude Modulation and Phase Inversion (AM and PI) is included in the Contrast option.

Table 13-20: Available Contrast Display Settings

Label	Description	Clinical Use
Low MI B--Single Low MI B-Mode image display mode	Find the tumor before/after contrast agent injection	Tumor detection and characterization
Contrast Only—single contrast image display mode	Use contrast agent nonlinearity to detect contrast agent signal.	Tumor detection and characterization
Single View--Single Contrast enhanced image display with low MI B-Mode image data acquisition mode	Use contrast agent nonlinearity to detect contrast agent signal.	Tumor detection and characterization
Dual View—Real-time side-by-side dual image display with the right side contrast image and the left side B-Mode reference image	Use contrast agent nonlinearity to detect contrast agent signal.	Tumor detection and characterization

### Benefits

The contract imaging technique, facilitated by the use of a contrast agent, detects non-linear signals while suppressing linear signals from surround tissue. Blood containing the contrast agent stands out brightly against a dark background of normal tissue.

### Clinical Use

Possible clinical uses are to detect and characterize tumors of the liver, kidney, and pancreas and to enhance flow signals in the determination of stenosis or thrombus.

## Contrast Imaging Overview (continued)

<b>Affect on other controls</b>	<p>The default acoustic output adjusts for contrast imaging and the Power Output key provides more subtle gradations for use while in contrast imaging. When you exit Contrast Imaging, the system returns the acoustic output to its original setting. When you reactivate Contrast Imaging, the system enters the default Contrast Mode.</p> <p>Most system controls are available (Depth, Zoom, Colorize, etc.). However, some controls are not available (Anatomical M Mode, Rejection, and Suppression).</p> <p>Controls adjusted while in Contrast Imaging retain these values when you exit Contrast Imaging (except for post-processing controls).</p>
<b>Bioeffect</b>	<p>Activating Contrast Imaging may change the TI and/or MI. Observe the output display for possible effects.</p> <p>The <b>Power Output</b> key has been enhanced to provide more subtle gradations for use while contrast imaging. The Mechanical Index displays values less than 0.1. These values are displayed on CINE Loops and on archived images.</p>
<b>Feature Availability</b>	<p>3D and Volume Navigation are available; Multi Image and LOGIQView are not available.</p>
<b>Technique Availability by Probe</b>	<p>Use the table in Chapter 11 to determine which contrast technique is available by probe.</p>

## **Mode**

### **Reference Mode**

Reference (Ref) Mode is to image the anatomical reference, not the contrast enhancement.

### **Contrast Mode**

There are several contrast imaging techniques. Note that the appropriate imaging technique may vary by agent and application. In other words, the imaging technique is not dedicated for the agent and vice versa.

### **Contrast MVI Mode**

Contrast MVI uses MVI (Micro Vascular Imaging) in Contrast mode. The characteristics of MVI's higher sensitivity and higher spatial resolution can be used in Contrast Imaging.

In addition to the MVI features, Flash, Flash + Capture, Max Enhance, and Contrast Clock can be used.

The choice of AM, PI, CHA mode in Contrast is not in Contrast MVI.

Support probes: C1-6-D, C1-6VN-D, 9L-D, L3-12-D and ML6-15-D.

### Contrast Presets

You access the Contrast Imaging Presets via Utility -> Imaging -> Ref or Con tabs.

#### Target MI

##### Description

Target MI control provides automated adjustment of the acoustic output to keep a specified Target value to reduce an unexpected change in MI during a contrast exam.

Target MI control can be preset in the Utility -> Imaging -> CON and Ref.

*NOTE: The value of Target MI for Reference Image is adjustable on Ref tab, only when Ref-Only mode.*

##### Time Delay

To set the Trigger time delay, press the down arrow next to *Time Delay*.

##### Dual View

To set the default contrast mode, press the down arrow next to *Default Mode* on Con tab to select the mode.

##### Additional Presets

To adjust other Contrast Imaging presets (Map, Frame Average, etc.), press the down arrow to adjust the setting.

### Sonazoid™ Contrast Agent

Sonazoid™ is a contrast agent approved in some countries. Refer to local clearances and availability in your respective market(s).

Sonazoid is a different microbubble, compared to other agents. You can select the Sonazoid contrast agent via Utility--> Imaging--> CON.

## Contrast Controls

### Max (Maximum) Enhance

<b>Description</b>	Sets the acoustic output to its maximum setting (100%)
<b>Values</b>	On/Off. When you deactivate Max Enhance, the acoustic output is returned to its previous setting. Max Enhance is deactivated by the system when you turn it off, change probes, or change the contrast technique.
<b>Benefits</b>	This control provides quick transition to High MI imaging. This allows the user a quick one-button push to destroy the agent. Useful when the user is interested in the bubble wash-in characteristics of the anatomy being scanned.

### Contrast Clock (Timer)

<b>Description</b>	<p>You can use the Contrast Clock by activating it at the time of injection and deactivating it at the end of the exam.</p> <p>Two timers, Contrast Clock1 and Contrast Clock2 can be displayed on the bottom, left-hand corner in the image area and info area for several injections.</p> <p><i>NOTE: You can also configure the system to perform a countdown for the contrast injection with the Utility -&gt; System -&gt; System Imaging -&gt; Countdown Time for Contrast preset.</i></p>
<b>Values</b>	<p>On/Off. You deactivate the Contrast Clock via the Touch Panel control or by starting a new patient.</p>
<b>Display</b>	<p>There are two areas on the screen where the Contrast Clock displays: on the image and on the lower, left-hand portion of the display. The timer on the image freezes when you freeze the image (the timer updates when you unfreeze the image). However, the timer located on the lower, left-hand portion of the display continues to display over a freeze, probe change, mode change, multi image, and zoom.</p> <p>The timer also appears on CINE Loops and archived images.</p>
<b>Benefits</b>	<p>The Contrast Clock measures the time since injection.</p> <p>You can save the data of contrast clock to an external file by using Export Traces of TIC.</p> <ol style="list-style-type: none"><li>1. Press <b>Freeze</b>. Scroll with the Trackball to show Cine tab.</li><li>2. Press <b>TIC Analysis</b> on the Touch Panel to enter TIC application.</li><li>3. Put a ROI on the image.</li><li>4. Press Export Traces. Type the file name and store it to the storage device.</li></ol>

## Accumulation

<b>Description</b>	Accumulation enhances the flow in an image.
<b>Values</b>	8 settings: 0=Off, 0.2, 0.4, 0.6, 0.8, 1.6, 3.2, and Infinite. If Accumulation is turned off, then Frame Averaging is used; if Accumulation value is set, then Accumulation is used.
<b>Availability</b>	Available in Contrast, Color Flow, and PDI.
<b>Benefit</b>	Accumulation detects the maximum signal and holds it for the level specified (1-7).

## SRI Usage

<b>Description</b>	You can use SRI-HD for the tissue image and the contrast image independently or together.
<b>Adjusting</b>	You can preset SRI Usage in Utility -> Imaging -> Ref tab.

## Visualization

<b>Description</b>	Define the display technique. Only available for Single View or Dual View.
<b>Values</b>	<b>Contrast.</b> Displays the contrast-enhanced image. <b>Tissue.</b> Displays the tissue image. <b>Hybrid Contrast.</b> Displays the contrast-enhanced image and the tissue image using Hybrid Map.

### Hybrid Map

**Description** Select the hybrid map for the Hybrid Contrast visualization in the Dual/Hybrid Display.

### Flash

**Description** This feature provides a way to expose the higher acoustic power for a specified time duration by pressing a control once.

*NOTE: Set the frame numbers to scanned with the higher acoustic power in Utility--> Imaging--> Con--> Flash Frames. The frame numbers defined by Flash Frames are applied to both the contrast imaging modes.*

- If you select Flash once in the Con menus, the system scans with 100% acoustic output burst pulses for the specified number of frames. The acoustic output then reverts to the original settings.
- When Max Enhance is ON for the contrast imaging modes, the system keeps Max Enhance = ON with no acoustic output change when Flash is selected in the Con menu.



## Relationship with other controls

- L + R Simultaneous Display (L: Tissue, R: Active Visualization)
  - Accumulation/Cine Capture
    - Applied on the right side image only.
    - You cannot compare On and Off image using L + R.
  - SRI-HD
    - Applied on both side image.
  - Frame Average
    - Applied on both side image.
- TIC
  - Measured on a recalled CINE, except “Hybrid Contrast”.
  - “Hybrid Contrast” is disabled and measured on “Contrast” visualization.
- Easy 3D
  - Build volume data from active visualization, except “Hybrid Contrast”.
  - Hybrid map is disabled and forces “Contrast” visualization.
- Advanced 3D/Tru3D
  - Build volume data from active visualization.
  - For the Single/Dual View data set of contrast mode, both reference and contrast data are rendered in individual volume segments. Each volume data is manipulated using Active Data and Visual Data.
- 3D
  - Hybrid Map is disabled and forces “Contrast” visualization.
  - The Cine frames have “Contrast” data only.
- Archive
  - The raw data size increases between two to three times the size compared to the previous raw data. It takes a longer period of time to save as Cine.

### Static 3D with Contrast

Static 3D is available while in Contrast imaging mode while imaging with 4D probes.

1. Activate Contrast imaging.
2. Adjust the image, as necessary.
3. Activate the Contrast Clock (if you want the acoustic output set at 100%). Or, you can activate these when you inject the contrast agent.

**NOTE:** *To restart the Contrast Clock, you need to turn it off, then back on.*

4. Activate 3D--> Static 3D. Specify the quality, angle, and render mode (Sectional, Render, and VCI Static are supported).

Wait to inject the contrast agent until after you have set up your pre-mode data. Adjust the ROI and other parameters before injecting the agent.

**NOTE:** *Accumulation and Trigger turns off or resets to 0 when you activate Pre-mode.*

5. Activate the Contrast Clock and inject the contrast agent, then press the Start Key to activate the Static 3D acquisition as soon as the contrast agent washes in.

The system automatically 'stores' the sweep (to internal memory, not to the clipboard).

**NOTE:** *You may want to set up a Fast Key to automate these keystrokes. See Chapter 6 for more information.*

## Static 3D with Contrast (continued)

6. To store this VOI, press a print key. All CINE and volume data loops are saved in 3D when you press P1. Store loops from Static 3D or from the Volume Review tab in order to store the complete volume.

*NOTE: You can also configure the system to perform a count down for the contrast injection via Utility-->System-->System Imaging.*

7. At the completion of the sweep, the Static 3D tab appears.

*NOTE: The Contrast Timer on the Volume Review images represents a timestamp of when the image was captured relative to when the timer was started.*

8. Press the **Start** key to acquire volume data.

## **Time Intensity Curve (TIC) Analysis**

### **Overview**

Time Intensity Curve (TIC) enables the user to perform the following analysis:

- Time-Intensity analysis allows instant time-intensity calculation from up to eight regions of interest.
- Curve fitting analysis for research studies of contrast agent concentration rates.

The basic TIC process works as follows:

1. Scan the patient after injecting the contrast agent.
2. Observe the agent flow through the anatomy of interest.
3. When the desired contrast effect has been visualized, freeze the image and select a range of images for analysis.
4. Position an ROI (region of interest) on one of those images where the contrast effect is visible.
5. The system then calculates the mean pixel intensity within that ROI for all frames in the user designated loop and plots the resulting data as a function of time.

You can also choose to fit this data to one of several mathematical functions. The fundamental idea is that the contrast effect flowing through the organ of interest can be modeled mathematically, and details of the wash in and washout of the agent can be gleaned by analyzing the numerical parameters of the mathematical model.

## Activating TIC

### Starting TIC in cine loop

1. Open an examination and select a contrast cine loop.
2. Select **TIC Analysis** on the Touch Panel.

### Starting TIC in live mode

1. Scan and freeze the patient in Contrast live mode.
2. Move the trackball to activate Cine.
3. Select **TIC Analysis** on the Touch Panel.

### Exiting TIC Analysis

There are several methods to exit TIC Analysis.

- Select **Exit TIC Analysis** on the TIC Touch Panel.
- Press **Freeze** to unfreeze and resume scanning.
- Press any other button that returns the system to real-time scanning.

TIC Analysis Screen Description

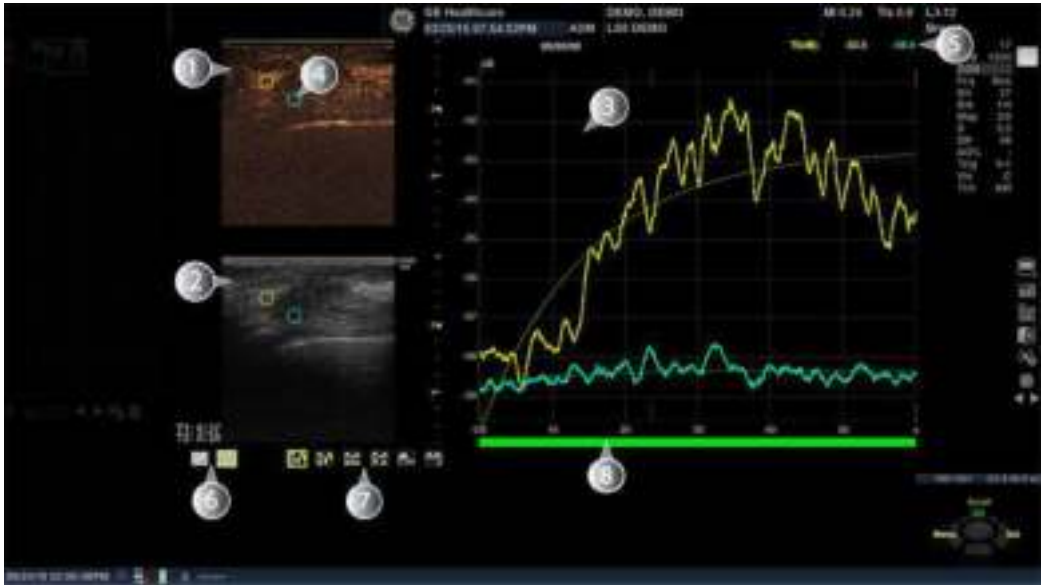

Figure 13-28. TIC Analysis Screen - Graph with dual image layout (example)

- |                             |   |
|-----------------------------|---|
| 1. Contrast cineloop window | 5. Time and velocity at cursor position |
| 2. B-Mode cineloop window   | 6. Sample area tools                    |
| 3. Analysis window          | 7. Layout icons                         |
| 4. Sample area              | 8. Frame marker                         |

Table 13-21: Cineloop windows

Graphic	Description
	<p>Displays Contrast image data</p> <p>Sample area: Indicates sampling position of the intensity trace. The sample area is color-coded: the first sample area is yellow, the second blue...etc.</p>

Table 13-21: Cine loop windows (Continued)

Graphic	Description
	<p>Displays B-Mode data</p> <p>Sample area: Indicates sampling position of the intensity trace. The sample area is color-coded: the first sample area is yellow, the second blue...etc.</p> <p>NOTE: B-Mode image is not displayed when cine clip stored in contrast only mode.</p>
 	<p>System menu on Sample Area</p> <p>This menu is displayed by pressing the left Set key when the cursor is placed over a sample area in one of the Cine loop windows.</p> <p>Note: The system menu is dependent on mode.</p> <ul style="list-style-type: none"> <li>• Set As Default ROI Size: Displays on elliptical ROI.</li> <li>• Label Sample Area: Sets a descriptive name to the sample area. The label is useful for identification of the sample area when exporting data.</li> <li>• Delete Anchor (On ROI setting as anchor point only)</li> <li>• Copy Sample Area</li> <li>• Copy &amp; Move</li> <li>• Copy &amp; Move (Same Depth)</li> <li>• Move (Same Depth)</li> <li>• Set Start Frame: Set start frame for current ROI to calculate the TIC parameters and fitting curves.</li> <li>• Set End Frame: Set end frame for current ROI to calculate the TIC parameters and fitting curves.</li> <li>• Cancel: exits the System menu.</li> </ul> <p>System menu on Image when copy sample area is selected.</p> <ul style="list-style-type: none"> <li>• Paste Sample Area</li> </ul>
	<p>Displays time-intensity curve.</p> <ul style="list-style-type: none"> <li>• Y axis: Intensity scale (logarithmic) (db) or linear acoustic units (AU).</li> <li>• X axis: Time(s) or Dt(s), elapsed time from previous frame.</li> <li>• ECG (where available -- not shown): displays ECG trace (where available).</li> <li>• Frame Marker: the current frame marker and the start and stop markers for the cine loop.</li> <li>• Time at cursor position and velocity at cursor position.</li> <li>• Intensity (dB or AU) at cursor position.</li> <li>• Intensity (dB or AU) at frame marker position (color coded)</li> </ul>

Table 13-21: Cineloop windows (Continued)

Graphic	Description
	<p>System menu of the analysis window                      This menu is displayed by pressing left Set key when the cursor is in the Analysis window.                      Note: The system menu is dependent on mode.</p> <ul style="list-style-type: none"> <li>• Vertical Auto-Scaling: selects between full unit range or a range according to the maximum and minimum values of the displayed trace(s). Delayed, On, Off.</li> <li>• Vertical Unit: toggles between logarithmic (dB) and linear acoustical units (AU). Vertical unit of previous analysis is retained.</li> <li>• Horizontal scale: Only on a loop including different frame rate.</li> <li>• Line Style: selects between solid line only or solid line with square markers at each data point.</li> <li>• TIC Parameters: The TIC parameters dialog appears.</li> <li>• Curve Fitting Parameters: toggles between Wash-in, Wash-out, Gamma Variate and off.</li> <li>• Gradient: On or Off.</li> <li>• Gradient Plot: Gradient, Gradient Derivative, All or Off (On Graph with Dual Image Layout and Small Data Layout only).</li> <li>• ECG Triggering: Only on a loop including the ECG cycle.</li> <li>• Cancel: exits the System menu.</li> </ul>

Table 13-22: Analysis windows

Graphic	Description
	<p>Displays time-intensity curve.</p> <ul style="list-style-type: none"> <li>• Y axis: Intensity scale (logarithmic) (db) or linear acoustic units (AU).</li> <li>• X axis: Time(s) or Dt(s) [Diastolic time in seconds], elapsed time from previous frame.</li> <li>• ECG (where available -- not shown): displays ECG trace (where available).</li> <li>• Frame Marker: the current frame marker and the start and stop markers for the cineloop.</li> <li>• Time at cursor position and velocity at cursor position.</li> <li>• Intensity (dB or AU) at cursor position.</li> <li>• Intensity (dB or AU) at frame marker position (color coded)</li> </ul>



Table 13-22: Analysis windows (Continued)

Graphic	Description
	<p>System menu of the analysis window This menu is displayed by pressing left Set key when the cursor is in the Analysis window.</p> <p>Note: The system menu is dependent on mode.</p> <ul style="list-style-type: none"> <li>• Vertical Auto-Scaling: selects between full unit range or a range according to the maximum and minimum values of the displayed trace(s). Delayed, On, Off.</li> <li>• Vertical Unit: toggles between logarithmic (dB) and linear acoustical units (AU). Vertical unit of previous analysis is retained.</li> <li>• Horizontal scale: Only on a loop including different frame rate.</li> <li>• Line Style: selects between solid line only or solid line with square markers at each data point.</li> <li>• TIC Parameters: The TIC parameters dialog appears.</li> <li>• Curve Fitting Parameters: toggles between Wash-in, Wash-out, Gamma Variate and off.</li> <li>• Gradient: On or Off.</li> <li>• Gradient Plot: Gradient, Gradient Derivative, All or Off (On Graph with Dual Image Layout and Small Data Layout only).</li> <li>• ECG Triggering: Only on a loop including the ECG cycle.</li> <li>• Cancel: exits the System menu.</li> </ul>

Table 13-23: Layout icon

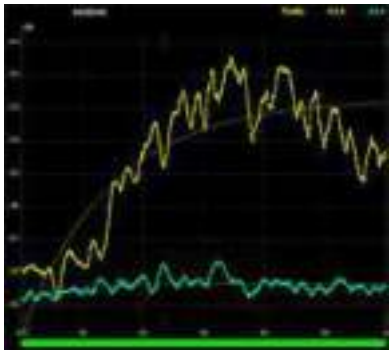



Graphic	Description
	<p>You can select layout from following.</p> <ul style="list-style-type: none"> <li>• Graph with Dual Image Layout</li> <li>• Small Data Layout</li> <li>• Large Data Layout</li> <li>• Everything Layout</li> <li>• Single Image Layout</li> <li>• Dual Image Layout</li> </ul>
	<p>Indicates an analysis graph.</p>
	<p>Indicates an image One icon means Contrast image. Two icons mean Contrast and B-Mode.</p>
	<p>Indicates parameters. 10 dots means that all parameters display. 4 dots means that only displays high level parameters.</p>

Table 13-24: Sample area drawing tool



Graphic	Description
	Creates a sample area based on freehand drawing.
	Creates a sample area with a pre-defined circular/elliptic shape.

Table 13-25: Trackball Assignment

Graphic	Description
	<p>Press the top Trackball key to toggle the trackball assignment between QA and Scroll.</p> <ul style="list-style-type: none"> <li>• QA Pointing tool in TIC mode.</li> <li>• Scroll When the cineloop is stopped, enables scrolling through the cineloop.</li> <li>• Menu Press left Set key to display System Menu.</li> <li>• Set</li> </ul>

TIC Touch Panel

Table 13-26: TIC Touch Panel Description

Parameter	Description
Exit TIC Analysis	Exit TIC.
Motion Tracking	Users use TIC to analyze tumor characteristics precisely, without distortion due to patient movement. Motion Tracker enables the system to automatically adjust the ROI's placement across multiple frames in order to accommodate patient breathing or body movements. To activate, press Motion Tracking on the Touch Panel. This starts the calculation to adjust the all ROI positions for every image frame. After completion, the ROI graphic on each frame is changed to the ROI with the anchor.
Accumulation	Enhances the flow in an image.
Enable All Frames	Re-enables disabled frames.
Curve Fitting	Toggles between Wash-In, Wash-Out, Gamma Variable and Off.
Smoothing	Smooths the trace displayed by applying a filter over a defined time window. Both the filter type and time window are user-selectable. The type of filter available depends on the analysis signal displayed.
Delete Sample Area	Removes selected sample area from the CINE Loop window and accompanying trace in the Analysis window. The Trackball marker must be pointed at an anchored sample area.
Auto Calc Range	Auto Calc Range enables system to automatically estimate the ROI's start frame and end frame to calculate TIC parameters and fitting curves. The start and end frames for each ROIs are displayed by small squares on the graph. Toggles between Current Sample, All Samples and Reset All. 
First	Move to the first frame of cineloop.
Last	Move to the last frame of cineloop.
Run/Stop	Start/Stop the cineloop review.
Loop Speed	Adjust the cine loop playback speed.
ROI width/height	Move the rotary left/right or up/down to adjust ROI width/height.
ROI tilt angle	Rotate the rotary to adjust ROI tilt angle.

Table 13-26: TIC Touch Panel Description (Continued)

Parameter	Description
Start Frame	Rotate the rotary to select the start frame and push to set the frame.
End Frame	Rotate the rotary to select the end frame and push to set the frame.
Frame by Frame	Rotate the rotary to review the CINE image frame by frame manually.
Disable frame	Push the rotary to disable the selected frame.
Graph #	Select the clip for general TIC analysis. System can register up to 10 clips and the individual parameters for each TIC analysis are maintained in one TIC analysis session.
Remove Graph	Remove the selected graph from the clip list in Graph # button.
Merge Graphs	Referring to Contrast Clock1 in the stored clips, system merges the TIC graphs. Contrast Clock1 and at least 2 ROIs are required for Merge Graphs.

## Generating a Trace

Up to eight traces can be generated.

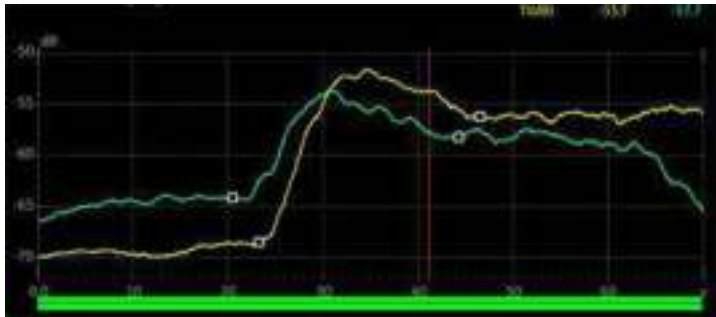
### About the sample area

The sample area can be in three different states:

- **Free sample area:** freely moving sample area (QA cursor) before anchoring.
- NOTE: The free sample area disappears when the QA cursor is moved over a static anchored frame.*
- **Static sample area:** the free sample area is anchored by pressing **Set**.
  - **Dynamic anchored sample area:** the sample area is anchored in two or more frames (see Manual tracking below). In these particular frames, the sample area is displayed with an anchor. The sample area moves smoothly between the anchored positions when playing/scrolling the cineloop.

### Trace from a pre-defined sample area (Ellipse ROI)

1. Press the top **Trackball** key until the QA trackball assignment is selected.
2. If necessary, select the sample area Ellipse ROI button (shape icon on the monitor display).
3. Move the cursor to one of the Cineloop windows using the **Trackball**.

The cursor is changed to a sample area (white circle). A preview of the trace is displayed in the Analysis window.

4. Press **Set** to anchor the sample area.

In this frame, the sample area is marked with an anchor. If the cineloop has more than one heart cycle, a sample area will also be anchored in the corresponding frame in the next heart cycle.

The trace is updated accordingly in the Analysis window.

### Generating a Trace (continued)

#### Trace from freehand sample area

1. Select the Freehand ROI button (pencil icon on the monitor display).
2. Move the cursor to one of the Cineloop windows using the **Trackball**.
3. Trace the outline of the desired ROI by moving the caliper with the **Trackball**.
4. Press **Set** to anchor the sample area.

The sample area is automatically closed and the trace is updated accordingly in the Analysis window.

#### Copy, move and paste a Sample Area

To copy and paste the ROI,

1. Move the cursor over the ROI and press the left **Set** key. The system menu displays.
2. Select **Copy sample area**.
3. Move the cursor to the desired location for the copied ROI and press the left **Set** Key. The system menu displays.
4. Select **Paste sample area**.

To copy and move the ROI,

1. Move the cursor over the ROI and press the left **Set** key. The system menu displays.
2. Select **Copy & move**. Or if you want to move to the same depth as the original ROI, select **Copy & move (same depth)**.
3. Move the copied ROI using the **Trackball**. Press **Set** to fix the position.

To move the ROI,

1. Move the cursor over the ROI and press the left **Set** key. The system menu displays.
2. Select **Move (same depth)**.
3. Move the ROI using the **Trackball**. Press **Set** to fix the position.

## Manual tracking of the sample area (dynamic anchored sample area)

The sample area can be moved within the loop to ensure that data in the trace is generated from the same anatomical location during the cyclic motion of the heart.

1. Place a sample area over a region of interest. Note the anatomical location of the sample area.
2. Scroll to a new frame using the **Trackball**.
3. Press the top **Trackball** key until the QA trackball assignment is selected.
4. Move the cursor to the sample area using the **Trackball**.
5. Press **Set**. The sample area is unanchored.
6. Drag the sample area to the corresponding anatomical location in the new frame.

When the sample area is anchored in more than one frame, linear interpolation is performed so that the sample area is smoothly moved between the anchored positions in the selected frames when running the cineloop.

**NOTE:**

*In the original frame and this particular frame the sample area is marked with an anchor.*

7. Press the top **Trackball** key until the scroll trackball assignment is selected.
8. Using the **Trackball**, scroll through the cineloop and control that the sample area follows the moving anatomical structure.
9. Add anchored sample areas in several frames to obtain a more accurate displacement of the sample area.

### Moving a dynamic anchored sample area

1. Freeze the image.
2. Press top Trackball key until the scroll trackball assignment is selected.
3. Using the **Trackball**, browse through the cineloop to display one of the frames where the sample area was anchored.

*NOTE: In these frames, the sample area is marked with an anchor.*

4. Press top Trackball key until the QA trackball assignment is selected.
5. Move the cursor to the sample area using the **Trackball**.
6. Press **Set**. The sample area is unanchored.
7. Drag the sample area to a new location.
8. Press **Set** to anchor the sample area to the new location.

If you want to move the sample area to the same depth, select **Move (same depth)** from the System Menu.



## Zooming in the Analysis window

To zoom:

1. In the Analysis window, press and hold down the **Set** key while dragging the cursor to define the zooming area.
2. Release the **Set** key.

To unzoom:

1. Press the left **Set** key in the Analysis window. The system menu displays.
2. Select **Unzoom**.

*NOTE:*            *Shown only in zoom mode.*

## Delete a trace

The user can delete all traces at once or one at a time.

1. If necessary, press the top Trackball key until the QA trackball assignment is selected.
2. Move the cursor over one of the sample area. Confirm that cursor is changed to hand icon.
3. Press the **Delete Sample Area** on the touch panel.
4. Select **Current Sample** or **Delete all** as necessary.

*NOTE:*            *The corresponding traces for the deleted ROIs are erased from the plot.*

### Disabling/Enabling the frame

Frame disabling excludes the actual frame from the cineloop display. Frame disabling is available only with contrast data.

#### Disabling the frame from the frame marker

To disable One Frame:

1. Use the **Trackball** to move the cursor to the frame on the Frame Marker which you want disable.
2. Press **Set** to disable the frame.
3. The frame marker is changed from green to red to indicate the frame has been disabled.

*NOTE: The disabled frame is no longer displayed in the reference window when scrolling through CINE memory.*

#### Disabling multi-frames from the frame marker

1. Use the Trackball to move the cursor to the first frame on the Frame Marker.
2. Press and hold down **Set**
3. Move the cursor with the Trackball to the last frame to be disabled and release Set.

The marker is turn red and the data from that frame is removed from the trace and any subsequent trace processing.

#### Disabling ECG triggered frame (where available)

In a multi-cycle acquisition, the user may deselect all frames in all heart cycles but a selected one. This function can be used for example to select a particular systolic frame for each heart cycle.

1. Scroll through the cineloop to identify the cardiac phase to analyze or identify the cardiac phase on the ECG trace (where available).
2. Position the cursor on the analysis window and press left **Set** key. The system menu displays.
3. Select **ECG triggering** (where available).

All frames in all heart cycles are disabled except for the selected and corresponding frames in the other heart cycles.

## Disabling/Enabling the frame (continued)

### To enable the frames

1. Select **Enable all frames** on the Touch Panel.
2. All disabled frames are re-enabled.

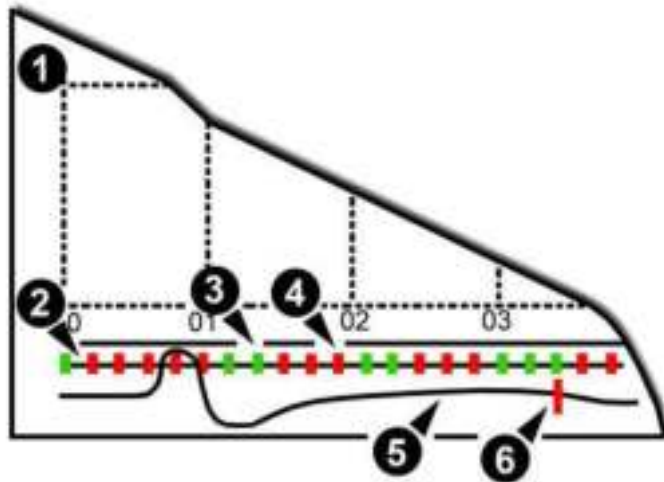

Figure 13-29. Frame markers

1. Analysis Window
2. Frame markers axis
3. Enabled frame (Green)
4. Disabled frame (Red)
5. ECG (where available)
6. Current frame

### **Manipulating the Sample Area**

Up to eight ROIs can be saved on the reference image, with the corresponding eight traces plotted simultaneously on the graph. Each ROI display has a different color, and its corresponding trace data is plotted using that same color.

Once eight ROIs have been saved, the system does not automatically generate an active ROI when the cursor is positioned over the displayed reference image.

The saved ROIs can be a mixture of elliptical and freehand ROIs.

When the user repositions an ROI, the old trace data is erased from the plot and the trace data for the new position replotted.

If the ROI position on the last frame of the selected image range is moved, the corresponding ROIs on all frames are repositioned to match the last frame.

The user shall also have the capability of setting separate ROI positions on different frames of the contrast images, and the system shall linearly interpolate the ROI positions for the frames in between the selected frames.

## Manipulating the Sample Area (continued)

### Setting the default sample area shape

1. Place the cursor on the sample area.
2. Press left **Set** key. The system menu displays.
3. Select **Set as Default ROI Size**.
4. The current ROI size is set as the default for subsequent Ellipse ROIs.

### Reshaping a Sample Area

To reshape the sample area:



Figure 13-30. ROI

- Move the rotary up and down to change the height.
- Move the rotary left and right to change the width.
- Rotate the rotary to change the tilt angle.

### Labeling a Sample Area

The sample area label is used to identify data associated with the sample area when exporting.

1. Position the cursor on the ROI to label and press the left **Set** key.
2. The ROI system menu displays. Select **Label sample area**. The Label Dialog box displays.
3. Enter a name for the sample area.
4. Select **OK**.

### TIC Plot Control

#### Vertical Unit

When analyzing the contrast data, the Y-axis can be set to display either logarithmic scale (dB) or linear, acoustic units (AU) for both tissue intensity (2D) or Angio intensity data.

To toggle between dB and acoustical display units for the Y-axis. The unit of previous analysis is retained.

- **dB**—The traditional log compressed B-Mode data is used to calculate the time-intensity curve values.
- **Acoustic**—The system reverse the log compression function to provide un-log compressed data for the TIC analysis.

#### Vertical auto-scaling

The system can be configured to display the full unit range or a range according to the maximum and minimum values of the displayed trace(s) (auto-scaling function). In addition, the auto-scaling function can be set to be live update (updates while the sample area is moved) or delayed (updated when the sample area is anchored).

- **Delayed**—The system automatically rescale the vertical axis of the trace graph only when a new ROI is saved, to account for changing input dynamic range.
- **On**—The system automatically rescale the vertical axis of the trace graph every time the currently selected (active) ROI is moved.
- **Off**—Disable any automatic scaling of the vertical axis. There is user-defined system defaults on the system preset page for the fixed vertical scale to be used for the plot.

#### Y-Scale

1. When you select “Off” for Vertical Auto-Scaling, Y-Scale dialog displays.
2. Enter maximum and minimum value for vertical scale on the graph.
3. Press **OK**. The vertical scale is updated.

## TIC Plot Control (continued)

### Line Style

- **Solid**—Setting the results in a plotted trace that does not display small boxes at the data points
- **Squares**—Setting the results in a plot where small squares are displayed at each data point, and the squares are linked together by lines.

### Horizontal Scale

Set the horizontal unit as time scaling (s) or time interval (dt) between frames.

*NOTE: Only on a loop including different frame rate.*

### Smoothing

The system can smooth the traces displayed by applying a filter over a defined time window. The type of filter available is depending on the analysis signal displayed.

1. Select **Smoothing** on the Touch Panel.

*NOTE: When smoothing is turned on, it applies to all traces in the plot window.*

2. The smoothing filter list displays. Select the appropriate parameter.

*NOTE: When smoothing is turned on, it applies to all traces in the plot window.*

## Trace Measurement

### Gradient

Gradient is displayed on the screen instead of Intensity (db or AU). The gradient calculates from 7 points (includes previous and next frames).

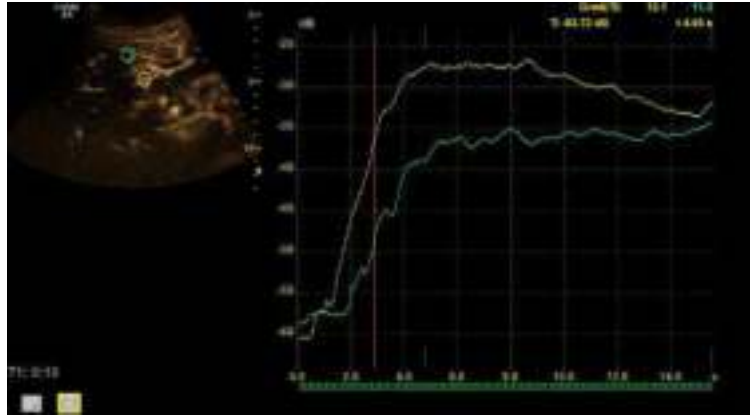

Figure 13-31. Gradient



**Trace Measurement (continued)**

**TIC Parameters**

Following parameters are automatically calculated and displayed with the graph.

Table 13-27: TIC Parameters

MGrad	Maximum Gradient
MGT	Max Gradient Time
Grad.	Mean Gradient for the peak intensity.
ArT	Arrival Time
TtoP	Time to Peak
PI	Peak Intensity
TWH	Time Width at Half maximum intensity
TWR	Time Width Ratio for wash-in and wash-out
AUC	Area Under the Curve
WiAUC	Wash-in Area Under the Curve
WoAUC	Wash-out Area Under the Curve
A, B, C, k and MSE	The coefficients and the mean square error for fitting curve equation. These parameters are displayed only on Large Data Layout with curve fitting.

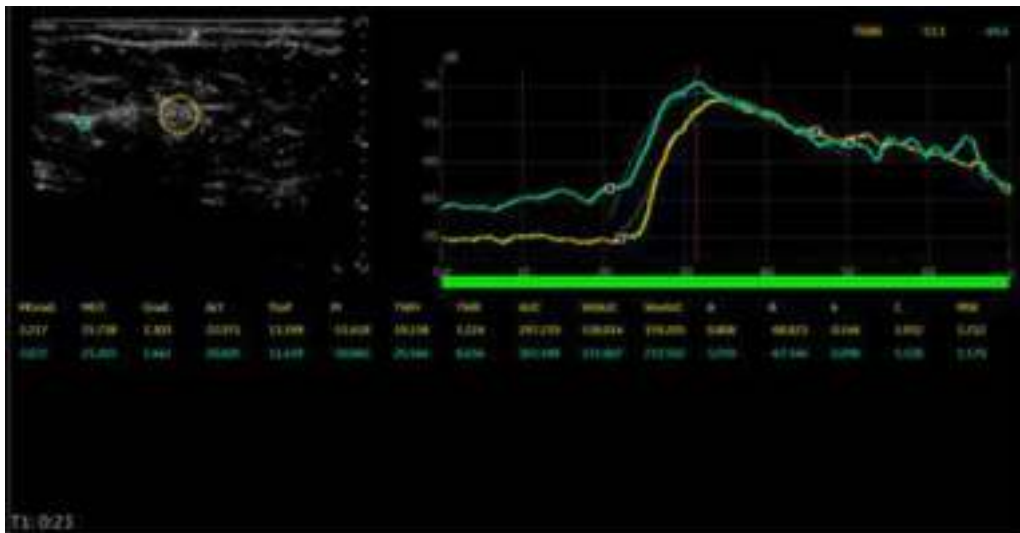

Figure 13-32. TIC Parameters

### Trace Measurement (continued)

#### Show graph (Gradient plot)

1. Select **Gradient Plot** from the pull-down menu.
2. Select the parameter.
  - Off: A graph plots TIC.
  - Gradient: Two graphs plot TIC and TIC gradient.
    - Unit of Y-axis is dB or AU in case of intensity.
    - The unit is  $d(\text{dB})/dt$  or  $d(\text{AU})/dt$  in case of the intensity gradient.
    - Gradient values for the current frame are displayed in the upper right corner of the graph.
  - Gradient Derivative: Two graphs plot TIC and TIC gradient derivative.
    - The Y-axis units is  $d^2(\text{dB})/dt^2$  or  $d^2(\text{AU})/dts$  in case of the intensity gradient derivative.
    - Gradient derivative values for the current frame are displayed in the upper right corner of the graph.
  - All: Three graphs plot TIC, TIC gradient and TIC gradient derivative.

## Curve Fit

1. Select **Curve Fitting** on the Touch Panel.
2. The Curve Fit selection list displays.

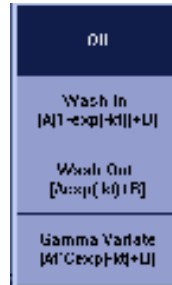

Figure 13-33. Curve Fit Selection List

- **Off**—Remove the fitted curves from the plot and the fit parameters from the display.
- **Wash-in**—Used to find and estimate the local perfusion rate using the contrast agent. Exponential wash-in is described by the function:

$Y(t) = A(1-\exp(-kt))+B$ , where:

- A (dB or AU) is the intensity from the contrast agent.
- B (dB or AU) is the intensity at time  $t=0$  (defined as the time of the left marker). This corresponds to the tissue (baseline) signal if no contrast is present at the selected starting point.

**NOTE:**  $A + B = \text{contrast} + \text{tissue} = \text{plateau level}$ .

- $k$  (1/s) is a time constant.

- **Wash-out**—Used to find and estimate a local wash-out rate. Exponential wash-out is described by the function:

$Y(t) = A\exp(-kt)+B$ , where:

- A (dB or AU) is the intensity from the contrast agent.
- B (dB or AU) is the intensity from the tissue = baseline signal.

**NOTE:**  $A + B$  is the initial intensity level.

- $k$  (1/s) is a time constant.

- **Gamma variate**

$Y(t) = At^c\exp(-kt)+B$

Parameters of Gamma curve fitting

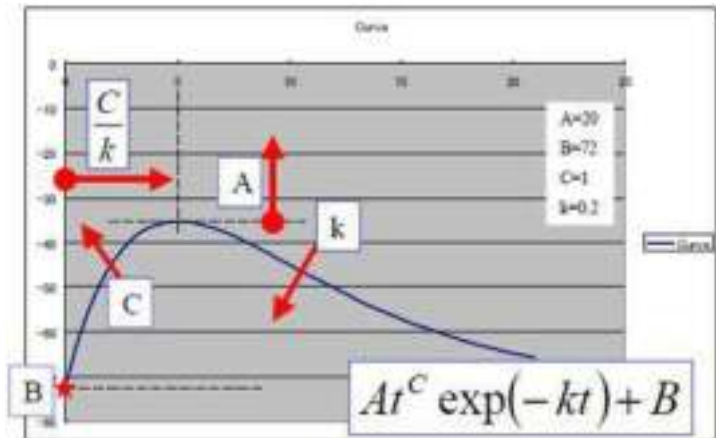

Figure 13-34. Gamma Curve

- $t^C$ : Increasing function ( $C>0$ ) for “Wash-in”.  
For larger C, the intensity increases quickly before the peak.
- $\exp(-kt)$ : Decreasing function ( $k>0$ ) for “Wash-out”.  
For larger k, the intensity decreases quickly after the peak.
- B: Intercept intensity at  $t=0$ .
- The peak intensity of the curve is affected by all parameters.  
Larger A, larger B, larger C, and smaller k make larger peak.  
The peak time is calculated by  $C/k$ .
- MSE: Mean Square Error  
If the MSE is small, the difference of actual data and the fitted curve is small.

### Set Start/End Frame for Curve Fit per ROI position

1. Generate TIC and perform a Curve Fit. In this state, the Curve Fit graph is drawn from Cine Start Frame to Cine End Frame for all the ROIs.
2. Push Auto Calc Range on Touch Panel and select All Samples. Then the start and end frames for each ROI are automatically estimated.

If you need to optimize the start and/or end frames,

1. Select the start frame as with Cine or move the cursor to the desired position on the graph and press the right **Set** key.
2. Move the arrow pointer on the ROI (hand cursor appears) and press the left **Set** key. The system menu appears.
3. Select **Set Start Frame** from the menu.
4. Select the End Frame as with Cine or move the cursor to the desired position on the graph and select the right **Set** key.
5. Move the arrow pointer on the ROI (hand cursor appears) and select the unmarked key (the left Set key). The system menu appears.
6. Select **Set End Frame** from the menu. The ROI colored line displays.
7. Repeat the above procedures as necessary. The system retains the start/end frame per ROI while TIC is active. Once the TIC menu is closed, the settings are lost.

### Display/Hide Calculation Values

You can select the TIC parameters for Small Data Layout and Everything Layout.

1. Place the cursor on the analysis graph and press left Set key. Select TIC Parameters from the pull-down menu.
2. The TIC Parameters dialog appears.
3. Select a maximum of 6 parameters to display for each TIC.
  - Save As Default: saves as a system preset.
  - Save: saves as temporary.
  - Cancel

**NOTE:** *If you select more than 6 parameters and select Save or Save as default, you will be prompted to select up to 6 parameters.*

4. The selected parameter displays for Small Data Layout and Everything Layout. Press the Large Data Layout button to display all parameters; or press the other Layout button to hide all parameters.



Figure 13-35. Curve Fitting Parameters Dialog

## Raw Data store with TIC Setting

You can store the raw data with TIC setting.

1. Run TIC cineloop.
2. During cine running mode, press appropriate print key.

When you recall the raw data clip with TIC data, you can add, delete or modify the analysis measurements on the recalled raw data in TIC mode.

## Printing TIC Data

1. Press **Run/Stop** to freeze the image.  
The still image can be get when cineloop is stopped by Run/Stop button.
2. The system captures a single still frame which consists of the plot, the reference image and user annotation.

## Annotating the TIC Data

The user can annotate both the reference image and the trace plot displays. Use **Comment** key to type the annotation. See Chapter 6 for reference.

### SaveAs (Save image file and export trace data)

You can save the image file and trace data.

1. Select **SaveAs**.
2. The following dialog displays.
  - Location: Select Location which to save.
  - Filename: Enter the file name. (Only Text)
  - Export Trace: If you check this box, LOGIQ Totus exports trace data to .csv file.

Note: Name of exported file has same name as the image file saved at the same time.
3. Select **OK** to save the image and data and return to the TIC Analysis screen.
  - All displayed ROI traces are saved in the exported file.
  - The fit parameters are included in the trace file if the user has done a curve fit.

*NOTE: The Smoothed trace is the one saved if the user has applied a smoothing filter.*

*NOTE: Only data from the user selected image range is included in the exported trace file.*

*NOTE: Data for disabled frames are not included in the exported trace file.*

*NOTE: No trace results are saved in the standard image database.*

*NOTE: Trace results are not shown on the Worksheet.*



## TIC cineloop store

When you transfer TIC cineloop to the external server, check “Add Multiframe Data” in Utility -> Connectivity -> Button and then store the cineloop to the system.



Figure 13-36. Button page

## TIC Analysis for multiple Clips

When you load additional contrast data on the clipboard in TIC mode, the system registers the contrast clips to analysis list up to 10 data in one TIC analysis session. The system maintains individual TIC setting such as ROI shape, position, smoothing, motion tracking state etc. for each clip. You can recall the clip by eGraph #f button on touch panel. The eRemove Graph button can remove selected clip from the analysis list.

The registered clip list and TIC settings are reset by exiting the TIC mode.

## Merge Graphs

You can merge the multiple graphs such as early phase and late phase for 2 TIC graph plots by eMerge Graphs button on touch panel. This function requires the stored clips which have the Contrast Clock1 information and at least 2 ROIs (yellow and light blue) for TIC analysis.

The horizontal scale of merged graph is based on Contrast Clock1.

Table 13-28: Merge Graphs Touch Panel Description

Parameter	Description
Exit	Exit to individual TIC analysis mode. All TIC parameters for registered clips are maintained.

**Merged graph Screen Description**



Figure 13-37. Merged Graph display

1. Merged graph window
2. Parameter table

Table 13-29: Merged graph window

Graphic	Description
	Displays the merged graph on the upper part of monitor. The horizontal scale is based on the Contrast Clock1.

Table 13-29: Merged graph window

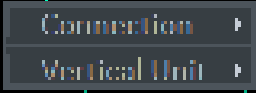
Graphic	Description
	<p>Displays the parameters on the lower part of monitor.</p> <p>The parameters are the intensity of ROI1 (Yellow), ROI2 (Light blue), Subtraction (ROI1-ROI2) and Standard deviation of ROI1 and ROI2..</p> <p>These are calculated for peak and last 5sec. average of 1st clip, and average of other clips based on Contrast Clock1 value.</p>
	<p>This menu is displayed by pressing the left Set key when the cursor is placed over the merged graph window.</p> <p>Connection : selects the graph connection method. Average, Direct and No Line.</p> <p>Vertical Unit : toggles between logarithmic(dB) and linear acoustic units(AU). Vertical unit of previous analysis is retained.</p>

### SaveAs (Save image file and export merged trace data)

You can save the graph image file and trace data.

1. Select SaveAs.
2. The following dialog displays.
  - Location: Select Location which to save.
  - Filename: Enter the file name. (Only Text)
  - Export Trace: If you check this box, system exports trace data to csv file.

*Note: Name of exported file has same name as the image file saved at the same time.*

3. Select OK to save the image and data and return to the merged graph screen.

# Strain Elastography

## Description

Strain Elastography shows the spatial distribution of tissue elasticity properties in a region of interest by estimating the strain before and after tissue distortion caused by external or internal forces. The strain estimation is filtered and scaled to provide a smooth presentation when displayed.

Below is an example of Strain Elastography. The image is displayed in dual mode with the color map/bar of the Strain Elastography on the left side and the imaging parameters on the right side of the display below E.

You activate Elastography via the Elasto hard key on the Control Panel.

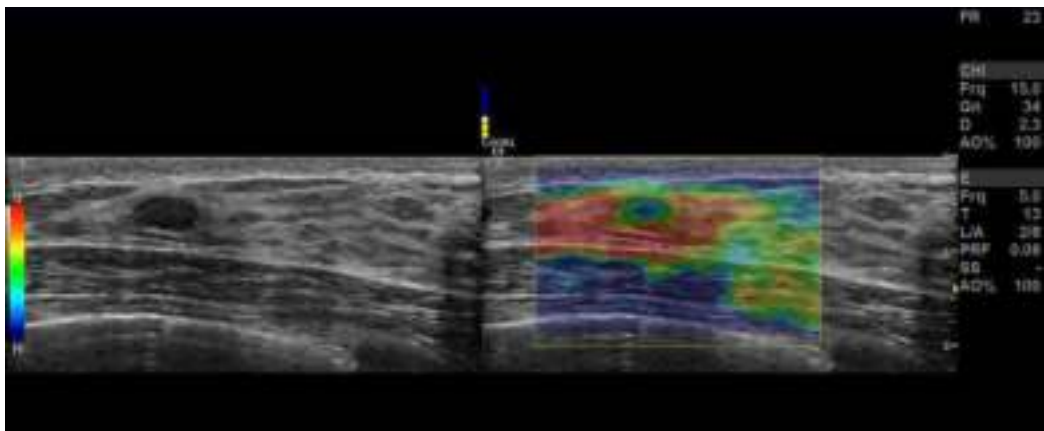

Figure 13-38. Strain Elastography Example

## **Using Strain Elastography**

The Strain Elastography image is achieved by pulsating the probe while you are scanning the anatomy of interest. Here are some criteria to use:

Handheld elasticity imaging can be very dynamic as the size of distortion depends on the movement of the hand-held probe. To maintain stable and consistent displayed strains, pay attention to the Quality graph. Two forms of feedback are provided. In either form, an ideal manual compression is indicated by a high value feedback. In addition, apply the following post-processing controls: Smoothing, Window, Scaling, and Frame Averaging.

Strain Elastography displays firmer tissue in blue and softer tissue in red. To enhance Blue, increase Hard Compress; to enhance Red, increase Soft Compress on the Touch Panel. To enhance strain elastography contrast, reselect the Color Map.

If you need more resolution, reduce Smoothing, increase Frequency, or reduce Window.

If you need a smoother image, increase Window or Smoothing.

If the images seem too flashy, decrease Frame Reject to 1.0 and Noise Reject to have consistent imaging throughout.

## Using Strain Elastography (continued)

Table 13-30: Strain Elastography

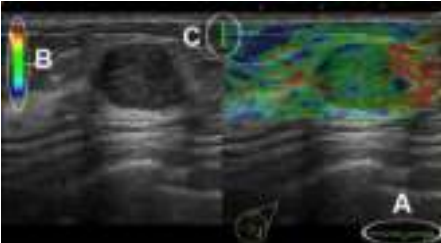
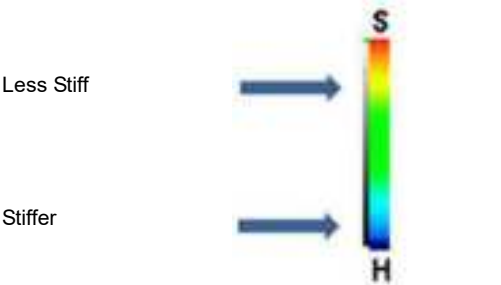
Using Strain Elastography	
<p><b>Manual Compression:</b></p> <ol style="list-style-type: none"> <li>1. Press “Elasto” button at the console to activate.</li> <li>2. Select Strain on Touch Panel.</li> <li>3. Adjust the position of the ROI to place the suspicious area at the center.</li> <li>4. Adjust the size to include surrounding tissue (sample area size = x3 dimension of the lesion per axis).</li> </ol> <p>Manual compression depends on the type of probe.</p> <ol style="list-style-type: none"> <li>1. Linear probes: Perform slight compressions keeping transducer perpendicular to the skin. Duration: 5 sec. or 10 compressions.</li> <li>2. Convex probes: Turn the patient on his left side more than 90 deg. Pressing with the probe above the lesion, allowing the heart and lungs to create the compressions.</li> <li>3. Endocavitary probes: Perform soft, angular movement in plane of the probe. Duration: 5 sec. or 10 compressions.</li> </ol> <p><i>Note 1: Any very soft (vessel, cyst, air) or very stiff (bone) tissue above the lesion or the reference area may cause interference with the compressions. You may want to attempt from a different view.</i></p> <p><i>Note 2: Keep the lesion within the image and watch the quality graph for consistent high nearly flat (plateau-like) peaks.</i></p>	<p><b>Select the frame to analyze</b></p> <ol style="list-style-type: none"> <li>1. Press “Freeze.”</li> <li>2. Using the trackball or “frame by frame” knob, select a frame on a plateau of the quality graph (Image 1, A) or when consistent frames with green bars are visualized (Image 1, B).</li> </ol>  <p><i>Image 1: Elastography image with quality graph (A), quality bar (C) and elasto color bar (B).</i></p> <p>The relation between elastography colors and area's stiffness is given at the elastography color bar (Image 1, B).</p> 

## Clinical Applications

Table 13-31: Clinical Applications

Application	Compare the suspicious lesion with:	Probe
<b>Breast</b>	A fatty area in the breast or the average rounding breast tissue.	<ul style="list-style-type: none"> <li>• 9L-D</li> <li>• ML6-15-D</li> <li>• L3-12-D</li> </ul>
<b>Thyroid</b>	A normal area in the parenchyma of the gland.	<ul style="list-style-type: none"> <li>• 9L-D</li> <li>• ML6-15-D</li> <li>• L3-12-D</li> </ul>
<b>MSK</b>	A normal area in the same part of the body.	<ul style="list-style-type: none"> <li>• C1-6-D/C1-6VN-D</li> <li>• 9L-D</li> <li>• L3-12-D</li> <li>• ML6-15-D</li> </ul>
<b>Liver</b>	A normal area in the parenchyma of the liver.	<ul style="list-style-type: none"> <li>• C1-6-D/C1-6VN-D</li> <li>• 9L-D</li> </ul>
<b>Prostate</b>	A normal area in the parenchyma of the prostate.	<ul style="list-style-type: none"> <li>• IC5-9-D</li> </ul>
<b>Uterus</b>	A normal area in the parenchyma of the uterus.	<ul style="list-style-type: none"> <li>• IC5-9-D</li> </ul>

## Strain Elastography Controls

Table 13-32: Strain Elastography Touch Panel Description

Parameter	Description
Axial Smoothing	Controls the smoothness of the strain elastography image in the axial direction. A higher value means a smoother image.
Lateral Smoothing	Controls the smoothness of the strain elastography image in the lateral direction. A higher value means a smoother image.
Window	Controls the RF data segment size for the motion tracking. A higher Window value gives a better signal to noise ratio (SNR) at the cost of axial resolution.
Map	<p>Controls the strain elastography maps. Seven different maps are available with various contrast and color schemes, including a grayscale map. Selections: E0-7, E-Gray, and S Map.</p> <p>The E Map calculates the mean strain for the whole ROI and assigns this mean value to a green (center) color. This is best suited for imaging a localizing mass compared to the surrounding tissue with external forces (the movement of the hand-held probe).</p> <p>The S Map is useful for imaging diffusely-distributed diseases and local strain changes brought about by internal forces such as the movement of a beating heart and moving vessels. The default strain sensitivity is unique by probe/application. You can adjust the strain scale by adjusting the strain sensitivity tool.</p>
Frame Average	Controls the persistence of the strain elastography images.
Frequency	Controls the transmit frequency.

Table 13-32: Strain Elastography Touch Panel Description (Continued)

Parameter	Description
Strain Sensitivity	If S0 Map (in live) is selected, the user can control Strain Sensitivity (SS).
Soft Compress	Individually controls the image enhancement for the softer than average tissues.
Hard Compress	Individually controls the image enhancement for the harder than average tissues.
Scale	Controls the time interval between consecutive firings. A lower value dictates a higher sensitivity to weak manual motion.
Transparency	High values bring out the tissue behind the strain elastography data. You adjust via the Color Gain control; this imaging parameter appears as a "T" on the right-hand portion of the display.
Biopsy Kit	Biopsy Kit.
Frame Reject	Controls how many frames get rejected due to low quality vertical motion. A higher value means more frames get rejected. A rejected frame has a completely transparent ROI with the B-Mode background showing through.
Noise Reject	Controls how many frames get rejected due to lateral and elevational motion. A higher value means more frames get rejected. A rejected frame has a completely transparent ROI with the B-Mode background showing through.
Line Density	Optimizes B-Mode frame rate or spatial resolution for the best possible image.
Show Quality Graph (restart needed)	Select to display a Quality Graph for Elastography. The higher the level, the higher the data quality for the frames.



## Application Parameters

You can set the Quality Bar and Quality Graph on the Utility--> Application--> Settings --> Elasto page.

For Quality Bar:

- Check to display a Quality Bar for Elastography.

For Quality Graph:

- Off (No elasto quality graph is displayed in the image)
- Small, Medium or Large for display size of Quality Graph.

## General Imaging Parameters by Application/Probe/Feature

Select the Default Elasto Mode via Utility--> Imaging--> General.

You can specify Strain to be the default setting by application and probe.

1. To specify a default probe per application, select Utility --> Imaging --> General.
2. Select the application.
3. Select the default probe from the pull-down menu.
4. Specify the Default Elasto setting:
  - Strain
  - Shear

# Elastography Analysis

## Overview

The Elastography Mode detects strains by correlating the echo amplitudes of the tissue when compressed and uncompressed. Different displacement of echoes is an indicator for different stiffness (strain) of the tissue. High strain means that the tissue is softer, low strain means that it is stiffer. Zero is absolutely stiff without any elasticity. Elastography Analysis is a strain ratio comparative tool that enables users to compare the strain of one tissue to the surrounding tissue.

## Using Elastography Analysis

1. If not yet in Elastography Mode press Elasto.
2. Perform the scan. Proper manual compression/decompression is indicated by a fully green quality bar.
3. Press Freeze and scroll the Trackball to bring up the CINE tab on the Touch Panel.
4. Press Analysis on the Touch Panel. The Elastography Analysis Touch Panel appears and the monitor screen shows the Elastography Analysis display. The valid Elastography frames are marked green.
5. Adjust the start and end of the CINE Loop within the green frames using the rotary buttons below the Touch Panel (Start Frame/End Frame). Press Set to confirm..
6. Activate the cursor and move it over the Elastography image on the top left side of the screen. A white sample area appears. By default this sample area is a circle. It will be the reference sample area and should be placed in the normal breast tissue.
7. Position this reference sample area and press Set. A yellow plot curve displays the strains over time on the right side of the monitor screen.
8. Move the Trackball again. A new sample area appears (sample area 1) which should be placed in the lesion.
9. Position the sample area and press Set. A second plot curve is displayed (blue curve).

## Using Elastography Analysis (continued)

In total you can create 7 sample areas and 1 sample area. Each sample area can be edited, moved, copied, or deleted. A sample area can also be drawn manually.

1. To edit an existing sample area, move the cursor over the sample area then press the left Trackball control (Menu) to bring up the menu. Select "Set Sample Area Shape" to enter a dialogue window where Height and Width can be adjusted. You can also label, delete, copy, move the sample area by selecting corresponding options in the menu.
2. To draw a sample area manually, select the pencil icon. Then the cursor becomes a cross inside the strain image. Start to draw the sample area by pressing "Set." Press "Set" again to stop drawing.

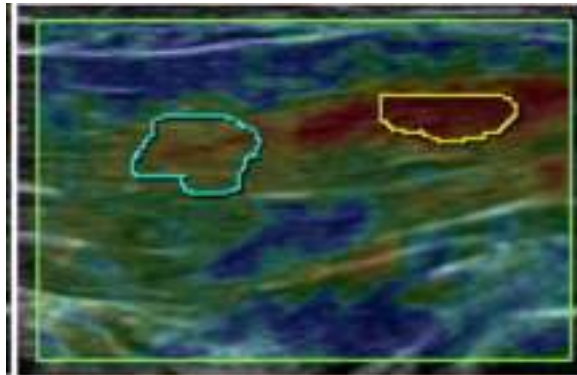

3. Both Stiffness and Ratio plots can be displayed: Switch to Ratio plots by pressing the Ratio control on the Touch Panel.
4. Press Exit Analysis to return to Elastography Mode.

## Using Elastography Analysis (continued)



### HINTS

Use the trackball to scroll the Cine Loop quickly.

*NOTE: The maximum strain value in human tissue can be up to 2%.*

*NOTE: The ratio value indicates how many times the tissue of a sample area is harder or softer than the tissue of the Reference sample area.*

## Elastography Analysis Display Description

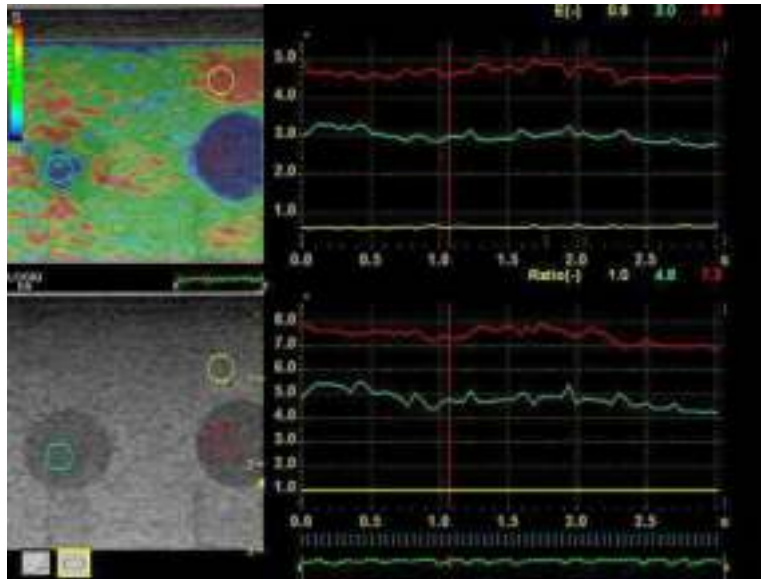

Figure 13-39. Elastography Analysis Example

1. Reference sample area
2. Lesion
3. Harder compression
4. Lower compression
5. Strain plot
6. Ratio plot
7. Frame indicator lines: green lines indicate frames with color in the Elastography image, red lines indicate invalid frames without color.
8. Reference sample area is set to 1
9. Lesion is 0.8 times as rigid as the Reference sample area

## Additional Notes for Elastography Analysis



### HINTS

#### Limitations:

- This is a relative quantification tool based on freehand manual palpation technology. It cannot show the stiffness by the kPa (kilopascal).
- There is no compatibility among manufacturers regarding the value. It depends on their strain imaging technology and definition of the value.
- Colors indicate degree of stiffness and do not directly correlate to a specific tissue type. Interpretation of what the tissues are and how to apply these ratios clinically is at the discretion of the user.
- Elastography physics dictates that cystic structures will be displayed with a three-layer pattern. This three-layer pattern will start with blue on the factory default map (which corresponds to hard), then progresses to green and then to red (which corresponds to soft). The posterior displacement of elastography patterns also may cause the B-Mode cyst to consist primarily of blue with the green to red being posterior to the B-Mode cyst. You need to be aware of the three-layer pattern of a cyst in elastography. Utilizing Elastography Analysis and setting the sample area in the blue portion of the three-layer pattern on the cyst and then setting the sample area in the “normal” tissue may cause you to misinterpret the Elastography Analysis ratio as the cyst to be hard as compared to the “normal” tissue.

# Shear Wave Elastography

## Overview

Shear wave elastography on the LOGIQ Totus is an ultrasound imaging mode in which shear waves are generated in-vivo acoustically via the imaging ultrasound transducer. The motion of the shear waves is then tracked using ultrasound to determine their velocity of propagation, which is a quantifiable indicator of the mechanical properties of the tissue through which it traveled. The steps associated with performing this analysis on the LOGIQ Totus include correctly placing a user-specific region of interest (ROI) over the anatomy of interest. Next, the user activates the shear wave analysis mode where the shear wave generation and tracking occurs. Up to four (4) sites may be analyzed. After acquiring the data, the user either stores the image or analyzes it via measurement tools which can produce shear wave velocity or stiffness statistics of areas within the ROI.

**Overview (continued)**

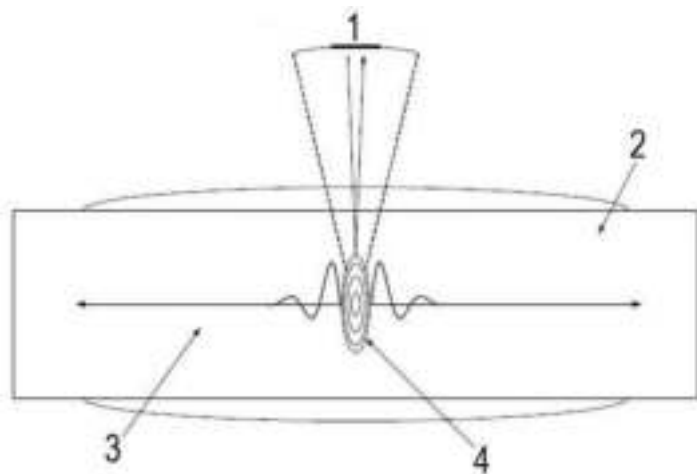

Figure 13-40. Shear wave Probe Characteristics

1. Excitation and imaging transducer
2. Tissue
3. Propagating Wave
4. Focus



## Intended Uses

Shear wave elastography Intended Uses are:

- Abdomen
- Small Parts
- Musculoskeletal
- Gynecological
- Urological



**CAUTION**

Shear wave elastography IS NOT intended for use for Obstetrical exams.

## Configuring Shear Wave

To configure Shear Wave parameters, you need to adjust the following Utility pages:

- ELASTO Imaging Parameters (Utility -> Imaging -> Elasto)
- General Imaging Parameters (Utility -> Imaging -> General)
- System Imaging Parameters (Utility -> System -> System Imaging)
- Measurement Parameters (Utility -> Measure -> Advanced -> for both Abdomen and Small Parts Breast)

### ELASTO Imaging Parameters

To configure Shear Wave Elastography settings, select Utility--> Imaging--> ELASTO.

- Push Output (%) — The acoustic output of the shear wave push
- Track Output (%) — The acoustic output of the shear wave tracking pulse
- Transparency — The transparency of the shear wave image overlay
- Gain — Gain, as can be manipulated by the CF knob
- Width — ROI Width (values vary by probe)
- Vertical Size (cm) — ROI Vertical Height (values vary by probe)
- Center Depth (cm) — ROI Center Depth (values vary by probe)
- Color Map — Select shear wave Map 0 or shear wave Map 1 (SW0 or SW1) plus other ELASTO Maps (E1, E2, E3, E4, E-GRAY)
- Enter ELASTO DualView by Default — Check to select entering shear wave in DualView.

## ELASTO Imaging Parameters (continued)

Shear wave Color Bars:

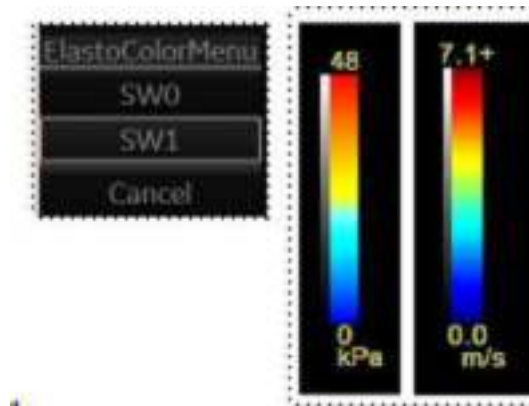

Figure 13-41. Shear wave Maps

The illustration shows the color maps for kiloPascals and velocity (meters per second). The images look the same, regardless of the unit (m/s or kPa). You can preset which color on the map represents stiffness (Red as Hard or Blue as Hard).

## General Imaging Parameters by Application/Probe/Feature

Select the Default Elasto Mode via Utility--> Imaging--> General.

You can specify shear wave to be the default setting by application by probe.

1. To specify a default probe per application, select Utility --> Imaging --> General.
2. Select the application.
3. Select the default probe from the pull-down menu.
4. Specify the Default Elasto setting:
  - Shear
  - Strain

### System Imaging Parameters

You can set the shear wave Display Units and specify which color on the shear wave map represents stiffness on the Utility--> System--> System Display--> Display page.

Set the Shear Elasto Display Units to either of the following settings:

- m/s (meters per second)
- kPa (kiloPascals)

Specify which color on the shear wave map represents stiffness:

- Red as Hard
- Blue as Hard

### Measurement Parameters

On the Utility--> Measure--> Advanced--> Abdominal page, set the following:

- Shear Measure Size — Sets the Default Diameter size of the shear wave measurement circle
- Shear Measure Fixed Size — Sets to ON to move the shear wave measurement circle with keeping the fixed size.
- Shear Calculation Method — Specify Mean (Mean averages of all of the shear wave points within the measurement circle) or Median (Median sorts, then selects the middle point of all points within the measurement circle)
- Shear Units Determine Folder — When On is specified, the unit specified pre-selects the measurement folder. If m/s is specified as the unit, then the Velocity folder is used; if kPa is specified as the unit, then the Stiffness folder is used

## Measurement Parameters (continued)

On the Utility--> Measure--> Advanced--> Small Parts page, specify the Calculation Method (Mean/Median).

- Shear Measure Size - Sets the Default Diameter size of the shear wave measurement circle.
- Shear Measure Fixed Size - Sets to ON to move the shear wave measurement circle with keeping the fixed size.
- Shear Calculation Method — Specify Mean (Mean averages all of the shear wave points within the measurement circle) or Median (Median sorts, then selects the middle point of all points within the measurement circle)

## Activating Shear Wave

To activate shear wave, press **ELASTO** and Touch Panel **Shear** controls. (1) To position and size the shear wave ROI, or to Start or return to Pre-Mode shear wave, touch the right-most **Trackball** control. (2) To save the Shear Elasto image, activate the P1 control.



Figure 13-42. Shear wave Operator Panel Controls

ELASTO -- When you activate ELASTO, the default Elasto Mode appears on the display and Touch Panel. If shear wave is preset as the default Elastography Mode, then Shear Wave Elastography mode appears; if Strain Elastography is set, then Strain Elastography mode appears.

## Shear Wave Display

Shear wave displays as follows while performing a measurement:

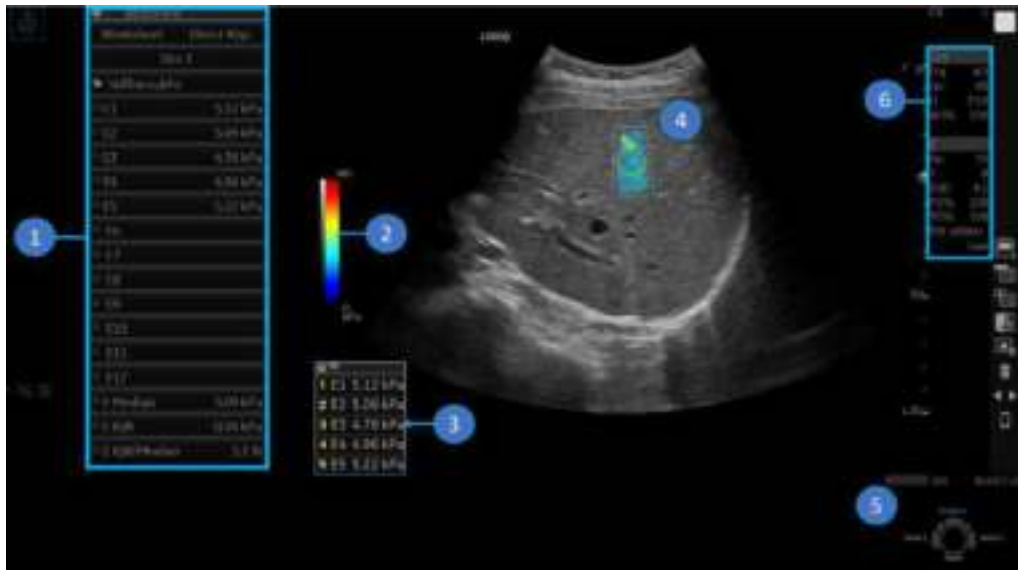

Figure 13-43. Shear wave Display with Measurement

1. Measurement Window
2. Shear wave Map
3. Measurement(s)
4. Shear wave ROI
5. Trackball Controls
6. Imaging Parameters
  - E = Elastography, Shear Wave
  - Gn = Gain
  - T = Transparency
  - SVD = Sample Volume Depth
  - PO% = Push Output Percentage
  - TO% = Track Output Percentage
  - f50-200Hz = Shear Wave Frequency range
  - Gen/Pen = General/Penetration.  
“Gen” appears when viewing an image where general settings were applied.  
“Pen” appears when viewing an image optimized for penetration.
  - “Clock” displays in Low Frame Rate Use cases.

Note: The measurements’ Median and Inter-Quartile Range (IQR) are displayed by default in the Measurement Window and Worksheet. The Caliper Area, Depth of Caliper Center, and average Quality within the measurement area can also be displayed on the Worksheet, along with how many measurements used for the median calculation.

## Selecting Measurements to Display

The following measurements are displayed by default, except those marked with an asterisk (\*):

- Shear Stiffness (kPa)
- Standard Deviation within the Shear Stiffness Measurement Area\*
- Shear Velocity (m/s)
- Standard Deviation within the Shear Velocity Measurement Area\*
- Measurement Area (cm<sup>2</sup>)\*
- Depth of Caliper Center (cm)\*
- Average Quality within the measurement area (%)\*

\*Items not displayed by default can be added via Utility--> Measure. See below.

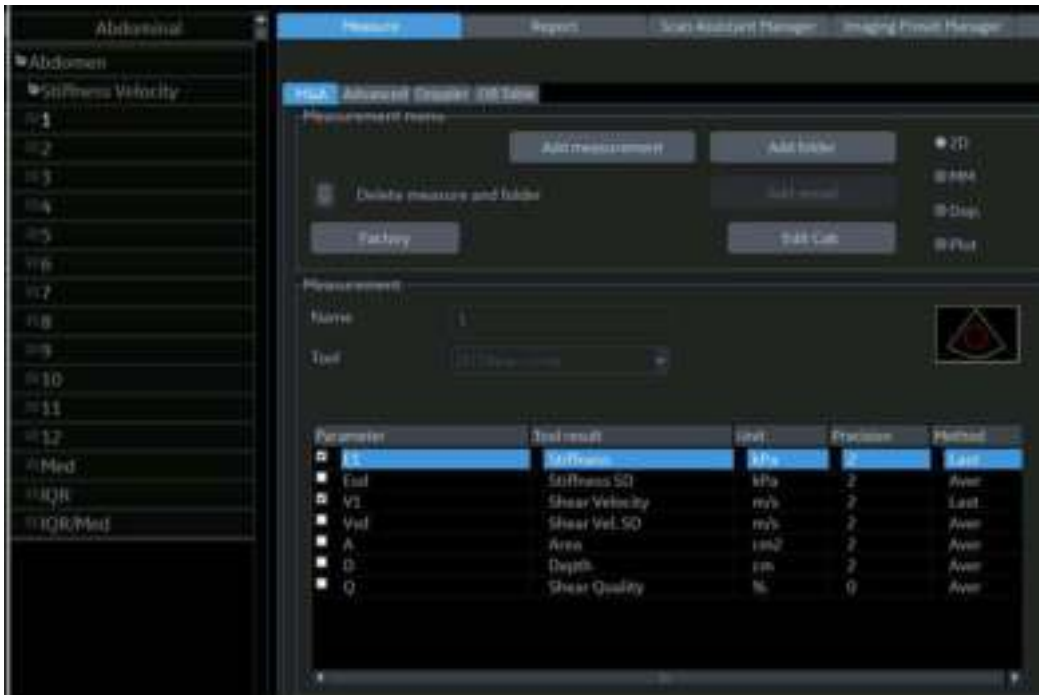

Figure 13-44. Configure Shear Wave Measurements

Selecting Measurements to Display (continued)

Checkmark the Shear Wave measurements to be displayed on the monitor and on the Extended Worksheet.

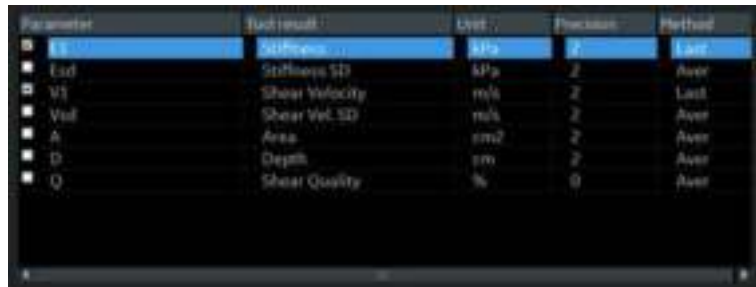

Figure 13-45. Selecting Default Shear Wave Measurements



Figure 13-46. Shear Wave Measurement Results Window

Shear Elastic (SWe1)		Stiffness	Velocity
Med		2.26 kPa	0.87 m/s
IQR		0.08 kPa	0.03 m/s
IQR/Med		3.4 %	3.7 %
N		8	8

	Stiffness	Stiffness SD	Velocity	Velocity SD	Area	Depth	Quality
1	2.34 kPa	0.23 kPa	0.88 m/s	0.28 m/s	0.96 cm <sup>2</sup>	4.86 cm	3 %
2	2.26 kPa	0.21 kPa	0.87 m/s	0.27 m/s	1.86 cm <sup>2</sup>	4.50 cm	3 %
3	1.98 kPa	0.12 kPa	0.83 m/s	0.20 m/s	1.03 cm <sup>2</sup>	6.33 cm	3 %
4	2.24 kPa	0.18 kPa	0.88 m/s	0.24 m/s	2.04 cm <sup>2</sup>	3.82 cm	3 %
5	2.49 kPa	0.25 kPa	0.91 m/s	0.27 m/s	0.72 cm <sup>2</sup>	4.85 cm	4 %
6	2.25 kPa	0.25 kPa	0.87 m/s	0.29 m/s	1.47 cm <sup>2</sup>	4.35 cm	3 %
7							
8							

Figure 13-47. Shear Wave Extended Worksheet



## Shear Wave Quality Indicator

The Shear Wave Quality Indicator displays the reliability of the Shear Wave image. A Quality value is computed for every pixel of the Shear Wave image and displayed as an image in a color-coded ROI. Locations with higher quality values have more reliable Shear Wave data.

### To View the Shear Wave Quality Image

The Quality Image can only be displayed in Dual Mode. It can be turned on and off using the Quality button on the Shear Elasto page on the Touch Panel.

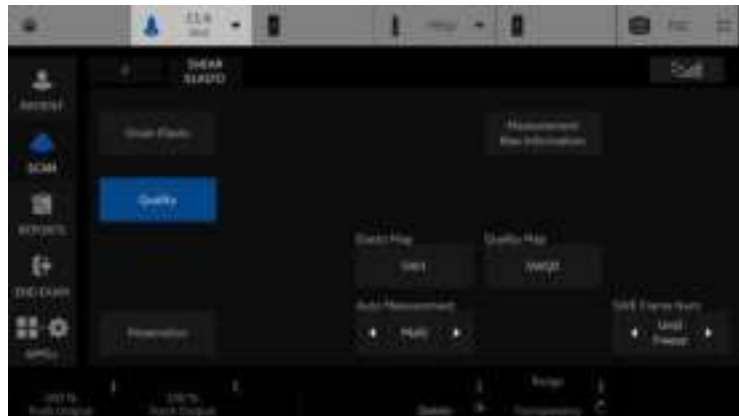

Figure 13-48. Quality Image Button

**NOTE:** You must be in Elasto Dual Mode to select the Quality button.

### To View the Shear Wave Quality Image (continued)

When the Quality Image display is turned on, the Quality Image is displayed on the left and the Shear Elasto image on the right.

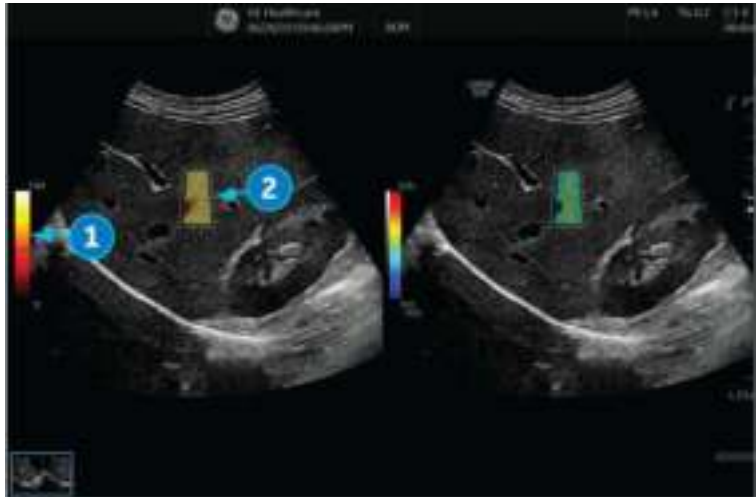

Figure 13-49. Shear Wave Display with Quality Image Enabled

1. Color Bar for Quality Image
2. Quality Image

The Color Bar on the left of the Quality Image shows the quality value corresponding to the colors in the Quality Image. Low quality is indicated by the colors at the bottom of the bar, and high quality by colors at the top.

### Quality Map

There are two Quality Maps available to choose from on the Shear Elasto screen (under Quality Map), each with a specific color range:

- SWQ0 - Black/red/orange/yellow/white (low to high quality)
- SWQ1 - Red/orange/yellow/green (low to high quality)

## **Elements of a good Shear Wave image**

Elements of a good shear wave image contain the following:

- Good contact
- ROI placed in the middle of image
- Gain at or near factory default
- Uniform color fill-in
- Homogeneous color pattern

## Shear Wave Touch Panel

Table 13-33: Shear wave elastography Touch Panel Parameters

Preset Parameter	Description
Strain or Shear Elasto	Toggle touch key between Strain and shear wave elastography.
Measurement Bias Information	Press to bring up measurement bias information.
Quality	Press the Quality button to open the Quality Indicator screen (while in Dual Mode).
Phantom	Press the phantom button to get good performance when measuring stiff, motion-free phantoms. The 049A phantom is recommended. For more information, refer to the CIRS website at <a href="http://www.cirsinc.com/products/all/74/elasticity-qa-phantoms/?details=specs">http://www.cirsinc.com/products/all/74/elasticity-qa-phantoms/?details=specs</a> .
Penetration	Press Penetration for instances measuring especially hard tissue (fibrotic or cirrhotic livers or technically difficult tissue in general).
Map	Shear wave Color Map.
Push Output	The acoustic output of the shear wave push.
Track Output	The acoustic output of the shear wave tracking pulse.
Range	Min/Max Velocity, or Stiffness displayed.
Transparency	The transparency of the shear wave image overlay.

Measurement Bias Information Tables

The Measurement Bias Information tables display the bias and precision percentage at different spatial resolutions (Bias/Precision vs Object Size, in millimeters) and at incremental depths (Bias/Precision vs Depth, in centimeters) for each shear wave probe.



Figure 13-50. C1-6-D/C1-6VN-D Measurement Bias Information (Velocity on the left and Stiffness on the right)

Measurement Bias Information Tables (continued)



Figure 13-51. IC5-9-D Measurement Bias Information (Velocity on the left and Stiffness on the right)

Measurement Bias Information Tables (continued)



Figure 13-52. ML6-15-D Measurement Bias Information (Velocity on the left and Stiffness on the right)



Figure 13-53. L3-12-D Measurement Bias Information (Velocity on the left and Stiffness on the right)

Measurement Bias Information Tables (continued)



Figure 13-54. 9L-D Measurement Bias Information (Velocity on the left and Stiffness on the right)

Speed Ranges and Accuracy are shown at the top of the Bias/Precision vs Object Size tables.



## Using Shear Wave (SW)

There are three shear wave states:

- Pre-shear wave acquisition  
Pre-shear wave acquisition is an intermediate mode between B-Mode and shear wave acquisition. During Pre-mode, the previous B-Mode imaging mode is still active.

*NOTE:*

*You cannot store images in Pre-Mode.*

- Shear wave acquisition  
Pressing the "Start" set key initiates SW acquisition.
- Post-shear wave acquisition (Freeze)  
The system displays the acquired SW image and background B-Mode image. The User can cycle through the acquired frames, perform measurements, and annotate the image.

SW images can be stored in both raw data and DICOM format.

Table 13-34: Using Shear wave

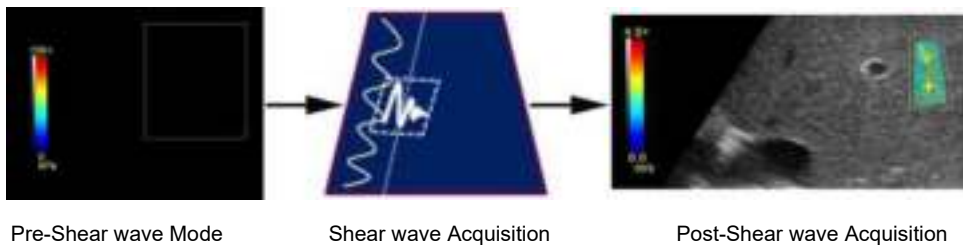

## Typical Exam Protocol (Liver)

A recommended shear wave elastography protocol to scan the liver is,

1. Image the right lobe of the liver intercostally in Pre-shear wave Mode.
2. Position and size the ROI.



### HINTS

The smaller the ROI, the faster the Frame Rate.

3. Instruct the patient that during the exam they can mostly breathe normally. However, advise the patient that they will need to suspend their breathing mid breath so that you can obtain an optimum image while performing the scan.
4. Adjust ROI as needed, avoiding vessels and fluid-filled structures. It is advisable to avoid rib shadows whenever possible.
5. Start the shear wave acquisition.
6. Freeze the image when desired frame is obtained.
7. Perform the measurement. The system prompts you through the measurement.
8. The system will auto sequence the measurements and walk you through all of the measurements (Abdominal Application Preset), if preset.

### NOTE:

*For Breast measurements, users typically take single measurements to measure the lesion once. Or, users can perform a ratio of two different tissues (one of the lesion and non-lesion tissue).*

9. Repeat steps 3 through 9 for the remaining samples.
10. Typically, users obtain ten (10) samples.

## Typical Exam Protocol (Liver) (continued)

11. Once measurements are complete, you can elect to add another site to the exam. To add another site, press **Add Site** on the Touch Panel. Select **Enter Site Name** to add the name for the new site.



Figure 13-55. Add Additional Shear Wave Site and Enter Site Name

**NOTE:** *If you no longer need the added site, you can select to delete the site via **Delete Site** on the Touch Panel.*

12. Once measurements for all sites are complete, select Summary on the Touch Panel to view saved measurements.



### CAUTION

Excessive manual compression of the underlying tissue with the probe can lead to biased shear wave measurements.

### Shear Wave Measurements

The higher the velocity, the stiffer the tissue.

#### Types of Shear Wave Measurements

There are two types of measurement units for quantifying stiffness:

- Velocity (meters per second)
- Stiffness (kiloPascals)

Measurement used to quantify stiffness: Shear wave imaging measures the velocity of shear waves generated by acoustic radiation force impulse in tissue. The velocity, in units of meters per second (m/s), can be converted to Young's Modulus (stiffness), in units of kiloPascals (kPa), under simplifying assumptions. Velocity or stiffness can be used to quantify the local tissue elasticity.

**NOTE:** *Acoustic radiation force is generated by a transfer of momentum from an acoustic wave to the medium through which it is propagating, caused by absorption and scattering in soft tissue. Impulsive application of focused acoustic beams in tissue can generate shear waves which propagate away from the focal region of the beam.*



#### CAUTION

Tissue inhomogeneities and other factors may bias shear wave measurements.

#### Measurement Analysis

To take shear wave measurements, typically users get ten (10) samples.

1. After you have acquired the desired image, avoiding vessels and fluid-filled structures, press Freeze.
2. Press Measure. Select the measurement (Stiffness or Velocity) unless preset to "Shear Units Determine Folder" is turned on.

**NOTE:** *This step only needs to be done in the Breast Small Parts Application Preset and is not needed in Abdomen.*

## Measurement Analysis (continued)

3. Perform the measurement. The system prompts you through the measurement.
  - a. Position the first caliper at the desired location on the ROI. Place the first control point and press Set on the Trackball control.  
An ROI ellipse appears and a second caliper.
  - b. Adjust the size of the ROI. Adjust ellipse and place the last control point.

**NOTE:** *This step only needs to be done in the Breast Small Parts Application Preset and is not needed in Abdomen.*

4. Repeat the scan and measurement. The system will auto sequence the measurements and walk you through all of the measurements, if preset.
5. Measurements are transferred to the Worksheet.

**NOTE:** *The measurements' Median and Inter-Quartile Range (IQR) are displayed by default in the Measurement Window and Worksheet. The Caliper Area, Depth of Caliper Center, and average Quality Percent within the caliper, and Standard Deviation within the caliper can also be displayed by going to Utility--> Measure, as shown in Figure 13-44 on page 13-119.*

Shear Wave Worksheets

There are two types of Worksheets (Overall and Extended).

Shear Elasto / uGAP [ Site1 ]				
Name	Stiffness	Velocity	Attenuation Coefficient	Attenuation Rate
Med	2.26 kPa	0.87 m/s	0.50 dB/cm/MHz	Site1
IQR	0.08 kPa	0.01 m/s	0.02 dB/cm/MHz	
IQR/Med	3.4 %	1.7 %	3.7 %	
N	6	6	5	
1	2.34 kPa	0.88 m/s	0.49 dB/cm/MHz	
2	2.26 kPa	0.87 m/s	0.50 dB/cm/MHz	
3	1.98 kPa	0.81 m/s	0.51 dB/cm/MHz	
4	2.24 kPa	0.86 m/s	0.51 dB/cm/MHz	
5	2.49 kPa	0.91 m/s	0.49 dB/cm/MHz	
6	2.25 kPa	0.87 m/s		
7				
8				

Figure 13-56. Shear Wave Overall Worksheet

Shear Elasto [ Site1 ]							
Med	Stiffness	Velocity					
Med	2.26 kPa	0.87 m/s					
IQR	0.08 kPa	0.01 m/s					
IQR/Med	3.4 %	1.7 %					
N	6	6					
1	Stiffness	Stiffness SD	Velocity	Velocity SD	Area	Depth	Quality
1	2.34 kPa	0.23 kPa	0.88 m/s	0.28 m/s	0.96 cm <sup>2</sup>	4.86 cm	3 %
2	2.26 kPa	0.21 kPa	0.87 m/s	0.27 m/s	1.66 cm <sup>2</sup>	4.60 cm	3 %
3	1.98 kPa	0.12 kPa	0.81 m/s	0.20 m/s	1.03 cm <sup>2</sup>	6.15 cm	3 %
4	2.24 kPa	0.18 kPa	0.86 m/s	0.24 m/s	2.04 cm <sup>2</sup>	3.82 cm	3 %
5	2.49 kPa	0.25 kPa	0.91 m/s	0.27 m/s	0.72 cm <sup>2</sup>	4.85 cm	4 %
6	2.25 kPa	0.25 kPa	0.87 m/s	0.29 m/s	1.47 cm <sup>2</sup>	4.35 cm	3 %
7							
8							

Figure 13-57. Shear Wave Extended Worksheet

### Deleting or Excluding Measurements from the Worksheet

Measurements can be deleted from the Extended Worksheet. Once a measurement has been deleted, it cannot be re-added. Deleted measurements show as a blank.

*NOTE: You can also choose to delete all Shear Wave measurements, without deleting non-Shear Wave measurements from the worksheet.*

Measurements can also be excluded from the Extended Worksheet -- and added back in at a later time. Excluded measurements show as a blank.

To delete/exclude a measurement,

1. Highlight the measurement you want to delete/exclude.
2. Right click on the Extended Worksheet to bring up the Delete/Excluded pop-up menu.

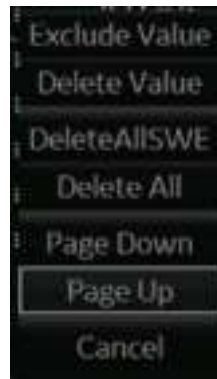

3. Select the appropriate action.

### Deleting or Excluding Measurements from the Worksheet (continued)

In the example below, measurements from line 4 with the blue rectangle have been excluded (and can be added back in); and measurements from line 2 have been deleted (and cannot be added back in).



The screenshot shows a data table with the following columns: Flow, Velocity, Area, Depth, and Quality. The table contains data for lines 1 through 12. Line 2 is highlighted in blue, indicating it has been deleted. Line 4 is also highlighted in blue, indicating it has been excluded. The data for line 4 is as follows:

Flow	Velocity	Area	Depth	Quality
2.41 m/s	0.90 m/s	3.23 cm <sup>2</sup>	3.58 cm	27 %

Figure 13-58. Example showing both deleted and excluded measurements



## Shear Wave Graph

The Shear Wave Graph displays an average of Shear Wave stiffness and velocity measurements for a patient over a period of time. To see the Shear Wave Graph, select **Worksheet** and then **Graph** on the touch panel.

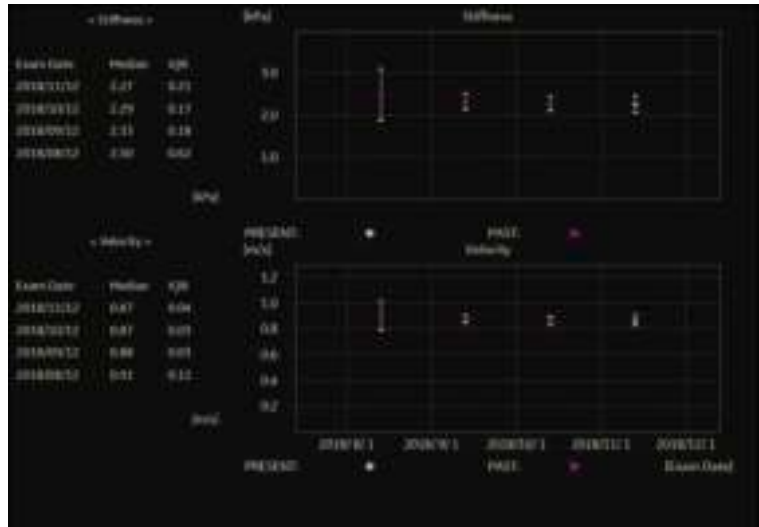

Figure 13-59. Shear Wave Graph

Measurement Information

Table 13-35: Shear Wave Speed Variation and Precision with Depth

Measurement	Units	Useful Range	Accuracy	Limitations or Conditions
Velocity	m/s	Shear wave ROI	Absolute range $\leq 0.5$ m/s or relative range $\leq 15\%$ , whichever is greater, for C1-6-D and C1-6VN-D. Absolute range $\leq 0.5$ m/s or relative range $\leq 10\%$ , whichever is greater, for all other probes with shear wave elastography.	Normalized SD less than or equal to 5% for multiple repeated measurements over the range of depths for which measurements can be made, limited by shear wave penetration.

The formula for Stiffness:  $E = 3 * \rho * c^2$

Where E = Young's modulus of tissue

$\rho$  = density of tissue (assumed to be 1 g/cc)

c = shear wave speed in m/s

**NOTE:** *The conversion from shear wave speed (m/s) to Young's modulus is done under the assumption that the underlying material in which the shear wave propagates is linear, isotropic, incompressible, and homogenous.*

**NOTE:** *Relative Range = (Absolute Range / Actual Velocity)*

**NOTE:** *Normalized SD = (SD) / Average Velocity*



**CAUTION**

The values for shear wave speed and tissue modulus are relative indices intended only for the purpose of comparison with other measurements performed using the system. Absolute values for these measurements may vary among different measurement devices. Use Shear Wave Elastography as a complement to other techniques when making a diagnostic decision.

## **Shear Wave Elastography Calculation**

An Interquartile Range/Median (IQR/Median) Shear Wave Elastography ratio has been added. You can use this ratio to evaluate the reliability of Shear Wave measurements in the liver. This ratio is displayed as a percentage (%) on the worksheet (Display Accuracy to 1 decimal place). Values <30% are recommended for a reliable Shear Wave Liver exam.

*NOTE: The IQR/Median ratio is calculated automatically for both Velocity and Stiffness and displayed by default to the user.*

## Scanning Hints



### HINTS

You may find the following recommendations helpful when performing a Liver shear wave scan:

- Locate right lobe of liver intercostally.
- Place the ROI away from the capsule in an area free of vessels and fluid-filled structures.
- Suspend Patient breathing in mid-breath during the scan
- Position the ROI between 2-5 cm deep for an optimal shear wave scan

You may find the following recommendations helpful when performing a Breast shear wave scan:

- Locate lesion
- Place lesion in center of ROI, including a sufficient amount of the surrounding tissue
- Only compress slightly, if necessary (compression changes the elastic tissue properties).

To increase frame rate:

- Reduce ROI Width
- Turn off Penetration Mode
- Reduce Push Output

To increase penetration:

- Turn on Penetration Mode
- Keep Push and Track Output at 100%
- Place ROI away from edges of image

To reduce artifacts:

- Minimize motion during acquisition
- Ensure there are no vessels within the ROI or near the left or right edge of the ROI. It is advisable to avoid rib shadows whenever possible.
- Keep ROI at least 1cm away from the liver capsule.

# Ultrasound-Guided Attenuation Parameter (UGAP) Option

## Overview

Ultrasound-Guided Attenuation Parameter (UGAP) measures the attenuation value (i.e. attenuation coefficient [dB/cm/MHz] or attenuation rate [dB/m]) in the liver to evaluate diffuse liver disease. There are four visualizations: B Ref, Color Ref, B/Color Dual, and Qual./Att. Dual. All visualizations measure a representative attenuation value. Color Ref, B/Color Ref, and Qual./Att. Dual measure a representative attenuation value in 2D color map and dual display of B-Mode and 2D color map, respectively.

## UGAP Availability

UGAP is available on the C1-6-D and C1-6VN-D probes in the Abdomen (ABD) application.

### Activation

To activate UGAP, select the appropriate probe Abdominal application, then press BT1 (configured as UGAP). UGAP parameters are displayed as “U” (Frequency and Acoustic Output Percent) in Simple Mode. Unit of attenuation coefficient values are displayed as dB/cm/MHz.



Figure 13-60. UGAP Display

## Measurement and Worksheet

### Measure the Coefficient Value

1. Scan to get the appropriate view to measure.
2. Press Start (right Set key).

**NOTE:** *The Measurement ROI can be moved using the Trackball; more than one ROI can be placed in one frame. Avoid structures such as vessels to obtain UGAP measurement.*



Figure 13-61. UGAP Study

Measurements can be performed afterwards using CINE or recalled data where multiple frames can be selected to measure attenuation coefficients.

### Add a New Site

Once measurements are complete, you can elect to add another site to the exam. To add another site:

1. Press the **Measurement** button on the console.
2. Select **Add Site** on the Touch Panel.
3. Select **Enter Site Name** to add the name for the new site.



Figure 13-62. Add Additional Shear Wave Site and Enter Site Name

**NOTE:** *If you no longer need the added site, you can select to delete the site via **Delete Site** on the Touch Panel.*



## Summary and Overall Worksheets

Measurements are transferred to the Summary and Overall Worksheets.

Shear Elasto / UGAP [Site1]				
Name	Stiffness	Velocity	Attenuation Coefficient	Attenuation Rate
	Site1	Site1	Site1	Site1
Med	2.26 kPa	0.87 m/s	0.50 dB/cm/MHz	
IQR	0.08 kPa	0.01 m/s	0.02 dB/cm/MHz	
IQR/Med	3.4 %	1.7 %	3.7 %	
N	6	6	5	
1	2.34 kPa	0.88 m/s	0.49 dB/cm/MHz	
2	2.26 kPa	0.87 m/s	0.50 dB/cm/MHz	
3	1.98 kPa	0.81 m/s	0.51 dB/cm/MHz	
4	2.24 kPa	0.86 m/s	0.51 dB/cm/MHz	
5	2.49 kPa	0.91 m/s	0.49 dB/cm/MHz	
6	2.25 kPa	0.87 m/s		
7				
8				

Figure 13-63. UGAP Summary Worksheet

Parameter	Value	m1	m2	m3	m4	m5	m6	Method
B Mode Measurements								
Attenuation Coef. (dB/cm/MHz)								
Site1								
A1	0.60	0.60						Last
A2	0.64	0.64						Last
A3	0.57	0.57						Last
A4	0.37	0.37						Last
A5	0.59	0.59						Last
Med	0.59							
IQR	0.03							
IQR/Med	3.4 %							
N	3							

Figure 13-64. UGAP Overall Worksheet

Attenuation Coefficients are displayed (A1, A2, A3), Median, IQR, IQR/Median, and number of measurements (N).

## 2D Color Map

2D color map is available on Color Ref, B/Color Dual and Qual./Att. Dual. There are two 2D color maps: Attenuation Map and Quality Map. Attenuation Map provides the distribution of attenuation values. Quality Map provides the distribution of the signal quality to support ROI placement.

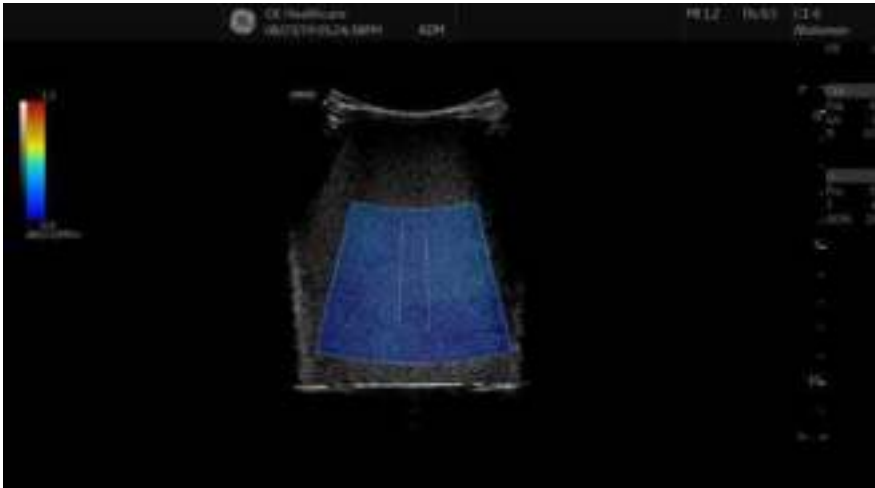

Figure 13-65. Attenuation Map

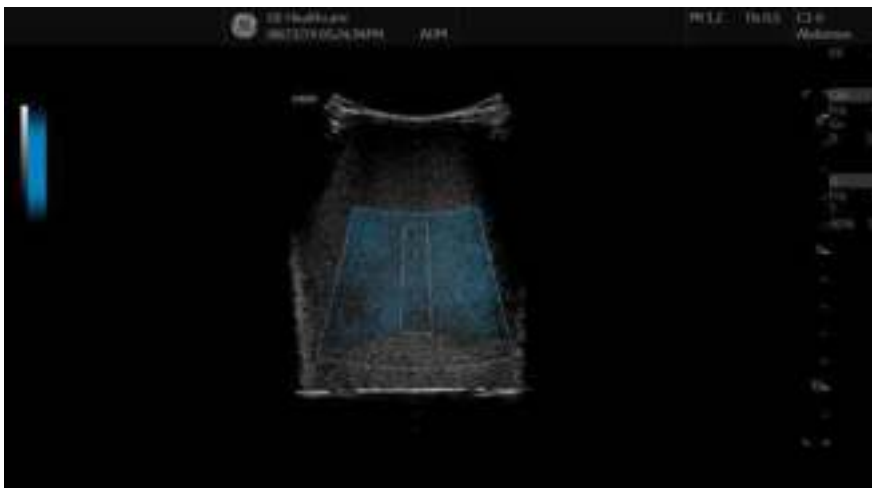

Figure 13-66. Quality Map

# Continuous Wave Doppler (CWD)

## **Overview**

There are two CW Doppler operating modes: Steerable and Non-Imaging.

Allows examination of blood flow data all along the Doppler Mode cursor rather than from any specific depth. Gather samples along the entire Doppler beam for rapid scanning of the heart. Range gated CW allows information to be gathered at higher velocities.

## **Steerable**

Allows viewing of the B-Mode image to position the Doppler cursor to the area of interest while viewing the Doppler spectrum and listening to the Doppler Audio signal.

## **Non-Imaging**

Provides only Doppler Spectrum and Audio for ascending/ descending aortic arch, other hard-to-get-to spaces or higher velocities.

### Activating CW Doppler

To activate CW Doppler Mode, press **CW**.

The Steerable CW Doppler spectrum displays along with the B-Mode image. The cursor changes to a Doppler cursor.

You can now position and size the sample volume gate to get a velocity. Use Doppler Audio to listen for when the sample volume gate is positioned over an area of flow.

**Update** toggles between real time B-Mode with Doppler Mode and real time spectral display.

### Exiting CW Doppler

To exit CW Doppler Mode, press **CW**.

# Tissue Velocity Imaging (TVI)

## Intended Use

Tissue Velocity Imaging (TVI) calculates and color-codes the velocities in tissue. The tissue velocity information is acquired by sampling of tissue Doppler velocity values at discrete points. The information is stored in a combined format with gray scale imaging during one or several cardiac cycles with high temporal resolution.



CAUTION

TVI can be activated on Cardiac Sector and TEE probes only.

## Activating TVI

1. Select the desired probe.
2. While in B-Mode, press the **TVI** key located above the PDI control on the Touch Panel. The TVI image and Touch Panel display.

**NOTE:** *To set up TVI on the Imaging Preset page, go to Utility--> Imaging--> TVI.*

### Optimizing TVI

The use of preset gives optimum performance with minimum adjustment. If necessary, the following controls can be adjusted to further optimize the TVI display:

- To reduce quantification noise (variance), the Nyquist limit should be as low as possible, without creating aliasing. To reduce the Nyquist limit: Reduce the Scale value.

*NOTE: The Scale value also affects the frame rate. There is a trade off between the frame rate and quantification noise.*

- TVI provides velocity information only in the beam direction. The apical view typically provides the best window since the beams are then approximately aligned to the longitudinal direction of the myocardium (except near the apex). To obtain radial or circumferential tissue velocities, a parasternal view must be used. However, from this window the beam cannot be aligned to the muscle for all the parts of the ventricle.

## TVI and TVD

### TVI

You can preset all parameters in Utility -> Imaging ->TVI.

The TVI parameters function the same as those described in the Color Flow specific section. The only differences would be that it pertains to tissue velocity rather than the color flow image. In the table below any TVI parameter or parameter specifics are noted.

Table 13-36: TVI Parameters

Control	Details
<b>Visible</b> Description Adjusting Values	In LIVE/Freeze/Archive, you can display TVI Color with TVI. Select <b>Visible</b> on the Touch Panel. On or Off.
<b>Invert</b>	Color Invert
<b>Baseline</b>	Adjusts the Baseline.
<b>Angle Steer</b>	Steers the angle
<b>Line Density</b>	Optimizes B-Mode frame rate or spatial resolution for the best possible image.
<b>Map</b>	Values: TV1 and TV2.
<b>Frame Average</b>	Averages color frames.
<b>Threshold</b>	High values display more color. Low values limit the color to lower tissue echo (Opposite of Threshold in Color Flow Mode).
<b>Transparency Map</b>	Values 0-5.
<b>Spatial Filter</b>	Values 0 and 1.
<b>Duplex</b>	Allows two modes to be active at the same time.
<b>TVI Gain</b>	Control color transparency. High values display more color; low values display more tissue. This parameter is assigned to the Color Gain control.

### TVD

While in TVI, press **PW** to activate Tissue Velocity Doppler.

You can preset all parameters in Utility -> Imaging ->TVD.

# Quantitative Analysis (QAnalysis)

## Overview

Quantitative Analysis is available for the following CINE loops obtained in the following modes: Tissue Velocity Imaging, Color Flow Mode, and Power Doppler Mode. All of the Quantitative Analysis modes operate similarly, with some variation.

The Touch Panel may be slightly different, for example; and the type of information you quantify varies by mode as well. Please see a summary of each mode below; followed by general instructions on how to perform Quantitative Analysis.

## Quantitative Flow Analysis

Provide tools for semi-quantitative assessment of inflammation in joints and vascularization in tumors.

*NOTE: There is frame number limitation for color quantification as 400 frames.*



## Statistics

The LOGIQ Totus extracts various statistics from the image data within each sample area. The statistics depends on the imaging mode in use.

Press **Statistics** to enable/disable display of statistics of the frame or loop. The statistics are shown only when the loop is stopped.

- Ratio: Ratio of Color (Power) Doppler pixels over total sample area area.
- Area (mm<sup>2</sup>): The size of sample area
- Max Ratio/Time of Max Ratio: Maximum Ratio of Color (Power) Doppler pixels in each sample area, and which frame that occurs in.
- Min Ratio/Time of Min Ratio: Minimum Ratio of Color (Power) Doppler pixels in each sample area, and which frame that occurs in.

Quantification supports two different statistical display formats: Short Form and Long Form.

Statistics (continued)

- Short Form: Ratio and Area.

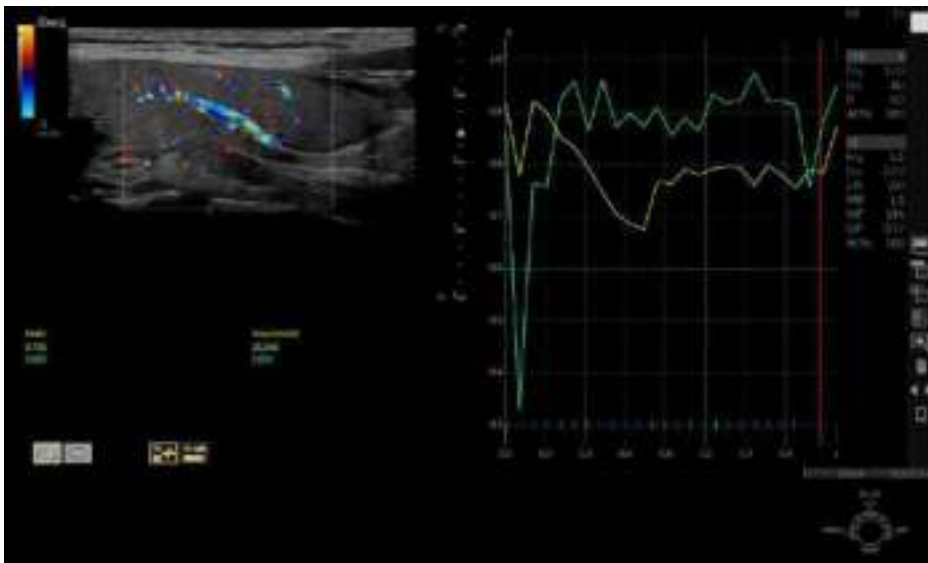

Figure 13-67. Color Flow Mode Short Form - Example

- Long Form: Ratio, Area, Max Ratio/Time of Max Ratio, Min Ratio/Time of Min Ratio



Figure 13-68. Color Flow Mode Long Form - Example

## QAnalysis - Tissue Velocity Imaging

Multiple Time -Motion trace display from selected points in the myocardium.

### QAnalysis Screen Description

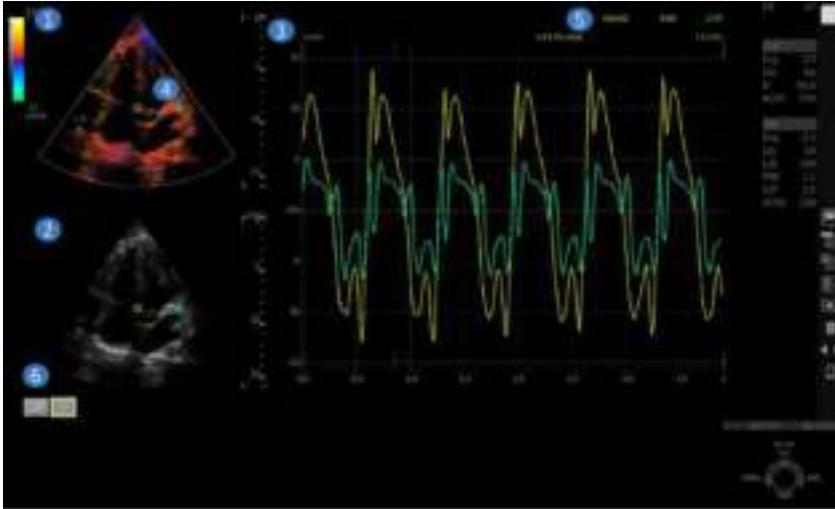

Figure 13-69. Q-Analysis Screen

Table 13-37: QAnalysis Screen Description

1.	TVI Cineloop Window Sample Area: Indicates sampling position of the velocity. The sample area is color-coded: the first sample area is yellow, the second green, etc.
2.	B Cineloop Window Sample Area: Indicates sampling position of the velocity. The sample area is color-coded: the first sample area is yellow, the second green, etc.
3.	Analysis Window. <ul style="list-style-type: none"> <li>• Y axis: Velocity scale (cm/s)</li> <li>• X axis: Time(s)</li> <li>• ECG</li> <li>• Time at cursor position.</li> <li>• Velocity at Cursor position.</li> <li>• Velocity at frame marker position (Color coded)</li> </ul>
4.	Sample Area
5.	Time at cursor position and velocity at cursor position. Position the pointer cursor over the analysis window.
6.	Sample Area Tools. <ul style="list-style-type: none"> <li>• Pencil Icon: Creates a sample area based on freehand drawing.</li> <li>• Shape Icon: Creates a sample area with a pre-defined circular/ellipse shape.</li> </ul>

### QAnalysis Plot Control

The following controls are user configurable presets which are configurable through the pull-down menu in QAnalysis mode. When using the pull-down menu:

1. Place the cursor over the analysis window and press the left **Set** key. The system menu displays at the cursor position.
2. Select the appropriate parameter.

### To switch trace (Analysis signal)

**Analysis Signal** toggles the trace display between velocity, displacement or gray scale intensity curves.

1. Position the cursor over the plot window and select Analysis Signal from the pull-down menu.
2. Select **Velocity**, **Displacement** or **Grayscale Intensity** as necessary.

### Vertical Unit

*NOTE: Vertical Unit is only available when Grayscale intensity is selected in Analysis Signal.*

When analyzing the data, the Y-axis can be set to display either logarithmic scale (dB) or linear, acoustic units (AU).

To toggle between dB and acoustical display units for the Y-axis.

- **dB**—The traditional log compressed B-Mode data is used to calculate the time-intensity curve values.
- **Acoustic**—The system reverse the log compression function to provide un-log compressed data for the Qanalysis.

### Drift Compensation

**Drift Compensation** compensates drifting of Tissue Tracking curves by either resetting the curve to zero at the tracking start point (cycle resetting) or by linear compensation throughout the cycle (linear compensation).

*NOTE: When Displacement is chosen by AnalysisSignal, Drift Compensation is active.*

*NOTE: Drift Compensation is inactive if ECG data cannot be acquired.*

## Trace Measurements

### Gradient

Select Gradient entry on the pull-down menu that is obtained when the cursor is placed over the plot.

Gradient is displayed on the screen instead of velocity. The gradient calculates from 7 points (includes previous and next frames).

### Max Gradient

Displays the time and gradient that becomes the maximum gradient between the CINE start and end frame.

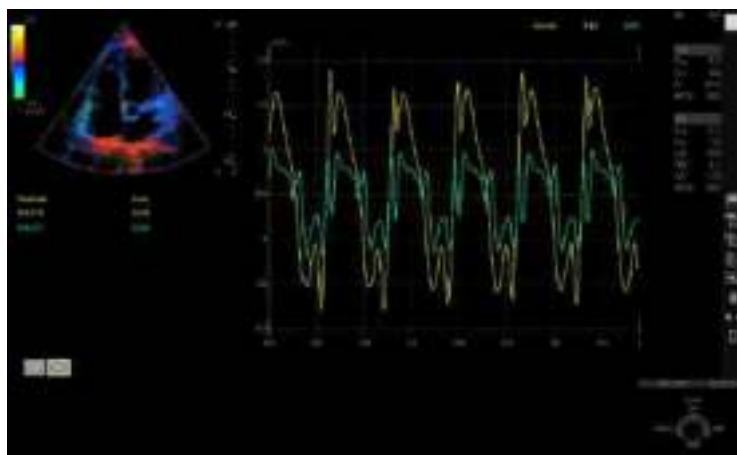

Figure 13-70. Max Gradient

### Selecting QAnalysis Image Range

A range of frames is selected for the QAnalysis in Cine mode (before accessing QAnalysis). Only the frames in this range are used for the QAnalysis.

If a range is not selected prior to accessing the QAnalysis, the system uses the default Cine start and end frames as the default start and stop frames.

1. The first frame in the analysis series is selected by adjusting the **Start Frame** control to the desired frame  
OR  
using the **Trackball** or the **Frame by Frame** control to select the desired first frame and then selecting the **Start Frame** control.
2. The last frame in the analysis series is selected by adjusting the CINE **End Frame** control to the desired frame  
OR  
using the **Trackball** or the **Frame by Frame** control to select the desired end frame and then selecting the **End Frame** control.

### Activating QAnalysis

1. Scan and Freeze the patient in the desired live mode or recall a desired cine loop from the stored images.

*NOTE: QAnalysis is only available when the system is in CINE mode.*

*NOTE: Images from the current scan session acquired in the desired analysis mode (already in CINE) or from a saved image loop can be used for QAnalysis.*

2. **QAnalysis** displays on the Cine Touch Panel.
3. Select **QAnalysis**. The QAnalysis screen and Touch Panel displays. To toggle the trackball function between QA and Scroll, press the top **Trackball** key.

## Common QAnalysis Function

### Display the System Menu

Place the cursor to the desired position and press the left **Set** key. The system menu displays at the cursor position.

The system menu is dependent on the area which you place the cursor.

### Generating a Trace

Up to eight traces can be generated.

### About the sample area

The sample area can be in three different states:

- **Free sample area:** freely moving sample area (QA cursor) before anchoring.

*NOTE: The free sample area disappears when the QA cursor is moved over a static anchored frame.*

- **Static sample area:** the free sample area is anchored by pressing Set.
- **Dynamic anchored sample area:** the sample area is anchored in two or more frames (see Manual tracking below). In these particular frames, the sample area is displayed with an anchor. The sample area moves smoothly between the anchored positions when playing/scrolling the cineloop.

### Trace from a pre-defined sample area

1. If the trackball assignment is not on QA, press the top **Trackball** key until QA highlights.
2. If necessary, select the sample area Ellipse sample area button (shape icon on the monitor display).
3. Move the cursor to one of the Cineloop windows using the **Trackball**.
4. Press **Set** to anchor the sample area.

In this frame, the sample area is marked with an anchor. If the cineloop has more than one heart cycle, a sample area will also be anchored in the corresponding frame in the next heart cycle.

The trace is updated accordingly in the Analysis window.

### Generating a Trace (continued)

#### Trace from freehand sample area

1. Select the Freehand sample area button (pencil icon on the monitor display).
2. Move the cursor to one of the Cineloop windows using the **Trackball**.
3. Press and hold down the **Set** key while drawing a sample area using the **Trackball**.
4. Release the **Set** key.

The sample area is automatically closed and the trace is updated accordingly in the Analysis window.

#### Manual tracking of the sample area (dynamic anchored sample area)

1. Place a sample area over a region of interest. Note the anatomical location of the sample area.
2. Scroll to a new frame using the **Trackball**.
3. Press the top **Trackball** key until the QA trackball assignment is selected.
4. Move the cursor to the sample area using the **Trackball**.
5. Press **Set**. The sample area is unanchored.
6. Drag the sample area to the corresponding anatomical location in the new frame.

When the sample area is anchored in more than one frame, linear interpolation is performed so that the sample area is smoothly moved between the anchored positions in the selected frames when running the cineloop.

7. Press the top **Trackball** key until the scroll trackball assignment is selected.
8. Using the **Trackball**, scroll through the cineloop and control that the sample area follows the moving anatomical structure.
9. Add anchored sample areas in several frames to obtain a more accurate displacement of the sample area.



## Generating a Trace (continued)

### Moving a dynamic anchored sample area

1. Press the top **Trackball** key until the scroll trackball assignment is selected.
2. Using the **Trackball**, browse through the cineloop to display one of the frames where the sample area was anchored.

*NOTE: In these frames, the sample area is marked with an anchor.*

3. Press the top **Trackball** key until the QA trackball assignment is selected.
4. Move the cursor to the sample area using the **Trackball**.
5. Press **Set**. The sample area is unanchored.
6. Drag the sample area to a new location.
7. Press **Set** to anchor the sample area to the new location.

If you want to move the sample area to the same depth, select **Move (same depth)** from the System Menu.

### Manipulating the Sample Area

Up to eight sample areas can be saved on the reference image, with the corresponding eight traces plotted simultaneously on the graph. Each sample area display has a different color, and its corresponding trace data is plotted using that same color.

Once eight sample areas have been saved, the system does not automatically generate an active sample area when the cursor is positioned over the displayed reference image.

The saved sample areas can be a mixture of elliptical and freehand sample areas.

When the user repositions a sample area, the old trace data is erased from the plot and the trace data for the new position replotted.

If the sample area position on the last frame of the selected image range is moved, the corresponding sample areas on all frames are repositioned to match the last frame.

The user shall also have the capability of setting separate sample area positions on different frames of the contrast images, and the system shall linearly interpolate the sample area positions for the frames in between the selected frames.

### Setting the default sample area shape

1. Select **Set sample area shape**. The Information Box displays.



Figure 13-71. Sample Area Information Box

2. Select Height, Width and Tilt angle.
3. Select **Set as default**. The current sample area size is set as the default for subsequent Ellipse sample areas.

## Sample Area Shapes

There are two different methods for determining the shapes of the sample area.

### **Ellipse sample area**

1. Select the ellipse icon (shape icon on the monitor display).
2. When the trackball positions the image display cursor over the reference image(s), an elliptical sample area is automatically generated and displays on the reference image(s).
3. The average velocity value inside the ellipse is calculated for every image in the image analysis range and plotted in the image display area.
4. The last generated or selected ellipse is considered the active sample area, and its trace plot automatically updates as the user repositions it on the reference image. Old traces are erased.
5. When scanning with an elliptical sample area, press **Set** to fix the sample area position and freeze its corresponding trace on the plot. A new active sample area is generated whose position is manipulated by the trackball and whose velocity curve traces will be plotted as before, while the previous sample area and trace remain fixed at the points they were saved at.

*NOTE: Elliptical sample areas can be positioned in any manner that keeps their center within the image boundaries. In the case that part of the sample area is outside the image boundary, only data from within the image boundary is used for calculating the mean velocity value.*

*NOTE: You can change the size of the Ellipse sample area by adjusting the Ellipse control.*

### **Freehand sample area**

1. Select Freehand icon (pencil icon on the monitor display).  
Use the **Trackball** to position the caliper on the reference image at the start point. Press **Set** to fix the start point.
2. While holding down the **Set** key, trace the outline of the desired sample area by moving the caliper with the **Trackball**.

### Reshaping a Sample Area

To reshape the sample area:

1. Position the cursor on the sample area to reshape and press the left **Set** key.
2. The sample area system menu displays. Select **Set sample area shape**.



Figure 13-72. Sample Area Information Box

3. Adjust Height, Width and Tilt angle.
4. Press **OK**. The selected sample area size changes.

### Labeling a Sample Area

The sample area label is used to identify data associated with the sample area when exporting.

1. Position the cursor on the sample area to label and press the left **Set** key.
2. The sample area system menu displays. Select **Label sample area**. The Label Dialog box displays.



Figure 13-73. Label Dialog Box

3. Enter a name for the sample area.
4. Select **OK**.

### Copy, move, and paste a Sample Area

To copy and paste the sample area,

1. Move the cursor over the sample area and press the left Set key. The system menu displays.
2. Select **Copy sample area**.
3. Move the cursor to the desired location for the copied sample area and press the left Set Key. The system menu displays.
4. Select **Paste sample area**.

To copy and move the sample area,

1. Move the cursor over the sample area and press the left Set key. The system menu displays.
2. Select **Copy & move**. Or if you want to move to the same depth as the original sample area, select **Copy & move (same depth)**.
3. Move the copied sample area using the **Trackball**. Press **Set** to fix the position.

### Deleting a Sample Area

Sample sample areas and their corresponding traces can be deleted using **Delete Sample Area**.

1. Select **Delete Sample Area**; a pull-down menu displays.



Figure 13-74. Delete Sample Area pull-down menu

2. Select **Current sample** to delete the currently active sample area.

Select **Delete all** to delete all currently set sample areas and all of their traces.

**NOTE:** *The corresponding traces for the deleted sample areas are erased from the plot.*

**NOTE:** *Deleting a sample area causes the sample areas to be deleted from all frames in the analysis loop.*

### QAnalysis Plot Control

**NOTE:** *Plot Control is available only with TVI and Elastography modes.*

The following controls are user configurable presets which are configurable through the pull-down menu in QAnalysis mode. When using the pull-down menu:

1. Place the cursor over the analysis window and press the left **Set** key. The system menu displays at the cursor position.
2. Select the appropriate parameter.

#### Vertical auto-scaling

The system can be configured to display the full unit range or a range according to the maximum and minimum values of the displayed trace(s) (auto-scaling function). In addition, the auto-scaling function can be set to be live update (updates while the sample area is moved) or delayed (updated when the sample area is anchored).

- **Delayed**—The system automatically rescale the vertical axis of the trace graph only when a new sample area is saved, to account for changing input dynamic range.
- **On**—The system automatically rescale the vertical axis of the trace graph every time the currently selected (active) sample area is moved.
- **Off**—Disable any automatic scaling of the vertical axis. There is user-defined system defaults on the system preset page for the fixed vertical scale to be used for the plot.



Figure 13-75. Vertical Autoscale Pop-up menu

## Line Style

- **Solid**—Setting the results in a plotted trace that does not display small boxes at the data points
- **Squares**—Setting the results in a plot where small squares are displayed at each data point, and the squares are linked together by lines.



Figure 13-76. Line style Pop-up menu

## Smoothing

The system can smooth the traces displayed by applying a filter over a defined time window. The type of filter available is depending on the analysis signal displayed.

1. Select **Smoothing**.

OR

Position the cursor over the analysis window and press the left **Set key**. The System menu is displayed at the cursor position. Select **Smoothing**.

*NOTE: When smoothing is turned on, it applies to all traces in the plot window.*

2. The smoothing filter list displays. Select the appropriate parameter.

## Horizontal Sweep

Horizontal Sweep allows you to increase or decrease the time interval over which to plot the analysis curve.

The default is the user selected image range. If the user has not yet selected a first and last frame, the first and last default frames from the displayed CINE loop are used.

### Zooming in the Analysis window

To zoom:

1. In the Analysis window, press and hold down the **Set** key while dragging the cursor to define the zooming area.
2. Release the **Set** key.

To unzoom:

1. Press the left **Set** key in the Analysis window. The system menu displays.
2. Select **Unzoom**.

### Disabling/Enabling the frame

*NOTE: Frame disable/enable is available only with Elastography, CF, and PDI modes.*

Frame disabling excludes the actual frame from the cineloop display.

### Disabling the frame from the frame marker

To disable One Frame:

1. Use the **Trackball** to move the cursor to the frame marker to disable.
2. Press **Set** to disable the frame.
3. The frame marker is changed from green to red to indicate the frame has been disabled.

*NOTE: The disabled frame is no longer displayed in the reference window when scrolling through CINE memory.*

### Disabling multi-frames from the frame marker

1. Use the trackball to move the cursor to the first frame marker to disable.
2. Press and hold down **Set**
3. Move the cursor with the Trackball to the last frame to be disabled and release Set.

The marker is turn red and the data from that frame is removed from the trace and any subsequent trace processing.



### Disabling a frame from the cineloop window

1. Use the trackball to move the cursor to the cineloop window.
2. Press the left **Set** key. The system menu displays.
3. Select **Disable frame**.

The current frame is disabled and the corresponding frame marker displays red.

### Disabling Frames - Auto

When the user enters Elasto Quantification, the useless frames are disabled automatically. The LOGIQ Totus uses Elastography Index value to find useless frame (low quality frames).

### Disabling ECG triggered frame (where available)

In a multi-cycle acquisition, the user may deselect all frames in all heart cycles but a selected one. This function can be used for example to select a particular systolic frame for each heart cycle.

1. Scroll through the cineloop to identify the cardiac phase to analyze or identify the cardiac phase on the ECG trace (where available).
2. Position the cursor on the ECG trace (where available) and press left **Set** key. The system menu displays.
3. Select **ECG triggering** (where available).

All frames in all heart cycles are disabled except for the selected and corresponding frames in the other heart cycles.

## Disabling/Enabling the frame (continued)

### To enable the frames

To re-enable all deleted frames:

1. Position the cursor on the Frame Marker line and press the left **Set** key. The system menu is displayed at the cursor position.
2. Select **Enable all frames**.
3. All disabled frames are re-enabled.

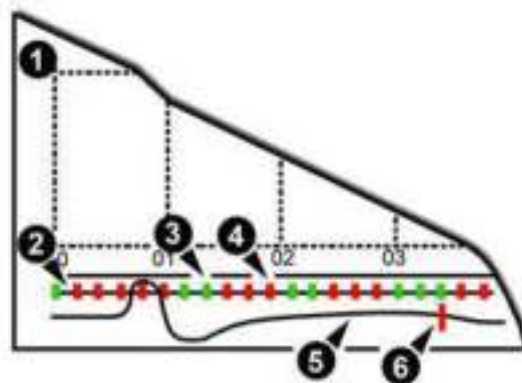

Figure 13-77. Frame Markers

1. Analysis Window
2. Frame markers axis
3. Enabled frame (Green)
4. Disabled frame (Red)
5. ECG (where available)
6. Current frame

## Exporting Traces (Saving the Trace Data)

You can save the trace data to an external file in ASCII format, readable in spreadsheet programs.

1. Select **Export Traces** to save the trace data.
2. Specify the following:
  - Location : Select Location which to save.
  - Filename : Enter the filename. (Only Text)
3. Select **OK** to save the data and return to the QAnalysis screen.
  - All displayed sample area traces are saved in the exported file.

*NOTE: The Smoothed trace is the one saved if the user has applied a smoothing filter.*

*NOTE: Only data from the user selected image range is included in the exported trace file.*

*NOTE: No trace results are saved in the standard image database.*

## Annotating the QAnalysis Data

The user can annotate both the reference image and the trace plot displays. Use **Comment** key to type the annotation. See Chapter 6 for reference.

## Printing QAnalysis Data

Press the appropriate print key in the desired analysis mode mode.

The system captures a single still frame which consists of the plot, the reference image, and user annotation.

## Exiting QAnalysis

There are several methods to exit QAnalysis.

- Toggling **Exit QAnalysis** on the QATouch Panel.
- Press **Freeze** to unfreeze and resume scanning.
- Press any other button that returns the system to real-time scanning.

# Stress Echo

## Introduction

The LOGIQ Totus Ultrasound system provides an integrated stress echo package, with the ability to perform image acquisition, review, image optimization, and wall segment scoring and reporting for a complete, efficient stress echo examination.

The stress package provides a protocol template for the two types of stress exams (exercise and pharmacological stress).

In addition to preset factory protocol templates, templates can be created or modified to suit your needs.

You can define various quad screen review groups, in any order and combination, that will suit your normal review protocol.

When reviewing stress examination images, the images are viewed at their original image quality, and different post-processing and zoom factors may be applied to the images under review for effective image optimization.

The protocol template may be configured for Continuous Capture.

A stress echo examination consists of three steps:

- Selection of a stress test protocol template
- Image acquisition
- Stress Analysis

*NOTE: If WallMotion Segment Score is not displayed on the screen, select the "WallMotion" preset in the Utility -> Measure -> M&A -> Plot -> Available Folders and Measurements.*

## Getting started with a stress study

1. After selecting the appropriate application and probe, press the **Protocol** tab on the Touch Panel. The protocol screen displays the layout of the default stress protocol for the current probe. This layout is also known as a template.

Table 13-38: Protocol Tab

Parameter	Description
Analyze	Display the Analysis screen
Template Editor	Display the template editor screen
Add Level	Add Level to the template
Delete Images	Delete the selected image
Move Image	Move the selected image to the another cell
Sync. Select	Synchronize the selected images.
End CC	End Continuous Capture
Begin/Cont.	Begin or continue the acquisition
Template	Display the template list
T1	Display/Hide the timer T1
T2	Display/Hide the timer T2
Cancel	Cancel Stress Echo

## Getting started with a stress study (continued)

- To use the current template, press **Begin/Cont.** to initiate scanning.  
To use another template, press **Template**. The template list displays.

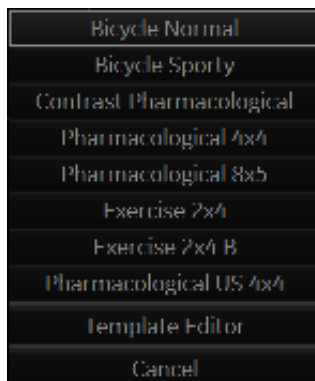

Figure 13-78. Template List

- Trackball** to the desired template and press **Set**.

## Getting started with a stress study (continued)

4. The selected template displays.

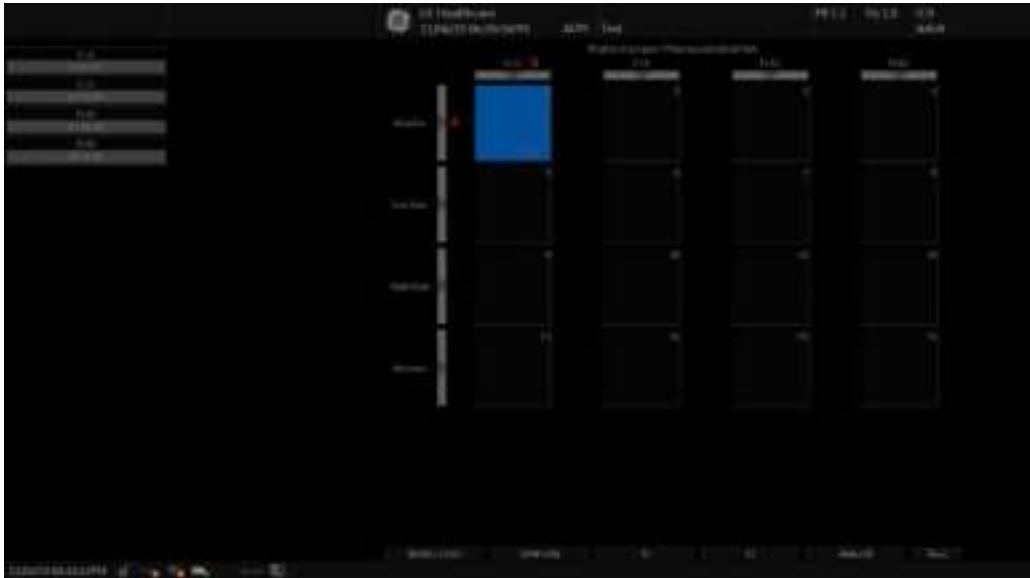

Figure 13-79. Template (Example)

- a. Level
  - b. Projection
  - c. Current Acquisition (green)
5. Press **Begin/Cont.** to initiate scanning using the new template.

### Image acquisition

Images are acquired in a pre-defined order, according to the selected template. The highlighted (green) cell of the template matrix, displayed in the Clipboard window, indicates which view is currently being acquired.

The names of the view and levels for the current cell are displayed on the top left corner of the image area and under the template matrix.

#### Acquisition Screen

1. Current View Level
2. Timer
3. Template Matrix
4. Current View (Green cell)



## Starting acquisition

1. Select the template.
2. Press **Begin/Cont.**
3. Perform a scan that conforms with the view that is highlighted in the template matrix on the Clipboard window.
4. Press the **P1** (Image Store) key.
  - If the actual stress level is configured to preview the cine loop before storing, use the cine loop controls to select the most appropriate heart cycle and if desired adjust the loop markers. Press **P1** again to save the selected cine loop.
  - or
  - If you do not want to store the cine loop, press **Freeze** to cancel. Return to the scan screen.
  - If the actual stress level is not configured to preview the cine loop before storing, the system automatically stores the last heart cycle.

Stress levels can be configured for side-by-side display/ comparison of the reference loop from baseline or previous level and the loop to acquire.

5. After storing the cine loop, the system automatically highlights the next view in the matrix to be acquired.
6. Repeat previous steps until all required views are completed.
7. If you select Auto Start Analysis on the Template Editor for this template, a dialogue asking “Do you want to start protocol analysis now?” displays when the last acquisition is complete. If you select Yes, the Stress Echo Analysis screen is displayed.

The template used can be configured so that analysis automatically starts by displaying the first protocol group. The wall segment scoring diagrams for each view is displayed in the Parameter window on the left side of the screen.

### Starting acquisition (continued)

If the **Protocol** tab is selected during acquisition, the following Touch Panel displays.

Table 13-39: Protocol Tab during acquisition

Parameter	Description
Stop	Stop Stress Echo.
Pause	Pause Stress Echo. The template matrix continues in display. Even if you press P1, the cine loop does not store to the matrix.
Select Cycles	The Continuous Capture Selection screen is displayed (only available in Continuous Capture mode).
Analyze	Enter Analysis screen.
Template	Enter Template screen.
Add Level	Add level to the template.
T2	Display (Start)/Hide Timer T2.

## Selecting a view during acquisition

A fixed protocol is provided for scanning, based on the selected template. The system automatically highlights the next view to be acquired in the template matrix, as images are stored. However, the order of scanning may be changed manually as follows:

### Manual selection of a view during acquisition

1. Use the **Trackball** or the **arrow keys** on the alphanumeric keyboard to move the cursor to the cell that represents the view to be acquired.

The selected cell in the template matrix, highlighted in red, indicates the non-default position. When blinking, it contains a previously-stored acquisition.

2. Press **Begin/Cont.** to initiate scanning.
3. Scan and save the selected loop as explained in the previous section.

After storage, the system automatically highlights the next available view to be acquired.

### Moving an acquired image

An image can be moved from one cell to another during acquisition.

#### Procedure 1

1. When in the Protocol screen, press **Move Image**.
2. Use the **Trackball** to move the cursor to the desired image.
3. Press **Set**.
4. Use the **Trackball** to move the cursor to the destination cell.
5. Press **Set**. The image is moved from the source cell to the destination cell.

#### Procedure 2

1. In the Protocol screen, use the **Trackball** to move the cursor to the cell containing the image to move (source cell).
2. Press and hold down **Set**.
3. With the **Set** key still depressed, move the **Trackball** to the desired cell.
4. Release the **Set** key. The image is moved from the source cell to the destination cell.

If the destination cell contains an image, the images from the source and destination cells is exchanged when moving an acquired image.

## Timers

Two timers can be displayed in the Stress mode acquisition screen, beside the template matrix.

### Timers

- T1 displays the elapsed time from the start of stress examination.
- T2 starts when entering live scanning on the second stress level.

Both T1 and T2 timers can be manually stopped and restarted during the acquisition.

The display of T1 and T2 is user-configurable.

*NOTE: If you activate the Timer in Stress Echo, the T1 timer is displayed in the lower left-hand corner of the image area after exiting Stress Echo.*

### Continuous Capture mode

Continuous Capture mode enables the user to perform acquisition continuously for all views at any level depending on the selected template configuration. Continuous Capture consists of temporary images and loops acquired during the session in a storage buffer in system memory. To enable best possible use of the limited storage buffer capacity, a Pause/Capture mode is provided, as opposed to the normal Freeze/Scan mode. The Pause mode enables scanning and live display on the screen, without any capture, thereby leaving the buffer available.



#### WARNING

Leaving a Stress Echo exam **PRIOR TO** saving portions of the Continuous Capture through “select cycle” or triggering a “Store All” could result in the loss of Continuous Capture data.

The continuous capture acquisition obtained using the P1 print key while in protocol is stored in temporary memory. Loss of power before properly ending the patient or before selecting cycles will result in the loss of this information in certain configurations.

Upon completion of cycle selection or when ending current patient, the user will be prompted as to what they would like to do with this temporary buffer. If they choose "store all," the information will then be placed in permanent memory on the system's hard drive.



#### WARNING

**DO NOT** change modes or power off the system while in Continuous Capture Mode. Doing so causes images and data acquired during the session to be lost.

To run Continuous Capture, the user has to select a template where this feature is activated.

## The buffer bar

When entering a level with Continuous Capture enabled, a buffer bar displays in the window.

The Buffer bar displays the following information:

- The scanning state
  - Pause (live scanning without storing)
  - Capture (live scanning with storing temporary images and loops to system memory buffer)
- The percentage of the buffer that is filled
- The buffer filling progression showed by a filling gage
- The capturing sessions, reflected by the red lines along the buffer bar

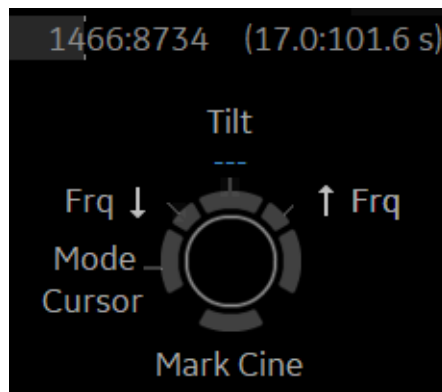

Figure 13-80. Buffer Bar

### Controlling the capture process

When entering a stress level with Continuous Capture enabled, the system is automatically set in Pause mode.

1. Press **P1** to start image capture.  
“Capture” is displayed in the buffer bar, the gage starts filling and the percentage of filled memory buffer increases.
2. Press P1 again to stop capture.  
“Pause” is displayed in the buffer bar.

When 90% of the memory buffer is filled up, the text display in the buffer bar turns red.

The system enters Freeze mode automatically once the buffer is full and the captured loops display in the Continuous Capture selection screen.

### Activating Continuous Capture

1. Do all your pre-stress acquisitions in the Cardiac application.
2. Press the **Protocol** tab to enter the Stress Echo mode. The Protocol screen displays.
3. Press **Template**. The template list displays.
4. Select the template **Exercise 2x4** from the list.
5. Press **Begin/Cont.**
6. Acquire the resting loops in all four views.

**NOTE:** *Use the **P1** key to store the images.*

7. Once the fourth loop is acquired, the system enters into a waiting mode where Continuous Capture is in a pause state awaiting the patient to exercise.
8. When the patient is back on the bed, press **P1**. The Continuous Capture acquisition starts.
9. Acquire all your views.  
The memory buffer gage increases. When memory exceeds 90%, the percent number turns red.
10. Press **Freeze** to finish.



## Activating Continuous Capture (continued)

### 11. Press **Select Cycle**.

The Continuous Capture selection screen displays.

Refer to the next section if additional image acquisitions are necessary after the buffer is full.

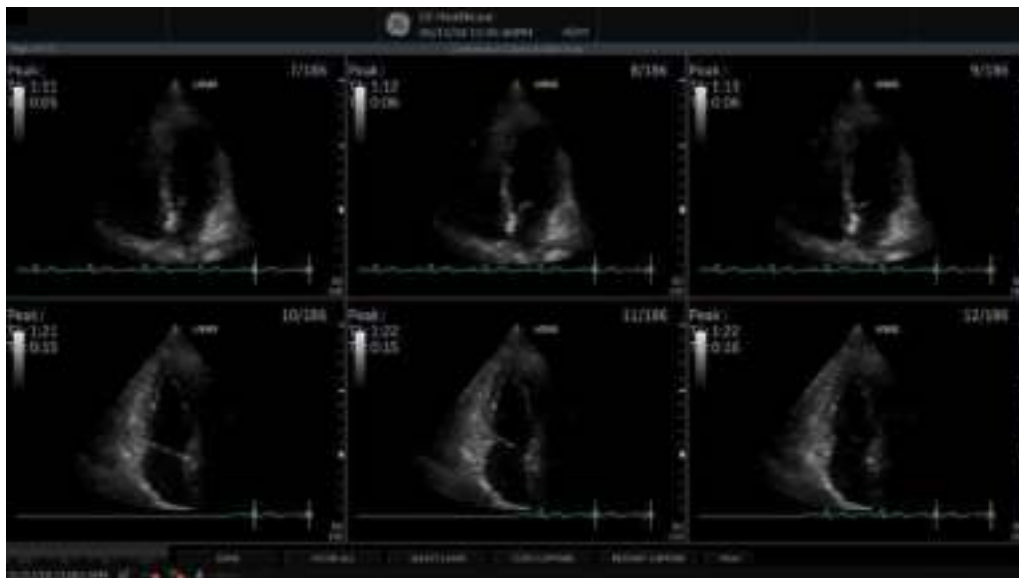

Figure 13-81. Continuous Capture Selection Screen

## Activating Continuous Capture (continued)

12. Assign the cine loops to the four views.
  1. **Trackball** to the desired loop.
  2. Press **Set**. A drop-down menu appears with the available choices.
  3. **Trackball** to the appropriate view.
  4. Press **Set**.
  5. Continue these steps until all views are selected.  
*NOTE' To access additional cycles, use the arrow keys on the lower left portion of the select cycle screen.*
  6. Select **Done** when complete. A dialogue window displays, asking whether the entire Continuous Capture acquisition should be saved.

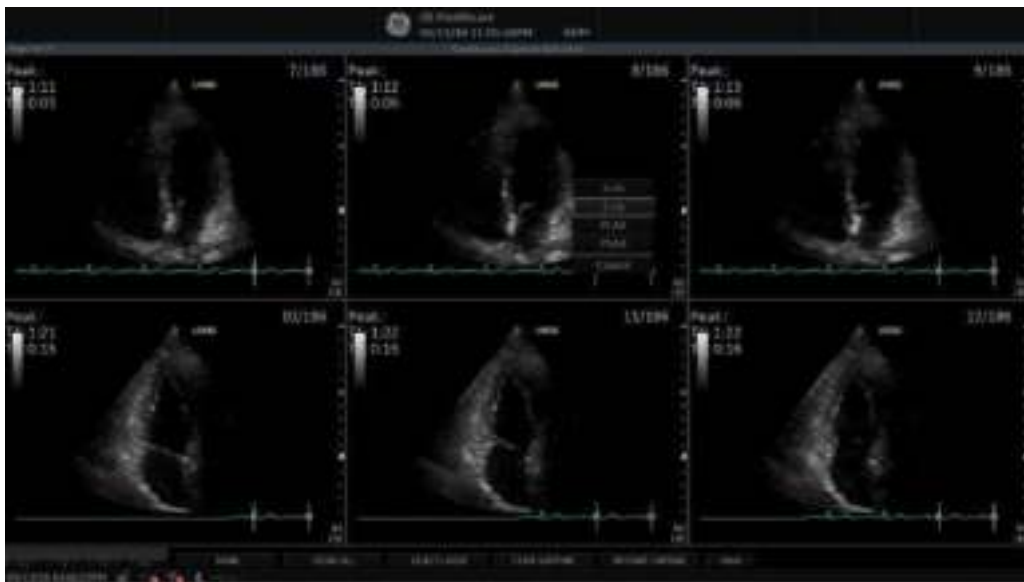

Figure 13-82. Drop-down Menu

## Activating Continuous Capture (continued)

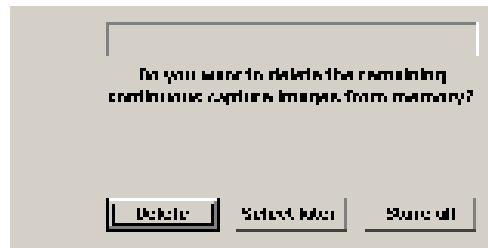

Figure 13-83. Dialogue Window

13. Press **Delete** to discard the loop or press **Store** to keep the entire loop.
14. Perform Analysis and scoring.

### Continuous Capture with additional image acquisition

If the buffer is filled up before all the image acquisitions are done, additional loops can be stored in the clipboard before doing image assignment to the views.

1. Perform the Continuous Capture. See 'Activating Continuous Capture' on *page 13-184 for more information.* (Steps 1 to 11).
2. In the Continuous Capture selection screen, press **Select Later**.  
The Continuous Capture screen displays.
3. Perform the additional acquisition.
4. In order to resume the stress echo exam and assign loops for the views from the Continuous Capture buffer, press **Protocol**. If not displayed, select the template **Exercise 2x4** from the template list.
5. Click the continuous capture images on the Protocol Template screen.  
The Continuous Capture selection screen displays.
6. Assign the cine loops to the view. See 'Activating Continuous Capture' on *page 13-184 for more information.* (Step 12 a - f).
7. Press **Delete** to discard the loop or press **Store all** to keep the entire loop.  
The normal procedure is to discard the loop. The loop is very big and requires a lot of disk space.
8. Perform Analysis and Scoring.

## Postponed image assignment

The assignment of the cine loops to the view can be done on a later stage on a stored Continuous Capture acquisition.

1. Perform the Continuous Capture. See 'Activating Continuous Capture' on *page 13-184 for more information*. (Steps 1 to 11).
2. Press **Store all**.  
The entire Continuous Capture acquisition is stored. The examination can be ended and the image assignment, analysis and scoring can be done later.
3. Re-open the examination, if necessary.
4. Press **Protocol**. The Protocol screen displays.
5. Click the continuous capture images on the Protocol Template screen.  
The Continuous Capture selection screen displays.
6. Assign the cine loops to the view. See 'Activating Continuous Capture' on *page 13-184 for more information*. (Step 12 a - f).
7. Select **Done**.
8. Perform analysis and scoring.

## Restart capture from the Continuous Capture Selection

- Press **Restart Capture**.  
The recording in memory is deleted and the Continuous Capture starts again.

## Resume Continuous Capture

- Press **Continue Capture**.  
Resumes Continuous Capture recording (only if the Continuous Capture buffer is not full).

### Assigning and storing the cine loop

The cine loops captured in the buffer are assigned to the stress protocol views and stored from the Continuous Capture selection screen.

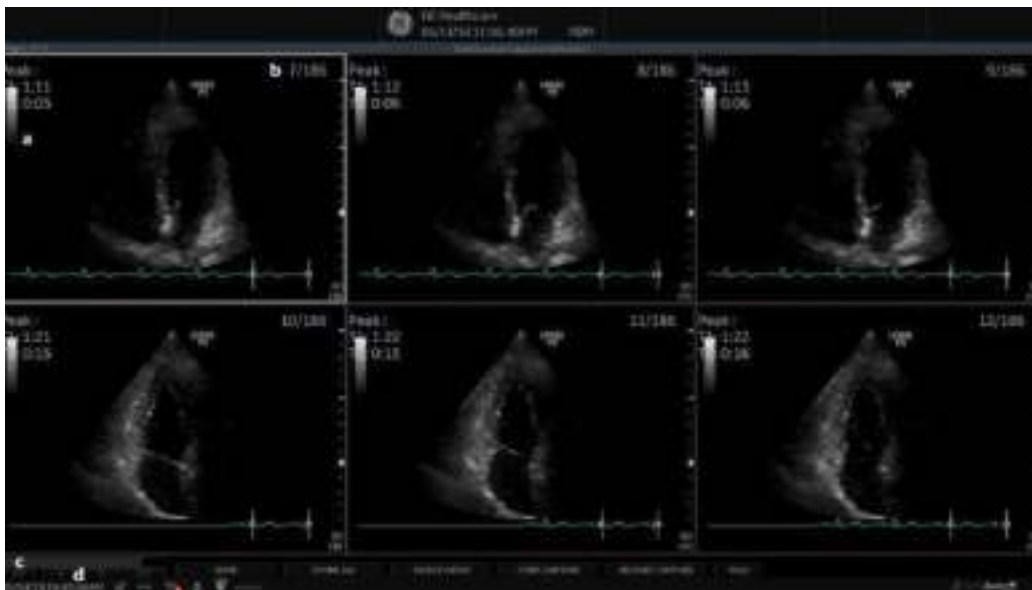

Figure 13-84. Continuous Capture Selection Screen

1. Highlighted loop
2. Cycle number and total number of cycles
3. Blue Gauge: Position of the highlighted loop within buffer area.
4. Red bar: Pause session.
5. Navigation Controls: << > >> (back to first selection, back to previous selection, forward to next selection, and forward to final selection).

### Assigning a cine loop to a view

1. Use the **Trackball** to move the cursor to the desired cine loop in order to assign it to a particular view of the stress template.  
The frame of the loop is highlighted.
2. Press **Set**.  
A pop-up menu displays with the view names of the template.

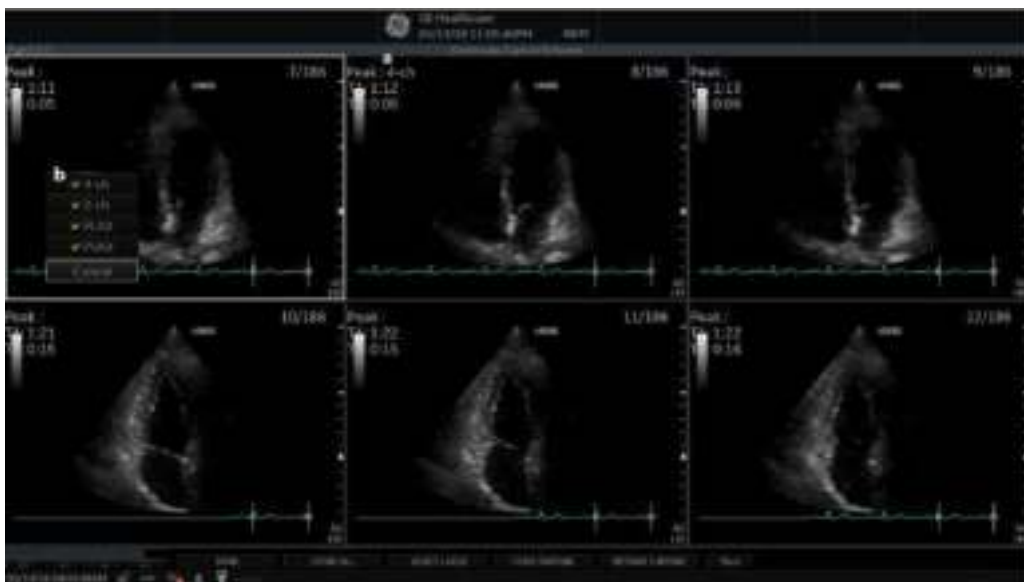

Figure 13-85. Loop Assignment

1. Already assigned view
2. Views pop-up menu  
*NOTE: A checkmark appears on the Views pop-up after you have assigned a view to an image.*

### Assigning a cine loop to a view (continued)

3. Use the **Trackball** to select the required view name.
4. Press **Set**.  
The name of the view displays above the timers in the window.
5. Repeat steps 1 through 4 to assign loops to the other views of the level.
6. Press **Done** when complete.  
A dialogue window displays asking whether the entire Continuous Capture acquisition should be saved.
7. Press **Delete** to discard the loop or press **Store all** to keep the entire loop.  
The normal procedure is to discard the loop. The loop is very big and requires a lot of disk space.



## Post Acquisition Features

Post acquisition, you can utilize Raw Data to adjust the following in B-Mode:

- Zoom
- SRI-HD
- Rejection
- Frame Average
- TGC
- Maps
- Dynamic Range
- Gain
- Rotation

You can also take measurements post Stress Echo acquisition.

### Analysis

Analysis consists of viewing previously saved loops and assigning scores to each cardiac segment, in order to quantify the function of the muscle or wall segment.

Depending on the protocol configuration, the analysis stage can start manually or automatically after completion of the stress test. In this case, the usual procedure consists of sequentially opening all image groups (if defined) and performing scoring from image to image.

The quad screen is the standard display for comparing heart cycles. The heart cycle loops in the display are synchronized to enable comparison. Each loop in the quad screen can be magnified, using the zoom control.

### Image Selection for Analysis

Images can be selected manually or from a pre-defined group in the Protocol screen.

### Selection of Images from a group

If groups of images have been defined in the protocol template, you can select a group of images for analysis and sequentially analyze all images from all groups from within the Analysis screen.

1. In a stress examination, press **Protocol**. A preview of the acquisition displays.
2. Press **Analysis**. A pre-defined group appears in the display with a Wall Segment window on the left.
3. To advance to other groups, use the **Trackball** to move the cursor to the arrows at the bottom of the Wall Segment window. Select an arrow to advance to another group. For further clarification, see callout E in Figure 13-86.

### Manual selection of images from Analysis screen

1. When currently in the protocol analysis screen in the Stress analysis quad screen, hold down the **SHIFT** key while performing Steps 2 through 4.
2. Use the **Trackball** to move the cursor to the first image to select in the template matrix.
3. Press **Set**. The frame of the selected loop is in the Stress analysis screen and the next window in the quad screen is automatically selected.
4. Repeat step 2 and 3 to select other images.
5. Depress **SHIFT** .

### Manual selection of images in the Protocol screen

1. In a stress examination, press **Protocol**. A preview of the acquisition displays.
2. Use the **Trackball** to move the cursor to the first image to select.
3. Press **Set**. The frame of the selected loop highlights.
4. Repeat Steps 2 and 3 to select other images.
5. Press **Analyze** to open images in the Analysis screen.

## Scoring acquired loops

1. After image selection, press **Analyze**.  
The Stress Echo analyze screen displays.

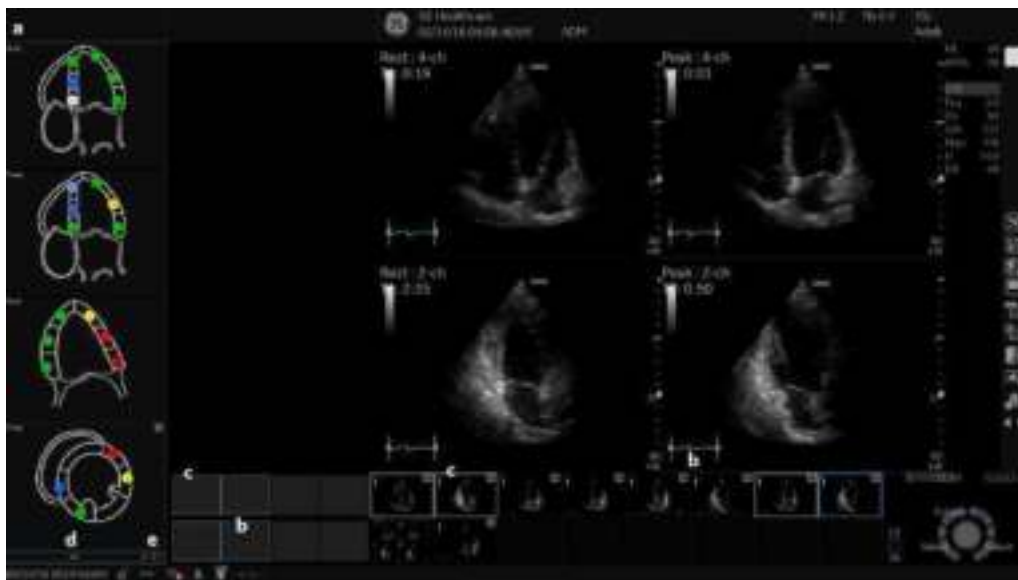

Figure 13-86. Analysis Screen

- a. Wall segment diagram
- b. Selected loop (Highlighted frame)
- c. Displayed loops (Highlighted frames)
- d. Exit Wall motion scoring
- e. Change page or enter next image group

## Scoring acquired loops (continued)

2. Use the **Trackball** to move the cursor to a score.
3. Press **Set**.  
The score displays in the relevant segment area in the diagram.

**NOTE:** *To edit a score, select it and choose a new score.*

4. Repeat step 1 through 3 to score relevant segments.
5. Press the **Change Page** arrow to display the next group of images.
6. Repeat step 1 through 3 to score relevant segments on the new loops.

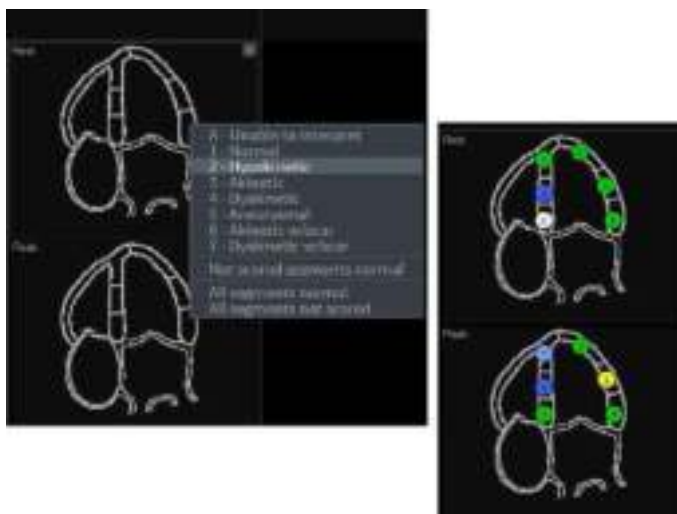

Figure 13-87. Segment Scoring

**NOTE:** *Since Cine changes into sync mode, subsequent scans are also synchronized. Exit sync mode from the Cine menu.*

### Editing/Creating template

The stress package provides protocol templates for exercise as well as pharmacological stress examinations.

The user can create new templates or modify existing templates to suit the individual needs. Up to ten projections and fourteen stress levels can be created in a template.

Templates created may be temporary, used only during the current examination, or saved as new templates, for future use and reference.

The editions that may be performed include:

- Adding/Deleting levels and projections.
- Assigning new labels to levels and projections.
- Defining level options.
- Defining new groups.

Templates are edited/created from the Template editor screen.

### Entering the Template editor screen

1. Press **Protocol** to enter the stress echo mode.
2. Press **Template**. The template list displays.
3. Use the **Trackball** to select the Template Editor.
4. Press **Set**. The Template Editor screen displays.

OR

1. Press **Protocol** to enter the stress echo mode.
2. Press **Template Editor** on the Touch Panel. The Template Editor screen displays.

## Template Editor screen overview

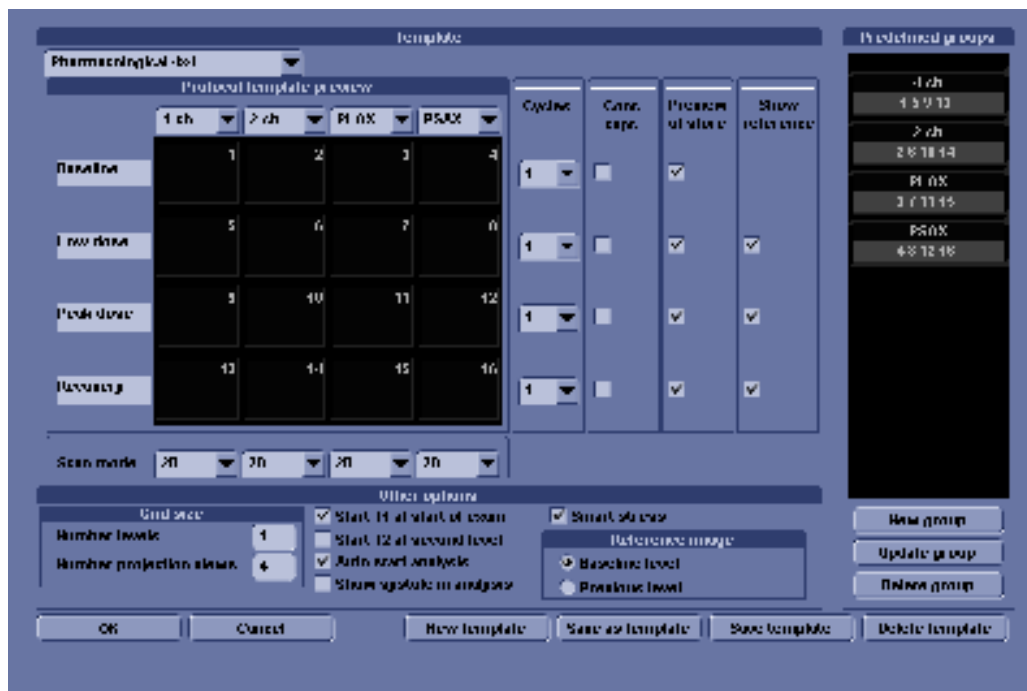

Figure 13-88. Template Editor Screen

Table 13-40: Template

Parameter	Description
Template	Select a pre-defined template from the pull-down menu. The protocol template preview updates accordingly.

Table 13-41: Protocol Template Preview

Parameter	Description
Protocol Template Preview	<ul style="list-style-type: none"> <li>Displays an updated preview of the template accordingly to the settings applied.</li> <li>To change Projection and Stress level labels, select a pre-defined label from the pull-down menu or press <b>Set</b> in the actual label field and type a new name.</li> </ul>

Table 13-42: Template Settings

Parameter	Description
Template Settings	<ul style="list-style-type: none"> <li>• Cycles: select the number of cine loop heart cycles to store for each level from the pull-down menu or enter the desired value manually.</li> <li>• Continuous Capture: Checking this parameter enables continuous image acquisition throughout the level. The images acquired are temporarily stored in the system's storage buffer.</li> <li>• Preview of store: Checking this parameter enables review and adjustment of cine loops before store.</li> <li>• Show reference: Checking this parameter displays a dual screen with the reference level (first or previous level) on the left and the live image on the right.</li> </ul>

Table 13-43: Scan Mode

Parameter	Description
Scan Modes	<ul style="list-style-type: none"> <li>• 2D, Color, PW (Pulsed Wave Doppler), CW (Continuous Wave Doppler), MM (M-Mode), Color MM, Color PW, Color CW</li> </ul>

Table 13-44: Other options

Parameter	Description
Other Options	<ul style="list-style-type: none"> <li>• Grid Size: Enter the number of levels and projections for the selected template.</li> <li>• Timers: If you check this parameter, starts T1 and T2 timers automatically.</li> <li>• Auto-start analysis: If you check this parameter, displays the Stress Echo Analysis when the last acquisition is performed.</li> <li>• Show Systole in Analysis: When selected, the systolic part of the cardiac or ECG cycle is only displayed. The whole cycle is not displayed.</li> <li>• Smart Stress: Check Smart Stress to store and automatically reuse a subset of the image acquisition settings from a previous level in the corresponding views in the next level. When smart stress is used with "preview to store" function the timeline modes (PW, CW, M Mode, TDI) will only transfer image acquisition settings from baseline.</li> <li>• Reference image: When Show Reference is selected, selects either corresponding baseline loop or corresponding loop from the previous level to be displayed as reference image during acquisition.</li> </ul>

Table 13-45: Pre-defined groups

Parameter	Description
Pre-defined groups	<ul style="list-style-type: none"> <li>• Shows the image groups created.</li> <li>• New group: Creates a new image group. Select the desired images on the template preview.</li> <li>• Update group: Edits a selected group after new loop selection on the template preview.</li> <li>• Delete group: Deletes a selected group.</li> </ul>



## Editing/Creating a template

### Selecting a base template to edit

1. Select the base template from the template pull-down menu on the upper left corner.
2. Press **Set**.

The selected template displays in the protocol template preview field, showing the levels, projections and their labels.

### Adding/Deleting levels and projections

1. Enter the number of levels and projections in the Grid size field.  
The new grid size displays in the protocol template preview field.
2. Press **New Template** to create a new template.  
or  
Press **Save Template** to update the base template.

### Display timers

1. Check the box(es) to display timer(s) as specified.

*NOTE: The timers can also be started or stopped at any time during stress examination by using the T1 and T2 Touch Panel key.*

### Start analysis automatically

1. Check **Auto Start Analysis** to display the Stress Echo Analysis screen when the last acquisition is performed.

### Smart Stress

1. Check Smart Stress to store and automatically reuse a subset of the image acquisition settings from a previous level in the corresponding views in the next level. When smart stress is used with "preview to store" function the timeline modes (PW, CW, M Mode, TDI) will only transfer image acquisition settings from baseline.

### Editing/Creating a template (continued)

#### Configuring levels

The following options can be set up for each level:

Number of cycles to be stored in the cine loop:

1. Enter the desired number (1, 2, 3, 4, 5, 6, 7, 8, 9, 10, 15, 20) in the Cycles field.

Continuous Capture

1. Check Continuous Capture if continuous image acquisition throughout the level is desired.

When Continuous Capture is selected, preview of the cine loop and reference display during acquisition are not possible.

Preview of store

1. Check Preview of store if review and adjustment of cine loops before storage is desired.

Show reference

1. Check Show reference if the display of the corresponding reference loop is desired during acquisition (Dual screen mode).

## Editing/Creating a template (continued)

### Adding a group

1. In the Protocol template preview field, select the cells to be part of the group.
2. In the Pre-defined group field, press **New group**.  
A dialogue box displays to ask the user to enter a name for the new group.
3. Enter the group name.
4. Press **OK**. The new group displays in the pre-defined group field.

### Updating an existing group

1. In the Pre-defined group field, select the group to edit.  
The selected cells are highlighted in the Protocol template preview field.

*NOTE: A selected group is highlighted by a blue frame.*

2. Either select a new cell(s) to add to the group or deselect an existing cell(s) to remove from the group.
3. Press **Update group**.

The display in the Protocol template preview field is updated accordingly.

### Deleting a group

1. In the Pre-defined group field, select the group to delete.

*NOTE: The selected group is highlighted by a blue frame.*

2. Press **Delete group**.

The group is removed from the list in the pre-defined group field.

### Specifying Scan Mode for each Projection

1. Specify the Scan Mode for each Projection: 2D (B-Mode), Color Flow Mode, M-Mode, Color M-Mode, PW Mode, Color PW Mode, CW Mode, or Color CW Mode.

### Editing/Creating a template (continued)

#### Saving the Template

You can save the template using controls at the bottom of the Template Editor page, or use the controls on the Touch Panel.

Table 13-46: Template Editor Saving Options

Parameter	Value
New Template	Select this option to create an entirely new template.
Save As Template	If you would like to create a new template based on the existing template with your modifications, select to Save this Template As, and give it a name.
Save Template	Select this option to save the default template with your modifications.
Delete Template	Select this option to delete a template.

## Wall Motion Segment Setup

You can set up the following parameters for Wall Motion Segment in the Utility screen (Utility--> Measure--> Advanced--> Cardiac).

Table 13-47: Wall Motion Segment Parameters

Parameter	Value
WMS freeze loop at ES	Specify to freeze the Loop at End Systole
WMS Segment Model	Select 16 or 18 segments
WMS initial scoring	Undefined or Normal
WMS scoring legend	ASE, ASIA or European

## Utility Application Settings for Protocol

Table 13-48: Protocol Parameters

Parameter	Description
Show Protocol Tab	Show/Hide the Protocol tab for that preset (Bicycle Normal, Bicycle Sporty, Contrast Pharmacological, Pharmacological 4x4, Pharmacological 8x5, Exercise 2x4, Exercise 2x4 B, Pharmacological US 4x4, or User-configured).
Template	Select the default template.

## Report

If you set up the Wall Motion Analysis field on the Report, you can insert the results.

Select Report to view either the Bull's Eye or Cut Plane Report.



Figure 13-89. Bull's Eye Report Sample

Report (continued)

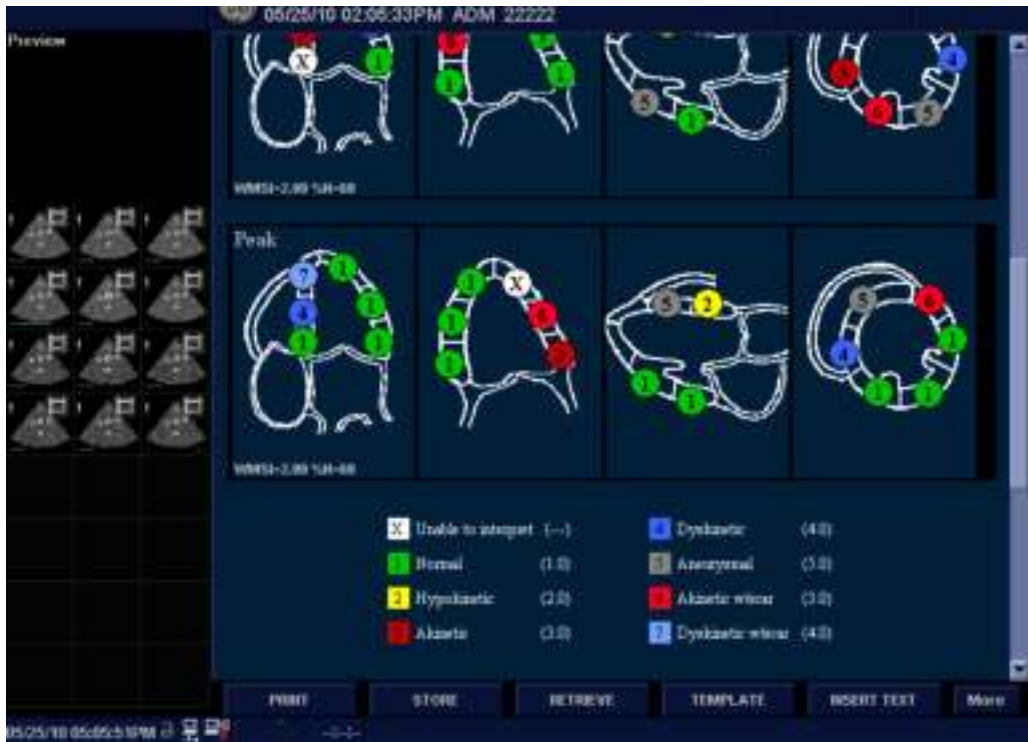

Figure 13-90. Cut Planes Report Example



HINTS

Select either Bull's Eye or Cut Plane on the Reports--> Adult Template.



# Cardiac Automated Functional Imaging (Cardiac Strain)

## Cardiac Strain

Cardiac Automated Function Imaging (Cardiac Strain) is a decision support tool for global and regional assessment of the LV systolic function. Cardiac Strain calculates the myocardial tissue deformation based on feature tracking on B-Mode grey scale loops.

Cardiac Strain is performed on the standard apical views, apical long-axis (APLAX), 4-chamber (A4CH) and 2-chamber (A2CH), following an on screen guided workflow. The apical views may be acquired sequentially in B-mode.

Cardiac Strain is also available for standard apical views acquired with a TEE probe.

Cardiac Strain may be launched from the Cardiac application using Transthoracic echocardiogram (TTE) images from the M5Sc-D probe, or from the Pediatric application using either the 6S-D probe.

If a complete analysis of all three views is performed, the result is presented as a Bull's eye display showing color coded and numerical values for peak systolic full wall longitudinal strain, PSS (Peak Systolic Strain), TTP (Time To Peak global longitudinal strain) and traces.

If the user approves the results, all values are stored to the worksheet. In addition, Global Strain for each view, Average Global Strain for the whole LV, standard deviation of the segmental Time To Peak Strain and the Aortic Valve Closure time used in the analysis are stored to the worksheet.



Texture is an imaging technique that enhances structural information and attenuates reverberations and other signals that do not represent the location displayed. Unlike B-mode, the brightness of the Texture image is not directly related to echo amplitude. Texture is useful for an enhanced view of layers, borders and structures. Pixels in a normal image that would be dominated by energy not coming from the target location will appear darkened. Speckle from blood signals will appear enhanced.

Images acquired with Texture have different speckle characteristics and might therefore influence the results of speckle tracking. For this reason, it will not be possible to perform Cardiac Strain analysis of images were Texture was enabled

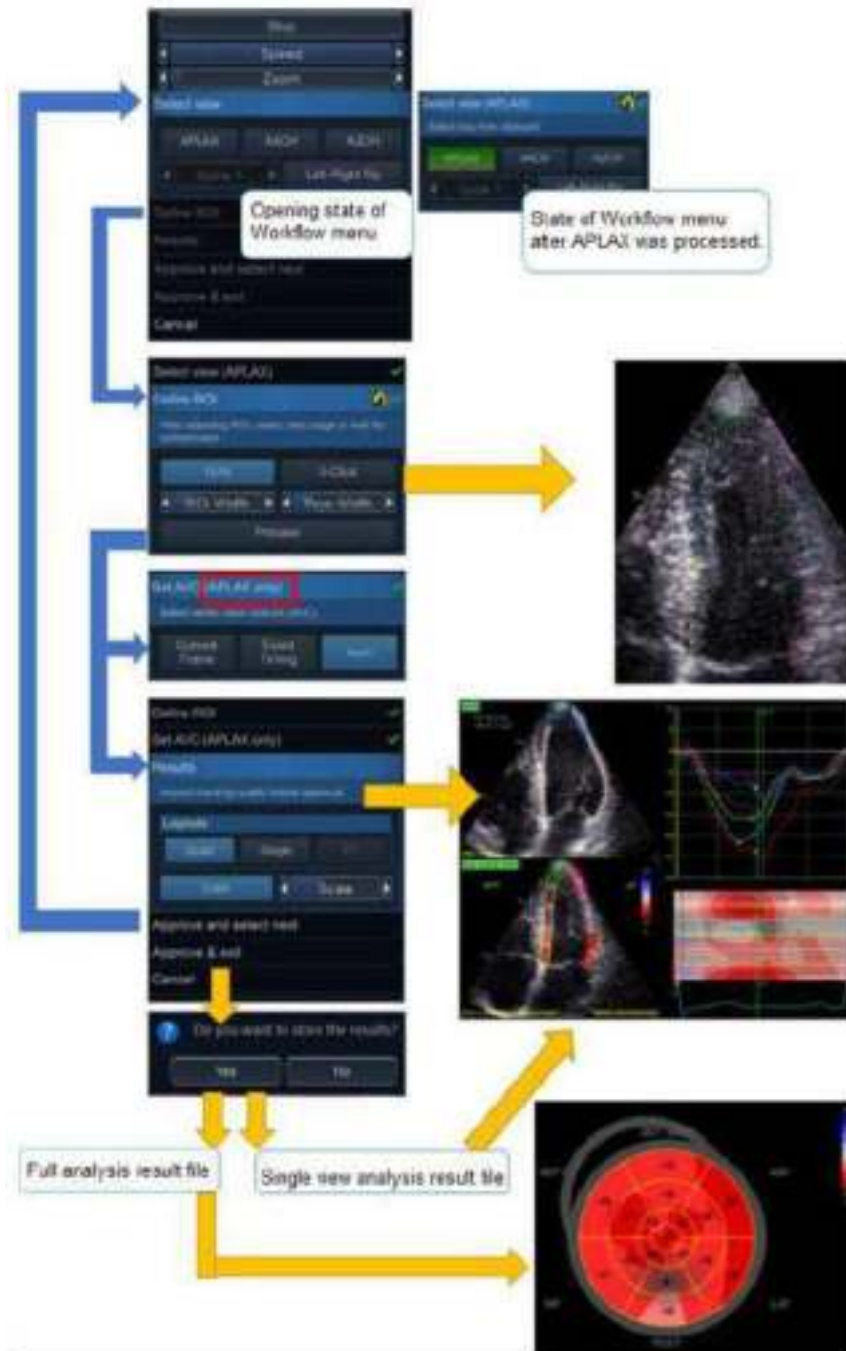

Figure 13-91. AFI Workflow

### Acquisition

Create an exam, connect the ECG device and make sure to obtain a stable ECG trace.

### Sequential acquisition

Acquire 2D grey scale cineloops of an APLAX, A4CH and A2CH view.

*NOTE: It is recommended to acquire all three apical views sequentially to get similar heart rate in all views.*

### Acquisition requirements

- The frame rate should be between 37 and 80 frames per second. A higher frame rate is recommended for high heart rate.
- Heart rate variability between the recordings should not be greater than 30%.
- The system should be configured to store 100 ms before and after each heart cycle.
- If the acquisition has more than one heart cycle, the analysis will by default be done on the second to last heart cycle.
- The entire myocardium should be visible.
- A depth range that includes the entire left ventricle should be used.



#### CAUTION

Cardiac Strain is only recommended for adult cardiac images acquired with the M5Sc-D probe. Cardiac Strain is only recommended for pediatric cardiac images acquired with the 6S-D probe. The measurement accuracies of the longitudinal strain values reported in the Reference manual are verified with these probes.

### Starting Cardiac Strain from sequential acquisition

1. Open the exam for which you want to perform Cardiac Strain analysis and select one of the apical images you would like to use for the analysis.
2. Press **Measure** on the Control panel and select the Cardiac Strain study. If the images are acquired with a transthoracic probe, the system will try to identify a suitable triplet of apical views suitable for the analysis. If this succeeded, the tool will launch and start up in the Define ROI stage with the selected view. The tool will launch and start up in the Select View stage.



Figure 13-92. Define ROI Stage



Figure 13-93. Select View stage



### Cardiac Strain Stage Menu

The workflow in Cardiac Strain is controlled by the stage menu to the right in the tool window. It is possible to navigate between the stages by clicking on the stage buttons. Stages that are not accessible from the given tool state are greyed out.



Figure 13-94. AFI stage menu

The stage menu buttons also contain information about completeness state and a reset button.

	By clicking the Reset button, the stage is reset and all user entered information in that stage is cleared. Any automatic procedures are re-run.
	If a stage is labeled, it means the stage is complete and nothing more needs to be done in that tool stage.

Beneath the stage menu button, a help string for the current active state is shown.

### Cardiac Strain on the APLAX view

1. The first stage when launching the tool, will be the Select View stage. The user should then:
  - Perform any Left-Right flip corrections.
  - Select Cycle and adjust Cine markers as appropriate.
  - Annotate the view by clicking one of the view labeling buttons (A4CH, A2CH, APLAX).
2. An automatic ROI is generated when entering the Define ROI stage. The ROI may be edited by clicking and dragging on the endocardial and epicardial contours. See 'ROI adjustment' on page 13-216 for more information.

**NOTE:**

*If Cardiac Strain is performed on pediatric exams, the automatic ROI is disabled. See section about 3-click ROI in 'To create a new ROI' on page 13-218.*

3. When satisfied with the ROI, either stop moving the cursor and wait for automatic processing to start or click on the Process button, Results for A4CH/A2CH, or Set AVC for APLAX. Now the system performs feature tracking to get a temporal ROI trace. On completion, it proceeds to the next stage.
4. (APLAX only) After the ROI edit stage, the system enters the Set AVC stage. Select one of the AVC setting strategies to verify AVC time. See 'Timing Validation' on page 13-222 for more information. On completion, the Cardiac Strain tool now proceeds to the Results stage.
5. The Cardiac Strain tool is now displaying the Results stage in a Quad layout. Now the tracking quality must be inspected and verified. The tracked ROI is divided into segments. The tracking quality for each segment is automatically evaluated and applied to reject segments for which the tracking is assumed to be not reliable. Segments

that have been rejected do not have values in the segmental result ROI to the lower left in the Quad view, but instead shows an X. The strain trace (upper right), Curved Anatomic M-mode section (lower right) and parametric overlay on the dynamic ROI (upper left) are disabled for rejected segments. By clicking on a segment in the segmental result ROI it is possible to override the automatic quality assessment to either show or hide segmental values. The tracking for each segment must be visually controlled and validated as described below.



Figure 13-95. Results stage in Quad layout

Once the tracking quality has been controlled for all segments, you may choose to click:

- Reprocess – To completely reprocess the view currently being reviewed. This will take the user back to “Define ROI” stage of the workflow.
- Approve and Select Next - Proceed to the Select View stage, and the operator has to manually select the next view to process from the clipboard.
- Approve and Exit – To exit the tool and store performed measurements. No segmental strain results are stored in this case.

In case of a multi-cycle recording, the system automatically launches the second to last cycle for analysis. If during analysis, the operator wants to switch to another cycle, that is possible by entering the Select View stage and change cycle using the Cycle button.

### Tracking validation



#### CAUTION

Poor tracking quality may lead to incorrect measurement results. The tracking for each segment must be visually controlled and validated.

Poor tracking quality could result from a variety of causes. Inspect each segment and make sure that the center line is moving together with the underlying 2D image. Use the various results layouts to examine the tracking quality (e.g. Quad layout).

The following can help examining the tracking quality:

- Turn off the color overlay by clicking Color button.
- Reduce playback speed by using the Speed slider (or the rotary on the touch panel).
- Use the Single layout to get a larger view of the dynamic mesh (especially in difficult cases).

If the tracking needs to be improved for some segments, the user can modify the ROI or create a new ROI.

### ROI adjustment

If the automatic ROI is not optimal (resulting in poor tracking), the user can either adjust the ROI or create a new ROI as described below.

### General ROI remarks

The calculations performed on the tracked ROI aim to find the longitudinal deformation along the cardiac muscle from the base to apex. These calculations assume the ventricle to have a horse-shoe shape.



#### CAUTION

If the ROI does not have a horse shoe shape, the calculated measurements may not be accurate.



### To adjust the ROI

Enter the Define ROI stage. The following adjustments can be done to the existing ROI:

- Adjust ROI width by clicking the ROI Width Control.
- Click and drag on the endocardial part of the ROI. Endocardial editing edits the whole ROI
- Click and drag anchor points on the epicardial ROI (highlighted in red on mouse hovering). Epicardial editing edits the epicardial part only

In the upper right of the screen there is a pictogram indicating the core features of a good APLAX ROI.



Figure 13-96. ROI Editing Options

### To create a new ROI

The system automatically displays a frame where the endocardial border is usually clearly visible. To use another frame, while in Define ROI stage, pause the playback by pressing Stop. Then, use the Frame slider (or rotary) to select a different frame for ROI definition.

### Creating a new automatic ROI

To create a new automatic ROI, click the Reset stage button. This relaunches the automatic segmentation.

### Creating a new manual ROI

Sometimes the automatic ROI may fail to capture the correct ROI. In this case, a 3-Point ROI alternative is provided.

**NOTE:** *The 3-Point ROI is the standard ROI method for TEE data and Pediatric exams.*

To generate a ROI by this method, when in Define ROI stage, click on the button 3-Click. The AFI tool will now prompt to click 3 landmarks. Take care to select proper landmarks, as displayed close to the pointer



#### CAUTION

Faulty landmark selection may cause segment values to be swapped in the final results.

When the third landmark is selected, a ROI is generated and can optionally be edited as for the automatic ROI.

**NOTE:** *If the ROI needs to be adjusted, make sure to make the changes immediately after the ROI is displayed, before the auto processing of the ROI begins.*

**NOTE:** *The timing when auto processing of the ROI will start is configurable (from Config).*

**NOTE:** *The Yo-yo function is turned on to help find correct location for the points.*



Figure 13-97. AFI Auto processing configuration



Figure 13-98. Defining a ROI

After placing the three points the ROI is displayed.

### Guidelines when re-creating the ROI

Correct ROI definition is crucial to get good tracking. See use cases below for common pitfalls.

**Tip:** Make sure to follow the recommendations when placing the three points.

Table 13-49: Tips for re-creating the ROI





Tips	Correct	Incorrect
<p><b>Base</b></p> <ol style="list-style-type: none"> <li>1. Correct position of the base points.</li> <li>2. The ROI extends into the aortic tract.</li> </ol>	 <p>Figure 1: A parasternal long-axis echocardiogram showing a correctly placed ROI (red dashed line) that follows the left ventricular wall without extending into the aortic tract. A green checkmark is in the top right corner.</p>	 <p>Figure 2: A parasternal long-axis echocardiogram showing an incorrectly placed ROI (red dashed line) that extends into the aortic tract. A red 'X' is in the top right corner.</p>
<p><b>Apex</b></p> <ol style="list-style-type: none"> <li>1. Correct position of the Apex points.</li> <li>2. The apex point is placed too high. The ROI is extending beyond the epicardium.</li> </ol>	 <p>Figure 1: A parasternal long-axis echocardiogram showing a correctly placed ROI (red dashed line) with apex points (cyan dots) positioned at the true apex of the heart. A green checkmark is in the top right corner.</p>	 <p>Figure 2: A parasternal long-axis echocardiogram showing an incorrectly placed ROI (red dashed line) where the apex points (cyan dots) are positioned too high, causing the ROI to extend beyond the epicardium. A red 'X' is in the top right corner.</p>
<p><b>Apex</b></p> <ol style="list-style-type: none"> <li>1. Correct position of the Apex points.</li> <li>2. The apex point is too high; the ROI is extending beyond the epicardium.</li> </ol>	 <p>Figure 1: A parasternal long-axis echocardiogram showing a correctly placed ROI (red dashed line) with apex points (cyan dots) positioned at the true apex of the heart. A green checkmark is in the top right corner.</p>	 <p>Figure 2: A parasternal long-axis echocardiogram showing an incorrectly placed ROI (red dashed line) where the apex points (cyan dots) are positioned too high, causing the ROI to extend beyond the epicardium. A red 'X' is in the top right corner.</p>

Table 13-49: Tips for re-creating the ROI (Continued)

Tips	Correct	Incorrect
<p><b>Bulges</b></p> <ol style="list-style-type: none"> <li>1. Correct ROI.</li> <li>2. ROI should not be bulging or follow the papillary muscle. To edit the ROI, see 'ROI adjustment' on page 13-216.</li> </ol>	 <p>Figure 1: A cardiac strain image showing a correct ROI (red circle) that is smooth and follows the ventricular wall. A green checkmark is in the top right corner.</p>	 <p>Figure 2: A cardiac strain image showing an incorrect ROI (red circle) that is bulging and follows the papillary muscle. A red X is in the top right corner.</p>
<p><b>General</b></p> <p>The left ventricle must be visible through the entire cycle.</p> <ol style="list-style-type: none"> <li>1. End systole frame: the entire left ventricle is displayed.</li> <li>2. End diastole frame: the annulus is not displayed.</li> </ol>	 <p>Figure 1: A cardiac strain image showing a correct ROI (red circle) that encompasses the entire left ventricle. A green checkmark is in the top right corner.</p>	 <p>Figure 2: A cardiac strain image showing an incorrect ROI (red circle) that does not encompass the entire left ventricle. A red X is in the top right corner.</p>

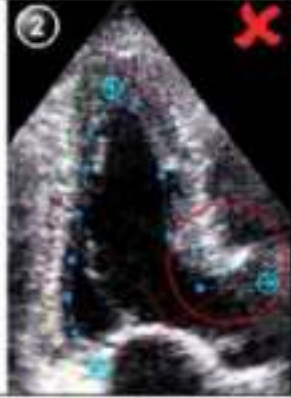
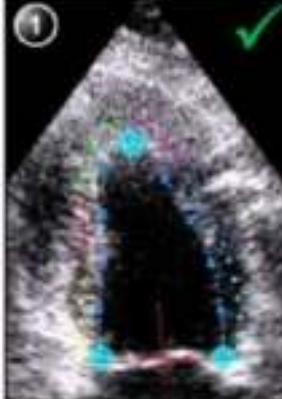
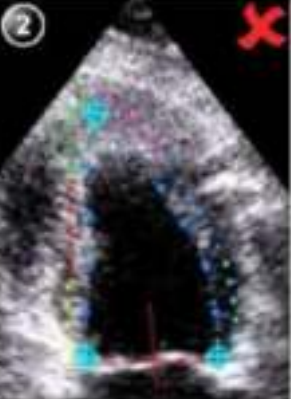
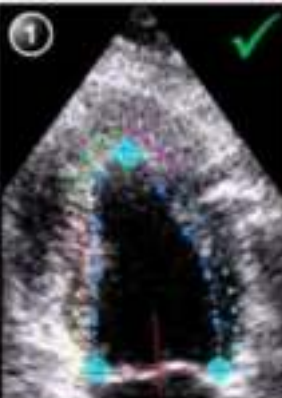
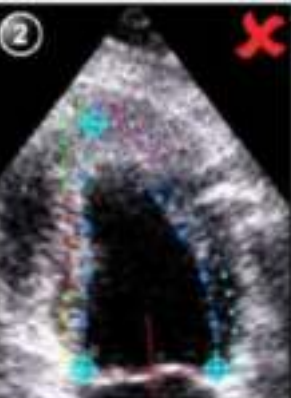
### Timing Validation

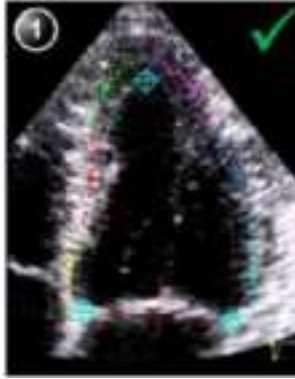
Timing information may be crucial to accurate diagnosis. The most important event timing is the aortic valve closure (AVC), since it is part of the definition of the end systolic strain parameter.

Determination of the AVC timing by the system is as follows, depending on the situation:

- An automatic AVC estimate determined by the temporal contraction of all LV segments (Strain curves) is used.
- From the APLAX view, the user can adjust the estimated AVC timing. The adjusted AVC timing will then be used in the other apical views when running Cardiac Strain on these views.

This option is only available from the APLAX view.

### AVC Timing Adjustment (APLAX only)

After tracking is performed, the system enters the Set AVC stage. The following options for AVC settings are provided:

- Automatic: AVC is set automatically based on the ROI tracking using the time of peak negative strain.
- Manual: Set the AVC time manually. The frame can be selected by the track ball.



Figure 13-99. Parametric Systolic Strain APLAX View

### Inspecting results

After completed tracking, and for APLAX completed AVC timing adjustment, the system displays the Quad screen layout for tracking validation (see page 8-26) and inspection of results for this view.

The screen contains the following result displays:

- Tracked ROI: A dynamic display of the tracked ROI to be used for tracking validation. The tracked ROI has a texture overlay indicating strain values according to the colormap. The overlay may be turned off/on by clicking the Color button.

**NOTE:** *Rejected segments will not have texture overlay.*

- Segmental result ROI: A static display indicating the peak strain value per segment. Rejected segments are displayed with an X instead of a value. Clicking a segment changes its rejection status (See 'Tracking validation' on page 13-216 for more information.)
- Strain traces: A static display indicating the segmental and global strain traces with time. The peak values are indicated.

**NOTE:** *The peak values can be adjusted by clicking and dragging the peak markers with the mouse.*



#### CAUTION

Segments and peak detection should be checked to make sure that non-physiological traces are excluded in the calculation of indices.

- Curved anatomic M-mode: A static display indicating a curved anatomic M-mode along the center of the ROI. The M-mode has a parametric overlay indicating peak strain values.

**NOTE:** *Rejected segments will not have texture overlay.*

**NOTE:** *The Segmental result ROI, Strain traces and Curved anatomic M-mode are using color codes to link the different segments.*

### Cardiac Strain on A4-Ch and A2-Ch views

The procedure for Cardiac Strain on Apical 4-chamber and 2-chamber views is similar to the one used in the APLAX view.

Perform the steps 1,2,3 and 5 from the APLAX procedure.

Perform the tracking validation ('Tracking validation' on [page 13-216](#)) and, optionally, ROI adjustment ('ROI adjustment' on [page 13-216](#)) procedures.



#### CAUTION

If the APLAX view was not analyzed first, the strain values displayed in the Quad screen for the A4CH/A2CH are labeled temporary and may be different after APLAX have been analyzed. The reason for this is that for the A4CH and A2CH views, the AVC time is automatically set based on strain curve peaks (Auto mode). If, during APLAX analysis, the AVC time is manually set, the globally applied AVC time becomes different, causing segmental results to change.



#### CAUTION

If AVC mode is set to Auto, the final value of AVC time is not available before all three views have been analyzed. Thus, strain values displayed in Quad screen of the two views analyzed first are labeled temporary. The reason for this is that the Auto-AVC calculation derived from all three views is most accurate and may be different from the intermediate AVC calculations used for each view.

### AutoEF Layout

The results screen for A4CH and A2CH views also has an AutoEF layout. In this layout, the system presents automatically generated end systolic and end diastolic traces used to calculate ejection fraction (EF), stroke volume (SV), cardiac output (CO), as well as volumes. See 'Auto EF Measurements' on [page 13-231](#) for more information.

**NOTE:** *If both A4CH and A2CH have been analyzed, the system also calculates biplane Simpson EF, SV, CO and volumes.*

**NOTE:** *The EF values (including volume values) provided by running the AFI tool will appear in the Worksheet, Report and in DICOM SR in exactly the same way as EF values provided by running the dedicated AutoEF tool. If first AutoEF is performed and then AFI, there will be two instances of the EF values in the Worksheet.*



### Completed analysis results

When all three apical views have been analyzed, the result screen provides three new Layouts to inspect global function.

- **BE:** Bull's eye presentation with segmental full wall Peak systolic strain color coding and segmental Peak systolic strain values.
- **Traces:** In addition to the Bull's eye, also displays the strain traces for all three views. In this view, it is possible to correct trace peaks by clicking and dragging peak markers or clicking the corresponding segment in the Bull's eye (Figure 8-20).
- **Tracking:** In addition to the Bull's eye, also displays the cineloops for all three views.
- **EF:** Displays EF result.

### Bull's eye standards

The Bull's eye can be configured to display either 18 or 17 segments using either the AFI or the ASE standard (from Config). Consult the Advanced Reference Manual for more information regarding Bull's Eye segmentation formats.



#### CAUTION

If reprocessing a file with a different Bull's Eye standard, the segmental values will change. The system will warn the operator if attempting to reanalyze a stored loop with a different Bull eye's standard

### Bull's eye colormaps

The tool provides a set of different colormaps for the Bull's Eye. The different colormaps are available from the Colormap dropdown menu in the Result stage menu.

The system can be configured to display other color maps (Config). The following colormaps are available:

- **PSS Red-Blue:** Peak systolic strain in a red-blue color coding.
- **PSS-Green-Yellow-Red:** Peak systolic strain in a green-yellow-red color coding.
- **PSI:** Post Systolic Index (PSI) color coding and segmental PSI values in the Bull's eye
- **TTP:** Time-to-peak strain (TTP) color coding and segmental TTP values in the Bull's eye

**NOTE:** *PSI and TTP color maps are based on the global peaks (as supposed to systolic peaks).*

Rejected segments in the Bull's Eye are identified by the peak values being replaced by a X, and that the segment is greyed out in the colorimetric display.

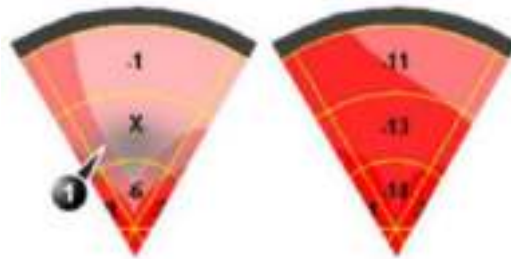

Figure 13-100. Colorimetric display

1. Segment with tracking quality scored as Not acceptable (x).

### Measurements available after complete analysis

The following parameters are also available after completed analysis

- Global Strain (GS) values for all three apical views. In a given view the Global Strain (GS), also called Global Longitudinal Peak Strain (GLPS), is defined as the percentage of maximal contraction over the whole cardiac cycle of the entire myocardial wall relative to its end diastolic length.
- Averaged Global Strain value from all three apical views.
- AVC measurement (either automatic, event timing measurement or manual, see 'Timing Validation' on *page 13-222*)
- PSD: Peak Strain Dispersion is an index that displays variability in time-to-peak (TTP) longitudinal strain. The index is the standard deviation of the TTP strain (of all segments) over the whole cycle. The TTP bulls-eye is useful in association with PSD as the color scheme uses green color to indicate normal contraction with a peak around AVC, blue color to indicate early contraction, and yellow to red color to indicate late contraction.



**CAUTION**

Rejection of non-physiological traces and correct peak detection (see also “Inspecting results” on page 13-223) is particularly important when using the TTP color map, as wrong peaks will influence the PSD index significantly. Peaks detected in very early systole and late diastole should be checked, and traces rejected if they are considered non-physiological.

**Exiting AFI**

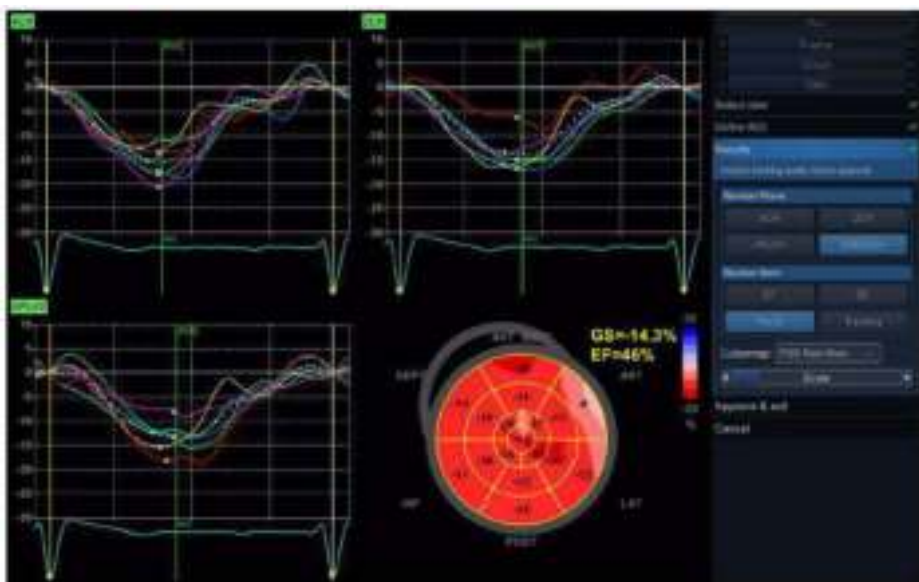

Figure 13-101. Bull's Eye and Trace screen

At any time, the tool can be cancelled by pushing the Cancel button. The plugin will close and any unsaved data will be lost.

When in the Results stage the operator may click the Approve and Exit button. The behavior depends on the number of views analyzed:

- If all three views have been analyzed, the tool will go to the Bull's eye only layout and prompt the operator whether the results should be stored. If Yes is selected, measurements are transferred to the worksheet, and a result file with a screenshot of the Bull's Eye will be generated. See also 'Reprocessing data' on page 13-229.
- If only one or two views have been analyzed, the tool will enter the Quad layout of the most recently processed view

and prompt the operator whether the results should be stored. If Yes is selected, measurements are transferred to the worksheet and a result file with a screenshot of the Quad screen is generated. See also 'Reprocessing data' on page 13-229.

### Peak detection

The peak systolic strain detection for each segment can be verified and manually adjusted as required. To adjust the peak detection:

1. Press Traces. The Bull's Eye and Traces screen is displayed
2. To change the peak marker position on a curve:
  - Click on the peak marker (square point) on one of the curves, move the peak marker to a new position and click again to fix the point.
  - Place the cursor on a segment in the Bull's Eye. The corresponding curve is highlighted. Click on the segment to select the corresponding peak marker and move it to a new position.

The peak type is determined by the selected color map (systolic for PSS, global for PSI and TTP). The position of the AVC marker can also be checked in the Bull's Eye and Traces screen. If needed, the APLAX view should be reprocessed to change the AVC time.

### About the results

Be aware of the following:

- Clinical assessments should be made based on both color and segmental full wall Peak systolic strain values.
- The export function is intended for research purposes and should not be used to archive diagnostic data.
- No values shown in any Result screen will be transferred to the Worksheet unless either Approve and Exit or Approve and select next is pressed.
- All results shown (curves, colors and values) are based on drift compensated values. Any strain drifting is linearly compensated throughout the cycle. If the drift compensation in a given segment is too high, the segment is automatically rejected.
- If more than one segment is rejected, the Global Strain value is not calculated.

### Reprocessing data

The data from one or several views from a saved AFI analysis may be reprocessed.

**NOTE:** *When doing reprocessing, if the operator chooses to store the results, the results will be treated as new analysis with new measurements in the worksheet and a new thumbnail in the clipboard.*

### Reference layer for strain

The tool supports calculation of strain parameters based on either endocardial deformation or myocardial/full wall deformation.



#### CAUTION

Measurements based on endocardial and myocardial analysis are not comparable.

- Endocardial deformation is assessed by performing analysis of the endocardial part of the ROI trace. Measurements derived from endocardial deformation are suffixed Endo, such as for instance GPeakSysSL(Avg)\_Endo
- Myocardial/full wall deformation is assessed by performing analysis of the whole ROI trace. Measurements derived from myocardial deformation are suffixed Full, such as for instance GPeakSysSL(Avg)\_Full

It is possible to change the reference layer preference using the Config screen.

**NOTE:** *If attempting to reprocess an analysis using a different reference layer a warning will be shown informing that the values in the analysis will change.*

### AFI configuration

It is possible to configure some of the AFI controls to modify the workflow slightly.

1. Press Utility > Scanner Apps. Select the AFI tab. The following parameters may be adjusted:
  - Autoprocessing timeout - The time the operator has to keep trackball still before automatic start of tracking.
  - BE Mode - Colormaps that shall be available for the Bulls Eye.
  - BE Segment model - Select the preferred Bulls Eye standard (ASE/AFI, 17/18 segment models).

- ROI Method - Select whether fully automatic or 3-Click ROI shall be the tool default.
- YoYo - When adjusting the ROI, select whether a limited number of frames around the selected ROI frame should be looped back and forth to ease ROI adjustment.
- Strain reference layer - Select whether the strain values shall be calculated based on endocardial or full wall tracking.
- AVC Stage mode - Select whether to always open the AVC Selection stage. If “Auto” is selected, upon analysis of the APLAX view, the user will be taken to Results stage after the ROI stage. “Auto” AVC or Event timing will be used by default. It will still be possible for the user to re-visit the AVC Selection stage to edit the chosen AVC.
- Prioritize event timing - Select “yes” to use “event timing” values for AVC if there are some in the current exam and AVC Stage mode is on “Auto”.
- Positive Peak Rule - If On, then a positive strain value will be shown if the maximum positive peak exceeds 30% of the maximum negative peak, resulting in a blue segment in the Bull’s Eye. If Off, then the negative strain value will be shown regardless of the size of the positive peak.



Figure 13-102. AFI Configuration

# Auto EF

## Auto EF Measurements

Automated Ejection Fraction (AutoEF) is a semi-automatic measurement tool used for measurement of the global EF (Ejection fraction). The AutoEF tool is used as an optional decision support tool.

The AutoEF tool is derived from a 2D speckle tracking algorithm which tracks and calculates the myocardial tissue deformation based on feature tracking on 2D grey scale loops.

AutoEF is performed on either one or both apical 4-chamber or 2-chamber views, in any order.

The result is presented as Ejection Fraction value, calculated by Simpson MOD for each view and MOD Bi-plane Ejection Fraction for the whole LV. All values are stored to the worksheet when approved.

## Acquisition

*NOTE: AutoEF is only available on the M5Sc-D probe.*

1. Create an exam, connect the ECG device and make sure to obtain a stable ECG trace.
2. Acquire B-Mode cine-loops of an Apical 4 chamber view (4-ch) and an Apical 2 chamber view (2-ch).

## Acquisition requirements

- The frame rate should be between 37 and 80 frames per second. A higher frame rate is recommended for high heart rate.
- LOGIQ Totus should be configured to store at least 100 ms before and after each heart cycle.
- If the acquisition has more than one heart cycle, the analysis will be done on the second last heart cycle.
- The entire myocardium should be visible.
- A depth range that includes the entire left ventricle should be used

### Starting AutoEF

1. Recall any one of the stored views and press **Measure**.
2. Select **AutoEF** either in Measure menu or on touch panel.

The tool will launch and start up in the Select View stage.



#### CAUTION

AutoEF is only recommended for adult cardiac images acquired with the M5Sc-D probe. The measurement accuracies of the 2D Auto EF measurement values reported in the Reference manual are verified with M5Sc-D probe.

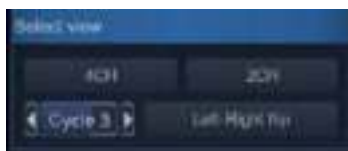

Figure 13-103. Select View Stage

### AutoEF on the A4CH view

1. When in Define ROI stage: Verify that the view annotation shown to the upper left of the screen is correct. If it is not, either:
  - Click the Select View stage button to reannotate to the correct view and proceed analyzing that image.
  - Click on an A4CH image in the clipboard. This will discard analysis of the current loop and replace it with the one selected from clipboard. The tool will start in the Select view stage where it should be annotated as A4CH.

Pay attention to the left/right orientation of the image by comparing the LV wall names with a visual inspection of the image. If the image orientation is wrong:

- Go back to the Select view stage.
- Press Left-Right Flip.
- Verify the view by annotating it as A4CH again

**NOTE:** *You may alternatively exit AutoEF, invert the image and start AutoEF again.*

2. An automatic endocardial ROI is generated when entering the Define ROI stage. The ROI may be edited by clicking and dragging on the endocardial and epicardial contours. See 'ROI adjustment' on *page 13-216 for more information..*



3. When satisfied with the ROI, either stop moving the cursor and wait for automatic processing or click on the Process button. Now the system tracks the ROI with time. On completion, it proceeds to show the results in the EF result screen. The tracking must be visually controlled and validated as described below.

## EF results

The Results stage opens with a multi frame EF result layout.

- The running loop is shown on the left. A green dotted line marks the inner border of the chamber. In case of poor tracking, the system automatically displays parts of the border in red.
- The frames with the maximal volume (ED) and minimal volume (ES) are displayed on the right side.
  - Press EF Dual to only display the ED and ES frames.
- The End Diastolic volume (EDV), the End Systolic Volume (ESV) and the resulting Ejection Fraction (EF) are displayed. Results for each view are summarized in a table on the right side.

## Tracking Validation

- Inspect the ROI traces for the end systole and end diastole.
- If the tracking results are visually correct, you may press Approve and Exit to exit the tool and store the values to the worksheet, so they can be used in a report.

## Possible causes of poor tracking

Poor tracking quality could result from a variety of causes. The common causes for bad tracking are:

- Erroneous placement of the basal points when defining the border. If the basal points are placed too far from the annular region, the border segments at the annular base will not move together with the underlying 2D image throughout the entire heart beat.
- Erroneous placement of the apex point when defining the border. The point should be placed so that the resulting border trace covers mainly the endocardium. If the apex

point is placed too high, the border trace will mainly cover the epicardium resulting in poor tracking.

- Too much clutter. Images with too much static clutter will result in poor tracking.

### Tracking correction

The following can be done if tracking needs correction:

- Press EF dual to display ES and ED frames side-by-side.
- Adjust ES frame and ED frame controls if different frames need to be selected for ES and ED.
- Edit misaligned points on the endocardial border trace as described on 'Editing the endocardial border trace' on page 8-47.
- Create a new endocardial border trace (See 'To create a new ROI' on *page 13-218 for more information.*)

### Possible causes of poor tracking

- Erroneous placement of the basal points when defining the border. If the basal points are placed too far from the annular region, the border segments at the annular base will not move together with the underlying 2D image throughout the entire heartbeat.
- Erroneous placement of the apex point when defining the border. The point should be placed so that the resulting border trace covers mainly the endocardium. If the apex point is placed too high, the border trace will mainly cover the epicardium resulting in poor tracking.
- Too much clutter. Images with too much static clutter will result in poor tracking.

### Trace adjustment of the endocardial border

If the automatic endocardial border detection is not optimal the user can either adjust the trace or create a new trace as described below.



CAUTION

Poor tracking quality may lead to incorrect measurement results. The tracking must be visually controlled and validated.

### Editing the endocardial border trace

- Enter the Define ROI stage.
- Adjust the trace by moving the cursor over the endocardial border trace, select an anchor point and drag it to a new location. The shape of the endocardial border trace is updated accordingly.

In the upper right of the screen there is a pictogram indicating the core features of a good APLAX AutoEF ROI.

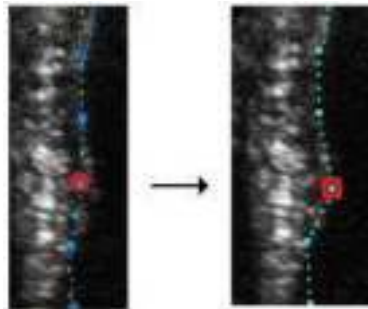

Figure 13-104. Moving an anchor on the trace

### To create a new ROI trace

The system automatically displays a frame where the endocardial border is usually clearly visible. To use another frame, while in Define ROI stage, pause the playback by pressing Stop. Then, use the Frame slider (or rotary) to select a different frame for ROI definition.

To create a new automatic ROI, click the Reset stage button. This relaunches the automatic segmentation.

Sometimes the automatic ROI may fail to capture the correct ROI. In this case, a 3-Point ROI alternative is provided.

To generate a ROI by this method, when in Define ROI stage, click on the button 3-Click. The AutoEF tool will now prompt to click 3 landmarks. Follow the indications displayed on the screen when placing the three points.

When the third landmark is selected, a ROI is generated and can optionally be edited as for the automatic ROI.

**NOTE:** *If the ROI needs to be adjusted make sure to make the changes immediately after the ROI is displayed, before the auto processing of the ROI begins.*

**NOTE:** *The timing when auto processing of the ROI will start is configurable (from Config).*

**NOTE:** *The Yo-yo function is turned on to help find correct location for the points.*



Figure 13-105. Tracing the Endocardial border

### Exiting AutoEF

At any time, the tool can be cancelled by pushing the Cancel button. The plugin will close and any unsaved data will be lost.

When in the Results stage the operator may click the Approve and Exit button. The tool will enter the dual layout of the most recently processed view and prompt the operator whether the results should be stored. If yes, measurements are transferred to the worksheet and a result file with a screenshot of the dual screen will be generated. See 'Reprocessing data' on page 13-229 for more information.

### Reprocessing data

The data from a saved AutoEF analysis may be reprocessed.

**NOTE:** *When doing reprocessing, if the operator chooses to store the results, the results will be treated as new analysis with new measurements in the worksheet and a new thumbnail in the clipboard.*

1. Single view analysis stored
  - Double-click on the thumbnail showing the AutoEF dual screen result layout. A dual screen is displayed,

showing the dual view result screen and the cineloop processed in that analysis.

- Launch AutoEF. The tool will proceed to the Results stage. You may choose to reprocess the view already analyzed or to complete the analysis adding the missing view to the analysis.

2. Both views analysis stored

- Double-click on the thumbnail showing the AutoEF dual screen result layout. A quad screen is displayed, showing the dual view result screen of the last processed view and the cineloops processed in the analysis.
- Launch AutoEF. The tool will automatically proceed to the Results stage of the last processed view. You may choose to reprocess the views already analyzed or even replace the cineloops used in earlier processed views.

## Overview

A physiological input panel is available for the LOGIQ Totus. This panel has inputs for ECG signals.

The physiological module consists of this channel:

1. ECG

The scanned image that is displayed is synchronized with the ECG traces. In Doppler or M-Mode, the traces are synchronized to that particular mode's sweep.

Approved accessory cables provide the proper signals to the Physiological Panel.



CAUTION

There will be a slight time gap between the ECG signal and the Doppler waveform when the selected PRF is low (less than 1.0 kHz).



CAUTION

To avoid skin burns in surgical use, do not place ECG electrodes in current path between Electrosurgical Unit (ESU) active and dispersive electrodes. Keep ESU cables away from ECG leads.

To display the ECG Signal on the monitor, go to Utility--> Imaging--> General--> ECG Display.

## Overview (continued)



Figure 13-106. Optional Physiological Input Panel



### WARNING

- Do not use with a defibrillator except with DEFIBRILLATION PROOF APPLIED PARTS. Only the ECG connection port is a defibrillator proof applied part.
- DO NOT USE the physiological traces of the LOGIQ Totus Ultrasound system for diagnosis and monitoring in lieu of ECG.
- Only approved and recommended peripherals and accessories should be used.
- After the defibrillator stimulates the patient, the ECG requires 4 to 5 seconds recovery time.

## ECG Cable

The ECG Cable is a modular cable consisting of two different cable parts:

- Single cable with a system connection at one end and a cable splitter at the other.
- A triple color-coded electrode cable to be inserted into the splitter device. Each electrode cable hooks up to the appropriate stick-on electrode by a color-coded clip type connector.

The color-coding of the electrodes follows one of two standards that are common in different parts of the world. The cable splitter device has a drawing defining the color codes, names and body location for the two standard color codes.

Table 13-50: ECG Color Code Cable

IEC (Europe, Asia, ROW)		AHA (USA)		Position of the human body surface
Electrode Mark	Color Code	Electrode Mark	Color Code	
R	Red	RA	White	Right Arm
L	Yellow	LA	Black	Left Arm
F	Green	LL	Red	Left Leg



## Physiological Trace Monitor Display

The scanned image is synchronized with the ECG trace. In Doppler or M-Mode, the traces are synchronized with that particular mode's sweep.

The user can control the gain, position and sweep speed of the traces using the Touch Panel controls.

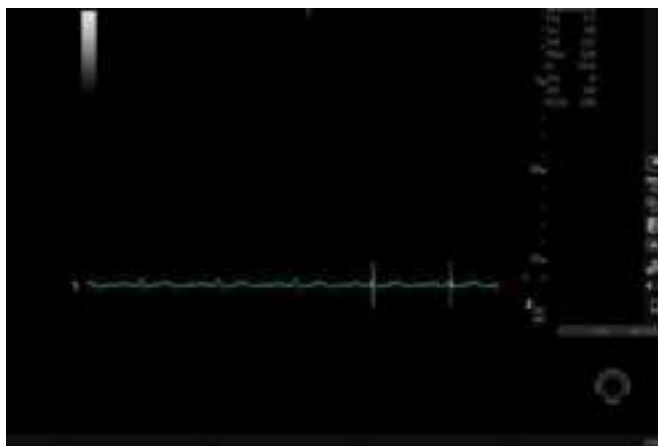

Figure 13-107. Physiological Trace Monitor Display

1. ECG
2. Auto Heart Rate Display

## ECG Touch Panel

The ECG Touch Panel provides for control of the physiological input signals.

Without the ECG option, the ECG Touch Panel is not displayed.

Table 13-51: ECG parameters

Parameter	Description
Sweep Speed	Change the speed of the trace. The sweep speed of the physio signal on the B-Mode image can be set independent of the timeline (Doppler and M-Mode) sweep speed. Value: 1 - 16.
ECG Lead	ECG Lead Pattern: 1, 2, 3 1: RA (-) to LA (+) (Right, Left, or Lateral) 2: RA (-) to LF (+) (Superior Inferior) 3: LA (-) to LF (+) (Superior Inferior) <i>NOTE: RA=Right Arm; LA=Left Arm; LF=Left Foot</i>
Timer Trigger	Enables intermittent imaging based on a timer. <i>NOTE: If Timer Trigger is turned on, the ECG Trigger is set to None.</i> Value: On or Off.
ECG Trigger	Enables intermittent imaging based on the ECG. The trigger location(s) relative to the R trigger are set with the Delay Time key. Adjusting: Press ECG Trigger and select one of the options and adjust the delay time using the Delay Time key. <ul style="list-style-type: none"> <li>• ECG Trig 1 specifies the delay (ms) from R-wave to triggered frame.</li> <li>• ECG Trig 2 specifies the delay from R-wave to second frame.</li> <li>• Both activates ECG Trig 1 and ECG Trig 2 simultaneously. Trig 2 must be greater than Trig 1 for dual triggering (Both) to be active.</li> </ul> <i>NOTE: If other than None is selected, Timer Trigger is turned off.</i> Value: None, Trig1, Trig2, and Both.
ECG Display	Provides the ability to turn on the ECG trace and Auto Heart Rate for display on the monitor. Adjusting: When the key is selected, the ECG trace and Auto Heart Rate toggles between on and off. Value: On or Off

Table 13-51: ECG parameters (Continued)

Parameter	Description
ECG Trigger Period	<p>The control specifies the number of heart cycles (R-waves) that are skipped between ECG triggers.</p> <p>The default is 1 or no skipping; 2= skip 1 cycle.</p> <p>Adjusting: Adjust the corresponding control.</p> <p>Value: 1 - 30</p>
Delay Time	<p>In ECG Trigger Mode: If only ECG Trig1 or ECG Trig2 is selected via the ECG Trigger key, the Delay Time key controls the R-Delay time of the active trigger. If both triggers are selected (Both), press this key to toggle ECG Trig1 and ECG Trig2 and rotate the key to change the delay time. Once the trigger is set, the snap shot image is displayed each time the update line passes the active trigger(s).</p> <p>In Timer Trigger Mode: Rotating the knob changes the delay time between images.</p> <p><i>NOTE: Delay time may be different for Trig1/2 (0-2 seconds) and Timer Trigger.</i></p> <p>Adjusting: Adjust the corresponding control.</p> <p>Value: 0.10 - 10.00</p>
ECG Gain/Position	<p>Allows for the amplitude control of the ECG trace or allows for the vertical positioning of the ECG trace on the image display.</p> <p>Adjusting: Press the knob to toggle between Gain and Position. The default is Gain.</p>

# Volume Navigation

## Introduction



### DANGER

DO NOT use the Volume Navigation feature on any patient relying on life-sustaining electronic equipment, such as a pacemaker or defibrillator. Failure to follow this instruction could lead to interference with patient electronic device(s).



### CAUTION

When performing interventional procedures, remember that the pre-acquired dataset is not live and should not be used as sole guidance for interventional procedures.

Using a position sensor attached to the probe, or using a probe with V Nav Inside, Volume Navigation Fusion (V Nav) lets you import a pre-acquired DICOM volume dataset, register the location of the live Ultrasound image with the 3D volume image, and then use the position sensing system to simultaneously show the live Ultrasound image side-by-side with the corresponding multi-planar reformatted (MPR) slice from the pre-acquired dataset.

**NOTE:** *DICOM datasets must have positional data to allow for V Nav to treat the datasets as a volume. Most CT, MR, and PET datasets have this information as do some X-Ray Angiography datasets.*

In addition, you can use V Nav as a type of “GPS” positioning marker to track an anatomy of interest.

The V Nav Trackers allow you to use a V Nav sensor to track where the needle/needle tip is inside the body.

V Nav is available in B-Mode, Color Flow, Elastography, PDI, and Contrast Modes; it is not available while in 3D/4D or when timeline modes are active. Biopsy capability is available while in V Nav. Dual Caliper is available while in V Nav.

You can load Auto Sweep data for V-Nav, after the data stored as volume data in Easy 3D/Advanced 3D.

## Introduction (continued)

V Nav displays in Split Screen, with the Ultrasound Image on the left side of the display and the 3D Dataset on the right side of the display.



Figure 13-108. V Nav Example

## V Nav-Specific Definitions

**3D Datasets.** Computed Tomography (CT)-, or Magnetic Resonance Imaging (MR), Positron Emission Tomography (PET), XA (X-Ray Angiography), hand held SPECT datasets (NM) and Invenia (US) series stored in DICOM format. Ultrasound datasets acquired using Tru3D and AutoSweep.

**Registration.** Linking the 2D Ultrasound image to the 3D dataset. You can register the 3D dataset to the Ultrasound image via two techniques, Parallel Plane Registration or Point Registration.

**Auto Registration.** Auto-registration is available when fusing to a Tru3D dataset. When entering V Nav directly from a Tru3D acquisition, the Tru3D volume is automatically loaded into V Nav and automatically registered.

**Parallel Plane Registration.** This registration technique requires that the user mark a plane parallel to the 3D dataset slices and one common anatomical point, referred to as a Translation Point since it performs an x, y, and z correction at the point.

### V Nav-Specific Definitions (continued)

**Point Registration.** This registration technique requires that the user mark three or more anatomical point pairs. Performing a Plane Registration first may make the process of matching the anatomical point pairs easier.

**Anatomical Point Pair.** Marking the same anatomical location in the 2D Ultrasound and the 3D dataset creates an anatomical point pair.

**Lock.** After you have set the registrations between the 2D image and 3D dataset by either plane or point registration, you lock this registration in place. This means that the image content of the B-Mode image and the corresponding cut plane through the 3D dataset remains the same when you move the probe.

**Magnetic Distortion.** A magnetic field is generated by the position sensing system. It can become distorted in the presence of ferrous or highly conductive metal.

**Environmental Quality.** On-screen visual quality map that indicates distortion and proximity to the transmitter. Monitoring and controlling these two variables contribute to the highest quality environment.

**RMSD, Root Mean Square Deviation.** Root Mean Square Deviation, which equals the 'goodness' of fit. After the user has completed a Point Registration, there's a numeric indicator to describe the goodness of fit. The lower the number, the better the fit. <1 to 10 would be good, 30-40 not so good.

**Window Levelling.** Balances the brightness/contrast in the 3D Dataset.

**Position Sensing System.** Consists of four components: Transmitter, Receiver (2), Probe Bracket, Probe/Receiver Cable Clips.

**GPS Marker.** Used in GPS to track the position of an anatomical structure while scanning or while performing a biopsy.

**Virtual Tracker .** The V Nav Virtual Tracker allows you to attach a sensor to the shaft of the needle (away from the tip). The position of the needle tip and the projected needle path are projected onto the 2D Ultrasound image.

## V Nav-Specific Definitions (continued)

**Active Tracker.** The Active Tracker is a device that consists of at least four markers that show up in a volume imaging dataset such as CT or MR. The markers are in known positions relative to each other such that the orientation of the Active Tracker can be uniquely determined based on the marker positions in the image. The device also holds a position sensor in a known position relative to the markers. Holes are provided in the Active Tracker so that its location can be marked on the body.

**Needle Tip Tracker.** The V Nav Needle Tip Tracker allows you to insert a V Nav tracker inside the Needle to track the projected path and needle tip location inside the body.

**Clinical vs. Research.** You can specify which V Nav controls you want to appear on the Touch Panel. You can set these via Utility -> Application -> Imaging Controls -> Clinical Controls V Nav.

## Environment Quality

In order to obtain best results when registering, setting GPS markers, it is important to have the highest quality environment (minimal distortion and proximity to the transmitter).



Figure 13-109. Environmental Indicator

An Environmental Quality reading for each sensor is provided via the Environmental Quality indicator (located in the upper, left-hand corner of the display).

### Environment Quality (continued)

Each sensor has a quality reading from 1 (low quality) to 7 (high quality). In addition, the distance between the two probe sensors is used to adjust the environmental quality reading presented to the user.

If needle tracking is being used, an overall environmental quality reading is provided.

The Overall Environmental Quality reading is based on the environmental quality readings of the probe sensors and the needle sensor as well as the distance between the needle tip and the transducer face.

The environmental quality readings update in real time and are retained so that they can be displayed during cine scrolling.

Moving the cursor over the Environmental Quality indicator for each sensor provides the following information:

Sensor 1 displays a quality reading.

Sensor 2 displays a quality reading and a Distortion reading between the 2 probe sensors in [mm]. The magnetic distortion is represented as a measured distance between the two sensors relative to the expected distance between the two sensors.

The Needle Sensor displays a quality reading.

The Overall indicator displays an overall Quality reading, and a Probe to Tip distance in cm.

### Calibration

To calibrate V Nav, contact GE HealthCare Service.

### Configuration

You can specify the maximum retrospective loop length to store via Utility -> Application -> Print controls -> Time span.

### Accuracy

Accuracy depends on precise registration, minimal distortion, and controlling the patient's breathing during a scan.



## **Load the Volume Dataset**

If you are using media to load the 3D dataset, you may want to store the CT, MR, PET, XA, DX, NM or Invenia Dataset on a USB flash drive, USB HDD so that you can clearly label the media in a way that identifies the patient information stored on the disk.

We recommend that you load the 3D Dataset onto the Ultrasound system prior to starting the V Nav exam to ensure that it loads properly and to ensure that the quality is acceptable.

Ultrasound volume datasets need to have been acquired using Tru3D, i.e., a volume dataset that was previously acquired using a position sensor.

### Query/Retrieve

**NOTE:** For Query/Retrieve to find a patient, the patient **MUST** have a Patient ID.

### Query



Figure 13-110. VNav Query

1. Press **Patient** and select **Data Transfer**. The Data Transfer screen displays.
2. Select Q/R.
3. Select the Query/Retrieve server from the Transfer From pull-down menu.
4. Type Patient name in the name field.
5. Press **Query** in the Transfer From section.
6. All studies for that patient and that modality will list.

## Retrieve

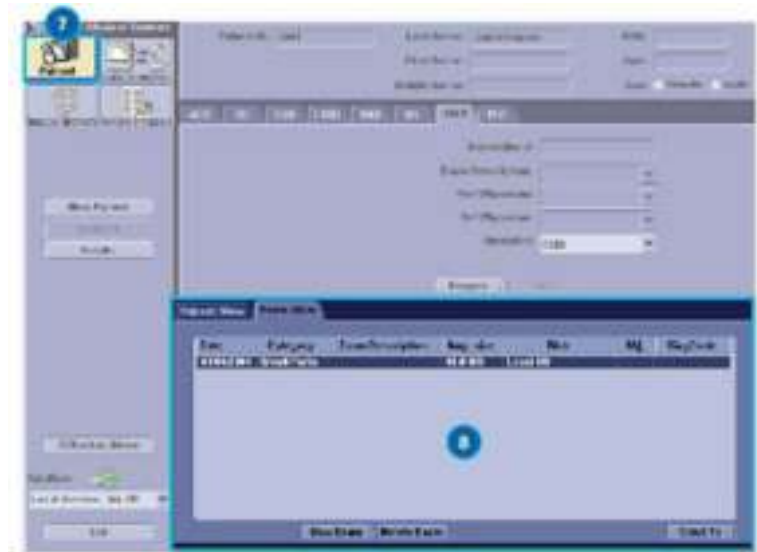

Figure 13-111. VNav Retrieve

7. Select the specific series or study which use in V-Nav exam.
8. Press **Transfer**.

**NOTE:** *Transfer time will vary based on network and file size.*

## Load DICOM Volume Dataset

Load a pre-acquired 3D DICOM volume dataset,

- Exit and re-enter V Nav and retain the 3D Dataset by pressing the V Nav control.

OR,

Discard the pre-acquired 3D Dataset,

- Press Exit and Clear on the Touch Panel.

### From USB

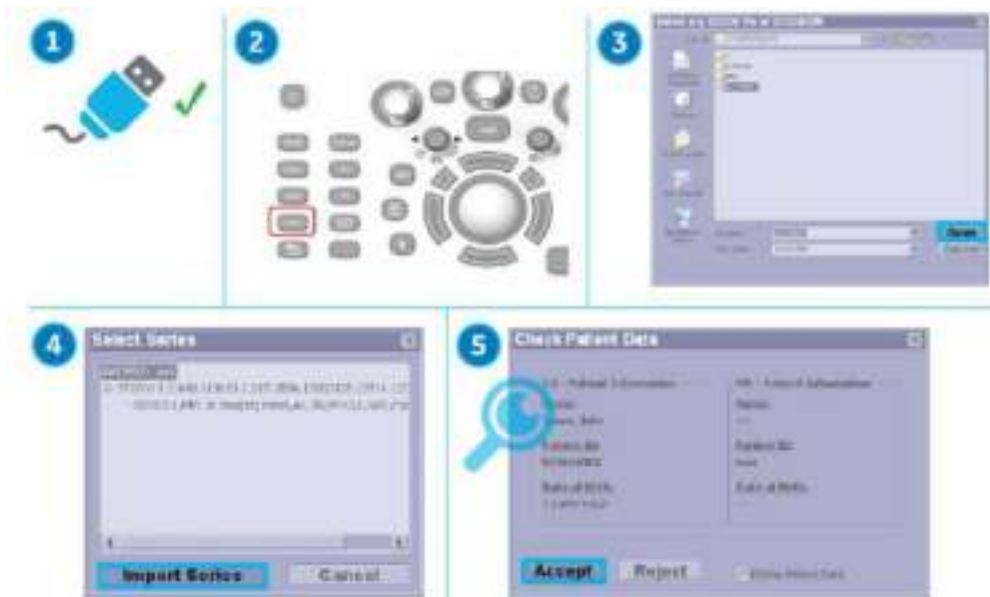

Figure 13-112. Loading Dataset From USB

1. If applicable, insert the media containing the pre-acquired 3D dataset. Volume datasets that can be loaded from disk may include CT, MR, PET, XA, DX, CBCT, and GE HealthCare ABUS (US).
2. Select VNav. Press **Load** and select **From USB**.
3. Double click on the DICOMDIR or database file (or single click and select the Open button).

**From USB (continued)**

4. Navigate to the location of the 3D dataset. A list of patients and a list of image series for each patient displays. Highlight the Series you want to import and select **Import Series**.
5. The Check Patient Data screen appears. Confirm that the patient information matches the patient associated with the current exam. After verifying patient information, press **Accept** (or Reject). You can also specify to display Patient Data by checking the Display Patient Data box.

If you turn on "Display Patient Data", Patient name, ID and birth date are displayed on the Volume data. These remain on the live scanning image.

**NOTE:**

*If Hide Patient Data preset or Hide Date Time preset (Utility->System->General) is set to "On Store", then the patient data is removed from the volume dataset prior to image storage and then redisplayed after image storage.*

6. B-Mode image displays on the left side and the loaded volume data displays on the right side.

### From Database

**NOTE:** Volume datasets that can be loaded from the database: CT, MR, PET, XA, DX, CBCT, and GE HealthCare ABUS (US).

1. Press **Load** and select **from Database**.
2. Select the desired volume from the Image History screen and press **Load**.
3. The Check Patient Data screen appears. Confirm that the patient information matches the patient associated with the current exam. After verifying patient information, press Accept (or Reject). You can also specify to display Patient Data by checking the Display Patient Data box.

If you turn on "Display Patient Data", Patient name, ID and birth date are displayed on the Volume data. These are remained on the live scanning image.



Figure 13-113. Check Patient Data Dialog

**NOTE:** If Hide Patient Data preset or Hide Date Time preset (Utility->System->General) is set to "On Store", then the patient data is removed from the volume dataset prior to image storage and then redisplayed after image storage.

**NOTE:** If you load a Tru3D volume data, Check Patient Data is not displayed.

**NOTE:** If you Load From Database and want to cancel out, use the Exit button on the Image History screen.

4. B-Mode image displays on the left side and the loaded volume data displays on the right side.

## Load Multi Volume Datasets

You can load multiple datasets (up to 10 datasets) of same study at the same time:

When loading multiple volume data at the same time, they must all be configured in the same direction (eg, Axial plane).

Sometimes there are multiple acquisitions stored within a single series. When you select Load All, these are loaded as one dataset (if they are not overlapping) or as two datasets (if two or more datasets are overlapping).

1. Load dataset From USB, check data of the Select Series pop-up.



Figure 13-114. Select Series pop-up

Load dataset from database, select one image from each exam and press **Load** in the Image History screen.



Figure 13-115. Image History screen

Load Multi Volume Datasets (continued)

2. V Nav screen and multiple dataset menu are displayed.

Table 13-52: Multiple dataset menu

	Item	Description
	1-5	Dataset List (CT and PT in this example)
	1	Display Color
	2	Active Dataset Indicator
	3	Active Dataset
	4	Name of dataset
	5	Display Weighting
	6-12	Control Area
	6	Single Display
	7	Multiple Overlapping Display
	8	Volume-to-Volume Registration
	9	Compare Volume
	10	Color Control
	11	Delete
	12	Expand/Collapse Dataset list



## Load Multi Volume Datasets (continued)

Using the Touch Panel control, you can adjust:

Table 13-53: Touch Panel Controls

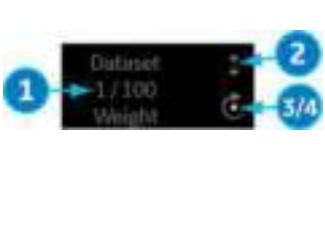
	Item	Description
	1	Dataset number and its Weight (%)
	2	Toggle Up/Down: Select the dataset.
	3	Push: Fix the selected dataset.
	4	Rotate: Weight Dataset. You can weight the overlay amount of the volume dataset.

**NOTE:** When you select **Save Volume** on the Touch Panel, all volumes are saved to a single file on the Clipboard, including GPS Markers.

## Load additional volume datasets

Whenever a dataset is loaded and you want to load another dataset From USB, from clipboard or from a database or if you generate a Tru3D dataset and then switch then back to VNav, the system asks you if you want to add the dataset as an additional dataset or to replace the existing dataset(s).

If you choose to add the dataset, the necessary adaption of the datasets with regard to size and resolution will be performed automatically at the end of the load.

## Easy Access to PACS

The LOGIQ Totus is set up to easily receive exams from PACS.

The system displays DICOM image transmission status at the bottom of the screen as:

- Incoming DICOM Images: In Progress.
- Incoming DICOM Images: Completed.
- Incoming DICOM Images: Failed - check spooler.

Refer to the Spooler to identify specific failed operations.

User operation takes precedence and will cancel any ongoing image receive operation.

### Setting Up V Nav sensors

#### Positioning Rules



CAUTION

When using fusion or GPS Markers, it is important to place the transmitter so that its location does not move relative to the working space. If you rearrange the working space (patient or transmitter location), you need to redo the registration or replace the GPS marker.



CAUTION

Place the transmitter such that the entire area of interest is in the front hemisphere of the transmitter. The front hemisphere generates the magnetic field used by the system.

The transmitter needs to be placed such that the face of the transmitter opposite of the cable (the field side) faces the working area

To avoid magnetic distortion, the following is recommended:

- Remove all ferrous or highly conductive metal from the vicinity of the transmitter and the working area.
- If the patient's bed contains ferrous or highly conductive metal, place the transmitter 20cm or more above the bed so that the central portion of the magnetic field sits well above the bed.
- To check for magnetic distortion, place a phantom that can be scanned from multiple directions in the planned working space. Using the 2D Marker on the GPS control on the Touch Panel, select Point. Scanning the phantom, place the Windows Pointer on a specific point in the phantom and then scan the same point from different directions. The distance between the graphical point (green cross) and actual structure is an indication of the amount of error. Larger than expected discrepancies could be the result of metal distortion or the transmitter field could be facing the wrong direction or be too far away from the working area.

## Setting up the Position Sensing Apparatus

To set up the position sensing apparatus,



### CAUTION

For accurate image registration, ensure that you connect the two probe position sensors to the probe as described in the instructions below. Match the numbers when you attach the sensors connectors to the sensor unit.

1. Attach the receiver probe bracket to the probe. Ensure that it is attached securely.
2. Fix the position sensor to the bracket.

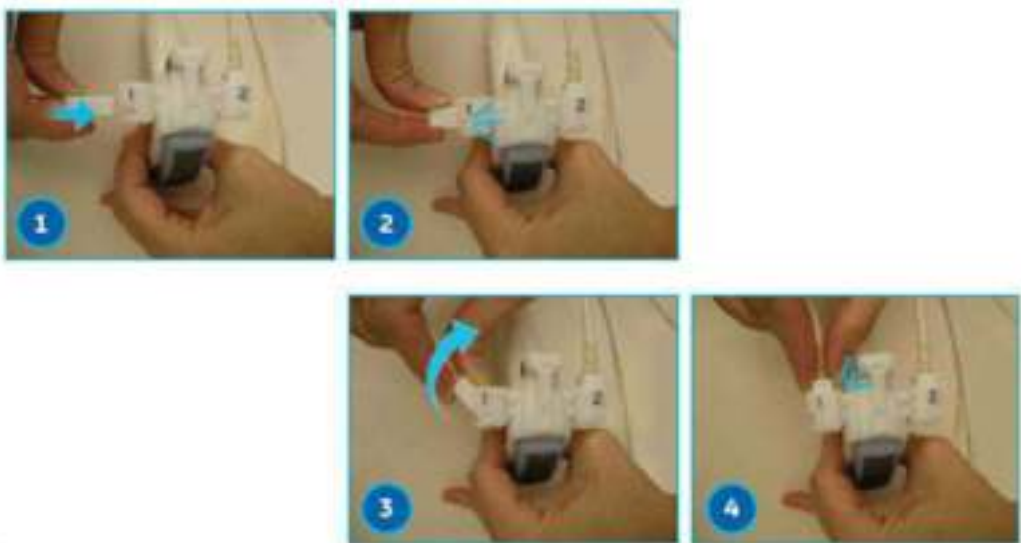

Figure 13-116. Set up the position sensor

1. Position the sensor's nub to the bracket's indentation.
2. Push the sensor into the bracket.
3. Tilt the sensor to position it in the bracket.
4. Tilt the sensor until positioned firmly in the bracket.

## Setting up the Position Sensing Apparatus (continued)

3. Connect the receiver cable from the Position Sensor to the front of the Ultrasound system.

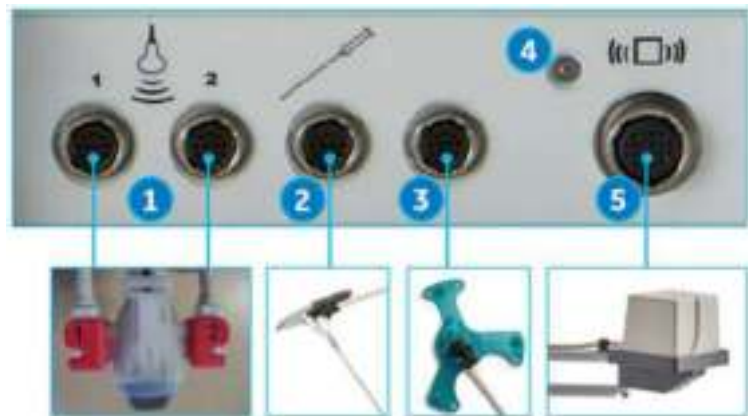

Figure 13-117. Volume Navigation Connections

1. V Nav Receiver Connector (2 cables)
  2. V Nav Needle Tip Tracker/Virtual Tracker Sensor Connector
  3. V Nav Active Tracker Connector
  4. V Nav Transmitter Indicator
  5. V Nav Transmitter Connector
4. Trace back each cable physically to insure the cable in position 1 on the probe is connected to position 1 on the console and that the cable in position 2 on the probe is connected to position 2 on the console.
  5. Use the probe/receiver cable clips to hold the receiver cables to the probe cable.
  6. Attach the transmitter cable to the front of the Ultrasound system where the transmitter label is shown.



### CAUTION

Place the transmitter such that the entire area of interest is in the front hemisphere of the transmitter (indicated by the '1' in the illustration above). The front hemisphere generates the magnetic field used by the system.

## Setting up the Position Sensing Apparatus (continued)

7. Now that all the cables are connected, press the **V-Nav** key. The light above the transmitter cable blinks until the position sensing system has been initialized by the system. Once initialization is complete, the light remains green.

**NOTE:** *Error message displays if the connection is incorrect.*

8. Place electromagnetic transmitter next to patient with front toward scanning area of interest.

**NOTE:** *Be sure patient and sensors are on the best position to start the exam.*

**NOTE:** *Patient must be in the same position as in the previous acquired exam.*



### CAUTION

If you need to connect/disconnect sensors, first use the V Nav key to exit V Nav. If you need to connect/disconnect the transmitter, make sure the light on the V Nav position sensing system is off. If it is on, enter V Nav and use the Exit & Clear Touch Panel control to leave V Nav.

## V-Nav Inside Probe

V Nav Inside is a feature where the V Nav sensor is not external to the probe but is part of the probe.

Probes with V Nav Inside transmit/receive automatically after you activate V Nav.

### Activate V-Nav

1. Begin an exam and optimize the image.
2. Press **V Nav** to activate Volume Navigation.
3. Perform Volume Navigation.
4. Press **V Nav** to exit V Nav. The following actions also exits V Nav: switching probes, recalling an image from the clipboard, starting a new patient, ending an exam, or selecting Exit and Clear from the Touch Panel.

### V Nav Controls

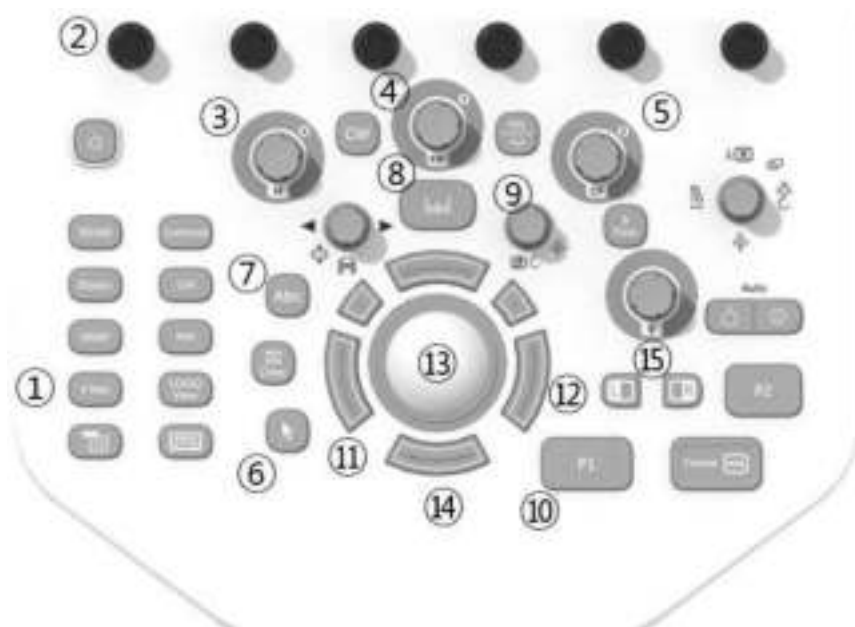

Figure 13-118. V Nav Controls

- |   |  |
|---|--|
| 1. V Nav On/Off                             | 9. Zoom and Depth                              |
| 2. Touch Panel and Joystick Rotary Controls | 10. P1   |
| 3. 3D Dataset X Axis Rotation Control       | 11. Left Set                                   |
| 4. 3D Dataset Y Axis Rotation Control       | 12. Right Set                                  |
| 5. 3D Dataset Z Axis Rotation Control       | 13. Trackball                                  |
| 6. Windows Pointer                          | 14. Bottom Trackball key locks the V Nav Plane |
| 7. Comment                                  | 15. Left/Right Key: Switches Display Mode      |
| 8. Measure                                  |  |

## V Nav Touch Panel

### V Nav Setup Touch Panel Menu

Prior to using V Nav, set up the following parameters:

Table 13-54: V Nav Volume Touch Panel descriptions

VNav Parameter	Description
Load	Loads the 3D Dataset From USB (USB storage device) or From Database.
Save Volume	Saves current volume, including any GPS markers shown in the volume.
Patient Data Check	Confirms patient's data
Reference Sensor	Specify which sensor you are using.
Orientation	Select Axial, Sagittal, or Coronal
Orientation Markers	Places orientation markers on the image.
Display Mode	Select Ultrasound only, 3D only, or Split Screen (both)
Clear/Reset	Allows you to clear plane registration(s), point registration(s) or reset all, which clears all registrations and resets the 3D Dataset to its initial position.
Exit and Clear	Clears the current 3D Dataset and exits V Nav; the 3D dataset is no longer available.
Virtual Tracker	Setup and select the Virtual Tracker. [Appears when the Virtual Tracker is present.]
Active Tracker	Select the Active Tracker sensor.
Window/Level (or Center/Width) Rotary	Set the brightness/contrast for the 3D Dataset. To set the brightness, adjust the Level; to set the contrast, adjust the Window.

## V Nav Touch Panel Menus

Table 13-55: V Nav Touch Panel 1 Descriptions

V Nav Parameter	Description
Scan	Specifies which image is moving with probe motion: Ultrasound (US), 3D, or Both
Registration	Select the type of Registration, Plane, Point/All, Point/Best 3, or None. Auto Registration is an additional choice if a Tru3D Ultrasound dataset is loaded using auto registration.
Save Current Registration	Select to save the current registration
Control Priority	Specifies the priority of shared image controls: Ultrasound image or 3D Dataset.
Restore Registration	Select to restore a stored registration.
Display Mode	Select Ultrasound only, 3D only, or Split Screen (both)
Clear/Reset	Allows you to clear plane registration(s), point registration(s) or reset all, which clears all registrations and resets the 3D Dataset to its initial position.
Overlay	Displays the 3D dataset superimposed on top of the Ultrasound image.
Overlay Brightness	Adjusts the intensity level of the 3D Dataset.
Overlay Weight	Adjusts the intensity level of the 3D Dataset.
Show Needle Tip	Shows or hides the needle graphics. [Appears when the Needle Tracker is present.]



**V Nav Touch Panel Menus (continued)**

Table 13-56: V Nav Touch Panel 2 Descriptions

<b>V Nav Parameter</b>	<b>Description</b>
Save Volume	Saves current volume, including any GPS markers shown in the volume.
Measure Accuracy	Press Measure Accuracy, then select a point on both the 2D Ultrasound image and on the 3D Dataset to tell you the distance as an indication of accuracy.
Calibration Delete	Used for calibration purposes, which is only available with a service key and performed by GE HealthCare Service.
Store Registration to File	Press to save the current registration to a file. This is useful when you want to load another dataset with the same geometry. For example, both a T1 and T2 weighted MR series may be available.
Read Registration from File	Press to read a stored registration from a file.
Read Markers from File	Press to recall saved GPS markers from a file.
Show Scan Area	Shows or hides the Ultrasound scan area on the 3D Dataset.
Cut Mode	Select the cut mode: Cubic Plane, the 3D dataset slice in reference to the whole volume of data; Overview, fixed orientation slice; or Detailed, a slice in the same orientation as the current Ultrasound image.
Exit and Clear	Clears the current 3D Dataset and exits V Nav; the 3D dataset is no longer available.

### **DICOM and Image Storage**

#### **Still Images**

To store a still image, press **Freeze**, and then press P1. If you want to CINE back to find an image, you may need to set the Priority on the Touch Panel to Ultrasound.

#### **Loops**

To store a loop after you have frozen the image, CINE back, change the Priority to Ultrasound (if necessary), indicate the start and end points, Run the CINE Loop, Press P1.

#### **Image-by-Image**

To store individual images to a USB memory stick or external hard drive via the USB port, recall the image from the Clipboard, select Menu -> SaveAs. Type in the file name. We recommend that you select Image Only, Jpeg compression, Quality level 99. For CINE Loops, save as WMV. For stills, save as type Jpeg. Then press Save. Repeat for as many images as desired. When you take the USB device to another computer, the images are stored in the Export directory.

## Save Volume

The system can save the volume and associated GPS markers as an image file in the exam.

The Save Volume key on the Touch Panel stores using the settings of whichever print key has Copy to Dataflow associated with it.

A saved volume can be loaded from the database and used as the pre-acquired volume.



The Volume is stored in Raw Data format. If you send the volume to PACS without the raw data, the volume will not be available if you later Query/Retrieve it from PACS.

## Measurements and Comments

You can measure distance, angle, circumference, or area on the 3D Dataset. You can annotate and perform any system measurement on the Ultrasound image.

## Using V-Nav

### Magnetic field range of V-Nav Transmitter

The position of the V-Nav sensor can be detected correctly within the range shown below. Make sure that the V-Nav sensor is within this range.

Check the Environmental Quality indicator on the monitor for the detection accuracy while scanning.

*NOTE: Remove the metal product from the region of the magnetic field to increase accuracy of position detection.*

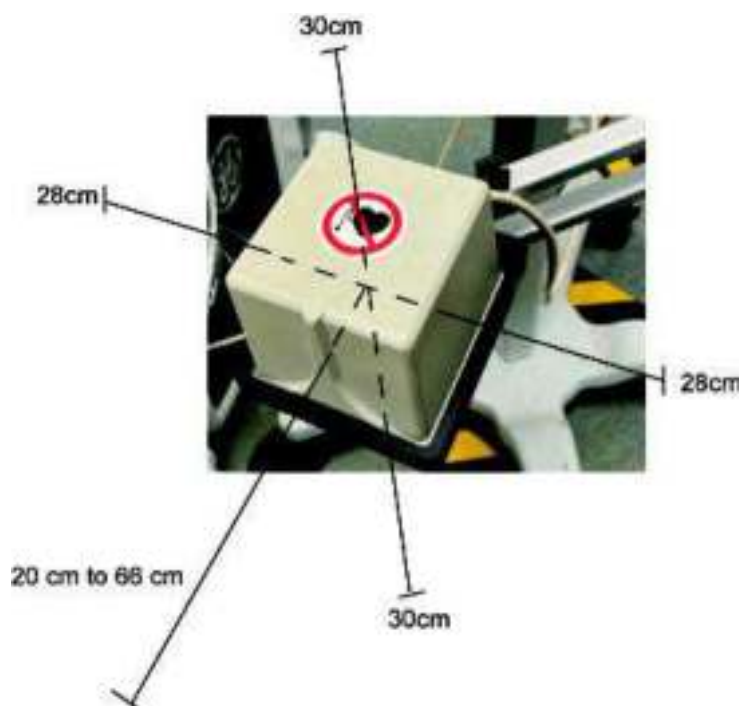

Figure 13-119. Magnetic Field Range from the Transmitter

From the center of the transmitter,

1. 30cm above and below
2. 28cm left and right
3. 20 - 66cm forward

## Perform V-Nav Exam

In order to perform a V-Nav exam, you need to have acquired the 3D Dataset and set up the position sensing apparatus.

The workflow for V-Nav is to:

1. Import the dataset if using Query/Retrieve.  
See 'Query/Retrieve' on *page 13-250 for more information.*
2. Perform the Setup (attach the sensors) as needed.  
See 'Setting Up V Nav sensors' on *page 13-258 for more information.*

**NOTE:** *Probes with V-Nav Inside transmit/receive automatically after you activate V-Nav.*

3. Begin an exam; optimize the image.
4. Enter V-Nav.
5. Load the dataset.
6. Perform the registration.

**NOTE:** *Confirm that the plane orientation of the ultrasound image is the same as that of the loaded volume data before starting registration.*

7. Perform the exam.
8. Take measurements and store images via the Print key.



### HINTS

Since Volume Navigation uses magnetic field to acquire probe position information, it may be affected by surrounding metal products.

If the image is flicked or misaligned, check the surroundings, such as the bed, the IV stand or the accessory, and move away those metal products from the magnetic field. If you use the bed with metal frame, it is desirable to be able to secure the distance from the metal frame using a thick mattress.

## Ending an Exam

Press **V-Nav**, select **End Exam**, select **End Current Patient**, then select **Store all**. The system is ready for the next patient.

### Perform the registration

#### Orient the Dataset and Pick a Slice

You can manipulate the 3D Dataset the same way you adjust any 3D volume.

Manipulate the dataset to pick a slice that most closely matches the area where you will hold the probe initially.

1. After the dataset has loaded, use the Zoom rotary to see the dataset in a larger size.
2. Use the Orientation key to select Axial, Sagittal, or Coronal to easily view the Dataset from different orientations.

You want the orientation that best matches the orientation of the patient.

**NOTE:** *If the data appears unacceptably blurred or smeared in one of these views, the dataset was not acquired with the appropriate settings for viewing the data in 3D.*

3. Pushing the X rotary rotates the dataset 90 degrees about the X-axis. Dialing the X rotary rotates the dataset about the X-axis in smaller increments. Same for Y and Z.

Note which points are identifiable in both the live Ultrasound image and in the 3D dataset. Remember that a point needs to be identifiable in all three dimensions. A point along a surface is often difficult to identify in three dimensions; but intersections of vessels, calcifications, or centers of structures can often be identified clearly in three dimensions.

## Registering, Locking, and Translating the Image with the 3D Dataset

After you've loaded the 3D Dataset, you need to link the 2D Ultrasound image to the 3D dataset via Registration. You can register the 3D dataset to the Ultrasound image by Parallel Plane Registration or Point Registration.

**Lock Plane:** Align the section of displayed volume data with the vertical and horizontal orientations of the ultrasound scan plane. Match the state of inspiration and expiration with the loaded volume data and setting the probe orientation correctly to reduce the misalignment during the examination.

**Lock Point:** The position in the depth direction is adjusted at Lock Point. Synchronous display starts after setting Lock Plane. Set the reference point (Landmark) on the ultrasound and volume data. It can be set repeatedly.

**NOTE:** *Confirm that the plane orientation of the ultrasound image is the same as that of the loaded volume data before starting registration.*

**NOTE:** *DO NOT move the patient once you have registered the image; if you move the patient, you lose registration.*

Select the type of registration on the Touch Panel.

**NOTE:** *When switching probes in V Nav, the registration is maintained. You can register with one probe, then scan with any probe.*

### Parallel Plane Registration

A plane registration constitutes a plane lock and a translation point.

To perform a Parallel Plane Registration,

1. Select **Registration** -> **Plane** from the Touch Panel.
2. Hold the probe parallel to the acquired (imported) 3D dataset, being careful not to tilt, twist, or rotate the probe.
3. Press the **Lock Plane** (bottom Trackball key) to lock the plane as parallel.
4. Define a translation point, by marking a common point in each image (Ultrasound and 3D Dataset) using the Windows Pointer and Trackball key labelled **Lock Point**. This allows the system to do an x, y, and z correction at that point.
5. Move the probe and ensure that this registration is correct.
6. Press **Save Current Registration** on the Touch Panel to save this registration. You can save up to five (5) registrations.

### Adjusting the Registration

To adjust the registration, you could try several things.

1. Save the registration. It's always a good idea to save the registration first.
2. Update the translation point in the area of interest.
3. Turn on Overlay and use the Z Rotary to adjust the 3D overlay relative to the Ultrasound image.
4. Holding the probe still during the following steps: move the windows pointer over the overlay image, select the Overlay XY Trackball control, move the overlay relative to the Ultrasound image, press the Overlay XY key to lock in the adjustment.
5. Manually adjust the parallel plane lock. Use the scan key on the Touch Panel to select only the 2D Ultrasound or the 3D dataset. Adjust the probe to make the scanned image match the locked image and then press **Lock Plane**.
6. Start over by using the Clear/Reset -> All control on the Touch Panel.



## Point Registration

To perform a Point Registration,

1. Select **Registration** -> **Point** from the Touch Panel.
2. Find a common point on both the 3D Dataset and Ultrasound image. Use the Windows Pointer to select each point, then press Set Point each time. Do this 3 times.

**NOTE:** *You can select either a Point/Best 3 or Point/All. If you identify more than three point pairs, Point/Best 3 takes the best 3 point pairings. Point/All uses all point pairs that you identify when calculating the Point Registration.*

3. Move the probe and ensure that this registration is correct.
4. Press **Save Current Registration** on the Touch Panel to save this registration. You can save up to five (5) registrations.

**NOTE:** *Point and Plane registrations are stored separately.*

To switch between Point and Plane Registration, change the registration via the Touch Panel.



### HINTS

Performing a plane registration is not necessary to do a point registration, but is recommended because it simplifies the process as the probe can easily be used to search for the point pairs in both the Ultrasound image and in the 3D Dataset.



### HINTS

When using a point pair to complete or update a registration, registration error is minimized at that point and will increase further away from that point. Therefore, registration accuracy near the anatomy of interest may be improved by marking the last point pair, or adding a point pair, in close proximity to the anatomy of interest.

### Auto Registration with Tru3D

Auto-registration is available when fusing to a Tru3D dataset.

When entering V Nav directly from a Tru3D acquisition, the Tru3D volume is automatically loaded into V Nav and automatically registered.

When a Tru3D data set from the current exam is loaded into V Nav from the clipboard or by loading from the database, the user shall be prompted to automatically register to the data set.

**NOTE:** *Tru3D auto registration is possible if the magnet and patient have not been moved since the Tru3D data set was acquired. If the magnet or the patient have moved since the Tru3D dataset was acquired, you need to perform a parallel plane or point registration.*

Auto Registration appears as a choice on the Registration control only if auto registration was initially used. You can manually select a different registration method even if Auto registration was initially selected when the volume was loaded.

## Overlay

Use the Overlay control on the Touch Panel to overlay the 3D Dataset image onto the Ultrasound image. Use the Overlay Brightness and Overlay Weight joysticks to adjust the intensity level of the 3D Dataset.

By pointing at the overlay (Overlay XY) with the Windows pointer and clicking on it with the Left Set Key, the overlay can be dragged via the Trackball in X and Y directions in an effort to achieve a better registration. To lock in the adjustment, press the Left Set Key again.

By pointing at the overlay with the Windows Pointer and clicking on it with the Right Set Key (Overlay Z), the overlay can be dragged via the Trackball in the Z direction in an effort to achieve a better registration. To lock in the adjustment, press the Left Set Key again.

One technique to improve registration is to adjust the overlay in X and Y as stated above and to also do any necessary Z axis rotation as well. Then, turn the probe 90 degrees and repeat these same adjustments. These steps can be repeated iteratively.



In an area with bony structures that show up bright with the 3D Dataset, applying an overlay with a low percentage can be a nice way to show bone structure with an Ultrasound tissue image.



When performing Overlay XY or Overlay Z adjustments, it is important to hold the probe still from the time the adjustment key is pressed until it is pressed a second time to lock in the change.

### Volume to Volume Registration

Datasets can come from different exams, can be from different orientations, and can be from different imaging modalities. Because datasets are not registered to one another, the system allows auto or manual volume-to-volume registration

To register multiple volumes,

1. Load multiple volumes (not restricted to one exam).
2. Clicks on the “link” icon. The “Select volumes for registration’ pop-up window appears.
3. Select the primary and secondary moving volumes. The primary volume is used for registration, the secondary volumes are transformed using the registration parameters of the primary volume.

For example, If the user has a CT1 volume and a CT2 + PET volume loaded, they would select the CT1 as the fixed and the CT2 as primary, and the PET as the secondary moving volumes. After the registration they will have CT2 + PET registered to CT1.

4. Specify if the result should be added as a new registered volume or overwrite the moving dataset. You can also or create the result as an additional volume (‘Add registered volume’ is not an option if 5 volumes already exist).

A user can perform two types of manual registration: a registration based off of a single common point pair identified in each volume (Translation); or a registration based off of three or more common point pairs identified in each volume (Registration).

## Volume to Volume Registration (continued)

5. Choose Manual, Auto, Semi Auto or Indirect volume to volume registration.



Figure 13-120. Select volumes for registration

**NOTE:** *If you select Auto registration, also choose the type (bone, tissue or some combination). If you select Manual registration, identify three point pairs between the two volumes. Only one point pair is usually needed for datasets with different orientations from the same exam.*

During manual volume to volume registration, the user is able to scroll through either the fixed volume (shown on the left) or the moving volume (shown on the right) by moving the Windows Pointer over the image, pressing the trackball key labeled Scroll Z and then using the trackball to perform the scrolling.

### Volume to Volume Registration (continued)

**NOTE:** *During manual volume to volume registration, the user is able to move the volume up and down or left and right on the screen by moving the Windows pointer over the image, switching from Primary to Secondary with the top trackball key, pressing the trackball key labeled Move XY and then using the trackball to perform the XY movement.*

When doing manual registration, the left volume is the fixed volume and the right volume is the moving volume. The right trackball key is used to scroll through the datasets and find anatomical points while the left trackball key is used to mark the points. Once a single point pair is marked, the bottom trackball key is labeled Apply Translation which is all that is needed to register the moving volume (oblique, e.g.) to the fixed volume (axial, e.g.).

**NOTE:** *A single point pair is sufficient if the two datasets have the same orientation but are shifted with respect to each other.*

Once three point pairs are marked, the bottom trackball key is labeled Calculate Registration which then registers the moving volume to the fixed volume.

**NOTE:** *Three point pairs or more are needed if the datasets do not have the same orientation or are at oblique angles with respect to each other.*

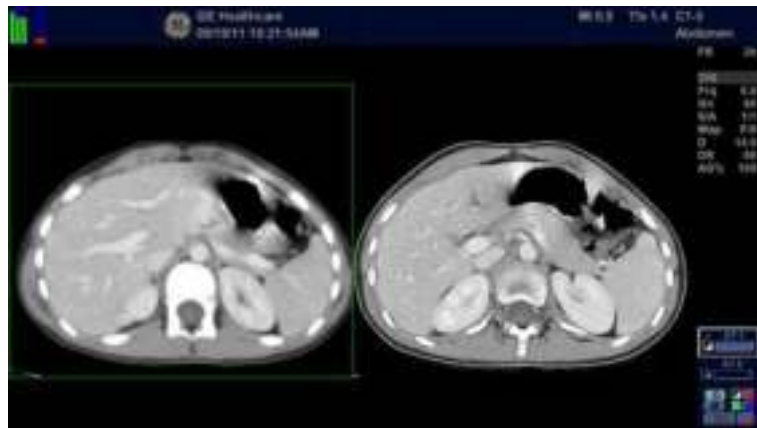

Figure 13-121. Volume to Volume Registration

## Volume to Volume Registration (continued)

Once three point pairs are marked, the bottom trackball key is labeled Calculate Registration which then registers the moving volume to the fixed volume.

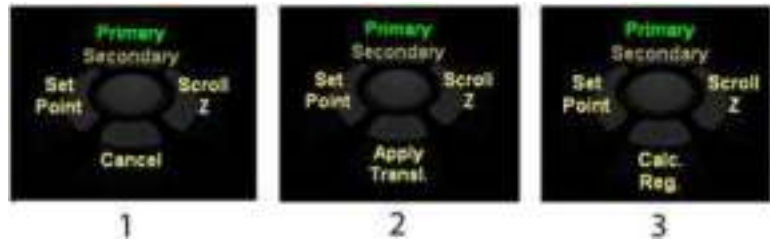

Figure 13-122. Trackball key status

1. No point pairs identified
2. One point pairs identified
3. Three or more point pairs identified

## Compare Volume

You can compare pre-registered volumes in a side by side display.

1. Press **Volume Compare** button in the multi volume menu.
2. The dialog for selecting left and right side volumes displays. Multiple selection is possible.

**NOTE:** *Volumes need to be from the same group of pre-registered volumes.*



Figure 13-123. Select volumes for comparison

3. The selected volumes is shown side by side and any interaction (scroll, zoom, rotation etc.) is applied to both sides simultaneously.

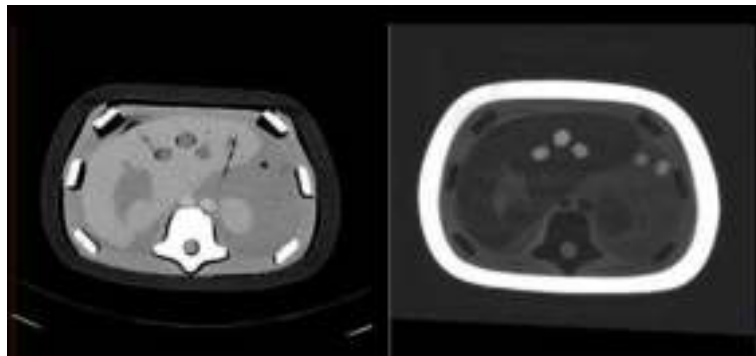

Figure 13-124. Compare Volume



## Advanced GPS Markers

### "GPS" -- Position Marking V Nav

Position markers can be 'placed' on a stationary anatomical structure within the body and then tracked with the existing position sensing system. The marker position is projected onto the current Ultrasound image in a graphical way that indicates the relative position of the point compared to the image. GPS markers track a particular point in space.

#### Controls

Selecting the GPS tab switches trackball control to GPS markers with 2D Marker or 3D Marker activated.

Table 13-57: GPS Controls

Preset Parameter	Description
2D Marker	Allows the user to select between a Point Marker and a Target Marker.
3D Marker	Allows the user to select between an Ellipsoid and Spherical Marker.
Show All Markers	Shows all markers, independent of Active State.
Show Active Markers	Shows/Hides all markers with Active State "On".
Active State	An individual GPS marker can be shown/hidden using the Active State control (turn to select, push to toggle state).
Delete	Rotate the control to select a specific GPS Marker to delete; then push the control to delete the marker.
Delete Markers	Deletes all active GPS Markers following the user's confirmation.
Mark Needle Tip	Mark Needle Tip allows a 2D or 3D GPS Marker (whichever is selected) to be put at the current tracked needle tip location. The marker is not attached to the needle and will not move as the needle moves.
Show Distance	Toggles between showing and hiding all defined distances.
Attach to Needle	If the 3D Marker key is selected and needle tracking is active, the "Attach To Needle" key initiates a 3D GPS Marker whose center (in the case of a sphere) or whose first long axis point (in the case of an ellipsoid) is placed at the needle tip.
3D Edit	The 3D Edit key is available only if a 3D GPS Marker is currently selected via the Delete or Active State rotaries. Selecting the Edit key causes the Edit GPS Touch Panel menu to appear.

Table 13-57: GPS Controls (Continued)

Preset Parameter	Description
Dist Start/Dist End/Clear	<p>Rotating the Distance Start and Distance End rotaries cycles through the list of GPS markers including the Needle Tip if needle tracking is active. When two different GPS markers are identified on the Distance Start and Distance End Rotaries, the Distance End rotary is labeled "Define" or "Clear". If the distance is not already defined, the label is "Define". If the user then pushes the rotary, the distance between the Start and End GPS Markers is defined, and the label switches to "Clear".</p> <p>The initial value of the Distance Start rotary is the first GPS marker. The initial value of the Distance End rotary is the needle tip if needle tracking is active or the 2nd GPS marker if not. In the case of a 3D GPS Marker, its center point is used for all distance calculations.</p>

## 2D GPS Markers

GPS Markers track a particular point in space. As you adjust the probe/image position, the point is projected onto the current image. If the point intersects the current image, it is displayed as a green cross. As the point gets further away from the current image, the cross turns into a bigger and bigger square. The color of the square indicates the direction; red represents one direction and blue represents the other direction. You can use 'GPS' to track an anatomical marker on the Ultrasound image or for biopsy needle guidance, for example.

You can use GPS Markers with an imported dataset, or independently of an imported dataset.

There are two types of GPS Markers: Point and Target. A Point Marker assigns a number. Each point marker you set has a unique number. A Target Marker only allows one target point. If you try to place another target marker, the target moves to the newly-indicated position.

To place a Target or Point Marker, use GPS Marker to specify Target or Point. Place the Windows Pointer in the location where you want to set the marker, then press the Set GPS Key.

## 3D GPS Markers

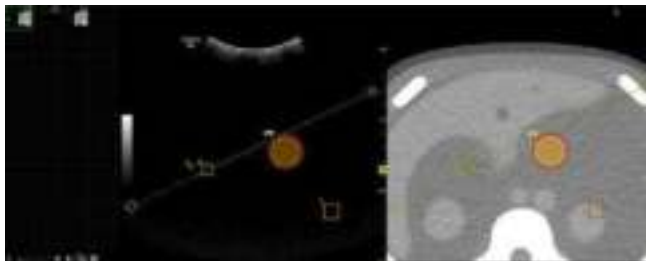

Figure 13-125. 3D GPS Marker example

**NOTE:** When using GPS Markers with a registered 3D dataset, a point marked in either image shows up in both images. GPS Markers are stored with the image.

**NOTE:** All 3D GPS Markers are appended with the letter "V" (for volume).

**NOTE:** The inner surface of the 3D GPS marker and margin contours can be colored using the colors of the marker/margin. This color is transparently overlaid on top of the US image below.

### Type of Markers

- Ellipsoid
 

The user places one GPS Marker (Set GPS on the right trackball key) at one end of the desired long axis. The point is marked with a marker named LA that behaves like a point marker. The distance between this first long axis point and the current cursor position is displayed in the status bar to allow the user to mark an ellipsoid with a defined long axis length. The user then places a second GPS Marker (Set GPS on the right trackball key) at the other end of the desired long axis. The ellipsoid will be drawn and the long axis endpoints will be marked with crosses that will be displayed only if they are hit by the plane.
- Spherical
 

The user places the GPS Marker (Set GPS key on right trackball key) at the center point of the anatomical structure of interest. The center of the sphere is marked with a cross, that is only displayed if the plane hits the center.

**Editing a 3D Marker**

Upon creating a 3D GPS marker, the Edit GPS menu appears on the Touch Panel.

Table 13-58: Edit GPS Marker - Sphere/Ellipsoid



Preset Parameter	Description
Done	Return to main GPS Touch Panel.
Reposition	Set Key on the image will reposition the sphere when Reposition key is on (otherwise Set Key creates a new sphere).
Select	Select attributes that were previously saved.
Save As	Save and name the current sphere attributes (size, margin, colors and transparency).
Color	Change color (yellow, Red, orange, blue, purple, pink or white).
Margin Color	Change margin color.
Margin Dist.	Adjust margin size.
 <p style="text-align: right;">a. Diameter b. Margin</p>	
Diameter	Adjust sphere diameter.
Inner Alpha/Margin Alpha	Adjust transparency of main area and margin in percent i.e. between 0 (= only ultrasound image) and 100 (= only marker/margin color).
Detach from Needle	The Detach From Needle key is only available if the 3D GPS Marker being edited is attached to the needle. Pressing the key causes the 3D GPS Marker to be removed from the needle and placed at the current location of the tracked needle tip. It will no longer move with the needle tip.

Table 13-58: Edit GPS Marker - Sphere/Ellipsoid (Continued)

Preset Parameter	Description
	<p>a. The length of the red ellipse is the long axis of the ellipsoid.                      b. The diameter of the blue circle is the short axis of the ellipsoid.</p>
Shift/Rotate (Ellipsoid)	Shift along long axis or rotate about end of long axis.
Short Axis/Long Axis (Ellipsoid)	Adjust short and long axis lengths.
Show Ablation Needle Path	<p>For ellipsoids, the user can display the needle path and tip position.</p> 

**NOTE:** Default of the parameters is configurable in Utility -> System -> System Imaging -> V Nav 3D Marker.

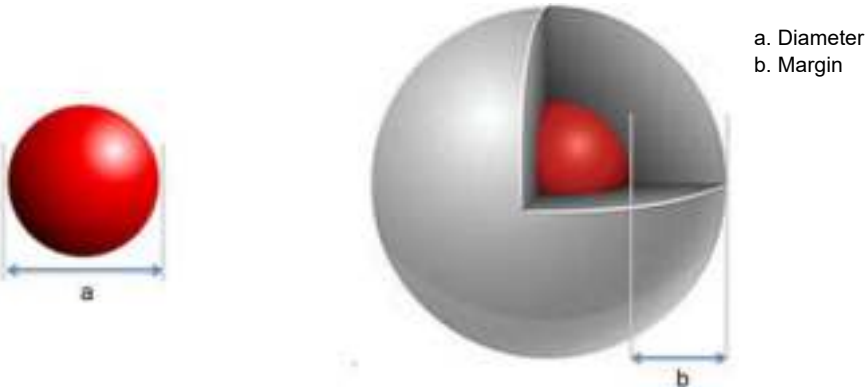
### Editing a 3D Marker (continued)

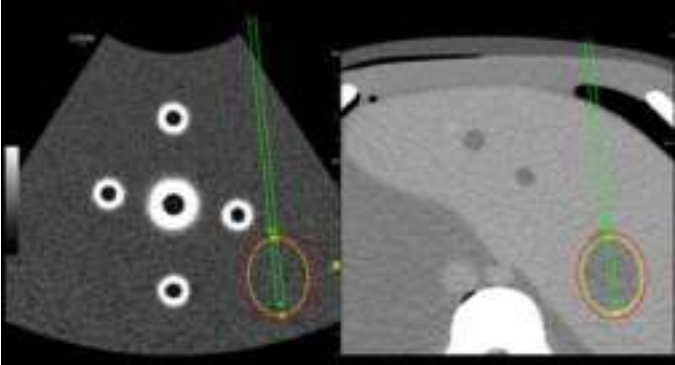
**Move XY GPS** allows the 3D Marker to be dragged to a new location in the current image plane.

**Repos. GPS** allows the 3D Marker to be recentered on the current image plane.



Figure 13-126. Trackball key for GPS Marker

**NOTE:** *The initial attributes of a 3D GPS marker match the last 3D GPS marker that was created.*

**NOTE:** *While on the Edit Menu, the 3D GPS marker being edited is shown in its normal color while all other 3D GPS markers are dimmed. After exiting the Edit Menu, all markers are returned to their normal color appearance.*

## Saving and Selecting a 3D GPS Marker

To save a 3D GPS Marker,

1. For markers that are used often, such as kill zones associated with a particular ablation needle, select **Save As** from the Edit GPS Touch Panel.
2. The Save 3D GPS Marker pop-up menu appears. Name the GPS Marker.



Figure 13-127. Saving a 3D GPS Marker

To select a 3D GPS Marker,

1. Select **Select** from the Edit GPS Touch Panel. The Select 3D GPS Marker pop-up menu appears.

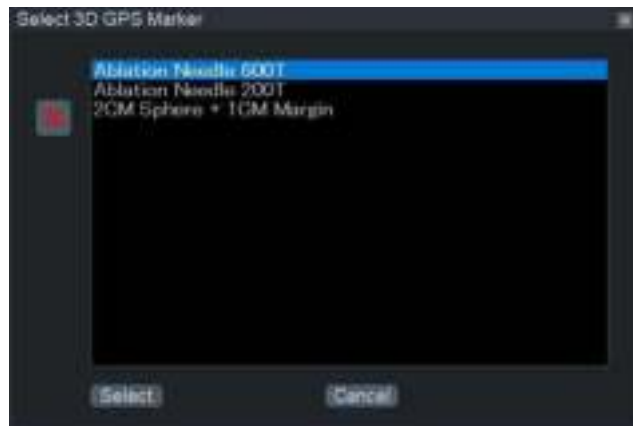

Figure 13-128. Select 3D GPS Marker

2. Highlight the desired Sphere or Ellipsoid, then press **Select**.

### Attach to Needle/Detach from Needle

The user attaches (and detach) 3D GPS markers to (from) a tracked needle tip and places a 2D GPS marker at the location of a tracked needle tip.

If the 3D Marker key is selected and needle tracking is active, the **Attach To Needle** key initiates a 3D GPS Marker whose center (in the case of a sphere) or whose first long axis point (in the case of an ellipsoid) is placed at the needle tip.

In the case of an Ellipsoid, it's long axis is aligned with the needle direction, i.e. both long axis points are placed on the needle axis. The 3D GPS Marker is not in a fixed location, but is attached to the needle and therefore moves with the needle tip.

The key is only available if needle tracking is enabled and the 3D Marker key is selected.

To detach the 3D Marker from the needle, the user can either press the **Detach from Needle** button on the GPS Edit page or the Mark Needle Tip on the GPS page.

### Mark Needle Tip

Mark Needle Tip allows a 2D or 3D GPS Marker (whichever is selected) to be put at the current tracked needle tip location. The marker is not attached to the needle and will not move as the needle moves.

**NOTE:** *You must use Tip Tracking or Virtual Tip Tracking.*

1. Place a needle.
2. Before extracting the needle, select **Mark Needle Tip** to get a 2D or 3D GPS marker at the needle tip.

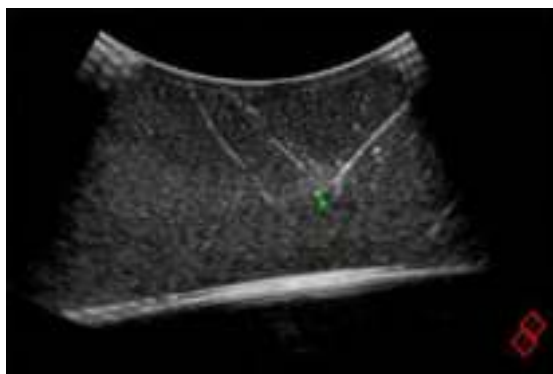

Figure 13-129. Mark Needle Tip - Example



## GPS Distance

The user displays the distance between two GPS markers or a GPS marker and a tracked needle.

- Between any two GPS markers (2D Point, 2D Target, 3D Sphere, 3D Ellipsoid)
- Between any GPS Marker and the tracked needle tip (Tip-Tracked, virtual tip-tracked)

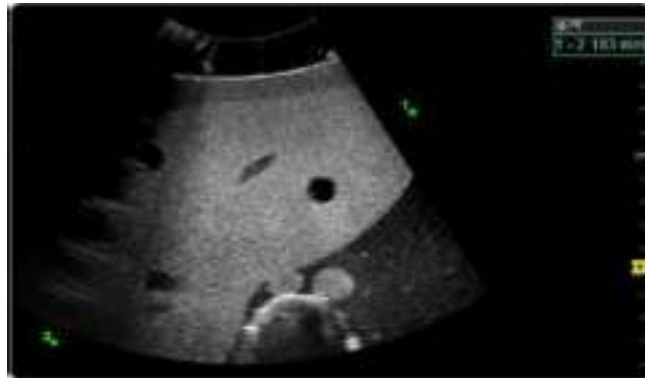

Figure 13-130. GPS Distance - Example

### Procedure

1. After marking GPS locations, rotate Dist. Start to select 1st marker.

**NOTE:** *Cycle through the list of GPS markers including the Needle Tip if needle tracking is active.*

2. Rotate Dist. End to select 2nd Marker. Push Define to display the distance.

**NOTE:** *If the distance is not already defined, the label is "Define". If the user then pushes the rotary and the distance between the Start and End GPS Markers is defined, the label switches to "Clear".*

In the case of a 3D GPS Marker, it's center point is used for all distance calculations.

When distances are defined to be displayed, they are displayed in the same location as 3D measurement results. When regular 3D measurements are displayed, the distance measurements are not shown. The label of a distance measurement is the numerically lowest GPS Marker followed by the numerically larger GPS Marker. If the needle tip is one of the markers, it is listed second. Some examples are "1-2V", "3X-Needle", and "5-7P".

### V Nav Trackers

V Nav supports the V Nav Needle Tip Tracker, the Virtual Tracker and Active Tracker.



Figure 13-131. Volume Navigation Connections

1. V Nav Receiver Connector (2 cables)
2. V Nav Needle Tip Tracker/Virtual Tracker Sensor Connector
3. V Nav Active Tracker Connector
4. V Nav Transmitter Indicator
5. V Nav Transmitter Connector

**NOTE:** *Pink probe brackets and sensors are necessary when using the Needle Tracker or Virtual Tracker*

## V Nav Trackers (continued)



### HINTS

- Remember to exit V Nav with the V Nav control BEFORE disconnecting and connecting the V Nav Trackers.
- With the V Nav Trackers attached, tracking can be turned on/off using the Show Needle Tip button.
- When using V Nav Tracking, it is important to have high Environmental Quality readings.
- When Needle Tracking is turned on, the Needle Tracking graphics show the:
  - Needle Tip and projected path on the live image
  - The intersection point with the current image when not in plane
  - Markers to assist with guiding the needle in plane with the current image
- The combination of Fusion and Needle Tracking is available once the volume dataset is registered. By selecting the Needle in Plane button, the volume dataset can show the needle in plane rather than the same plane as the live Ultrasound image.
- You can push the Z-Rotation Rotary to rotate the needle path plane about the needle axis (coarse adjustments). Rotating the Z-Rotation Rotary can be used for fine adjustments.

## Setting up the V Nav Needle Tip Tracker

The V Nav Needle Tip Tracker allows you to insert a V Nav tracker inside the Needle to track where the needle tip is inside the body. The Needle Tip Tracker makes use of a needle assembly (combination of stylet and sheath) where the stylet has a hollow core in which a position sensor receiver may be placed, thereby placing the sensor near the tip of the stylet. The Needle Tip Tracker tip is annotated with an “N.”

To set up the V Nav Needle Tip Tracker, you need the CIVCO eTRAX Needle System Starter Kit.

1. The Kit includes the eTRAX Sensor as well as 5 sterile packages. Each sterile package contains a needle assembly (combination of stylet and sheath) and a cover for the sensor handle and cable.



Figure 13-132. Needle Tip Sensor and Cable Close-up

2. The Needle Sensor fits inside the needle assembly. Prior to performing the procedure, you need to cover the sensor handle and cable.
3. Advance the sensor all the way into the needle assembly.

## Setting up the V Nav Needle Tip Tracker (continued)

4. The Needle assembly locks into place with the Sensor handle.



### CAUTION

For illustration purposes only, the needle sensor is shown without a cover. Always place a cover over needle sensor to protect patients and users from cross-contamination.

5. Using proper sterile technique, insert needle sensor through opening in cover, taking care to minimize bending of needle sensor.
6. Extend cover over needle handle.
7. Inspect cover to ensure there are no holes or tears.
8. After you have the Needle Assembly placed at the desired anatomical location, you can unscrew the stylet from the sheath and remove the stylet (and sensor). The procedure needle can be placed in the sheath to perform the procedure.
9. Remove the Sensor and Needle
10. The site is now ready for the procedure (core biopsy, ablation, etc.).

### Setting up the V Nav Needle Tip Tracker (continued)

- NOTE: Dispose of the needle assembly and sensor cover. The Needle sensor should not be disposed.*
- NOTE: You DO NOT need to sterilize the Needle Sensor. Instead, clean and disinfect the needle sensor the same way you would a probe, taking care not to bend the sensor.*
- NOTE: The Tracker must be used in conjunction with a probe that has a V Nav Bracket. You need three (3) sensors: two (2) sensors attached to the probe and one (1) Tracker sensor. However, if you are using a V Nav Inside probe, no sensors need to be attached to the probe and only the sensor for the tracker is needed.*

### V Nav Virtual Tracker (Part of V Nav Option)

The V Nav Virtual Tracker allows you to attach a sensor to the shaft of the needle (away from the tip). The position of the needle tip and the projected needle path are projected onto the 2D Ultrasound image. The virtual needle tip is annotated with a "V."

## Setting up the V Nav Virtual Tracker

To set up the Virtual Tracker, you need the CIVCO VirtuTRAX Starter Kit.

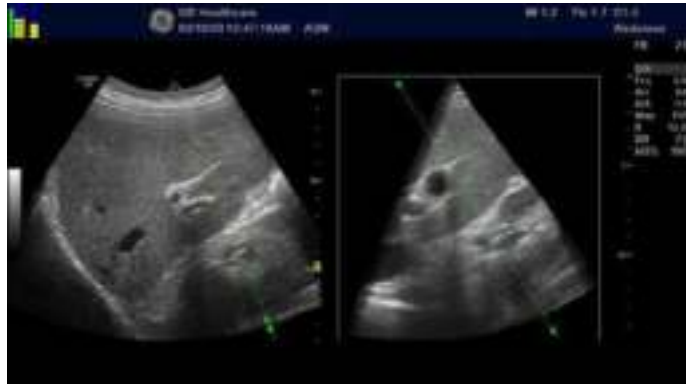

Figure 13-133. V Nav Virtual Tracker

1. The kit includes the VirtuTRAX Sensor as well as 5 sterile packages. Each sterile package contains a sensor bracket, a cover for the sensor, and rubber bands for the cover. Insert sensor inside cover. Place covered sensor in sensor bracket. Push down on sensor. Push down until sensor snaps into place.

## Setting up the V Nav Virtual Tracker (continued)

2. Insert needle into insertion point of the bracket, making sure that the arrow on the side of the bracket points toward the needle tip. Rotate knob to tighten needle holder to adjust it to the needle's gauge.
3. Assembled V Nav Virtual Tracker
4. Attach Virtual Sensor to the system. Connect V Nav sensors to the system.
5. You are ready to calibrate the Virtual Tracker. See Calibrating the V Nav Virtual Tracker procedure below.
6. To track the needle, the system needs to know the distance from the sensor bracket to the needle tip.
7. To provide the distance, select the V Nav Virtual Tracker control. Details are provided below.



8. On the display the virtual needle tracker appears like the needle tip tracker except that the needle tip is annotated with a "V."

**NOTE:** *Dispose of the sensor bracket and sensor cover. The sensor should not be disposed.*

**NOTE:** *You DO NOT need to sterilize the sensor. Instead, clean and disinfect the sensor the same way you would a probe.*

**NOTE:** *The Tracker must be used in conjunction with a probe that has a V Nav Bracket. You need three (3) sensors: two (2) sensors attached to the probe and one (1) sensor attaching to the needle sensor bracket.*



### CAUTION

Because the sensor is away from the tip of the needle, the system cannot detect needle bending. When the needle bends, the projection of the needle trajectory and the representation of the needle tip will vary with respect to the actual needle trajectory and tip position.



## Calibrating the V Nav Virtual Tracker

**Method 1.** You enter the needle length.

1. Select Virtual Tracker.
2. Enter a device name and specify a length. Press OK (Length is measured from the tip of the needle inserted to the far surface of the sensor bracket, measured along the needle shaft).
3. Check the length by placing the needle tip on the center of the probe face.
4. There should be a 'V' on the probe face in the image.

**Method 2.** You define the needle length via the image.

1. Select Virtual Tracker.
2. Enter a device name, and click on Define via Image. Press OK in the dialog.
3. Set the tip on the center of the probe face, move windows cursor to that point on the image and press Set.
4. The tip becomes marked with a 'V' on the image, initially on the probe face.

Existing Virtual Tracker devices can be selected and their calibrations modified if needed.

## Active Tracker

The Active Tracker is a device that consists of four markers that show up in a volume imaging dataset such as CT or MR. The markers are in known positions relative to each other such that the orientation of the Active Tracker can be uniquely determined based on the marker positions in the image. The device also holds a position sensor in a known position relative to the markers. Holes are provided in the Active Tracker so that its location can be marked on the body.

When the Active Tracker sensor is attached to the Active Tracker device, it can be used as a reference sensor. This means that all tracking is done in relationship to this sensor rather than in relationship to the transmitter.



Figure 13-134. Left, Active Tracker - Right, CT of Active Tracker

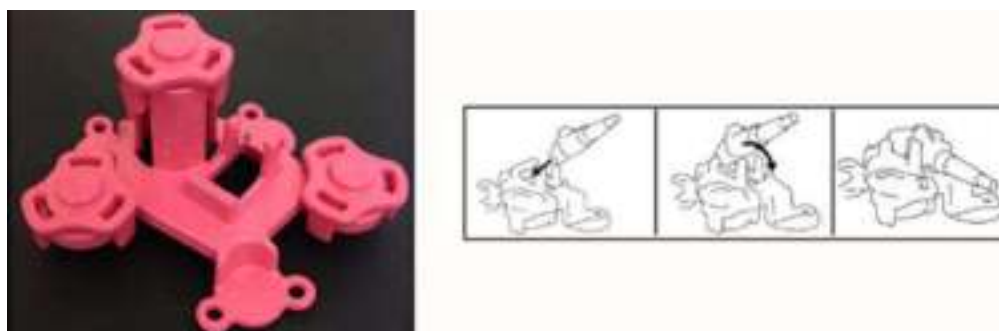

Figure 13-135. MR Active Tracker

## Active Tracker (continued)

The Active Tracker adds sensor-based auto registration for CT/MR. An Active Tracker device, which can hold a sensor, is placed on the patient during the CT/MR scan and then detected in the CT/MR images to facilitate an auto registration. CT/MR uses the same Active Tracker device as a Reference Sensor, meaning that tracking is done relative to the sensor attached to the Active Tracker. Provides some breathing compensation, and allows registration and GPS markers to be maintained in case the transmitter/patient moves.

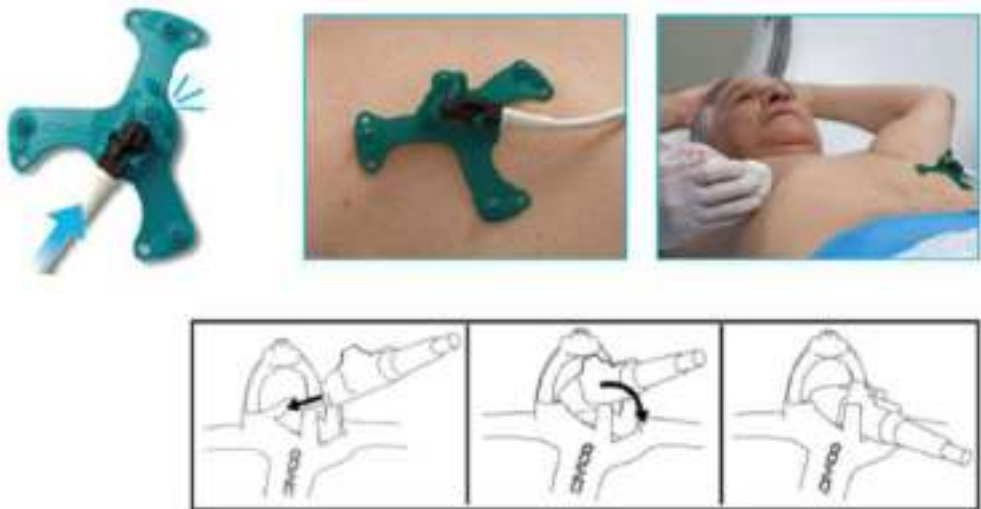

Figure 13-136. Active Tracker Setup and Positioning

1. Connect the following sensors to the V Nav Module. V Nav Probe Connectors (into Slots 1 and 2). Active Tracker Connector. Transmitter Connector.
2. Ensure that the probe has the V Nav attachment in place, along with the two V Nav Sensors.
3. Attach the CT/MR Active Tracker to the sensor.
4. Position the Active Tracker on the patient.

### Using the Active Tracker

Perform CT/MR exam.

1. Apply sensor.

For an MR Exam, avoid having the MR coil touch the MR Active Tracker.

- a. Place the MR Active Tracker where there is a gap in the coil.

**NOTE:**

*The MR Active Tracker must be in the area being scanned during the MR. It is good to place the Active Tracker on a rigid area, such as the xyphoid, and good to place it in the vicinity of the intervention, but still out of the way.*

- b. Use pads (available in the MR suite) to keep the coil from touching the MR Active Tracker.

2. Perform CT/MR scan.

Scanning the patient,

1. Use the Active Tracker to hold the sensor.
2. Tape the sensor to the body. First, clean the area, then peel and stick the sensor to the body.
3. Choose the reference sensor on the Touch Panel.

**NOTE:**

*If you choose the Active Tracker for Auto Registration, the sensor is automatically selected as the reference.*

4. Load MR/CT dataset.

## With Sensor and Active Tracker

In order to acquire an ultrasound volume and auto register live ultrasound to it at a future time, perform the following steps:

1. Use a probe with VNav position sensors attached to or built into the ultrasound probe.
2. Attach the Active Tracker device to the patient and connect the active tracker sensor to the device.
3. Using a body marking pen, mark the position of the Active Tracker on the body using a body marking pen and the four holes in the base of the Active Tracker.
4. Enter Tru3D and select the acquisition as "With Sensor + Active Tracker"
5. Perform a Tru3D sweep as usual and store it as usual.

Entering VNav directly from Tru3D or entering VNav and then loading the saved Tru3D data set will allow automatic registration of the live ultrasound to the Tru3D data set. If you want to automatically register to the Tru3D data acquired with Active Tracker at a future time, perform the following steps:

1. Follow steps 1 and 2 above except when placing the Active Tracker device use the four body marks to recreate the same position as before.
2. Enter VNav and load the Tru3D data set that was previously acquired with the active tracker attached. Perform sensor-based auto registration in the same way as for CT/MR.
3. Manually adjust the registration as needed.

# Breast Productivity Package

## Overview

There are three features in the Breast Productivity Package:

- Breast Lesion M&A — includes lesion measurement folders, show features, summary, etc.
- Breast Measure Assistant — contains the Auto Contour feature. It also has measurements related to Breast (distance to nipple, ratio).
- Breast Assistant, Powered by Koios DS — breast lesion analysis option.

## Breast Lesion M&A

Breast Lesion M&A allows you to document up to 30 breast lesions for each breast. Lesion Height/Width/Length, Distance to Nipple and A/B Ratio are available. Distance to Nipple allows you to enter the value (this is not a calculated measurement).

ACR BI-RADS® lesion classification can be notated via Show Features and Show Assessment.

The Breast Measure Assistant (Auto Contour) feature can also be used to automatically detect and outline the breast lesion.

Worksheet and Summary Worksheets show all the documented right/left breast lesions.

**Breast Lesion M&A (continued)**

From the Small Parts Application Preset, select the Breast Application. Next, select the Right/Left Lesion (Select RtSide/LtSide below the Touch Panel).

Table 13-59: Breast Lesion M&amp;A Touch Panel Controls

Preset Parameter	Description
Position	Specify the position of the lesion: Clock position 1-12 O'Clock, Areolar, SubAreolar, Axillary, or "-" (default).
Segment	Specify A, B, C, None, or "-" (default).
Show Features	<p>Press to activate the Show Features notations. To add notations for each feature, position the Trackball to the right of each feature and press Set. This brings up the available notations. Move the Trackball to highlight a notation and press Set to select a notation. The notation will then appear next to the feature. If a Feature has an asterisk next to it (*), then you can select multiple notations -- select all that apply and then select 'Done.' These features are displayed on the Trackball. Below is a list of each Feature with its possible notations:</p> <ul style="list-style-type: none"> <li>• Shape: Oval, Round, Irregular, None (-)</li> <li>• Orientation: Parallel, Not Parallel, None (-)</li> <li>• Margin: Circumscribed, Indistinct, Angular, Microlobulated, Spiculated, None (-)</li> <li>• Echo Pattern: Anechoic, Hyperechoic, Complex, Hypoechoic, Isoechoic, Heterogeneous, None(-)</li> <li>• Posterior Features: No posterior features, Enhancement, Shadowing, Combined Pattern, None(-)</li> <li>• Associated features: Architectural distortion, Duct changes, Skin thickening, Skin retraction, Edema, Absent, Internal vascularity, Vessels in rim, Soft, Intermediate, Hard, None(-)</li> <li>• Calcifications: Calcifications in a mass, Calcifications outside of mass, Intraductal calcifications, None(-)</li> <li>• Special Cases: Simple Cyst, Clustered microcysts, Complicated cysts, Mass in or on skin, Foreign body including implants, Lymph nodes-intramammary, Lymph nodes-axillary, Vascular abnormalities AVMs, Vascular abnormalities, Mondor disease, Postsurgical fluid collection, Fat Necrosis, None(-)</li> </ul>
Show Assessment	Specify the ACR BI-RADS Assessment: None (-), 0, 1, 2, 3, 4a, 4b, 4c, 5, 6. A comment field is available directly below the ACR BI-RADS Assessment.
Return	Press to return to the previous Touch Panel.
Lesion #	Indicates which lesion you are viewing (Lesion # of Total Number of Lesions). Press the left/right arrow to move from lesion to lesion.
L	Lesion Length
H	Lesion Height
W	Lesion Width
Distance to Nipple	Used to manually enter the distance the lesion is from the nipple.

Table 13-59: Breast Lesion M&A Touch Panel Controls (Continued)

Preset Parameter	Description
Auto Contour (HxL)	Press to activate the Auto Contour feature, using the height and length.
Auto Contour (HxW)	Press to activate the Auto Contour feature, using the height and width.
Rt or Lt A/B Ratio	Right or Left Lesion A/B Ratio, measured by Area or Diameter.
Composition	Specify the composition of the lesion: None (-), Homogeneous background echotexture-fat, Homogeneous background echotexture-fibroglandular, or Heterogenous background echotexture.
Delete Lesion	Press to delete this lesion.

### Worksheet and Summary Worksheets

Worksheets and Summary Worksheets are provided for all documented Breast Lesions.

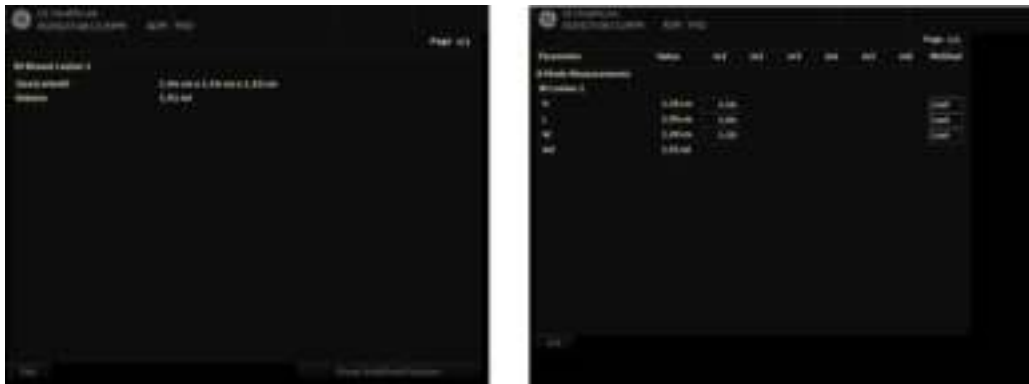

Figure 13-137. Breast Lesion Worksheet and Summary

To move to the next page, select the Page Change control beneath the Touch Panel.

**NOTE:** Only defined features are displayed on the Summary. To display the undefined features, select “Show Undefined Features” at the bottom of the Summary Worksheet.



## Breast Measure Assistant (Auto Contour)

You can request that the system trace/outline the border of a breast lesion using Breast Measure Assistant (Auto Contour). You do this by setting the Region of Interest (ROI) around the lesion; the system can then measure the lesion by drawing the contour around it.

To automatically detect the breast lesion on the display,

1. Press **Measure**.
2. Press **Auto Contour (HxW)** on the Touch Panel.
3. Place the Cursor in the center of the lesion and press **Set**. Size the ROI around the lesion. Use the Trackball to resize the ROI.
  - To increase the size of the circle, move the Trackball down and to the right.
  - To decrease the size of the circle, move the Trackball up and to the left.

*NOTE: Include the entire lesion, even if additional surrounding tissue is included.*

4. Press **Set** on the Trackball. A trace appears around the lesion.

*NOTE: Multiple breast lesion traces may be generated by the system. To cycle through the generated contours, use the Select Contours rotary on the Touch Panel.*

5. Inspect the generated contour for accuracy. If edits are necessary, execute steps 6-7 to edit the contour prior to accepting the measurement. Otherwise, skip to step 8.
6. To edit the selected contour, move the Trackball to appropriately size the edit region and then press **Set** on the Trackball.
7. The blue portion of the contour can be edited by moving the Trackball to the portion of the contour you want to edit.

*NOTE: The Caliper closest to the cursor enables editing.*

*NOTE: To limit the horizontal/vertical editing capabilities, you can set a preset via Utility--> Measure--> Advanced--> Small Parts--> Restrict Breast Contour Caliper Edit.*

8. After you have completed your edits, press Done on the bottom Set Key or press Print to accept the measurement.

## **Breast Assistant, Powered by Koios DS (not available in all countries)**

Breast Assistant, Powered by Koios DS is a Breast Lesion Analysis Option. Koios DS is integrated with the LOGIQ Totus via DICOM. Koios DS is configured similar to a DICOM Service. The user can accept/dismiss analysis results. If accepted, these results are included in the DICOM Structured Report.

To perform Breast lesion analysis using Koios DS:

1. In B-Mode in the Breast Application, select the Breast Productivity Package Lesion # then press **Koios** via the Touch Panel.

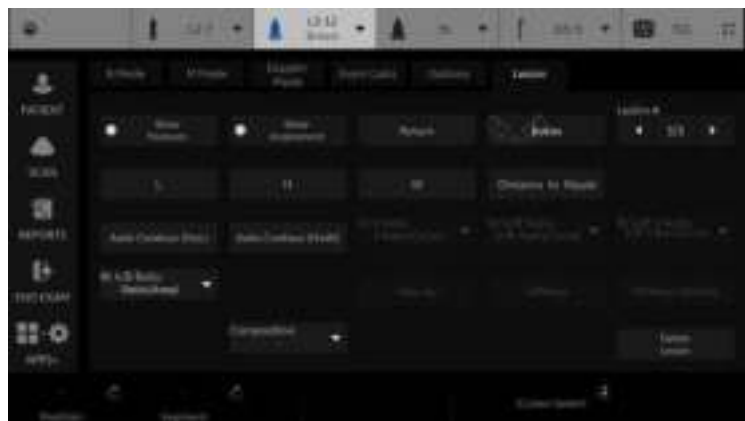

Figure 13-138. B-Mode Touch Panel in Breast Application

**NOTE:** *Koios DS analysis requires a frozen dual B-Mode image with a Length, Width, and Height measurement.*

2. Measure the breast lesion (Length, Width, Height) over 2 orthogonal scan planes; or measure the lesion using Auto Contour.
3. Using the Trackball control, press **Analyze**.

**Breast Assistant, Powered by Koios DS (not available in all countries) (continued)**

4. Koios DS analyzes the lesion (a pop-up appears, “Analyzing”).



Figure 13-139. Koios DS Analysis

5. A pop-up appears with the result of the Koios DS risk assessment and its alignment to an ACR BI-RADS® or U1-U5 risk category.
6. If the assessment is accepted, it becomes part of the exam including being displayed on the exam's Summary Report and included in the DICOM SR data associated with the exam. If the assessment is dismissed, the results are not stored as part of the exam.

**NOTE:** *For additional details of the Koios DS assessment, refer to Koios Medical's Koios DS product documentation.*

# Thyroid Productivity Package

## Overview

A Thyroid Productivity Package is available.

Table 13-60: Thyroid/Parathyroid/Lymph Node/Nodule Touch Panel Controls

Preset Parameter	Description
Side	Specify the side: <b>Right, Left, Isthmus.</b>
Worksheet/Summary	Select to view the Worksheet/Summary Worksheet.
Add#1, Add#2, etc.	Cycles through the available lesions, or adds a new lesion/node/nodule, etc.
Rt/Lt Thyroid Rt/Lt Parathyroid Rt/Lt/Isthmus Lymph Node Rt/Lt/Isthmus Nodule	To initiate a Left/Right Thyroid/Parathyroid or Left/Right/Isthmus Lymph Node/Nodule, select the corresponding folder on the Touch Panel. Length, Height, and Width are available for all thyroid measurements. The Cortical Thickness measurement is available for the Lymph Node. Show Features is available for all thyroid measurements.
Location	Parathyroid: Specify Upper Gland or Lower Gland Lymph Node: Supraclavicular fossa, Lower cervical, Middle cervical, Upper cervical, Parotid, Submandibular, Submental, Posterior triangle Nodule: • Location A: Upper, Lower, Mid, None • Location B: Lateral, Medial, Midline, None
Show Features - Overall Thyroid	Press to activate the Show Features notations. To add notations for each feature, position the Trackball to the right of each feature and press Set. This brings up the available notations. Move the Trackball to highlight a notation and press Set to select a notation. The notation will then appear next to the feature and on the Summary Worksheet. Below is a list of each Feature with its possible notations by measurement type: • Overall Thyroid (Top Level Touch Panel) <ul style="list-style-type: none"> <li>• Resected: Totally, Partially, None (-)</li> <li>• Appearance: Within normal limits, Abnormal, Symmetric, Asymmetric R&gt;L, Asymmetric L&gt;R, None (-)</li> <li>• Comment</li> </ul>

Table 13-60: Thyroid/Parathyroid/Lymph Node/Nodule Touch Panel Controls

Preset Parameter	Description
<p>Show Features - Lt/Rt Thyroid / Parathyroid and/ Lt/Rt/Isthmus Lymph Node / Nodule</p>	<p>Press to activate the Show Features notations. To add notations for each feature, position the Trackball to the right of each feature and press Set. This brings up the available notations. Move the Trackball to highlight a notation and press Set to select a notation. The notation will then appear next to the feature and on the Summary Worksheet.</p> <p>Below is a list of each Feature with its possible notations by measurement type:</p> <ul style="list-style-type: none"> <li>• Lt/Rt Thyroid               <ul style="list-style-type: none"> <li>• Resected: Totally, Partially, None (-)</li> <li>• Echogenicity: Homogeneous; Coarse; Heterogeneous; Hashimoto, Classic; Hashimoto, Probable; None (-)</li> <li>• Vascularity: Normal, Increased, Decreased, None (-)</li> <li>• Size: Normal, Enlarged, Small, None (-)</li> <li>• Comment</li> <li>• Isthmus Comment</li> </ul> </li> <li>• Lt/Rt Parathyroid -- Upper/Lower Gland               <ul style="list-style-type: none"> <li>• Visibility: Visualized, Not Visualized, None (-)</li> <li>• Comment</li> </ul> </li> <li>• Lt/Rt/Isthmus Lymph Node               <ul style="list-style-type: none"> <li>• Appearance: Within normal limits, Suspicious, Pathologic, None (-)</li> <li>• Composition: Cystic, Complex, Solid, None (-)</li> <li>• Vascularity: Normal, Increased hilar, Increased non-hilar, None (-)</li> <li>• Comment</li> </ul> </li> </ul>

Table 13-60: Thyroid/Parathyroid/Lymph Node/Nodule Touch Panel Controls

Preset Parameter	Description
Show Features - Lt/Rt Thyroid / Parathyroid and/ Lt/Rt/Isthmus Lymph Node / Nodule	<ul style="list-style-type: none"> <li>• Lt/Rt/Isthmus Nodule</li> </ul> <p>The selections for each category/feature and associated points match the ACR® TI-RADS™ (Thyroid Imaging Reporting &amp; Data System) risk-stratification system as published in 2017 by ACR*. Once one or more values are assigned for each feature, the points are summed and the corresponding ACR TI-RADS level is determined. Additional information including feature assignment guidelines and criteria for fine needle aspiration or follow up ultrasound can be found at the American College of Radiology website at: <a href="https://www.acr.org/-/media/ACR/Files/RADS/TI-RADS/TI-RADS-chart.pdf?la=en">https://www.acr.org/-/media/ACR/Files/RADS/TI-RADS/TI-RADS-chart.pdf?la=en</a></p> <ul style="list-style-type: none"> <li>• Composition (choose one): Cystic (0 point), Spongiform (1 point), Mixed cystic and solid (1 point), Solid (2 points), -</li> <li>• Echogenicity (choose one): Anechoic (0 point), Hyperechoic (1 point), Isoechoic (1 point), Hypoechoic (2 points), Very hypoechoic (3 points), -</li> <li>• Shape (choose one): Wider-than-tall (0 point), Taller-than-wide (3 points), -</li> <li>• Margin (if more than one type, choose the most suspicious one): Smooth (0 point), Ill-defined (0 point), Lobulated (2 points), Irregular (2 points), Extra-thyroidal extension (3 points), -. Note: If more than one type, choose the most suspicious.</li> <li>• Echogenic foci (choose all that apply): None (0 point), Comet (0 point), Macrocalcifications (1 point), Peripheral calcifications (2 points), Punctate echogenic foci (3 points), -</li> <li>• Comment</li> <li>• TI-RADS level: TR1, TR2, TR3, TR4, TR5                         <ul style="list-style-type: none"> <li>- TR1 - 0 points - Benign</li> <li>- TR2 - 2 points - Not Suspicious</li> <li>- TR3 - 3 points - Mildly Suspicious</li> <li>- TR4 - 4-6 points - Moderately Suspicious</li> <li>- TR5 - 7+ points - Highly Suspicious</li> </ul> </li> </ul> <p>NOTE: Although it is possible for a nodule to be awarded zero points and hence be characterized as TR1, all other nodules merit at least two points because a nodule that has a mixed cystic and solid composition (one point) will also gain at least one more point for the echogenicity of its solid component.</p> <ul style="list-style-type: none"> <li>• Koios DS Assessment</li> </ul> <p>* Tessler FN, Middleton WD, Grant EG, Hoang JK, Berland LL, Teefey SA, Cronan, JJ, Beland MD, Desser TS, Frates MC, Hammers LW, Hamper UM, Langer JE, Reading CC, Scoutt LM, Stavros AT. ACR Thyroid Imaging, Reporting and Data System(TI-RADS): White Paper of the ACR TI-RADS Committee. J Am Coll Radiol. 2017May;14(5):587-595. doi: 10.1016/j.jacr.2017.01.046. Epub 2017 Apr 2. PubMed PMID:28372962.</p>
Return	Press to return to the previous Touch Panel.
H	Height
W	Width
L	Length
Isthmus AP	Used to measure the Isthmus anterior to posterior distance.

Table 13-60: Thyroid/Parathyroid/Lymph Node/Nodule Touch Panel Controls

<b>Preset Parameter</b>	<b>Description</b>
Cortical Thickness	Cortical thickness of the lymph node.
Delete	Press to delete this anatomy.

## Worksheet and Summary Worksheets

Worksheets and Summary Worksheets are provided for all documented Thyroid anatomies.

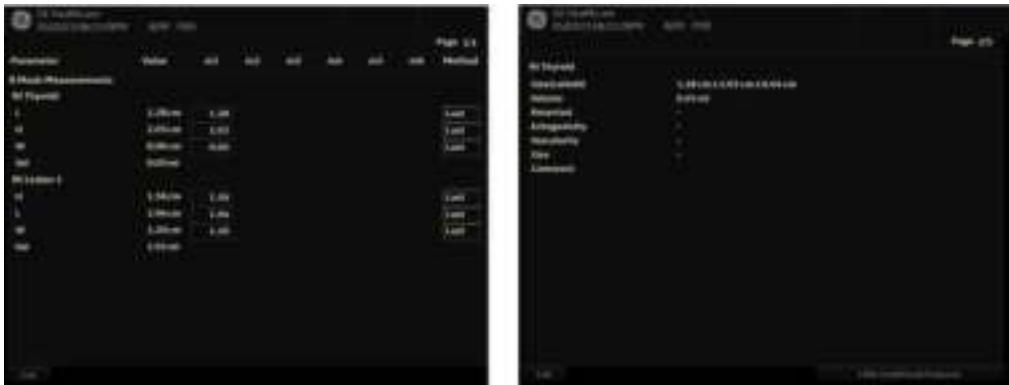

Figure 13-140. Thyroid Worksheet

To move to the next page, select the Page Change control beneath the Touch Panel.

**NOTE:** Only defined features are displayed on the Summary Report. To display the undefined features, select “Show Undefined Features” at the bottom of the Summary Worksheet.

**NOTE:** To exit back to the previous measurement screen, press Set on exit.

**NOTE:** To exit back to the scan screen, press Worksheet/Summary on the Touch Panel.



## Thyroid Assistant, Powered by Koios DS (not available in all countries)

Thyroid Assistant, Powered by Koios DS is a Thyroid Nodule Analysis Option. Koios DS is integrated with the LOGIQ Totus via DICOM. Koios DS is configured similar to a DICOM Service. The user can accept/dismiss analysis results. If accepted, these results are included in the DICOM Structured Report.

To perform Thyroid nodule analysis using Koios DS:

1. In B-Mode in the Thyroid Application, select the Thyroid Productivity Package Nodule # then press **Koios** via the Touch Panel.



Figure 13-141. B-Mode Touch Panel in Thyroid Application

**NOTE:** *Koios DS analysis requires a frozen dual B-Mode image with a Length, Width, and Height measurement.*

2. Measure the thyroid nodule (Length, Width, Height) over 2 orthogonal scan planes; or measure the nodule using Auto Contour.
3. Using the Trackball control, press **Analyze**.
4. Koios DS analyzes the nodule (a pop-up appears, "Analyzing").

**Thyroid Assistant, Powered by Koios DS (not available in all countries) (continued)**



Figure 13-142. Koios DS Analysis

5. A pop-up appears with the result of the Koios DS risk assessment and its alignment to an ACR TI-RADS® risk category.
6. If the assessment is accepted, it becomes part of the exam including being displayed on the exam's Summary Report and included in the DICOM SR data associated with the exam. If the assessment is dismissed, the results are not stored as part of the exam.

*NOTE: For additional details of the Koios DS assessment, refer to Koios Medical's Koios DS product documentation.*

# Start Assistant

## Introduction

Start Assistant automatically saves exam settings as Exam Mappings when the first image is acquired during an exam. Saved Exam Mappings are automatically recalled when a Worklist item is loaded, keying off the Worklist Exam Description.

Start Assistant has two functional modes:

- On: Use Exam Description (default mode)
- On: Use Scan Assistant only

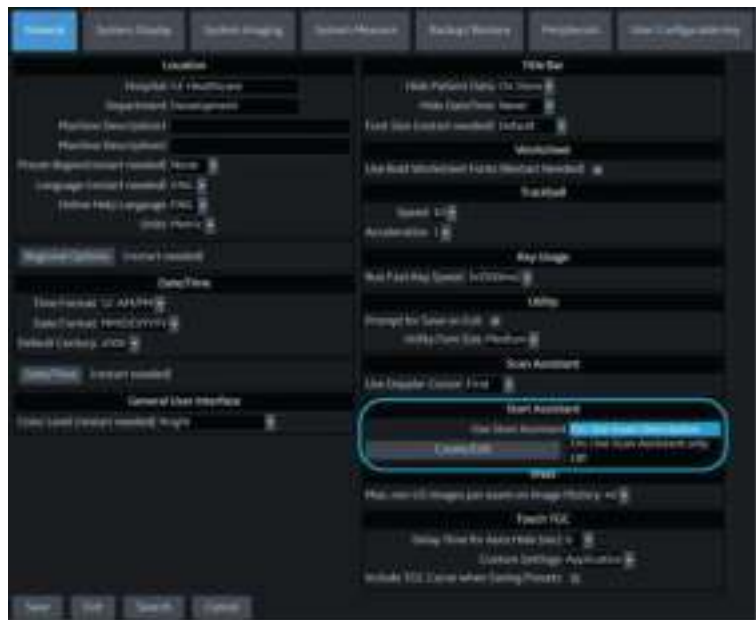

Figure 13-143. Start Assistant Modes

**NOTE:** An Exam Description or Scan Assistant program entry must be present for Start Assistant to save the Mapping.

### **On: Use Exam Description Mode**

In *On: Use Exam Description* mode, Start Assistant saves and loads the following exam settings:

- Exam Description - Populated from the Worklist item, the Exam Description is the default key by which the exam Mapping is saved.
- Category
- Scan Assistant
- Preset
- Probe

If a new Patient is entered manually (without using a Worklist), and no Exam Description is entered, Scan Assistant will become the key by which the Mapping is saved.

### **On: Use Scan Assistant only Mode**

In *On: Use Scan Assistant only* mode, the exam description is ignored and the selection of the Preset and Probe is based on the Scan Assistant protocol only. The Exam Category and Scan Assistant program are not automatically selected and Start Assistant Editor does not show the Exam Description column. Manual entry of an Exam Description for table entry is prevented.

Saved Start Assistant Exam Mappings can also be added, edited or deleted with the Start Assistant Mapping Editor - See 'Start Assistant Mapping Editor' on *page 13-317 for more information*.

**NOTE:** *When using Start Assistant Mapping Editor in "On: Use Scan Assistant only" mode, the Exam Description field will not appear on the Start Assistant Mapping Editor, Add Start Assistant Mapping or Edit Start Assistant Mapping screens.*

## Start Assistant Mapping Editor

The Start Assistant Mapping Editor can be accessed from the Utility->System->General screen by selecting “Create/Edit” under the Start Assistant section (see Figure 13-144).

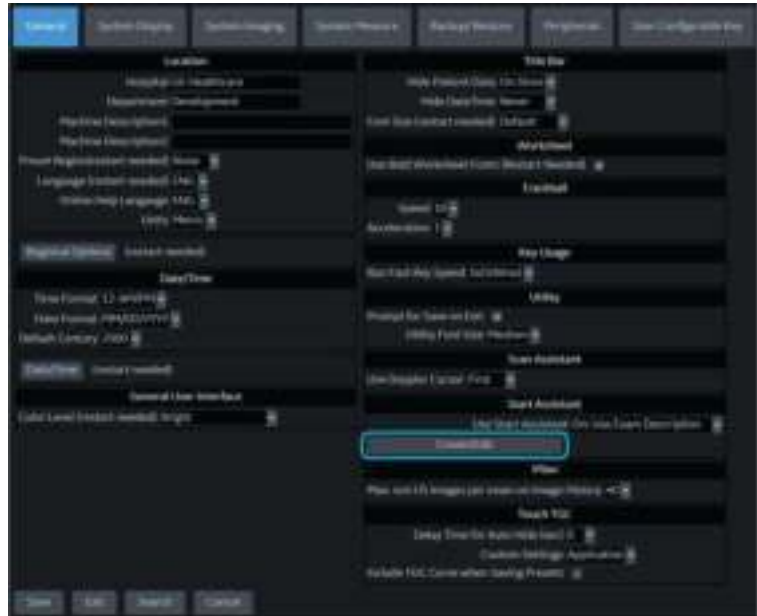

Figure 13-144. Start Assistant Create/Edit

On the Start Assistant Mapping Editor screen you can Add, Edit or Remove a Start Assistant map (see Figure 13-145).



Figure 13-145. Start Assistant Mapping Editor

**NOTE:** When using Start Assistant Mapping Editor in “On: Use Scan Assistant only” mode, the Exam Description field will not appear on the Start Assistant Mapping Editor, Add Start Assistant Mapping or Edit Start Assistant Mapping screens.

## Add a Start Assistant Mapping

Select **Add** from the Start Assistant Mapping Editor screen to add a new mapping (see Figure 13-146).

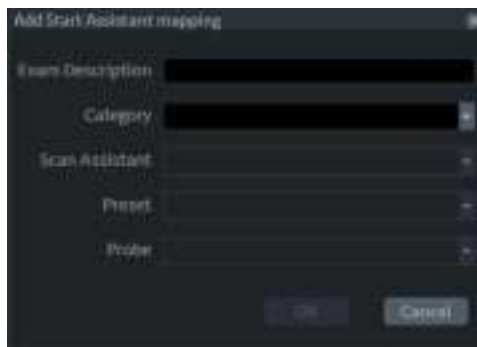

Figure 13-146. Add Start Assistant Mapping

## Edit a Start Assistant Mapping

Highlight an existing mapping on the Start Assistant Mapping Editor screen and select **Edit** or double-click the item to edit a mapping (see Figure 13-147).

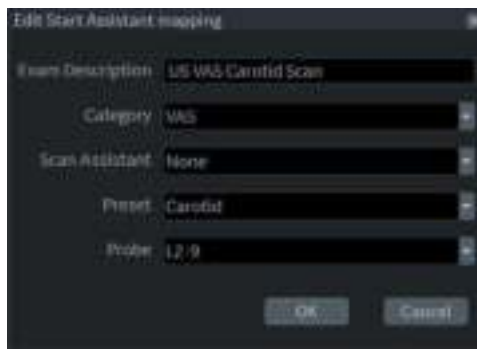

Figure 13-147. Edit Start Assistant Mapping

## Delete a Start Assistant Mapping

Highlight one or more existing mappings and select **Delete** to delete.

## **Save and Exit Start Assistant Mapping Editor**

Before exiting Start Assistant Mapping Editor, select **Save** to save any changes you have made.

Select **Exit** to exit Start Assistant Mapping Editor.

# Scan Assistant

## Introduction

Scan Assistant provides an automated exam script that moves you through an exam step-by-step. This allows you to focus on performing the exam rather than on controlling the system and can help you to increase consistency while reducing keystrokes. The system automatically invokes the correct mode and imaging parameters, advances to the next step in an exam, annotates the image, initiates measurements, and assigns the measurements to the worksheet/report.

**NOTE:** *Scan Assistant Creator (off-board) only supports 64-bit Windows.*

## Availability

The following additional imaging parameters and preferences are available for use in a Scan Assistant program: Contrast, Contrast Clock, CW Doppler, Dual on Freeze, Depth, Color Scale, PW Doppler Scale, PW Sample Volume size, and Flow Model Selection.

You can initiate one or more manual Doppler measurements/calculations.

Body Patterns are available for use during a Scan Assistant program. You can turn a Body Pattern on/off, select a particular Body Pattern graphic, and specify the position of the probe mark on the Body Pattern graphic.

The footswitch can be used with Scan Assistant. You can map Pause/Resume, Previous Step, and Next Step to the footswitch.

The “Always Use Doppler Cursor” preset, available on the Utility --> System --> General page, allows all PW Doppler steps to start with full screen 2D image plus mode cursor. You can specify the Store Order in Scan Assistant to set the Reading Order for the radiologist. The Learn Probe attribute can be set to learn and change the probe for the user in the middle of the exam.



## Scan Assistant Definitions

Scan Assistant definitions:

- **Scan Assistant Manager.** Available via the Utility -> Scan Assistant page to import/export Programs created via the Scan Assistant Creator and to assign Programs to a user/exam category.
- **Import.** Used to load Programs created via the Scan Assistant Creator on to the LOGIQ Totus.
- **Export.** Used to move Programs from one LOGIQ Totus system to another LOGIQ Totus.
- **Scan Assistant Creator.** Used to create Scan Assistant Programs.

## Scan Assistant Description



Figure 13-148. Scan Assistant Display Description

1. Program name, completed steps/out of total number of steps, and step description area.
2. Program step status (Complete/Incomplete), step number, step name. A checkmark indicates that this step has been completed. You can also manually check the box to bypass this step.
3. This column indicates the mode or when a measurement needs to be made.
4. This column indicates that the action moves the Program to the next step.
5. Active step The box is green when the program is active or yellow when it is paused.
6. Navigation: Stop, Pause, Pause/Resume. Edit (Pencil Icon). Also available via the left/right keyboard arrow keys. Stop also allows the program to be stopped, restarted, or a new program selected.

## Setting up Scan Assistant

To set up Scan Assistant,

1. Import the Scan Assistant Program created using the Scan Assistant Creator or exported from another LOGIQ Totus program.
  - a. Insert the media with the saved Program from the Scan Assistant Creator or exported program from another LOGIQ Totus.
  - b. Press Utility -> Scan Assistant.
  - c. Select Import from the Scan Assistant Manager page.
  - d. In the Source field at the top of the Import Programs pop-up, select the media that the Program is stored on.
  - e. Highlight the Program(s) to be imported. If a folder is highlighted, all programs in the folder are selected.
  - f. Select Import. The Program(s) you selected are stored to the LOGIQ Totus. You can add it to the exam category and user.
2. Assign the imported Program to the exam category and user. Under Program Selections on the right-hand side of the Scan Assistant Manager page, specify the Exam Category and User for this Program. You can select All Users, or a specific user. If you specify All Users, all users will have the ability to use this Program while in the specified exam category, unless the user has his/her own list defined.
3. Select the imported Program from Available Programs-> Custom Programs on the left-hand side of the page. Then press the right arrow button to move the imported Program to the exam category and user selected above.

## Setting up Scan Assistant (continued)

4. The Program list you created in Utility ->Scan Assistant is visible in the Program field on the Patient menu. Pressing **New Patient** erases any patient data and Scan Assistant program you entered. First press **New Patient** and then set up patient data, Scan Assistant program, and finally, press **Register Patient**.

You can access the Scan Assistant Creator to edit the exam's program from the imaging display via the Creator Icon located at the bottom, left-hand corner of the Scan Assistant Program monitor on the display. You can activate the Scan Assistant Creator from the image screen, make edits, and then run Scan Assistant to test your changes.

*NOTE: If you edit the program after you have already stored several images, and your edits change the number of program steps, you are prompted to Restart or Continue the Scan Assistant program.*

*NOTE: If you edit the program after you have already completed several steps, checkmarked steps remain checkmarked, even if you insert a new step between checkmarked steps. If this is not correct, you can edit the checkmarks or restart the program.*

## Using Scan Assistant

After you have set up Scan Assistant, the Program is active when you exit the Patient menu. The Program is located on the left-hand side of the display and as you can see in the example below, the annotation for the first step has been automatically noted on the image, ready for you to scan the specified anatomy.

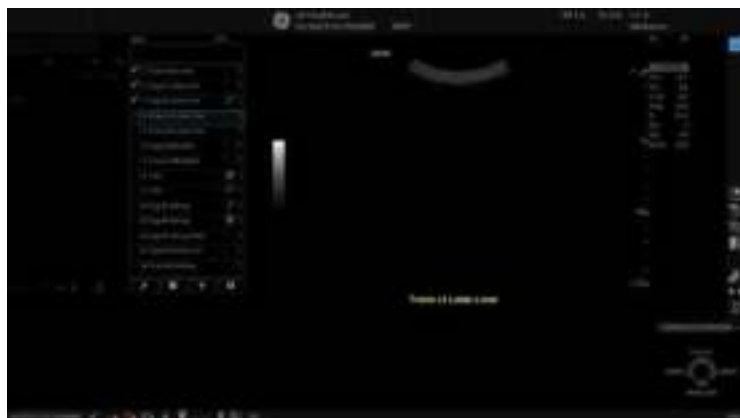

Figure 13-149. Scan Assistant Display

1. Follow the steps indicated in the Program: image/measure the appropriate anatomy.
2. Perform the indicated trigger to move to the next step in the Program.

**NOTE:** *The footswitch can be used with Scan Assistant. You can map Pause/Resume, Previous Step, and Next Step to the footswitch.*

3. To pause or unpause Scan Assistant, press the pause button on the display or press the left/right arrow on the keyboard.
4. To stop or restart a Program, press the Stop icon at the bottom of the Scan Assistant Program. A dialog pops up. This dialog lets you restart the current Program, start another Program, or stop Scan Assistant.
5. To skip a step or move to a certain step, press the up/down arrows on the keyboard or select the step you want to move to using the Trackball and Set keys.

### Reference Images

#### Overview

Reference images can be attached to a step of Scan Assistant protocol. The reference image is displayed in an extra window on the scan screen during scanning with the protocol.

Any image (JPEG/DICOM) can be attached to (or removed from) a protocol with Scan Assistant Creator.

#### Using Reference Images

A reference image window appears when a protocol with a reference image attached is active. The window is positioned over the preview window and can be moved anywhere on the screen (the system will remember the last image position).



Figure 13-150. Reference Image Window

1. Minimize window by clicking minimize button in upper left window corner.
2. Change window size by dragging window corners.
3. Drag to move window anywhere on screen.

## Inserting a step

1. To insert a pre-defined step to the active Scan Assistant Program, press the Plus Sign (+) on the Scan Assistant Display.



Figure 13-151. Insert Steps

The Insert Steps Pop-Up Menu appears.

2. Select the steps to be inserted via the pull-down Scan Assistant menu.

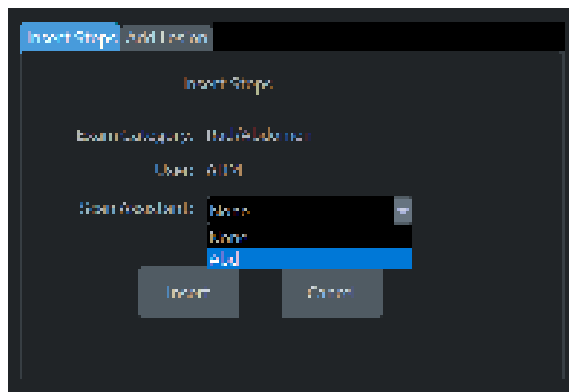

Figure 13-152. Select from pull-down menu

3. Press Insert. All the steps in the inserted program are added immediately after the active step in the current program.

To undo inserted steps, use Edit button to edit the program and delete the recently inserted steps.

**NOTE:** After the exam is completed, the system removes the temporarily saved Scan Assistant program with inserted steps.

**NOTE:** The inserted steps is not adapt the annotation and body pattern from the active step.

## Breast Measurement Auto Insert Steps

To add a program to be inserted whenever the Add Lesion key is selected,

1. Press the Plus Sign (+) on the Scan Assistant Display.



Figure 13-153. Insert Steps

2. Select the "Add Lesion" tab.
3. Identify a breast lesion while using a breast scan assistant program. Freeze on the lesion and press "Add Lesion" on the measurement menu.
4. Complete the length measurement of the lesion. Unfreeze the image.
5. Upon unfreeze, the predefined program is inserted into the existing program and the next step is started.



Figure 13-154. "BreastLesionAssess"

In this example, BreastLesionAssess contains four (4) steps, as indicated within the brackets on the figure above.



## Exporting Scan Assistant Programs to Another LOGIQ Totus

Exporting Scan Assistant Programs allows them to be imported to another LOGIQ Totus or to be edited offline with the Scan Assistant Creator tool. To export a Program,

1. Insert the media to save the Program to.
2. Press Utility -> Scan Assistant.
3. Select Export from the Scan Assistant Manager page.
4. In the Source field at the top of the Export Programs pop-up, select the media that the Program is to be stored on.
5. Specify the Program Directory using the drop-down menu if the desired Program Directory already exists on the media. If not, or if you want to export the Program to a new Program Directory, type a new Program Directory name in the field.
6. Highlight the Program(s) to be exported. If a folder is highlighted, all programs in the folder are selected.
7. Select Export. The Program(s) you selected are stored to the media. You can now import it to a new LOGIQ Totus.

## Scan Assistant Creator

### Overview

Scan Assistant Creator is used to build customized Programs that can be imported onto the LOGIQ Totus. These Programs automate many of the steps normally performed manually by the user, thereby reducing the number of user actions and the amount of time to perform an exam.

The Scan Assistant Creator tool can be used both on the scanner and as an off scanner tool.

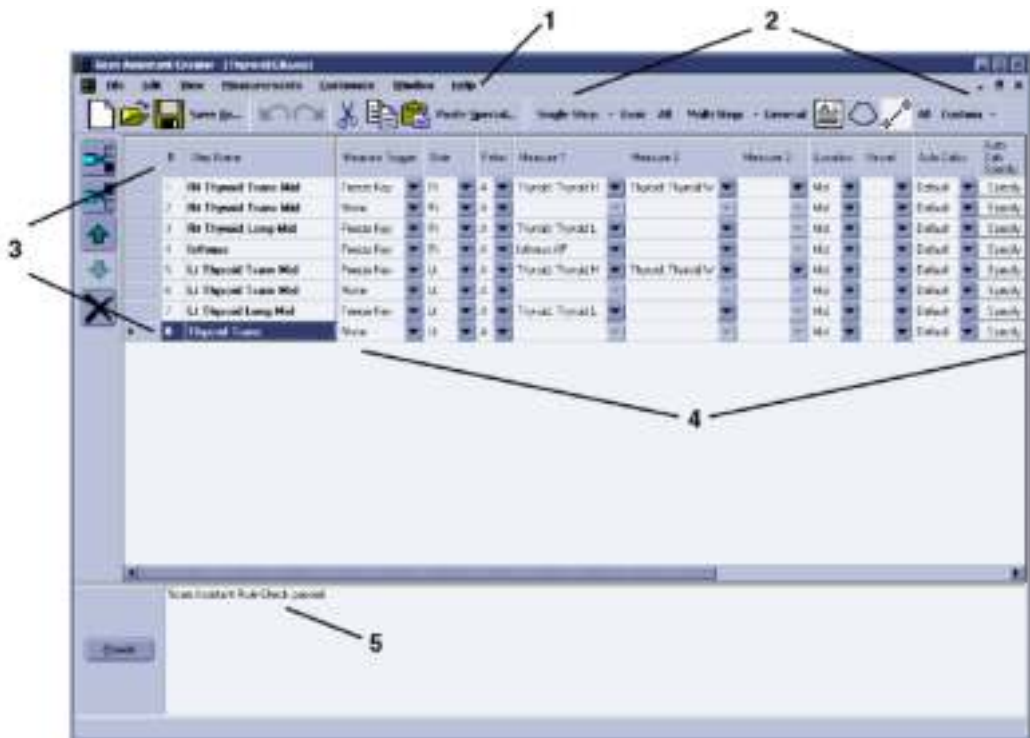

Figure 13-155. Tool Layout Overview

- 1. Menu
- 2. Toolbars
- 3. Steps
- 4. Step Attributes
- 5. Rule Checking

## Help

Help is available via the F1 key.

## File Handling

When using Scan Assistant Creator off the scanner, it is very important to organize the programs in a way that will make it easy to import the programs onto the scanner. Each Program is a computer file. While these computer files can be copied, pasted and deleted like any other computer file, the Program files are only viewable using the Scan Assistant Creator.

## File Extensions

Factory defined Programs have an .ep (exam Program) extension while user-defined Programs have an .uep (user exam Program) extension. Both factory and user-defined Programs can be read into the Scan Assistant Creator, but only user-defined Programs are created. If a factory Program is read into the Scan Assistant Creator and then edited, it is saved as a user-defined Program.

## Off-Scanner Directory Structure

The Scan Assistant Creator organizes the Programs in a directory structure that allows easy importing into the LOGIQ Totus. In order to be imported, all Programs must be stored in a LOGIQ\_SCAN\_ASSISTANT Programs Directory. Within this directory, one or more user-specified directories are created. Within each of these user-specified directories are the category directories (VAS, ABD, etc.) that hold the actual Programs.

The dialog in the figure below allows the user to specify the location of the LOGIQ\_SCAN\_ASSISTANT directory (root directory) and to either select an existing User Program Directory or create a new one.

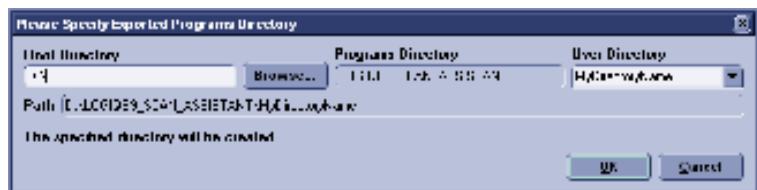

Figure 13-156. Directory Structure

### Exporting Programs from LOGIQ Totus

Factory or user-defined Programs on the LOGIQ Totus are easily exported for editing with the Scan Assistant Creator.

On the LOGIQ Totus:

1. Insert a USB storage device.
2. Select **Utility -> Scan Assistant**.
3. Select **Export**.
4. Select the media type and specify a directory. If a directory is specified that already exists, the Export adds the Programs along with any existing Programs. If the names of Programs are the same, use the resulting dialog to decide how to continue.
5. Select the Program to be exported and export them.

On the computer with the Scan Assistant Creator installed:

1. Insert the USB storage device used above.
2. Copy the LOGIQ\_SCAN\_ASSISTANT directory from the USB storage device to the hard drive. The hard drive directory that you copy to is the root directory. If you want to work with the Programs directly on the USB storage device, this step can be skipped.
3. Either open a Program by double-clicking it or selecting File '-> Open from the Scan Assistant Creator.

## Importing Programs to LOGIQ Totus

Programs created with the Scan Assistant Creator are easily imported to the LOGIQ Totus.

On the computer with the Scan Assistant Creator installed:

Copy the complete LOGIQ\_SCAN\_ASSISTANT directory from the computer hard drive to a USB device. The LOGIQ\_SCAN\_ASSISTANT directory needs to be at the top level (not in a subdirectory) on the USB device.

Table 13-61: Directory Structure Example

LOGIQ_SCAN_ASSISTANT
MyUserNameDirectory
ABD
CARD
GYN
OB
PED
SMP
UR
VAS

On the LOGIQ Totus:

1. Insert the USB device.
2. Select **Utility** -> **Scan Assistant**.
3. Select **Import**.
4. Select the media type.
5. Select the Programs to be imported and import them. If you attempt to import Programs that already exist with the same name, use the resulting dialog to decide how to continue.

### Sharing Programs

To share a program with someone else, the file can be sent via e-mail as an attachment or copied onto a media. If the person receiving the program has the Scan Assistant Creator tool installed, open the file and use “Save As” to save it to an appropriate directory.

If the person receiving the program does not have the Scan Assistant Creator tool installed, the program can still be loaded onto a scanner by creating the following structure at the top level directory on a media device, copying the file to one of the category directories and then importing the protocol onto the scanner.

Table 13-62: Media Directory Structure

LOGIQ_SCAN_ASSISTANT
User Program Directory (Any user name)
Category Directories (e.g. ABD, CARD)

To share an entire portfolio of programs with someone else, the entire user program directory can be zipped. Make sure to set the options to include subfolders and to include relative path information. On the receiving end, the user can unzip the directory into a LOGIQ\_SCAN\_ASSISTANT directory.

### Exporting the Scan Assistant Creator to a PC

To export the Scan Assistant Creator to a PC,

1. Insert a USB Flash Drive in a USB port on the Control Panel.
2. Press **Utility** -> **Scan Assistant**.
3. Press **Export**.
4. Place a checkmark in the Export Scan Assistant Creator Installation.
5. Press **Export**.

### Creating and Editing Programs

To access Scan Assistant Creator on the LOGIQ Totus:

1. Select **Utility -> Scan Assistant**.
2. Select **Creator** on the Scan Assistant Manager tab on the monitor.

### Creating New Programs

1. Select File -> New.
2. Before creating a New Program, select **Single Step** or **Multi Step** in the Toolbar.



Figure 13-157. File Toolbar

3. Proceed to add/update your settings for the Step: Step Name, Instructions, etc.
4. Once finished, highlight the finished Step.
5. Select **Edit -> Copy**
6. In the Toolbar along the left, select **Insert Step Before Selected** or **Insert Step After Selected**.



Figure 13-158. Insert Step

7. Highlight the copied step and proceed to edit accordingly.
8. Proceed to follow the same procedure to add more steps to your Program.



**Creating New Programs (continued)**

9. When done, select **Check** to verify your Steps.



Figure 13-159. Rule Check and results area

10. The results are listed as to whether the Scan Assistant Rule Check Passed or if any Issues were detected. Issues found when running the check do not mean the Program is unusable.

**NOTE:** *The rule check may report an unequal number of left and right steps. This may or may not be the expected result. If a change is made in response to the rule check results, a new rule check can be run to see if the issue has been resolved.*

### Editing Programs

When editing Programs, changes can be made at both the step level and the step attribute level. Steps can be added, inserted, moved, deleted, copied and pasted. Step attributes can be modified for a given step or across multiple steps.

### Editing Steps

The step toolbar allows steps to be inserted, moved up and down, and deleted. For steps to be moved, one or more consecutive steps must be selected.

When the last step in a Program is selected, the Enter key automatically appends a new step to the end of the Program and selects the new step. When the Enter key is pressed on any other step, the next step is activated. The up and down arrows can also be used to move between steps.



Figure 13-160. Step Toolbar and Edit Toolbar and Menu

- |   |  |
|---|--|
| 1. Insert Step above selected step (Ctrl+I)     | 5. Delete selected step(s)                                       |
| 2. Insert Step below selected step              | 6. Edit Toolbar (Undo, Redo, Cut, Copy, Paste and Paste Special) |
| 3. Move selected step(s) up (Ctrl+Up Arrow)     | 7. Edit Menu (same toolset as the Edit Toolbar)                  |
| 4. Move selected step(s) down (Ctrl+Down Arrow) |  |

When selecting multiple steps for Cutting or Copying, the Shift + Left Mouse and Ctrl + Left Mouse key combinations can be used.

## Editing Steps (continued)

### Paste Special

The Paste Special control allows copied steps to be pasted with some modification. Select the desired Conversion and select **Paste**. An added feature to the Paste Special control is the Define Conversions function, which is used to define the text that is converted. An example is shown in the figure below. If an exact case match is found, it is used for the conversion. If there is a match, but with a different case, it is used only if there is not an exact case match.

There are 3 user-defined conversions that can be edited and named. These user-defined conversions can also be used to perform a find and replace capability.

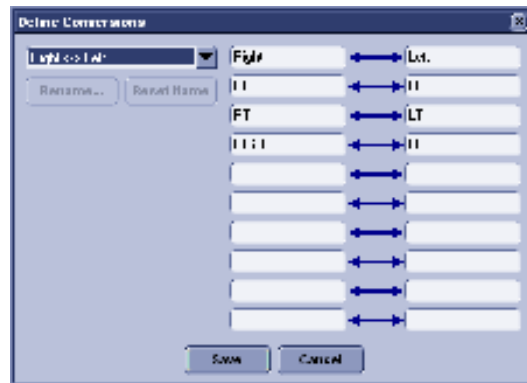

Figure 13-161. Define Conversions Dialog

### Editing Step Attributes

To edit a step attribute, select the step attribute and edit it, such as picking from a drop down menu, checking or unchecking a box, or typing in text. To edit multiple steps in a Multi Step view, select the step attribute of choice and do the following actions:

- Set the value of the step attribute as desired.
- Left click (and release) in the square in the bottom right-hand corner of the attribute.
- Drag to highlight the other steps to be changed in the same way.
- Left click (and release) again.

This will take the original step's content and copy it down the highlighted steps. This is also available when multiple attributes are selected within the same step.

To edit multiple steps in the single step view, highlight the multiple steps that you want to edit and then change the step attribute. If a step attribute is highlighted in green, this indicates that its current value varies across the selected steps.

If a step attribute is not editable, it may be because the attribute requires a different attribute to be set a particular way in order to become enabled. These dependencies are outlined below.

Table 13-63: Step Attribute Dependencies

Step Attribute	Dependency
PDI	Color step attribute must be checked
Color / Dop Steer	Color or PW step attribute must be checked
Measure 1	Measure Trigger must not be set to None
Measure 2	Measure 1 must be set
Measure 3	Measure 1 and Measure 2 must be set

## Editing the Current Program on the Scanner

If you are currently using a Scan Assistant program and choose to edit that program while using it (by selecting the pencil icon at the bottom of the Scan Assistant steps), the program will be reloaded when scanning is restarted. If the number of steps is changed, the checkmarks that were in place before editing are cleared. If the number of steps in the program has not changed, the checkmarks that were in place before editing are maintained.

The current program can be restarted at any time by selecting the Stop button on the Scan Assistant navigation window and selecting restart.

## Opening Existing Programs

Multiple Programs can be open at the same time by selecting File -> Open. Each Program will open within the primary Scan Assistant Creator window. Finding the Program file (.ep or .uep) and opening the file automatically opens the file in the Scan Assistant Creator.

To switch between Programs, the title banner of the window is selected or the Program is selected from the Window Menu. An asterisk indicates that the Program has been edited but not saved.

With multiple Programs open, steps copied from one Program can be inserted into another Program via the paste or paste special features.

## Saving Programs

Programs are saved via Save or Save As.

When Saving a Program, the Scan Assistant Creator provides an opportunity to run a rule check on the Program before saving.

**NOTE:** *The name of a Program is appended with an asterisk (\*) when the Program has been changed, but those changes have not yet been saved*

## Views

A Program is made up of a series of steps. Each step is made up of various step attributes. The step and step attribute data can be viewed in many ways using the Scan Assistant Creator. The different ways to look at the data are called Views.

### Single Step Views

There are two Single Step views: Basic and All. The Basic view shows the most common attributes of the selected step. The All view shows all of the attributes of a given step.

For both views, the step names are shown on the left with the active step highlighted. The step attributes appear on the right and are separated into four groupings:

- General attributes at the top
- Imaging and Comment attributes on the left
- Measure attributes on the right.

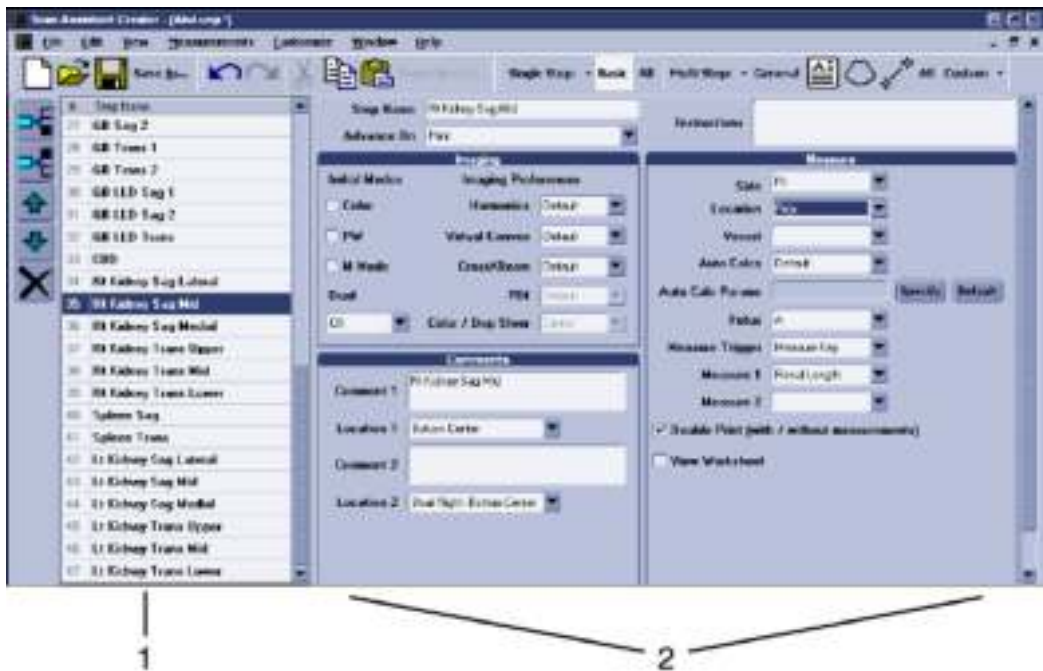

Figure 13-162. Basic Single Step View

1. Steps

2. Step Attributes

## Multi Step Views

Multi Step views show certain step attributes for all the steps in a Program. There are six Multi Step views: General, Comment, Scan, Measure, Custom and All.

#	Step Name	Scan Mode	Per. Decodes Mode	M. Mode	Out	Forecast	Value Codes	Count/Event	PTI	Color/Tag Code	LED/View	Default View	Default Step
10	Line 7 RR Railway	<input type="checkbox"/>	<input type="checkbox"/>	<input type="checkbox"/>	On	Default	Default	Default	Default	Color	<input type="checkbox"/>	<input type="checkbox"/>	<input type="checkbox"/>
13	Main Portal View	<input type="checkbox"/>	<input type="checkbox"/>	<input type="checkbox"/>	On	Default	Default	Default	Default	Color	<input type="checkbox"/>	<input type="checkbox"/>	<input type="checkbox"/>
20	Main Portal View	<input checked="" type="checkbox"/>	<input type="checkbox"/>	<input type="checkbox"/>	On	Default	Default	Default	Default	Color	<input type="checkbox"/>	<input type="checkbox"/>	<input type="checkbox"/>
31	Main Portal View	<input checked="" type="checkbox"/>	<input checked="" type="checkbox"/>	<input type="checkbox"/>	On	Default	Default	Default	Default	Color	<input type="checkbox"/>	<input type="checkbox"/>	<input type="checkbox"/>
23	Line Trans Left Lobe	<input type="checkbox"/>	<input type="checkbox"/>	<input type="checkbox"/>	On	Default	Default	Default	Default	Color	<input type="checkbox"/>	<input type="checkbox"/>	<input type="checkbox"/>
24	Line Trans Right Lobe 1	<input type="checkbox"/>	<input type="checkbox"/>	<input type="checkbox"/>	On	Default	Default	Default	Default	Color	<input type="checkbox"/>	<input type="checkbox"/>	<input type="checkbox"/>
24	Line Trans Right Lobe 2	<input type="checkbox"/>	<input type="checkbox"/>	<input type="checkbox"/>	On	Default	Default	Default	Default	Color	<input type="checkbox"/>	<input type="checkbox"/>	<input type="checkbox"/>
25	Hoplink Value	<input type="checkbox"/>	<input type="checkbox"/>	<input type="checkbox"/>	On	Default	Default	Default	Default	Color	<input type="checkbox"/>	<input type="checkbox"/>	<input type="checkbox"/>
26	GR Sag 1	<input type="checkbox"/>	<input type="checkbox"/>	<input type="checkbox"/>	On	On	Default	Default	Default	Color	<input type="checkbox"/>	<input type="checkbox"/>	<input type="checkbox"/>
27	GR Sag 2	<input type="checkbox"/>	<input type="checkbox"/>	<input type="checkbox"/>	On	On	Default	Default	Default	Color	<input type="checkbox"/>	<input type="checkbox"/>	<input type="checkbox"/>
28	GR Trans 1	<input type="checkbox"/>	<input type="checkbox"/>	<input type="checkbox"/>	On	On	Default	Default	Default	Color	<input type="checkbox"/>	<input type="checkbox"/>	<input type="checkbox"/>
29	GR Trans 2	<input type="checkbox"/>	<input type="checkbox"/>	<input type="checkbox"/>	On	On	Default	Default	Default	Color	<input type="checkbox"/>	<input type="checkbox"/>	<input type="checkbox"/>
30	GR LED Sag 1	<input type="checkbox"/>	<input type="checkbox"/>	<input type="checkbox"/>	On	On	Default	Default	Default	Color	<input type="checkbox"/>	<input type="checkbox"/>	<input type="checkbox"/>
31	GR LED Sag 2	<input type="checkbox"/>	<input type="checkbox"/>	<input type="checkbox"/>	On	On	Default	Default	Default	Color	<input type="checkbox"/>	<input type="checkbox"/>	<input type="checkbox"/>
32	GR LED Trans	<input type="checkbox"/>	<input type="checkbox"/>	<input type="checkbox"/>	On	On	Default	Default	Default	Color	<input type="checkbox"/>	<input type="checkbox"/>	<input type="checkbox"/>
33	CRD	<input type="checkbox"/>	<input type="checkbox"/>	<input type="checkbox"/>	On	Default	Default	Default	Default	Color	<input type="checkbox"/>	<input type="checkbox"/>	<input type="checkbox"/>
34	RR Railway Sag Lateral	<input type="checkbox"/>	<input type="checkbox"/>	<input type="checkbox"/>	On	Default	Default	Default	Default	Color	<input type="checkbox"/>	<input type="checkbox"/>	<input type="checkbox"/>
35	RR Railway Sag Mid	<input type="checkbox"/>	<input type="checkbox"/>	<input type="checkbox"/>	On	Default	Default	Default	Default	Color	<input type="checkbox"/>	<input type="checkbox"/>	<input type="checkbox"/>
36	RR Railway Sag Meas	<input type="checkbox"/>	<input type="checkbox"/>	<input type="checkbox"/>	On	Default	Default	Default	Default	Color	<input type="checkbox"/>	<input type="checkbox"/>	<input type="checkbox"/>



Figure 13-163. Multi Step Scan View

1. Steps

2. Step Attributes

### Customizing Multi Step Views and HTML Export

The contents of the Multi Step Views and the HTML Export is configurable via the Customize Menu or the small downward pointing arrow next to the word "Custom" on the View Toolbar Menu.



Figure 13-164. Customize Menu

The Language selection allows the Scan Assistant Creator language to be configured.

The column widths of the steps and step attributes are customizable. The desired width is set by selecting and dragging the line separating column headers. These adjustments are remembered for the next time the Scan Assistant Creator is used.

The locations of the toolbars are customizable. The location is set by selecting and dragging the toolbar gripper as shown in the figure below. The toolbars can be placed at the top, left, right or bottom of the Scan Assistant Creator.

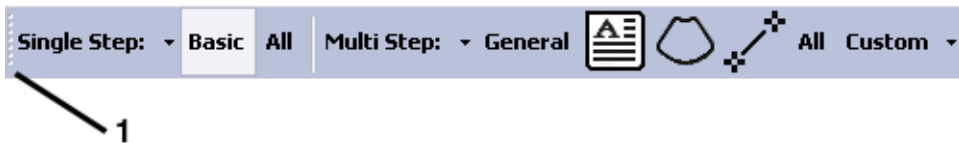

Figure 13-165. Gripper used for Toolbar placement

1. Toolbar Gripper



## Customizing Multi Step Views and HTML Export (continued)

### Multi Step View

In the Customize Multi Step Views dialog, each tab represents a different Multi Step view. Within a tab, the checked boxes are the step attributes that are displayed in that Multi Step view. The views are independent of one another, so if a step attribute is desired in both views, it needs to be selected in both views.

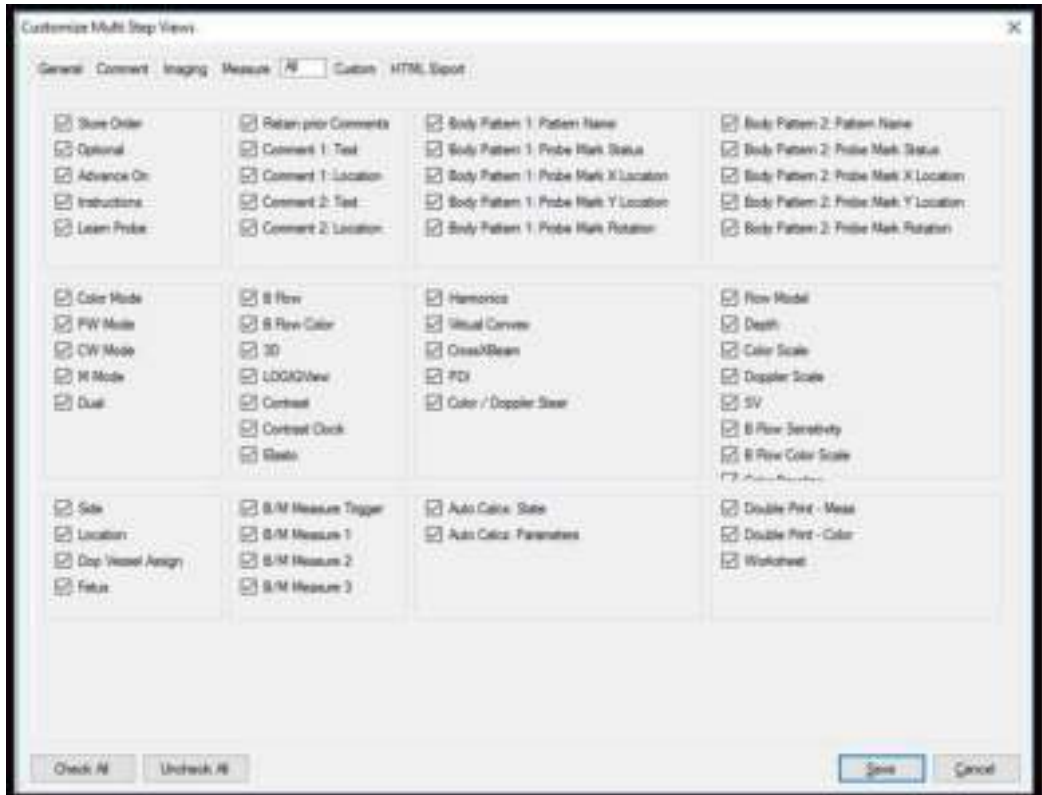

Figure 13-166. Customize Multi Step Views Dialog

Customizing Multi Step Views and HTML Export (continued)

HTML Export

The HTML Export feature allows a Program to be stored in a file format (\*.mht) that is compatible with Windows Internet Explorer. This file is useful for printing the Program or viewing the Program, but is not useful for editing the Program. HTML Export is available via the File Menu.

An example of how a Program looks in HTML format is shown below.

Step Name	Enabled	Advanced On	Bookmarks	Comment 1	Location 1	Comment 2	Location 2	Location 3	Color Name	HP Disabled	H Mode	Cool	Maintenance	Virtual Servers	Group/Streams	FOL	Color/Step	LOG/View
01 Thermal Trans Wd	Yes	Free		01 Thermal Trans Wd	Bottom Center		01 Thermal Trans Wd	01 Thermal Trans Wd	Blue Right Bottom Corner	Yes	Yes	Off	Default	Default	Default	Default	Center	No
02 Thermal Trans Wd	Yes	Free		02 Thermal Trans Wd	Bottom Center		02 Thermal Trans Wd	02 Thermal Trans Wd	Blue Right Bottom Corner	Yes	Yes	Off	Default	Default	Default	Default	Center	No
03 Thermal Long Wd	Yes	Free		03 Thermal Long Wd	Bottom Center		03 Thermal Long Wd	03 Thermal Long Wd	Blue Right Bottom Corner	Yes	Yes	Off	Default	Default	Default	Default	Center	No
04 Thermal Wd	Yes	Free		04 Thermal Wd	Bottom Center		04 Thermal Wd	04 Thermal Wd	Blue Right Bottom Corner	Yes	Yes	Off	Default	Default	Default	Default	Center	No
05 Thermal Wd	Yes	Free		05 Thermal Wd	Bottom Center		05 Thermal Wd	05 Thermal Wd	Blue Right Bottom Corner	Yes	Yes	Off	Default	Default	Default	Default	Center	No
06 Thermal Wd	Yes	Free		06 Thermal Wd	Bottom Center		06 Thermal Wd	06 Thermal Wd	Blue Right Bottom Corner	Yes	Yes	Off	Default	Default	Default	Default	Center	No
07 Thermal Long Wd	Yes	Free		07 Thermal Long Wd	Bottom Center		07 Thermal Long Wd	07 Thermal Long Wd	Blue Right Bottom Corner	Yes	Yes	Off	Default	Default	Default	Default	Center	No
08 Thermal Trans	Yes	Free		08 Thermal Trans	Bottom Left	Right Ledge Thermal Long Wd	Bottom Left	Bottom Left	Blue Right Bottom Corner	Yes	Yes	Off	Default	On	Default	Default	Center	No

Figure 13-167. HTML Export

## Keyboard Navigation

In addition to moving the windows pointer and selecting an item, there are several keyboard controls to help navigate through the Views.

Table 13-64: Keyboard Program Navigation

Keyboard Entry	Step Selected	Step Attribute Selected
Enter	Moves to next step. If on the last step, it creates a new step and selects it.	Single Step View: Varies based on the step attribute selected. Multi Step View: Moves to same step attribute in the next step. If on the last step, it creates a new step and selects it.
Tab	Single Step View: Moves to next step. On the last step it moves to the first step attribute. Multi Step View: Moves to the first step attribute.	Moves to next step attribute. If last attribute for the step, moves to next step.
Alt+Tab	Single Step View: Moves to previous step. On the first step it moves to the last step attribute. Multi Step View: Moves to the last step attribute of the previous step.	Moves to next step attribute. If first attribute for the step, moves to previous step.
Up Arrow	Moves to previous step	Single Step View: Varies based on the step attribute selected. Multi Step View: Moves to same step attribute in the previous step.
Down Arrow	Moves to next step	Single Step View: Varies based on the step attribute selected. Multi Step View: Moves to same step attribute in the next step.
Left Arrow	No action	Single Step View: Varies based on the step attribute selected. Multi Step View: Moves to the previous step attribute.
Right Arrow	Single Step View: No action. Multi Step View: Moves to the first step attribute.	Single Step View: Varies based on the step attribute selected. Multi Step View: Moves to next step attribute.
Page Up	Scrolls to previous page of steps	Single Step View: Varies based on the step attribute selected. Multi Step View: Moves to same step attribute in the previous step.
Page Down	Scroll to next page of steps	Single Step View: Varies based on the step attribute selected. Multi Step View: Moves to same step attribute in the next step.

### Scan Assistant Features

Scan Assistant allows the user to program the steps in an exam and to program certain attributes for each step. The attributes are what give the Scan Assistant Program behavior. The tables below provide the names of all attributes along with a description.

#### General Attributes

Table 13-65: General Attributes

Attribute Name	Description
Store Order Specify	Used to enable the Store Order Definition dialog so that the Store Order can be set
Store Order	Specifies the Store Order number associated with the Step
Step Number	Number of the step that appears in the Scan Assistant Navigation menu
Step Name	Name of the step that appears in the Scan Assistant Navigation menu
Advance On	<ul style="list-style-type: none"><li>• Print: Advance to the next step and go live after Print / Image Store (e.g P1 key). This can be a single image store or a loop store.</li><li>• Print &amp; Unfreeze: Advance to the next step after Print / Image Store (e.g. P1 key) and unfreeze. This can be a single image store or a loop store.</li><li>• User Selection: Advance to next step only after next step is manually selected (e.g. down arrow)</li></ul>
Instructions	User notes displayed in the Scan Assistant Navigation menu when the step is active
Optional	Optional: An optional step is given a check mark during Program execution even if no image is acquired Mandatory: A mandatory step is give a check mark only if an image is acquired for the step
Learn Probe	On or Off. Learn and change the probe for the user, when selected.

**Comment Attributes**

Table 13-66: Comment Attributes

Attribute Name	Description
Comment 1, Comment 2	User annotation associated with the step. When editing in a Multi Step View, use Alt+Enter to create a new line.
Location 1, Location 2	Choose where the annotation is located on the image area for single or dual screens.
BP 1,2	Blank: Body Pattern not specified. Selected Body pattern graphic with or without probe position will be set, if selected
BP Specify	Used to enable the Body Pattern Selection dialog so that the Body Pattern graphic can be selected and probe position can be set
BP Clear	Clears BP 1, BP 2 defined for the step
BP Probe	BP Probe mark set by Scan Assistant, when selected
BP X/Y/Rot	Displays the X/Y/Rot information of the Probe mark set from Body Pattern Selection dialog

**Imaging Mode and Imaging Preference Attributes**

The probe and application associated with a program is not configurable. Instead, the scanner remembers the last probe and application used for a given Scan Assistant program and automatically selects them the next time the program is started.



Figure 13-168. Imaging Mode and Imaging Preference Attributes

Table 13-67: Imaging Mode Attributes

Attribute Name	Description
Color, PDI, MVI, PW, CW, M Mode, B Flow, B FLOW Color, 3D, LOGIQView, Contrast, Contrast Clock, Elasto (Strain Elastography) and SWE (Shear Wave Elastography)	<ul style="list-style-type: none"> <li>• On - when selected, the mode is on.</li> <li>• Off - when not selected, the mode is off.</li> </ul>
Dual	<ul style="list-style-type: none"> <li>• Off - Dual screen is not in use.</li> <li>• Left Active - Dual screen is active and the left image is the active image.</li> <li>• Right Active - Dual screen is active and the right image is the active image.</li> <li>• DualView (simul) - DualView is active (both left and right images are live).</li> </ul>

**Imaging Mode and Imaging Preference Attributes (continued)**

**NOTE:** *B Flow Color is not supported by the LOGIQ Totus. It still exists in Scan Assistant Creator because other products that offer B Flow Color use the Scan Assistant Creator program.*

Imaging Preferences work slightly different than other attributes. For example, if an abdomen Program has 20 steps and all steps have the Harmonics attribute set to Default, then Scan Assistant will not affect the harmonics setting. Now, assume that steps 10-12 are gallbladder steps and that the harmonics attribute has been set to on for these steps. When transitioning into this group of steps (step 9 to step 10), harmonics will be turned on (or remain on if it was previously on). If harmonics is then manually turned off in step 10 then Scan Assistant will not turn it back on when advancing to step 11. In other words, a group of consecutive steps with the same Imaging Preference are treated as a group by Scan Assistant and not as individual steps.

Table 13-68: Imaging Preference Attributes

Attribute Name	Description
Harmonics	<ul style="list-style-type: none"> <li>• On - when selected</li> <li>• Off - when unchecked</li> <li>• Default - Not specified so Scan Assistant does not set this attribute.</li> </ul>
Virtual Convex	
CrossXBeam	
Color/Doppler Steer	<ul style="list-style-type: none"> <li>• Left - Color/Doppler steered to the left</li> <li>• Center - Color/Doppler not steered</li> <li>• Right - Color/Doppler steered to the right</li> </ul>
Flow Model	<ul style="list-style-type: none"> <li>• Specified Flow Model is selected - Aorta, Renal, Penetration, Slow Flow, Med Flow, Fast Flow</li> <li>• Default - Not specified so Scan Assistant does not set this attribute.</li> </ul>
Depth	<ul style="list-style-type: none"> <li>• 2.0 to 36.0.</li> <li>• Default - Not specified so Scan Assistant does not set this attribute.</li> </ul>
Color Scale	<ul style="list-style-type: none"> <li>• 1 to 200.</li> <li>• Default - Not specified so Scan Assistant does not set this attribute.</li> </ul>
Doppler Scale	
SV	<ul style="list-style-type: none"> <li>• 1 to 16.</li> <li>• Default - Not specified so Scan Assistant does not set this attribute.</li> </ul>
B-Flow Sensitivity	<ul style="list-style-type: none"> <li>• 1.0 to 50.</li> <li>• Default - Not specified so Scan Assistant does not set this attribute.</li> </ul>
B-Flow Color Scale	<ul style="list-style-type: none"> <li>• 0.02 to 1.5.</li> <li>• Default - Not specified so Scan Assistant does not set this attribute.</li> </ul>
Color Baseline	<ul style="list-style-type: none"> <li>• 0 to 100.</li> <li>• Default - Not specified so Scan Assistant does not set this attribute.</li> </ul>
Doppler Baseline	<ul style="list-style-type: none"> <li>• 5 to 95.</li> <li>• Default - Not specified so Scan Assistant does not set this attribute.</li> </ul>

Measurement Attributes



Figure 13-169. Measurement Attributes

Table 13-69: Measure Attributes

Attribute Name	Description
Side	When selected, the side measurement qualifier is set to: <ul style="list-style-type: none"> <li>• Rt - Right side of the body</li> <li>• Lt - Left side of the body</li> <li>• None - Not used (neither Right nor Left)</li> <li>• Default - Side not specified so Scan Assistant does not set Side</li> </ul>
Location	When selected, the location measurement qualifier is set to: <ul style="list-style-type: none"> <li>• Prox - Proximal</li> <li>• Mid - Middle</li> <li>• Dist - Distal</li> <li>• None - Not used</li> <li>• Default - Location not specified. Scan Assistant does not set Location</li> </ul>
Dop Vessel Assign	Various Doppler measurement Vessel folders Specifies the Vessel folder to assign auto calcs to. The assignment happens when the image is stored / printed (e.g. P1 key).
Auto Calcs	When selected, the Auto Calcs state is set to: <ul style="list-style-type: none"> <li>• Frozen</li> <li>• Live</li> <li>• Off</li> <li>• Default - Auto Calcs state not specified. Scan Assistant does not set Auto Calcs state.</li> </ul>
Auto Calc Params	<ul style="list-style-type: none"> <li>• Various Auto Calc parameters - specifies the auto calc parameters to be used.</li> <li>• Default - Auto Calc parameters are not specified. Scan Assistant does not set the Auto Calc parameters.</li> </ul>
Auto Calc Specify	Used to enable the Auto Calcs Parameter Selection dialog so that the Auto Calc Params attribute can be set
Auto Calc Default	Used to set the Auto Calcs Params attribute to Default.



Table 13-69: Measure Attributes (Continued)

Attribute Name	Description
Fetus	When selected, the fetus measurement qualifier is set to: <ul style="list-style-type: none"> <li>• A - Fetus A</li> <li>• B - Fetus B</li> <li>• C - Fetus C</li> <li>• D - Fetus D</li> <li>• Default - Fetus not specified so Scan Assistant does not set Fetus</li> </ul>
B/M Measure Trigger	When selected, the following action initiates the "Measure 1" attribute: <ul style="list-style-type: none"> <li>• Measure Key</li> <li>• Freeze Key</li> <li>• Image Store - when the Measure key is manually selected or the image is stored. This is used to store / print an image and then measure on it and then store it again. Therefore, the Advance On Print attribute is ignored on the first store / print when the Measure Trigger attribute is set to Image Store.</li> <li>• None - Measurements are not triggered by Scan Assistant. The "Measure 1" attribute is ignored.</li> </ul>
B/M Measure 1	Various 2D or M-Mode measurements Specifies the first 2D or M-Mode measurement to be initiated. The point at which the measurement is initiated is based upon the Measure Trigger attribute.
B/M Measure 2	Various 2D or M-Mode measurements Specifies the second 2D or M-Mode measurement to be initiated after the measurement associated with the Measure 1 attribute is completed.
B/M Measure 3	Various 2D or M-Mode measurements Specifies the third 2D or M-Mode measurement to be initiated after the measurement associated with the Measure 2 attribute is completed.
Double Print - Meas	<ul style="list-style-type: none"> <li>• On - If an Image Store / Print (e.g. P1 key) is performed on an image with measurements, the image is stored / printed two times, once with the measurements and once without.</li> <li>• Off - No special Store / Print behavior.</li> </ul>
Double Print - Color	<ul style="list-style-type: none"> <li>• On - If an Image Store / Print (e.g. P1 key) is performed on an image with color, the image is stored / printed two times, once with color and once without. If double print on color and double print on measurements are both configured to be on, the image is stored / printed two times, once with the measurements and once without.</li> <li>• Off - No special Store / Print behavior.</li> </ul>
View Worksheet	<ul style="list-style-type: none"> <li>• On - The worksheet is turned on</li> <li>• Off - The worksheet is not turned on</li> </ul>

### Measurements

Because there are many measurements available on the LOGIQ Totus and because the measurement package is highly customizable, there is some special handling for measurements. The Measurement attributes affected by this special handling are Measure 1-3 and Vessel.

#### Selecting a Measurement Package

The Measurement selection menu can be used to specify which measurement package is to be used for the Program. The Measurements packages are organized by category and subcategory. The choices for the Measure 1-3 and Vessel attributes are limited by the selection of category and subcategory. To select a subcategory, select a category, move to the subcategory list and select a subcategory. To select all subcategories for a given category, select the category and then reselect the Measurements menu item to remove the menu.

A single Program is not allowed to have measurements from multiple categories, but it may have measurements from multiple subcategories.



Figure 13-170. Measurements Menu

## **User-Defined Measurements**

User-defined subcategories and individual measurements can be used with the Scan Assistant feature. To do so, the Scan Assistant Creator needs to know about the user-defined measurements on the LOGIQ Totus.

On the LOGIQ Totus, use the Scan Assistant utility menu to Export Programs to a USB storage device. On the export menu, check the "Export user config data" checkbox to store the user-defined measurement information to the Program User Directory on the media. The name of the file is UserConfigSystemFile.res. When this file exists in the Program User Directory, then it is used. Otherwise, the default file installed with the Scan Assistant Creator is used.

## Rule Checking

Scan Assistant Creator allows Programs to be checked. During a rule check, Scan Assistant Creator applies a series of rules against the Program being checked and reports any inconsistencies between the rules and the Program. This rule check is intended to find potential issues in the Program before it is tested on a LOGIQ Totus. Issues found when running the check do not mean the Program is unusable. It means that if there happens to be a problem with running the Program, the first place to look would be at the Issue noted when you ran the Check.

For example, if there is a step name Right Kidney and the Measurement Location is set to "Left", the rule check would report this inconsistency.

### Running a Rule Check

The "Check" button below the Program area is used to initiate a rule check. The results are displayed in the Rule Check Results window to the right of the button. A rule check is also initiated when attempting to save a Program that has not previously passed a rule check.



Figure 13-171. Rule Check Button and Rule Check Results

## **Rule Check Results**

If the issue is specific to a particular step, double-clicking on the issue number in the Rule Check Results window selects the step associated with the issue. The results are intended to be potential issues and therefore may be ignored at the discretion of the user. For example, the rule check may report that there are an unequal number of left and right steps. For a particular Program, this may be the expected result. If a change is made in response to the rule check results, a new rule check can be run to see if the issue has been resolved.

# Compare Assistant

## Overview

Compare Assistant allows you to perform serial scans on a patient when you can compare the images from a patient's previous exam(s) to the patient's current exam.

*NOTE: In order to reload imaging parameters from a previous exam, the image must have been stored as raw data.*

*NOTE: Side-by-side scanning comparison is present whether or not you are able to import the scanning parameters.*

In Comparison Mode the system can automatically reload scanning parameters from a previous exam performed on a LOGIQ Totus archived as raw data and allow for side-by-side scanning for image comparison. This allows you to use consistent scanning parameters from exam to exam on the same patient and may assist in assessing the progress of the patient.

Compare Assistant is available in B-Mode, Harmonics, Contrast, and in Color Flow and Power Doppler Imaging Modes.

In B-Mode the following parameters can be transferred from the Compared Image to the Active B-Mode Image: Gain, Depth, Frequency, CrossXBeam, Virtual Convex (linear probes), SRI, Frame Averaging, Map, Dynamic Range, Acoustic Output, Harmonic state, Focal Zone Number and Position, Width, and Line Density.

In Color Flow/PDI Mode the following parameters can be transferred from the Compared Image to the Active Color Flow/PDI Mode image: Gain, ROI Size/Position, Frequency, Frame Averaging, Packet Size, Flow Model, Scale (PRF), Wall Filter, Spatial Filter, Acoustic Output, Invert, Threshold, Sample Volume, Color Map, Virtual Convex (linear probes), and Line Density.

## Overview (continued)

Image parameter copy is supported for the following additional modes: Contrast (supports depth, focal zone position, acoustic output, and frequency), Elasto (supports ROI size, ROI position, frequency, and scale), and B-Flow (supports depth, frequency, focal zones, and sensitivity).

Annotations and Body Patterns can also be transferred from a patient's previous exam to the patient's current active exam.

Up to four (4) exams, three (3) other exams and the current active exam, can be compared. Each exam is displayed on the bottom of the display, with Tabs indicating each exam. Tabs are shown in chronological order with the most recent exam displayed on the left.

Compare Assistant is not supported with V Nav, 3D/4D, Quantitative Analysis, Stress Echo, or LOGIQView.

Only measurements taken during the active exam are transferred to the current exam's Worksheet; previous exam measurement information is not included on active worksheets.

In order to utilize the Compare Assistant tool, images should have RawDICOM data. The RawDICOM data is saved locally when available. Some scanning modes do not provide raw data. If the raw data associated with the comparison image cannot be displayed in dual image format, the DICOM image data is used to display the image. RawDICOM data is typically removed when images are sent to PACS; therefore, images that are loaded using Query/Retrieve will likely be standard DICOM only.

**NOTE:** *Images from some other 'unsupported' modes (PW Mode, CW Mode, and M-Mode) can be recalled in Compare Assistant, but the tool will not attempt to copy over imaging parameters unless it is one of the types listed above (it will still attempt annotation copy). Imaging parameter copy will also not be attempted unless the current probe is the same as the probe used to capture the original image and RawDICOM data for the original image is available.*

### Workflow example

**NOTE:** If you use DICOM images for comparison, check the "Compare" checkbox on the DICOM Image folder and press Compare on the Image History page.

1. Place the cursor on the Compare Assistant icon and press **Set** to activate Compare Assistant.
2. Place the cursor on the date tab of the desired comparison exam and press **Set**.
3. Place the cursor on the desired comparison image and press **Set**.
4. Start scan and freeze the image at the same position to make a comparison.

Use Copy Setting Icon as necessary. Comparison Image parameters transfer to the Active Image based on your preset (automatic or manual)

5. Place the cursor on the Compare Assistant icon and press **Set** to deactivate Compare Assistant.



Figure 13-172. Compare Assistant Screen (example)

1. Active Image
2. Comparison Image
3. Active Exam clipboard
4. Date tab of comparison exam
5. Comparison exam clipboard



## Setting Up Compare Assistant

Compare Assistant allows you to set the following parameters:

- Side to place the compared image (left/right)
- Date settings for the compared image
- Imaging and Annotation parameters to be copied from the patient's Compared to the Current image
- Clipboard, Active Image, and Image History Label Layout and Color

You can set these parameters on the System Imaging page via Utility--> System--> System Imaging.



Figure 13-173. Setting Up Compare Assistant Parameters

Table 13-70: Compare Assistant Parameters

Parameter	Settings
Comparison Image Side	<ul style="list-style-type: none"> <li>• Left</li> <li>• Right (Default)</li> </ul>
Comparison Image Date	<ul style="list-style-type: none"> <li>• All Dates (Default): The date is always displayed on the comparison image.</li> <li>• Different Date: Date only displayed when the date of the comparison image is different than the active exam date.</li> <li>• None: No comparison image date is displayed.</li> </ul>

Table 13-70: Compare Assistant Parameters

Parameter	Settings
Copying Settings	<p>You can set the default Compare settings on the System Imaging Utility page or you can select the Compare setting via the On-screen controls. Comparison Image parameters transfer to the Active Image based on your preset (automatic or manual).</p> <p><b>Automatic Settings</b> are copied from the Comparison Image to the current image as soon as the comparison image is loaded.</p> <ul style="list-style-type: none"> <li>• <b>Automatic: Imaging &amp; Annotations</b> (Default): Imaging Parameters, Annotations, and Body Patterns copied</li> <li>• <b>Automatic: Imaging Only:</b> Only Imaging Parameters copied</li> <li>• <b>Automatic: Annotation Only:</b> Only Annotations and Body Patterns copied</li> </ul> <p><b>Manual Settings</b> are copied from the Comparison Image to the current image when you manually select the control.</p> <ul style="list-style-type: none"> <li>• <b>Manual: Imaging &amp; Annotations:</b> (Default) Imaging parameters, Annotations, and Body Patterns copied</li> <li>• <b>Manual: Imaging Only:</b> Only Imaging Parameters copied</li> <li>• <b>Manual: Annotations Only:</b> Only Annotations and Body Patterns copied</li> </ul> <p><b>Off:</b> No parameters copied.</p>
<p>Note: Copy settings are restored to the default whenever Compare Assistant is turned on and the active exam or current patient has changed since the last time it was on.</p>	
<p><b>Image Label Layout:</b> Clipboard Active Images Image History</p>	<ul style="list-style-type: none"> <li>• No Label</li> <li>• 1-Line Label (Default)</li> <li>• 2-Line Label</li> </ul>
<p><b>Image Label Color:</b> Clipboard Active Images Image History</p>	<ul style="list-style-type: none"> <li>• Bright/Soft White</li> <li>• Bright/Soft Yellow</li> <li>• Bright/Soft Red</li> <li>• Bright/Soft Orange</li> <li>• Bright/Soft Blue</li> <li>• Bright/Soft Purple</li> </ul>

To set Compare Assistant print parameters, select Utility--> Connectivity--> Button--> Advanced. You can set the system to print the Comparison image only, to store the New Image only; or to store both the Comparison and New Image.

## Compare Assistant Controls













The following controls can be used while in Compare Assistant:

Table 13-71: Compare Assistant Controls

Control	Description
	<ol style="list-style-type: none"> <li>1. Image Display Area Icon</li> <li>2. Worksheet</li> <li>3. Active Image Screen</li> <li>4. Compare Assistant On/Off. Select the Compare Assistant Icon to activate Compare Assistant.</li> <li>5. Copying Settings</li> <li>6. Save As Menu</li> <li>7. Next/Previous Image, or Press [Ctrl]+[Next Image Arrow] to start a Slide Show.</li> </ol>
Keyboard Arrow Keys	You can also use the Arrow Keys on the Keyboard to move to the next/previous clipboard image.
Operator Panel L/R Keys	If comparison mode is on and the single image display is active, to enter dual comparison display press the L (Left) or R (Right) key. If dual comparison display is on and the dual comparison display is active, to enter single image display, press the L (Left) or R (Right) key.
Freeze Key	To deactivate Comparison Mode, select the comparison image side while in Dual Comparison Display and press Freeze.
Print Key	When you store an image while in Dual Comparison Display, the system automatically switches to the active exam side prior to storing the image.

Compare Assistant Controls (continued)

Table 13-72: Compare Assistant icon and Copy Setting icon

	Compare Assistant On. Copy to Right.		Compare Assistant On. Copy to Left.
	Off		Off
	Automatic: Imaging and Annotations		Automatic: Imaging Only
	Automatic: Annotation Only		Manual: Imaging & Annotations
	Manual: Imaging Only		Manual: Annotations Only
	Off. No parameters copied.		Disabled.

**NOTE:** Compare Assistant icon is disabled when the system does not have Compare Assistant Option.

## Comparison Clipboard

In Comparison Mode two (2) image clipboard areas display images from the active exam and the selected comparison exam. The Comparison Clipboard can display up to four (4) exams, including the active exam. Each exam has a tab that you click on to select the desired comparison or active exam. The active exam is always displayed.



Figure 13-174. Comparison Clipboard

The comparison exam(s) are identified by the date of the exam on the tab; the active exam is identified by the word, “Active” and by the asterisk (\*). You can activate the Image History screen by clicking on the “...” tab.

Each image clipboard has its own scroll bar that can be used to scroll through all the images.

The highlighted image in the clipboard is the image that’s displayed along with the exam’s active image.

### Query/Retrieve

You can use DICOM Query/Retrieve to search for a patient's previous exams. When you select a patient on the Patient Screen, select the "Query" button. This automatically registers the patient (if needed) and initiates a query via the Data Transfer page. Select the exams you wish to be transferred and press the "Transfer" button.

After the retrieve completes, the system automatically returns to the Patient Screen with the same patient and exam active as when you selected to Query this patient.

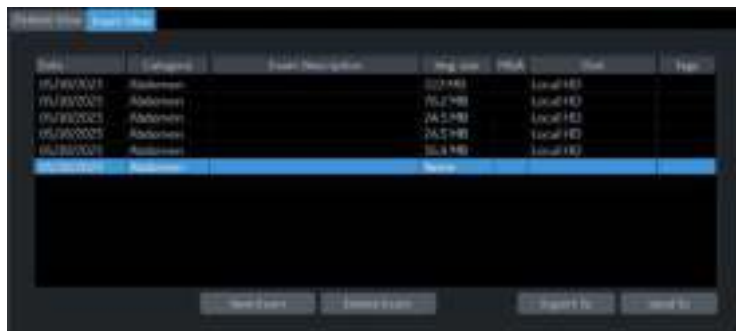

Figure 13-175. Patient Exam View

You can also push the data from the PACS device to the system.

## Activating Compare Assistant

Compare Assistant displays an image associated with the active exam (live, frozen, or CINE) and the other side contains an image from the comparison exam.

Comparison Image parameters transfer to the Active Image based on your preset (automatic or manual). You can also use the Display Copying control adjacent to the clipboard to copy settings from the comparison image to the active image.

**NOTE:** *If an imaging parameter is not available for the current probe, a message in the status bar indicates that this parameter is not available.*

You activate Compare Assistant via the Comparison Mode Key adjacent to the Image Clipboard and On-screen Trackball Controls or you can activate Compare Assistant via the Patient Image History screen by selecting the image and pressing “Compare.”

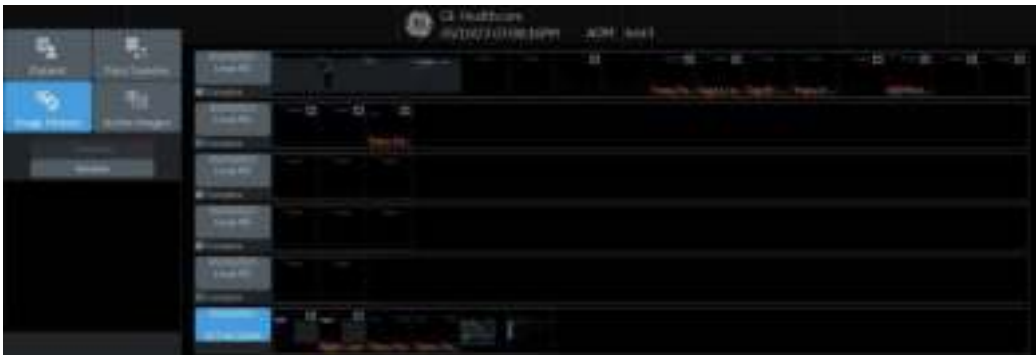

Figure 13-176. Image History

At the start of an exam the system automatically checkmarks the three (3) most recent exams, excluding active exams and exams without any images as the comparison exams. You can adjust this by placing a checkmark next to the exam you wish to include in Compare Mode (the system automatically deselects the oldest checked exam). To activate Comparison Mode, select which specific image you would like to compare to the current image from the clipboard on the Image History screen. Select the image and press the “Compare” button.

## **Exiting Compare Assistant**

To exit Compare Assistant Mode, select the Comparison Mode Key adjacent to the Image Clipboard, or change the exam Application Preset, change active exam, change patient, or recall an image from the active clipboard.



# OB Measure Assistant

## Overview

The user can request the system to trace/outline the borders of specified OB measurements using the OB Measure Assistant feature. You can auto-detect the Biparietal Diameter, Head Circumference, Abdominal Circumference, Femur Length and Humerus Length.

To automatically trace the fetal anatomy on the display,

1. Press **Measure Assist Settings** on the OB Touch Panel to set OB Measure Assistant parameters.

Table 13-73: OB Measure Assistant Touch Panel

Touch Panel Settings	Description
Default	When you first activate the Measure Assistant Touch Panel, the following measurements are highlighted: BPD, HC, AC, and FL. This means that OB Measure Assistant is active for all these measurements.
There are four (4) BPD Auto Custom Settings:	
1. BPD Highlighted	BPD and HC OB Measure Assistant is generated one at a time. BPD is auto generated--> Edit/Set--> HC is auto generated--> Edit/Set--> Done
2. BPD + AutoSet BPD	BPD and HC generated at the same time. BPD and HC are auto generated--> Edit/Set HC--> Edit/Set BPD--> Done.
3. BPD + BPD Only	Only the BPD is auto generated--> Edit/Set--> Done.
4. No Highlight	User must perform these measurements manually

2. Press the measurement (BPD, HC, AC, FL or HL). The trace is auto generated on the display.

### Overview (continued)

3. To edit the selected measurement graphics:
  - Move the Trackball to appropriately size the edit region of interest
  - Edit the Calipers via Cursor Select.
  - Adjust the circumference using the Ellipse key.

Press Set on the Trackball to complete the measurement.

*NOTE:*

*Specify the mode to measure the BPD: Outer to Inner, or Outer to Outer via Utility--> Measure--> Advanced--> Obstetrics--> Measure Assistant BPD Method.*

If the system was not able to detect the anatomy automatically, measurement calipers are displayed in the center of the screen in an editable state and a message is displayed on the status bar.

# Hepatic Assistant

## Overview

Hepatic Assistant is supported on C1-6-D and C1-6VN-D (Abd (Abdomen), AbdPen (Abdomen Penetration) and AbdDetail (Abdomen Detail)) to measure SWE and UGAP simultaneously.

See 'Shear Wave Elastography' on *page 13-111* and 'Ultrasound-Guided Attenuation Parameter (UGAP) Option' on *page 13-141* for detailed workflows.

## Activate Hepatic Assistant

1. Configure presets for Hepatic Assistant in Utility > Imaging > UGAP > Abdomen/Abdomen Pen/Abdomen Detail - C1-6 (Hepatic Assistant), as needed.
  - **Visualization:**
    - UGAP/SWE (A/E)
    - UGAP Q/SWE (A Qual./E)
    - B/SWE & UGAP/UGAP A (BE -> A/Att.)
    - SWE Q/SWE & UGAP Q/UGAP (E Qual./E -> A/Qual.)
    - SWE Q/SWE & UGAP Q/UGAP (Qual./E -> Qual./Att.)
  - **SWE Display Side:** Right or Left.
  - **Frames to store:** UGAP frames to store for Auto Measurement Multi can be configured in increments of 10 from 0 to 300 (0, 10, 20, etc.).
  - **UGAP ROI Display in PreMode:** On or Off.
  - **Pause before beginning UGAP acquisition:** The Pause functionality can be selected On or Off on the Touch panel prior to entering UGAP when using Multi-Measurement configuration.



Figure 13-177. Presets for Hepatic Assistant

2. Assign Hepatic Assistant to any User Defined key in Utility -> System -> User Configurable key. Press **Save**.
3. Select C16-D/C1-6-VN-D probe and Abd, AbdPen or AbdDetail for application.

## Activate Hepatic Assistant (continued)

4. Press assigned User Defined key. Pre Mode is displayed.

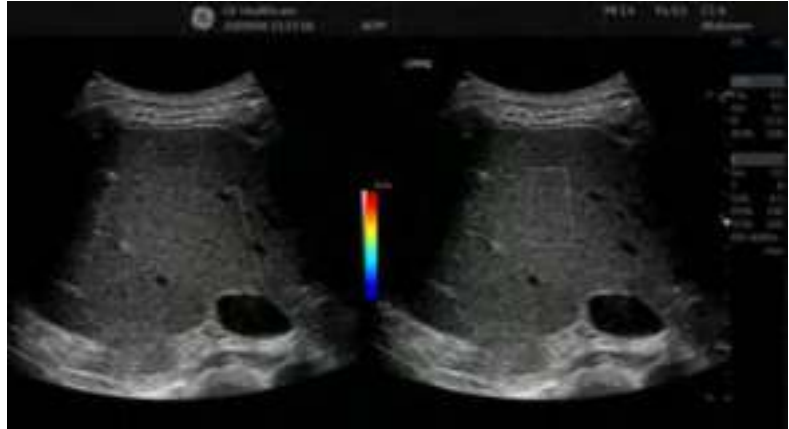

Figure 13-178. Pre Mode

5. Move SWE ROI to desired position, if needed.
6. Press **Start** to begin SWE and UGAP live data acquisition. The UGAP measurement is activated when the SWE measurement is completed.
  - The LOGIQ Totus acquires one SWE frame data and one UGAP frame data for Auto Measurement Single.
  - The LOGIQ Totus acquires SWE frames data until the user presses **Freeze**, and the specified number of UGAP data frames for Auto Measurement Multi.
  - The LOGIQ Totus acquires SWE data frames until the user presses **Freeze**, and UGAP data frames until the user presses **Store** (when Auto Measurement is set to Off).
7. Press assigned User Defined Key to exit Hepatic Assistant.

## Visualization

The below Visualizations are selectable in Utility.

- Dual view of UGAP and SWE

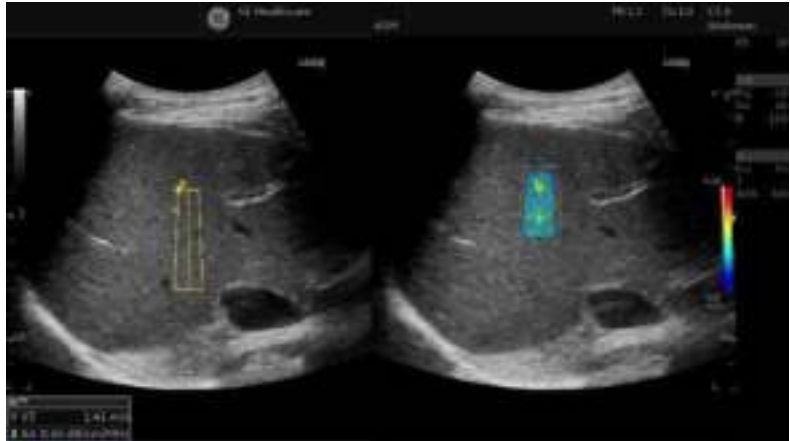

Figure 13-179. Example - UGAP/SWE (A/E)

- Dual view of UGAP Quality Map and SWE

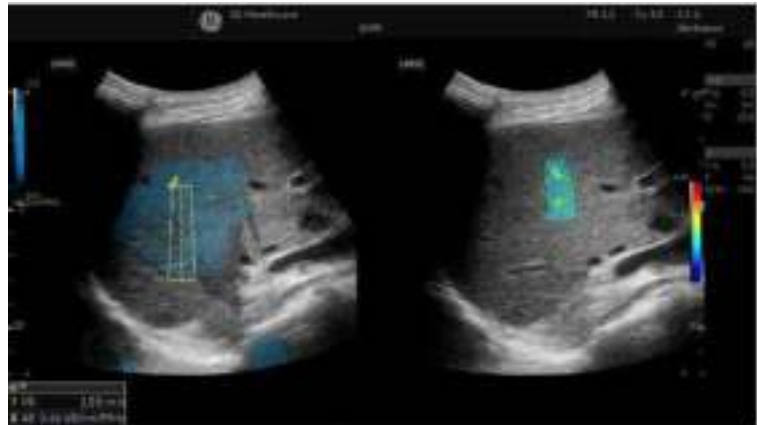

Figure 13-180. Example - UGAP Q/SWE (A Qual./E)

**Visualization (continued)**

- Dual view of B-Mode and SWE to UGAP and UGAP Attenuation Map

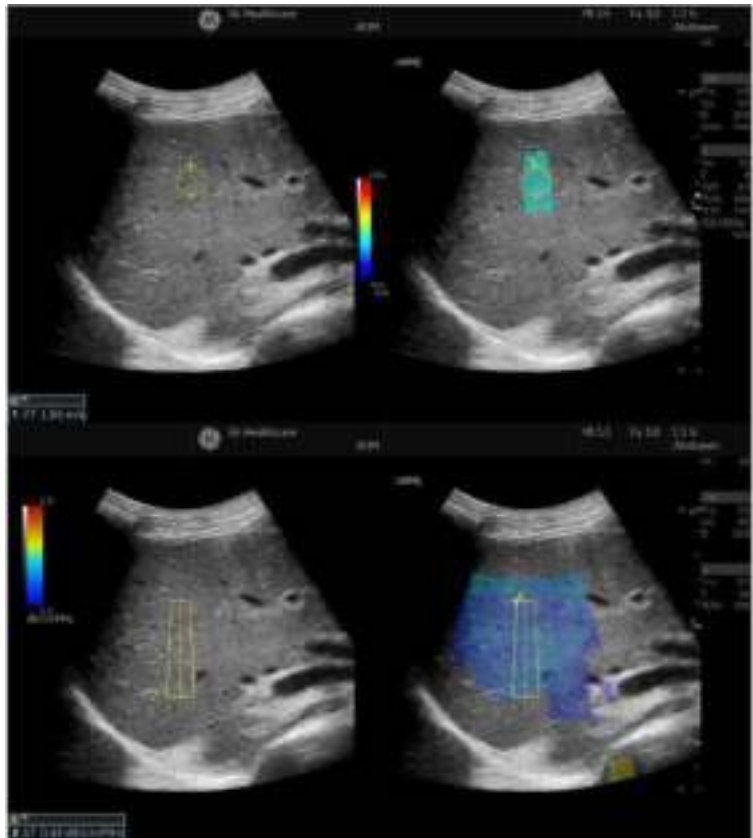

Figure 13-181. Example - B/SWE & UGAP/UGAP A (B/E " A/ Att.)

Visualization (continued)

- Dual view of SWE Quality Map and SWE and dual view of UGAP Quality Map and UGAP

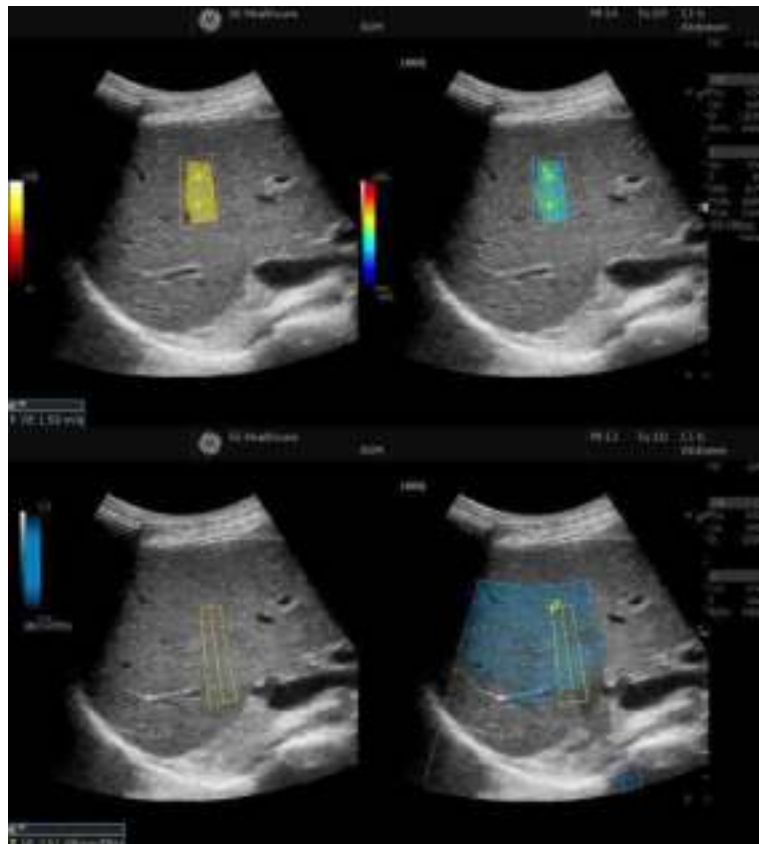

Figure 13-182. Example - SWE Q/SWE & UGAP Q/UGAP (E Qual./E " A/Qual.)



Visualization (continued)

Dual view of SWE Quality Map and SWE to UGAP Quality Map and UGAP Attenuation Map

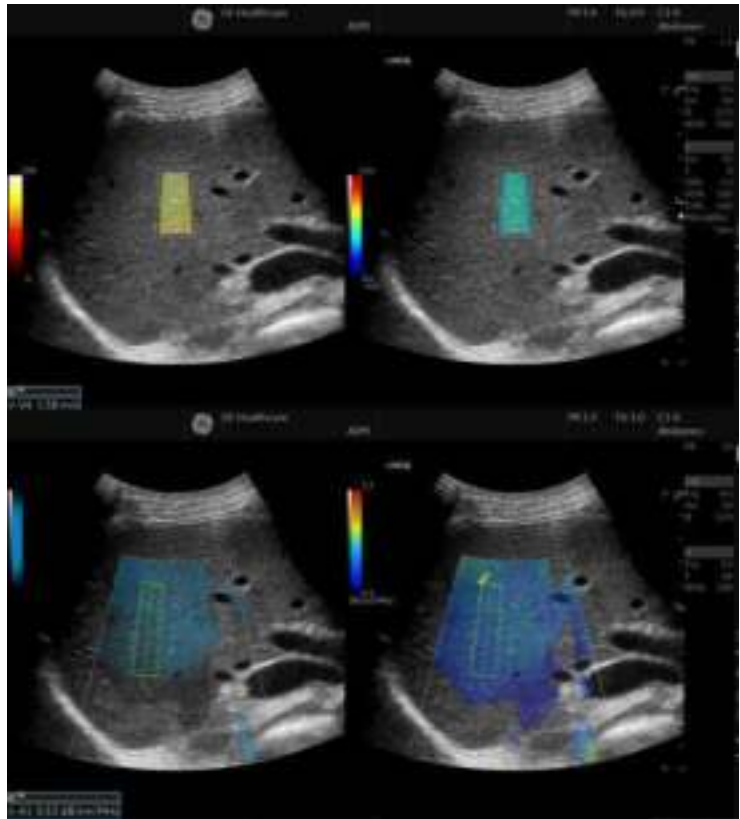

Figure 13-183. Example - SWE Q/SWE & UGAP Q/UGAP (Qual./E -> Qual./Att.)

# Vscan Air™ CL (Option)

## Overview

LOGIQ supports Vscan Air™, - The Vscan Air is a battery-operated, wireless, general-purpose diagnostic handheld ultrasound imaging system which consists of a dual-headed probe. More information about the Vscan Air CL, care and handling, can be found in the Vscan Air™, User Manual on the GE HealthCare Customer Documentation Portal website at: <http://gehealthcare.com/usermanual>

The Vscan Air CL acquires and forms the ultrasound image, sends the image data in real time through Wi-Fi to the ultrasound system, and the console displays the image. LOGIQ console provides the needed software to use the console as the display and the UI control unit.



Figure 13-184. Vscan Air and Ultrasound System as Display and User Interface

The Vscan Air CL probe supports B mode and Color flow mode. Currently, PW and M mode are not supported on LOGIQ systems

Table 13-74: Clinical Applications - Additional Capabilities and Features

	<b>Clinical Applications</b>	<b>Additional Capabilities and Features</b>
Curved probe	<ul style="list-style-type: none"> <li>• Abdomen (incl.Pleural)</li> <li>• OB/GYN</li> <li>• Pediatric</li> <li>• Peripheral Vascular</li> <li>• Musculoskeletal</li> </ul>	Overwrite and create application presets Retain FOV Easy3D LOGIQ View LOGIQ Apps ATO (B Mode) Auto Doppler (Colorflow Mode - Linear) Rawdata (B & CF) Scan Assistant Compare Assistant Measurement Package (by application) Annotation package (by application) Body Pattern (by application) Imaging controls on Utility page Imaging display (dual/quad, B CF simultaneous) Print / Recall / change order  Patient page/Exam Category
Linear probe	<ul style="list-style-type: none"> <li>• Abdomen (incl.Pleural)</li> <li>• OB/GYN</li> <li>• Small Parts</li> <li>• Pediatric</li> <li>• Peripheral Vascular</li> <li>• Musculoskeletal</li> </ul>	

### Prepare the Vscan Air CL Probe for Use



CAUTION

The ultrasound system with Vscan Air CL is not intended for ophthalmic use or any use causing the acoustic beam to pass through the eye.



CAUTION

Only use GE HealthCare provided chargers or a Qi compliant charger with the Vscan Air CL probe. Failure to use a compliant charger may result in the probe not charging, or possible damage to the probe.



CAUTION

Scanning stops within 10 seconds if the Wi-Fi link to the Vscan Air CL probe is lost. Ensure the Wi-Fi connection is sufficient to avoid loss of image and delay of care.



CAUTION

The probe will not begin a scan if the Vscan Air CL probe battery is critically low. Ensure probe is sufficiently charged before beginning scan to avoid delay of care.



CAUTION

Scanning stops within 10 seconds when the Vscan Air CL probe battery becomes critically low. Ensure probe is sufficiently charged before beginning scan to avoid delay of care.

**NOTE:** *Ensure only one Vscan Air CL is around the console. The ultrasound system will try to pair with the VScan Air CL with strongest signal.*

**NOTE:** *To guarantee the maximum performance with Vscan Air CL on the ultrasound system, check the environment and avoid other Wi-Fi devices.*

**NOTE:** *Make sure the ultrasound system is connected to an access point (if needed) BEFORE pairing with Vscan Air CL. Connecting to an access point after pairing with Vscan Air CL will result in significant performance degradation.*

**NOTE:** *Connect to the network infrastructure through an ethernet connection, if possible, to avoid any possible Wi-Fi interference.*

**NOTE:** *The VScan Air CL must be activated from a mobile (Android, iOS) device first through the Vscan Air app. The ultrasound system does not provide a workflow for activating a new VScan Air CL.*

## Vscan Air CL Probe Charger



### CAUTION

The Vscan Air CL probe charger must ONLY be used to charge the Vscan Air CL probe. DO NOT charge a mobile phone or any other device with the Vscan Air CL probe charger. Failure to follow these instructions may damage the charger or other device.

## FCC Statement

This device complies with Part 15 of the FCC Rules. Operation is subject to the following two conditions: (1) This device may not cause harmful interference, and (2) this device must accept any interference received, including interference that may cause undesired operation.



### WARNING

Changes or modifications not expressly approved by the party responsible for compliance could void the user's authority to operate the equipment.

**NOTE:** *This equipment has been tested and found to comply with the limits for a Class B digital device, pursuant to Part 15 of the FCC Rules. These limits are designed to provide reasonable protection against harmful interference in a residential installation.*

This equipment generates, uses, and can radiate radio frequency energy and, if not installed and used in accordance with the instructions, may cause harmful interference to radio communications. However, there is no guarantee that interference will not occur in a particular installation. If this equipment does cause harmful interference to radio or television reception, which can be determined by turning the equipment off and on, the user is encouraged to try to correct the interference by one or more of the following measures: (1) Reorient or relocate the receiving antenna. (2) Increase the separation between the equipment and receiver. (3) Connect the equipment into an outlet on a circuit different from that to which the receiver is connected. (4) Consult the dealer or an experienced radio / TV technician for help.

### Radiation Exposure Statement

This equipment complies with FCC radiation exposure limits set forth for an uncontrolled environment. This equipment should be installed and operated with minimum distance of 20cm between the radiator and your body.

### IC Statement

This device complies with RSS-216 of Industry Canada. Operation is subject to the condition that this device does not cause harmful interference.

This device contains license-exempt transmitter(s)/receiver(s) that comply with Innovation, Science and Economic Development Canada's license-exempt RSS(s). Operation is subject to the following two conditions:

- (1) This device may not cause interference.
- (2) Any changes or modifications not expressly approved by the party responsible for compliance could void the user's authority to operate the equipment.

**RF exposure statement:** The equipment complies with IC Radiation exposure limit set forth for uncontrolled environment. This equipment should be installed and operated with minimum distance 20cm between the radiator and your body.

## Install the Vscan Air CL Probe Charger

1. Install the probe holder onto the probe charger by sliding down until it latches into place.



Figure 13-185. Install Probe Holder on Charger

2. Select the probe holder location on the system to install the charger assembly and insert the probe charger post through the holder location.
3. Thread the nut onto the bottom end of the charger mounting post and tighten the nut by hand until the charger is secured firmly to the system.
4. Connect the USB charging cable to a USB port under the control panel.



Figure 13-186. LOGIQ Totus USB Ports with Vscan Air CL Probe charger Installed

5. Place the Vscan Air CL probe into the charger to begin charging.

## Charge the Vscan Air CL Probe

To charge the Vscan Air CL probe, place the probe inside of the plastic probe holder on the probe charger.

Table 13-75: Vscan Air CL Battery Charger LED Charging Status Indicator

LED Color	Charging Status
Blue	Charger initially plugged in - no probe on charger.
Blinking Green	Probe battery charging.
Blinking Green and Static Blue	Probe battery fully charged - probe on charger.
Blue	No probe on charger.
Orange	Charging failure. Probe battery not full, charging paused.



## Pair Vscan Air CL to the Ultrasound System

To pair the Vscan Air CL to the ultrasound system:

1. Turn the ultrasound system on.
2. Press and hold the Vscan Air CL power button for approximately two seconds, while watching the probe LED lights.

**NOTE:** *Do not continuously hold the button for longer than 5 seconds, or the probe will shut down after booting up.*

The LED lights will first briefly display the battery level (green, yellow, or orange), then the display power up (two blue lights). Release the Vscan Air CL power button when you see the power up light.

3. Touch the first probe connector (Vscan Air CL shares the probe port menu with the CW-only probe) to start the pairing process.
4. The LED lights will enter the booting up state (two white lights blinking alternately), followed by the searching state (two white lights blinking synchronously). Tap the power button to allow connection during searching state.

### Pair Vscan Air CL to the Ultrasound System (continued)

5. Pairing will take 5-30 seconds to complete. When pairing is complete, the two LED lights will shine steady blue, indicating the connection is established. At the same time, the Vscan Air CL probe icon will appear on the ultrasound system Touch Panel



Figure 13-187. Vscan Air CL Touch Panel Icon







Figure 13-188. Vscan Air CL Battery and Wi-Fi Icons

1. Battery Level
2. Wi-Fi Signal Strength

## Vscan Air CL Battery Indicator

Table 13-76: Vscan Air CL Battery Indicator

Icon	Description
	Battery charged 90-100%
	Battery charged 60-80%
	Battery charged 40-60%
	Battery charged 20-40%
	Battery charged <20 - prepare to recharge the a batter.

## Wireless Connection Quality Indicator

A wireless probe has a limited inherent risk of a disrupted connection due to various factors that could lead to loss of real time imaging. The 'Wireless Connection Quality Indicator' provides a visual indication of the connection quality between the probe and the ultrasound system during scanning. An unstable connection may result in loss of image quality or slow image update during real time imaging.



Figure 13-189. Wi-Fi Connection Quality Indicator Icons - Left: Compromised, Right: Good

### Vscan Air CL Temperature Indicator and Thermal Management

When the Vscan Air CL operating temperature is increased, the thermal management system inside the probe may automatically decrease frame rates and/or reduce image width, to keep the probe temperature within optimal functional levels to support continuous scans up to 50 minutes. There are five thermal management levels (0-4). Level 0 is the initial state when starting with a cool probe, and at Level 4 the probe temperature reaches the maximal allowed level. At Level 4 a user notification will appear on screen and the probe will automatically shut down.

The 'Probe temperature indicator' tracks and displays changes in the operating temperature of the probe during scanning. Factors affecting probe temperature are:

- **Transducer:** The curved array transducer gets warm more quickly than linear array due to higher power consumption.
- **Preset:** Certain presets like Abdominal and Cardiac have higher power requirements, depending on the image settings, causing the probe to warm up faster than other presets.
- **Mode:** Operating in Color Flow mode warms up the probe faster than Black and white mode.
- **Length of scan:** The duration of continuous scanning.
- **Ambient temperature:** Higher ambient temperatures can cause the probe to warm faster.

**NOTE:** *The probe temperature and related user notifications are independent of the probe battery status.*



Figure 13-190. Thermal Status Icons - Level 0 to 4

## Scanning

To begin scanning with the Vscan Air CL:

1. Select the Vscan Air CL probe icon on the Touch panel.



Figure 13-191. Vscan Air CL Touch Panel Icon

2. Select the Curved or Linear tab on the Touch Panel.

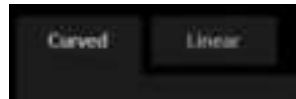

Figure 13-192. Vscan Air CL Curved and Linear Applications



Figure 13-193. Vscan Air CL Curved and Linear Applications

3. Select a preset on the Touch Panel. The Vscan Air CL probe begins scanning and the system displays the images.

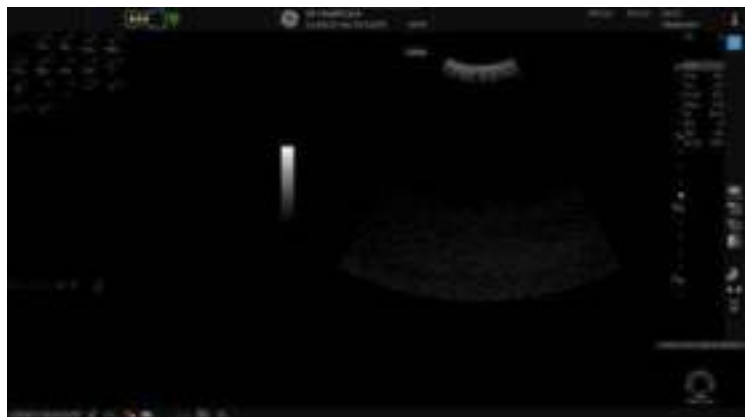

Figure 13-194. Vscan Air CL Image Display on Ultrasound System



### HINTS

The power button on the Vscan Air CL probe can be configured as a Freeze/Unfreeze button during scanning.

**Preparing for a Guided Procedure with Vscan Air CL**

A wireless probe has a limited inherent risk of a disrupted connection due to various factors that could lead to loss of real time imaging.



**WARNING**

If a temporary, unexpected disruption to real time imaging is determined to have a severely negative adverse effect on the patient's health, outweighing the benefits of using an ergonomic wireless probe at the point of care, it is recommended to consider using a wired ultrasound device for the specific procedure guidance.



**CAUTION**

When performing a guided procedure or a freehand biopsy (without a biopsy guide), it is the user's responsibility to use the appropriate equipment. Ensure that the needle (especially the needle tip) is always visible in the ultrasound image during the entire procedure.



**CAUTION**

Always use only B-Mode when performing guided procedures or a freehand biopsy.

### **Prepare Vscan Air CL probe and check Wi-Fi connection prior to a procedure**

Prior to setting up for a guided procedure, it is recommended to prepare the Vscan Air CL probe to be in optimal condition, and if assess if a stable Wi-Fi connection can be maintained during the procedure. Follow the below steps for the assessment.

### **Use a Cool Probe**

Ensure the probe is sufficiently cooled down after any previous scanning. Disruption or reduced scan quality may occur due to the probe overheating if a lengthy procedure is anticipated. Leaving the probe on a desk (outside the pocket or the case) after it is powered off will cool it down faster. It should take approximately 30-60 minutes to get to a reasonably cool state, depending upon how warm it was from the previous scan, and the ambient temperature. If accelerated cooling of the probe is required, place the probe, while turned off, in front of a fan, run under cold water, or apply a cooling pack.

### **Ensure the Probe is Sufficiently Charged**

Ensure the probe battery is sufficiently charged before beginning a procedure. Battery levels of 50% and above are recommended before starting. The battery level of the probe can be checked on the top left of the imaging screen after connecting with the system. A green battery icon indicates sufficient battery level.



Figure 13-195. Battery Icon - Fully Charged

### Check Wi-Fi Environment

Whenever possible, check the Wi-Fi connection between the probe and ultrasound system in the environment where the procedure is expected to be performed. This will help detect any unexpected challenges before the actual procedure.

Select Small Parts from the Linear presets menu (Small Parts is the most Wi-Fi-challenging preset due to its high image data rate) and turn up the B-Mode gain. Ensure that the connection quality indicator is steadily green on the imaging screen. Observe the noise pattern, and the random movement of noisy pixels should not appear to pause occasionally.



Figure 13-196. Wi-Fi Icon

The probe temperature indicator is also visible on the right upper corner of the image screen. A gray colored thermometer icon confirms a cool probe.



Figure 13-197. Probe Temperature Indicator



### Disconnect the Vscan Air CL Probe

To disconnect the Vscan Air CL probe from the ultrasound system, simply turn off the probe by pressing and holding the power button until the LED lights appear purple, which indicates the probe is powering down.

You can also shut down the Vscan Air CL probe by selecting the Vscan Air power button on the Touch Panel, or by selecting the battery icon on the title bar and selecting Yes in the Vscan Air Battery Icon dialog box.



Figure 13-198. Vscan Air Power Button



Figure 13-199. Vscan Air Battery Icon Dialog Box

### Supported Features

Most features on the ultrasound system (measurement, annotation, image tag, etc.) are supported on the Vscan Air CL probe.

Table 13-77: Features Available on the Vscan Air

Feature Name
Scan Mode: B Mode
Scan Mode: CF Mode
Overwrite and create application presets
Retain FOV
Easy3D
LOGIQ View
LOGIQ Apps
ATO (B Mode)
Auto Doppler (Colorflow Mode - Linear)
Rawdata (B & CF)
Scan Assistant
Compare Assistant
Measurement Package (by application)
Annotation package (by application)
Body Pattern (by application)
Imaging controls on Utility page
Imaging display (dual/quad, B CF simultaneous)
Print / Recall / change order
Patient page/Exam Category

## Charger Cleaning and Disinfection

For approved charger cleaners and disinfectants, refer to "Cleaning and Disinfecting the System" in Chapter 12 "User Maintenance" of this manual.



CAUTION

Avoid using ALCOHOL (ISOPROPANOL) 70% on the Vscan Air probe holder and charger. ALCOHOL (ISOPROPANOL) 70% may compromise the durability of the probe holder and charger.



CAUTION

To prevent cross-contamination, clean and disinfect the Vscan Air probe holder and charger after every exam.

To clean and disinfect the Vscan Air probe holder and charger:

1. Remove the Vscan Air probe from the charger probe holder and place in a safe location.
2. Remove the clear probe holder from the charger.



Figure 13-200. Remove Vscan Air Probe Holder

3. Clean the probe holder and the charger with an approved cleaning agent.
4. Disinfect the probe holder and the charger with an approved disinfectant; allow to dry for the manufacturer's recommended contact time.
5. Reassemble the probe holder on the charger.

Regulatory Requirements



CAUTION

The Qi compliant wireless charger supplied as an accessory with the product is verified for use with the Vscan Air CL probe. The wireless charger is considered to be information technology equipment that does not affect the basic safety or essential performance of the Vscan Air CL product. The wireless charger is compliant to the IEC/EN 62368-1 standard, which applies to audio/video, information and communication technology equipment.



CAUTION

To prevent cross-contamination, clean and disinfect the Vscan Air probe holder and charger after every exam.

The Vscan Air CL probe complies with regulatory requirements of the European Directive 93/42/EEC concerning medical devices.

**NOTE:** *Regulatory information regarding the Vscan Air can be found from Utility > Admin > Vscan Air.*

**NOTE:** *All applications may not be supported with the different variations of the Vscan Air (e.g. Vscan Air SL - Sector/Linear). Check which VScan Air products are supported from Utility > Admin > Vscan Air.*

Vscan Air On Console Charger Rating Plate



Figure 13-201. Vscan Air CL Charger Rating Plates

**Acoustic Output Reporting Tables for Track 3/EN/IEC 60601-2-37**

The ultrasound system does not control any acoustic output for the Vscan Air CL. For acoustic output reporting tables for the Vscan Air CL, refer to the manual provided by the manufacturer of the Vscan Air CL probe or on <http://gehealthcare.com/usermanual>.

*NOTE: These acoustic output reporting tables are produced according to IEC 62359 Ed.2.*

*NOTE: The Acoustic Output tables are in English only.*

## Overview

EZ Imaging provides an efficient workflow to complete exams with minimal operator button input. EZ Touch Panel allows the operator quick access to change model, flow modes and Doppler modes without searching through multiple pages or many different parameters.

Quick Patient Change allows you to start a new exam without entering the patient page.

## Activate EZ Touch Panel

1. Check **EZ Touch Panel Page** in Utility > System > System Imaging > EZ Settings.
2. Select “By Probe” (Default) or “By Category” for MyPreset Shortcuts.



Figure 13-202. EZ Settings

## Activate EZ Touch Panel (continued)

3. EZ Touch Panel appears on the first page of B, flow and Doppler mode tabs.



Figure 13-203. B-Mode - EZ Touch Panel (Example)

1. MyPreset Shortcuts
  - Change model quickly on the Touch Panel.
2. Image Shortcut
  - Change imaging frequency (Res > Gen > Pen). (Frequencies are not editable.)
3. Essential Control: Virtual Convex (or Max Angle), Advanced SRI
4. MyPreset Shortcut: Last used or current model displays in the 4th position.
5. Essential Control (Configurable) - Configurable essential controls display in the 3rd and 4th positions. A desired control can be assigned in the 3rd and 4th positions.

## Activate EZ Touch Panel (continued)



Figure 13-204. CF/PDI/MVI/TVI - EZ Touch Panel (Example)

1. Flow mode buttons
  - Change Flow Technology quickly on the Touch Panel.
2. Flow Shortcut
  - CF/PDI: Displays available existing shortcuts.
  - MVI/TVI: No shortcut.
3. Essential Control
  - CF/PDI/MVI: Virtual Convex, Invert, Simultaneous
  - TVI: Map Compress and Map
4. Essential Control (Configurable) : Configurable essential controls display in the 4th and 5th position. A desired control can be assigned in the 4th and 5th position.



## Activate EZ Touch Panel (continued)



Figure 13-205. B-Flow - EZ Touch Panel (Example)

1. Flow mode buttons - Change Flow Technology quickly on the Touch Panel.
2. Flow Shortcut - Displays flow shortcut to change Sensitivity/PRI
3. Essential Control - Virtual Convex, Advanced SR
4. Essential Control (Configurable) - Configurable essential controls display in the in the 4th and 5th position. A desired control can be assigned in the 4th and 5th position.

## Activate EZ Touch Panel (continued)

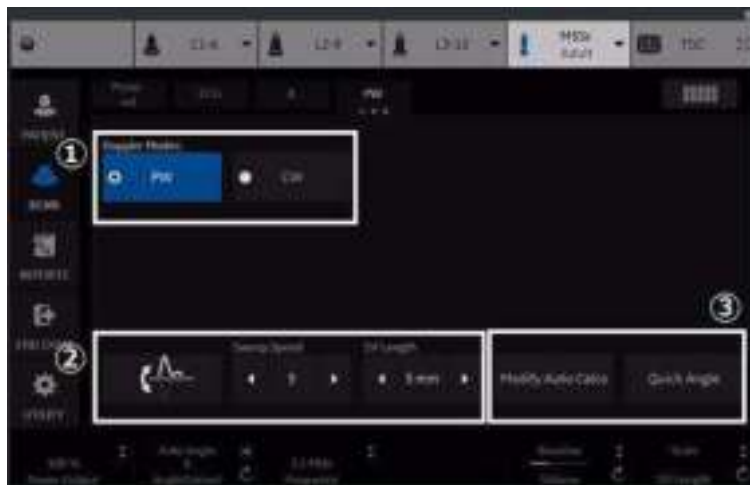

Figure 13-206. Doppler Mode - EZ Touch Panel (Example)

1. Doppler mode buttons - Change Doppler Technology quickly on the Touch Panel (if both PW and CW are supported).
2. Essential Control (Non-Configurable)
  - Invert, Sweep Speed, SV Length (for PW)
  - Wall Filter, Sweep Speed, Colorize (for CW)
3. Essential Control (Configurable) - Configurable essential control displays in the 4th position. You can assign a desired control in the 4th position.

## Activate EZ Touch Panel (continued)

4. Switch to conventional Touch Panel by selecting to turn the Touch Panel page.



Figure 13-207. Switch between EZ Touch Panel and Conventional Touch Panel

## MyPreset Shortcuts “By Probe”



Figure 13-208. By Probe

- TOP 3 models on My Preset for the probe is displayed on the Touch Panel.
- \* (Asterisk) indicates the preset appears on the MyPreset Shortcut.

## MyPreset Shortcuts “By Category”



Figure 13-209. By Category

- TOP 3 models in same exam category on My Preset for the probe is displayed on the Touch Panel.

## Quick Patient Change

1. Complete current patient exam.
2. Press the BT key assigned to Quick Patient Change.
3. All Patient data is stored for the current patient and the Patient ID for the next patient is generated automatically.

**NOTE:** *If you turn off Auto Patient Archive, a Confirmation Dialog for Data Archive appears. Select Store All, Delete All, or Cancel.*



Figure 13-210. Confirmation Dialog for Data Archive

4. An information dialog displays to inform the user that the patient has been created.



Figure 13-211. Information Dialog

5. Start the exam for the new patient. The B-Mode screen displays with the default preset for the connected probe.

# Anonymize the patient

## Overview

The LOGIQ Totus offers an option to extract all measurements and DICOM tags from a selected patient in the Patient List when that patient is not active. This option makes the exam(s) anonymous and attaches this information to a newly created Anonymous Patient.

The LOGIQ Totus warns the user on possible data loss, data mismatch and data that cannot be copied anonymously, including:

- Image data may have patient information burned into the pixel data. This information will not match the updated patient data in the DICOM tags.
- Patient identification on image pixel data which the user annotated. This information cannot be removed.
- Links to Reports will be lost.
- Non-ultrasound exams will not be anonymous.

## Anonymize the patient

1. Ensure that you are logged in as an Administrator on the system.
2. Select the Local Archive dataflow.
3. Select the patient from the Patient View list and left click to bring up the “Anonymize” pop-up menu.
4. A confirmation dialog displays. Select **OK**.
5. The “Anonymize Patient” dialog displays. All the fields inherit the values from the original patient’s exam, except for Patient ID.

Fill in the Patient information fields.

Press **OK** to continue.

**NOTE:** *If the newly entered Patient ID is not unique in the database, the Patient ID turns to red and an error message displays on the status bar.*

- **Empty Other DICOM Tags:** Check to clear all DICOM Tags.
- **Manage DICOM Tags:** Manage DICOM tags dialog displays. Select DICOM tags individually.

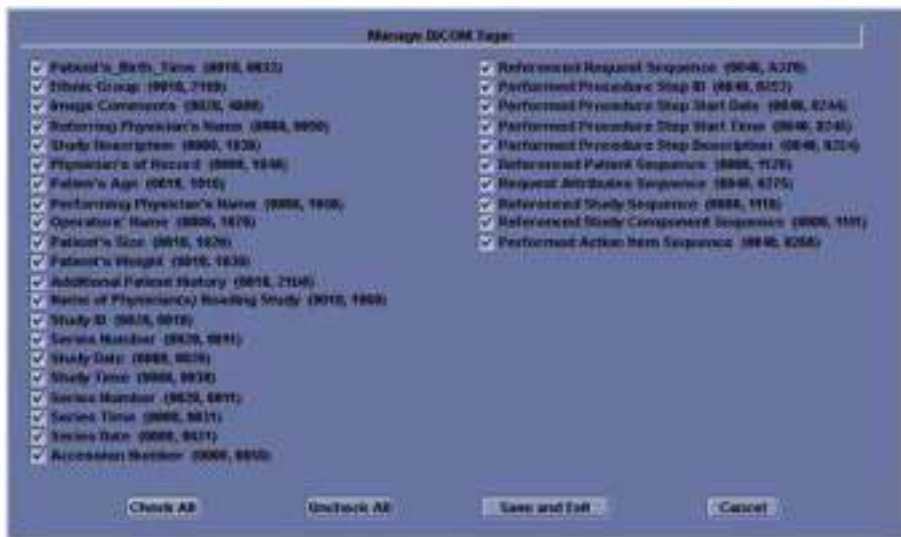

Figure 13-212. Manage DICOM Tags



# Report Writer

## **Introduction**

The LOGIQ Totus enables the generation of patient reports based on the examination performed and the analyses that were made during the exam. The reports are generated using the data stored in the system with pre-selected templates.

You may edit a report while performing the exam; customize, delete, or add measurements; and save changes until you use the Store command. Once Stored, the reports are read-only.

It is recommended that the data be saved often, and then carefully reviewed before the report is Stored. Use the worksheet to facilitate the review and adjust data before storing a report. The final report can be printed on a standard printer.

## Creating a report

Reports summarize the data obtained in the examination. They can contain data, images, and cine loops.

Once generated, the report can be viewed, images can be added, and the patient's personal data can be modified. The examination data itself CANNOT be changed.

The screenshot displays a report interface for GE Medical Systems. At the top left is the GE logo and the text "GE Medical Systems". Below this is a header table with three columns: "Name : GE Test", "Patient ID : 123-4567", and "Date : 07/09/2004". The main body of the report contains six dark, rectangular medical images arranged in a 3x2 grid. At the bottom of the report is a "Comments" section with a text area containing the text "Test exam".

Figure 13-213. Report Example

## Activating the Report

1. Select **Reports** on the Touch Panel.
2. The system displays the default report for the current application on the monitor.

The information entered during the examination is automatically filled in the appropriate fields (e.g. demographic, diagnosis, comments).

The preview image appears when the cursor is over the clipboard image.

**NOTE:** *The template is the skeleton of your report. It is composed of different objects that can be customized by the user.*

3. Adjust the **Page Change** control to move down the page.



Figure 13-214. Report Page Example

## Activating the Report (continued)

Table 13-78: Report Button Controls

Button	Description
Print	Prints out the report to the default printer.
Store	Stores the report page into Archive as CHM* file.
Retrieve	Retrieves the report page from Archive. Stored Date/Time is appended to the name of stored report.
Template	Selects template from the list of selected applications.
Designer	Accesses template editor screen.
Save As	Exports the report page to storage media as CHM or PDF format.
Delete	Deletes the report page from Archive.
Worksheet	Accesses Worksheet Page.
Graph	Accesses OB Graph page (applies only to OB).
Anatomical Page	Accesses Anatomical Survey page (applies only to OB).
*CHM is a compressed HTML help file.	

## Selecting another template

You can select another template for the current patient:

1. Select **TEMPLATE** at the bottom of the monitor display or the Touch Panel.
2. A list of available templates and exam categories (Abdomen, Adult, Carotid, etc.) displays.
3. Select the desired template using the **Trackball/Trackball** and press **Set**.

The selected template displays on the monitor.

**NOTE:** *If you select another exam category, the template list of the selected category displays. Select the desired template.*



Figure 13-215. Available Template list

4. Select the desired template name and press **Set**.
5. The report changes to the selected template.

### Factory Templates

The system has factory templates for each application. You can modify these templates or create user-defined templates. You need to save revised/new templates with unique names.

A template may include one or more of the following:

- Measurements
- Worksheet or Vessel Summary Images
- Anatomical Surveys or Biophysical Profiles
- Anatomical Graphics
- Graphs
- Images areas
- Score Boxes

*NOTE: Additional factory templates can be added from the Utility-->Report menu (OB for multiple gestation, Renal, etc.).*

## Editing a Report

### Entering the hospital address

When using a factory template, the area for the hospital information is usually placed in the upper portion of the report.

To make a new area, see 'Fixed Text' on *page 13-453* for more information.

To modify the factory template:

1. Select **Reports**.
2. Select **Designer**.
3. Double-click on the area for the hospital information in the template. The Fixed Text dialogue box displays.

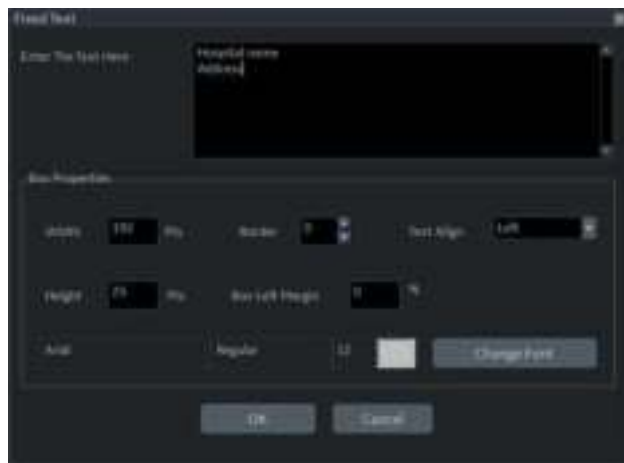

Figure 13-216. Fixed Text Dialogue Box

4. Make changes as necessary.
  - a. Enter the hospital address in the text area.
  - b. Modify Box Properties (box width, box border line width, text align, box height, box left margin, and font).
5. Select **OK**.

### Entering the hospital address (continued)

6. Save the template.

To keep the same template name:

- Select **Save** from the File menu, and press **Set**. The Save Template dialog box opens.
- Select **Yes**. The template retains the same name and appends “[user]”. For example, OB23-Basic[user].

To save the template with a new name:

- Select **Save As** from the File menu, and press **Set**. The Save Template As dialog box opens.
- Enter the name of the new template, and press **Set**. The template receives the new name and appends “[user]”. For example, NewReport[user].

7. Exit the Report Designer. The report with the hospital address displays.



## Inserting the hospital logo

When using a factory template, the area for the logo is usually placed in the upper left portion of the report.

To make a new area, see 'Fixed Text' on page 13-453 for more information.

To modify the factory template:

1. Save the preferred hospital logo in either a jpeg or bmp format on USB.

**NOTE:** *Label the logo with a unique name (e.g. HospitalNameLogo.bmp).*

2. Insert the USB into the USB drive.
3. Select **Reports**.
4. Select **Designer**.
5. Double-click the GE HealthCare Logo so that the frame is highlighted. The logo box displays.



Figure 13-217. Logo Box

### Inserting the hospital logo (continued)

6. Select **Import Logo** (1). Select the USB drive first and then the hospital logo.
7. Select **OK**. The hospital logo displays in the logo list (2). Click the logo to select.

**NOTE:** *Scroll the logo list using the left/right arrow key (3).*

8. Modify Appearance (4).
9. Select **OK**.
10. Save the template.

To keep the same template name:

- Select **Save** from the File menu, and press **Set**. The Save Template dialog box opens.
- Select **Yes**. The template retains the same name and adds “[user]”. For example, OB23-Basic[user].

To save the template with a new name:

- Select **Save As** from the File menu, and press **Set**. The Save Template As dialog box opens.
- Enter the name of the new template, and press **Set**. The template receives the new name and adds “[user]”. For example, NewReport[user].

11. Exit the Report Designer. The template with the hospital logo displays.

**NOTE:** *If a different logo prints on the report, rename the logo image which you want on the report and insert it into the report template again.*

## Changing the Archive Information

When using a factory template, the Archive Information is usually placed below the hospital name and logo.

The contents of the Archive Information is inserted through the related page automatically. If you want to change the description, such as Information or Comments that was entered in the patient menu:

1. Select the yellow text to be changed, e.g. Information or Comments.

The area where the description was entered (e.g. Patient menu) displays.

2. Change the existing data as necessary.
3. Select **Report** to return to the report.



Figure 13-218. Patient Information Area (Example)

### Modifying the displayed objects of Archive Information

1. Select **Designer**.
2. Double click on the area for the Archive Information in the template. The Archive Information Box displays.

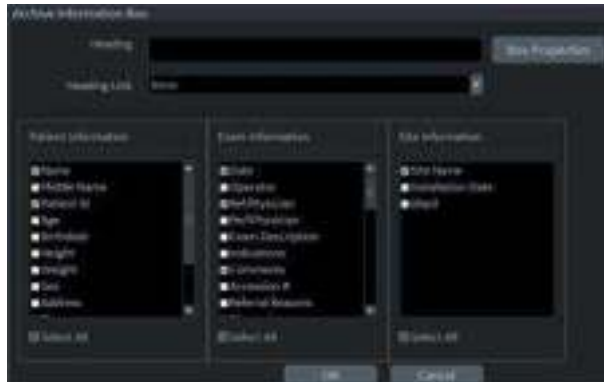

Figure 13-219. Archive Information Box

3. Click the checkboxes to select and deselect the objects. Objects with checkmarks will appear in the report template.
4. Select Box Properties to change the font, font size, font color, or box size, and select **OK**.
5. Select **OK** to return to the Report Designer.

---

## Modifying the displayed objects of Archive Information (continued)

6. Save the template.

To keep the same template name:

- Select **Save** from the File menu, and press **Set**. The Save Template dialog box opens.
- Select **Yes**. The template retains the same name and adds “[user]”. For example, OB23-Basic[user].

To save the template with a new name:

- Select **Save As** from the File menu, and press **Set**. The Save Template As dialog box opens.
- Enter the name of the new template, and press **Set**. The template receives the new name and adds “[user]”. For example, NewReport[user].

7. Select File -> Exit to leave the Report Designer.

## Entering free text

You can enter free text to the report using the alphanumeric keyboard.

The factory template terms their text area as “Summary or Comments”.

1. Move the cursor to the text field and press **Set**.

*NOTE: You can enter the text only to the field set as free text in the Report Designer.*

*NOTE: DO NOT enter “%s” in a free text field and then try to edit/save the template in the Report Designer.*

2. Type the text.

## Inserting Text

1. Select **Designer**.
2. Move the cursor where the text is to be inserted and press **Set**.
3. Select the Text Field from the Insert menu. The Text Field dialog box displays.

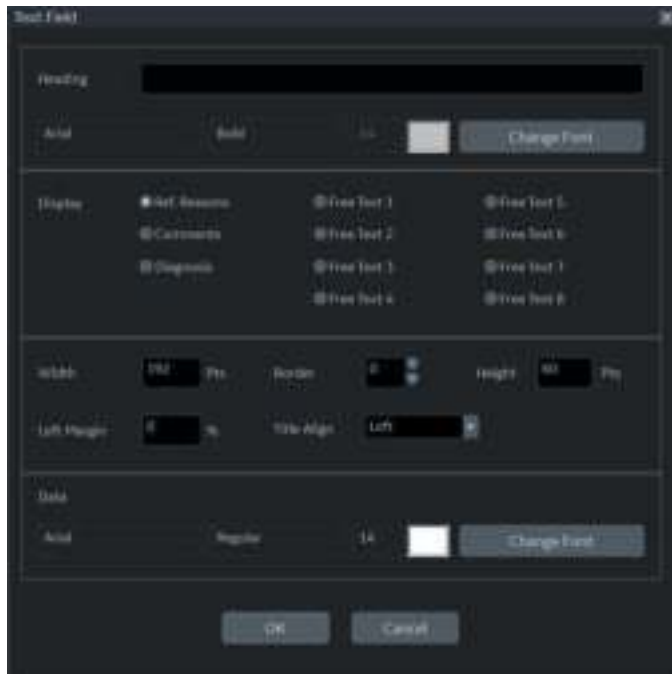

Figure 13-220. Text Field Dialogue Box

4. Select the appropriate display items:
  - Ref. Reasons: Retrieves this information from the Direct Report
  - Comments: Retrieves this information from the Comment field of the patient screen and the Exam Comment field of the worksheet.
  - Diagnosis: Retrieves this information from the Direct Report
  - Free Text 1 - 8

## Inserting Text (continued)

5. Type the heading Text.
6. Modify box properties, the heading text and font, and data.
7. Select **OK** or Cancel.
8. Save the template.

To keep the same template name:

- Select **Save** from the File menu, and press **Set**. The Save Template dialog box opens.
- Select **Yes**. The template retains the same name and adds “[user]”. For example, OB23-Basic[user].

To save the template with a new name:

- Select **Save As** from the File menu, and press **Set**. The Save Template As dialog box opens.
- Enter the name of the new template, and press **Set**. The template receives the new name and adds “[user]”. For example, NewReport[user].

## Inserting an image to the report

Some factory templates include an image area. If you want to insert or modify the image area, see ‘Image Display Fields’ on *page 13-445* for more information.

To insert images from clipboard into the image field of the report:

1. Move the cursor to the desired image on the clipboard.

*NOTE:* The preview image appears when the cursor is over a clipboard image.

2. Press and hold down the **Set** key and drag the selected image to the report by using the **Trackball** or double click the **Set** key on the desired image.
3. To move images between image areas, press and hold down the **Set** key and using the **Trackball**, drag the selected image to the new location.

To remove an image from the report, press and hold down the **Set** key and using the **Trackball**, drag the select image back to the clipboard.

### Measurement result section

Measurement results for the current patient display automatically if you have the measurement section in the report template.

The factory template has an appropriate measurement result area. If you want to insert or modify the measurement area, see 'Measurements' on *page 13-451* for more information.

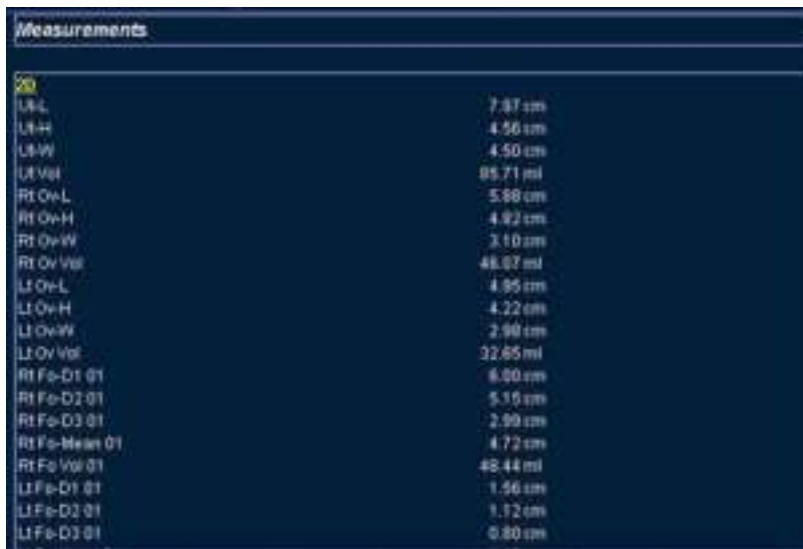

Measurement	Value
UI-L	7.37 cm
UI-H	4.56 cm
UI-W	4.50 cm
UI-Vol	85.71 ml
RI Ov-L	5.88 cm
RI Ov-H	4.82 cm
RI Ov-W	3.10 cm
RI Ov-Vol	48.87 ml
LI Ov-L	4.95 cm
LI Ov-H	4.22 cm
LI Ov-W	2.99 cm
LI Ov-Vol	32.65 ml
RI Fe-D1 01	6.00 cm
RI Fe-D2 01	5.15 cm
RI Fe-D3 01	2.99 cm
RI Fe-Mean 01	4.72 cm
RI Fe-Vol 01	48.44 ml
LI Fe-D1 01	1.56 cm
LI Fe-D2 01	1.12 cm
LI Fe-D3 01	0.80 cm

Figure 13-221. Measurement section



## Inserting the worksheet

You can insert the worksheet (like you can insert an image) to the image display field. To set an image display field in the report template, see 'Image Display Fields' on page 13-445 for more information.

1. Display the worksheet on the monitor display.
2. Save the worksheet using the **Print** key.
3. Press **Report**.
4. Drag the worksheet into the report.
  - a. Move the cursor to the desired worksheet on the clipboard.
  - b. Press and hold down the **Set** key. Use the **Trackball** to drag the selected worksheet into the Image Display Field.
  - c. Release **Set**.

*NOTE:* You can also move the cursor to the desired worksheet on the clipboard, double-click the worksheet, move the cursor to the Image Display Field, and select **Set**.

5. The worksheet displays on the report.

*NOTE:* You can double-click the worksheet in the report to change the background color to white to save ink during printing. Double-click the worksheet again to return the worksheet to the original color.

### Placing objects side-by-side

If you want to place images, the image and comment, anatomical graphic and comment, etc. side-by-side, you must first place a table, which has two (or more) columns, into the report template.

1. Select **Report**.
2. Select **Designer** to display the Report Designer.
3. Place the cursor where you want to insert the object.
4. Select **Table** from the Insert menu. Insert Table box displays.



Figure 13-222. Insert Table Box

5. Set the number of columns to 2 (or more, as required) and change the table parameters, if needed. Select **OK**.
- NOTE:** *If you do not need a table border, set the Border to 0. Add additional rows if required.*
6. Place the cursor in the column and select the desired items from the Insert menu (e.g. logo, image, free text). Specify those items.
  7. Repeat step 6 for each column as required.
  8. Save the template.

To keep the same template name:

- Select **Save** from the File menu, and press **Set**. The Save Template dialog box opens.
- Select **Yes**. The template retains the same name and adds “[user]”. For example, OB23-Basic[user].

## Placing objects side-by-side (continued)

To save the template with a new name:

- Select **Save As** from the File menu, and press **Set**. The Save Template As dialog box opens.
- Enter the name of the new template, and press **Set**. The template receives the new name and adds “[user]”. For example, NewReport[user].

You can insert the images in the order preferred, by row or column, on the factory templates. See ‘Inserting the Table’ on *page 13-437 for more information*.

## Accessing Worksheet, OB Graph and Anatomical Survey Pages

If the Worksheet, OB Graph, and/or Anatomical Survey pages have been saved for the current patient, you can access these pages from the report page.

**NOTE:** *OB Graph and Anatomical Survey pages applies to OB, GYN and Abdomen.*

1. Select either **Worksheet**, **Graph** or **Anatomical Page** on the Touch Panel.

**NOTE:** *There is also Fixed Text set up as hyperlinks for these pages. Cursor to the fixed text and press **Set**.*

2. The system displays the appropriate page (Worksheet, OB Graph or Anatomical Survey) with the corresponding Touch Panel.
3. Select **Report** to return to the Report page.

## Storing the Report

1. Select **Store**.

The Report is saved as a CHM file to Archive.

**NOTE:** *The archived report cannot be edited; therefore, it is recommended that the data is carefully reviewed before the report is saved.*

## Retrieving an Archived Report

1. Select **Retrieve**. The Retrieve menu displays.



Figure 13-223. Retrieve Menu (Prefix "User1\" may not appear)

2. Select the desired report and press **Set**.

**NOTE:** *The retrieved report cannot be edited.*

## Deleting a Report from Archive

1. Select **Delete**. The Retrieve menu appears on the screen.



Figure 13-224. Delete Reports Menu (Prefix “User1\” may not appear)

2. Select the report to delete and press **Set**.

## Printing the Report

To preview the Print Layout before printing, see ‘Preview the Print Layout’ on page 13-435 for more information.

**NOTE:** *Double-click the worksheet and/or image in the report to change the background color to white. A white background will save ink during printing. Double-click the worksheet or image again to return to the original color.*

1. Select **Print** to print out the report.  
The Report is printed on the default printer.

### Exporting the Report to Media

1. Select **More**.
2. Select **Save As**.  
The Save As dialog box appears on the screen.
3. Enter the Report title and select the file format.
4. Select the media to export the Report. The system supplies a name (numeric DICOM UID, unique identifier).



Figure 13-225. Save as Dialog Box

5. Select **Save**.

### Exiting the report

1. Select **Store** to save the report.  
*NOTE: If the user is working on a report and leaves the report screen for any reason, all information added to the report is automatically saved without loss of data.*
2. Select another key to close the report page.

## Designing Your Own Template

### Template Designer

You can design and create your own customized template from a blank template page, or you can use an existing template (factory or user-defined) and save the changes.

Display the desired template and select **Designer** to open the Template Designer page.

The screenshot displays a software interface for designing report templates. The interface is divided into several sections:

- Top Right:** A list of fields: "User Name", "Address", "City/State/Zip Code", and "Phone".
- Section Header:** "Patient Information".
- Form Fields:** A grid of fields for patient data:
  - Row 1: Name, Patient Id, Title
  - Row 2: Birthdate, MRN, GR
  - Row 3: Initials, Ref. Physician, ICD
  - Row 4: Ref. Physician, Operator
- Section Header:** "Indications".
- Text:** "Comments" (likely a label for a text area).
- Section Header:** "Measurements".
- Table:** A table with 4 columns and 4 rows, currently empty, intended for measurement data.

Figure 13-226. Report Designer

### File Menu

Table 13-79: File Menu

	Description
New	Creates a new template. A blank template appears.
Save	Overwrites the existing template.
Save As	Saves as a new name.
Page Setup	Enters Print Layout screen.
Print Preview	Executes print preview.
Exit	Exits Report Designer page.

#### Create a new template

To design a new template without using a pre-existing factory template:

1. Select **Designer** to open the Report Designer.
2. Select **New** from the File menu, and press **Set**.  
The blank template displays.
3. Create the report template as needed.
4. Select **Save** from the File menu, and press **Set**.  
The Save Template As dialogue box displays.
5. Enter a template name and click **OK**.
6. To exit Report Designer, select **Exit** from the File menu, and press **Set**.
  - Yes: Saves changes and exits Report Designer.
  - No: Does not save changes and exits Report Designer.
  - Cancel: Returns to Report Designer.



## Create a new template and save as a factory template name

To design a new template by modifying an existing factory template and keeping the same name of the factory template:

1. Select and display the existing factory template.
2. Select **Designer** to open the Report Designer.
3. Modify the report template as needed.
4. To save changes, select **Save** from the File menu, and press **Set**.

The Save Template dialog box displays.

- Yes: Saves changes.
- No: Does not save changes.
- Cancel: Returns to Report Designer.

### NOTE:

*The template name displays in the template list, retains the same name, and adds “[user]”. For example, “OB23-Basic[user]”. You do not lose the original factory template.*

5. To exit Report Designer, select **Exit** from the File menu, and press **Set**.
  - Yes: Saves changes and exits Report Designer.
  - No: Does not save changes and exits Report Designer.
  - Cancel: Returns to Report Designer.



### HINTS

Save changes frequently as you modify your template. Saving often reduces the risk of losing all your changes.

### Create a new template and save with a new name

To design a new template by modifying or copying an existing factory template and saving it with a new name:

1. Select and display the existing factory template.
2. Select **Designer** to open the Report Designer.
3. Modify the report template as needed.
4. Select **Save as** from File menu and press **Set**.  
The Save Template As dialog box displays.
5. Type the new template name and click OK.
6. Select **Exit** from the File menu and **Set**.
7. The Report Designer closes and returns to the Report Page.

**NOTE:** *The template receives the new name and adds “[user]”. For example, NewReport[user].*

### Page Setup

1. Modify the factory template as necessary in **Designer**.
2. Select **Page Setup** from File menu and press **Set**.
3. Change the paper size or orientation to fit the print layout, as necessary.

To define the header and footer for the printed report, type text and enter the required variables listed in the table below. Select “Different for first page” and enter a specific header/footer for that page.

Table 13-80: Variable and Definition

Variable	Definition	Variable	Definition
{pid}	Patient ID	{prt}	Current time (printing time)
{pnm}	Patient name	{cp}	Current page
{pbd}	Patient date of birth	{tp}	Page count
{exd}	Examination date	{c}	Subsequent text is centered
{prd}	Current date (printing date)	{r}	Subsequent text is right aligned.
{inm}	Institution name		

**NOTE:** *Default is left aligned. Report will appear as black ink on white background.*

**Page Setup (continued)**

4. Select **OK** or **Cancel**.



Figure 13-227. Page Setup with Header Example

**Preview the Print Layout**

1. Select **Template** to choose the Report Template.
2. The Print Preview screen displays.

If changes need to be made, select **Close** to exit the Preview page. Modify the template or return to the Report and modify the contents.

**Edit Menu**

Table 13-81: Edit Menu

	Description
Delete	Deletes the selected object from the report template.
Undo	Restores the previous state(s) of the report template.

**Deleting a template object**

1. Select the object to be deleted.
2. Select **Delete** from the Edit menu, and press **Set**. The object is deleted from the template.

**Undoing the operation**

1. Select **Undo** from the Edit menu, and press **Set**.
2. Repeat as required.

### Insert Menu

Table 13-82: Insert Menu

	Description
Page Break	Inserts a Page Break.
Table	Inserts a Table.
Logo	Inserts a Logo Bitmap File.
Archive Info	Inserts Archive Information.
Anatomical Graphics	Selects anatomical graphics by category to be inserted into a field.
Anatomical Survey	Selects OB, GYN or Abdomen.
Image	Inserts the image display field to the template.
Wall Motion Analysis	Selects Cut Planes, Bull's Eye, or Score Table Box.
OB/GYN	Selects OB Graph, Bar Graph or Anatomy.
Small Parts	Selects Breast or Thyroid.
Measurements	Inserts the measurement display field in the template.
Text Field	Edits text field.
Fixed Text	Enters any comments as Fixed Text.

#### Inserting the Page Break

1. Place the cursor where the Page Break is to be inserted and press **Set**.
2. Select Page Break from the Insert menu and press **Set**. The page break line displays on the template.

*NOTE:* To edit the page break line, select the line and double click the **Set** key.

## Inserting the Table

1. Place the cursor where the table is to be inserted and press **Set**.
2. Select Table from the Insert menu and press **Set**. The Insert Table dialog box displays.



Figure 13-228. Insert Table Dialog

3. Specify each parameter as required.

**NOTE:** *To set the table border as not visible, set “Border” parameter to 0 (zero)*

4. Select **OK** to insert the table or Cancel.

**NOTE:** *To insert/delete a row/column from the table or access table properties, double click the **Set** key in any empty area inside the table. A table menu appears with those options.*

### Inserting Images in a Table

You can choose the order in which images are inserted into tables: by row (default) or by column.

#### **Image Order by Row**

The system default inserts images in the cells of the first row, then to the next row.

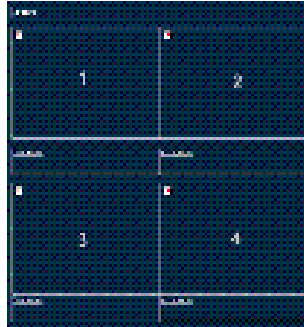

Figure 13-229. Image Order—Row Preference (System Default)

1. Follow the instruction for inserting a table. When specifying parameters, specify:  
No. of Columns=2; No. of Rows=2
2. After inserting the table, insert an image box in each cell of the table.
  - a. Move the cursor to the first cell and select Insert -> Image.
  - b. Repeat this step for each cell in the table.

After the template is saved and you are working in the ReportWriter, when you select images to be inserted in the table, they are placed in the default order.

## Inserting Images in a Table (continued)

### Image Order by Column

If you prefer to have the image placement by column, images are inserted in each cell of the first column, then the next column.

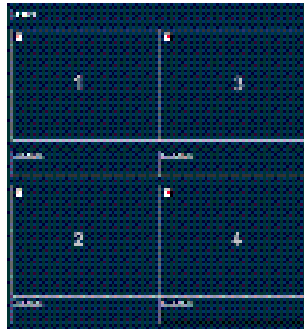

Figure 13-230. Image Order—Column preference

In order to achieve the column preference, you need to create a table with 2 columns and 1 row. In each cell of this table, you need to insert another table.

1. Follow the instructions for inserting a table. When specifying parameters, specify:  
No. of Columns=2; No. of Rows=1
2. After inserting the table, create a table inside each of the existing table's cells.
  - a. Move the cursor to the left column's cell and press **Set**.
  - b. Select Table from the Insert menu and press **Set**.
  - c. When specifying parameters, specify:  
No. of Columns=2; No. of Rows=1; Width=290 pixels.  
Select **OK**.
  - d. Repeat steps a-c for the next column.
3. Insert an image box to each table cell.
  - a. Move the cursor to the first cell and select Insert -> Image.
  - b. Repeat this step for each cell in the 2 tables.

After the template is saved and you are working in the ReportWriter, when you select images to be inserted in the table, they are placed with your column preference.

### Inserting Logos

1. Place the cursor where you want to insert the logo and press **Set**.
2. Select Logo from the Insert menu and press **Set**. The Logo Box displays.



Figure 13-231. Logo Box

3. Select a logo that you want to insert (1), or import a bmp or jpg file from the removable media (2). Scroll the images using the arrow key (3). Specify the appearance (4).
4. Select **OK** to insert the logo or Cancel.

#### **Changing a logo:**

1. Place the cursor on the logo to be changed and press **Set** twice. The Logo Box displays.
2. Select a different logo. If the desired logo is not shown, select Import Logo to import a different logo.
3. Specify the appearance.
4. Select **OK** or Cancel.



## Inserting Archive Information

Archive information contains all the objects from the different information menus (Patient, Exam, and Site Information). This box accumulates different information menu selections that can be grouped together and displayed in one table.

1. Place the cursor where you want to enter the archive information and press **Set**.

If you use a factory template, double click on the current archive information area to display the Archive Information Box.

2. Select **Archive Info** from the Insert menu and press **Set**. The Archive Info Box displays.



Figure 13-232. Archive Information Box

3. Type the Heading, select a heading link from the pull-down menu, and select the parameters you want to display in the report.

**Inserting Archive Information (continued)**

4. Select Box Properties to change the Font, Alignment, Appearance, etc.

*NOTE: To set the same font to all fields, select Set All fields.*



Figure 13-233. Table Properties

5. Select **OK** or Cancel. The contents of the Archive Information is inserted to the related page automatically.



Figure 13-234. Patient (Archive) Information Example

## Inserting Archive Information (continued)

### *Editing displayed Archive Information:*

1. Select **Designer**.
2. Move the cursor to Archive Information field to be edited.
3. Press **Set** twice. The Archive Information Box displays.
4. Edit the heading, the Heading Link and Information parameters, as necessary.
5. Select **OK** to save or Cancel.

### Anatomical graphics

1. Place the cursor where you want to insert the Anatomical Graphics and press **Set**.
2. Select **Anatomical Graphics** from the Insert menu.
3. Select the desired category and press **Set**. The graphic box displays.



Figure 13-235. Anatomical Graphics Box Example

4. Select the graphic to be inserted to the template or import a bmp or jpg file from the removable media. Scroll the images using the arrow key.
5. Select Appearance.
6. Select **OK** or Cancel.

## Image Display Fields

1. Place the cursor where you want to insert the image.
2. Select image from the Insert menu and press **Set**. The Ultrasound Image Box displays.



Figure 13-236. Ultrasound Image Box

3. Type the Heading text, modify the box properties, and change the heading text font, as necessary.

**NOTE:** *For no heading, type a Space in the Heading text.*

To keep the monitor image appearance, the ratio of width to height (W:H) should be 4:3. So, basically 640:480 for large images and 300:225 for two side-by-side images.

4. Select **OK** or Cancel.

## Cardiac Studies Wall Motion Analysis

1. Place the cursor where you want to insert the wall motion analysis and press **Set**.
2. Select Wall Motion Analysis from the Insert menu.

Cardiac Studies Wall Motion Analysis (continued)

3. Select and set up the desired parameter.
  - Bull's Eye



Figure 13-237. Bull's Eye Dialog Box

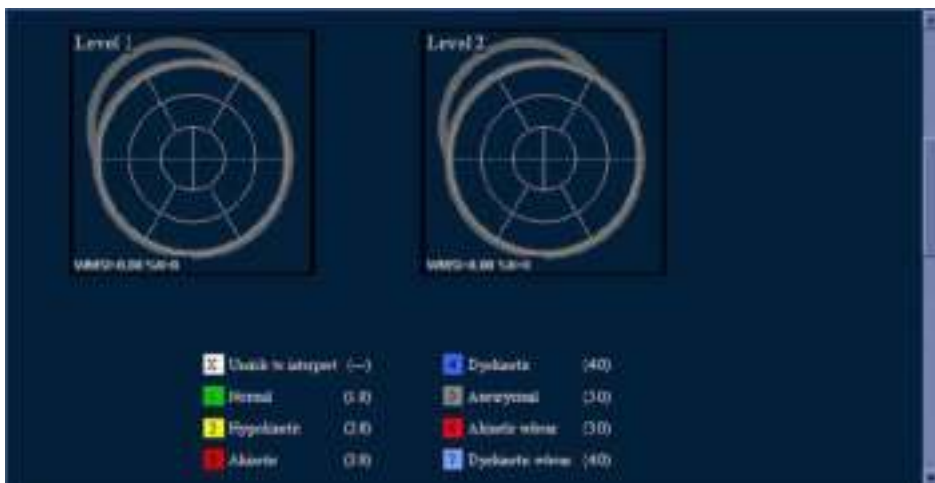

Figure 13-238. Bull's Eye Report Example

**Cardiac Studies Wall Motion Analysis (continued)**

- Cut Planes

*NOTE: The Cut Planes dialog box parameters are similar to the Bull's Eye Dialog Box shown previously.*



Figure 13-239. Cut Planes Report Example

- Score Table Box



Figure 13-240. Score Table Box Dialog Box

### OB/GYN (OB and GYN Only)

The OB Graph, Bar Graph and Anatomy can be entered into the Report.

1. Place the cursor where you want to insert the graph or anatomy and press **Set**.
2. From the Insert menu, select OB/GYN. The selection menu displays.
3. Select the appropriate item as necessary. A dialog box displays.
  - OB Graph



Figure 13-241. OB Graph Dialog Box

- a. Select the Measurement and Fetus Number.
- b. Check Fetus Trending and Fetus Compare, if appropriate.
- c. Modify the Layout, if necessary.
- d. Select **OK**



**OB/GYN (OB and GYN Only) (continued)**

- Bar Graph



Figure 13-242. Bar Graph Dialog Box

- Select the exam and fetus number.
- Modify the Layout, if necessary.
- Select **OK**.

**NOTE:**

*The Bar Graph already contains default application measurements.*

OB/GYN (OB and GYN Only) (continued)

- Anatomy

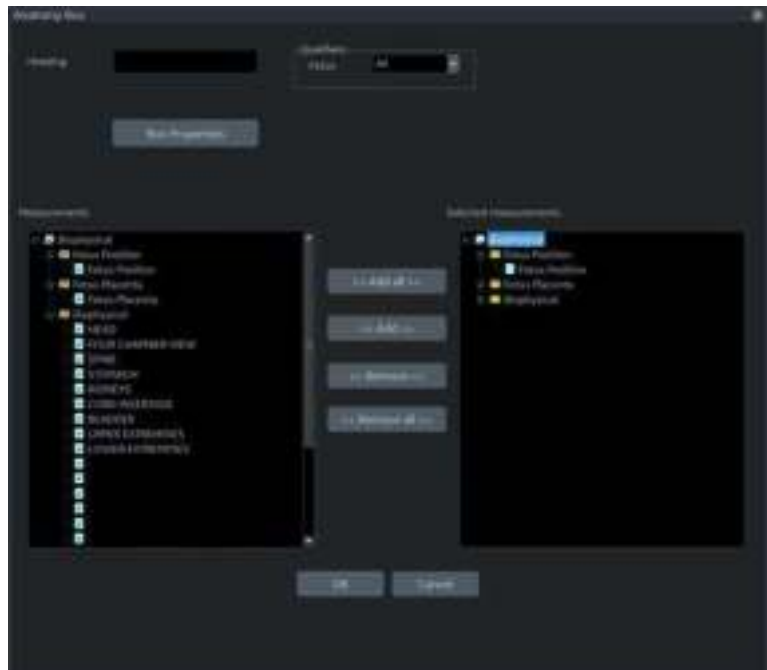

Figure 13-243. Anatomy Dialog Box

- Type the Heading.
- Select qualifiers from the pull-down menu.
- Select “**Add all**” to copy all measurements to the right column
- Check the box in front of the measurement you need in the left column and select “**Add**”. The select measurements copy to the right column.
- To remove measurements you do not need, check the boxes in front of those measurements in the right column, and select “**Remove**” or “**Remove all**”.
- If you want to modify the properties, select Box Properties and set required parameters.

## Measurements

Insert a field to display the measurements. The measured parameters displayed in the measurement display field are configured.

1. Place the cursor where you want to insert the measurement and press **Set**.
2. Select Measurements from the Insert menu and press **Set**. The Measurements Box displays.

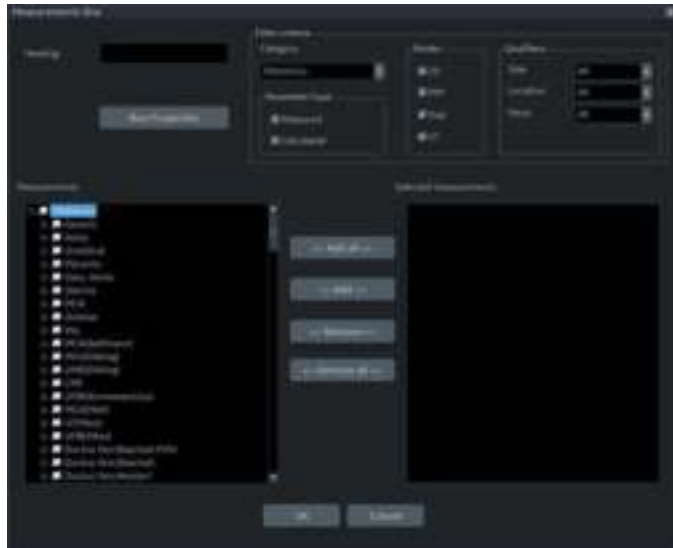

Figure 13-244. Measurement Box

3. Type the Heading text, select the Filter Criteria and measurements from the tree, as necessary.
4. Select **OK** or Cancel.

### Text Fields

1. Place the cursor where you want to insert the text and press **Set**.
2. Select Text Field from the Insert menu and press **Set**. The Text Field dialog box displays.



Figure 13-245. Text Field Dialog Box

3. Type the Heading Text. If you do not need the heading, type a space.
4. Select Display item.
  - Ref.Reason: Reason for Referral.
  - Comments: Gets information from the Comment field of the Patient screen and the Exam Comment field of the Worksheet.
  - Diagnosis.
  - Free Text: 1 - 8
5. Specify the border of the Text Field and Font as necessary.
6. Select **OK** or Cancel.

The text is saved automatically into the corresponding area selected on this dialog box.

**Text Fields (continued)*****Editing an existing text field:***

1. Move the cursor to the Text Field to be edited.
2. Press **Set** twice. The Text Field dialog box displays.
3. Edit the heading, the settings, or font, as necessary.
4. Select **OK** or Cancel.

**Fixed Text**

1. Place the cursor where you want to insert the fixed text and press **Set**.
2. Select Text Field from the Customize menu and press **Set**. The Fixed Text dialog box displays.

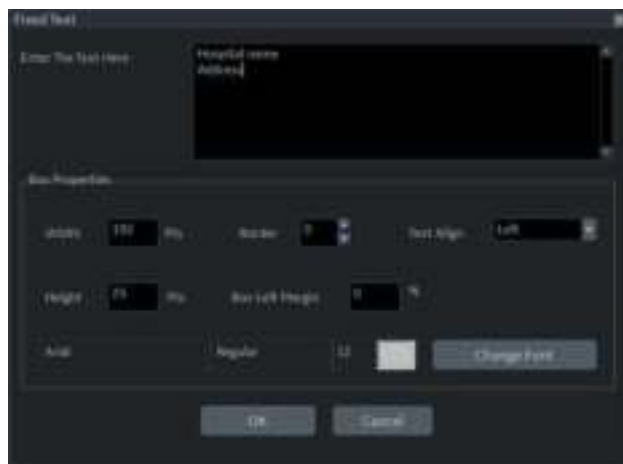

Figure 13-246. Fixed Text Dialog Box

3. Type the text (e.g. hospital information, report title, or table title) and specify the border and font.
4. Select **OK** or Cancel.

***Editing existing Fixed Text:***

1. Move the cursor to the Fixed Text to be edited.
2. Press **Set** twice. The Fixed Text dialog box displays.
3. Edit the text, the border or font, as necessary.
4. Select **OK** or Cancel.

## Customize Menu

Table 13-83: Customize Menu

	Description
Page Color	Changes the template color.
Preference	The Preference menu for Archive Information field displays.

### Page Color

1. To change the page color, select Page Color from the Customize Menu and press **Set**. The Color dialog box displays.



Figure 13-247. Color Dialog

2. Choose the desired color or create a new color.
3. Select **OK** or Cancel.

## Setting Preferences

To set preferences for the Archive Information:

1. Select Preferences from the Customize menu and press **Set**. The Preference Box displays.

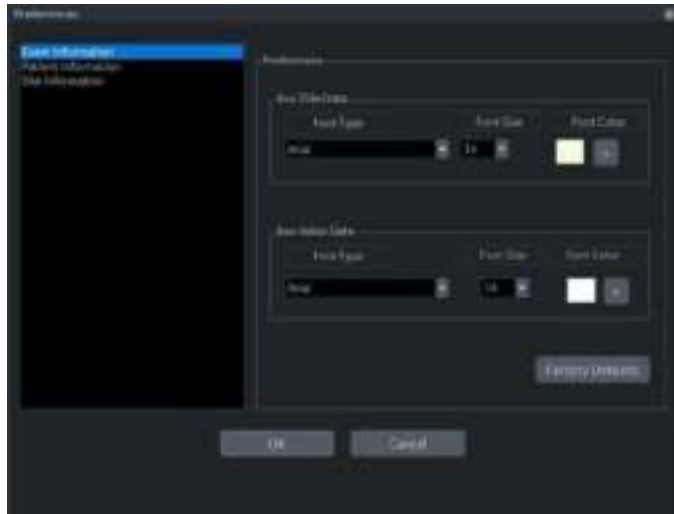

Figure 13-248. Preferences Box

2. Select the information to be modified and set the desired preferences.
3. Select **OK** or Cancel.
4. Save the template.

### Direct Report

#### Direct Report

You can use Direct Report to enter Comments, Diagnosis, and Referral Reasons at any time during the examination that will be part of the final report. The comments are reflected on the Report if the Report is configured for those parameters.

1. Select **Direct Rep.** on the measurement Summary window. The Direct Report displays on the left side of the monitor display.



Figure 13-249. Measurement Summary Window



## Direct Report (continued)

- The Direct Report displays on the left side of the screen.



Figure 13-250. Direct Report

- Select the type of information  
*NOTE: Comments entered under Diagnosis appear in the Clinical Diagnosis section of the final report. Comments entered under Referral Reasons appear in the Referral Diagnosis section of the final report.*
- Create/insert pre-defined text
- Text field
- List of measurements completed  
 The measurement results display on the Measurement Overview field.  
 Double Click: inserts value only for selected line, e.g. 5.98 cm  
 Shift + Double Click: inserts whole line for selected line, e.g. BPD 5.98 cm
- Exits the Direct report

### Direct Report (continued)

3. Select the appropriate parameter and type the free text with the alphanumeric keyboard or use Insert Text.

**NOTE:** You can configure the pre-defined text at the Utility Report screen.

- a. Select **Insert Text** to display the Insert Text Window.
- b. Use the **Trackball** to select the text to be inserted.
- c. Press **Set**. The selected text displays on the Direct Report.

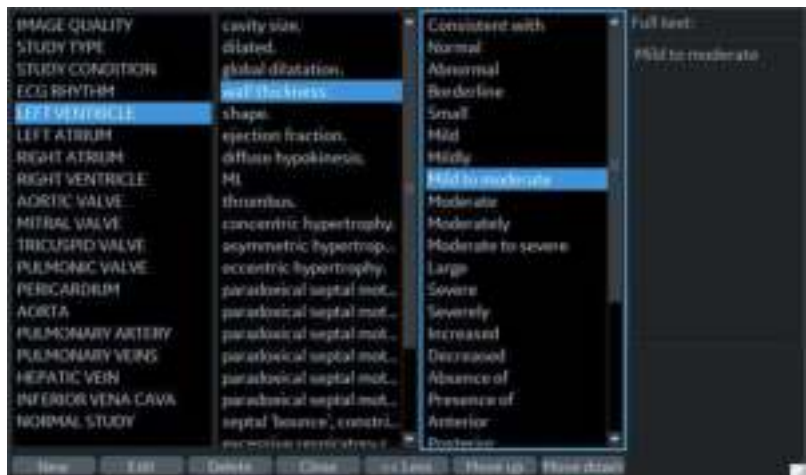

Figure 13-251. Full Insert Text Window

- New: Enters the new text
  - Edit: Edits the existing text
  - Delete: Deletes the existing text
  - Close: Closes the insert text window
  - More>>: Displays the Full Insert Text Window
  - <<Less: Minimizes the insert text window
  - Move up/Move down: Moves the text up or down
4. Move the cursor over the measurement result displayed in the overview window, and double click the **Set** key.

## Direct Report (continued)

5. Select **Done** at the bottom of Direct Report to exit.

If you configure the field of comment, diagnosis, referral reasons or Measurement on the Report, the text and/or measurement results entered in the Direct Report are automatically displayed on the Report.



Figure 13-252. Direct Report and Report (Example)

### Report Presets

#### Utility Report Page

You can edit the report template, diagnosis code, and text on the Utility Report page.

#### Templates

Left Column: The list of all templates (Factory Default, User defined, etc)

Right Column: The list of templates displayed on the template list.

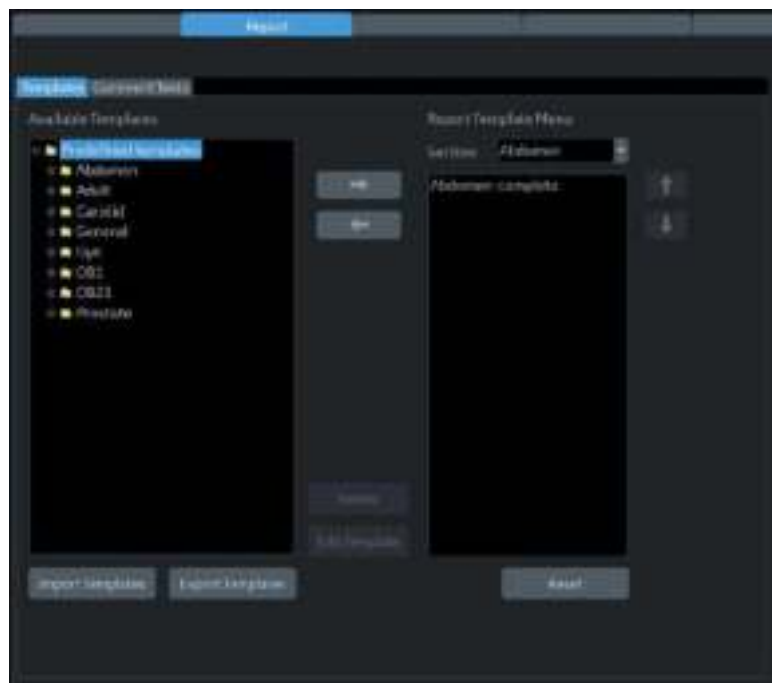

Figure 13-253. Report Template Tab

## Templates (continued)

- To insert the template on the template list:
  - a. Select the application which you want to insert into the template from the pull-down menu above the right column.
  - b. Select the category (categories) and/or the template(s) in the left column by the check the box.
  - c. Select the right arrow to copy the template to the right column.
- To remove the template from the template list but not from the system):
  - a. Select the template in the right column.
  - b. Use the left arrow to remove the template from the right column.
- To edit the template or to make a new template:
  - a. Enter Utility -> Report -> Template tab.
  - b. Select the appropriate template in the left column.
  - c. Select **Edit Template**. The Template Designer page displays.
  - d. Edit the template and save or save as with a new name.

If you use Save As with a new name, the new template is added to the left column. See 'Designing Your Own Template' on *page 13-431 for more information*.
- To delete the template:
  - a. Select the template to be deleted.
  - b. Press **Delete**.

### Templates (continued)



#### HINTS

- To export the template:

Export templates to removable media (USBs) so, at a later time, you can import those templates to a different system or a system with a different software version. Export only works on templates, not data.

- a. Insert the removable media in the drive.
- b. Move the cursor to “Export Templates” and press **Set**. The available user-defined templates display in the Export Templates window.



Figure 13-254. Export Templates

- NOTE:**
- a. Select the template(s) to be exported.  
*To select multiple templates, use the **Ctrl** or **Shift** keys.*
  - d. Select the desired removable media under the Select Target Device field.
  - e. Select **OK**.
  - f. Press **F3** to eject the media.

## Templates (continued)



## HINTS

- To import the template:

Import templates from a different system or a system with a different software version. Import only works on templates, not data.

- a. Insert the removable media with the report template(s) to be imported.
- b. Select **Import Template**. The Import Template window displays.
- c. Select the Source Device from the pull-down menu. Select **OK**.
- d. Press **F3** to eject the media.

**NOTE:**

*Imported templates are stored in the User defined templates\General directory.*

- To move the template from the left column to the right, or from the right to the left:
  - a. Select the template to be moved.
  - b. Select the Right Arrow or Left Arrow button.
- To move the template up or down in the right column:
  - a. Select the template to be moved.
  - b. Press the Up Arrow or Down Arrow button.

### Comment Texts

You can edit the comment text on the Comment Texts tab.

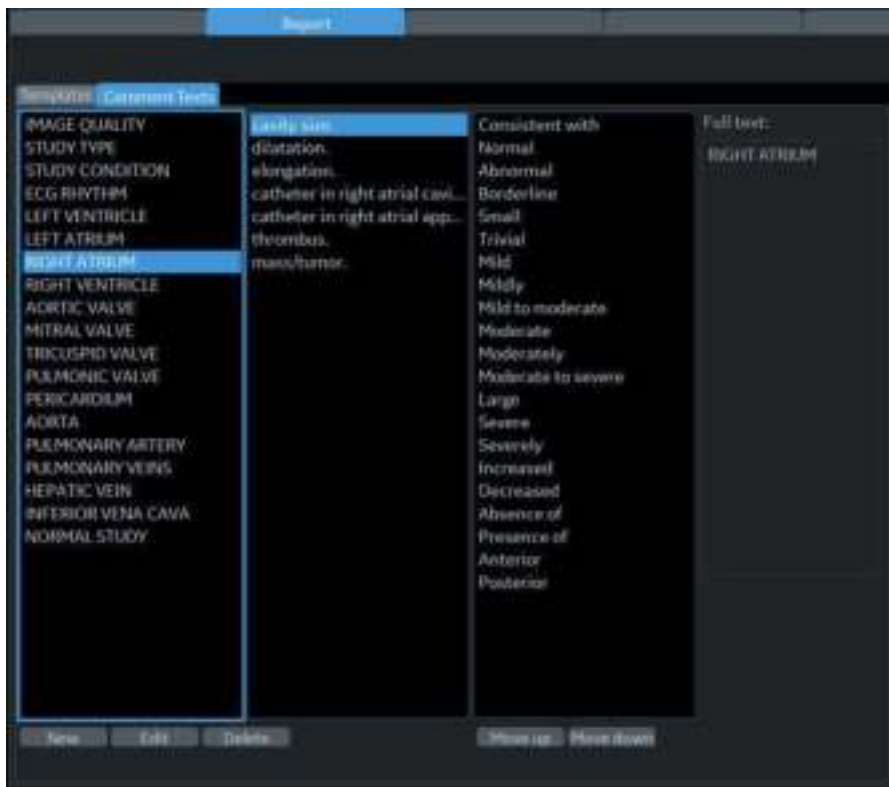

Figure 13-255. Comment Texts Tab

- New: Enters the new comment.
- Edit: Edits the existing comment.
- Delete: Deletes the existing comment.
- Move up/Move down: Moves the comment up or down.



## Backup/Restore Report Templates

Backup moves templates to removable media (USBs).

Restore moves templates, that were backed up onto media, to a similar system or a system with the same software version. For example, it allows templates to move from one LOGIQ Totus to another LOGIQ Totus.

To backup the report template:

1. Select **Utility**.
2. Select **System** and select the Backup/Restore tab.
3. Select the media.
4. Check User Defined configuration box of the Backup field.
5. Select **Backup**.
6. Select **Save** and eject the media.

To restore the report template:

1. Insert the media.
2. Select **Utility**.
3. Select **System** and select Backup/Restore tab.
4. Check Report Template box of the Detailed Restore of User Defined.
5. Select **Restore**.
6. After the system reboot, select **Utility** and **Report**.
7. Select the Template tab.
8. Select the appropriate template (See 'Templates' on *page 13-460 for more information.*)

# Configuring DICOM

## Overview

If you follow these instructions, you will be able to set up a DICOM PACS environment suitable for a typical daily routine in a typical Ultrasound clinical environment:

In these instructions, you will ensure that your LOGIQ Totus and DICOM PACS are connected to and communicating back and forth on the hospital/clinic's network and between the devices. We will be setting up the most commonly used DICOM features typically used in a clinical setting.

**NOTE:** *For additional information on the DICOM parameters, detailed information is provided in Chapter 10, Customizing Your System.*

**NOTE:** *To set up the connectivity configuration, See 'Configuring Connectivity' on page 10-61 for more information.*

## DICOM Job Spooler

To check the status of each job, open the DICOM Job Spooler by pressing F4 (see Figure 13-256).



Figure 13-256. DICOM Job Spooler Active Jobs

The DICOM Job Spooler lists Pending, Active, Completed (identified as “Done”) and Failed jobs, with the status listed in the “Status” column on the far right. Select the desired job to see the job details in the Details Pane on the right side of the screen.

Failed jobs will include an Error Description and Recommendations to correct the error in the Details Pane (see Figure 13-257 on page 13-467).

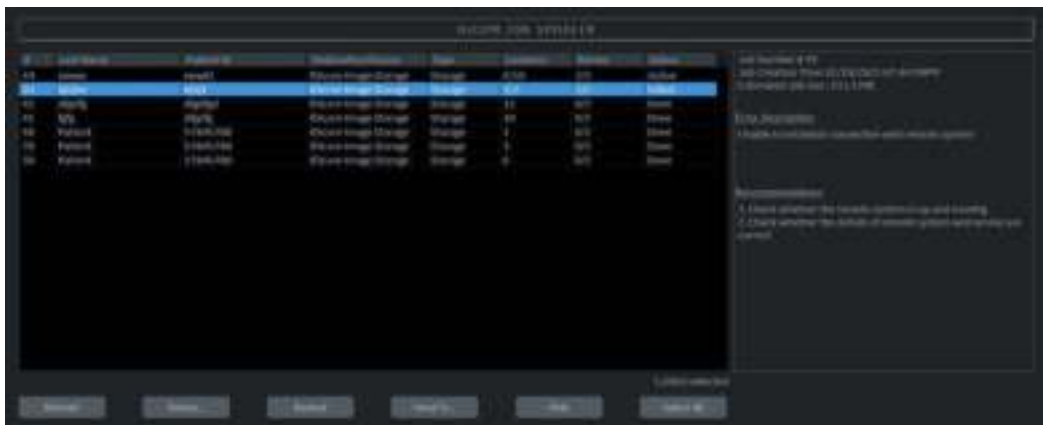



Figure 13-257. DICOM Job Spooler Failed Job

**NOTE:** *Deleting jobs from the spooler does not delete images from the hard drive. They can be re-sent via the “Send To” function on the Patient--> Patient View, Exam View, or Image Review.*

## Patient Menu DICOM Functionality

Additional DICOM functionality can be performed via the Patient Menu:

Table 13-84: Patient View Functions

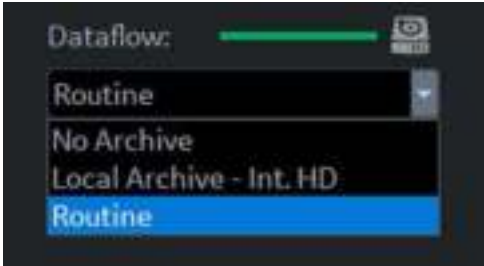
<p>You can also send studies to the DICOM destination by selecting Send To. :</p>	
<p>And, access the Worklist or perform Query/Retrieve to/from the PACS via the Patient screen. To start Query/Retrieve for a patient: Select the patient, select Query, the LOGIQ Totus then displays a list of exams. Select the desired exam, then select Transfer.</p>	
<p>You can also specify which Dataflow to use on the Patient page. This is the dataflow that will be used for Copy to Dataflow on print keys.</p>	

## **Troubleshooting DICOM Connectivity Issues**

- If you ping/verify the device and receive a frown, confirm with your IT Team that you are using the correct IP Address, AE Title, Port Number, etc.
- If the image/clip is stuck in the Print Spooler, select the job and resend or send to an alternate device.

For Detailed descriptions of every DICOM parameter, refer to Chapter 10 of the Basic User Manual's (Configuration chapter). For more detailed instructions on setting up each DICOM page, refer to Chapter 3 of the Basic Service Manual (System Setup).

# Configuring the Wireless Network

## **Wireless LAN (WLAN)**

A Wireless Network (WLAN) is available on the LOGIQ Totus. When the WLAN is active, an icon appears in the status bar to indicate whether the WLAN is installed or disconnected. See 'Network and Spooler Status Icons' on *page 13-474* for a description of the network icons.

## **Wireless LAN (WLAN) Specifications**

The Wireless LAN (WLAN) supports the following network protocols:

### **Supported Standards**

- Conforms to IEEE 802.11 a/b/g/n/ac Wi-Fi with Bluetooth 5.2 Standard.
- FCC Part 15 Class B
- Japan's Radio Law
- Radio Equipment Directive
- Canada Requirements

### **Security Methods**

- WPA2
- WPA3

### **Encryption**

- 128-bit AES-CCMP
- 256-bit AES-GCMP

### **Internet Protocol**

- The LOGIQ Totus supports IPv4 or IPv6.

### **Intel declaration of conformity**

You can find the Intel Declaration of Conformity at this web link:

<https://www.intel.com/content/dam/support/us/en/documents/network-and-i-o/wireless-networking/ax210ngw-eu-red-doc.pdf>

## **Wireless LAN (WLAN) Specifications (continued)**

### **Authentication**

- None
- Microsoft PEAP using MSCHAP v2
- Username/password
- Limited support for server certificate verification using pre-installed trusted root CAs
- Client certificates not supported
- User authentication/confirmation prompts not supported

### **Antenna**

- 2 integrated internal wireless antenna

### **Radio Data Rate**

- 1, 2, 5.5, 6, 9, 11, 12, 18, 24, 36, 48, 54, 08, 140, 246, and 300 Mbps (Auto Rate Sensing)

### **Frequency**

- 2.4, 5, 6 GHz (160MHz)

### **Country Compliance**

The WLAN subsystem automatically detects location and adjusts the output to be compliant to country regulations. The following is a partial list of countries that the product is compliant with:

- United States: FCC Part 15 Class B
- Canada: Industry Canada Radio Standards Specification (RSS) license-exempt
- European Union: Radio Equipment Directive (RED) 2014/53/EU
- Japan: Japan Radio Law
- Brazil: National Telecommunications Agency (Anatel)
- Malaysia: Malaysian Communications and Multimedia Commission (MCMC)
- Singapore: Infocomm Development Authority of Singapore (IDA)



## Connecting to the WLAN

To connect the LOGIQ Totus to the WLAN,

1. Press Utility --> Connectivity --> TCP/IP --> Wireless Network --> Configuration (located under Wireless Network).

The Wireless Network Configuration tool appears. If enabled, Wireless Networks broadcasting in your area appear in the list.





















2. If necessary, check the box for “Enable Wireless Connection”.
3. Select the wireless network you want to use or set up.
4. Press **Connect** from the bottom of the Configuration tool. If prompted, enter the correct settings for this wireless network.

*NOTE: If the WLAN fails to connect, review and/or recreate the Wireless connection on the Security Tab.*

## Network and Spooler Status Icons

The following icons identify network and spooler statuses:

Table 13-85: Network and Spooler Status Icons

Network and Spooler Status Icons				
Ethernet Active 	Ethernet Error 	Ethernet Active Spooler Active 	Ethernet Active Spooler Error 	Mobile 
Mobile Error 	Mobile Bluetooth 	Mobile Wifi 	Spooler Active 	Spooler Active Error 
Spooler Inactive 	Spooler Inactive Error 	Wifi 1 Bar 	Wifi 2 Bars 	Wifi 3 Bars 
Wifi 4 Bars 	Wifi Alert 	Wifi Spooler Active 	Wifi Spooler Error 	Wifi Error 

## Adding a Wireless Network

To add a WLAN profile (even for a network which is not yet available),

1. Press Utility--> Connectivity--> TCP/IP--> Wireless Network--> Security. The Wireless Network Configuration tool appears. Available Wireless Networks appear.
2. Select the **Security** tab.
3. Select **Add...**
4. Obtain and enter the correct information for each wireless network setting:

- a. Enter a Network Name (SSID), pre-select the security type, then press OK.

A new window appears so you can enter the settings for this network.

- b. On the connection page, check the appropriate boxes based on how you want the LOGIQ Totus to connect to this network.

The LOGIQ Totus attempts to connect to available wireless networks based on the options you enable. If multiple networks are available, connection attempts begin with the network appearing topmost on the list.

- c. Select the Security page.
- d. Select the Security Type from the available options.

**NOTE:**

*Dialog boxes vary, depending on the Security Type selected.*

- e. Select the Encryption Type from the available options.
- f. For Personal networks, enter the Network key.

### Adding a Wireless Network (continued)

- g. For Enterprise networks, choose the network authentication method and press Settings.

Detailed settings for Enterprise networks are complex and must be correct for the connection to succeed. Ensure you have all the required information/settings and work with your site's IT Network Administrator as needed.

*NOTE: Credentials must be entered at this time. The LOGIQ Totus does not support automatic prompting for user credentials.*

- For Microsoft PEAP networks, press Advanced and enter User authentication credentials (username and password).
- For Cisco networks, enter user credentials in the PEAP Properties dialog after pressing the Settings button.

*NOTE: IMPORTANT: User credentials are not validated until you attempt to connect to the network.*

- h. When you have correctly entered all required settings, press OK in the Wireless Network Properties dialog.

Your settings will be validated and you may be prompted about certain settings which are not recommended or supported.

Examples: "Automatic connection to unencrypted networks is not recommended. Reminder to enter user credentials for Enterprise networks."

- i. If changes are necessary, press Customize. Make corrections, then press OK. Settings will be validated again.

5. After you have filled in all the required information, press **OK**. To cancel adding this profile, press **Cancel**.

### Removing a WLAN

To remove a WLAN profile (even for a network which is not available),

1. Press Utility--> Connectivity--> TCP/IP--> Wireless Network--> Security. The Wireless Network Configuration tool appears. Available Wireless Networks appear.
2. Select the **Security** tab.
3. Select **Remove**.

## Customizing Wireless Network Settings

To customize an existing WLAN profile,

1. Press Utility--> Connectivity--> TCP/IP--> Wireless Network--> Configuration. The Wireless Network Configuration tool appears. Available Wireless Networks appear.
2. Select the **Security** tab.
3. Select **Customize...**
4. Obtain and enter the correct information for each wireless network setting:
  - a. Enter a Network Name (SSID), then press OK.  
A new window appears so you can enter the settings for this network.
  - b. On the connection page, check the appropriate boxes based on how you want the LOGIQ Totus to connect to this network.  
  
The LOGIQ Totus attempts to connect to available wireless networks based on the options you enable. If multiple networks are available, connection attempts begin with the network appearing topmost on the list.
  - c. Select the Security page.
  - d. Select the Security Type from the available options.  
*Dialog boxes vary, depending on the Security Type selected.*
  - e. Select the Encryption Type from the available options.
  - f. For Personal networks, enter the Network key.

**NOTE:**

## Customizing Wireless Network Settings (continued)

- g. For Enterprise networks, choose the network authentication method and press Settings.

Detailed settings for Enterprise networks are complex and must be correct for the connection to succeed. Ensure you have all the required information/settings and work with your site's IT Network Administrator as needed.

*NOTE: Credentials must be entered at this time. The LOGIQ Totus does not support automatic prompting for user credentials.*

- For Microsoft PEAP networks, press Advanced and enter User authentication credentials (username and password).
- For Cisco networks, enter user credentials in the PEAP Properties dialog after pressing the Settings button.

*NOTE: IMPORTANT: User credentials are not validated until you attempt to connect to the network.*

- h. When you have correctly entered all required settings, press OK in the Wireless Network Properties dialog.

Your settings will be validated and you may be prompted about certain settings which are not recommended or supported.

Examples: "Automatic connection to unencrypted networks is not recommended. Reminder to enter user credentials for Enterprise networks."

- i. If changes are necessary, press Customize. Make corrections, then press OK. Settings will be validated again.

5. After you have filled in all the required information, press **OK**. To cancel adding this profile, press **Cancel**.

## Setting an IP Address

To set an IP Address (Static or Dynamic), select Utility--> Connectivity--> TCP/IP--> Properties.

## **Refreshing a WLAN**

Refreshes the list of available Wireless Networks. To refresh the Wireless Network,

1. Press Utility--> Connectivity--> TCP/IP--> Wireless Network--> Configuration. The Wireless Network Configuration tool appears. Available Wireless Networks appear.
2. Press Refresh from the bottom of the Configuration tool.

## **Managing Connectivity to a Wireless Network**

You can control which wireless networks can be connected to and which networks are preferred over other networks.

- Networks appearing on the Security page, Preferred Wireless Networks list are listed in decreasing preference. The network listed at the top of the list is the most preferred, and therefore the most likely to get connected. The network listed at the bottom of the list is the least preferred, and therefore the least likely to get connected.
- Networks with the check box unchecked for automatic connection will never connect unless you manually press the Connect button.
- Non-broadcasting networks will never connect unless the corresponding checkbox is checked; or, you manually press the Connect button.
- Once connected to a network, the system will not automatically switch over to a more preferred network unless the check box is checked.

## **Monitoring the WLAN**

If there are wireless network communication problems, you can monitor the wireless network events.

To monitor Wireless Networking events,

1. Press Utility--> Connectivity--> TCP/IP--> Wireless Network--> Configuration. The Wireless Network Configuration tool appears. Available Wireless Networks appear.
2. Select the Monitor Tab.

### WLAN Diagnostics

If the wireless network is connected, you can run diagnostics to determine how well, or poorly, the network itself is working. The diagnostic information displayed can help pinpoint causes of networking problems. Tests which pass are shown in green; tests which fail are shown in red.

To run diagnostics for the Wireless Network,

1. Press Utility--> Connectivity--> TCP/IP--> Wireless Network--> Configuration. The Wireless Network Configuration tool appears. Available Wireless Networks appear.
2. Select the Diagnostics Tab.
3. Select **Run Diagnostics**.

### Repairing the WLAN

Occasionally you may need to repair a WLAN that has lost its connection to the LOGIQ Totus. To repair the Wireless Network,

1. Press Utility--> Connectivity--> TCP/IP--> Wireless Network--> Configuration. The Wireless Network Configuration tool appears. Available Wireless Networks appear.
2. Select the Diagnostics Tab.
3. Select **Repair**.

**NOTE:** *DO NOT cancel the Repair operation after you have selected to repair the Wireless LAN connection.*



## Available WLAN Channels

The available WLAN channels show availability of wireless connect points that the scanner can talk to. Each channel supports a finite number of users and has limited signal strength. This may effect the ability to connect, the throughput and the connection dropping out.

To check the available WLAN channels,

1. Press Utility--> Connectivity--> TCP/IP--> Wireless Network--> Configuration. The Wireless Network Configuration tool appears. Available Wireless Networks appear.
2. Select the Properties Tab.
3. Select **Available Channels...**

## Disconnecting from the WLAN

To disconnect from the Wireless Network,

1. Press Utility--> Connectivity--> TCP/IP--> Wireless Network--> Configuration. The Wireless Network Configuration tool appears.
2. Select **Disconnect**.

# Tricefy Uplink

## Introduction

Tricefy is a cloud-based image viewer and a platform to archive, collaborate, and share. The Tricefy DICOM server may be used in the way any DICOM server on the product may be used, i.e., Print keys, Send To, etc. The corresponding DICOM destinations can be used via the Print keys. An internet connection is necessary for uploading data to Tricefy.

**NOTE:** *To engage in service offerings with Tricefy, confirm that your country has entered into an agreement with Tricefy.*

**NOTE:** *Tricefy DOES NOT support IPV6 and cannot be used in conjunction with Tricefy.*



Figure 13-258. Tricefy Account

## **Introduction (continued)**

The tab displays a general info area with a short description of Tricefy, an uplink ID, and an info badge for how to configure Print buttons on system setup (only available when an account is active). Furthermore the account area displays controls and information about the Tricefy account while the test connection area enables you to test a connection and gives detailed information about it.

# Uploading Exam Information to the Tricefy Cloud

## Enabling Tricefy

1. To enable Tricefy, fill out the information on Utility -> Connectivity -> Special Devices -> Tricefy. As soon as this option is enabled, relevant Tricefy items are displayed (e.g. email text field, Activate button,.... and options within the system setup to share or store data to Tricefy via the print key or status bar icons (described below).
2. Enter your email address to register and click Activate account. (If you want to deactivate an active account, click Deactivate account.)
3. Depending on the account status, different account information is displayed:
  - green badge containing the account info, email address, account name, customer name and account status- account activated
  - blue badge - information about a disconnected account
  - orange badge - connection to Tricefy™ failed (due to timeout,...)
4. For testing the connection click Activate. Depending on the connection status, different information is displayed:
  - green badge - connection ok
  - blue badge - instruction for testing the connection (only displayed as long as Activate is not pressed)
  - orange badge - connection failed
5. Upon success activation, you will receive an Uplink ID.

**NOTE:** *When tricefy is successfully activated an image storage and Query//Retrieve service will be created with port number 8104.*

## Configuring Tricefy

1. Set up the Tricefy Service via Utility > Connectivity > Service. Set the DICOM Image Storage and Query/Retrieve ports to Port 8104. Refer to the DICOM sections in this chapter and in Chapter 10 for more information. Verify the service.
2. Set up a Dataflow for Tricefy. Refer to the DICOM sections in this chapter and in Chapter 10 for more information. Verify the Dataflow.
3. Configure the Print buttons via Utility > Connectivity > button. Refer to the DICOM sections in this chapter and in Chapter 10 for more information. Verify the Print button(s).

### Using Tricefy

You can send a patient's exam to the Tricefy Image Storage service via the Exam Tab.

1. Select the patient's exam and press the Send To button. Select the Tricefy Image Storage service. Press OK.

You can check the job status by pressing F4 (DICOM Job Spooler).









You can confirm the exam is on the Tricefy Server via a web browser. Navigate to <https://tricefy4.com>. Log in with your account information. The patient and image(s) you sent are on the Tricefy cloud.

2. To Query patient information on the Tricefy cloud, on the Patient page, go to the Data Transfer page. Select the Q/R radial button, then press Query. A list of patients on the Tricefy cloud is displayed. Select the patient you want to retrieve, then select Transfer.

## Tricefy Icons

Tricefy icons are explained below.

Table 13-86: Tricefy Icons

Connection Icons	Store Icons	Share Icons
<p>Connected to Tricefy. Ready to Store and Share</p> 	<p>Upload Image to Tricefy</p> 	<p>Share Image with Patient via Tricefy.</p> 
<p>Disconnected from Tricefy.</p> 	<p>Upload CINE to Tricefy</p> 	<p>Share CINE with Patient via Tricefy.</p> 
<p>Registration incomplete.</p> 	<p>Upload 4D Image to Tricefy</p> 	
	<p>Upload 3D Image to Tricefy</p> 	

## Tricefy Activation

Refer to Chapter 10 for more information.

# Device Mgmt

## Overview

Device Mgmt is a remote device management tool that enables bi-directional management capabilities on the device.

Device Mgmt allows Cloud management of system preset configurations to a fleet of systems on network, as well as one to one system preset configuration Cloud backup and restore.

*NOTE: For Cloud operation please refer to Device Mgmt online user manual after sign-up at <http://AVURI.gehealthcare.com/signup>*

## Device Mgmt Fleet Management



Figure 13-259. Device Mgmt Fleet Management

An account on the Cloud with access to Device Mgmt is required.

1. Upload preset configurations for fleet of systems
2. On the Cloud, assign configuration to fleet of systems
3. Receive installation notification (on each system in the fleet)
4. Install preset configuration (on each system in the fleet)



## Device Mgmt Cloud Backup/Restore

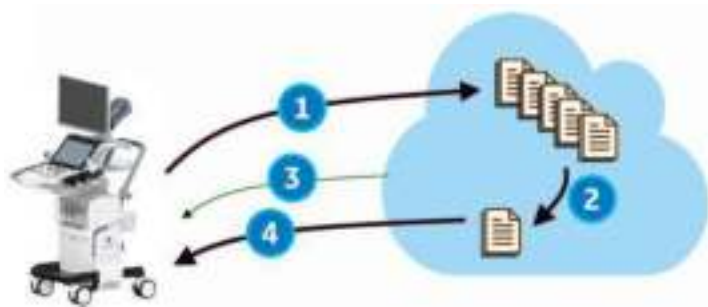

Figure 13-260. Device Mgmt Cloud Backup/Restore

An account on the Cloud with access to Device Mgmt is required.

1. Backup to the Cloud
2. On the Cloud, assign configuration to restore to originating system
3. Receive restore notification
4. Restore on system

**NOTE:** *Restoring to a system other than the originating system is not allowed.*

**NOTE:** *Cloud Backup jobs are queued and processed in the background and do not disturb user operation.*

## Upload For Fleet and Manual Backup (Cloud Backup)

To upload preset information from the master system for the fleet:

1. Go to Utility > System > Backup/Restore.
2. Select **Upload For Fleet**.
3. Set Comment to identify configuration on the Cloud.
4. Press **Upload**.
5. The system displays the result in the status bar and the Notification dialog.



Figure 13-261. Upload For Fleet

**NOTE:** Upload For Fleet can share the preset configuration across Fleet, while Cloud Backup can restore only to the originating device.

**NOTE:** Upload For Fleet and Cloud Backup copies all “User Defined Configuration” to the Cloud.

**NOTE:** The user must have Device Mgmt Administration Group Rights to begin the Upload For Fleet.

## Backup Automatically (Local and Cloud Backup)

1. Check **Backup Automatically** under Local and Cloud Backup.
2. Press **Save**.
3. User Defined Configuration files are automatically backed up to Cloud when configuration is changed and then saved.

*NOTE: Cloud Backup requires activation. Even if it is not activated, files will automatically copy to Local Backup.*

*NOTE: If the administrator (ADM) login password is reset and reconfigured, a manual backup should be created to save the ADM password change.*

## Manual Backup (Cloud Backup)

To backup user defined configuration for Cloud manually:

1. Go to Utility > System > Backup/Restore.
2. Select **Cloud** under Backup To/Restore From.
3. Check **User Defined Configuration** under Backup
4. Press **Backup** under Backup.
5. Set Comment to identify fleet configuration on the Cloud.
6. Press **Backup**.
7. The system displays the result in the status bar and Notification dialog.

### **Assign Configuration to Fleet or to the Device (on Cloud)**

Installation assignment for configuration files uploaded to the Cloud is performed on the Cloud (not on the device).

- Upload For Fleet - Configuration files can be assigned to the Fleet (group of devices).
- Cloud Backup - Configuration files can be assigned only to the device where they were backed up from.

*NOTE: Configuration files that have been uploaded to the Cloud with Upload For Fleet and Cloud Backup are displayed in different lists on the Cloud.*

## Receive Installation Notification

When a configuration file is assigned for installation from the Cloud, the system displays a pop-up dialog notifying that a download is available by selecting the download icon in the status bar. The pop-up appears only at the following operation points, to avoid interrupting an exam:

- New Patient/End Current Patient
- Unlock Lock-screen
- Log off/Log on

The download icon also appears in the status bar.

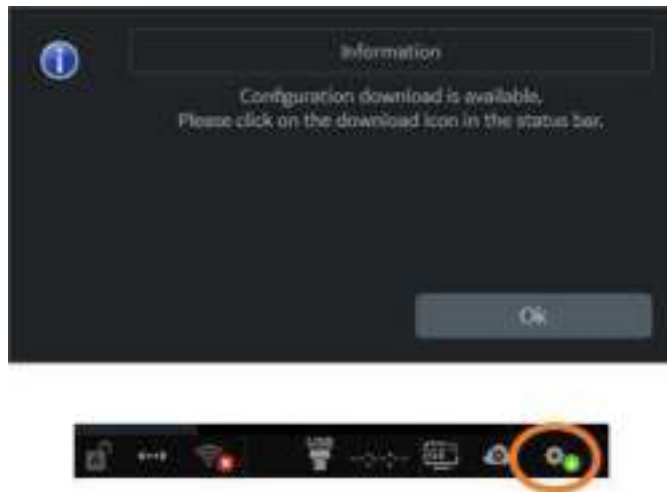

Figure 13-262. Notification Dialog and Installation Icon

**NOTE:** *The user must have Configuration Group Rights to begin the configuration download and installation. If the user does not have Configuration Group Rights, a Warning message is displayed (see Figure 13-265).*

## Installation Dialog



Figure 13-263. Installation Icon

Selecting the Installation Icon in the status-bar initiates the Installation Dialog with three options:

- Install
- Delay Install Until Shutdown
- Download Only
- Discard

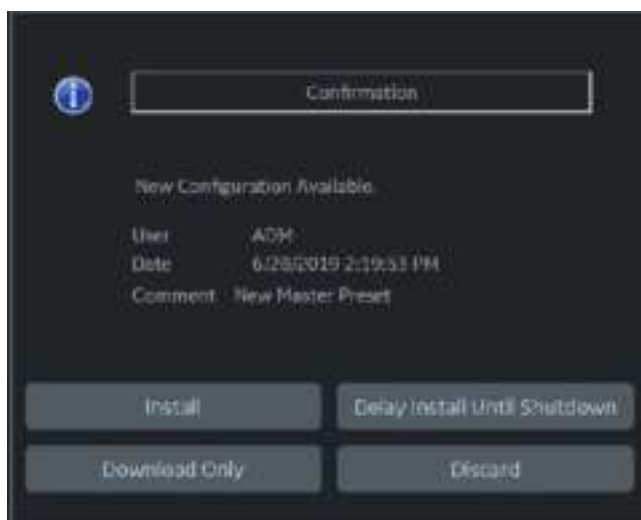

Figure 13-264. Installation Dialog

**NOTE:** *Discard and Download Only are available only when the Installation is marked as optional on the Cloud. Otherwise, no Discard or Download Only buttons appear in the Installation Dialog.*

## Installation Dialog (continued)

**NOTE:** *Installation requires Advanced Configuration Group Rights. If the user does not have Advanced Configuration Group Rights, selecting the Installation Icon displays a Warning.*

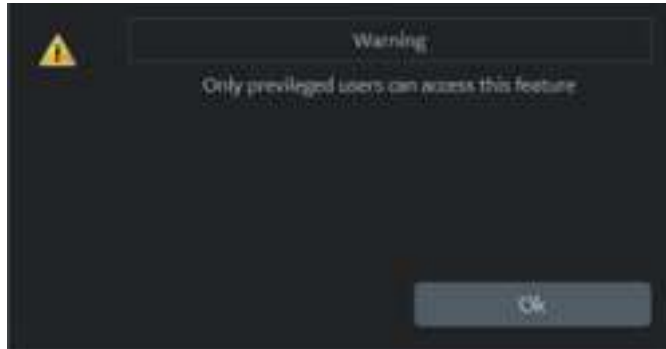

Figure 13-265. Advanced Configuration Group Rights Warning

### Install

1. Select the Installation Icon in the status bar.



Figure 13-266. Installation Icon

2. Select **Install**.

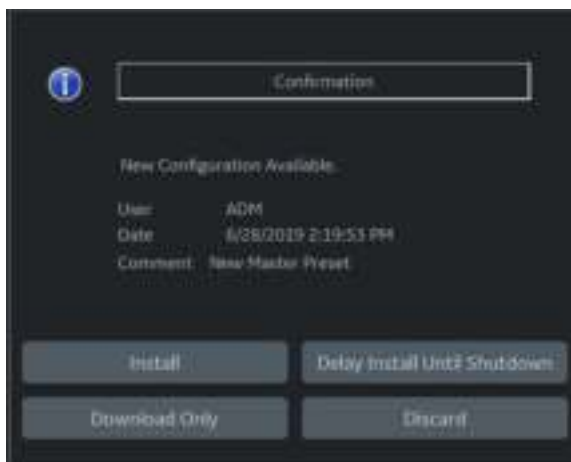

Figure 13-267. Install

3. Select **Continue** to acknowledge. The configuration installation begins and the result is displayed.



Figure 13-268. Continue Install



**Install (continued)**

4. Select OK to restart.



Figure 13-269. Select to Restart System

## Delay Install Until Shutdown

1. Select the Installation Icon in the status bar.



Figure 13-270. Installation Icon

2. Select **Delay Install Until Shutdown**.

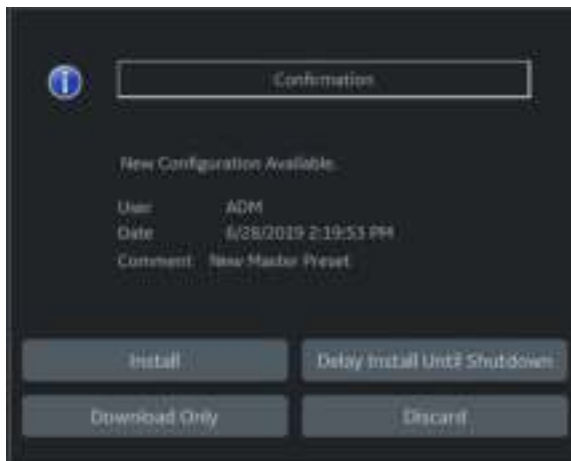

Figure 13-271. Select Delay Install Until Shutdown

3. Select **Continue** to acknowledge. Continue the exam.



Figure 13-272. Continue Delay Install Until Shutdown

**NOTE:** Icon changes to "Delay Install Until Shutdown".



Figure 13-273. Delay Install Until Shutdown Icon

## Delay Install Until Shutdown (continued)

4. Press Power button to display Exit dialog.
5. Select **Shutdown**. Installation begins automatically and the result is displayed.



Figure 13-274. Shutdown to Begin Installation

6. When installation is complete the system will shutdown automatically.

**NOTE:** *If the installation fails for any reason, a notification will be displayed after the system restarts.*

### Discard

1. Select the Installation Icon in the status bar.



Figure 13-275. Installation Icon

2. Select **Discard**.

**NOTE:** *Discard is available only when the Installation is marked as optional on the Cloud. Otherwise, no Discard button appears in the Installation Dialog.*

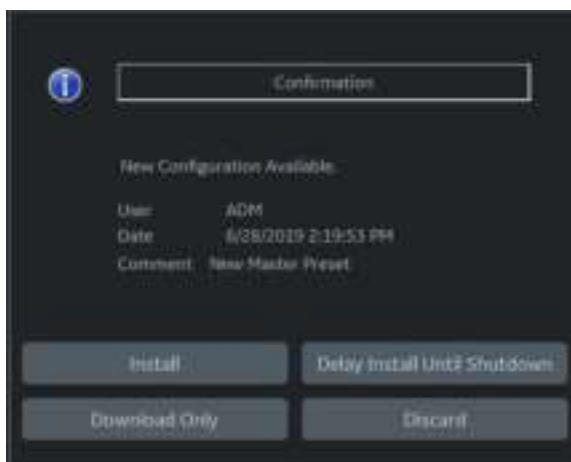

Figure 13-276. Select Discard

3. Select **Continue** to acknowledge.



Figure 13-277. Continue Discard

## Detailed Restore from Cloud

### Download Only from Cloud

**NOTE:** Because Download from Cloud runs in the background, the download is already completed when selecting Install icon.

1. Select the Install icon.



Figure 13-278. Install icon

2. Select **Download Only** which creates local backup of the preset.

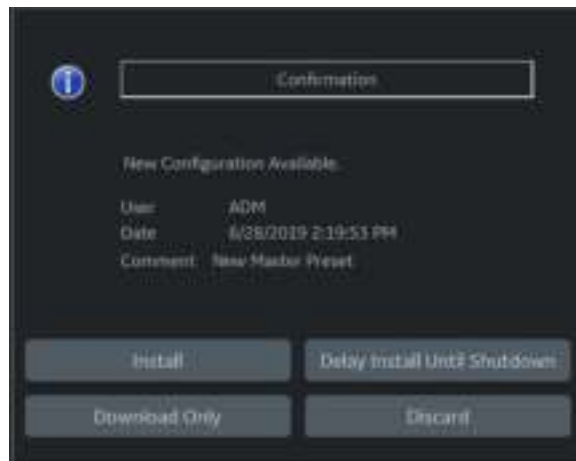

Figure 13-279. Select Download Only

**NOTE:** If installation of the preset is set as Mandatory, then the dialog enables only the Install or Delay Install until Shutdown.

### Download Only from Cloud (continued)

3. Information displays when the download is completed.

Download completed. To install the downloaded configuration, go to Utility -> System -> Backup/Restore and select Cloud as the Location.



Figure 13-280. Download Completed

### Detailed Restore From Cloud

1. Go to Utility > System > Backup/Restore.
2. Select **Cloud** as Location of Restore From
3. Select categories and press **Detailed Restore** under Detailed Restore of User Defined.

### Restore from Cloud

1. Go to Utility > System > Backup/Restore.
2. Select **Cloud** as Location of Restore From
3. Select categories and press **Restore** under Restore.

## Cancel a Failed Job

1. Select Notification Icon.



Figure 13-281. Notification Icon

2. The notification dialog displays on the monitor. Select a failed job and press **Cancel Selected Job**.



Figure 13-282. Select Failed Job

3. Select **Continue** on the dialog.



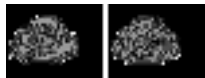



Figure 13-283. Warning Dialog

**NOTE:** Successful jobs are removed automatically after a period of time. Failed jobs are deleted automatically after 2 weeks.

## Icon and Notification

One of the following icons is displayed in the status bar:

Table 13-87: Device Mgmt Icons

Icon	Description
	Activated/Not Activated
	Unread/Read Error message
	Unread/Read Warning message
	Unread/Read information

When there is a notification, clicking on the icon displays a message (see Icon Message example below).



Figure 13-284. Icon Message



# Smart Device Apps

## LOGIQ Apps

Smart Device LOGIQ Apps are available for Android devices (both a phone and tablet) via Bluetooth: LOGIQ Remote Control App and LOGIQ Photo/Barcode Reader App.



Figure 13-285. Smart LOGIQ Apps Devices

**NOTE:** *The communication between the LOGIQ Apps and the ultrasound system is Bluetooth which is a wireless, secure transmission. At no time is patient data stored on the device hosting the LOGIQ Apps. For the LOGIQ Photo App, photos are never written to a file, but rather directly transferred to the LOGIQ ultrasound system. Once on the ultrasound system they can be included with the diagnostic images sent to the reviewing/reading physician.*

## LOGIQ Apps (continued)



**DANGER**

DO NOT use the Smart Device Apps if the patient has a life-sustaining device, such as a pacemaker or defibrillator. Failure to follow this instruction could lead to interference with patient electronic device(s).

*NOTE: DO NOT use the USB Ports on the LOGIQ Totus to charge LOGIQ Apps devices as these devices are not approved devices to connect to a medical device.*

## Connecting the Device

To link to the device:

Table 13-88: Linking the Device to the LOGIQ Totus



Steps	On LOGIQ Totus	On Device
<p>1. Press the Mobile Icon on the LOGIQ Totus that's located on the display.</p> 		

Table 13-88: Linking the Device to the LOGIQ Totus (Continued)



Steps	On LOGIQ Totus	On Device
<ol style="list-style-type: none"> <li>2. On the LOGIQ Totus, the QR code appears on the display.</li> <li>3. On the device, press the LOGIQ Remote App.</li> </ol>		
<ol style="list-style-type: none"> <li>4. Follow the instructions on the device.             <ol style="list-style-type: none"> <li>a. Press "Connect."</li> <li>b. Scan the QR Code with the device.</li> </ol> </li> </ol>		

Table 13-88: Linking the Device to the LOGIQ Totus (Continued)



Steps	On LOGIQ Totus	On Device
<p>5. Place the device in front of the LOGIQ Totus as directed. "Scan QR code with your mobile application to pair and connect."</p> <p>The LOGIQ Totus and the device are now ready to pair.</p>		
<p>6. The device displays the Bluetooth pairing request, "Confirm passkey is ##### to pair with the LOGIQ Totus." Press OK.</p>		

Table 13-88: Linking the Device to the LOGIQ Totus (Continued)



Steps	On LOGIQ Totus	On Device
<p>7. The Bluetooth icon on the LOGIQ Totus is now paired to the device.</p> <p>8. The LOGIQ Remote application appears on the device. The Phone App and Tablet App displays are shown to the right.</p>		
<p>To switch to the LOGIQ Photo App, press the Camera icon located on the top of the remote device's display.</p> <p>Note: The Camera Icon only appears if LOGIQ Photo App is already installed.</p>		

Table 13-88: Linking the Device to the LOGIQ Totus (Continued)

Steps	On LOGIQ Totus	On Device
<p>To disconnect the LOGIQ Totus from the device, click on the “Bluetooth Connected to the Device” icon on the bottom of the display and select to disconnect. Or, You can press “Disconnect” on the Device.</p>		
<p>To Unpair a Device from the LOGIQ Totus, press “Unpair Bluetooth Devices” via Utility&gt; Connectivity&gt; Miscellaneous&gt; LOGIQ Apps.</p>		

To completely break the association between the LOGIQ Totus and the device (unpair the device from the LOGIQ Totus):

1. Access the Utility-> Connectivity-> Miscellaneous screen.

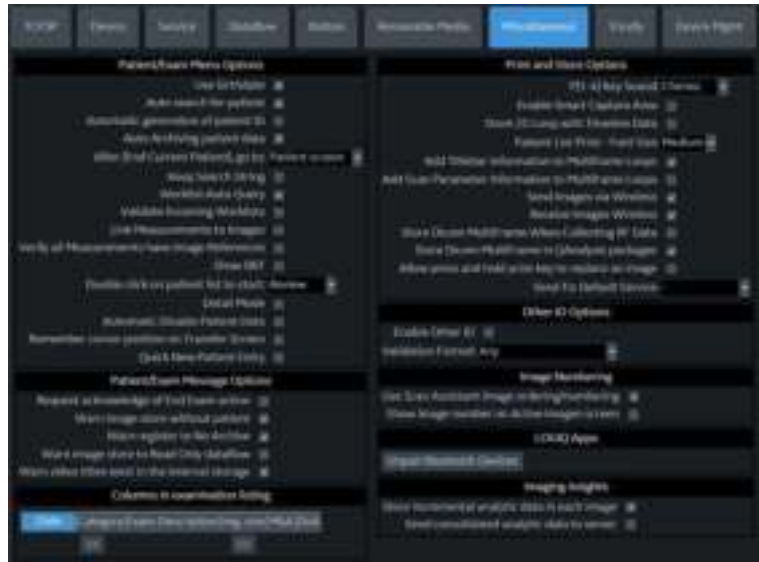

2. In the LOGIQApps section, select **Unpair Bluetooth Devices**.

### Assigning LOGIQ Apps to a User Defined Key

To assign LOGIQ Apps to a User Define key, select “LOGIQ Apps” to a User Defined key (restart needed)” via Utility> System> User Configurable Key.





Figure 13-286. Assign LOGIQ Apps to a User Defined Key

### Using the Apps

Table 13-89: Using Smart Device LOGIQ Apps

Tablet/Phone Remote Control and Photo/Barcode reader Apps
<ol style="list-style-type: none"><li>1. LOGIQ Remote Control App</li><li>2. LOGIQ Photo/Barcode Reader App</li></ol>
A screenshot of a tablet interface with a blue background. Two app icons are shown in the center, labeled with the numbers '1' and '2' in white circles. The icon '1' is a blue square with a white camera lens, and the icon '2' is a blue square with a white camera lens. The bottom of the screen shows a dock with several app icons.

Table 13-89: Using Smart Device LOGIQ Apps (Continued)

Tablet/Phone Remote Control and Photo/Barcode reader Apps	
<p>LOGIQ Remote Control App:</p>  <p>Via the Tablet LOGIQ Remote Control App, you will be able to adjust the following controls: Depth, Gain (B-Mode, Color Flow Mode, PW Mode), Left/Right, Measure, Comment, Clear, Trackball, Freeze, Store, Color Flow Scale, and Cursor.</p>  <p>Via the Phone LOGIQ Remote Control App, you will be able to adjust the following controls: Activate PW, CF, or B-Mode, adjust the Cursor, Freeze the image, and send images to the P1 control.</p>	<p>Photo/Barcode Reader App</p>  <p>You can use the LOGIQ Photo App to capture photos that will go to the patient's exam and to use as a barcode reader to scan in patient exam information.</p> <p>Note: The photo does not go directly into the exam; instead the image must be stored from the LOGIQ Totus.</p> <p>Note: The barcode scanner scans the barcode into the Patient ID field on the Patient menu.</p>



## Barcode - Input Mode

### Off

Enter the Patient ID using the keyboard.

### Patient ID

Scan the barcode for the Patient ID or enter the Patient ID using the keyboard.

### Complexation

Patient demographics can be entered by scanning the barcode, or manually, using the keyboard.

To enter patient demographics manually with the keyboard (instead of the barcode), select Cancel.

1. Enter a string in the Input Data field by scanning from a barcode or typing with the keyboard.
2. Scan a sample barcode. The following items can be included in the barcode:
  - Patient ID
  - First Name, Last Name, Middle Name
  - Birth Year, Month, Day

**NOTE:**

*The character length for Year is four characters, Month is two characters and Day is two characters. The Year, Month and Day should always be provided together.*

- Gender

### Complexation (continued)

- Configure the Start and End position for each item.

**NOTE:** *If the barcode does not contain information for an item, configure the Start and End position as "0."*

For example, if the scanned barcode is "000001LastNameFirstName191990101F," the configuration and results display as seen in Figure 13-287.

The screenshot displays a software interface for barcode configuration. At the top, there is a navigation bar with options like 'Home', 'Report', and 'Data Assistant'. Below this is a 'Barcode' section with an 'Input Mode' dropdown set to 'Patient'. Under 'Input Mode', there are four radio buttons: 'Patient ID', 'Complexation', 'Birth Date', and 'Accession 2'. The 'Complexation' option is selected. Below the input mode, there is an 'Input Data' field containing the barcode '000001LastNameFirstName191990101F'. The main area is divided into two columns. The left column lists fields with their corresponding positions in the barcode: Patient ID (1-2), Other ID (3-4), Last Name (5-10), First Name (11-25), Middle Name (26-31), Birth Year (32-35), Birth Month (36-37), Birth Day (38-39), Gender (40-41), and Photo (42-43). The right column shows the extracted data for each field: Patient ID (00), Other ID (00), Last Name (LastName), First Name (FirstName), Middle Name (MiddleName), Birth Year (1990), Birth Month (10), Birth Day (01), Gender (F), and Photo (F). At the bottom center, there is a 'Save' button.

Figure 13-287. Barcode Configuration Page Example

# Digital Expert

## Digital Expert Remote Training

Digital Expert is a purchasable option which enables remote training between users and the GE HealthCare Clinical Applications team, through scheduled and real-time sessions. Digital Expert is a self-contained, app-based companion solution, designed to pair with GE HealthCare medical devices. Digital Expert utilizes Intelehealth software for remote connectivity.

*NOTE: This tool is not for clinical diagnostics purposes.*

Digital expert also enables customer to customer Enterprise Collaboration, where users can connect with each other within their own network. This provides on-demand access for guidance and consultation for clinicians from in-house experts.

Refer to the user manual included with Digital Expert for information on setting up and using Digital Expert.

# Service and Applications Support

## GE HealthCare Connect Guide

The GE HealthCare Connect Guide helps the user follow the necessary steps to setup the InSite ExC connectivity. To use the GE HealthCare Connect Guide to begin the GE HealthCare Backoffice Connectivity Troubleshooting wizard:

1. Select the Insite icon at the bottom of the display screen to open up the InSite ExC Icon Menu.



Figure 13-288. InSite ExC Icon Menu with Connection Unconfigured

2. Select GE HealthCare Connect Guide from the menu to open the GE HealthCare Backoffice Connectivity Troubleshooting wizard.



## GE HealthCare Backoffice Connectivity Troubleshooting Wizard

(continued)

3. **Agent Proxy Configuration** - Ensure proxy configuration details and credentials are accurate. Edit if necessary, save changes and select Next.



Figure 13-291. Agent Proxy Configuration

4. **DNS Configuration** - Ensure DNS is configured correctly for the system. Select Next.



Figure 13-292. DNS Configuration

## GE HealthCare Backoffice Connectivity Troubleshooting Wizard

(continued)

5. Network Firewall - Ensure the network firewall in the facility is configured correctly to allow GE HealthCare InSite communication. Select Next.



Figure 13-293. Network Firewall

6. Summary Page - The Summary page will check the agent configuration and connection status for all configuration steps. When the process completes (may take up to five minutes) the status for each step is listed as “OK” or “Not OK.” If any step is reported as “Not OK” select the step from the menu on the left and correct the information on that screen, then proceed to the Summary page again for a connection status update.



Figure 13-294. Summary Page

### Support Requests

#### InSite ExC

InSite ExC is your direct link with a GE HealthCare Online Service Engineer or Applications Support Engineer by creating a Request for Service via the InSite ExC link at the bottom of the display screen.

*NOTE: The Insite connection must already be configured with the GE HealthCare backoffice for the InSite ExC Menu to appear. See 'GE HealthCare Connect Guide' on page 13-516 for more information.*



Figure 13-295. InSite ExC Menu

#### Types of InSite ExC Service

1. **Contact GE HealthCare** - Opens a service dispatch with GE HealthCare Service.
2. **Connect Clinical Lifeline** - Sets the system in a state of readiness for Virtual Console Observation.
3. **Connect To GE HealthCare** - Initiates a connection to the GE HealthCare Backoffice.



## Initiating a Request for Service (RFS)

To initiate an RFS:

1. Position the Windows pointer on top of the GE HealthCare InSite ExC icon at the bottom of the display.
2. Press the Right Trackball Set Key. Select Contact GE HealthCare. This opens the RFS screen which sends a service dispatch directly to the Remote Service or Applications Team after you fill in the following information:
  - Last Name, First Name, Phone Number
  - Select correct Problem type
  - Choose Problem area
  - Type in Problem description
3. After you have completed filling in all of this information, press **Send** to initiate the Request for Service.

You can confirm if your RFS has been sent as well as RFS's automatically sent by the system. The LOGIQ Totus can automatically submit a Request for Service. These are displayed on the Machine Queue.

In addition, you can use the Users screen to identify your institution's point of contact for service dispatches.

### Initiating a Technical or Clinical Support Request

When the Remote Applications or Service person reaches you, they will ask you to click on the InSite icon and choose either Connect to GE HealthCare or Connect Clinical Lifeline,

1. Position the Windows pointer on top of the GE HealthCare InSite ExC icon at the bottom of the display.
2. Press the Left Trackball Set Key. This opens the following pop-up:
  - Connect to GE HealthCare,
  - Connect Clinical Lifeline, or
  - Cancel
3. Select the option the GE HealthCare representative asks you to select.

**NOTE:** *Selecting Connect to GE HealthCare changes the polling time from 15 minutes to 15 seconds so that your call can be answered as quickly as possible. Selecting Connect Clinical Lifeline also activates disruptive mode.*

**Initiating a Technical or Clinical Support Request (continued)**

InSite ExC icons appear differently, depending on their state:

Table 13-90: InSite Icons

GE HealthCare InSite - Connected - Disruptive Mode - Enabled	
GE HealthCare InSite - Connected - Disruptive Mode - Disabled	
GE HealthCare InSite - Idle - Disruptive Mode - Enabled	
GE HealthCare InSite - Idle	
GE HealthCare InSite - Not Configured  For more info on the configuring the connection to the GE HealthCare Backoffice, see 'GE HealthCare Connect Guide' on <i>page 13-516</i> .	

### InSite ExC Definitions

Here are definitions for the different InSite ExC states:

**Virtual Console Observation (VCO).** Allows Technical Support to control LOGIQ Totus functionality remotely.

**Disruptive.** Allows GE HealthCare's Technical Support person to connect to your system via VCO, to run diagnostics directly on your LOGIQ Totus system, and to collect system logs. When the system is in Disruptive Mode, the icons are red. There are two disruptive states. If you see a telephone with a clock, then the system is in Disruptive, Not Connected Mode. If you see a telephone with GE HealthCare, then the system is in Disruptive, Connected Mode.

**Non-Disruptive.** Allows GE HealthCare's Technical support person to look around on your system, but cannot perform any service-related functions, depending on whether InSite has connected or not connected. There are two Non-Disruptive states. If you see a black and white icon, InSite ExC is activated, but not open for Technical Support access. If you see a yellow icon, InSite ExC is activated and the Technical Support person can look around on your system, but cannot perform any service-related functions.

**Connected.** InSite ExC is connected.

**Not Connected.** InSite ExC is not connected.

*NOTE: When Disruptive mode has been activated or a diagnostic has been run, the message, "Service Mode is Activated. Reboot required before patient use" appears in red at the bottom of the display. It is recommended that you reboot the system before use. Make sure you disable disruptive mode before rebooting or the message will not be cleared.*

### Exiting InSite ExC

To exit InSite ExC:

1. The GE HealthCare Technical Support person will exit Disruptive Mode and VCO, then ask you to reboot your system.
2. Reboot your LOGIQ Totus system before patient use.

For more information on InSite ExC refer to the LOGIQ Totus Basic Service Manual.

# Service Desktop

## Overview

The Administrator (and others granted the “Access Service Desktop” privilege) can access the Service Desktop to:

- Access the Service Home Page.
- Perform the following Utilities
  - Change Password
  - Data Transfer
  - Delete Files
  - SSA License
  - Gather Logs
  - View Third Party Licenses
  - Disruptive Mode Utility
- View Installed Options
- InSite Agent Configuration



Figure 13-296. Service Desktop

For more information on Service Desktop, refer to the LOGIQ Totus Basic Service Manual.

## Accessing the Service Desktop

1. Select **Utility** and go to Page 2 of the Utility Menus.
2. Select **Service**.

# Battery Power Mode

## Overview

The LOGIQ Totus supports either the 3 pack battery Option or the 6 pack Battery option.

*NOTE: Only GE HealthCare Service personnel have access to the batteries. Please contact the technical service department or your local GE HealthCare representative for replacement. Also, replace all battery packs at the same time to avoid confusing used and new battery packs.*

## Scan on Battery Option (ScoB)

### Overview

Scan on Battery Option allows the user to scan using battery power (AC unplugged).

While running on the battery power, the LOGIQ Totus can scan or perform post-processing and switch to Power Saving Mode.

With a fresh battery that is fully charged, the LOGIQ Totus stays powered for approximately 1h in 3 battery pack / 2h in 6 battery pack.

### Before starting Scan on Battery



#### CAUTION

Verify battery functionality is available by the battery icon in the status area.

It is imperative to confirm the battery icon indicator before unplugging power cord from wall power.

Full charging condition is recommended for Battery Power Mode. Unplugging system from wall power with <30% battery could result in a sooner than expected shutdown warning.



#### CAUTION

It is recommended to complete the following before unplugging the AC cable.

- Any access to the external media, such as USB HDD via Export, Import, Save As, EZBackup.
- Any access to the Network device, such as DICOM transfer or Network Storage.
- Volume Navigation should be exited by Exit and Clear Control.
- Processing 3D/4D images in live mode.

### Before starting Scan on Battery (continued)

Before starting Scan on Battery, go to Utility -> System > General page and select the appropriate value for “Auto Switch to Power Saving Mode” and “Freeze when AC is Unplugged” (Default: Off).

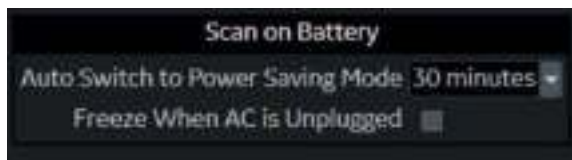

Figure 13-297. Extended Battery for Scanning

#### Auto Switch to Power Saving Mode

- Select 15, 30 minutes or 1 hour to automatically switch to Power Saving Mode after the time specified on battery operation.
- Select “Never” to never switch to Power Saving Mode.
- Select “Always” to always switch to Power Saving Mode.

#### Freeze when AC is Unplugged

- On: When selected, the system goes into Freeze mode when the AC cable is unplugged.



## Starting Scan on Battery

When the AC cable is unplugged from AC power, the system automatically transitions to Scan on Battery Mode.

**NOTE:** *If the system does not transition to Scan on Battery Mode, contact the technical service department or your local GE HealthCare representative.*



**WARNING**

**Do not use Scan on Battery Mode when you need to handle (transfer/ export/ import) patient data.** (Export/ Import/ Backup/ Burn Media, Dicom Transfer, etc.) The system can unexpectedly shutdown when the battery capacity is too low and result in patient data loss. Please note the message in the status bar when Scan on Battery is activated. It is strongly recommend to use AC power when transferring, importing or exporting patient data.

System is using battery power. Make sure the battery has enough capacity to prevent potential data loss

Figure 13-298. Warning message

## Recommendation

Plug in AC power if possible, keep using the battery power can impact to the battery life.

## When the battery capacity becomes low

The LOGIQ Totus displays a dialog for the user to guide to switch to Power Saving Mode when the battery capacity becomes low. User can either keep scanning until the system shuts down or go to Power Saving Mode to extend time before shutdown.

### Switch to Power Saving Mode



#### WARNING

The system switches to Power Saving Mode automatically when the capacity is low.

You can switch to Power Saving Mode by selecting “Switch to power-saving” in the battery status popup anytime you want.

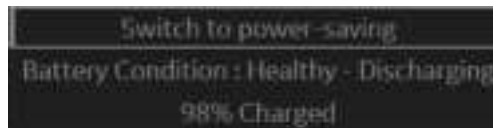

Figure 13-299. Battery status pop-up

The LOGIQ Totus allows going back to Scan on battery mode by pressing the **Power** button or **Freeze** button.



Figure 13-300. Dialog during Power Saving Mode

## View current battery status

When the system is running under Power Assistant/Scan on Battery, battery icons appear in the title bar and on the status bar, indicating how much charge is left in the battery.

### Battery Status Icon on the status bar

The system displays the battery's current charge and posts a notification message on the display when battery power needs attention.

Detailed battery information is available by clicking on the icon and display the popup, which includes the battery's current capacity displaying.

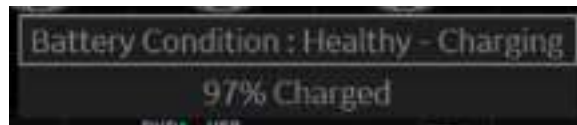

Figure 13-301. Battery status pop-up

**NOTE:** *When the Front Battery LED is blinking, the system is in standby mode and the batteries are charging.*

Table 13-91: Battery status icons









Icon	Description
No icon	AC Plugged; no battery present
	AC Unplugged; battery is fully charged (81 - 100%)
	AC Unplugged; battery is partially charged (61 - 80%)
	AC Unplugged; battery is partially charged (31 - 60%)
	AC Unplugged; battery is partially charged (0 - 30%)

Table 13-91: Battery status icons (Continued)

Icon	Description
	AC Plugged; battery is fully charged (81 - 100%) and charging
	AC Plugged; battery is partially charged (61 - 80%) and charging
	AC Plugged; battery is partially charged (31 - 60%) and charging
	AC Plugged; battery is partially charged (0 - 30%) and charging
	<p>Battery error icon</p> <p>When an abnormal status of the battery is detected, the system displays the following icon:</p> <ul style="list-style-type: none"> <li>• Battery Temperature error</li> <li>• Communication error or battery charge error</li> </ul> <p>NOTE: If this icon displays, do not initiate Power Assistant. Contact the technical service department or your local GE HealthCare representative.</p>

**Battery status Icon in the title bar**

Fuel Gauge icon appears in the title bar.

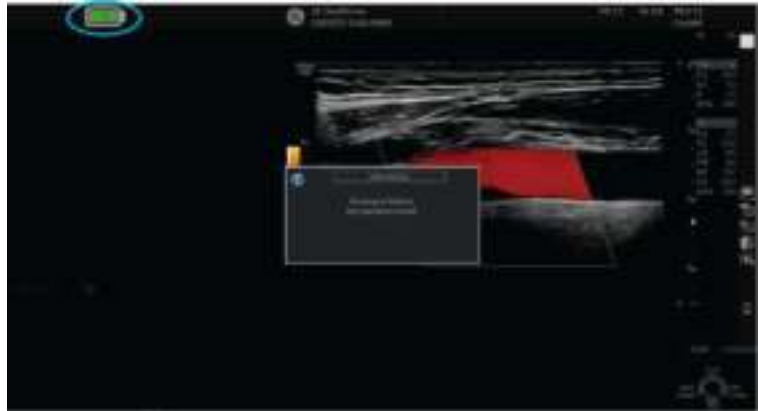

Figure 13-302. Fuel Gauge icon

Table 13-92: Battery status icons (AC unplugged)

Icon	Description	Icon	Description
	91 - 100%		41 - 50%
	81 - 90%		31 - 40%
	71 - 80%		16 - 30%
	61 - 70%		0 - 15%
	51 - 60%		

**NOTE:** To avoid an unintended shutdown of the system, and to avoid risk of losing patient data, it is strongly recommended to connect to AC power when the fuel gauge icon is yellow or red.

### Battery charging

**NOTE:** *Whether the LOGIQ Totus is on or off, the battery will charge as long as the system is connected to AC power via the power cable, and the break is on.*

While the battery is charging, the front battery LED will blink. When the battery is fully charged, the LED will stop blinking and remain on.



Figure 13-303. LED location of the battery

### Approximate charging time (from empty to full)

Wait until the battery is fully charged. It takes at least 1 hour 40 minutes (3 battery pack) / 3 hour 20 minutes (6 battery pack) to fully charge the battery. (depend on the remaining battery capacity).

## **Refreshing the battery**

To maintain battery life and accuracy of the fuel gauge, and to avoid unexpected shutdowns, it is recommended to refresh the battery every 6 months with the following procedure:

1. Plug the AC cable to the wall outlet and turn on the circuit breaker.
2. Wait until the battery is fully charged. It takes about 2.5 hours to fully charge the battery (depend on the remaining battery capacity).
3. Wait at least 1 hour.
4. Remove all probes.
5. Turn on the system.
6. Unplug the AC cable, letting the system run on battery until it automatically shuts down. It may take at least 30 minutes (Power Assistant Battery)/ 50 minutes (Scan on Battery) to complete shutdown.
7. Wait at least 5 hours.
8. Plug the AC cable to the wall outlet and turn on the circuit breaker.
9. Wait until the battery is fully charged. It takes about 2.5 hours to fully charge the battery.

### Battery deterioration

When the system detects battery deterioration, the following dialog displays:

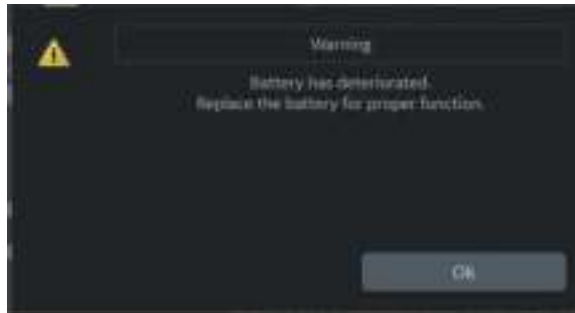

Figure 13-304. Battery life message

If this message appears, the LOGIQ Totus disables both of Power Assistant and Scan on Battery.

Contact the technical service department or your local GE HealthCare representative.

### Battery Disposal

#### Lithium Ion

Used batteries must be disposed of properly and as chemical waste. They cannot be treated as regular waste. Contact your building administration for proper disposal.

**NOTE:** *When removing a defective battery, ensure that it is disposed of in accordance with local regulations. Alternatively, provide it to GE HealthCare for proper disposal.*



# Magstripe Card Reader

## Magstripe Magnetic Card Reader

The Magstripe Card Reader can be attached to the LOGIQ Totus by connecting it to any LOGIQ Totus USB port.



Figure 13-305. Magstripe Card Reader

The Magstripe Card Reader can be used in Patient screen, Worklist and Image Display.

- **Patient screen:** Patient ID, First Name, Last Name, Middle Name, Perf. Physician, Ref. Physician
- **Worklist:** Patient ID, Search String
- **Image Display:** Comments (Annotation)

# Footswitch

## Wired Footswitch

You can attach this Footswitch to the system by connecting it to any USB port on the system.



Figure 13-306. Footswitch and USB Cable

This is a 3-pedal Footswitch. You can configure its functionality via the Utility -> Applications -> Footswitch parameters.



### CAUTION

When using the Footswitch, DO NOT hold down the footswitch pedal. Press and release the Footswitch pedal. Pushing and holding down the pedal behaves the same way as pushing and holding down a key on the keyboard.

## Setting up the DVR

To set up the Digital Video Recorder (DVR), configure the LOGIQ Totus **PRIOR TO** using the DVR since the system **MUST BE** restarted after updating these configuration parameters.

1. Set up following parameters in **Utility --> System --> Peripherals**.

- Media: USB

*NOTE: Pre-format USB device as NTFS*

- Picture Quality: HQ, SP, LP, EP
- Microphone Level: 1 to 5
- USB Playback Skip Interval (sec.): 15, 30, 60, 120

2. If needed, assign [DVR Record/Pause] to a Print key in following steps.

- a. Add [Video Capture] and select [DVR Record/Pause] as the Type, in Utility -> Connectivity -> Service.
- b. Assign the [Video Capture] to the Print Button, in Utility -> Connectivity -> Button.

3. Restart the system.

DVR functionality is now set to record the scan.

### Using the DVR



#### WARNING

Loss of patient data may occur during an AC failure. Ensure that you are not using Power Assistant and that you do not disconnect AC power while saving an exam to the DVR.

1. Create a patient record or open an existing one.
2. Press the Video-assigned key.
3. Insert USB storage, which is selected as DVR media (Utility -> System -> Peripherals).
4. Press **Record** to start recording.

The status bar updates with the recording information. While recording, you can only pause or stop the recording and cannot perform any other DVR functionalities.

**NOTE:** *Recording automatically pauses when you access the Utility screen.*

**NOTE:** *When more than one USB storage is connected, the DVR records to the first drive letter, in alphabetical order.*

**NOTE:** *The system does not start the recording while the following operation is in progress: Data Transfer, EZBackup, Utility screen.*

5. Press **Record** or **Pause** to pause/resume recording.
6. Press **Stop** on the Touch Panel to stop recording.  
When you stop recording, the DVR writes the title data. During this period of time, the busy state icon is displayed in the status bar (green arrow circling) and you cannot operate any DVR functionalities.

**NOTE:** *The DVR automatically stops recording before the media fills up.*

7. Press **Eject** on the Touch Panel or the **F3** key to eject.
8. Press **Scan** tab to return to scanning.

---

## Recording Functionality - USB Storage

### Supported media

USB-HDD (NTFS only), USB Flash Device (NTFS only)

*NOTE: You cannot record or play FAT (exFAT, FAT32, etc) on a USB Device. Please format the USB device to the NTFS file system on a PC.*

### Supported format

MPEG video file

Recording to USB storage creates an mpeg video file (\*.mpg) (LOGIQ\_Series\_DVR\folder) for each title. The file size can be up to 2GB.

*NOTE: The mpeg video file does not have a chapter.*

### Support Picture Quality

- HQ (Record length: approx. 30 minutes)
- SP (Record length: approx. 40 minutes)
- LP (Record length: approx. 60 minutes)
- EP (Record length: approx. 130 minutes)

*NOTE: The maximum size of each video file: 4GB.*

### **Video file name**

The mpeg video file name is titled as follows:

<Date>\_<Time>\_<Patient Last name>\_<Patient First name>..

When the patient's name is not provided, then the video file name is as follows, <Date>\_<Time>\_<serial number> where the serial number is the number of video files on the media plus one.

## Video Touch Panel Menu

DVR Touch Panel menus:

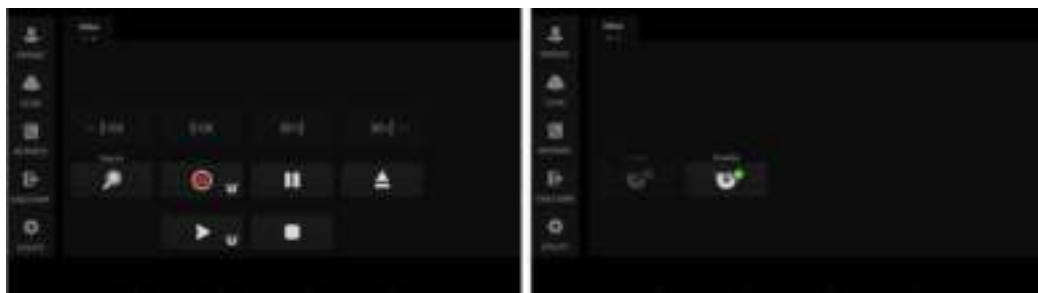

Figure 13-307. Video Touch Panel

Table 13-93: Touch Panel Keys

Touch Panel Key	Explanation
Skip ( <</>> )	USB storage: Skip specific time to forward/backward.
4x Skip (4x  <</>>  4x)	USB storage: Quad time interval skip to backward/forward.
Search	Press Search to start the Search dialog. Select Title, adjust offset then press Search Counter to start the Search. The title name is as follows: <Date>_<Time>_<Patient's Last name>_<Patient's First name>
Record (Red circle with Media Inserted)	Start recording.
Pause (    )	Pauses and resume Recording and Playback. NOTE: The Freeze key works the same as the Pause button, when in Playback.
Open Media Drawer	Press to open the Media Drawer.
Eject	Eject the USB storage device. Also you can eject media pressing the F3 key.
Play ( > with Media Inserted)	Play a video from USB storage device.
Stop ( Box )	Stop playback or recording.

## DVR Display Icons

Displays the following icons in the status bar:

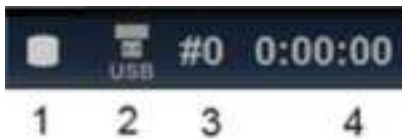









Figure 13-308. DVR Disk Status

Table 13-94: DVR icons

1. DVR status			
	Recording		Stopping
	Pause Recording		Pause Playback
	Playback		Busy
	No media		
2. USB storage status Displays the device availability and the free space size.			
	USB Storage is attached		
3. Current Title Number. Displays while recording			
4. Time counter.			



# Auto Preset Assistant

This AI-based framework recognizes some anatomy by analyzing live B-Mode images. The system then automatically adjusts the B-Mode model (user preset) or suggests the user change the preset manually. While live scanning, the system analyzes the B-Mode image at regular time intervals. When the anatomy is recognized for a specific model (user preset), the associated B-Mode model is enabled.

This feature works on 9L-D, M6-15L-D, L3-12L-D and L6-24-D and Supports 10(ten) B-Mode Anatomical areas: Abdomen, Breast, Carotid, Leg, MSK, Scrotal, Thyroid, Thyroid/Carotid Axial, Air and Other.



## WARNING

This feature uses AI based computer algorithms to determine the anatomical area. There is an inherent risk that these algorithms may sometimes give suboptimal or incorrect results. Verify that automatically selected presets are appropriate for the scanned anatomy type.

**NOTE:** *This view recognition algorithm was trained on 14,333 images and validated on 339 images which were independent data sets for the training algorithm.*

*Based on the validation test, Minimum Acceptable Algorithmic Performance was confirmed to 80% accuracy.*

### Auto Preset Assistant Configuration in Imaging Preset Manager

The Imaging Preset Manager can incorporate the Auto Preset selections, or manually added presets.

1. Select Utility > Imaging Preset Manager > Auto Preset in Category.
2. Available Imaging Presets on the left side includes all available presets (including the “Auto Preset” selections).

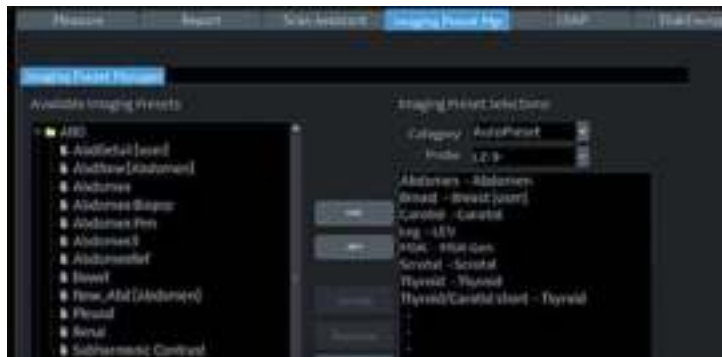

Figure 13-309. Auto Preset Assistant Configuration

For example, in Figure 13-309 "Auto Preset Assistant Configuration", if the algorithm percentage result meets the MSK preset, the preset that is automatically selected is “MSK Gen.” If no preset was defined, the system does not recommend or automatically change any presets.

## Auto Preset Assistant Configuration in System Imaging

1. Select Utility > System > System Imaging on the Touch Panel.
2. "Auto Preset Assistant" configuration column is shown in Utility System Imaging menu.
3. Turn on check box of Enable in Auto preset Assistant in Utility System Imaging menu.
4. See Table 13-95 Auto Preset Assistant for detail parameters.

Table 13-95: Parameters and Description

Parameter	Description
Enable	Select to enable the Auto Preset Assistant feature.
Default Auto Mode in new patient	<p>Off: the system does not automatically change to the recommended preset.</p> <p>Automatic: the system automatically changes to the recommended preset when the algorithm percentage is higher than the defined Auto Threshold.</p> <p>Air detected: The system automatically changes to the recommended preset when the algorithm percentage is higher than the Auto Threshold and is immediately recognized as Preset of Air. By selecting "Air detected" the system automatically changes to the recommended preset, if the confidence result is higher than the automatic threshold and is immediately recognized as Preset of Air.</p>
Turn off Auto after changing preset	If selected, once the preset changes, no automatic preset changes are allowed.
Automatically Retain Field of View	Selecting this ensures that the Imaging Parameters. Retain Field of View stay constant over Probe and Preset changes by Auto Preset Assistant.
Check before automatic change	Requires confirmation before the preset changes.
Recommendation without specifying preset	If there are presets to recommend, the "Check your preset" message displays.
Show detected view	A tool displays the detected view result.

## Auto Preset Assistant Configuration in User Defined Trackball Set Key Menu

In addition to making this function work automatically, it is possible to confirm the recommended preset using the Trackball Set key. These operations can be assigned to the trackball sub-set key in the User Configurable Key menu. The B-Mode preset can be changed to the recommended preset without moving hands from the operator panel.

1. Select Utility > System > User Configurable Key menu.
2. Select “Auto Preset” check in B/BF/Con category of User Defined Trackball Set Key menu.

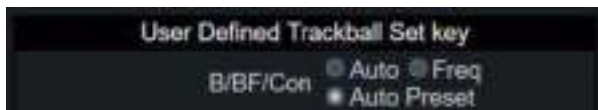



Figure 13-310. User Defined Trackball Set key

Table 13-96: Parameters and Description

Parameter	Description
<p>AUTO</p>	<p>On: Automatically changes to the recommended preset as defined in the Auto Preset Assistant parameters.</p>  <p>Off: Does not automatically change to the recommended preset.</p> 
<p>Change</p>	<p>Displayed if there is a suggested preset change. If preset should change to the recommended preset, press Change.</p>

## Using Auto Preset Assistant

1. Perform the required setup in the configuration menu.
2. Select Linear probe and start B-Mode scan.
3. Scan the same plane continuously for more than one second.
4. During live scan, Auto Preset Assistant uses computer algorithms to estimate which of the B-Mode presets is closest to the current scan plane.
5. If the algorithm percentage result exceeds the Assist Threshold and the confidence level is different from the current preset, a message displays to press the Change key to change to the appropriate preset. The Change key is then assigned to the right side of the Sub-set key.



6. If the "Change" key is pressed while the above message is displayed, the system changes from the current to the proposed preset.

### Using Auto Preset Assistant (continued)

7. If the returned confidence result exceeds the Auto threshold and inferencing is different from the current preset, a system message similar to “Changing to Thyroid Preset” appears. The preset change algorithm is automatically executed.



This feature only starts if certain conditions are met:

- Simplex B-Mode live images
- When there is a link between the preset and the confidence preset
- Depth > 2 cm
- Does not work with a contrast application
- Does not work in write zoom.
- Does not work with Scan Assistant

This algorithm may display suboptimal or incorrect results, especially in the following cases.

- When the target or probe is moving significantly.
- In case of poor visualization due to probe contact, deep attenuation, artifacts, etc..
- When it is not a typical scan cross section. For example, including tumors, cysts, or diffuse changes.
- Affected by B-Mode display settings such as Compress and Gain, or user adjustments for post-processing.
- When multiple different organs coexist. Algorithms tend to make more important decisions based on image information close to the center.
- MSK anatomical area is limited to only scan views that contain bone structures of knee and elbow.

## **Using Auto Preset Assistant (continued)**

- LEG(Arm) anatomical Area is limited to only scan views that contain vessel structures of Leg and Arm.
- The “Thyroid/Carotid Axial” anatomical area is specific to the short axis view of the carotid artery that also captures the thyroid lobe. When the user is scanning in the “Thyroid” preset and the “Thyroid/Carotid Axial” anatomical area is detected, no change is made to the preset. And when the user is scanning in the “Carotid” preset and the “Thyroid/Carotid Axial” anatomical area is detected, no change is made to the preset. This allows the user to stay in the existing preset.
- The system does not actively change presets if a preset within same categories is already selected. For example, if MSK sup and UEA are selected, do not automatic change to MSK gen or LEA, respectively.

### Auto Abdominal Color Assistant

This AI-based framework recognizes some anatomy by analyzing live B-Mode images. When the user enters Color Doppler, the system automatically adjusts to a flow shortcut based on a confidence level. While live scanning, the system analyzes the B-Mode image at regular time intervals. When the anatomy is recognized for a specific model (user preset) in B-Mode and Color mode is entered, the associated flow shortcut is activated.

This feature works on C1-6-D, C1-6(VN)-D, C2-7-D, C2-7(VN)-D, C3-10D, RAB6-D, 9L-D, L3-12-D, M5Sc-D probes while scanning in an Abdomen application (Abdomen, Abdomen Detail, Abdomen Penetration, Abdomen Biopsy and Renal). The algorithm supports five abdominal areas: "Aorta", "Liver/IVC/Spleen", "Gallbladder/Urinary Bladder", "Kidney" and "Pancreas."

This feature is trained to classify views among five anatomical areas, and two labels called "Unknown/Other" and "Probe in Air."



#### WARNING

This feature uses AI based computer algorithms to determine the abdominal model presets. There is an inherent risk that these algorithms may sometimes give suboptimal or incorrect results. Verify that automatically selected Flow models are appropriate for the scanned anatomy type.

**NOTE:** *This view recognition algorithm was trained on 11,478 images and validated on 285 images which were independent data sets for the training algorithm.*

*Based on the validation test, Minimum Acceptable Algorithmic Performance was confirmed to 80% accuracy.*



## Auto Abdominal Color Assistant Configuration for System Imaging

1. Select Utility > System > System Imaging on the Touch Panel.
2. “Auto Abodminal Color Assistant” configuration column is shown.
3. Turn on check box of Enable in Auto Abdominal Color Assistant.
4. See Figure 13-311 for detail parameters.



Figure 13-311. Configuration for Auto Abdominal Color Assistant

Table 13-97: Parameters and Description

Parameter	Description
Enable	To use this feature, turn on check box of Enable Auto Abdominal Color Assistant.
Auto Flow Model selection	Turn on check box, selecting recommended Flow model automatically at the timing of entering color mode.
Turn off Auto after manual Flow Model selection	If the Flow Model is selected by manual operation from the Touch Panel, automatic change function will be turned off tentatively. After selecting a new patient or probe, it becomes valid again.
Show detected view	A tool displays the detected view result.

## Auto Abdominal Color Assistant Configuration in User Defined Trackball Set Key Menu

In addition to making this function work automatically, it is also possible to accept user confirmation operations based on the confidence results. These operations can be assigned to the trackball sub-set key in the Configuration Menu below. The Flow model can be changed while still touching the operator panel.

1. Select Utility > System > User Configurable Key menu.
2. Select “Auto Preset” check in CF/TVI/PDI category of User Defined Trackball Set Key menu.



Figure 13-312. User Configurable Key for Auto Flow Model

Table 13-98: Parameters and Description

Parameter	Description
Reset CF	System turns off any Flow model. This can be easily reverted if the Flow model proposed by the algorithm and automatically modified does not meet expectations.
Change	Displayed it if there is a proposed Flow model. Press to change to the proposed

## Auto Flow Model Selection Configuration in Imaging Menu

Each confidence preset can be freely associated with any of the four pre-prepared flow models. Each flow model name and parameters can be customized.

1. Select Utility > Imaging > CF-tab.
2. The left side of “Auto Preset - Flow Model” shows bundled view confidence preset as Aorta, Liver/Spleen/IVC, Renal, Gall/Urinary Bladder and Pancreas. Select the corresponding Flow Model from the column of right side.



Figure 13-313. Configuration for Auto Abdominal Color Assistant

Using the above sample settings as an example, when the confidence algorithm estimates the Aorta Preset, the “Flow Model 1” is automatically or semi-automatically selected by entering color mode. For the Pancreas Preset (“-” is selected), the system does not recommend or automatically change any Flow model. For the Liver/Spleen Preset (“None” is selected), the system turns off any Flow model and changes to the default setting. The settings of these four pre-prepared flow models (Flow Model 1...4) can be confirmed and adjusted on the setting screen.



Figure 13-314. Setting screen example - Auto Abdominal Color Assistant

### **Using Auto Abdominal Color Assistant**

1. Perform the required setup in the configuration menu.
2. Select a probe that supports abdominal applications and start the B-Mode scan.
3. Scan the same plane continuously for more than three seconds.
4. By entering color mode, the Auto Abdominal Color Assistant uses computer algorithms to estimate which of the 11 abdominal presets is closest to the current scan plane.
5. If the returned confidence result exceeds the Assist threshold and inferencing is different from the current Flow model, a system message similar to "Recommend changing to Aorta flow model" appears on the bottom of the display (information area). The "Change" key is then assigned to the right side of the Sub-set key.
6. If the "Change" key is pressed while the above message is displayed, the system changes from the current to the proposed Flow model.

**Auto Abdominal Color Assistant (continued)**

7. If the returned confidence result exceeds Auto threshold and inferencing is different from the current Flow model, a system message similar to "Changing to Aorta flow model" displays. The preset change algorithm is automatically executed.



This feature only starts if certain conditions are met:

- Using Abdomen, Abdomen2, AbdBiopsy and AbdDetail or an application created based on one of them.
- When color or PDI mode is activated from the B-Mode Live scan.
- When there is a link between the Flow model and the confidence preset.
- When there is live information of B-Mode for more than 3 seconds. This feature does not work if Color Flow is activated immediately after starting Auto Flow mode Model, or if the color mode is turned on/off in a shorter time frame.
- Does not work with a contrast application or other flow modes (only with Color and PDI).
- Does not work with Scan Assistant.

This algorithm may display suboptimal or incorrect results, especially in the following cases:

- When the target or probe is moving significantly.
- In case of poor visualization due to probe contact, deep attenuation, artifacts, etc.
- When it is not a typical scan cross section. For example, including tumors, cysts, or diffuse changes.
- Affected by B-mode display settings such as Compress and Gain, or user adjustments for post-processing.
- When multiple different organs coexist. Algorithms tend to make more important decisions based on image information close to the center.
- The algorithm uses only information for the entire B mode, not the position of the color ROI or blood flow information. Therefore, depending on the location or size of CF ROI, algorithm may sometimes give suboptimal or incorrect results.

# Voice Control

Voice Control lets you activate certain functions by speaking recognized commands.

**NOTE:** *Voice Control is not available in all languages. To choose the language you want to use for Voice Control, Utility --> System --> General --> Language.*



**CAUTION**

Voice recognition accuracy may be affected by background noise, speech clarity/accent, or microphone configuration.

## Set up Voice Control

1. Go to Utility --> System --> General.
2. Check the box for "Enable Voice Control".

## Start Voice Control

1. You can start by performing one of the following :
  - If "Wake with 'Hey LOGIQ'" is checked, you can say "Hey LOGIQ"
  - On the scan screen, click the Voice Control icon on the status bar.
  - Press the User Defined key assigned to Voice Control. (You can set up the User Defined key via Utility --> System --> User Configurable Key.)
  - Push the footswitch pedal mapped to Voice Control. (You can set up the footswitch via Utility --> Application --> Footswitch.)
2. Say a command, such as "Freeze."

Table 13-99: Icon description

Icon	Description
	<b>Mute:</b> Not listening for a wake word.
	<b>Standby:</b> Listening for a wake word.
	<b>Listening:</b> Listening for a command.
	<b>Busy:</b> Responding and not listening.

**NOTE:** *Voice Control might activate when you didn't say "Hey LOGIQ." This can happen when it detects something that sounds similar. If this happens often, you can make it less sensitive. Also, Voice Control might not activate when you say "Hey LOGIQ," particularly in a noisy environment. If this happens often, you can make it more sensitive. You can adjust 'Hey LOGIQ' Sensitivity via Utility --> System --> General --> Voice Control.*

**NOTE:** *To protect your privacy, Voice Control does not log any audio data or transcripts.*

## Command Set

The following list of commands shall be supported. There are many varied expressions for the same intent. The list has only the simplest forms composed of essential keywords.



### HINTS

In the list, [n] is an index and X is a value, such as:

- [n] is a relative index if the command is a type of incremental or decremental. e.g., "Gain up 10"
- [n] is an absolute index if the command is a type of direct setting. e.g., "SRI 2"
- X is always an absolute value. e.g., "Gain 50"

Table 13-100: Essential keywords and command

Category	Command
Freeze/Unfreeze	<ul style="list-style-type: none"> <li>• Freeze</li> <li>• Unfreeze</li> </ul>
Print	<ul style="list-style-type: none"> <li>• Print [1/2/3/4/Screen]</li> </ul>
Imaging	<ul style="list-style-type: none"> <li>• Gain up/down [n]</li> <li>• Gain X</li> <li>• Depth up/down [n]</li> <li>• Depth X</li> <li>• Frequency up/down [n]</li> <li>• Frequency X</li> </ul>
B/BFlow	<ul style="list-style-type: none"> <li>• B Mode</li> <li>• CHI [on/off]</li> <li>• CrossXBeam [on/off]</li> <li>• Advanced SRI [on/off]</li> <li>• SRI n</li> <li>• Virtual Convex [on/off]</li> <li>• Near/Far/Overall TGC up/down [n]</li> <li>• Dual/Split [left/right/simultaneous]</li> </ul>
CF/PDI/MVI/TVI	<ul style="list-style-type: none"> <li>• Color Flow [on/off]</li> <li>• PDI [on/off]</li> <li>• MVI [on/off]</li> <li>• TVI [on/off]</li> <li>• Scale up/down [n]</li> <li>• Scale X</li> <li>• Steer [left/right]</li> <li>• Virtual Convex [on/off]</li> <li>• Dual/Split [left/right/simultaneous]</li> </ul>
Biopsy Kit	<ul style="list-style-type: none"> <li>• Biopsy [on/off]</li> <li>• Biopsy n</li> </ul>
BSteer+	<ul style="list-style-type: none"> <li>• BSteer+ [on/off]</li> <li>• Needle left/right</li> <li>• Needle Angle X</li> </ul>



Table 13-100: Essential keywords and command

Category	Command
Comment	<ul style="list-style-type: none"> <li>• Type &lt;text&gt;</li> </ul>
Clear	<ul style="list-style-type: none"> <li>• Clear</li> <li>• Clear all</li> </ul>
Probe and Preset	<ul style="list-style-type: none"> <li>• Probe n</li> <li>• Preset &lt;preset&gt;</li> </ul>
Other Controls	<ul style="list-style-type: none"> <li>• M mode [on/off]</li> <li>• PW [on/off]</li> <li>• CW [on/off]</li> <li>• LOGIQView [on/off]</li> <li>• Contrast [on/off]</li> <li>• Elasto [on/off]</li> <li>• UGAP [on/off]</li> <li>• Quick Patient Change</li> <li>• Reverse</li> </ul>

**NOTE:** *Keep the Doppler volume at its lowest acceptable level.*

**NOTE:** *Do not speak too loudly.*

### Stop Voice Control

To stop Voice Control, you can do any of the followings:

- Say "Stop listening."
- If you select a timeout period for "Time Out After No Speech" in Voice Control settings, wait the specified time.
- Click the Voice Control icon on the scan screen.
- Press the User Defined key assigned to Voice Control.
- Push the footswitch pedal mapped to Voice Control.

*NOTE: Clicking the icon, pressing the User Defined key, or pushing the footswitch pedal is to either start or stop Voice Control.*

*NOTE: To turn off Voice Control entirely, go to Utility --> System --> General, and then uncheck "Enable Voice Control".*

## Change Voice Control settings

To view or change your Voice Control settings:

1. Select Utility --> System --> General.
2. Select Voice Control settings.

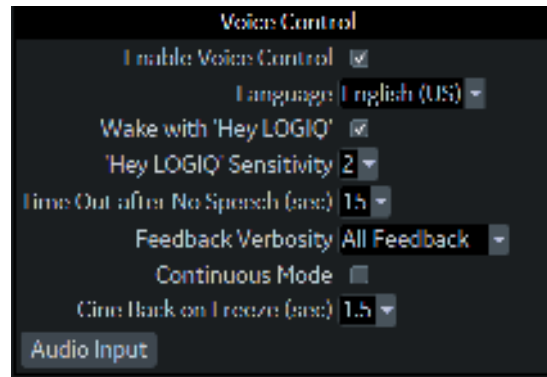

Figure 13-315. Voice Control Setting

Refer to the followings for the detail.

- Enable Voice Control: Select to enable Voice Control.
- Language: Select the language you want to use for Voice Control. Voice Control is currently available only for US English.
- Wake with 'Hey LOGIQ': Select to activate Voice Control with your voice.
- 'Hey LOGIQ' Sensitivity: Choose how sensitive Voice Control to be when it responds to "Hey LOGIQ" (0, 1, 2, 3, 4).
- Time Out after No Speech: Stop Voice Control after a specified period of no speech. (5, 15, 30, 120, Always).
- Show Live Captions: Display live captions in real-time.
- Continuous Mode: Keep listening for a next command continuously.
- Cine Back on Freeze (sec) : Select time by which cine back after recognition of the Freeze command (0.0, 1.0, 1.5, 2.0).

- Audio Input: Adjust the audio input volume.

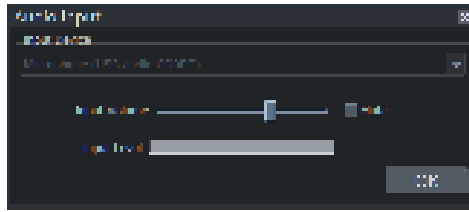

Figure 13-316. Audio Input

**NOTE:** *The input level monitor bar should not rise above approximately 3/4 of its maximum width. If it goes greater than that, the volume is too loud, and the recording will probably experience clipping. This may cause the quality of the speech recognition to be poor. If there is no sound coming from the audio source, the bar will not move.*

# Data Streaming (Option)

**NOTE:** *The Data Streaming option key should be installed to enable streaming live/recall/CINE ultrasound data.*

The system has the capability to stream live/recall/CINE ultrasound image data over the network connection to enabled devices. The data stream will contain grayscale, color map, geometry, view settings (flip/rotate/reverse), probe and system information, VNav position information and ultrasound data. No patient information is transferred with the streamed data.

The following table represents the types of data streamed in different modes on the ultrasound system.

Table 13-101: Icon description

Data Type	Modes
2D Image	B Mode, B-Flow Mode, Contrast Mode

**NOTE:** *It is recommended to use a 1 Gbps network connection for Data Streaming. The required bandwidth often lies in the 100-300 Mbps range. Usage of a 100 Mbps network leads to dropped frames and the risk of latency buildup.*

## User Setup for Data Streaming

Only a member of the group "ReceiveStreaming" will have permission to receive streamed data. See example of users who can receive streaming data below.



Figure 13-317. User Setup for Data Streaming

If LDAP authentication is enabled, at least one of the LDAP groups that the user belongs to must be mapped to the group "ReceiveStreaming" to allow the device to receive streaming data.

## Enable Data Streaming

1. Press UTILITY+ on the Touch Panel.
2. Press Utility on the Touch Panel.
3. Press Connectivity on the Touch Panel.
4. Select Data Streaming on SmartConnect.
5. Turn on Enable Streaming.
6. Enter the Port No (or use the default port).

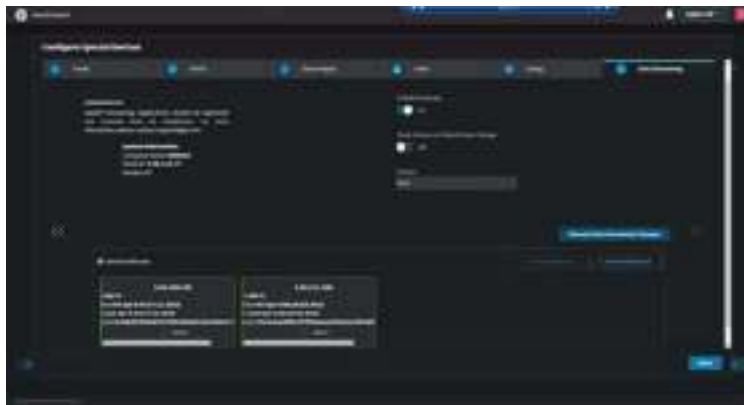

Figure 13-318. Data Streaming settings

## Enable Data Streaming

1. On the device, connect to the ultrasound system with the IP address, Port Number, user account and password currently used to log on to the ultrasound system.
2. The ultrasound system displays a PIN code. Enter the PIN code on the device.
3. The device and the ultrasound system establish the Data Streaming connection.

**NOTE:** *Once the device establishes the connection, the ultrasound system stores the connection as a certificate. The PIN code is NOT necessary in the next connection.*



Figure 13-319. Certificates

**NOTE:** *The certificate is valid for one year. After the certificate expires, a new PIN code displays on the ultrasound system at the next connection attempt.*

**NOTE:** *When the certificate for the device is no longer needed, the certificate can be revoked.*

1. Press APPS+ on the Touch Panel.
2. Press Utility on the Touch Panel.
3. Press Connectivity on the Touch Panel.
4. Select Data Streaming on SmartConnect.
5. Select the certificate.
6. Click Revoke Selected.





## Data Streaming in Process

Data Streaming is initiated and terminated from an enabled device (e.g. a smart phone/tablet or PC connected to the same network and capable of receiving the streamed data over a custom protocol). An enabled device can only receive data when streaming has been enabled on the system.

Streaming status is indicated on the screen as follows:

Table 13-102: Streaming status

Indication (Icon)	Status
	<ul style="list-style-type: none"> <li>• The streaming device is connected.</li> <li>• The system is in freeze mode, or PW/CW when 2D is not live.</li> <li>• Data is NOT streaming.</li> </ul>
	<ul style="list-style-type: none"> <li>• The streaming device is connected.</li> <li>• Data is streaming.</li> </ul>
	<ul style="list-style-type: none"> <li>• The streaming device is connected.</li> <li>• The system is in a mode not supported in Data Streaming.</li> <li>• Data is NOT streaming.</li> </ul>

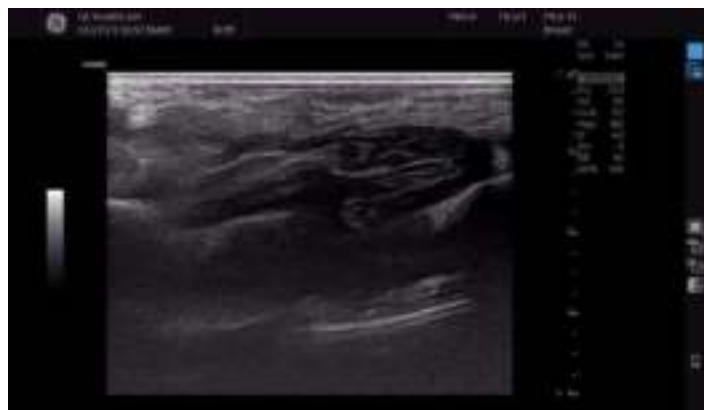

Figure 13-320. Data Streaming is in active (example)

Data Streaming can be stopped by the following operations:

- Changing a patient or ending an exam when Close Stream on Patient/Exam Change is turned on.
- Pressing the Pointer Key to display the pointer on the monitor. Hover the pointer over the Streaming status icon and select the icon.

## Symbols

- % Stenosis
  - generic measurement, 7-20

## Numerics

- 3D/4D imaging
  - introduction, 13-4
  - manipulating the volume of interest, 13-27
  - operational controls, 13-13
  - principles of operation, 13-5, 13-558, 13-559, 13-562, 13-563
- 3D/4D presets, changing, 10-56
  - Advanced, 10-60
  - Render Setting, 10-59
  - ROI (Region of Interest), 10-58
  - Scalpel, 10-59
- 3D/4D presets, overview, 10-56

## A

- A/B Ratio
  - Doppler generic measurement, 7-35
  - generic measurement, 7-27
  - M-Mode generic measurement, 7-29
- Acceleration time (AT)
  - OB/GYN vessel measurement, 7-36
- Acceleration, measuring, 7-36
- accessories
  - ordering, 1-12
  - requesting a catalog, 1-12
- accessory
  - connector panel, 3-13
- Acclimation time, 3-90
- Accumulation, B-Flow, 5-16
- accuracy
  - clinical calculation, 12-10
  - clinical measurement, 12-7
- acoustic output
  - default levels, 2-44
- Activating Continuous Capture, 13-184
- Active Images, 9-11
- active images, description, 4-3
- Admin
  - overview of Utility screen, 10-141
- Admin screen
  - Logon, 10-154
  - System Admin, 10-150
  - Users, 10-153

- administrator
  - specifying system, 10-153
- AFI
  - AVC Timing Adjustment, 13-222
- AFI, see Amniotic Fluid Index (AFI)
- air filter
  - removing, 12-43, 12-44
- ALARA (as low as reasonably achievable), bioeffects, 2-5
- Alpha Hip, pediatric measurement, 8-84
- Amniotic Fluid Index (AFI), measuring, 8-13
- Analysis
  - Stress Echo, 13-194
- Anatomical M-Mode
  - activating, 5-33
  - adjusting, 5-33
  - overview, 5-33
- Angle, B-Mode generic measurement, 7-26
- annotating an image
  - introduction, 6-23
  - text overlays, 6-26
  - using the annotation library, 6-28
  - using typed words, 6-33
- Annotation mapping
  - Breast lesion, 10-39
- Annotations Libraries Presets Menu, 10-33, 10-37
- annotations, presets, 10-36
- anonymize, 13-407
- Anonymize Patient
  - patient data, 13-407
- application presets
  - user-defined, 10-182
- Applications
  - setting presets, 10-47
- Applications Preset Menu, 10-45
- area measurements
  - ellipse, 7-41
  - spline, 7-43
  - trace, 7-40, 7-42, 7-43
- AUA
  - OB worksheet, 7-65
- audio, speakers, 3-10
- Auto Calcs
  - modifying, 5-55
- Auto Calcs, modifying, 5-55
- Auto sequence

---

- using, 7-85
- Auto Vascular Calculation, see also Manual Vascular calculations
  - activating, 8-65
- Auto Vascular Calculation, see also Manual Vasuclar calculations
  - setting up calculation parameters, 8-65
- AutoEF
  - Tracking validation, 13-233

## B

- B Steer plus, adjusting, 5-21
- Background, B-Flow, 5-16
- Backup and Restore Preset Menu, 10-22, 10-189
- Battery status, 13-531
- Battery, refresh, 13-535
- biological hazards, 2-12
- Bladder volume, measuring, 8-75
- B-Mode imaging
  - intended uses, 5-2
  - optimizing, 5-2
  - scanning hints, 5-3
  - typical exam protocol, 5-2
- B-Mode measurements
  - Echo Level, 7-45
  - Gynecology exam, 8-42
- B-Mode measurements, general, 7-38
- B-Mode measurements, generic
  - % Stenosis, 7-20
  - A/B Ratio, 7-27
  - Angle, 7-26
  - Volume, 7-22
- B-Mode measurements, mode
  - circumference and area (ellipse), 7-41
  - circumference and area (spline trace), 7-43
  - circumference and area (trace), 7-42
  - distance, 7-39
- body pattern application libraries, selecting, 10-45
- Body Patterns, 6-35
  - General tab, 10-44
- Body Patterns Preset Menu, 10-44
- Breast lesion
  - Annotation mapping, 10-39

## C

- calculations
  - OB worksheet, 7-66
  - selecting, 7-12
  - urology, 8-75
- calipers, description, 7-14
- Capture Recon., B-Flow, 6-11
- Capture, B-Flow, 5-17
- Care and maintenance
  - cleaning the system, 12-34
  - footswitch, 12-50
  - operator controls, 12-41

- system cabinet, 12-37
- Caution icon, defined, 2-4
- Change the display format, 3-79
- CINE capture, 6-10
  - Enhancement, 6-12
- CINE loop
  - previewing only, 9-8
  - storing and previewing, 9-7
  - storing without previewing, 9-8
- CINE mode
  - introduction, 6-3
  - synchronizing loops, 6-6
  - using, 6-5
- circuit breaker
  - description, 3-21
- circumference measurements
  - ellipse, 7-41
  - spline, 7-43
  - trace, 7-40, 7-42, 7-43
- Clinical
  - calculation accuracy, 12-10
  - measurement accuracy, 12-7
- Color Flow imaging
  - activating, 5-37
  - intended uses, 5-35
  - M-Mode, 5-48
  - optimizing, 5-35
  - Power Doppler, 5-44
- comments, see annotating an image
- Compare Assistant
  - Control, 13-363
  - Set up, 13-361
  - Workflow, 13-360
- Connectivity
  - configuring, 10-61
  - presets, 10-61
- console
  - moving, 3-85
  - transporting, 3-89
  - wheels, 3-86
- contacts
  - clinical questions, 1-12
  - Internet, 1-12
  - service questions, 1-12
- Continuous Capture
  - Stress Echo, 13-182
- contraindications, 1-10
- Contrast Imaging
  - overview, 13-57
- Control Panel
  - description, 3-52
- Control panel
  - replacing key caps, 12-50
  - replacing key lamps, 12-50
- controls
  - annotation function, 3-61
  - display function, 3-60
  - keyboard, 3-55

- measurement function, 3-61
  - mode function, 3-60
  - operator, 3-52
  - print function, 3-60
  - Touch Panel, 3-58
- CUA**
- OB worksheet, 7-65
- Curved Anatomical M-Mode, 5-34**
- CW Doppler**
- activating, 13-148
  - exiting, 13-148
  - non-imaging, 13-147
  - overview, 13-147
  - steerable, 13-147
- D**
- D/S ratio, 7-34**
- Danger icon, defined, 2-4**
- Data Transfer, description, 4-3**
- dD Ratio, pediatric measurement, 8-85**
- device labels, 2-49**
- devices**
- acceptable, 2-40
- Digital Expert, 13-515**
- disinfecting probes, 11-41**
- disinfecting solutions, probes, 11-41**
- distance measurement**
- general, 7-39
- Doppler Auto Calc Average Cycle, using, 7-49**
- Doppler measurements, generic**
- A/B Ratio, 7-35
  - D/S ratio, 7-34
  - Heart Rate, 7-34
  - Pulsatility Index (PI), 7-33
  - Resistive Index (RI), 7-33
- Doppler measurements, mode**
- TAMAX and TAMEAN, 7-47
  - time interval, 7-46
  - velocity, 7-46
- Doppler Mode**
- generic study, 7-32
- Doppler Mode, general measurements, 7-45**
- Doppler Mode, PW**
- intended uses, 5-49
  - optimizing, 5-49
  - typical exam protocol, 5-50
- dual image mode, see split-screen imaging**
- DVD Multi drive**
- location, 3-9
- E**
- Echo level measurements, 7-45**
- editing**
- patient information, 4-24
  - user-defined calculations, 7-98
- EFW growth percentile**
- OB worksheet, 7-66
- electrical**
- configurations, 3-3
- electrical hazard, 2-11**
- electromagnetic compatibility (EMC), 2-19**
- ellipse measurement, general, 7-41**
- EMC (electromagnetic compatibility), 2-19**
- End diastole (ED)**
- OB/GYN vessel measurement, 7-36
- Endometrium thickness (Endo), GYN exam, 8-43**
- Enhancement, 6-12**
- environmental requirements, 3-4**
- equipment safety, 2-11**
- Erasing**
- measurements, 7-13
- exam**
- definition of terms, 7-11
  - deleting, 4-25
  - OB, 4-7
  - workflow, 7-11
- explosion hazard, 2-12**
- F**
- Fast Key, 6-44**
- Federal law (USA), requirements, 1-10**
- Fetal growth bar graph, 8-17, 8-25**
- Fetal growth curve graph, 8-17**
- description, 8-18
  - multiple fetus, 8-27
  - quad view, 8-20
  - selecting, 8-19
- Fetal trending**
- fetal growth curve graph, 8-22
  - multiple fetuses, 8-28
- Fetus**
- entering number of, 8-26
  - selecting on an OB worksheet, 7-65
- Fetus Compare**
- multiple fetus, 8-27
- Flow Volume, 7-52**
- folders, measurement**
- adding, 7-87
- Follicle measurements, GYN exam, 8-43**
- Footswitch, 13-538**
- freezing an image, 6-2**
- front panel, location, 3-16**
- FV, 7-52**
- G**
- Gels, coupling, 11-46**
- General imaging**
- changing presets, 10-31
- generic studies and measurements, 7-18**
- Generic study**
- Doppler mode, 7-32
- Gestational Sac (GS), 8-12**

GYN exam  
    endometrium thickness, 8-43  
    follicle measurements, 8-43  
    ovaries measurements, 8-44  
    uterus measurements, 8-44  
Gynecology exam, 8-42  
    B-Mode measurements, 8-42

**H**

hazards, 11-39  
    biological, 11-14  
    electrical, 11-13  
hazards, safety symbols, 2-5  
hazards, types  
    biological, 2-12  
    electrical, 2-9, 2-11  
    explosion, 2-12  
    mechanical, 2-9  
Heart Rate  
    Doppler generic measurement, 7-34  
    M-Mode generic measurement, 7-31  
Hip Dysplasia, pediatric measurement, 8-82

**I**

Image acquisition  
    Stress Echo, 13-176  
Image History, description, 4-3  
Image Zoom, 6-14  
images  
    deleting, 4-25  
    recalling from clipboard, 9-23  
    reviewing, 9-11  
Imaging presets, changing  
    General, 10-31  
Imaging presets, overview, 10-30  
information, requesting, 1-12  
InSite, using, 13-520  
Intravessel ratio, calculating, 8-70

**K**

keyboard  
    special keys, 3-55

**L**

labeling probes, 2-60  
Libraries Preset Menu, 10-42  
Lock the monitor, 3-65  
log on procedures  
    defining, 10-154  
LOGIQ system  
    contraindications, 1-10  
LOGIQView, 5-19  
Logon  
    Admin screen, 10-154

**M**

managing images  
    media handling tips, 9-4  
    media requirements, 9-4  
Manual Vascular Calculation, 8-69  
Measurement  
    Tool  
        Copy, Past&Move, 7-15  
Measurement & Analysis screen  
    accessing, 7-75, 8-28, 8-31  
measurement controls, location, 7-6  
Measurements  
    erasing, 7-13  
    general instructions, 7-13  
    OB  
        AFI, 8-13  
    measurements, general, 7-4  
    measurements, generic  
        overview, 7-18  
    measurements, types  
        amniotic fluid index (AFI), 8-13, 8-14  
        gestational sac, 8-12  
    measurements, using  
        adding, 7-87  
        automatically starting in workflow, 7-85  
        calipers, 7-14  
        changing, 7-86  
        deleting, 7-99  
        selecting in different category, 7-8  
Minimum diastole (MD)  
    OB/GYN vessel measurement, 7-36  
M-Mode  
    CAMM, 5-34  
M-Mode imaging  
    color flow, activating, 5-48  
    intended uses, 5-31  
    optimizing, 5-31  
    typical exam protocol, 5-32  
M-Mode measurements, generic  
    % Stenosis, 7-29  
    A/B Ratio, 7-29  
    Heart Rate, 7-31  
M-Mode measurements, mode  
    time interval, 7-57  
    tissue depth, 7-56  
M-Mode, general measurements, 7-56  
MO drive  
    location, 3-9  
Mode Cursor, displaying  
    Doppler Mode, 5-55  
monitor  
    speakers, 3-10  
moving the system, 3-82  
    during transport, 3-89  
    precautions, 3-85  
    wheels, 3-86  
Multiple fetuses, 8-26

---

- fetal trending, 8-28
- identifying, 8-27
- on OB worksheet, 8-28

My Desktop

- set up, 3-77

## N

- network status indicator, location, 3-16
- new patient
  - scanning, 4-10

## O

OB

- graph, 8-17
- identifying multiple fetuses, 8-27
- Patient data, 4-9, 8-9
- studies, 8-11

OB exam

- preparing, 4-7
- starting, 4-9, 8-8

OB graphs, 8-17

- fetal growth bar graph, 8-25
- patient data, 8-24
- viewing, 8-17

OB measurements, types

- amniotic fluid index, 8-14
- amniotic fluid index (AFI), 8-13
- gestational sac, 8-12

OB multigestational, 8-26

OB worksheet

- AUA, 7-65
- calculations, 7-66
- CUA, 7-65
- EFW growth percentile, 7-66
- multiple fetuses, 8-28
- patient data, 7-65
- selecting ultrasound age, 7-65

OB/GYN vessel measurements, 7-36

- acceleration, 7-36
- acceleration time, 7-36
- end diastole, 7-36
- minimum diastole, 7-36
- peak systole, 7-36

Operator controls, 12-41

optimizing images

- B-Mode, 5-2
- Color Flow, 5-35
- Doppler, PW, 5-49
- M-Mode, 5-31

options

- system, 10-150

Orientation Help, 3D/4D imaging, 13-19

ovaries, measurement, 8-44

## P

past exam

- entering patient data, 8-23

Patient Cardiac and ECG Connections

- location, 3-18

Patient data

- deleting, 4-25
- OB, 4-9, 8-9
- OB graphs, 8-24
- OB worksheet, 7-65
- searching, 4-21

patient exam

- reviewing, 9-10

patient safety, 2-7

Patient Screen

- active images, 4-3
- Data Transfer, 4-3
- Image History, 4-3

Peak systole (PS)

- OB/GYN vessel measurement, 7-36

Peak systole/end diastole ratio, Doppler generic measurements, 7-34

pediatric exam

- calculations, 8-81

pediatric measurements, types

- alpha HIP, 8-84
- dD ratio, 8-85
- hip dysplasia, 8-82

peripherals

- connector panel, 3-13

peripherals, digital

- setting up, 9-46

Phantoms, 12-53

Plot Both, fetal trending, 8-22

Plot Control

- line style, 13-167
- vertical auto scaling, 13-166

portable exam

- performing, 9-58

Power, 3-19

- circuit breaker, 3-21
- connection
  - USA, 3-19
- Cord, 3-83
- On/Off, 3-22
- shut down, 3-37
- switch, location, 3-22

power

- power up sequence, 3-23

Power Assistant, 13-526

Power Doppler imaging, 5-44

prescription device, caution, 1-10

Preset Program menu

- Acoustic Output
  - Fetal Exposure, 4-8
  - Prudent Use, 4-8

presets

- organizing folders and measurements, 7-80

presets, changing

- Anotations/Libraries, 10-33

- Body Patterns, 10-42, 10-44, 10-45
- Connectivity, 10-61
- Imaging, 10-30
- System, 10-6
- presets, overview, 10-2
- previous exam data
  - entering manually, 8-23
- Probe handling and infection control, 11-16
- probe orientation, 3D/4D imaging
  - abdominal, 13-11
  - endocavity, 13-12
- probes
  - cable handling, 3-48
  - connecting, 3-46
  - coupling gels
    - coupling gels, probes, 11-46
  - deactivating, 3-50
  - disconnecting, 3-50
  - disinfecting, 11-41
  - ergonomics, 11-2
  - labeling, 2-60
  - planned maintenance, 11-49
  - probe orientation, 11-10
  - safety, 11-11
    - using protective sheaths, 11-14
  - storing, 3-51
- Prostate volume, measuring, 8-76
- prudent use, 2-4
- PS/ED or ED/PS Ratio, measuring, 7-34
- Pulsatility Index (PI), Doppler generic measurement, 7-33

## Q

- QAnalysis, 13-106, 13-152
  - Drift Compensation, 13-156
  - Exit, 13-171
  - generating a trace, 13-159
  - manipulating the sample area, 13-161
  - Plot Control, 13-156, 13-166
  - Select Image Range, 13-158
  - smoothing, 13-167
- QAPlot Control
  - horizontal sweep, 13-167
- Quality Assurance, 12-51
  - baselines, 12-54
  - frequency of tests, 12-52
  - Introduction, 12-51
  - periodic checks, 12-54
  - phantoms, 12-53
  - record keeping, 12-65
  - system setup, 12-55
  - test descriptions, 12-56
  - typical tests, 12-52

## R

- real-time 4D imaging

- acquiring data, 13-22
  - stopping acquisition, 13-29
- Record keeping, 12-65
- reference images, 3D/4D, 13-9
- Renal volume, measuring, 8-76
- Render view, 3D/4D imaging, 13-18
- Report
  - Wall Motion Analysis, 13-206
- Report Writer report templates, customizing, 13-431
- Report Writer reports
  - activating, 13-411
  - creating, 13-410
  - Direct Report, using, 13-456
  - editing, 13-415
  - factory templates, 13-414
  - inserting images, 13-423
- Resistive Index (RI), Doppler generic measurement, 7-33
- Results window, 7-12

## S

- S/D Ratio, Doppler measurement, 7-34
- safety
  - electromagnetic compatibility (EMC), 2-19
  - equipment, 2-11
  - hazards, 2-5, 2-11, 2-12, 2-44, 11-13, 11-14
    - biological, 11-39
    - smoke and fire, 2-12
  - labels, 2-49
  - patient, 2-7
    - acoustic output hazard
      - hazard, types
        - acoustic output, 2-10
    - electrical hazards, 2-9
    - mechanical hazards, 2-9
    - patient identification, 2-7
  - patient training, ALARA, 2-10
  - personnel, 2-11
  - precaution icons, defined, 2-4
  - precaution levels, defined, 2-4
  - probes, 11-11
    - handling precautions, 11-16
- Scalpel, 3D/4D imaging, 13-35
- Scan Assistant
  - Availability, 13-317, 13-320
  - Definitions, 13-321
  - Description, 13-322
  - Exporting Programs, 13-329
  - Setting Up, 13-323
  - Using, 13-325
- Scan Assistant Creator
  - Attributes, 13-348
  - Features, 13-348
  - File Handling, 13-331
  - Help, 13-331
  - Keyboard
    - Navigating, 13-347



- Measurements, *13-354*
- Overview, *13-330*
- Programs
  - Editing, *13-338*
  - Views, *13-342*
- Scoring
  - Stress Echo, *13-196*
- Sectional view, 3D/4D imaging, *13-17*
- Sensitivity/PRI, B-Flow, *5-17*
- service, requesting, *1-12*
- Shear wave imaging
  - Activating Shear wave, *13-117*
  - Configuring Shear wave, *13-113*
  - Intended Uses, *13-113*
  - Measurement Bias Information Tables, *13-125*
  - Overview, *13-111*
  - Scanning Hints, *13-140*
  - Shear wave Measurements, *13-132*
  - Typical Exam Protocol (Liver), *13-130*
  - Using Shear wave, *13-129*
- site requirements, before the system arrives, *3-3*
- small parts exam
  - thyroid measurements, *8-5*
- speakers, description, *3-10*
- Speckle Reduction Imaging-High Detection (SRI-HD)
  - see SRI-HD, adjusting
- Spectral Doppler, see Doppler Mode, PW
- Speed of Sound, *5-28*
- Split Screen, *6-18*
- split-screen imaging, *3-60*
- SRI-HD, adjusting, *5-11*
- starting an OB exam, *4-9, 8-8*
- Static 3D imaging, *13-31*
  - acquiring data, *13-31*
- storage area
  - location, *3-10*
- Strain Elastography, *13-100*
- Stress Echo
  - create a template, *13-198*
- studies
  - OB, *8-11*
- study
  - adding, *7-87*
  - definition, *7-11*
  - deleting, *7-99*
  - generic, *7-18*
  - organizing, *7-80*
- system
  - acclimation time, *3-90*
  - electrical configurations, *3-3*
  - environmental requirements, *3-4*
  - options, *10-150*
  - power down, *3-37*
- System Admin
  - Admin screen, *10-150*
- System cabinet, *12-37*
- System Imaging Preset Menu, *10-15*
- System Measure Preset menu, *10-19*

- System presets, changing
  - General, *10-8*
  - System About, *10-29*
  - System Imaging, *10-15*
  - System Measure, *10-19*
  - System Peripherals, *10-24*
  - System/Backup and Restore, *10-22, 10-189*
- System presets, overview, *10-6*
- System/General Preset Menu, *10-8*

## T

- TAMAX and TAMEAN, Doppler mode measurement
  - manual trace, *7-47*
- Test Patterns
  - overview, *3-72*
- TGC, adjusting, *5-26*
- Thyroid measurements, *8-5*
- TIC analysis
  - activating, *13-69*
  - curve fitting, *13-91*
  - exiting, *13-69*
  - generating a trace, *13-77*
  - manipulating the sample area, *13-84*
  - overview, *13-68*
  - smoothing, *13-87*
- TIC Plot Control
  - horizontal scale, *13-87*
  - line style, *13-87*
  - overview, *13-86*
  - vertical auto scaling, *13-86*
- Time Gain Compensation, see TGC, adjusting, *5-26*
- Time interval
  - Doppler mode measurement, *7-46*
  - M-Mode measurement, *7-57*
- Time-Based Store, *10-50*
- Timers
  - Stress Echo, *13-181*
- Tissue depth, M-Mode measurement, *7-56*
- Tissue Velocity Imaging, *13-149*
- Trace measurement, general, *7-40, 7-42, 7-43*
- TVD, *13-151*
- TVI, *13-151*

## U

- Ultrasound age
  - selecting on OB worksheet, *7-65*
- Ultrasound-Guided Attenuation Parameter (UGAP)
  - Option, *13-141*
- Unlock the monitor, *3-65*
- urology exam, preparing, *7-12, 8-2*
- urology measurements
  - bladder volume, *8-75*
  - prostate volume, *8-76*
  - renal volume, *8-76*
- USB Quick Save, *9-45*
- user IDs

---

- defining, *10-153*
- User label
  - set up, *3-78*
- user-defined calculations, editing, *7-98*
- user-defined measurement, adding, *7-89*
- Users
  - Admin screen, *10-153*
- Uterine cavity, amniotic fluid index (AFI), *8-13*
- Uterus measurements, *8-44*
- Utility screens
  - Admin, *10-141*
  - connectivity, *10-61*

## V

- Vascular measurements, selecting, *8-69*
- Vascular worksheets
  - saving and printing, *7-64, 7-70*
  - vessel summary, *7-68*
- Velocity, Doppler measurement, *7-46*
- Vessel summary, vascular exam, *7-68*
- Volume measurement, B-Mode generic measurement, *7-22*
- Volume Navigation ConnectionssollIndicator
  - location, *3-18*

## W

- Warning icon, defined, *2-4*
- wheels, console, *3-86*
- word wrap, annotation, *6-33*
- Worksheet
  - viewing, *7-58*
- Write Zoom, activating, *6-15*

## XYZ

- zooming an image
  - bioeffects, *6-15*

