

Anexa 28 Dispozitiv fizioterapeutic pentru laseroterapie și cu ultrasunet, Model: PhysioGo 600C, Astar, Nr. de inregistrare AMDM: DM000663231

Specificarea tehnică deplină solicitată, Standarde de referință	Specificarea tehnică deplină oferita, Standarde de referință
<p>Dispozitiv fizioterapeutic pentru laseroterapie și cu ultrasunet Cod 400172 Descriere Dispozitivul portabil de laseroterapie și cu ultrasunet este destinat utilizării în cabinete de fizioterapie, recuperare medicală, reumatologie, ortopedie și medicină sportivă pentru ameliorarea durerii acute și cronice musculo-scheletale, reducerea inflamației și edemului, accelerarea vindecării rănilor, stimulare regenerării țesuturilor moi. Parametru Specificație Laser: Clasa dispozitivului cu laser 3B Laser roșu obligatoriu Laser infraroșu obligatoriu Ultrasunet: Frecvența de lucru diapazon minim 1-3 MHz Moduri de operare continuu sau pulsatoriu Funcționalități: Protocoloale de lucru presetate obligatoriu Protocoloale de lucru personalizate obligatoriu</p> <p>Cronometru diapazon 1-99 min Portabil obligatoriu</p> <p>Alimentare 230V ± 10%, 50 HZ Accesorii "Sonda roșu ≥ 1 buc, să se indice codul produsului" "Sonda infraroșu ≥ 1 buc, să se indice codul produsului" "Sondă ultrasunet (~1 cm²) ≥ 1 buc, să se indice codul produsului" "Sondă ultrasunet (~4-5 cm²) ≥ 1 buc, să se indice codul produsului" "Ochelari de protecție ≥ 2 buc, să se indice codul produsului" Gel de contact: ≥ 1 litru, să se indice codul produsului Set de accesorii standard - obligatoriu</p>	<p>Dispozitiv fizioterapeutic pentru laseroterapie și cu ultrasunet Cod 400172 Descriere Dispozitivul portabil de laseroterapie și cu ultrasunet destinat utilizării în cabinete de fizioterapie, recuperare medicală, reumatologie, ortopedie și medicină sportivă pentru ameliorarea durerii acute și cronice musculo-scheletale, reducerea inflamației și edemului, accelerarea vindecării rănilor, stimulare regenerării țesuturilor moi. -manual pag.49, Parametru Specificație Laser: Clasa dispozitivului cu laser 3B- broșura, pag.2 Laser roșu - da, broșura, pag.2 Laser infraroșu -da, broșura, pag.2 Ultrasunet: Frecvența de lucru diapazon 1-3,5 MHz- broșura, pag.2 Moduri de operare continuu sau pulsatoriu- broșura, pag.1 Funcționalități: Protocoloale totale de lucru presetate da, -233 programe, broșura pag.2 Protocoloale totale de lucru personalizate: ultrasunet - 50 programe, , broșura pag.2 Laserterapie- 50 programe pentru fiecare aplicator, broșura pag.2 Cronometru diapazon 1s-100 min - broșura, pag.2 Tip Portabil- da, tinind cont ca atit dispozitivul cit si aplicatorii nu sunt voluminosi, acestea pot fi transportati, broșura, pag.2 Alimentare 230V, 50/60Hz, broșura, pag.2 Accesorii "Sonda roșu - 1 buc, Cod: A-AL-AST-80RDV3- broșura pag.3 "Sonda infraroșu ≥ 1 buc, Cod: A-AL-AST-400IRV3- broșura pag.3 Sondă ultrasunet (-1 cm²):1 bucată, cod: A-AS-AST-GS1WH broșura, pag.3 Sondă ultrasunet (-4 cm²): 1 bucată, cod:A-AS-AST-GS4WH, broșura, pag.3 Ochelari de protecție - 2 buc, laser therapy protective goggles, broșura, pag.4 Gel de contact: - 1 litru(2butelii/500g), ultrasound gel 500 g, broșura, pag.4 Set de accesorii standard – da, broșura pag.4</p>



PhysioGo 600C

Biostimulation laser therapy
Ultrasound therapy



Features

product code	A-UC-AST-PHG600C	
color display with touch panel	7"	
independent treatment channels	2	
manual mode of operation	✓	
program mode of operation	✓	
disease entities selected by name or medical field	✓	
preset treatment programs database	✓	
possibility of creating user programs	✓	
favorite programs	✓	
possibility of program names edition	✓	
encyclopaedia describing the treatment methodology	✓	
treatment statistics	✓	
buzzer sound volume regulation	✓	
battery	✓	

Ultrasound therapy

water-resistant US heads (IPX7)	✓
continuous/ pulse emission	✓
ultrasound head contact control (effective treatment time measured)	✓
head sensitivity calibration according to the needs	✓

Laser therapy

operation with applicators: scanning laser, cluster laser and point probes	✓
emission modes: continuous and pulse	✓
regulation of laser power radiation	✓
duty factor regulation	✓
automatic laser radiation power test	✓
automatic calculation of time relative to treatment parameters - dose, power, duty factor, treatment area	✓

Preset treatment programs

preset treatment programs, including:	
for ultrasound therapy	58
IR point probe programs	39
R point probe programs	18
programs with Nogier frequency	8
programs with Voll frequency	30
preset sequences for scanning laser applicators	26
cluster laser applicator programs	54

three modes of treatment field irradiation in scanning laser applicators	✓	user-defined programs	
dedicated modes for working with optic fiber applicators	✓	user-defined programs – ultrasound therapy	50
optical fiber applicators for laserpuncture and ENT applications	✓	user-defined programs – biostimulation laser therapy	50 (for each applicator)
pilot beam indicating the application site	✓	favorite programs	✓

Ultrasound therapy technical parameters

operating frequency	1 & 3.5 MHz
effective radiation area	1 cm ² , 4 cm ²
maximum ultrasound wave intensity	2/3 W/cm ²
frequency in pulse mode	16 Hz, 48 Hz, 100 Hz
duty factor in pulse mode	5 - 75 %, step 5%
treatment timer	30 s - 30 minutes

Laser therapy technical parameters

laser device class	3B
treatment timer	1 s - 100 minutes

Laser therapy parameters - biostimulation laser point probes

red light laser point probes wavelength	660 nm
maximum power of the red light point probes	80 mW
infrared laser point probes wavelength	808 nm
maximum power of the infrared point probes	400 mW
power regulation	25%, 50%, 75%, 100%
pulse mode frequency	1 - 5000 Hz
duty factor in pulse mode	10 - 90%, pulse 50 ?s

Laser therapy parameters - scanning laser applicator

scanning laser applicator wavelength	808 & 660 nm
maximum power of the scanning laser applicator	450 & 100 mW
power regulation	50%, 100%
pulse mode frequency	1 - 5000 Hz
duty factor for scanning laser applicator pulse mode	75%

Laser therapy parameters - cluster laser applicator

cluster laser applicator wavelength	4x 808 nm & 5x 660 nm
maximum power of the cluster laser applicator	4x 400 mW & 5x 40 mW
power regulation	50%, 100%
pulse mode frequency	1 - 5000 Hz
duty factor in pulse mode	10 - 90%, pulse 50 ?s

General technical parameters

dimensions	34 x 28 x 11-16 cm
device weight	6 kg
power supply	230 V, 50/ 60 Hz

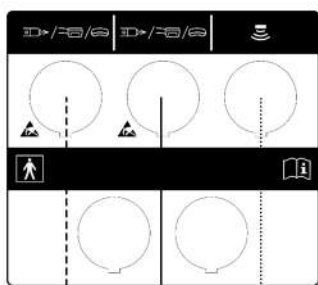

PhysioGo 601C

A-UC-AST-PHG601C

Optional accessories



A-AL-AST-CL1800WH



A-AL-AST-SK450V2WH



A-AL-AST-80RDV3



A-AL-AST-400IRV3



A-AS-AST-GS1WH



A-AS-AST-GS4WH

Standard accessories

- DOOR remote interlock connector
- electrical safety test report
- instructions for use
- mains cable
- masking covers with cutout
- masking covers without cutout
- screwdriver
- spare fuses
- technical description
- touchscreen cloth
- touchscreen pen
- ultrasound gel 500 g
- warning labels

Optional accessories

- bag for the unit, parts and accessories
- cluster applicator stand
- cluster laser applicator CL 1800 R 5 x 40 mW and IR 4 x 400 mW with holder
- laser therapy protective goggles
- optical fiber applicators: straight \varnothing 6 mm, angled 45 \varnothing 6 mm, angled 45 \varnothing 6 mm narrowed with holder
- point applicator IR 808 nm/ 400 mW with holder
- point applicator R 660 nm/ 80 mW with holder
- scanning applicator R+IR 100 mW + 450 mW with stand
- ultrasound head 1/ 3.5 MHz, 1 cm² with holder
- ultrasound head 1/ 3.5 MHz, 4 cm² with holder
- Versa trolley
- Versa X trolley

ΔSTAR.

PhysioGo
Technical description

CE
0197

Contents

1.	BASIC INFORMATION	5
1.1	MANUFACTURER	5
1.2	RISK MANAGEMENT PROCESS	5
1.3	INTENDED USE OF PHYSIOGO DEVICES.....	6
1.4	MODEL LIST	7
1.5	INTENDED USERS	7
1.6	USER TRAINING	8
2.	WARRANTY AND MANUFACTURER'S RESPONSIBILITY	9
3.	OPERATIONAL SAFETY	10
3.1	MAINS SUPPLY AND OPERATION MODE	10
3.2	STORAGE, OPERATION AND TRANSPORT CONDITIONS	10
3.2.1	<i>Acclimatization of the unit</i>	10
3.3	WARNINGS AND SAFETY NOTES	11
3.4	EXPLOSION PROOF ENVIRONMENT	14
3.5	ELECTROMAGNETIC ENVIRONMENT	15
3.6	OPERATION OF TOUCH-SENSITIVE DISPLAYS	15
3.7	ESSENTIAL PERFORMANCE	15
3.7.1	<i>Test of essential performance and basic safety</i>	16
3.8	EYE PROTECTION	17
3.9	LASER LABELS	19
3.10	APPLIED PARTS	20
3.11	DISPOSAL	20
4.	UNIT DESCRIPTION	21
4.1	GENERAL CHARACTERISTICS	21
4.2	FRONT PANEL	22
4.2.1	<i>Operation status and battery level indicators</i>	23
4.3	MOUNTING OF ACCESSORY HOLDERS	24
4.4	NAME PLATE	25
4.4.1	<i>UDI code</i>	26
4.5	CURRENT AND VOLTAGE STABILIZATION – CC AND CV MODE	26
4.6	LASER RADIATION MEASUREMENT	27
4.7	PROTECTION	27
4.7.1	<i>DOOR remote connector</i>	27
4.7.2	<i>Laser emergency stop</i>	27
4.7.3	<i>Patient's stop switch</i>	27
4.7.4	<i>Open circuit detection</i>	28
4.7.5	<i>Current accuracy control in CC mode</i>	28
4.7.6	<i>Overcurrent in CV mode</i>	28
4.8	LASER APPLICATORS	28
4.9	MAGNETIC FIELD APPLICATORS	30
4.10	ULTRASOUND HEADS	31
4.11	SAFE SHUTDOWN PROCEDURE	32
5.	DEFINITIONS AND PARAMETERS	33
5.1	ELECTROTHERAPY	33
5.1.1	<i>Terminology</i>	33
5.1.2	<i>Output signal modulations</i>	33
5.1.3	<i>Galvanic current</i>	34
5.1.4	<i>Diadynamic currents</i>	34
5.1.5	<i>Rectangular and triangular pulse currents</i>	35
5.1.6	<i>Kotz' current (Russian stimulation)</i>	37
5.1.7	<i>TENS pulse current</i>	38
5.1.8	<i>SP-TENS pulse current</i>	40
5.1.9	<i>Interferential currents</i>	41
5.1.10	<i>USS – Unipolar Sine Surge</i>	42
5.1.11	<i>Tonolysis</i>	44
5.1.12	<i>Microcurrents</i>	45
5.2	ULTRASOUND THERAPY	46
5.3	COMBINED THERAPY	48

5.4	LOW FREQUENCY MAGNETOTHERAPY	48
5.5	LASER THERAPY.....	49
5.5.1	Point laser applicators.....	50
5.5.2	Scanning applicator.....	51
5.5.3	Cluster applicator.....	52
5.6	INTENDED CLINICAL BENEFITS OF THE THERAPIES	53
6.	MAINTENANCE, CLEANING, DISINFECTION	55
6.1	CLEANING OF THE UNIT CASING	55
6.2	CLEANING OF TOUCHSCREEN	55
6.3	CLEANING AND DISINFECTION OF THE ELECTROTHERAPY ACCESSORIES AND DETACHABLE PARTS	55
6.4	CLEANING AND DISINFECTION OF THE ULTRASOUND HEADS.....	56
6.5	CLEANING AND DISINFECTION OF THE SCANNING AND CLUSTER APPLICATOR	56
6.6	CLEANING AND DISINFECTION OF THE POINT LASER APPLICATORS	56
6.6.1	Disinfection and sterilization of the optical fiber applicators.....	57
6.7	CLEANING AND DISINFECTION OF MAGNETIC FIELD APPLICATORS	57
6.8	VERIFICATION OF INTERCONNECTING CABLES AND ELECTRODES CONDITION	57
6.8.1	Cable condition control	57
6.8.2	Electrode condition control.....	58
6.9	US HEAD CALIBRATION	59
6.10	SELF-TEST PROCEDURE.....	59
6.11	TROUBLESHOOTING	60
6.12	FUSE REPLACEMENT	61
6.13	BATTERY.....	61
6.12.1.	Battery damage.....	61
7.	SPECIFICATION AND PARTS OF THE UNIT	63
7.1	SPECIFICATION	63
7.2	EMC PARAMETERS.....	65
7.3	STANDARD AND OPTIONAL PARTS OF THE UNIT	66
8.	SYMBOLS DESCRIPTION, I(T) CURVE CARD	67
8.1	CONTROLLER, PARTS OF THE UNIT, PACKAGING.....	67

Table of figures

Figure 3.1.	Unit acclimatization process.....	10
Figure 3.2.	Laser labels	20
Figure 4.1.	General view.....	21
Figure 4.2.	Unit's rear panel view – version 2.0	21
Figure 4.3.	Unit's rear panel view – version 1.0	22
Figure 4.4.	Arrangement of front panel components	22
Figure 4.5.	Sample view of mounting the holders for point laser applicator and ultrasound head	24
Figure 4.6.	Sample view of mounting the holder for cluster laser applicator	25
Figure 4.7.	Name plate of PhysioGo device – version 2.0	25
Figure 4.8.	Name plate of PhysioGo device – version 1.0	25
Figure 4.9.	Label with parameters.....	25
Figure 4.10.	UDI code – example.....	26
Figure 4.11.	Rough diagram of the output circuit of the PhysioGo unit working in CV mode (one channel).....	26
Figure 4.12.	Point laser applicators and optical fibers	29
Figure 4.13.	Laser scanning applicator – panel description.....	29
Figure 4.14.	Scanning and cluster laser applicators	30
Figure 4.15.	Laser cluster applicator - panel description.....	30
Figure 6.1.	Battery damage message	62
Figure 6.2.	Permanent blockade message.....	62

1. Basic information

Read this Technical description as well as Instructions for use dedicated to a particular unit model carefully before starting the unit operation! Follow the recommendations presented in those documents!

PhysioGo unit should be installed by the seller. The recipient has the right to insist on the product operation training. The unit may only be operated by qualified personnel or under supervision of such personnel!
WARNING: The device is intended for adult patients only. It is not intended for use in a home healthcare environment.

Revision 20.0 and higher of this instruction applies to a device that complies with the requirements of Regulation (EU) 2017/745 of the European Parliament and of the Council of 5 April 2017 on medical devices.
Revision 22.0 and higher of this instruction applies to devices with hardware versions 1.0 and 2.0 – the device version can be found on the nameplate (see 4.4).

Description of symbols used in this instruction:



Read appropriate passage of the technical description, warnings or important information. Failure to observe warnings can lead to injuries.



Important notices and information.



Following texts marked with this symbol facilitates device operation.

NOTE:

The outlook of screenshots shown in this manual may slightly differ from their actual outlook during device operation. These differences may concern size and type of fonts and size of symbols. There are no differences in the content of shown information.

NOTE: This manual contains technical description and is a part of instructions for use. This Technical description is provided in the paper form. It is possible to receive a copy of it in the form of a file. To do this, please submit the form available at <https://astar.eu/instructions/>

WARNING: No modification of this equipment is allowed!

NOTE:

In this document, the term 'battery' is used interchangeably with the term 'rechargeable battery' and means an internal power source.

1.1 Manufacturer

ASTAR Sp. z o.o.
ul. Świt 33
43-382 Bielsko-Biała, Poland
www.astar.eu

1.2 Risk management process

The manufacturer conducts continuous risk management process referring to the device construction, its intended use, method of operation and maintenance. Residual risks are presented in this manual in form of information about precautions, contraindications and warnings.

1.3 Intended use of PhysioGo devices

PhysioGo units are active, noninvasive therapeutic devices. Depending on the model, it is possible to carry out treatment procedures:

- bipolar (bidirectional) and unipolar (unidirectional) low frequency currents,
- bipolar (bidirectional) medium frequency currents and unipolar (unidirectional) medium frequency currents modulated by low frequency waveforms,
- low frequency magnetic field,
- laser radiation within the visible (for wave length 660 nm) and invisible range (for wavelength 808 nm),
- using ultrasound therapy and phonophoresis,
- combination method of current and ultrasounds.

Their specific medical purposes are:

- treatment or alleviation of disease,
- treatment or alleviation of an injury or disability.

The units are equipped with fully independent treatment channels. The units possess the base of pre-defined treatment procedures along with therapeutic encyclopedia, which significantly increases comfort of operation. There is also a possibility to create own user-defined:

- programs – for all therapies,
- sequences – for electrotherapy.

With regard to magnetotherapy, the unit may be used with coupled plate applicators CPE type in single or dual configuration. The treatment procedure is carried out locally, the magnetic field is focused only on the part of the body, which will be subjected to therapy. In contrast to the classical method of magnetic field application with the use of solenoid applicators, such a solution substantially reduces the impact of magnetic field on the other parts of the patient's body and the unit's environment, including the operating personnel.

As regards to laser radiation, the unit may be operated with point, cluster and scanning laser applicators. Due to the available maximum radiation power output at the level of 450 mW for wavelength 808 nm and 100 mW for 660 nm, the PhysioGo unit is classified as a small power output laser device. In physiotherapy such lasers are designated as "cold", "soft" or biostimulating.

In the range of ultrasound therapy, PhysioGo unit may cooperate with the following types of ultrasound heads:

- dedicated to standard ultrasound therapy with the effective radiation area 4 cm², which generates the ultrasound wave with 1 MHz or 3,5 MHz frequency,
- dedicated to standard ultrasound therapy with the effective radiation area 1 cm², which generates the ultrasound wave with 1 MHz or 3,5 MHz frequency.

The unit may perform treatments by:

- interferential currents – dynamic and isoplanar,
- one-channel sine wave current (AMF),
- Kotz' – Russian stimulation,
- TENS, BURST and formed in packages to spastic paralysis SP-TENS currents,
- tonolysis – to spastic paralysis,
- ionophoresis and galvanization of constant current (in the continuous and interrupted mode),
- triangular or rectangular pulses (in continuous and interrupted mode),
- Träbert (Ultra Reiz), Leduc' and neofaradic (in continuous and interrupted mode),
- diadynamic according to Bernard – MF, DF, CP, CP-ISO, LP currents (in continuous and interrupted mode),
- USS – Unipolar Sine Surge current,
- microcurrents,
- low frequency magnetic field in continuous and pulse mode,
- laser radiation in continuous and pulse mode,
- ultrasound, phonophoresis in continuous and pulse mode,
- combined method of electrotherapy and ultrasound therapy,
- qualitative and quantitative electrodiagnostics of the nervous-muscle system.

Due to the versatility and the optional availability of a battery, the unit is perfectly suited for use:

- in sports medicine in case of training camps,
- wherever there are problems with power supply quality.

1.4 Model list

Model	Available therapies and therapeutic channels	Other distinguishing features
100A	Electrotherapy, two independent treatment channels	---
101A	Electrotherapy, two independent treatment channels	Battery
200A	Ultrasound therapy, one treatment channel	---
201A	Ultrasound therapy, one treatment channel	Battery
300A	Electrotherapy, ultrasound therapy, three independent treatment channels	---
301A	Electrotherapy, ultrasound therapy, three independent treatment channels	Battery
400C	Laser therapy, three independent treatment channels	---
401C	Laser therapy, three independent treatment channels	Battery
500I	Electrotherapy, laser therapy, magnetotherapy, two independent treatment channels	---
501I	Electrotherapy, laser therapy, magnetotherapy, two independent treatment channels	Battery
600C	Ultrasound therapy, laser therapy, two independent treatment channels	---
601C	Ultrasound therapy, laser therapy, two independent treatment channels	Battery
700C	Electrotherapy, ultrasound therapy, laser therapy, three independent treatment channels	---
701C	Electrotherapy, ultrasound therapy, laser therapy, three independent treatment channels	Battery
700I	Electrotherapy, ultrasound therapy, laser therapy, magnetotherapy, three independent treatment channels	---
701I	Electrotherapy, ultrasound therapy, laser therapy, magnetotherapy, three independent treatment channels	Battery

1.5 Intended users



The patient should not be the operator.

Users (operators) of PhysioGo device can be:

- specialists in the field of the electrotherapy, ultrasound therapy, combined method of electrotherapy and ultrasound therapy, low frequency magnetic field therapy and laser therapy,
- physiotherapists specializing in the therapy of the musculoskeletal system,
- sports medicine specialists,
- aesthetic medicine specialists,
- trained personnel performing treatments under the supervision of the above-mentioned specialists.

The user should have:

- knowledge about the indications and contraindications for the use of electrotherapy, ultrasound therapy, combined method of electrotherapy and ultrasound therapy, low frequency magnetic field therapy and laser therapy,
- knowledge of the terminology and technical terms used in the manual (e.g. knowledge of units of physical quantities),
- practical skills in performing therapeutic treatments using multifunctional devices, resulting from education, experience and training.

Physical and cognitive requirements of the operator:

- eyesight enabling to recognize elements of keyboard and display,
- hearing enabling to hear the patient's voice,
- reading comprehension that allows to read the Instructions for use and information on the casing of the device,
- two functional upper limbs that allow to perform treatments and other activities related to the operation of the device (e.g. cleaning of applicators),
- age in the range of admissible value of professional activity (depending on the regulations of the country where the device is used).

1.6 User training

The PhysioGo user has to be properly trained in the device safe and effective use, before starting the operation. Training in the rules of operation can be carried out by representatives of the manufacturer or seller, based on the Instructions for use and Technical description. Recommended training positions:

- information about the intended use of the device,
- occupational safety information,
- information on the construction and method of the output signals generation,
- information on available settings and operation modes,
- instructions for use,
- indications and contraindications for the therapy,
- information on recommended maintenance, cleaning and disinfection,
- handling in the event of a technical malfunction.

Due to requirements of local law and regulations in different countries, additional training activities may be required. The user should inform the seller about such requirements in order to receive complete information.

2. Warranty and manufacturer's responsibility



The manufacturer warrants the controller, laser applicators, magnetic field applicators and ultrasound heads to be free of faults for the period of time and conditions stated in Warranty Certificate. The manufacturer also provides post-warranty service for a period of 10 years from launching the unit onto the market. The warranty includes all material and workmanship faults.

The manufacturer undertakes to observe the warranty agreement, if the following conditions are met:

- all repairs, changes, upgrades and calibrations of equipment are performed by the manufacturer or authorized service personnel,
- firmware updates are performed by the manufacturer, an authorized service personnel or distributor,
- the mains supply system in the treatment room meets requirements of standards in force,
- the unit is operated by qualified personnel, in compliance with instructions presented in the Instructions for use,
- the unit is operated in compliance with its intended use.

The warranty does not include consumables, such as electrodes, viscose covers, connection cables, mains cables, patient's cables, gas springs, laser applicator lenses, holders and fuses, as well as faults or damage caused by:

- improper placement, installation, or configuration of the device,
- misuse or failure to observe the instructions presented in this Instructions for use,
- inaccurate or inadequate maintenance carried out by the operator,
- improper environmental conditions specified for the product,
- unauthorized opening of the outer casing,
- adjustment and/or unauthorized tuning,
- use of non-original parts of the unit.

The warranty does not cover any damage due to a failure to adhere to the recommendations stated in chapters 3.3 and 6 hereof.

The manufacturer is not liable in case of infection transmission by parts of the unit.



The expected "life time" of the device is 10 years.

After elapse of 10 years from date of introduction of device, accessories and detachable parts in the market the manufacturer is not liable for device, accessories and detachable parts faults or its consequences. After elapse of the expected life time of the device the user bears the complete responsibility for the occurrence of medical incidents.

The manufacturer bears no responsibility for results of faulty installation, wrong diagnosis, wrong use of the device and parts of the unit, failure to observe Instructions for use and performance of repairs by unauthorized persons.



**Inside the device there are no user serviceable components, except for fuses.
No parts can be serviced or maintained when the device is in use with a patient.**

The firmware that is part of the device is not intended to be installed, configured or updated by the user.

On demand, the manufacturer makes available technical diagrams, parts lists, descriptions, instructions for calibration or other helpful information to appropriately qualified user's technical staff to repair these parts of unit, which are described by the producer as a reparable.

3. Operational safety

3.1 Mains supply and operation mode



Each PhysioGo unit is designed for supply from AC mains with rating and frequency shown on the nameplate. It is a medical device under safety class I, type BF. The unit may be used only in rooms, where the electric system is executed in compliance with standards in force. The unit is intended for continuous operation. It is not necessary to switch it off from the mains between particular treatment procedures.

The unit is connected to the mains using the detachable power cord. The power supply cord is equipped with a mains plug that isolates the device from the supply mains on all poles simultaneously.



Recommendations related to isolation the device from the supply mains:

- Do not position the device so that it is difficult to operate the disconnection of the device from the supply mains.
- To isolate the device from the supply mains, hold the mains socket-outlet with one hand, grasp the mains plug with second hand and disconnect it from the mains socket-outlet.

Disconnection from the mains takes place after:

- removing the mains cable plug from the mains power socket,
- removing the mains cable plug from the socket on the unit,
- switching the mains switch to the "0" position.

Selected models are equipped with rechargeable battery which allows for operation without, or in conditions of reduced quality of power supply.

3.2 Storage, operation and transport conditions

The PhysioGo unit must be stored in closed rooms, where the atmosphere is free from vapors and caustic substances and:

- the temperature is maintained between +5°C and +45°C,
- relative humidity does not exceed 75%,
- atmospheric pressure value is between 700 and 1060 hPa (70 – 106 kPa).

The unit is intended for operation under the following conditions:

- ambient temperature between +15°C and +30°C,
- relative humidity between 30% to 75%,
- atmospheric pressure between 700 to 1060 hPa (70 – 106 kPa).

If further transport of the device is required, use the delivery packaging. Transport shall be performed with covered transport means. Recommended transport conditions:

- ambient temperature between -10°C to +45°C,
- humidity between 20% and 95%,
- atmospheric pressure between 700 and 1060 hPa (70 – 106 kPa).

3.2.1 Acclimatization of the unit

The acclimation procedure is started automatically on activating the device, if the temperature of any module is lower than 10°C. The following message with a progress bar is displayed on the display screen:

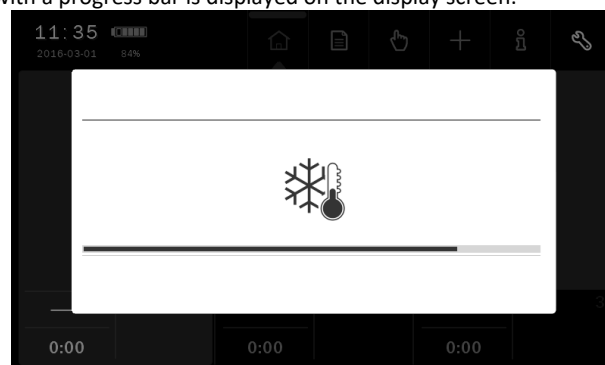

Figure 3.1. Unit acclimatization process

The acclimation lasts to a maximum 10 minutes. If during this time the temperature rises to the limit value, the unit will reboot and it will be possible to use it normally.

If, in spite of many attempts to start the unit, the acclimatization process is not properly completed, it may indicate that one of the temperature sensors is damaged. In this case, contact your authorized service.

Important! We do not recommend to turn off the unit during the acclimatization process!



3.3 WARNINGS and safety notes

The PhysioGo unit has been designed and manufactured in such a way that its use does not jeopardize the health and safety of patients, users and third parties, as well as the unit should provide therapeutic benefits to patients if it is operated in appropriate conditions and in accordance with its intended purpose.

General:

- The unit may be operated by qualified personnel in compliance with instructions presented in the chapter 1.5.
- To avoid the risk of electric shock, the equipment must only be connected to mains supply with protective earth pin.
- No modification of this equipment is allowed!
- The treatment station (bed, couch) shall be located away from other electric devices and water supply / sewerage installation / central heating system, so that it is impossible for the patient to touch any of them during treatment procedure.
- Do not position PhysioGo so that it is difficult to operate the disconnection of the device from the supply mains.
- Replacement of the lithium battery applied to back up the clock should be performed by the manufacturer or authorized service personnel. Incorrect replacement (e.g. reversed polarization) would result in hazardous situation such as excessive temperatures, fire or explosion.
- Do not remove warning signs and labels put by the manufacturer on the unit casing, accessories and detachable parts.
- The unit, laser applicators, magnetic field applicators and ultrasound heads shall be protected against high temperatures and atmospheric conditions (e.g. direct sunlight).
- Detachable parts and accessories should be regularly inspected. Damaged cables, electrodes and/or heads shall be replaced immediately. Pay special attention to the casing cracks, threadbare insulation and partially torn interconnecting cables.
- Prevent any fluid from penetrating inside the unit, accessory or detachable parts. In case of any fluid getting inside the unit, switch the unit immediately off, isolate from the mains and contact service to inspect the unit.
- By any means do not cover the vents. Do not insert any objects into the ventilation socks.
- The unit may be only used with accessories, detachable parts, spare parts, disposable items which have been determined to be safe and appropriate inspection bodies have not issued contraindications against their use.
- Ultrasound heads are sensitive to mechanical damages that is why they should be used with caution. Throwing, banging against hard surfaces and similar actions that may lead to damage of the ultrasound head shall be avoided. Careless use of the head may make its properties worse.
- Ultrasound heads and laser applicators are particularly sensitive to very low and very high temperatures. Special attention should be paid while connecting the device to the mains supply when it is too much cooled (e.g. winter period, right after delivering by the courier company).
- Ultrasound heads may only be connected to the sockets when the mains supply is switched off. Each head contains memory with calibration data that are checked by microprocessor during self-test phase. Plugging head to switched on unit will make the head undetected, so its use will not be possible! Sometimes it may also damage the ultrasound head.
- The ultrasound head has dedicated transport packaging. The front of the head is protected by rubber cover, which secures it against mechanical damage during delivery. The cover must be removed before use. It is not recommended to use it between treatments due to the possibility of damaging head parts.
- Laser applicators may only be connected to the sockets when the mains supply is switched off. Connecting of probes with the power on, may cause irreversible damage of the laser diode which is beyond the scope of warranty repairs!
- CPE applicators are not identical to CPEP applicators for PhysioMG magnetotherapy devices. They cannot be used interchangeably.
- GS heads are not identical to GU heads used in ultrasound therapy devices of PhysioGo.Lite family. GU heads and GS heads cannot be used interchangeably.
- SnG head is not supported by PhysioGo devices.
- Refers to the unit without the battery supply – after switching the unit off, wait for 10 seconds before you switch it on again.

- Each serious incident concerned with the device should be reported to the manufacturer and competent authority of the country, where the user or patient resides. Serious incident means any incident that directly or indirectly led, might have led or might lead to any of the following:
 - the death of a patient, user or other person,
 - the temporary or permanent serious deterioration of a patient's, user's or other person's state of health,
 - a serious public health threat.

Occupational health and safety – laser therapy:

- Unit operation with laser applicators is only possible, when DOOR plug is inserted into the unit socket designated DOOR and when after switching on the unit the right code was entered.
- Patient and operator must wear protective glasses during treatment. See section 3.8 for information. Do not allow unauthorized persons to enter the treatment room without wearing safety goggles.
- Do not look directly into the laser beam, also avoid looking on reflected rays.
- Avoid directing laser beam onto surfaces, which reflect light.
- Each treatment procedure must be started at the moment, when laser applicator is set in the right direction.
- It is recommended, that walls of room, where the laser is operated, disperse to the greatest possible extent laser radiation incident of them. The color of walls must be so matched that the incident laser beam be visible. It should be added that some surfaces, which disperse visible light, may reflect infrared radiation emitted by laser.
- It is recommended to operate the unit, as far as possible, in a room dedicated exclusively to performance of laser therapy treatment procedures. If fulfilling this recommendation is not possible, we suggest to separate an area within the room used for different purposes in such a way that no emission of laser radiation outside the delimited area is possible.
- It is recommended to mark the room, where the laser therapy treatment procedures are performed, with warning labels and information delivered together with the unit.
- It is recommended to connect to the DOOR socket, located in the right side wall of the unit, with delivered plug (plug with DOOR symbol) the connector of remote lock of the room's door, where treatment is performed. To obtain additional information, contact manufacturer's service.
- In case, when the User does not intend to mount in the door the remote lock connector, its task is completely fulfilled by DOOR plug.
- Point laser applicators may be operated according to contact or contact free method, cluster and scanning laser applicators work contact free method only.
- Please take special care when handling laser applicator lens, do not hit it against hard surfaces, and avoid scratches. Mechanical damage of lens may cause reduction in power output of laser radiation emitted by the probe.
- Caution should be exercised when cleaning glass elements and transparent laser applicators to avoid scratches.

Occupational health and safety – magnetotherapy:

- During the treatment carried out near the head, the patient should wear protective glasses (they are part of the equipment).
- During the treatment of magnetotherapy the personnel operating the unit and the bystanders should not be at the distance less than 1 m from any plate magnetic field applicator.
- A long-lasting exposure of personnel and bystanders on magnetic field could cause irritation, concentration impaired, headache and/or insomnia.
- Before the treatment the patient should take off metal elements of clothing and a watch and remove metal objects from their pocket. The appropriate prohibition label is placed on the applicator housing.
- Third parties are not allowed in the treatment room.
- In the treatment room with unit for magnetic therapy it is necessary to designate and mark magnetic field exposure zones in accordance with national regulations.

Increased temperatures:

- During operation of the cluster laser applicator, the head surface (polycarbonate panel) may be heated. The direct contact of this surface with the patient's body is not intended. The contact may be incidental, temporal, with the contact time less than a minute. Permissible temperature for such a situation and the applicator's material is 60°C according to table 24 IEC 60601-1.

Therapeutic – general:

- The device is intended for adult patients. Patient must be conscious.
- It is impermissible for the patient to carry out the treatment on their own.
- It is prohibited to leave the patients unattended during treatments.
- It is necessary to continuously update knowledge and follow literary activities in the scope of therapy.
- Patients with implanted electronic devices (e.g. cardiac pacemakers, cardioverter defibrillator, spinal cord stimulator) or other metal implants should be consult a physician prior to treatment.

- Before treatment it is necessary to interview the patient, including the occurrence of relative and absolute contraindications to conduct therapy.
- It is necessary to keep records of the treatment, including the parameters of the therapy, the area of treatment, treatment technique, dose and symptoms after therapy.
- Do not perform treatments on patients under the influence of alcohol.
- Do not perform treatments on patients under the influence of intoxicants.
- It is necessary to ensure the adequate interval between treatments for the patient, in order to avoid an increase of the risk of complications.
- Take special care with patients with disturbed superficial sensation.
- Immediately disconnect the patient in the case of appearing warning or error messages on the display.
- Sitting or reclining position should be applied to the patients with respiratory disorders or breathing difficulties.
- The patient should be in a position causing loosening of the part of the body subjected to therapy.
- The patient should immediately report an increase of pain or other unpleasant sensations.

Therapeutic – electrotherapy:

- Treatment parameters and electrodes placement should be consistent with the medical indications.
- Connect the cables to the patient at a time when the device does not generate the electricity to avoid the risk of electric shock.
- Electrodes should not be placed alongside the carotid artery (carotid sinus), in the area of reproductive organs, in the lower abdomen and over the internal organs.
- It is necessary to take precautions in case of the occurrence of surface metal implants in the spot of application.
- Do not use electrotherapy at the area of application of surgical staples in the skin, or on tissues protected with dressings or materials containing metal ions (silver, zinc).
- If it is possible, the treatment polarity should be adjusted so that the negative pole ought to be "further" from the heart than the positive one.
- It is not recommended to place electrodes in chest area, as it may increase the risk of ventricular fibrillation.
- Do not place electrodes on the neck and transcranially for epileptic patients, because stimulation may cause seizures.
- Unless specifically indicated by a doctor, avoid placing electrodes that form the circuit on the chest and upper back or crossing over the heart.
- Unless specifically indicated by a doctor, avoid applying electrical stimulation directly on the eyes or mouth.
- In case of treatment performed near the head, the patient should be in lying position.
- Simultaneous performance of electrotherapy treatments and therapies with the use of high frequency equipment (diathermy and electro surgery) may result in burns where electrodes are applied.
- It is necessary to use operational and sanitized electrodes. Inadequate choice of electrodes may cause skin irritations or burns.
- It is recommended to differentiate the electrodes size according to performed treatment in order to do not exceed the current density:
 - 0,2 mA/cm² for currents with constant component (unipolar) – galvanic, diadynamic, pulse currents, unipolar sine surge, tonolysis,
 - 2 mA/cm² for bipolar currents – TENS, Kotz', interferential.

Improper selection of electrodes can cause skin irritation and burns.

- Carrying out treatments, where for the applied electrodes it is necessary to set the current/voltage so that the current density does not exceed 2 mA/cm², may require particular attention of the physiotherapist.
- Irritation and skin burns may occur during performing electrical stimulation. If such syndromes occur you are obliged to interrupt the treatment and immediately consult with a doctor.
- It is not recommended to apply unidirectional currents in CV mode due to the possibility of skin burns. It is necessary to apply CC mode.
- Unless specifically indicated by a doctor, it is not recommended to treat pregnant women with electrotherapy.
- Special caution must be kept during electrotherapy treatments in older people.

Therapeutic – ultrasound therapy:

- The treatment parameters and the part of the body undergoing therapy should be as indicated by the physician.
- If two heads are connected, the head which is not used should be placed in the holder. If any of the head is not used for a longer period of time, it is recommended to disconnect this head.
- Do not perform ultrasound treatments on the cervical spine above the 3rd vertebra as the ultrasound energy could affect the medulla oblongata.
- Avoid applying ultrasound energy to internal organs of the abdominal cavity, thorax (i.e. heart area) and gonads.
- Avoid application of ultrasounds in continuous mode directly over joints with cement or plastic endoprotheses. Ultrasound in low-intensity pulsed mode can be used with caution.
- Avoid application of ultrasounds in continuous mode (causing a thermal effect) in case of dermatological diseases that are sensitive to heat, such as eczema, psoriasis. Ultrasound in the pulse mode can be used to treat open wounds with precautions (head disinfection, sterile gel, correct treatment method). The skin condition should be monitored and in case of its deterioration, the treatment should be stopped.

- Avoid application of ultrasounds in continuous mode (causing a thermal effect) over damaged nerves, because they can cause unpleasant sensations (e.g. needles and pins) and do not accelerate their regeneration.
- When performing treatments, a dynamic or semi-stationary technique should be applied. The stationary technique is not allowed.
- Use a coupling gel for ultrasound devices. The gel should be a medical equipment, marked with the conformity mark (the CE mark in EU). Avoid using a gel with undocumented origin.
- Where it is necessary to use other coupling medium (e.g. liquid paraffin), test the quality of contact detection first.
- It is recommended to use distilled water when performing treatments in water, preferably after its degasification. To degas water, boil it for 30 minutes, then close a container tightly and put it in the refrigerator to cool. Heat water to the comfort temperature for the patient before use. The presence of air bubbles during therapy may cause deterioration of operation parameters, especially at the stationary positioning of the head.
- The surface of the front head of the ultrasound transducer can degrade and its parameters can deteriorate if you use tap water with the addition of minerals, disinfectants or other chemical agents. In the extreme case, the transducer may damage.
- The therapist should keep his or her hand outside of water during treatment.
- If you use a plastic container, the dose should be corrected, because the plastic absorbs reflected ultrasound energy. If you use a metal container, the reflected energy returns to the treated body part and there is no need to correct the dose.

Therapeutic – combined therapy of current and ultrasounds:

- See warnings and information for electrotherapy and ultrasound therapy.

Therapeutic – combined therapy of current / ultrasounds and vacuum therapy:

- The unit may be operated in connection with vacuum therapy unit.
- It is recommended to cooperate with the Avaco units manufactured by Astar due to the complete compatibility.
- For information on how to make combination between devices and how to use them safely, please refer to the manual for the vacuum therapy device.

Therapeutic – laser therapy:

- It is not recommended to carry out treatments in the patients with neurological disorders, synkineses, trembling and convulsions.
- It is necessary to avoid carrying out treatments in the area of abdomen in pregnant women or women with the likelihood of pregnancy.
- The position of the patient should ensure good accessibility of the irradiated area and it should be comfortable for the patient.

Therapeutic – magnetotherapy:

- Treatments for patients:
 - having implanted electronic devices (e.g. a pacemaker) and metal implants,
 - with lesions in the initial EEG test,
 - who have experienced epileptic seizures,
 - who have undergone neurosurgical operations
 should be consulted with the attending physician. In such cases, an individual approach and precise monitoring of the course of therapy in these individuals is recommended. The attending physician should assess whether the benefits of using magnetotherapy outweigh the risks resulting from the above-mentioned factors.
- If the therapy is carried out on ulcerations, decubitus ulcers, burns in the phase with effusion or post-traumatic wounds in the inflammatory phase, the treated area should be protected with a sterile dressing, e.g. gauze.
- **Act with caution** in severe vascular diseases (obliterative arteritis of the lower limbs, diabetic angiopathy, severe angina pectoris).
- It is not recommended to treat pregnant women with magnetotherapy.
- Due to the possibility of occurrence of sleep disorders, avoid, if possible, magnetotherapy treatments carried out in the evening. This applies mainly to the elderly people.
- Treatment parameters and the arrangement of the applicators should be consistent with the medical indications.
- During therapy by means of low-frequency magnetic field the patient should not undergo X-ray examinations and ionizing radiation.



3.4 Explosion proof environment

Device is not adapted to operation in rooms, where combustible gases or their vapors occur. It is recommended to avoid anesthetic or oxygen derivate gases, such as nitrous oxide (N₂O) and oxygen. Some materials (e.g. cotton wool) may after saturation with oxygen become combustible at high temperatures generated with normal operation of equipment. It is recommended that solutions of adhesive and combustible solvents be vaporized before equipment is operated. It is also

recommended to pay attention to the danger of ignition of endogenous gases. The unit must be separated from the mains before approaching the disinfection room, where it is installed.



3.5 Electromagnetic environment

- Due to the intended use the device can be used in hospitals, clinics, health centers, GP practices, rehabilitation offices and other health care facilities, under the supervision of qualified personnel.
- Simultaneous operation of unit with devices generating strong electromagnetic field, such as short wave and microwave diathermies, high frequency surgical equipment, MRI systems, may disturb unit operation. For this reason, it is recommended to maintain appropriate distance between these devices or to switch off the generator of strong fields during therapy with the PhysioGo unit. Manufacturer doesn't claim compatibility of the PhysioGo unit with high frequency surgical equipment.
- If the device is subjected to electromagnetic interference with an intensity that exceeds the declared compliance levels declared in chapter 7.2, the display may be affected, generation may be interrupted or the device may restart.
- **WARNING:** Use of the PhysioGo adjacent to or stacked with other equipment should be avoided because it could result in improper operation. If such use is necessary, the PhysioGo and the other equipment should be observed to verify that they are operating normally.
- It is recommended to use original accessories, detachable parts, spare parts and equipment of Astar.
- **WARNING:** Use of accessories, detachable parts, transducers and cables other than those specified or provided by the manufacturer of this equipment could result in increased electromagnetic emissions or decreased electromagnetic immunity of this equipment and result in improper operation.
- **WARNING:** Portable RF communications equipment (including peripherals such as antenna cables and external antennas) should be used no closer than 30 cm (12 inches) to any part of the PhysioGo, including cables specified by the manufacturer. Otherwise, degradation of the performance of this equipment could result.
- Sockets of laser / magnetic field applicators, marked with symbol shown to the left, are sensitive to electrostatic discharges. Attention must be paid not to touch with fingers sockets of the unit, especially in rooms with low air humidity.
- At the moment, when laser / magnetic field applicators are being connected, the unit must be separated from the mains, and the user must remove electrostatic charges from his fingers by touching earthed metal component (e.g. earthed pin in mains socket or metal casing of earthed device).
- CPE type magnetic field applicators are marked with non-ionizing radiation symbols because they emit electromagnetic field energy for medicinal purposes.



The PhysioGo meets requirements of electromagnetic interference emission and immunity standards and shall not pose a threat to correct operation of the other devices. Compliance levels for emissions and immunity are given in section 7.2.

3.6 Operation of touch-sensitive displays

Table 3.1. Recommendations for the operation of touch screens

Type of display	Method of operation of the display
7" with a capacitive touch-sensitive panel	Recommended: <ul style="list-style-type: none"> • Operator's finger • Pen designed for capacitive screens – preferably with a rubber tip



3.7 Essential performance

Essential performance in relation to the area of physical therapy available in the PhysioGo family devices is presented in the Table 3.2.

Table 3.2. Essential performance

Physiotherapy field	Essential performance characteristics
All	The value of the adjusted signal amplitude, displayed via the user interface, complies with the value on the output / outputs with the tolerance specified in chapter 7.1

Physiotherapy field	Essential performance characteristics
Electrotherapy	<p>Generation of current and voltage signals with frequencies, shapes and amplitudes corresponding to the waveforms recognized and used in this therapy. Unidirectional (unipolar) and / or bidirectional (bipolar) currents are available.</p> <p>The device meets the requirements of IEC 60601-2-10 standard, where there are specified:</p> <ul style="list-style-type: none"> • maximum amplitudes of the output currents depending on the frequency of the waveform, • permissible pulse energy, • pulse duration, pulse frequencies and amplitude tolerances.
Ultrasound therapy	<p>Generation of the ultrasound wave with a frequency in the 500kHz – 5MHz range in the mode:</p> <ul style="list-style-type: none"> • continuous or • pulse – with adjustable duration and frequency of packets, <p>using ultrasonic transducers.</p> <p>The device meets the requirements of IEC 60601-2-5 standard, where there are specified:</p> <ul style="list-style-type: none"> • maximum permissible effective intensity, • tolerances of the output power, effective radiating area and effective intensity, • permissible level of unwanted ultrasound radiation, • temperature limits of ultrasound transducers.
Combined therapy	As for electrotherapy and ultrasound therapy
Laser therapy	<p>Emission of the laser radiation with power suitable for the defined laser class of the device, for a particular wavelength, in the mode:</p> <ul style="list-style-type: none"> • continuous or • pulse – with adjustable duration and frequency of pulses, <p>using continuous and / or pulse sources of radiation.</p> <p>The device meets the requirements of IEC 60601-2-22 standard, where the tolerance of laser power indication is specified.</p>
Low frequency magnetic field therapy	<p>Generation of an electro-magnetic field with a specific frequency (in the range of 0.5 – 200 Hz), unidirectional (half-) or bidirectional, in the mode:</p> <ul style="list-style-type: none"> • continuous or • pulse <p>using field sources in the form of plate applicators. The tolerance is specified in the chapter 7.1</p>



3.7.1 Test of essential performance and basic safety

Calibrating or servicing the device shall be carried out by the manufacturer or an authorized service personnel in accordance with separate guidelines. If the warnings given in this manual are followed, there is no risk for persons performing the above mentioned activities.

The User of PhysioGo unit must perform technical inspection of the unit at year's intervals. The inspection must be performed by a unit authorized by the manufacturer. The inspection is performed at the user's expense.

Table 3.3. Essential performance and basic safety testing recommendations

Test item	Method of checking	Acceptance criteria	Required measuring equipment
Safety test: <ul style="list-style-type: none"> • patient leakage current measurement, • touch current measurement, • insulation resistance if necessary 	The manufacturer allows the methods compliant with the requirements of the standards: <ul style="list-style-type: none"> • IEC 60601-1 • IEC 62353 	The measurement results are within the limits specified by the applied standard	Safety tester meeting the: <ul style="list-style-type: none"> • IEC 60601-1 • IEC 62353 • requirements
Control of correctness of the performed self-test (includes the control of compressor pressure)	Visual inspection	No errors	No requirements
Evaluation of keyboard function and operation	Manual and visual inspection	The keys respond properly to pressure	No requirements
Evaluation of touchscreen function and operation	Manual and visual inspection	The touch panel responds correctly to pressing	No requirements
Inspection of the controller condition for casing defects and damage of sockets	Visual inspection	No deformation or cracks of the casing Undamaged sockets No loosened sockets	No requirements

3. Operational safety

Test item	Method of checking	Acceptance criteria	Required measuring equipment
Inspection of the applicators and ultrasound heads condition for casing defects and damage of interconnecting cables and connectors	Visual inspection	No deformation or cracks of the casing No tear and bending of cable insulation Undamaged connector	No requirements
Inspection of the patient cables and electrodes	Measurement of cables continuity and electrodes quality according to subsection 6.8.	Quality of the cables according to subsection 6.8.1 Quality of the electrodes according to subsection 6.8.2	No requirements
Verification the power emitted by the ultrasound heads	The manufacturer recommends to apply methods compliant with the requirements of the IEC 60601-2-5 standard	Accuracy of power indication is within $\pm 20\%$ tolerance	Pressure balance or ultrasonic power meter
Verification the accuracy of current and voltage amplitudes	The manufacturer recommends to apply methods compliant with the requirements of the IEC 60601-2-10 standard	Accuracy of time / frequency parameters and the amplitude is within $\pm 20\%$ tolerance	Oscilloscope, digital multimeter, 500 Ω reference resistor
Verification the laser radiation power level of all sources	The manufacturer recommends to apply methods compliant with the requirements of the IEC 60601-2-22 standard	The accuracy of the laser power indication is within $\pm 20\%$ tolerance	Laser power meter
Verification the magnetic field induction emitted by the applicators	Direct measurement	The accuracy of induction indication fidelity is within $\pm 20\%$ tolerance	Magnetic field induction meter (gaussmeter)

The inspection must also include verification of the quality of applied accessories, detachable parts and treatment materials. No action is required to maintain basic safety and essential performance with respect to electromagnetic interference during device "life time".

Positive result of the technical inspection confirms that basic safety and essential performance is maintained.



3.8 Eye protection

Astar recommends the following types of protective goggles:

- models with **AST**, **TP2**, **ML3** and **DI4** filters – manufactured by **NoIR**, optical density and spectral ranges are shown in the tables below:

Table 3.4. Parameters of AST filter

Spectral range [nm]	Optical density	Symbol
650-670	2+	DIR LB2
660	6+	DIR LB6
808-825	6+	DIR LB5

Table 3.5. Parameters of TP2 filter

Spectral range [nm]	Optical density	Symbol
650-<655	2+	DIR LB2
655-685	3+	DIR LB3
>685-690	2+	DIR LB2
770-<785	2+	DIR LB2
785-830	3+	DIR LB3
>830-845	2+	DIR LB2

Table 3.6. Parameters of ML3 filter

Spectral range [nm]	Optical density	Symbol
190-400	5+	190 – 315 nm D LB7 + IR LB4 >315-395 D LB5 + IRM LB6
630-660	3+	
660-670	2+	630-660 + 800-915 DIR LB3
800-915	3+	>660-670 + 780-920 DIR LB2
780-920	2+	

Table 3.7. Parameters of DI4 filter

Spectral range [nm]	Optical density	Symbol
190-400	5+	190 – 315 nm D L7 + R L4 >315-400 D L5 + R L6
625-850	4+	>830-850 DIR L3
660-835	5+	625-830 DR L4
633	5+	625-670 + >800-830 I L4 >670-800 I L5

- model with **31-21128** filter – manufactured by **Honeywell** (formerly Sperian), optical density and spectral ranges are shown in the table below:

Table 3.8. Parameters of 31-21128 filter

Spectral range [nm]	Optical density	Symbol
630-730	4+	DIR L4
770-1070	4+	DIR L4

- models with **P1L22** and **P1H03** filters – manufactured by **Laservision**, optical density and spectral ranges are shown in the tables below:

Table 3.9. Parameters of P1L22 filter

Spectral range [nm]	Optical density	Symbol
>315 - 375	8+	D LB6+ IR LB8 + M LB7Y
>375 - 378	6+	DIRM LB6
>378 - 382	4+	DIRM LB4
625 - <636	2+	DIRM LB2
636 - <640	4+	DIRM LB4
640 - 658	5+	DIRM LB5
>658 - 662	4+	DIRM LB4
>662 - 668	2+	DIRM LB2
797 - <804	2+	DIRM LB2
804 - <806	4+	DIRM LB4
806 - <809	5+	DIRM LB5
809 - 824	6+	D LB6 + I LB6Y + RM LB6
>824 - 827	5+	DIRM LB5
>827 - 829	4+	DIRM LB4
>829 - 836	2+	DIRM LB2

Table 3.10. Parameters of P1H03 filter

Spectral range [nm]	Optical density	Symbol
540 - <578	1+	DIRM LB1
578 - <595	2+	DIRM LB2
595 - <610	3+	DIRM LB3
610 - <630	5+	DIRM LB5
630 - <660	6+	DIRM LB6
660 - 775	7+	D LB6 + IR LB7 + M LB7Y
>775 - 790	6+	DIRM LB6
>790 - 800	5+	DIRM LB5
>800 - 820	4+	DIRM LB4
>820 - 835	3+	DIRM LB3
>835 - 850	2+	DIRM LB2
>850 - 870	1+	DIRM LB1

The above-mentioned models provide an adequate level of safety for the patient and the user during laser therapy treatment with the use of applicators handled by any PhysioGo unit model.

It is admissible to wear other types of protective goggles under condition that appropriate level of safety is guaranteed by their manufacturer (they must meet requirements of EN207 standard, feature CE marking and declaration of conformity).

3.9 Laser labels



The unit is equipped with information labels on laser radiation and warnings against it. The User is obliged to visibly mark with them the room, where the laser therapy treatment procedures are performed. A label must be stuck in such a way that the longer ray, which connects the triangle with point in the center of the label, must be on the right. The background of labels is yellow, framed and texts are in black.

Label patterns for marking the room, where laser therapy treatment procedures are performed:



Laser patterns of the unit and laser applicators:





Label patterns of scanning and cluster applicators:



Figure 3.2. Laser labels

3.10 Applied parts

The PhysioGo unit has one type of applied part of BF type. It includes, depending on model:

- the magnetotherapy socket along with plug, cable and applicator,
- the laser therapy sockets along with plugs, cables and applicators (it can be point laser applicators, cluster applicator, scanning applicator),
- the ultrasound therapy sockets along with plugs, cables and ultrasound heads,
- electrotherapy sockets along with plugs and patient's cables.

Elements of applied part are connected. Physical contact of the electrodes and ultrasound head with patient's body during normal use is essential for the device to perform its function.

Laser applicators and magnetic field applicators generally do not require physical contact with patient's body during normal use. So, they do not come under the definition of the applied part, concerning the basic standard for the safety of medical electrical equipment (in Poland PN-EN 60601-1, in Europe EN 60601-1, both based on IEC 60601-1), but they are treated as applied parts (there are some indications to perform treatment with contact method, for point laser applicators, magnetic field applicators can be attached to the patient's body using Velcro belts).

The specification of the leads, along with the location of the output sockets and the characteristics applicators are described in detail in the Instructions for use of the model. The symbol of applied part type BF is presented on the sockets label.

3.11 Disposal

In case, when the disposal of the unit will become necessary (e.g. after elapse of its service life), please contact the manufacturer or manufacturer representative, which must react in an appropriate way i.e. collecting the unit from the user. The user may also contact companies specialized in removal and/or disposal of electrical devices or computer equipment.

The device is marked with an appropriate symbol compatible with the requirements of the directive on waste electrical and electronic equipment (WEEE) – see the table with symbol descriptions used for marking the product at the end of the Technical description manual.

4. Unit description

4.1 General characteristics

Multifunction PhysioGo unit is a highly specialized medical device based on modern microprocessor platform.

The unit has a plastic console casing. It is equipped with a color touch LCD display with a diagonal of 17,8 cm (7"). The mains switch, fuse socket, mains socket and remote lock connector socket are located on the rear side of the casing, service sockets are located on the left side. Output sockets for connection of accessories and detachable parts are located on the rear panel. The unit has the possibility of changing its angle of inclination. For this purpose, feet in the rear side of the casing have been developed. They can be folded or unfolded. General view of the unit is presented in Figure 4.1, view of the rear panel in Figure 4.2 or Figure 4.3.



Figure 4.1. General view



Figure 4.2. Unit's rear panel view – version 2.0

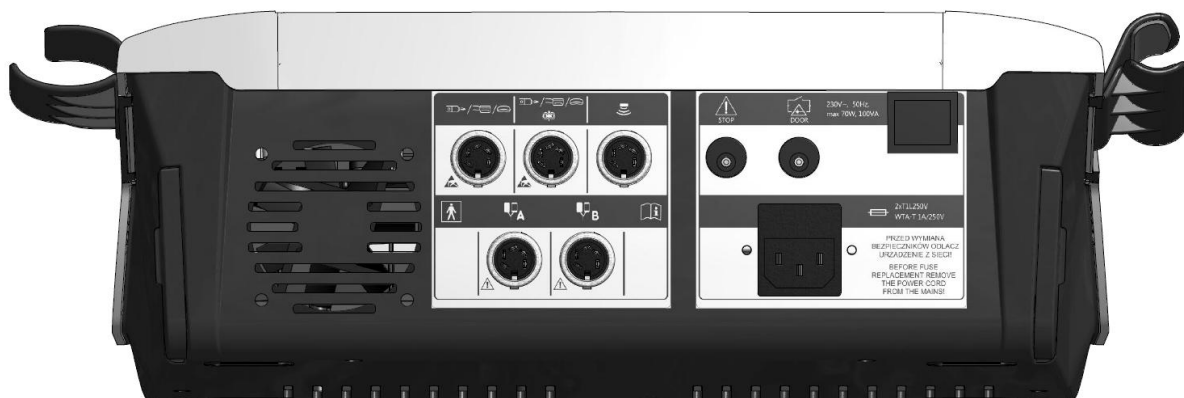

Figure 4.3. Unit's rear panel view – version 1.0

4.2 Front Panel

Arrangement of front panel components is shown in figure 4.4.

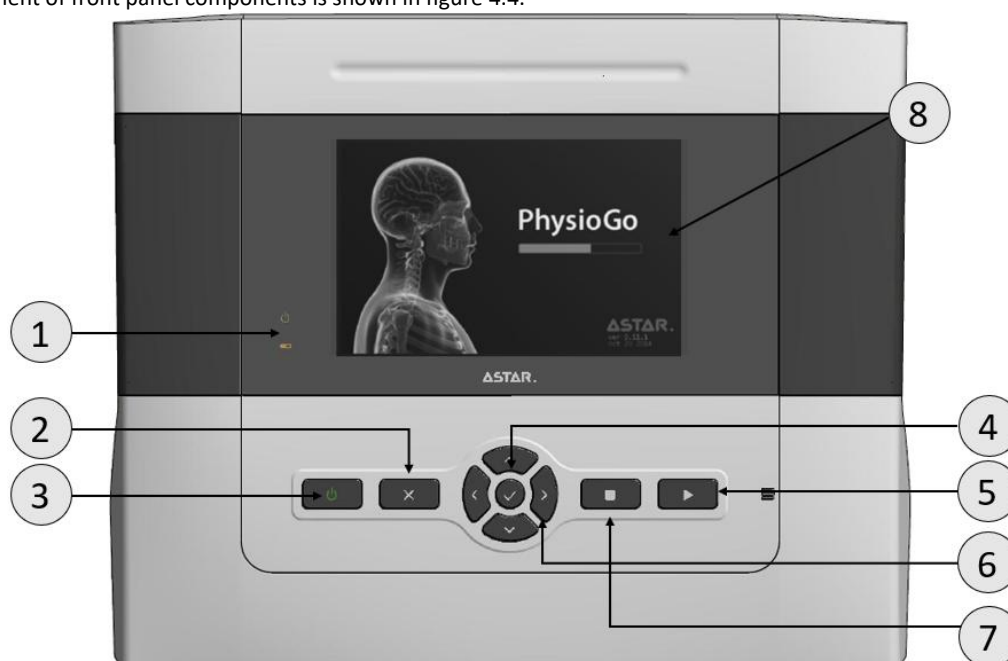

Figure 4.4. Arrangement of front panel components

Front panel components characteristics:

Symbol	Description	Function
1	Operation status and battery level indicators	See chapter 4.2.1
2	Escape key	Its pressing causes abolition of action and going over on an early menu level. Pressing of this key during treatment procedure results in immediate interruption of the procedure.
3	Turn ON/OFF key (STANDBY)	In order to activate the unit in the case of battery operation, please hold on for at least 3 seconds the STANDBY key. Extension of the holding time prevents unintentional activation during transport.
4	Confirmation key	It is used to confirm: <ul style="list-style-type: none"> • selection of therapy in a particular treatment channel, • function in program mode, • current type in electrotherapy and combined therapy, • saving of user-defined program, • functions in setup mode, • changes in the unit settings.



4. Unit description

Symbol	Description	Function
5	START key	Pressing START key results in generation after: <ul style="list-style-type: none"> • selection of a treatment program or sequence, favorite program or user-defined program in program mode, • ending of parameters edition in manual mode. Pressing START key after interruption of a treatment procedure using STOP key (pause) makes it possible to continue the procedure.
6	Edit keys	They are used for: <ul style="list-style-type: none"> • switching between parameters (left / right) • increasing / decreasing of parameter values (up / down)
7	STOP key	Pressing STOP key while performing treatment procedure results in treatment interruption and automatically the unit enters the standby mode (pause). The treatment timer will stop.
8	LCD screen	7" Touch screen



4.2.1 Operation status and battery level indicators

Symbols and description of unit operation status signaled by LED indicators are summarized in the tables below.

Non-battery unit:

Symbol	Color	Indicator status	Mains switch	Explanation
	Green	No light	OFF	The unit is turned off. Turning ON: <ul style="list-style-type: none"> • Turn the mains switch on • Press the STANDBY key
		Blinks	ON	Unit is in standby mode. Turning ON: <ul style="list-style-type: none"> • Press the STANDBY key
		Steady light	ON	The unit is ready for operation.
	Orange	No light	---	No battery.

Battery unit:

Symbol	Color	Indicator status		Mains switch	Explanation
		Readiness	Battery		
 	Green	No light	No light	OFF	The unit is turned off. Turning ON: <ul style="list-style-type: none"> • Turn the mains switch on • Press the STANDBY key
		Blinks slowly	No light	ON Mains cable connected	Unit is in standby mode. Battery is fully charged. Turning ON: <ul style="list-style-type: none"> • Press the STANDBY key
	Orange	Blinks slowly	Blinks slowly	ON Mains cable connected	Unit is in standby mode. Battery is being charged. Turning ON: <ul style="list-style-type: none"> • Press the STANDBY key
	Steady light	Blinks slowly	ON Mains cable connected	The unit is turned on. Battery is being charged.	
	Steady light	No light	ON Mains cable connected	The unit is turned on. Battery is fully charged.	

Symbol	Color	Indicator status		Mains switch	Explanation
		Readiness	Battery		
		No light	Steady light	ON Mains cable disconnected	Unit is running on battery supply.

Additional information about battery indicator:

Symbol	Color	Battery indicator status	Explanation
	Orange	Blinks fast	Battery module has been disconnected.
		3 pulses	Battery low.
		5 pulses	Battery error. Turn the unit off using STANDBY key and switch the mains supply off. Restart it after 10 seconds. If the problem repeats, contact your service.

4.3 Mounting of accessory holders

According to possessed part to the unit casing you can mount:

- a holder / holders for ultrasound heads or
- a holder / holders for point laser applicators,
- a holder for cluster laser applicator – on the left side of the casing only.

In order to mount the holders you should:

- loosen the clasps and remove the holder masking cover – black parts of the casing (without cutout) located on the left and right side of the screen,
- adjust the holders and screw bolts in,
- reattach the masking cover, use a part with cutout, you'll find it in the standard accessory list.

Method of mounting the holders for ultrasound heads and point laser applicators is presented in the following figures.



Figure 4.5. Sample view of mounting the holders for point laser applicator and ultrasound head



Figure 4.6. Sample view of mounting the holder for cluster laser applicator

4.4 Name plate

The name plate is located on the left side of unit casing. Among others there are following data on the name plate (see chapter 8):

- device name, version and model,
- UDI-DI code,
- serial number and manufacture date – UDI-PI code,
- nominal voltage and operation frequency,
- maximum power consumption,
- type of applied fuses,
- IP protection class,
- manufacturer’s data.



Figure 4.7. Name plate of PhysioGo device – version 2.0



Figure 4.8. Name plate of PhysioGo device – version 1.0

The label with ultrasound wave parameters is located on the bottom side of unit casing (see chapter 8):

- acoustic working frequencies,
- waveforms,
- detailed information of impulse’s duration, period of repetition and duty factor.

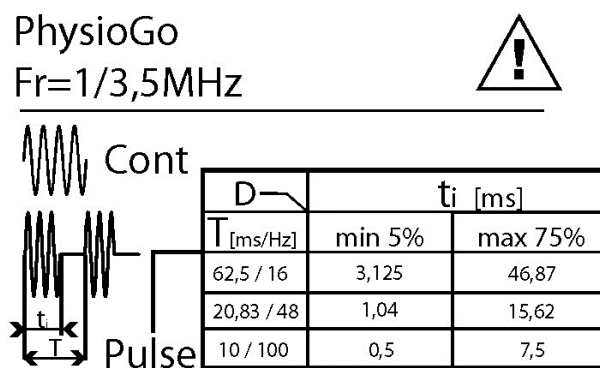
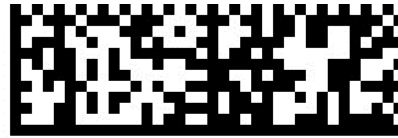

Figure 4.9. Label with parameters

Laser label is located at the bottom of unit casing (see chapter 3.9).

4.4.1 UDI code

Regulation (EU) 2017/745 of The European Parliament and of The Council defines “Unique Device Identifier” (‘UDI’) as a series of numeric or alphanumeric characters that is created through internationally accepted device identification and coding standards and that allows unambiguous identification of specific devices on the market (def.15). The code development process is supported by entities designated by Commission (EU) Implementing Decision. The manufacturer has chosen to cooperate with the GS1 organization.



GTIN(01) 05903641500944
PROD DATE(11) 230500
SERIAL(21) CBO00022

Figure 4.10. UDI code – example

ID	Symbol	Description	UDI code part
(01)	GTIN	Unique GTIN code assigned by GS1 organization	UDI-DI
(11)	PROD DATE	Production date format: YYMMDD A record limited to the year and month is acceptable in the format: YYMM00	UDI-PI
(21)	SERIAL	Serial number	

4.5 Current and voltage stabilization – CC and CV mode

In the range of electrotherapy, the PhysioGo unit may be operated in one of two modes:

- CC mode (constant current) – when output current is stabilized,
- CV mode (constant voltage) – when output voltage is stabilized.

In CC mode the current in patient’s circuit is independent (within certain limits) from the resultant of resistance of skin, tissues, electrodes (with moist pads) and cables. Effective operation of the unit for very high resistance is possible due to its structure. At the maximum current value of 140 mA, stabilization within a full range of current intensity regulation is provided for resistance values from 500 to 750 Ω . For higher values of resistance, the maximum current intensity is lower. It means that increasing on the keyboard current intensity over the limiting value does not result in further increase of current in the output circuit. In the case, when resistance is too high (e.g. used electrodes, moist pads are not moistened enough), the information about open circuit will be shown on the display.

In CV mode, the voltage generated by the unit, which value is set up on the keyboard, is spread out (according to Kirchhoff voltage law) between the unit’s output resistance and resistance of a load. Rough diagram of operation system in CV mode for one channel is presented in Figure 4.11.

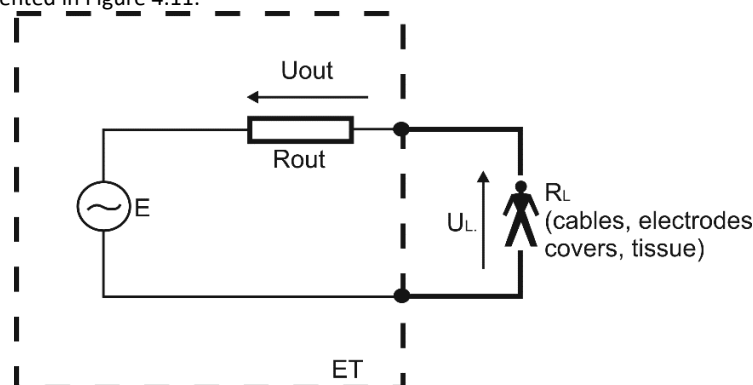

Figure 4.11. Rough diagram of the output circuit of the PhysioGo unit working in CV mode (one channel)

Symbols used in figure:

- E – the value of output voltage – set on the keyboard

- U_{out} – drop of the voltage on unit's output resistance
- R_{out} – unit's output resistance
- U_L – load voltage
- R_L – load resistance

The value of voltage in the patient's circuit depends on the quotient of unit's output resistance by the resultant of resistance of skin, tissues, electrodes (with moist pads) and cables. During the unit operation, on the display there are shown the internal settings and voltage value in patient's circuit.



It is recommended to use CV mode while performing non-stationary treatment procedures, e.g. combination therapy of current and ultrasounds or using the point electrodes. A momentary loss of contact between the electrode and patient's body does not result in interruption of treatment procedure, contrary to CC mode.

The calibration settings for CC mode are being entered with the load which has a resistance of 500 Ω . The calibration settings for CV mode are being entered in the idle operation mode of the unit.

4.6 Laser radiation measurement

Laser power radiation measurements are based on a built-in laser applicator photodetectors. An exception to this rule is cluster laser applicator, where the measurements should be performed with the use of an external laser power radiation meter.



4.7 Protection

4.7.1 DOOR remote connector

The DOOR remote connector is one of the components which ensure laser system operation safety. The manufacturer delivers (as a standard part of the unit) the plug marked with DOOR symbol, which is designated to be a connector.

Connection of DOOR plug to dedicated socket enables performance of treatment procedures without the need to apply additional means. If the plug is not connected, when attempting to start the treatment an acoustic signal will be heard and the message will be displayed.

In a situation, when the user utilizes a composed system, which consists of entrance door lock or other stationary lock, additional sensors together with cables, as a remote lock connector, DOOR plug can be utilized and connected to such system.

4.7.2 Laser emergency stop

This is an optional module equipped with poppet stop, which is designated to immediately stop emission of laser radiation in case of danger.

If danger occurs and emergency stop is released, then before starting normal use of the unit the following operations are to be performed:

- **switch off mains supply with mains switch,**
- **turn anticlockwise the poppet of emergency stop to unlock it,**
- **switch on mains supply with mains switch.**

While working on the battery supply, emergency stop switch should be connected to the patient's stop socket marked STOP, located on the rear side of the unit.

If as a result of danger the unit or applicators could be damaged, do not start the unit. It is recommended to contact manufacturer's service to explain the situation.

4.7.3 Patient's stop switch



Patient's stop switch is an optional parts of unit. Its pressing automatically interrupt the treatment and the unit is in pause mode. The switch is intended for the patient in the case of feeling unwell during the treatment, especially electrotherapy treatments, when the patient is not under the supervision of a therapist. Restoring current generation is possible by pressing START key on the front panel.

In the event of a battery operation with laser applicators to a STOP socket there should be connected emergency stop switch. Its pressing immediately interrupt the emission of laser radiation in case of any danger.

4.7.4 Open circuit detection

In the case, when starting or performing an electrotherapy / combined therapy treatment procedure, the state of high resistance on the output will be detected, which may be caused by:

- incorrect connection of electrodes,
- a poor contact between electrodes and tissue (e.g. covers are not moistened enough),
- used electrodes,
- damaged interconnection cables,

The information about open circuit will be shown on the display.



The open circuit detection system is active during the unit's operation. The open circuit detection system works when current value is more than 2,5 mA or voltage is set above 15 V.

Detailed description of cables and electrodes condition control is given in chapter 6.

4.7.5 Current accuracy control in CC mode

While performing the electrotherapy treatment in stabilized output current mode (CC), the unit controls the accuracy of current intensity. In the case when the difference between the setting and output value is higher than 20%, the treatment will be interrupted and the message will appear on the display.

4.7.6 Overcurrent in CV mode

While performing the electrotherapy treatment in stabilized output voltage mode (CV), the unit controls whether the maximum current value is not beyond the limits. If the voltage setting for current value is higher than the allowed limit (specified for the stabilized output current in CC mode), the treatment will be interrupted and the message will appear on the display.

4.8 Laser applicators

Available types of point laser applicators:

- red light probe – type 80RDV3, wavelength 660 nm with maximum output power 80 mW in the continuous and pulse operation mode,
- infrared light probe – type 400IRV3, wavelength 808 nm with maximum output power 400 mW in the continuous and pulse operation mode.

Available types of scanning laser applicators:

- SKW2-450 / SK2-450 – wavelength 808 nm with maximum output power 450 mW and wavelength 660 nm with maximum output power 100 mW.

Available types of cluster laser applicators:

- CL1800WH / CL1800 – 4 laser diodes – wavelength 808 nm with maximum output power 400 mW and 5 laser diodes – wavelength 660 nm and maximum output power 40 mW, in abbreviated form R+IR 5x40+4x400.

Schemes of laser beams waveforms in the following laser applicators are presented below.

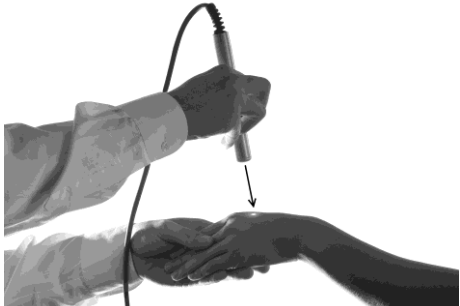
Applicator type / Description	Figure
<p>Point laser applicators</p> <p>Laser radiation is directed manually by the operator into the patient's body who is undergoing the therapy. The laser beam is collimated by a lens, which is also the laser aperture. The output laser beam is divergent.</p>	



Applicator type / Description	Figure
<p>Scanning laser applicators</p> <p>Laser radiation is directed automatically after setting the applicator into the patient's body who is undergoing the therapy.</p> <p>The laser beam is collimated inside the applicator by a lens system and outputted by a polycarbonate glass, which is also the laser aperture. The output laser beam is divergent.</p>	
<p>Cluster laser applicator</p> <p>Laser radiation is directed manually by the operator into the patient's body who is undergoing the therapy. Laser beams from individual sources are not collimated. They pass through a clear polycarbonate plate, which is also the laser aperture. Laser beams are divergent.</p>	



Figure 4.12. Point laser applicators and optical fibers

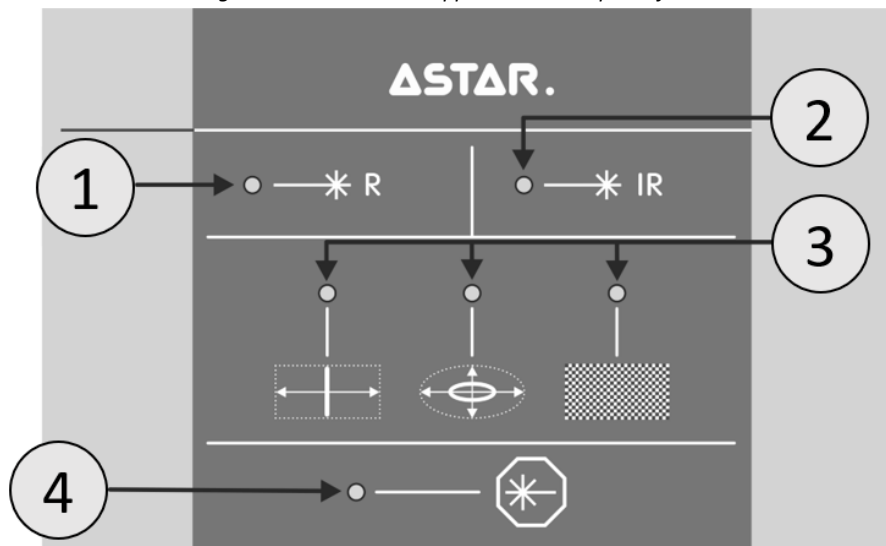

Figure 4.13. Laser scanning applicator – panel description

Symbol	Description
1.	Radiation wavelength 660 nm selection indicator
2.	Radiation wavelength 808 nm selection indicator
3.	Field shape selection indicator
4.	Output radiation indicator



Figure 4.14. Scanning and cluster laser applicators

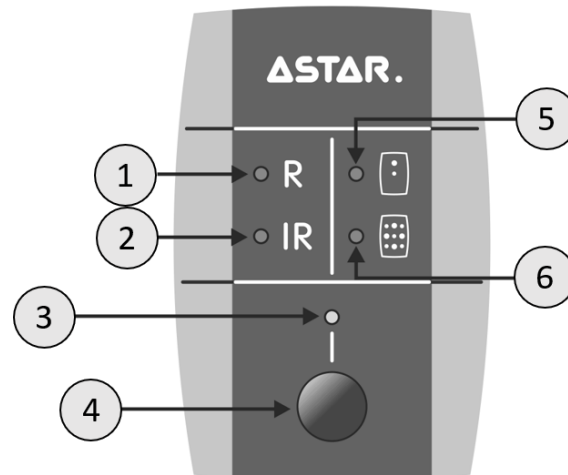

Figure 4.15. Laser cluster applicator - panel description

Symbol	Description
1.	Radiation wavelength 660 nm selection indicator
2.	Radiation wavelength 808 nm selection indicator
3.	Output radiation indicator
4.	Emission start/stop button
5.	Single-diode mode indicator
6.	Multi-diode mode indicator

4.9 Magnetic field applicators

The unit may cooperate with magnetic field coupled plate applicator – CPE type. This detachable part may be used in single or dual configuration. Applicator may operate in continuous or pulse mode. Examples of magnetic field application are presented below.

Applicator	Example
CPE	

4.10 Ultrasound heads

Head type	Characteristics and application
GSW-4/1	<ul style="list-style-type: none"> head with acoustic operating frequency 1 MHz or 3,5 MHz, and effective radiating area 4 cm² basic type of head for carrying out the ultrasound therapy, phonophoresis and combined therapy
GSW-1/1	<ul style="list-style-type: none"> head with acoustic operating frequency 1 MHz or 3,5 MHz, and effective radiating area 1 cm² head intended to small body parts

Unit has a system controlling the quality of contact between head and patient's body during treatment process. In case the quality of contact worsens (e.g. not enough gel, bones too close), the message appears. In case the device detects no contact and this action will continue, then the treatment will be terminated and a message informing about no contact of head with patient's body will appear.

Temporal loss of contact does not result in treatment interruption, but the treatment timer stops so the effective time of treatment meets set value.

During the treatment, the quality of contact is shown on the display in form of columns varying in height. Moreover, each head has a light indicator.



Indicator status:

- if it is off during the treatment procedure – it means good contact with patient's body,
- if blinks during the treatment procedure – it means bad contact with patient's body.

On ultrasound head name plate following data are located (see **Chapter 8**):

- acoustic working frequency,
- effective radiating area,
- nominal power,
- beam non-uniformity ratio,
- beam type,
- degree of protection provided by the enclosure.





Examples of application are presented below.

Applicator / therapy	Example
GSW-4/1	
GSW-1/1	

Applicator / therapy	Example
Combined therapy	

4.11 Safe shutdown procedure

In order to shut down the device properly:

Step	Description
1.	Press the STANDBY key on the front panel  .
2.	The message presented below will appear on the screen:
	
3.	If you want to confirm the operation, press  , the device will be properly turned off. If you want to resign, press  .
4.	After the system shutdown you can disconnect the unit from the mains supply using the mains switch. If you want to charge the battery, leave the mains switch on.

There is no risk of the device failure due to switching it off with mains switch, but without a correct system shutdown. However, the diagnostic system recognizes it as an unwanted situation, for example as a voltage dip. This information is logged into the system logs and can make the diagnosis of actual problems difficult, if any exists.

5. Definitions and parameters

5.1 Electrotherapy

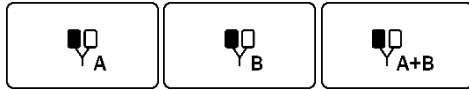

5.1.1 Terminology

The carrier frequency is a parameter of medium frequency alternative current, the so called carrier wave of interferential currents (4000 Hz), Kotz' current (2500 Hz) and medium frequency unipolar currents modulated by low frequency current. The medium frequency alternative current features good penetrability within the medium, which the human body is, and its properties are used to "transport" the base frequency, which is the proper therapeutic instrument.

Base frequency is a parameter of low frequency alternative current, which is produced in course of amplitude modulation of carrier wave creating a low frequency sine curve (5÷100 Hz). The sine wave of base frequency constitutes an envelope circumscribed on the carrier wave, which enables its deep penetration into human body tissues.

Basic frequency **spectrum** determines scope of modulation of this parameter as function of time. This parameter determines the frequency added to basic frequency, and the sum of them is the highest BASE frequency value that occurs during modulation.

Example: Base frequency is at 60 Hz, spectrum 40 Hz. That means that the base frequency will vary within the limits 60 to 100 Hz (60+40=100) in timely dependence determined by the FM program.

The base frequency of Kotz' current determines the frequency of occurring rectangular, bipolar "bursts" (filled with carrier wave 2500 Hz), the duration of which equals the pause time.

TENS pulse frequency determines frequency of occurring pulses, where the pulse duration time is a value set separately between 25 and 300 µs.

5.1.2 Output signal modulations

Frequency modulation program FM determines how the frequency of the signal changes, depending on the settings of the base frequency and the spectrum over a given time interval. Program parameters define:

- duration of the lowest frequency,
- time of increase to the highest frequency,
- duration of the highest frequency, and
- falling time to the lowest frequency.

If SPECTRUM value is set up at 0 Hz, it is not possible to use frequency modulation program. And when nonzero SPECTRUM value is selected, default settings of frequency modulation program are 3 s rise time and 3 s fall time.

Amplitude modulation program AM determines in what time spans therapeutic signal amplitude change and how deep that change goes. Such modulation aims at delaying process of adaptation to the set value of the therapeutic signal and alleviation of adverse treatment results with patients badly tolerating electrotherapy. Amplitude is modulated within the range 70% to 100% of set up output signal.

Training program controls occurrence of muscle contraction and rest phases. Voltage and amperage, which will be applied during electrostimulation, should be determined when no training program is set. This program includes an active phase only, enabling comfortable setup of appropriate value of output signal. This program shall not be applied in therapy. Set value of output signal shall be remembered and set up during session of the selected treatment program.

The programs which feature relatively long rest time in relation to contraction phase give appropriate conditions for muscle fiber regeneration. The programs which have decisively shorter rest phase shall only be applied to electro-gymnastics with healthy persons or to cause tonolitic effect.

5.1.3 Galvanic current

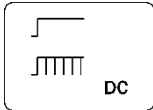

Galvanic current is a medium frequency unipolar current, not modulated. There are no significant therapeutic differences between this type of current and traditional direct current. However, because of applying medium frequency current, patient's sensation during treatment procedure improves. **It should be taken into consideration that set up amplitude, which determines certain degree of sensation, will be higher than amplitude of traditional direct current, which causes the same degree of sensation.**

Parameters description:

Symbol	Description	Available parameters
	Treatment time	30 seconds – 60 minutes, 30 seconds step
	Continuous or interrupted shape of the current	Continuous <ul style="list-style-type: none"> Pulse frequency is 4 kHz Duty factor 80%
	Polarization	For such polarization setting red plug is a positive electrode, and black plug is a negative electrode.
		For such polarization setting red plug is a negative electrode and black plug is a positive electrode. Warning means that such a setting is the reverse of commonly accepted way of marking polarity.
		Automatic polarization switch in the half performed treatment.
	Maximum amplitude	0 – 40 mA in CC mode Regulation: <ul style="list-style-type: none"> 0,1 mA in the range of 0-10 mA 0,5 mA in the range of 10-20 mA 1 mA in the range of 20-40 mA



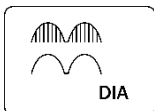





5.1.4 Diadynamic currents



Diadynamic currents generated by the PhysioGo unit are medium frequency currents modulated by low frequency current, which comply with traditional diadynamic currents described by Bernard. There are no significant therapeutic differences between such an approach to diadynamic currents generation and traditional method. However, due to the use of a medium-frequency carrier, there is a reduction in the patient's unpleasant sensation during the treatment and a reduction in the electrochemical effect. With this method of signal generation, it should be realized that a higher amplitude must be set in order to induce a certain level of patient sensation, compared to classical diadynamic currents.

Parameters description:

Symbol	Description	Available parameters
	Treatment time	30 seconds – 60 minutes, 30 seconds step
	Shape of the current	<ul style="list-style-type: none"> MF DF CP CP-ISO (modification of MF phase, reduction with 12%) LP

Symbol	Description	Available parameters
	Continuous or interrupted shape of the current	 Continuous  <ul style="list-style-type: none"> Pulse frequency is 4 kHz Duty factor 80%
	Polarization	 For such polarization setting red plug is a positive electrode, and black plug is a negative electrode.  For such polarization setting red plug is a negative electrode and black plug is a positive electrode. Warning means that such a setting is the reverse of commonly accepted way of marking polarity.  Automatic polarization switch in the half performed treatment.
	Maximum amplitude	0 – 60 mA in CC mode Regulation: <ul style="list-style-type: none"> 0,1 mA in the range of 0-10 mA 0,5 mA in the range of 10-20 mA 1 mA in the range of 20-60 mA

5.1.5 Rectangular and triangular pulse currents

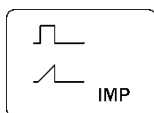

Pulse currents generated in the PhysioGo unit are medium frequency unipolar currents modulated by low frequency rectangular or triangular current.











Rectangular pulse current consists of pulse sequence of rectangular shape and independently adjusted times of pulse and pause. This current is used for the stimulation of healthy denervated muscles. It is also applied in electrodiagnostics to determine the I/t curve.







Triangular pulse current consists of a sequence of saw-shaped pulses and independently adjusted times of pulse and pause. It is used to stimulate denervated muscles (struck by flaccid paralysis) and smooth muscles. It is also applied in electrodiagnostics to determine the I/t curve.

The Ultra Reiz current (Träbert's current) is a special case of rectangular pulse current. This is a current with rectangular shape, pulse duration 2 ms and pause duration 5 ms. These settings are not adjustable. Because it is also pain relieving, it is applied in pain syndrome treatment, muscle pain and degenerative joint disease.

Another special case of rectangular pulse currents are Leduc's currents with pulse duration 1 ms and pause duration 9 ms and neofaradic current with pulse duration 1 ms and pause duration 19 ms available also for triangular currents.

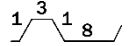
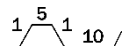
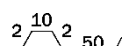
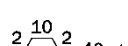
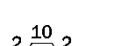
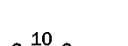
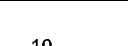
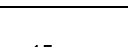
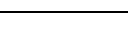
Parameters description:

Symbol	Description	Available parameters
	Treatment time	30 seconds – 60 minutes, 30 seconds step
	Shape of the current	 Rectangular pulse current
		 Rectangular pulse current according to Träbert (Ultra Reiz)
		 Rectangular pulse current according to Leduc
		 Neofaradic rectangular pulse current
		 Triangular pulse current
	Continuous or interrupted shape of the current	 Continuous
		 <ul style="list-style-type: none"> Pulse frequency is 4 kHz Duty factor 80% Pulse time values of 100 µs and 200 µs do not have pause

Symbol	Description	Available parameters			
	Pulse duration	<ul style="list-style-type: none"> Regulation range 100 μs – 1 s for rectangular and triangular pulse current Regulation range 100 μs – 200 ms for rectangular and triangular pulse current with the operation of training program PT Constant 2 ms for Ultra Reiz Constant 1 ms for Leduc's and neofaradic currents 			
	Pause duration	<ul style="list-style-type: none"> Regulation range 1 ms – 10 s for rectangular and triangular pulse current Regulation range 1 ms – 200 ms for rectangular and triangular pulse current with the operation of training program PT Constant 5 ms for Ultra Reiz Constant 9 ms for Leduc's currents Constant 19 ms for neofaradic currents 			
F	Basic pulse frequency	Non editable parameter, displayed for information purposes calculated from the formula $F=1 / (\text{Pulse duration} + \text{Pause duration})$			
PT	Training program	————— No training program			
			Rise time 1 s Contraction phase 3 s Fall time 1 s Rest phase 8 s		
			Rise time 1 s Contraction phase 5 s Fall time 1 s Rest phase 10 s		
			Rise time 2 s Contraction phase 10 s Fall time 2 s Rest phase 50 s		
			Rise time 2 s Contraction phase 10 s Fall time 2 s Rest phase 40 s		
			Rise time 2 s Contraction phase 10 s Fall time 2 s Rest phase 30 s		
			Rise time 2 s Contraction phase 10 s Fall time 2 s Rest phase 20 s		
			Rise time 2 s Contraction phase 10 s Fall time 2 s Rest phase 10 s		
			Rise time 3 s Contraction phase 15 s Fall time 3 s Rest phase 50 s		
			Rise time 3 s Contraction phase 15 s Fall time 3 s Rest phase 30 s		
			For such polarization setting red plug is a positive electrode, and black plug is a negative electrode.		
			Polarization		For such polarization setting red plug is a negative electrode and black plug is a positive electrode. Warning means that such a setting is the reverse of commonly accepted way of marking polarity.
					Automatic polarization switch in the half performed treatment.
		CC CV	Amplifier operation mode	CC – stabilized output current CV – stabilized output voltage	

Symbol	Description	Available parameters
	Maximum amplitude	0 – 60 mA in CC mode Regulation: <ul style="list-style-type: none"> • 0,1 mA in the range of 0-10 mA • 0,5 mA in the range of 10-20 mA • 1 mA in the range of 20-60 mA
		0 – 100 V in CV mode, max. 60 mA Regulation: <ul style="list-style-type: none"> • 0,5 V in the range of 0-100 V

5.1.6 Kotz' current (Russian stimulation)

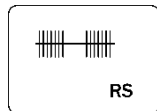





Kotz' current is a medium frequency sinusoidal alternating current. For the stimulation a relatively complicated current train is here applied. Current of 2500 Hz frequency is joined to form rectangular trains or "bursts" with length equal to the pause time (e.g. pulse current with 20 Hz frequency consists of bursts lasting 25 ms and pauses of equal length). The bipolar pulse current of such duty cycle is subjected to amplitude modulation to obtain smooth increase and reduction of output current within patient circuit (by the use of a training program), which results in mild muscle contraction and relaxation effect with determined activity and rest phase. The training program is selected depending on the purpose of therapy and the patient's needs.

Kotz describes stimulations using frequency within the above range, suggesting that by using the 2500 Hz frequency the deeper located muscle layers are excited. The stimulation methodic is similar to the classic method utilizing unipolar rectangular or triangular impulses. Most frequently the bipolar method is used by applying small, flat electrodes above extreme segments of muscle belly. Stimulation involves the parts of muscle groups that perform the same movement.

The Kotz' stimulation influences correctly innervated skeletal muscles. The method is useful for stimulation of hypotrophic muscles disappearing due to immobilization and for exercise of healthy muscles. It can also be used to treat tissue injuries to achieve an analgesic or hyperemic effect. This method does not enable stimulation of partially and totally denervated muscles. It is worth remarking here that the method is practically painless.

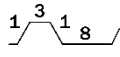
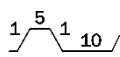
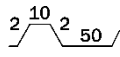
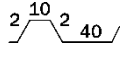
Parameters description:

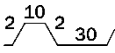
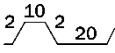
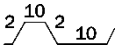
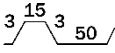
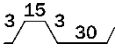
Symbol	Description	Available parameters
	Treatment time	30 seconds – 60 minutes, 30 seconds step
-	Carrier frequency	2500 Hz – default parameter
	Basic frequency	Regulation in the range of 5 Hz – 100 Hz
PT	Training program	————— No training program
		 Rise time 1 s Contraction phase 3 s Fall time 1 s Rest phase 8 s
		 Rise time 1 s Contraction phase 5 s Fall time 1 s Rest phase 10 s
		 Rise time 2 s Contraction phase 10 s Fall time 2 s Rest phase 50 s
		 Rise time 2 s Contraction phase 10 s Fall time 2 s Rest phase 40 s

Symbol	Description	Available parameters
		Rise time 2 s Contraction phase 10 s Fall time 2 s Rest phase 30 s
		Rise time 2 s Contraction phase 10 s Fall time 2 s Rest phase 20 s
		Rise time 2 s Contraction phase 10 s Fall time 2 s Rest phase 10 s
		Rise time 3 s Contraction phase 15 s Fall time 3 s Rest phase 50 s
		Rise time 3 s Contraction phase 15 s Fall time 3 s Rest phase 30 s
	Amplifier operation mode	CC – stabilized output current CV – stabilized output voltage
	Maximum amplitude	<p>0 – 100 mA in CC mode</p> <p>Regulation:</p> <ul style="list-style-type: none"> • 0,5 mA in the range of 0-10 mA • 1 mA in the range of 10-100 mA <p>0 – 100 V in CV mode, max. 100 mA</p> <p>Regulation:</p> <ul style="list-style-type: none"> • 0,5 V in the range of 0-100 V

5.1.7 TENS pulse current

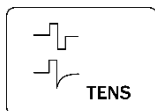

The TENS method (Transcutaneous Electrical Nerve Stimulation) was developed in the sixties as an alternative to the then modern analgesic stimulation with electrodes implanted adjacent to posterior horns of spinal cord. According to the check gate theory of Wall and Melzack, stimulation of fast-conducting nerve fibers of the A type inhibits the conductivity of slow-conducting fibers of the C type, responsible for connection of pain receptors with posterior horns of spinal cord. The check gate constitutes here the common synaptic system, loaded with the burden of A type fiber pulses, which inhibits pain transmission.

Additional phenomenon accompanying the TENS stimulation is increase in endorphin production in Central Nervous System centers.

TENS are used mainly for prolonged analgesic therapy and for stimulation of skeleton muscles.

The pulse current used with this method consists of rectangular bipolar pulses, symmetrical, asymmetrical or asymmetrical with alternately changing polarization. The choice of pulse shape is at the discretion of the patient's preferences. Symmetric and asymmetric pulses have similar biophysical properties. The pulse duration is short, whereas the amplitude is relatively high. The pulse frequency occurs within the range from several to more than one hundred Hertz. The TENS pulse current is frequency and amplitude modulated, which aims at delay in adaptation and creation of relax phases during session.













The BURST 7/2 program consist of 7 pulse sequences (timp = 100 μ s) generated every 10 ms, occurring with 2 Hz frequency.

The BURST 7/4 program consist of 7 pulse sequences (timp = 100 μ s) generated every 10 ms, occurring with 4 Hz frequency.

The BURST 9/2 program consist of 9 pulse sequences (timp = 100 μ s) generated every 10 ms, occurring with 2 Hz frequency.

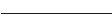
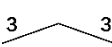
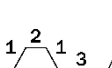
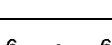
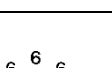
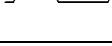
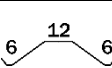
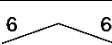
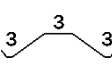
The BURST 9/4 program consist of 9 pulse sequences (timp = 100 μ s) generated every 10 ms, occurring with 4 Hz frequency.

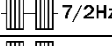
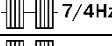
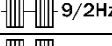
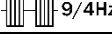
Parameters description:

Symbol	Description	Available parameters	
	Treatment time	30 seconds – 60 minutes, 30 seconds step	
	Shape of the current	 Symmetric	
		 Asymmetric	
		 Alternating asymmetric	
	TENS pulse duration	Possible settings: 25 μs, 50 μs, 75 μs, 100 μs, 125 μs, 150 μs, 175 μs, 200 μs, 250 μs, 300 μs	
	Basic frequency	Regulation in the range of 1 Hz – 100 Hz	
	Frequency spectrum	Regulation in the range of 5 Hz – 150 Hz	
FM	Frequency modulation program	 Frequency modulation program is switched off	
		 Frequency rise time 3 s Frequency fall time 3 s	
		 Frequency rise time 1 s Hold time of maximum frequency 2 s Frequency fall time 1 s Hold time of basic frequency 3 s	
		 Frequency rise time 6 s Frequency fall time 6 s	
		 Frequency rise time 6 s Hold time of maximum frequency 6 s Frequency fall time 6 s Hold time of basic frequency 6 s	
		 Frequency rise time 12 s Frequency fall time 12 s	
		RAND	Random pulse generation
		AM	Amplitude modulation program
 Amplitude rise time 6 s Hold time of maximum amplitude 12 s Amplitude fall time 6 s			
 Amplitude rise time 6 s Amplitude fall time 6 s			
 Amplitude rise time 3 s Hold time of maximum amplitude 3 s Amplitude fall time 3 s			
	BURST mode	 7/2Hz 7 pulse sequences, 2 Hz	
		 7/4Hz 7 pulse sequences, 4 Hz	
		 9/2Hz 9 pulse sequences, 2 Hz	
		 9/4Hz 9 pulse sequences, 4 Hz	
CC CV	Amplifier operation mode	CC – stabilized output current CV – stabilized output voltage	
	Maximum amplitude	<p>0 – 140 mA in CC mode</p> <p>Regulation:</p> <ul style="list-style-type: none"> 0,5 mA in the range of 0-10 mA 1 mA in the range of 10-140 mA <p>0 – 140 V in CV mode, max. 140 mA</p> <p>Regulation:</p> <ul style="list-style-type: none"> 0,5 V in the range of 0-140 V 	

5.1.8 SP-TENS pulse current

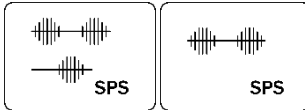

On the basis of classical TENS pulse currents, SP-TENS currents were created, intended for spastic paralysis treatments. Stimulation may be performed by using one- or two-channels simultaneously. While two-channel operation, during the stimulation phase in one channel, in the second channel the rest phase occurs, then there is a change.

Parameters description:

Symbol	Description	Available parameters
	Treatment time	30 seconds – 60 minutes, 30 seconds step
	SP-TENS current	One-channel Sequence, available only in
	TENS pulses type in A and B circuits	Symmetric Asymmetric
	TENS pulses duration time in A and B circuits	Possible settings: 25 μ s, 50 μ s, 75 μ s, 100 μ s, 125 μ s, 150 μ s, 175 μ s, 200 μ s, 250 μ s, 300 μ s
	Basic frequency in A and B circuits	Regulation in the range of 30 Hz – 100 Hz
PT	Training program	Stimulation phase 2 s Rest phase 2 s
		Stimulation phase 2 s Rest phase 4 s
		Stimulation phase 2 s Rest phase 6 s
		Stimulation phase 2 s Rest phase 10 s
		Rise time 0,5 s Stimulation phase 3 s Fall time 0,5 s Rest phase 4 s
		Rise time 0,5 s Stimulation phase 3 s Fall time 0,5 s Rest phase 8 s
		Rise time 1 s Stimulation phase 4 s Fall time 1 s Rest phase 6 s
		Rise time 1 s Stimulation phase 4 s Fall time 1 s Rest phase 10 s
		Rise time 2 s Stimulation phase 6 s Fall time 2 s Rest phase 10 s

Symbol	Description	Available parameters
	Maximum amplitude	0 – 140 mA in CC mode Regulation: <ul style="list-style-type: none"> • 0,5 mA in the range of 0-10 mA • 1 mA in the range of 10-140 mA
		0 – 140 V in CC mode, max. 140 mA Regulation: <ul style="list-style-type: none"> • 0,5 V in the range of 0-140 V

5.1.9 Interferential currents

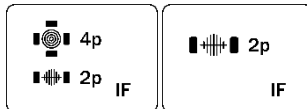

Interferential current is a two-channel sine wave current with carrier frequency with modulated amplitude. Most frequently basic frequency is modulated, i.e. it changes with the time within the preset spectrum.

As opposed to the classic technique of generating interferential currents within patient's tissue (frequency interference), with the PhysioGo unit the internal modulation process has been transferred to the inside of the unit. This technology causes generation of interference field occupying much space (the therapeutic current passes larger tissue space than with the classic method), interference occurs even in case of not very precise electrode application, which simplifies the treatment method.









In case of **dynamic interferential current** additional amplitude and phase modulation of both channels was introduced, which causes the area of most effective therapeutic current operation to sweep in cycles the area between the electrodes (vector scanning). This effect increases additionally the volume capacity exposed to stimulation and continuous change of interference field location delays the adaptation process.



Isoplanar interferential current – its properties are similar to the current resulting from the classical interference, generated by the older unit versions. The unit has the additional amplitude modulation causing that the treatment covers the entire area between the electrodes and not just a small part on bisector of angles formed by lines connecting the electrodes centers from both circuits. This simplifies the placement of electrodes and improves the spatiality of the current therapeutic effect.

Static interferential current – is not directly available. In order to apply this current you should choose **AMF** current working in **A+B mode** and use both channels while placing the electrodes.

AMF current – two-electrode technique is applied with two electrodes (one channel). Its biophysical properties are the same as in the case of standard interference, however, it features somewhat lesser penetration range. It is recommended for electrotherapy applied onto a small area or in places, which are not easily accessible. Because of the similarity to the interferential current it is determined as the IF-2P on the list of treatment programs.

Parameters description:

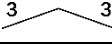
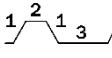
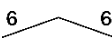
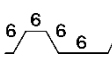
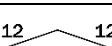
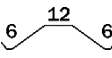
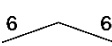
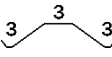
Symbol	Description	Available parameters
	Treatment time	30 seconds – 60 minutes, 30 seconds step
	Shape of the current	 Diadynamic interferential current
		 Isoplanar interferential current
		 One-channel AMF current
	Carrier frequency	Possible settings 2000 Hz, 4000 Hz, 6000 Hz, 8000 Hz, 10000 Hz
	Basic frequency	Regulation in the range of 1 Hz – 100 Hz
	Frequency spectrum	Regulation in the range of 5 Hz – 200 Hz

Symbol	Description	Available parameters	
	Pulse duration	Possible settings 4 s, 6 s, 8 s, 10 s	
FM	Frequency modulation program	—————	Frequency modulation program is switched off
			Frequency rise time 3 s Frequency fall time 3 s
			Frequency rise time 1 s Hold time of maximum frequency 2 s Frequency fall time 1 s Hold time of basic frequency 3 s
			Frequency rise time 6 s Frequency fall time 6 s
			Frequency rise time 6 s Hold time of maximum frequency 6 s Frequency fall time 6 s Hold time of basic frequency 6 s
			Frequency rise time 12 s Frequency fall time 12 s
AM	Amplitude modulation program	—————	Amplitude modulation program is switched off
			Amplitude rise time 6 s Hold time of maximum amplitude 12 s Amplitude fall time 6 s
			Amplitude rise time 6 s Amplitude fall time 6 s
			Amplitude rise time 3 s Hold time of maximum amplitude 3 s Amplitude fall time 3 s
	Amplifier operation mode	CC – stabilized output current CV – stabilized output voltage	
	Maximum amplitude	<p>0 – 100 mA in CC mode</p> <p>Regulation:</p> <ul style="list-style-type: none"> • 0,5 mA in the range of 0-10 mA • 1 mA in the range of 10-100 mA <p>0 – 100 V in CC mode, max. 100 mA</p> <p>Regulation:</p> <ul style="list-style-type: none"> • 0,5 V in the range of 0-100 V 	



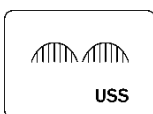



5.1.10 USS – Unipolar Sine Surge

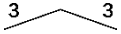
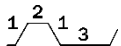
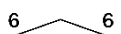
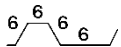
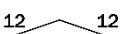
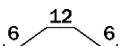
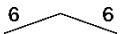
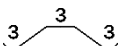

Unipolar (unidirectional) Sine Surge current is an average frequency current with modulated amplitude. The shape of the generated wave is very similar to the interferential current, the main difference relates to the polarization and generation of electrochemical changes under the electrodes, as in the constant current. Therefore, you must pay special attention to safety during treatment. It is recommended to use thick pads and it is possible to change the polarity while the treatment is performed.

The biggest advantage stems from the fact that this current is better tolerated by patients than the low frequency pulse current and direct current, it also creates proper conditions for affecting tissues located deeper. By modulating the low frequency amplitude, there are possibilities of using medium frequency unipolar current in order to relief acute and chronic pain disorders, improving peripheral circulation, acceleration of wound healing, strengthening muscles as well as to ionophoresis treatments.

Parameters description:

Symbol	Description	Available parameters
	Treatment time	30 seconds – 60 minutes, 30 seconds step
-	Carrier frequency	40 kHz modulated by rectangular pulses with 4 kHz frequency and duty factor 50%
	Basic frequency	Regulation in the range of 1 Hz – 100 Hz
	Frequency spectrum	Regulation in the range of 5 Hz – 200 Hz
FM	Frequency modulation program	————— Frequency modulation program is switched off
		 Frequency rise time 3 s Frequency fall time 3 s
		 Frequency rise time 1 s Hold time of maximum frequency 2 s Frequency fall time 1 s Hold time of basic frequency 3 s
		 Frequency rise time 6 s Frequency fall time 6 s
		 Frequency rise time 6 s Hold time of maximum frequency 6 s Frequency fall time 6 s Hold time of basic frequency 6 s
		 Frequency rise time 12 s Frequency fall time 12 s
		AM
 Amplitude rise time 6 s Hold time of maximum amplitude 12 s Amplitude fall time 6 s		
 Amplitude rise time 6 s Amplitude fall time 6 s		
 Amplitude rise time 3 s Hold time of maximum amplitude 3 s Amplitude fall time 3 s		
	Polarization	
		 For such polarization setting red plug is a negative electrode and black plug is a positive electrode. Warning means that such a setting is the reverse of commonly accepted way of marking polarity.
		 Automatic polarization switch in the half performed treatment.
CC / CV	Amplifier operation mode	CC – stabilized output current CV – stabilized output voltage
	Maximum amplitude	0 – 100 mA in CC mode Regulation: <ul style="list-style-type: none"> • 0,1 mA in the range of 0-10mA • 0,5 mA in the range of 10-20 mA • 1 mA in the range of 20-100 mA
		0 – 100 V in CC mode, max. 100 mA Regulation: <ul style="list-style-type: none"> • 0,5 V in the range of 0-100 V

5.1.11 Tonolysis

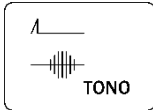

Tonolysis is a method of two-channel electrostimulation, which through proprioceptive facilitation of impulse transmission along nervous pathways aims at restoration of physiological balance of nerve fiber stimulation. It is applied in case of dysfunctions of central nervous system, when spastic muscle paralysis occurs. Due to lack of central regulation of muscle spindles domination of stimulation by flexor muscle tone occurs as well as weakness and stretching of extensor muscles acting on joints. With tonolysis spastically paralyzed muscles are stimulated with short triangular impulse of high output current. In this way their strong contraction is evoked, which is followed by their relaxation. In the phase of relaxation of flexor muscles, muscles operating antagonistically in relation to flexors, which are extensors, are stimulated with a sequence of amplitude modulated impulses. Alternative operation of flexor and extensor muscles, forced by the passage of the current, results in reproduction of the movement mechanism and restoration of physiological balance of paralyzed muscles.

The biological effect of tonolysis consists of:

- alternative facilitation of impulse transmission along nervous pathways of muscles flexing and extending joints,
- activation of new multi-synaptic junctions.

Parameters description:

Symbol	Description	Available parameters
	Treatment time	30 seconds – 60 minutes, 30 seconds step
	Trigger pulse shape (channel A)	Rectangular pulse Triangular pulse
	Trigger pulse duration	Regulation in the range of 100 μ s – 10 ms
	Pocket frequency	Regulation in the range of 0,2 Hz – 10 Hz
	Stimulating pulse envelope shape (channel B)	Sinusoidal bipolar Frequency and current shape: <ul style="list-style-type: none"> • Rectangular 4 kHz
		Sinusoidal unipolar Frequency and current shape: <ul style="list-style-type: none"> • 40 kHz modulated by rectangular pulses with 4 kHz frequency • Duty factor 50%
		Triangular bipolar Frequency and current shape: <ul style="list-style-type: none"> • Rectangular 4 kHz
		Triangular unipolar Frequency and current shape: <ul style="list-style-type: none"> • 40 kHz modulated by rectangular pulses with 4 kHz frequency • Duty factor 50%
	Time lag between channels	Regulation in the range of 5 ms – 300 ms
	Stimulating pulse width (Stimulation duration)	Regulation in the range of 5 ms – 1000 ms
	Polarization	For such polarization setting red plug is a positive electrode, and black plug is a negative electrode.
		For such polarization setting red plug is a negative electrode and black plug is a positive electrode. Warning means that such a setting is the reverse of commonly accepted way of marking polarity.
	Amplifier operation mode	CC – stabilized output current CV – stabilized output voltage

Symbol	Description	Available parameters
	Maximum amplitude	CC mode: 0 – 100 mA for trigger pulses – channel A Regulation: <ul style="list-style-type: none"> 0,5 mA in the range of 0-20 mA 1 mA in the range of 20-100 mA 0 – 60 mA for unipolar stimulating pulses – channel B Regulation: <ul style="list-style-type: none"> 0,5 mA in the range of 0-20 mA 1 mA in the range of 20-60 mA 0 – 100 mA for bipolar stimulating pulses – channel B Regulation: <ul style="list-style-type: none"> 0,5 mA in the range of 0-20 mA 1 mA in the range of 20-100 mA
		CV mode: 0 – 100 V max. 60 mA for unipolar stimulating pulses – channel B 0 – 100 V max. 100 mA for trigger pulses (channel A) and bipolar stimulating pulses (channel B) Regulation: <ul style="list-style-type: none"> 0,5 V in the range of 0-100 V

5.1.12 Microcurrents

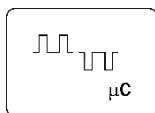









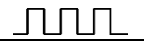
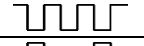

Microcurrents characterize significantly lower values of amplitudes in comparison with traditional currents used in electrotherapy. Unipolar and bipolar currents are used in a therapy. The applied amplitudes are so low that they are not felt by the patient, and the signal is a subliminal stimulation (it does not stimulate the nerves).

There is also significantly reduced risk of side effects like irritation, skin burns and damages as well as discomfort of current flow felt by some patients.

Microcurrent restores the biological, electrical balance of tissues, which is necessary to stimulate healing processes.

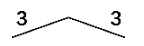
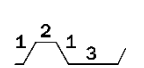
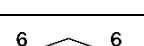
Parameters description:

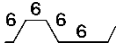
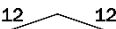
Symbol	Description	Available parameters
	Treatment time	30 seconds – 60 minutes, 30 seconds step
	Shape of the current	 Positive
		 Negative
		 Alternating
	Pulse duration	Regulation in the range of 1 ms – 500 ms
	Basic frequency	Regulation in the range of 0,3 Hz – 500 Hz
	Frequency spectrum	Regulation in the range of 5 Hz – 500 Hz
FM	Frequency modulation program	 Frequency modulation program is switched off
		 Frequency rise time 3 s Frequency fall time 3 s
		 Frequency rise time 1 s Hold time of maximum frequency 2 s Frequency fall time 1 s
		 Hold time of basic frequency 3 s Frequency rise time 6 s Frequency fall time 6 s

Symbol	Description	Available parameters
		 Frequency rise time 6 s Hold time of maximum frequency 6 s Frequency fall time 6 s Hold time of basic frequency 6 s
		 Frequency rise time 12 s Frequency fall time 12 s
	Maximum amplitude	0 – 1000 µA in CC mode Regulation: <ul style="list-style-type: none"> • 50 µA within the range

5.2 Ultrasound therapy



The term ultrasounds applies to mechanical vibrations with frequency that exceeds the upper limit of human hearing (above 20 kHz). Electromechanically active substances, that are distorted as a result of an external electric field, are used for generation of ultrasounds used in physical therapy. In physical medicine, sound waves are generated by electroacoustic transducers using the reverse piezoelectric effect. Mechanical vibrations of the piezoelectric element are conducted to the surface of the ultrasound head. Particles adjacent to the vibrating surface of the ultrasonic transducer begin to oscillate around their equilibrium position. The vibrations are transferred to the next particles causing the formation of a mechanical wave that propagates in space and time. When the ultrasound head comes into contact with the patient's body, the ultrasound waves propagate in the form of longitudinal waves, which cause parallel movement of particles in the same direction as the energy flow. The frequencies used in physiotherapy are typically between 0.8 and 3.5 MHz.

Absorption of the energy by tissues to which it is applied produces the therapeutic effects. The greatest amount of ultrasound energy is absorbed in human tissues with a high content of proteins, such as tendons and articular cartilage.

In tissues, the ultrasound produces:

- thermal effects,
- mechanical effects,
- physicochemical changes.

The thermal effect is based on the increase in the temperature of the tissues, that results from the conversion of kinetic and potential energy (molecules oscillation around the equilibrium position) into thermal energy. The physiological responses to the rise of the temperature include:

- increase in collagen flexibility,
- acceleration of blood flow,
- changes in the peripheral nerves conduction velocity,
- increase of pain threshold,
- acceleration of enzymes activity,
- changes in skeletal muscles contractile activity.

The non-thermal ultrasound mechanisms include:

- mechanical changes (micromassage),
- cavitation (formation of cavities penetrated by vapors of liquids, that are result of overcoming cohesive forces and breaking the water bonds in the emerging areas of negative pressure),
- chemical changes.

Under the influence of the mechanical energy of the ultrasounds, the following physiological effects occur:

- increase of the intracellular calcium level,
- degranulation of mastocytes,
- stimulation of fibroblasts activity,
- increase of the permeability of vascular walls,
- increase of angiogenesis,
- increase of the tensile strength of collagen fibers.

Because of the mechanical and thermal effects, the ultrasounds cause physicochemical changes in tissues, including:

- acceleration of conventional reactions as well as oxidation and reduction in aqueous solutions,
- degradation of polymers,
- lysis and reactions in organic solvents.







The biological effect of ultrasounds is the resultant of thermal, mechanical and physicochemical effects and includes:

- agitation of fibroblast activity,
- stimulation of collagen synthesis,
- stimulation of synthesis of non-collagen proteins in fibroblasts (albumin and globulin),
- acceleration of DNA synthesis,
- vasodilation and hyperemia of organs,
- intracellular increase of calcium synthesis,
- degranulation of mastocytes,
- acceleration of angiogenesis,
- agitation of cellular oxidation processes,
- change of cell membrane functions,
- change of nerve fibers conduction rates.

Ultrasounds, due to their biological effects in tissues, are used to:

- treat inflammation,
- reduce pain and swelling,
- increase the flexibility of connective tissue,
- reduce muscle tension,
- accelerate tissue healing, including bone fusion,
- reconstruct and improve circulation.

Parameters description:

Symbol	Description	Available parameters
	Head type	4cm² – GS/GSW-4/1 type – ultrasound head with acoustic working frequency of 1 MHz or 3,5 MHz, with the effective radiation area – 4 cm ² 1cm² – GS/GSW-1/1 – ultrasound head with acoustic working frequency of 1 MHz or 3,5 MHz, with the effective radiation area – 1 cm ²
	Acoustic working frequency	Available settings: <ul style="list-style-type: none"> • 1 MHz • 3,5 MHz
	Amplitude	Setting – power density [W/cm ²]: <ul style="list-style-type: none"> • max. 2 W/cm² for any head working in continuous mode • max. 3 W/cm² for any head working in pulse mode Setting – power [W]: <ul style="list-style-type: none"> • max. 8 W for 4cm² head working in continuous mode • max. 12 W for 4cm² head working in pulse mode • max. 2 W for 1 cm² head working in continuous mode • max. 3 W for 1 cm² head working in pulse mode Regulation: <ul style="list-style-type: none"> • 0,1 W/cm²
	Pulse operation frequency	Available settings: <ul style="list-style-type: none"> • 16 Hz, 48 Hz, 100 Hz – pulse mode, • cont – continuous mode
	Pulse duration	Available settings: <ul style="list-style-type: none"> • 5 – 75%, step 5% – pulse mode • 100% – continuous mode (forced by cont setting in pulse operation frequency field)
	Treatment time	30 seconds – 30 minutes, 30 seconds step

Pulse time according to set frequency and duration:



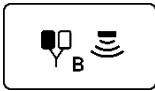

Pulse repetition period / pulse repetition frequency	Duty factor	
	min 5%	max 75%
62,5 ms / 16 Hz	3,125 ms	46,87 ms
20,8 ms / 48 Hz	1,04 ms	15,62 ms
10 ms / 100 Hz	0,5 ms	7,5 ms

5.3 Combined therapy



Combined therapy joins electrotherapy and ultrasound therapy into one treatment. The current in this type of treatment is generated in channel B. The active electrode is a front ultrasound head, the passive electrode is the red plug connected to socket B. The number of currents is limited, there are available only unidirectional (unipolar) currents according to the following chart.

Parameters description:









Therapy	Available parameters	
Ultrasound therapy	All parameters are consistent with chapter 5.2.	
Electrotherapy	TENS currents 	
	AMF current  2p IF	All parameters are consistent with chapter 5.1.
	Kotz' current 	
	Treatment time	30 seconds – 30 minutes, 30 seconds step



5.4 Low frequency magnetotherapy

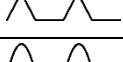
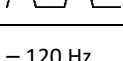

The treatment procedure with the use of a magnetic field applicator is performed locally. The magnetic field is focused only on the part of the body, which will be subjected to therapy. In contrast to the classical method of magnetic field application with the use of solenoid applicators, such a solution substantially reduces the impact of magnetic field on the other parts of the patient's body and the unit's environment, including the operating personnel. Carrying out treatment procedures is possible at any place without the need of therapeutic room specially designed for that purpose.

Characteristic of treatment parameters:

Symbol	Description	Available parameters
	Magnetic field shape	 Rectangular
		 Triangular
		 Sinusoidal
		 Half-rectangular
		 Half-triangular
		 Half-sinusoidal
	Magnetic field frequency	2 Hz – 120 Hz
	Pause time in operation mode with modulation	<ul style="list-style-type: none"> cont – continuous mode Pause time – settings 0,5; 1; 1,5; 2; 3; 4; 6; 8 s
	Pulse time in operation mode with modulation	Continuous, 1 s

Symbol	Description	Available parameters
	Induction	<ul style="list-style-type: none"> 0,5 mT – 10 mT 5 Gs – 100 Gs Regulation: <ul style="list-style-type: none"> 0,5 mT 5 Gs
	Treatment time	30 seconds – 30 minutes, 30 seconds step

With the increase of operation frequency, reduction of effective induction occurs due to the limited efficiency of the magnetic field generator. The reduction occurs from the frequency of 60 Hz and for the maximum value 120 Hz it is 40%.

5.5 Laser therapy

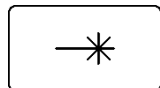

Due to the wide impact range, lasers may be applied to treat disorders on many fields, among others in:

- sports medicine,
- orthopedics,
- rheumatology,
- neurology,
- dermatology.
- laryngology,
- stomatology.

An important factor of bio-stimulating laser activity is the missing heat effect, which allows application for acute conditions.

Characteristic of laser radiation sources used in laser applicators:

Applicator type	Rated optical power	Wavelength	Laser diode type	Operation mode
80RDV3	80 mW	660 nm ± 5 nm	Semiconductor	Continuous and pulse operation mode
400IRV3	400 mW	808 nm ± 5 nm	Semiconductor	Continuous and pulse operation mode
SKW2-450 / SK2-450	100 mW	660 nm ± 5 nm	Semiconductor	Continuous and pulse operation mode
	450 mW	808 nm ± 5 nm	Semiconductor	Continuous and pulse operation mode
CL1800WH / CL1800	5x40 mW	660 nm ± 5 nm	Semiconductor	Continuous and pulse operation mode
	4x400 mW	808 nm ± 5 nm	Semiconductor	Continuous and pulse operation mode

Applicator type	Beam type	Nominal distance of sight hazard	Beam divergence	Class
80RDV3	divergent	6,2 m	0,025 rad ± 0,005 rad	3B
400IRV3	divergent	> 8 m	0,025 rad ± 0,005 rad	3B
SKW2-450 / SK2-450	660 nm divergent	> 8 m	0,025 rad ± 0,005 rad	3B
	808 nm divergent	> 8 m	0,025 rad ± 0,005 rad	3B
CL1800WH / CL1800	660 nm 5x divergent	2,7 m	5 x 0,045 rad ± 0,005 rad	3B
	808 nm 4x divergent	> 8 m	4 x 0,045 rad ± 0,005 rad	3B

The values of maximum permissible exposure:

Radiation type	Wavelength	Influence	Maximum permissible exposure value
Direct beam or reflected beam	660 nm ± 5 nm	Cornea	10 W/m ²
		Skin	2000 W/m ²
Dispersion	660 nm ± 5 nm	Cornea, photochemical hazard	13 182 W/m ²
		Cornea, thermal hazard	380 W/m ²
	808 nm ± 5 nm	Cornea	16,6 W/m ²

Direct beam or reflected beam	Skin	3320 W/m ²
Dispersion	Cornea	35 W/m ²

5.5.1 Point laser applicators

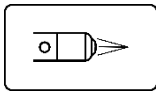

Characteristic of treatment parameters:

Symbol	Description	Available parameters
	Type of connected applicator	IR R laser applicator with the 808 nm wavelength laser applicator with the 660 nm wavelength
	Energy dose	0,5 J/cm ² – 15 J/cm ² regulation step 0,5 J/cm ²
	Irradiated area	0,1; 0,3; 1, 3, 5; 10; 15; 20; 25; 30 cm ²
	Pulse frequency	<ul style="list-style-type: none"> cont – continuous mode 1 Hz – 5000 Hz – pulse mode
	Filling during pulse operation	<ul style="list-style-type: none"> Constant pulse 50 μs 10 – 90% regulation step 5%
	Radiation output power	25%, 50%, 75%, 100% of rated power
	Laser aperture	Lens Optical fiber applicator – straight / angled Optical fiber applicator narrowed for laser acupuncture
	Delivered energy	Maximum 450 J
	Treatment time	1 second – 100 minutes, variable step

When using the optical fiber applicators, due to the attenuation, the correction factor found its application in calculation of treatment time. This allows to preserve the effectiveness of the treatment, because the effective dose of energy delivered to the tissue remains unchanged in relation to the exposure with the use of the lens. For standard fiber applicators the treatment time is extended up to 25%, for applicators dedicated to laser acupuncture up to 67%.

5.5.2 Scanning applicator



Characteristic of treatment parameters:

Symbol	Description	Available parameters
	Type of radiation source	IR Laser diode with the 808 nm wavelength
		R Laser diode with the 660 nm wavelength
		R+IR Laser diode with the 660 nm wavelength and laser diode with the 808 nm wavelength
	Energy dose	0,5 J/cm ² – 20 J/cm ² regulation step 0,5 J/cm ²
	Radiation output power	1/2 50% of rated power
		MAX 100% of rated power
	Shape of treatment area	Line
		Ellipse
		Rectangle
	Size of treatment area in axis X and Y	1 – 100% in both axes
		20 – 100% in both axes
		20 – 100% in both axes
	Distance applicator-patient	2 cm – 100 cm
	Pulse frequency	<ul style="list-style-type: none"> cont – continuous mode 1 Hz – 5000 Hz – pulse mode Duty factor: 75%, non-editable parameter
	Treatment time	1 second – 100 minutes, variable step
	Delivered energy	Maximum 3300 J

Characteristics of treatment area:

- rectangle linear – rectangular shape of area is scanned, pilot beam is visible as a line – length is set in X axis and reciprocates at a distance set in Y axis, the treatment area is uniformly illuminated,
- rectangle quasi-uniform – rectangular shape of area is scanned, pilot beam is visible as an ellipse, its axis reciprocates between the diagonals of rectangle in dimensions set in X and Y axis – the treatment area is uniformly illuminated,
- ellipse – ellipse shape of area is scanned, pilot beam is visible as an ellipse (circle) that pulses from the center to the center.

5.5.3 Cluster applicator

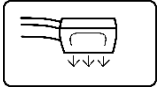

Characteristic of treatment parameters:

Symbol	Description	Available parameters	
	Type of radiation source	1xR	One laser diode with the 660 nm wavelength
		1xIR	One laser diode with the 808 nm wavelength
		5xR	Five laser diodes with the 660 nm wavelength
		4xIR	Four laser diodes with the 808 nm wavelength
		5xR+4xIR	<ul style="list-style-type: none"> Five laser diodes with the 660 nm wavelength Four laser diodes with the 808 nm wavelength
	Energy dose	1 J/cm ² – 15 J/cm ² regulation step 0,5 J/cm ²	
	Irradiated area	0,1; 0,2; 0,5; 1, 2, 5, 10, 15, 20 cm ² for single-diode modes 25, 50, 75, 100, 125, 150, 200 cm ² for multi-diode modes	
	Radiation output power	 1/2	50% of maximum output power for each of laser diodes
		 MAX	100% of maximum output power for each of laser diodes
	Pulse frequency	<ul style="list-style-type: none"> cont – continuous mode 1 Hz – 5000 Hz – pulse mode 	
	Filling during pulse operation	<ul style="list-style-type: none"> Constant pulse 50 μs 10 – 90% regulation step 5% 	
	Treatment time	1 second – 100 minutes, variable step	
	Delivered energy	Maximum 3000 J	

5.6 Intended clinical benefits of the therapies

Clinical benefits description:

Intended clinical benefits - electrotherapy	
TENS and SP-TENS pulse current	Interference current and AMF current
<p>Pain reduction, circulation improvement, muscle stimulation, stimulation of nerve fibers of different thickness depending on the frequency range, pulse width and type of modulation:</p> <ul style="list-style-type: none"> • pulse duration 50-100 μs, frequency 50-150 Hz, intensity above the sensory threshold and below the motor threshold - inhibition of pain transmission at the level of the spinal cord • pulse duration 100-300 μs, frequency 1-10 Hz, intensity above the motor threshold - stimulation of endorphin synthesis, facilitation of impulse transmission along nervous pathways in afferent fibers, stimulation in electroacupuncture • pulse duration 200-300 μs, frequency 5-50 Hz, intensity above the motor threshold - stimulation of motor units • BURST, intensity above the motor threshold - strong analgesic effect, increasing the production of endorphins • SP-TENS, intensity above the motor threshold - for the treatment of spastic paralysis 	<p>They act mainly on deeper tissues, showing different biological effects depending on the range of fundamental frequency and the intensity of current:</p> <ul style="list-style-type: none"> • 1-10 Hz, intensity above the sensory threshold and below the motor threshold - stimulation of postganglionic sympathetic fibers • 1-10 Hz, intensity above the motor threshold, stimulation of endorphin production - single muscle contractions • 10-20 Hz, intensity above the sensory threshold and below the motor threshold - stimulation of postganglionic parasympathetic fibers • 10-20 Hz, intensity above the motor threshold - incomplete tetanus contractions • 20-80 Hz, intensity above the motor threshold - complete tetanic contractions • 50-100 Hz, intensity above sensory threshold and below motor threshold - inhibition of pain conduction on the principle of gate control theory • 80-150 Hz, intensity above the sensory threshold and below the motor threshold - inhibition of the preganglionic fibers of the sympathetic system • 90-200 Hz, intensity above the sensory threshold and below the motor threshold - muscle relaxation, increasing local hyperemia
Kotz current - Russian stimulation	Neofaradic pulse current
<ul style="list-style-type: none"> • improvement of trophics and muscle tone • prevention of atrophy • a counterweight to the side effects of connective tissue formation (fibrosis) • muscle strengthening • muscle re-education (after operations, restoration of normal functions) • in sports medicine as training techniques aimed at increasing muscle strength and mass as well as economizing muscle work in order to increase resistance to fatigue 	<p>Pain reduction or triggering skeletal striated muscle contraction in order to:</p> <ul style="list-style-type: none"> • increase muscle strength • improve circulation • re-educate muscles (after operations, restoration of normal functions) • relax muscles • prevent atrophy
Diadynamic currents	Galvanic current
<ul style="list-style-type: none"> • pain relief • improvement of peripheral circulation • normalization of the activity of the vegetative system • muscle relaxation • acceleration of hematoma and edema resorption 	<p>Electrochemical and electrokinetic phenomena which lead to:</p> <ul style="list-style-type: none"> • pain relief • dilatation of peripheral blood vessels • introduction of healing ions into tissues by the forces of an electric field
Träbert current	Unipolar sine surge
<p>Segmental and local action that leads to:</p> <ul style="list-style-type: none"> • reduction of the increased activity of the sympathetic system • reduction of muscle tension locally and segmentally • pain relief • improvement of peripheral circulation 	<ul style="list-style-type: none"> • restoration of the electrical balance of cells and tissues • improvement of circulation in the capillaries • supporting the processes of cell and tissue regeneration • acceleration of breakdown and elimination of lactic acid and pain substances
Leduc current	Rectangular pulses
<ul style="list-style-type: none"> • pain reduction 	<ul style="list-style-type: none"> • stimulation of properly innervated muscles and nerves

Triangular pulses	Tonolysis
<ul style="list-style-type: none"> stimulation of muscles with impaired nerve conductivity 	<ul style="list-style-type: none"> restoring the physiological balance of excitation of spastic paralyzed muscle fibers normalizing spastic muscle tone
Microcurrents	
<ul style="list-style-type: none"> restoring the electrical balance of cells and tissues improving circulation in the capillaries supporting the processes of cell and tissue regeneration accelerating the breakdown and elimination of lactic acid and pain substances 	
Intended clinical benefits – ultrasound therapy	
<p>The biological effects in the tissues, under the influence of the ultrasound energy absorption, include:</p> <ul style="list-style-type: none"> agitation of fibroblast activity stimulation of collagen synthesis vasodilation and hyperemia of organs agitation of cellular oxidation processes change of cell membrane functions change of nerve fibers conduction rates causing the therapeutic effects described on the right 	<p>Therapeutic effects include:</p> <ul style="list-style-type: none"> pain relief acceleration of angiogenesis increase the flexibility of connective tissue acceleration of bone fusion reducing the tension of muscles, tendons and ligaments improving the quality of scar tissue reducing of the ulceration area normalization the rate of repair processes in the tissue healing process shortening the recovery period in sports injuries
Intended clinical benefits – combined therapy	
<ul style="list-style-type: none"> the sum of the effects of electrotherapy and ultrasound therapy greater effectiveness of treatments achieved in a shorter time and with a smaller number of treatments 	
Intended clinical benefits – Laser therapy	Intended clinical benefits – Magnetotherapy
<p>Impact of low energy laser radiation on tissue:</p> <ul style="list-style-type: none"> improvement of micro-circulation stimulation of angiogenesis increase in amplitude of activity potentials with nerve fibers increase in enzyme activity changes in potential of cell membranes changes in secretion of neurotransmitters, hormones and kinins <p>Impact of low energy laser radiation on the cells:</p> <ul style="list-style-type: none"> acceleration of electrolyte exchange between cell and environment increase in biological activity anti-mutagen impact changes in liquid crystal structure of biological membranes changes in intercellular cations concentration increase in synthesis of collagen, proteins, RNA and ATP 	<ul style="list-style-type: none"> faster bone union, pain and oedema reduction reduction of pain (orthopedic disorders) enhancing the quality of life (osteoporosis) symptoms relief, slower or stopped progress faster healing (wound healing, burns) faster healing shorter illness period, symptoms relief (upper and lower respiratory tract diseases) symptoms relief (allergies) pain relief, elimination of inflammations (rheumatic disorders, muscular system inflammations) relief of disorder effects (neurological disorders) increased regeneration of nerve (neurological disorders) pain relief, mitigation of the scope and strength of symptoms (cardiovascular system disorders) relief of pain, tympanites, diarrhea, shorter illness period (digestive system disorders) shorter recovery period (sport injuries) increased vitality (general weakness)

6. Maintenance, cleaning, disinfection



NOTE: The warranty does not cover any damage due to a failure to adhere to the recommendations stated in this chapter.

NOTE: Before attempting to perform following operations isolate the unit from the mains supply!

The activities of maintenance, cleaning and disinfection of device components should be realized at:

- ambient temperature between +15°C to +30°C,
- relative humidity between 30% to 75%,
- atmospheric pressure between 700 hPa and 1060 hPa (70 – 106 kPa).

These conditions are identical to those defined in chapter 3.2 as operation conditions.

There are no limitations for the number of cleaning and disinfection cycles, procedures should be carried out during the entire device “life time”.



6.1 Cleaning of the unit casing

Cleaning of the unit shall be performed with lightly humid sponge or soft cloth with delicate soap solution or mild detergent. It is recommended to use a microfiber cloth, preferably designated for cleaning mirrors or electronic equipment.

Do not use solvents for paints and lacquers. Do not use excessively dampened sponges either, which can lead to water penetration inside the unit.

All cleaned cables shall be wiped with dry cloth and left for complete drying.

Do not connect wet or moist leads!

Do not disinfect or sterilize unit casing. Disinfection of accessories and detachable parts, which are not intended for contact with patient's body (for example cables), shall be carried out at least once a week. It is recommended to use agent based on ethanol and/or isopropyl alcohol e.g. Alpro Minuten Spray or 70% solution of spirit.



All disinfected parts of the device should be completely dry before switching the power on.

It is not recommended to use sanitizers consisting of active oxygen, because it can lead to damage of the unit or its parts.

6.2 Cleaning of touchscreen

To clean the touchscreen, we recommend to use a cloth which is standard part of the unit or other made of microfiber, preferably designated for cleaning mirrors or electronic equipment.

The manufacturer recommends to clean regularly the touchscreen display. Gently moisten the cloth with clean water. The cloth should be drained so that there is no dripping water. The screen should be wiped until removal of all dirt and dust.

The manufacturer does not recommend to use any product designated for cleaning screens, because there is no guarantee that the chemicals will not lead to faster wear out of touch screen layers.



6.3 Cleaning and disinfection of the electrotherapy accessories and detachable parts

Leads and electrodes shall be cleaned with water and gentle soap or mild detergent, and then wiped with dry cloth and left for complete drying. Electrodes shall be thoroughly cleaned after each treatment session.

Do not use wet or moist leads!

Electrodes shall be disinfected after each treatment session. To disinfect it is recommended to use 70 % alcohol solution. It is recommended to use agent based on ethanol and/or isopropyl alcohol e.g. Alpro Minuten Spray or 70% solution of spirit. After disinfection, accessories must be cleaned to avoid allergic reaction.

After each treatment session viscose electrode pads shall be accurately rinsed in clean water, if necessary it is recommended to add some vinegar to the water to remove calcareous deposit. In this case viscose pads shall be rinsed again in clean water. Viscose electrode covers and Velcro belts may be disinfected with 70 % solution of spirit. It is also premised to use agent based on ethanol and/or isopropyl alcohol e.g. Alpro Minuten Spray.

Viscose electrode pads can be also washed in boiling water by the time of 1 minute, after that it is recommended to soak them in saline solution to improve conducting properties. Before immersion in the boiling water, it is recommended to soak viscose pads in the cool water.

If the viscose pads have a material tear or damage to the seams, replace them with new ones.

NOTE: Used electrodes and viscose pads should be disposed of with hospital waste.



6.4 Cleaning and disinfection of the ultrasound heads

Ultrasound heads shall be cleaned with water and gentle soap or mild detergent, and then wiped with dry cloth and left for complete drying. Ultrasound heads shall be thoroughly cleaned after each treatment session.

Ultrasound heads (especially their head fronts) shall be disinfected after each treatment session. To disinfect it is recommended to use 70 % alcohol solution. After disinfection, accessories must be washed (clean, not hot water) to avoid allergic reaction.



6.5 Cleaning and disinfection of the scanning and cluster applicator

Cleaning of the scanning or cluster laser applicator and their cables shall be performed with lightly humid sponge or soft cloth with delicate soap solution or mild detergent. Please be careful while cleaning the protective glass of scanning and cluster applicator output opening. All cleaned parts shall be wiped with dry cloth and left for complete drying.

If protective glass of the:

- scanning applicator output opening,
- cluster applicator output opening,

is dirty, soak the cloth (made from dust-free fabric) with isopropyl alcohol or glasses cleaner and carefully clean them. You can apply glasses cleaner from Chemax, Uvex, Carl Zeiss, Bausch&Lomb or Alpro.

Do not use humid or wet laser applicators and cables!

Do not use solvents for paints and lacquers. Do not use excessively dampened sponges either, which can lead to water penetration inside the unit or any laser applicator.

Where it is necessary to disinfect (accidental contact with patient's body), it is recommended to use agent based on ethanol and/or isopropyl alcohol e.g. Alpro Minuten Spray or 70% solution of spirit. After disinfection, detachable parts must be cleaned to avoid allergic reaction.

It is not recommended to use sanitizers consisting of active oxygen, because it can lead to laser applicators surface damage.



6.6 Cleaning and disinfection of the point laser applicators

Point laser applicators and their cables shall be cleaned with water and gentle soap or mild detergent, and then wiped with dry cloth and left for complete drying.

If the laser probe lens glass is dirty, soak the cloth (made from dust-free fabric) with isopropyl alcohol or glasses cleaner and carefully clean them. You can apply glasses cleaner from Chemax, Uvex, Carl Zeiss, Bausch&Lomb or Alpro. While cleaning pay attention, if the lens is not scratched.

Do not use humid or wet laser applicators and cables!

Do not use solvents for paints and lacquers. Do not use excessively dampened sponges either, which can lead to water penetration inside the unit or any laser applicator.

Lenses and components fixing lenses to applicator casing may contact patient's body during treatment procedure. Perform disinfection of these components after each treatment procedure, where there is contact with the patient's body. It is recommended to use sanitizers based on ethanol and/or isopropyl alcohol e.g. Alpro Minuten Spray or 70% solution of spirit. If no contact with patient's body takes place, apply disinfection using above mentioned agents at least once a week.

The recommendation also applies to other elements of the point laser applicator point case. After disinfection, accessories must be cleaned to avoid allergic reaction.

It is not recommended to use sanitizers consisting of active oxygen, because it can lead to laser applicators surface damage.



6.6.1 Disinfection and sterilization of the optical fiber applicators

Optical fiber applicators in combination with laser probes may contact patient's body during treatment procedure. Perform disinfection of these components after each treatment procedure, where there is contact with the patient's body. It is recommended to use sanitizers based on ethanol and/or isopropyl alcohol e.g. Alpro Minuten Spray or 70% solution of spirit. If no contact with patient's body takes place, apply disinfection using above mentioned agents at least once a week. The recommendation also applies to other elements of the point laser applicator point case. After disinfection, accessories must be cleaned to avoid allergic reaction.

Optical fiber applicators could be sterilized by any steam method.



6.7 Cleaning and disinfection of magnetic field applicators

Cleaning of the applicators casings shall be performed with lightly humid sponge or soft cloth with delicate soap solution or mild detergent. Then cleaned applicators shall be wiped with dry cloth and left for complete drying.

Do not use solvents for paints and lacquers. Do not use excessively dampened sponges either, which can lead to water penetration inside the applicator.

Perform disinfection of magnetic field applicators after each treatment procedure, where there is contact with the patient's body. It is recommended to use sanitizers based on ethanol and/or isopropyl alcohol e.g. Alpro Minuten Spray or 70% solution of spirit. After disinfection, detachable parts must be cleaned to avoid allergic reaction.

It is not recommended to use sanitizers consisting of active oxygen, because it can lead to damage of the unit or its parts.

6.8 Verification of interconnecting cables and electrodes condition



The content of this point applies to units with electrotherapy function.

6.8.1 Cable condition control



To check the cable condition you may use the function available in setup mode **Service** – "Electrodes test".

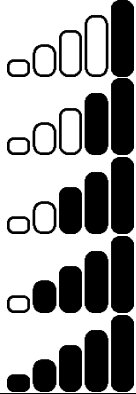

Special caution should be exercised due to the possibility of high current flow while testing cables. While performing the test, do not touch the cable plug that is examined!

Step	Description
1.	Switch on the unit.
2.	Press the field 
3.	Select the tab Service
4.	Select the tab Electrodes test
5.	Into socket A connect the patient cable which is going to be tested. Holding for the plastic covers close to each other cable connectors. Additionally, you should move the cable near the plugs. Observe the indication shown on the display. Press the button Run the test
6.	Evaluate the usage of cables according to instructions below:  Cable in good condition

Step	Description
	 <p>Reducing the signal level indicates the cable damage</p>

7. To escape the test mode press the key . To leave **Setup** mode, press the key 



Alternative method: cable plug should be inserted into the output socket, and plugs from the side of electrodes should be short-circuited. Then select one-channel interferential current and set 10 mA amplitude. Additionally, you can make movements with the cable, and particularly with the spiral cable glands.

If during current increase the information about open circuit is **not displayed**, the cable shall be deemed in proper working condition.

6.8.2 Electrode condition control

The unit possesses the function of electrodes test, which allows for checking the status of their usage. To check it, the current circuit A is used, where on its output voltage the signal is given. The unit while measuring the current flow in the circuit determines the level of electrode usage. When the electrode is more consumed, the less current flows in the circuit.





Special caution should be exercised due to the possibility of high current flow while testing cables. While performing the test, do not touch the cable plug that is examined!



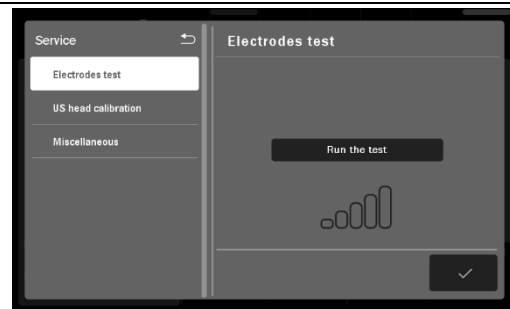

Step	Description
1.	Switch on the unit.
2.	Press the field 
3.	Select the tab Service
4.	Select the tab Electrodes test

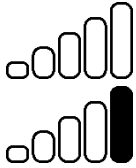
5. To the patient cables red plug in circuit A connect the electrode that is going to be tested. Press the button **Run the test**. Black plug press in the corners of the electrode.



Evaluate the usage of electrodes according to instructions below:

6.	 <p>New electrode, no signs of usage</p>
	 <p>Small level of usage</p>
	 <p>Medium level of usage</p>

Step	Description
	 <p>Large level of usage, it is not recommended to perform the treatments with unipolar currents due to the possibility of open circuit frequent detection.</p>
	 <p>Electrode completely consumed, recommended immediate replacement.</p>
7.	To escape the test mode press the key  . To leave Setup mode, press the key 





Alternative method: Rubber electrodes should be inspected using special "Electrode Tester" or resistance meter. In the case of using a resistance meter, electrodes should be considered to be used, when their resistance measured at the ends (diagonally for rectangular shapes, and diametrically for round shapes) is higher than 1000 Ω. In the case of working with used electrodes, the information about open circuit detection will be shown on the display, while performing treatment procedure.

6.9 US head calibration

The content of this point applies to units with ultrasound function. This function allows you to adjust the head settings associated with the contact quality detection with the patient's body during treatment. It is recommended to carry it out in case of problems during normal operation.

In order to properly perform the procedure clean and dry out the ultrasound head.

Step	Description
1.	Prepare a plastic container with a capacity of 1 liter of water.
2.	Switch on the unit.
3.	Press the field 
4.	Select the tab Service
5.	Select the tab US head calibration
6.	Select the head and press the field.
7.	Measure the head without load – "in the air". Press the key / button. 
8.	Put the ultrasound head into the container filled with water Press the key / button. 
9.	If necessary, adjust the US head sensitivity settings by selecting a different field from the default.
10.	Press Save the calibration to save the settings or Return to cancel and return to the procedure beginning.

6.10 Self-test Procedure

Each time the PhysioGo unit is started, a special self-test procedure is performed during which all modules and functional blocks of the device are tested. If any errors or damage are detected, the relevant information will be presented on the display screen. The module where the irregularity has been detected is blocked and the associated function is not available. If any mistakes of the hardware nature are detected, the unit will not start. An acoustic signal reminiscent of "tapping" will be emitted. The number of signals ("taps") generated is adequate to the number of the error (see table of error codes). For example, if seven signals are emitted (followed by a short break), this means that the keyboard is damaged or one of the keys is locked.

In this situation, you must disconnect the unit from the network and contact an authorized service center for a service and a possible repair.

The table below presents the "hardware" error coding system:

Error code	Error description
I1	SDRAM initialization error
I2	SDRAM self-test error
I3	No communication with the SD card
I4	No communication with the TSC controller in the LCD
I5	Program defect in the processor FLASH memory (CRC)

Error code	Error description
I6	No communication with the keyboard module
I7	The keyboard is damaged or a button is pressed (a button short-circuit)

6.11 Troubleshooting

Model	Symptoms	Undertaking action
All	The unit does not respond to mains supply.	Check spare fuses. If they are blown, replace them in accordance with indications in point 6.12. Try to connect different mains cable. If the problem persists, contact your service.
	The unit does not start. Acoustic sounds can be heard.	Turn off and on the device. If the problem persists or occurs frequently, determine the type of error based on chapter 6.10 and contact your service.
	Unit Error indication – symbol  in the status field or channel tab.	Switch the unit off and on once again. If the problem persists or frequently occurs, note down the error number and contact your service.
	Error indication of laser applicator, magnetic field applicator or ultrasound head.	Switch the unit off. Disconnect applicators and heads. Connect it once again and switch on the mains supply. If the problem persists or frequently occurs, note down the error number and contact your service. If you have another applicator, connect it in and check if the problem persists.
	The unit does not respond when you press a key / keys. Touch screen panel doesn't work.	Switch the unit off and on once again. If the problem persists or frequently occurs, contact your service.
	Incomprehensible messages.	Switch on the unit. Enter the setup mode. Select an appropriate language version.
	Unclear display.	Switch on the unit. Enter the setup mode. Adjust brightness.
	Lack of buzzer signals.	Switch on the unit. Enter the setup mode. Check the configuration of buzzer volume.
	Too silent buzzer volume.	Switch on the unit. Enter the setup mode. Set an appropriate buzzer volume.
	Series 400, 500, 600, 700	You cannot start laser operation.
Lack of laser radiation.		Switch on the unit. Enter the setup mode. Perform the laser power measurement.
Series 200, 300, 600, 700	Message – no ultrasound head contact – appears frequently Ultrasound head does not detect the lack of contact.	Switch on the unit. Enter the setup mode. Modify the US head sensitivity using the instructions described in the Instructions for use. If the problem repeats, contact your service.
	Message "Open circuit" frequently appears. Problems with interconnecting cables or/and electrodes.	Switch on the unit. Enter the setup mode. Perform the US head calibration procedure. If the problem repeats, contact your service.
Series 100, 300, 500, 700	Message "Open circuit" frequently appears. Problems with interconnecting cables or/and electrodes.	Check it in accordance with point 6.8.1 and/or 6.8.2. Follow the instructions described there.
Models equipped with battery module	The unit does not respond to mains supply.	Connect the mains supply. The battery may be discharged. To start the operation, please hold on for at least 3 seconds the STANDBY key. Additionally, If a problem I16 is shown on the display it means that the backup battery is exhausted. Its exchange should be directed to an authorized service. Type of memory backup battery is a CR2032.
	The battery is very quickly discharged.	Contact your service representative for battery replacement.

6.12 Fuse replacement



NOTE: Before proceeding to the further described operations isolate the unit from the mains supply!

In case of burnt fuses, they must be replaced. Their parameters are given in chapter "Specification and parts of the unit" and on the name plate.

To replace fuses:

Step	Description
1.	Isolate the device from the mains.
2.	Disconnect the mains cable from the mains socket.
3.	With flat screwdriver lever the fuse socket until the moment of its slipping from the socket.
4.	Remove the socket with your fingers, replace the fuses, install them in the socket again and press firmly.
5.	Connect the mains cable – first to the socket placed in the rear panel of the controller and then to the mains.
6.	Switch the power switch on and start the device. Check the device operation.



6.13 Battery

The unit may be optionally equipped with a battery module. Please observe the following precautions when using this power source:

- **First use, please discharge the battery and then recharge it fully.**
- **Prevent complete discharging the battery, as this may shorten its life or results in its damage. Such damage is not covered under warranty conditions.**
- **Do not leave the battery in the discharged condition for more than two days, because it can cause its damage (recharge will not be possible).**
- **Storing the unused unit for more than three months should be done at the battery charged more than 50%. Otherwise, it may result in its damage (recharge will not be possible). If you're concerned about such a situation, contact an authorized service center and ask about removing the battery module.**
- **In order to maintain high battery performance, it must be regularly discharged to minimum acceptable level and then recharged fully. Such cycles of discharging and charging should be performed at least once every two months.**

In order to prevent unintentional cases when running on a battery, the unit displays warning messages of low battery condition. Then, it is recommended to start the operation with the mains supply. In this case:

- Interrupt the procedure. Disconnect the patient in case of any connection.
- Connect the mains cable.
- Turn the mains switch on
- Continue the treatment.



NOTE – The unit start up when the battery charge status is below 10% is not possible. In this case, the unit must be powered from the mains.

6.12.1. Battery damage

If a damage to the battery is detected, the unit will report an error and launch a special procedure. After each start-up, the message shown in figure 6.1 will appear on the screen.

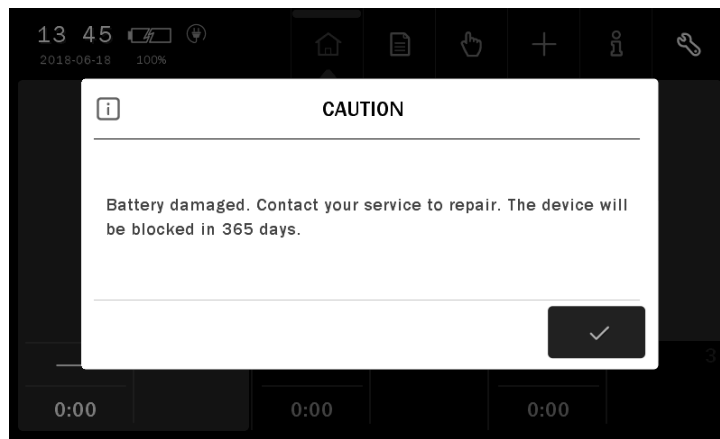



Figure 6.1. Battery damage message

The unit operation will only be possible on the mains supply, after pressing ✓.



Notes:

- It is necessary to remove the battery failure for safety reasons.
- The procedure will be launched after the battery error is detected for the third time to prevent random situations.
- The user has one year to contact an authorized service and arrange the conditions for repair.
- The time is automatically counted down by the unit.
- The failure condition is indicated by the  symbol displayed instead of battery charge indicator (left, top corner).

If the cause of the failure is not removed within the indicated time, the unit will be permanently blocked. After start-up, the message shown in figure 6.2 will appear on the screen. Performing treatments will not be possible until the failure is removed by an authorized service.

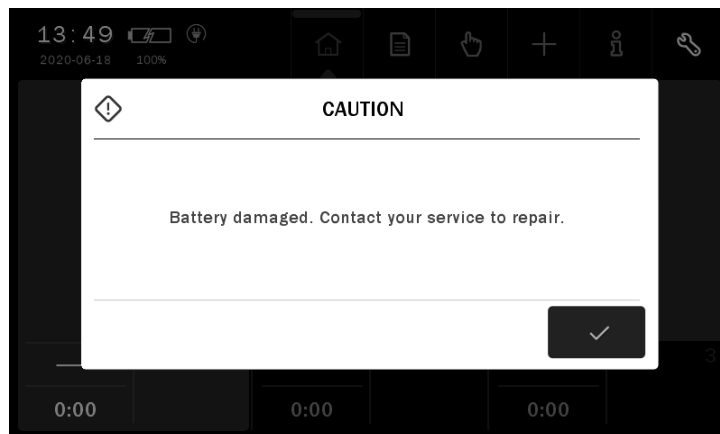

Figure 6.2. Permanent blockade message

7. Specification and parts of the unit

7.1 Specification

Classification:

Medical device class (according to REGULATION (EU) 2017/745 OF THE EUROPEAN PARLIAMENT AND OF THE COUNCIL of 5 April 2017):

- IIa (rule 9), models: 100A, 101A, 200A, 201A, 300A, 301A
- IIb (rule 9), models: 400C, 401C, 500I, 501I, 600C, 601C, 700C, 701C, 700I, 701I

Laser device class:	3B
Electrical safety class:	I
Applied part type:	BF
Degree of protection provided by enclosures (IP code):	IP20
Degree of protection provided by ultrasound head enclosure:	IPX7
Operating altitude	<2000m

Operation mode:

The PhysioGo unit is intended for continuous operation.

Treatment parameters:

Given in chapter 5 and:	
Nominal load resistance:	500 – 750 Ω
Carrier frequency for unipolar unidirectional currents:	40 kHz
Ultrasound wave frequency:	1 MHz \pm 50 kHz 3,5 MHz \pm 100 kHz

Accuracy of operation parameters:

Electrotherapy:

Output current and voltage amplitude \pm 20% for the range of load resistance:	500 Ω
Microcurrents calibration:	for resistance 22 k Ω
Pulse repetition frequency:	\pm 20%
Pulse duration:	\pm 20%
Accuracy of times of individual phases for AM and FM:	\pm 20%

Ultrasounds:

Output power / power density:	\pm 20%
Pulse frequency:	\pm 20%
Duty factor:	\pm 20%
Effective radiating area:	\pm 20%

Laser therapy:

Power control accuracy:	\pm 20% of max value
Pulse repetition period:	\pm 20%
Duty factor:	\pm 20%
Laser emission readiness signal, the unit:	unit screen
Laser emission signal, the unit:	sound, unit screen
Laser emission readiness signal, laser point probes:	flashing yellow – LED indicator
Laser emission signal, laser point probes:	yellow LED indicator
Laser emission signal, scanning laser applicator:	yellow LED indicator
Laser emission readiness signal, cluster laser applicator:	flashing yellow – LED indicator
Laser emission signal, cluster laser applicator:	yellow LED indicator
Additional safety measures:	warning labels DOOR blocking plug
Remote interlock connector:	passive closing contact sensor

Magnetotherapy:

Accuracy of induction:	\pm 20% of max value
Accuracy of frequency:	\pm 20% of max value
Accuracy of pause time:	\pm 20% of max value
Accuracy of pulse time in interrupted mode:	20%

Parameters of scanning laser applicator

Laser class of pilot beam:	3R
Output power of pilot beam:	5 mW
Wavelength of pilot beam:	660 nm
Possibility of simultaneous radiation of RD and IR:	yes
Scanner height adjustment range:	60 – 140 cm
Adjustment angle of rotation:	-90÷ +90° in both axes
Duty factor for pulse operation of scanning applicator:	75%
Driving element of scanner stand:	4 with brake

Treatment programs and sequences:

Pre-defined treatment programs for electrotherapy:	69
Pre-defined treatment sequences for electrotherapy:	38
Pre-defined treatment programs for ultrasound therapy:	58
Pre-defined treatment programs for combined therapy:	77
Pre-defined treatment programs for point laser applicators with 808nm wavelength:	39
Pre-defined treatment programs for point laser applicators with 650/660nm wavelength:	18
Pre-defined treatment sequences for scanning laser applicators:	26
Pre-defined treatment sequences for cluster laser applicator:	54
Voll's frequencies:	30
Nogier's frequencies:	8
Pre-defined treatment programs for magnetotherapy:	41
Total	458

User-defined programs for:

Electrotherapy:	50
Ultrasound therapy:	50
Combined therapy:	50
Laser therapy:	50
	(for every applicator)
Magnetotherapy:	50
Total	400

Parameters for pulse operation of point applicators:

Nogier's frequencies:	1,14; 2,28; 4,56; 9,12; 18,3; 36,5; 73;146 Hz
Voll's frequencies:	1,2; 1,7; 1,75; 2,2; 2,45; 2,5; 2,65; 2,9; 3,3;3,5 Hz 3,6; 3,8; 3,9; 4; 4,9; 5,55; 5,8; 5,9; 6; 6,3; 6,8 Hz 7,5; 7,7; 8,25; 9,2; 9,35; 9,4; 9,45; 9,5; 9,6 Hz

Treatment timer:

Ranges and resolutions:	defined in chapter 5
Time accuracy:	10%

General:

Mains supply:	230 V ±10%, 50/60 Hz
Maximum power consumption:	90 VA
Mains fuses:	2xT1L250V; 1 A, 250 V
Type of memory backup battery:	CR2032
Unit weight:	max. 6 kg
Ultrasound head weight:	max. 0,8 kg
Point laser applicator weight:	max. 0,5 kg
Scanning laser applicator weight:	max. 1 kg
Cluster laser applicator weight:	max. 0,5 kg
Single plate magnetic field applicator weight:	max 1,2 kg
Set of coupled plate magnetic field applicators weight:	max 2,4 kg
Unit dimensions (WxDxH), feet folded:	34x28x11 cm
Unit dimensions (WxDxH), feet unfolded:	34x28x16 cm

The power supply cord is equipped with a mains plug that isolates the device from the supply mains on all poles simultaneously.

Battery – version 2.0:

Type:	Li-Ion
Voltage:	18,17 V
Capacity:	3400 mAh

Battery – version 1.0:

Type:	Li-Ion
Voltage:	25,2 V
Capacity:	2250 mAh

Storage conditions:

Temperature range:	+5÷+45°C
Relative humidity:	30÷75%
Pressure range:	700÷1060 hPa (70 – 106 kPa)

Operation conditions:

Temperature range:	+15÷+30°C
Relative humidity:	30÷75%
Pressure range:	700÷1060 hPa (70 – 106 kPa)

Transport conditions:

Temperature range:	-10÷+45°C
Relative humidity:	20÷95%
Pressure range:	700÷1060 hPa (70 – 106 kPa)

7.2 EMC parameters

Acc. to EN 60601-1-2:2015 and EN 60601-1-2:2015/A1:2021 (IEC 60601-1-2:2014 and IEC 60601-1-2:2014 /AMD1:2020).

Guidance and manufacturer's declaration – electromagnetic emissions

Emission test	Compliance level
Radiated emissions – CISPR 11	Group 1
Conducted emissions – CISPR 11	Class B
Harmonic emissions – IEC 61000-3-2	Class A
Voltage fluctuations / Flicker emissions – IEC 61000-3-3	Complies

Guidance and manufacturer's declaration – electromagnetic immunity

Immunity test	IEC60601 test level	Compliance level
Electrostatic discharge (ESD)	±8 kV contact	±8 kV contact
IEC 61000-4-2	±2, ±4, ±8, ±15 kV air	±2, ±4, ±8, ±15 kV air

Recommendation: Floor should be made of wood, concrete or ceramic tile. If floors are covered with synthetic material, the relative humidity should be at least 30%.

Immunity test	IEC60601 test level	Compliance level
Radiated RF	10 V/m	10 V/m
IEC 61000-4-3	80MHz to 2,7 GHz	

Field strengths from fixed transmitters, such base stations for radio (cellular / cordless) telephones and land mobile radios, amateur radio, AM and FM radio broadcast and TV broadcast cannot be predicted theoretically with accuracy. To assess the electromagnetic environment due to fixed RF transmitters, an electromagnetic site survey should be considered. If the measured field strength in the location in which the PhysioGo unit is used exceeds the applicable RF compliance level above, the unit should be observed to verify normal operation. If abnormal performance is observed, additional measures may be necessary, such as re-orienting or relocating the PhysioGo unit.

Applied compliance level is suitable for home healthcare environment. It means the device may be connected to the public low-voltage power supply network.

Immunity test	IEC60601 test level	Compliance level
Electric fast transient / burst	±2 kV	±2 kV
IEC 61000-4-4		

Immunity test	IEC60601 test level	Compliance level
Surges	±1 kV line-to-line	±1 kV line-to-line
IEC 61000-4-5	±2 kV line-to-ground	±2 kV line-to-ground

Immunity test	IEC60601 test level	Compliance level
Conducted RF IEC 61000-4-6	3 Vrms	3 Vrms
	150 kHz to 80 MHz	150 kHz to 80 MHz
	6 Vrms in ISM and amateur radio bands between 150 kHz – 80 MHz	6 Vrms in ISM and amateur radio bands between 150 kHz – 80 MHz

Field strengths from fixed transmitters, such as base stations for radio (cellular / cordless) telephones and land mobile radios, amateur radio, AM and FM radio broadcast and TV broadcast cannot be predicted theoretically with accuracy. To assess the electromagnetic environment due to fixed RF transmitters, an electromagnetic site survey should be considered. If the measured field strength in the location in which the PhysioGo unit is used exceeds the applicable RF compliance level above, the unit should be observed to verify normal operation. If abnormal performance is observed, additional measures may be necessary, such as re-orienting or relocating the PhysioGo unit.

Applied compliance level is suitable for home healthcare environment. It means the device may be connected to the public low-voltage power supply network.

Immunity test	IEC60601 test level	Compliance level
Magnetic field power frequency (50/60 Hz) IEC 61000-4-8	30 A/m	30 A/m

Immunity test	IEC60601 test level	Compliance level
Voltage dips IEC 61000-4-11	0% U _r 0,5 cycle, phase angles of synchronization with AC power supply voltage 0°, 45°, 90°, 135°, 180°, 225°, 270°, 315°	Complies
	0% U _r 1 cycle, phase angle of synchronization with AC power supply voltage 0°	Complies
	70% U _r 25 cycles for 50 Hz 30 cycles for 60 Hz phase angle of synchronization with AC power supply voltage 0°	Complies
	0% U _r 250 cycles for 50 Hz 300 cycles for 60 Hz	Complies

Immunity test	Compliance level
Immunity to proximity fields from RF wireless communications equipment according to the table 9 of IEC 60601-1-2:2014/AMD1:2020	Complies
Immunity to proximity magnetic fields in the frequency range 9 kHz to 13,56 MHz according to the table 11 of IEC 60601-1-2:2014/AMD1:2020 and IEC 61000-4-39	Complies

7.3 Standard and optional parts of the unit

Standard and optional parts of the unit are defined in the Instructions for use dedicated for the particular PhysioGo unit model.













8. Symbols description, I(t) curve card

















Recommendation for the operator's position to ensure the legibility of markings and information on the controller, accessory and detachable parts labels:

- visual distance – shall be 30 cm due to the applied technologies,
- lighting – 500 lx, which corresponds to normal room lighting conditions.

8.1 Controller, parts of the unit, packaging

Symbol	Explanation
	Caution, symbol ISO 7000-0434A
	Type BF applied part, symbol IEC 60417-5333
	Date of production: year, symbol ISO 7000-2497
	Manufacturer, symbol ISO 7000-3082
IP20	Degree of protection provided by enclosures, based on IEC 60529
	Fuse, symbol IEC 60417-5016
VER	Unit version
	Serial number, symbol ISO 7000-2498
	Batch code, symbol ISO 7000-2492
	Catalogue number, symbol ISO 7000-2493
	Medical device, symbol 5.7.7. of ISO 15223-1 standard
	Unique Device Identifier, symbol 5.7.10. of ISO 15223-1 standard
	Disposal of used devices together with other waste is prohibited, complied with the requirements of WEEE
	Operating instructions, symbol ISO7000-1641

Symbol	Explanation
	Non-ionizing electromagnetic radiation, symbol IEC 60417-5140 Indication of equipment in the medical electrical area that intentionally apply RF electromagnetic energy for diagnosis or treatment.
	Refer to instruction manual, symbol ISO 7010-M002 Background color: blue
	No sitting, symbol ISO 7010-P018 Background color: white Circular band and slash: red Symbol or text: black
	No stepping on surface, symbol ISO 7010-P019 Background color: white Circular band and slash: red Symbol or text: black
	No pushing, symbol ISO 7010-P017 Background color: white Circular band and slash: red Symbol or text: black
	No metallic articles or watches, symbol ISO 7010-P008 Background color: white Circular band and slash: red Symbol or text: black
	Electrostatic sensitive devices, symbol IEC 60417-5134
	The product has passed quality control
	Weight
	Packaging size
	Temperature limit, symbol ISO 7000-0632
	Keep away from rain, symbol ISO 7000-0626
	Fragile; handle with care, symbol ISO 7000-0621
	This way up, symbol ISO 7000-0623
	The marking of conformity with legal regulations for medical devices applicable in the European Union along with the number of the Notified Body taking part in the conformity assessment.

The chart of unit operation parameters:

Symbol	Explanation
	Caution, see the ASSOCIATE DOCUMENTS
Fr	Acoustic working frequency
Cont	Continuous mode (continuous wave emission)
Pulse	Pulse mode (pulse wave emission)
T	Pulse repetition period
t _i	Pulse duration
D	Duty factor (pulse duration / pulse repetition period)

Symbols placed on the ultrasound head name plate

Symbol	Explanation
Fr	Acoustic working frequency
ERA	Effective radiating area
P _{max}	Nominal power
BNR	Beam non-uniformity ratio
BT	Beam type
IPX7	Degree of protection provided by enclosures (IP code)

Patient:	Date of examination:
Age:	Therapist:
Description:	
Site:	
Rheobase:	mA
Chronaxie:	ms
Accomodation factor:	

